

Test Report

AIR-AP1800S-x-K9

AIR-AP1800I-x-K9

(x=A,B,D,N,T,Z)

Bluetooth Low Energy (BLE)

FCC ID: LDK102112

IC: 2461B-102112

2400-2483.5 MHz

Against the following Specifications:

CFR47 Part 15.247

RSS-247

RSS-Gen

AS/NZS 4268

LP0002

G.S.R 45 (E)



Cisco Systems

170 West Tasman Drive

San Jose, CA 95134

	
Author: Jose Aguirre Tested By: Jose Aguirre	Approved By: Jim Nicholson Title: Technical Leader, Engineering Revision: 2

This report replaces any previously entered test report under EDCS – **11570953**. This test report has been electronically authorized and archived using the CISCO Engineering Document Control system.



This test report has been electronically authorized and archived using the CISCO Engineering Document Control system.

SECTION 1: OVERVIEW3

SECTION 2: ASSESSMENT INFORMATION4

 2.1 GENERAL4

 2.2 DATE OF TESTING6

 2.3 REPORT ISSUE DATE6

 2.4 TESTING FACILITIES6

 2.5 EQUIPMENT ASSESSED (EUT).....6

 2.6 EUT DESCRIPTION7

SECTION 3: RESULT SUMMARY8

 3.1 RESULTS SUMMARY TABLE8

SECTION 4: SAMPLE DETAILS10

 4.1 SAMPLE DETAILS10

 4.2 SYSTEM DETAILS10

 4.3 MODE OF OPERATION DETAILS.....10

APPENDIX A: EMISSION TEST RESULTS11

 CONDUCTED TEST SETUP DIAGRAM11

 TARGET MAXIMUM CHANNEL POWER11

 A.1 6dB BANDWIDTH12

 A.2 99% AND 26DB BANDWIDTH14

 A.3 MAXIMUM CONDUCTED OUTPUT POWER16

 A.4 POWER SPECTRAL DENSITY18

 A.5 CONDUCTED SPURIOUS EMISSIONS20

 A.6 CONDUCTED BANDEDGE25

APPENDIX B: EMISSION TEST RESULTS31

 RADIATED EMISSION SETUP DIAGRAM-BELOW 1G31

 B.1 RADIATED SPURIOUS EMISSIONS32

 B.2 RECEIVER SPURIOUS EMISSIONS40

 B.3 RADIATED EMISSIONS 30MHZ TO 1GHZ43

 B.4 AC CONDUCTED EMISSIONS45

 PHOTOGRAPHS OF SETUP47

APPENDIX C: LIST OF TEST EQUIPMENT USED TO PERFORM THE TEST51

APPENDIX E: ABBREVIATION KEY AND DEFINITIONS54



Section 1: Overview

The samples were assessed against the tests under the requirements of the following specifications:

Emission
CFR47 Part 15.247 RSS-247 Issue 2: February 2017 RSS-Gen Issue 4: Nov 2014

Measurements were made in accordance with

- ANSI C63.10:2013
- FCC KDB 662911 D01 v02r01
- KDB 558074 D01 Meas Guidance v03r05

Section 2: Assessment Information

2.1 General

This report contains an assessment of an apparatus against Electromagnetic Compatibility Standards based upon tests carried out on the samples submitted. The testing was performed by and for the use of Cisco systems Inc:

With regard to this assessment, the following points should be noted:

- a) The results contained in this report relate only to the items tested and were obtained in the period between the date of the initial assessment and the date of issue of the report. Manufactured products will not necessarily give identical results due to production and measurement tolerances.
- b) The apparatus was set up and exercised using the configuration and modes of operation defined in this report only.
- c) Where relevant, the apparatus was only assessed using the susceptibility criteria defined in this report and the Test Assessment Plan (TAP).
- d) All testing was performed under the following environmental conditions:

Temperature	15°C to 35°C (54°F to 95°F)
Atmospheric Pressure	860mbar to 1060mbar (25.4" to 31.3")
Humidity	10% to 75*%

*[Where applicable] For ESD testing the humidity limits used were 30% to 60% and for EFT/B tests the humidity limits used were 25% to 75%.
- e) All AC testing was performed at one or more of the following supply voltages:
110V 60 Hz (+/-20%)

Units of Measurement

The units of measurements defined in the appendices are reported in specific terms, which are test dependent. Where radiated measurements are concerned these are defined at a particular distance. Basic voltage measurements are defined in units of [dBuV]

As an example, the basic calculation for all measurements is as follows:

$$\text{Emission level [dBuV]} = \text{Indicated voltage level [dBuV]} + \text{Cable Loss [dB]} + \text{Other correction factors [dB]}$$

The combinations of correction factors are dependent upon the exact test configurations [see test equipment lists for further details] and may include:-

Antenna Factors, Pre Amplifier Gain, LISN Loss, Pulse Limiter Loss and Filter Insertion Loss..

Note: to convert the results from dBuV/m to uV/m use the following formula:-

$$\text{Level in uV/m} = \text{Common Antilogarithm} [(X \text{ dBuV/m})/20] = Y \text{ uV/m}$$



Measurement Uncertainty Values

voltage and power measurements	± 2 dB
conducted EIRP measurements	± 1.4 dB
radiated measurements	± 3.2 dB
frequency measurements	± 2.4 10 ⁻⁷
temperature measurements	± 0.54°
humidity measurements	± 2.3%
DC and low frequency measurements	± 2.5%

Where relevant measurement uncertainty levels have been estimated for tests performed on the apparatus. This uncertainty represents an expanded uncertainty expressed at approximately the 95% confidence level using a coverage factor of k=2.

Radiated emissions (expanded uncertainty, confidence interval 95%)

30 MHz - 300 MHz	+/- 3.8 dB
300 MHz - 1000 MHz	+/- 4.3 dB
1 GHz - 10 GHz	+/- 4.0 dB
10 GHz - 18GHz	+/- 8.2 dB
18GHz - 26.5GHz	+/- 4.1 dB
26.5GHz - 40GHz	+/- 3.9 dB

Conducted emissions (expanded uncertainty, confidence interval 95%)

30 MHz – 40GHz	+/- 0.38 dB
----------------	-------------

A product is considered to comply with a requirement if the nominal measured value is below the limit line. The product is considered to not be in compliance in case the nominal measured value is above the limit line.

This report must not be reproduced except in full, without written approval of Cisco Systems.

2.2 Date of testing

01-Feb-17 - 07-Feb-17

2.3 Report Issue Date

14-Feb-17

Cisco uses an electronic system to issue, store and control the revision of test reports. This system is called the Engineering Document Control System (EDCS). The actual report issue date is embedded into the original file on EDCS. Any copies of this report, either electronic or paper, that are not on EDCS must be considered uncontrolled.

2.4 Testing facilities

This assessment was performed by:

Testing Laboratory

Cisco Systems, Inc.,
125 West Tasman Drive
San Jose, CA 95134, USA

Registration Numbers for Industry Canada

Cisco System Site	Address	Site Identifier
Building P, 10m Chamber	125 West Tasman Dr San Jose, CA 95134	Company #: 2461N-2
Building P, 5m Chamber	125 West Tasman Dr San Jose, CA 95134	Company #: 2461N-1
Building I, 5m Chamber	285 W. Tasman Drive San Jose, California 95134	Company #: 2461M-1

Test Engineers

Jose Aguirre

2.5 Equipment Assessed (EUT)

AIR-AP1800S-x-K9

2.6 EUT Description

The Cisco Aironet 802.11ac Dual Band Access Point with Bluetooth LE supports the following modes of operation. The modes are further defined in the radio Theory of Operation. The modes included in this report represent the worst case data for all modes. Data is recorded at the lowest supported data rate for each mode. This report covers operation on channel 1-11.

802.15.1 - BLE GFSK, One Antenna, 1 Mbps

The following antennas are supported by this product series.
The data included in this report represent the worst case data for all antennas.

Frequency	Part Number	Antenna Type	Antenna Gain (dBi)
2.4 GHz	BLE Internal	Omni	1 / NA
	2x2 Internal	Omni	3 / 5

Section 3: Result Summary

3.1 Results Summary Table

Conducted emissions

Basic Standard	Technical Requirements / Details	Result
FCC 15.247 RSS-247 LP0002:3.10.1(6.2.1)	6dB Bandwidth: Systems using digital modulation techniques may operate in the 2400-2483.5MHz band. The minimum 6dB bandwidth shall be at least 500 kHz.	Pass
FCC 15.247 RSS-247	99% & 26 dB Bandwidth: The 99% occupied bandwidth is the frequency bandwidth such that, below its lower and above its upper frequency limits, the mean powers are each equal to 0.5% of the total mean power of the given emission. There is no limit for 99% OBW. The 26 dB emission is the width of the emission that is constrained by the frequencies associated with the two outermost amplitude points (upper and lower frequencies) that are attenuated by 26 dB relative to the maximum level measured in the fundamental emission.	Pass
FCC 15.247 RSS-247 LP0002:3.10.1(2.3)	Output Power: 15.247 The maximum conducted output power of the intentional radiator for systems using digital modulation in the 2400-2483.5 MHz band shall not exceed 1 Watt (30dBm). If transmitting antennas of directional gain greater than 6 dBi are used, the maximum conducted output power shall be reduced by the amount in dB that the directional gain of the antenna exceeds 6 dBi. RSS-247 For DTSs employing digital modulation techniques operating in the band 2400-2483.5 MHz, the maximum peak conducted output power shall not exceed 1W. Except as provided in Section 5.4(5), the e.i.r.p. shall not exceed 4 W.	Pass
FCC 15.247 RSS-247 LP0002:3.10.1(6.2.2)	Power Spectral Density: For digitally modulated systems, the power spectral density conducted from the intentional radiator to the antenna shall not be greater than 8 dBm in any 3 kHz band during any time interval of continuous transmission.	Pass
FCC 15.247 RSS-247 LP0002:3.10.1(5)/2.8	Conducted Spurious Emissions / Band-Edge: In any 100 kHz bandwidth outside the frequency band in which the spread spectrum or digitally modulated intentional radiator is operating, the radio frequency power that is produced by the intentional radiator shall be at least 20 dB below that in the 100 kHz bandwidth within the band that contains the highest level of the desired power, based on either an RF conducted or a radiated measurement, provided the transmitter demonstrates compliance with the peak conducted power limits. If the transmitter complies with the conducted power limits based on the use of RMS averaging over a time interval, as permitted under paragraph (b)(3) of this section, the attenuation required under this paragraph shall be 30 dB instead of 20 dB. Attenuation below the general limits specified in §15.209(a) is not required	Pass
FCC 15.247 RSS-247 FCC 15.205 RSS-Gen	Restricted band: Unwanted emissions falling within the restricted bands, as defined in FCC 15.205 (a) and RSS-Gen 8.10 must also comply with the radiated emission limits specified in FCC 15.209 (a) and RSS-Gen 8.9.	Pass

Radiated Emissions (General requirements)

Basic Standard	Technical Requirements / Details	Result
FCC 15.209 RSS-Gen LP0002:3.10.1(5)/2.8	<p>TX Spurious Emissions: Except as provided elsewhere in this subpart, the emissions from an intentional radiator shall not exceed the field strength levels specified in the filed strength limits table in this section. Unwanted emissions falling within the restricted bands, as defined in FCC 15.205 (a) and RSS-Gen 8.10 must also comply with the radiated emission limits specified in FCC 15.209 (a) and RSS-Gen 8.9.</p>	Pass
RSS-Gen LP0002:3.10.1(5)2.8	<p>RX Spurious Emissions: RSS-Gen 8.9 Except when the requirements applicable to a given device state otherwise, emissions from licence-exempt transmitters shall comply with the field strength limits shown in Table 4 and Table 5 below. Additionally, the level of any transmitter emission shall not exceed the level of the transmitter's fundamental emission. RSS-Gen 8.10 Unwanted emissions that fall into restricted bands of Table 6 shall comply with the limits specified in RSS-Gen; and (c) Unwanted emissions that do not fall within the restricted frequency bands of Table 6 shall comply either with the limits specified in the applicable RSS or with those specified in this RSS-Gen.</p>	Pass
FCC 15.207 RSS-Gen LP0002:2.3	<p>AC conducted Emissions: Except when the requirements applicable to a given device state otherwise, for any radio apparatus equipped to operate from the public utility AC power supply, either directly or indirectly (such as with a battery charger), the radio frequency voltage of emissions conducted back onto the AC power lines in the frequency range of 0.15 MHz to 30 MHz shall not exceed the limits shown in the table in these sections. The more stringent limit applies at the frequency range boundaries.</p>	Pass

* MPE calculation is recorded in a separate report

Section 4: Sample Details

Note: Each sample was evaluated to ensure that its condition was suitable to be used as a test sample prior to the commencement of testing.

4.1 Sample Details

Sample No.	Equipment Details	Manufacturer	Hardware Rev.	Firmware Rev.	Software Rev.	Serial Number
S01	AIR-AP1800I-A-K9	Cisco Systems	P2	6fd6a0ba7 4da9f8665 9cfc8984 f36b9	8.4.1.10	RFDP3AFA037
S02*	AIR-PWRINJ6	Cisco Systems	V01	NA	NA	C15456663000 0247

(*) S02 is support equipment Power supply for EUT S01

4.2 System Details

System #	Description	Samples
1	AIR-AP1800I-A-K9	S01
2	AIR-PWRINJ6	S02

4.3 Mode of Operation Details

Mode#	Description	Comments
1	Continuous Transmitting	Continuous Transmitting $\geq 98\%$ duty cycle

Measurements were made in accordance with

- ANSI C63.10:2013
- FCC KDB 662911 D01 v02r01
- KDB 558074 D01 Meas Guidance v03r05

Appendix A: Emission Test Results

Conducted Test Setup Diagram

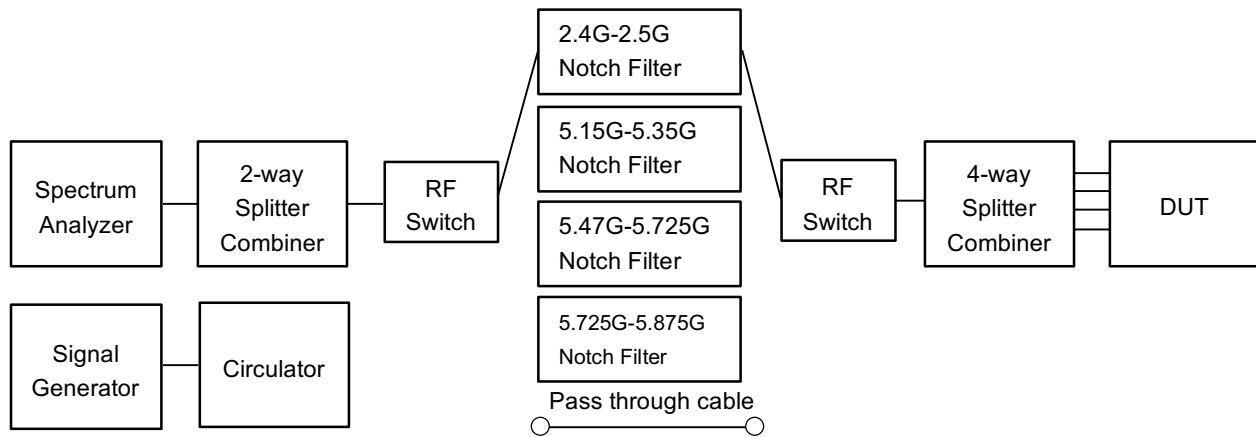

Target Maximum Channel Power

The following table details the maximum supported Total Channel Power for all operating modes.

Operating Mode	Maximum Channel Power (dBm EIRP)		
	Frequency (MHz)		
	2402	2426	2480
BLE GFSK, 1 Mbps	3	4	5



A.1 6dB Bandwidth

15.247 / RSS-247 / LP0002:3.10.1(6.2.1) Systems using digital modulation techniques may operate in the 2400-2483.5MHz band. The minimum 6dB bandwidth shall be at least 500 kHz.

Test Procedure

Ref. KDB 558074 D01 DTS Meas Guidance v03r05
ANSI C63.10: 2013

<p>6 BW Test Procedure</p> <ol style="list-style-type: none"> 1. Set the radio in the continuous transmitting mode. 2. Allow the trace to stabilize. 3. Setting the x-dB bandwidth mode to -6dB within the measurement set up function. 4. Select the automatic OBW measurement function of an instrument to perform bandwidth measurement. 5. Capture graphs and record pertinent measurement data.
--

Ref. KDB 558074 D01 DTS Meas Guidance v03r05
ANSI C63.10: 2013 section 11.8.2 Option 2

<p>6 BW Test parameters</p> <p>X dB BW = 6dB (using the OBW function of the spectrum analyzer) Span = Large enough to capture the entire EBW RBW = 100 KHz VBW ≥ 3 x RBW Sweep = Auto couple Detector = Peak or where practical sample shall be used Trace = Max. Hold</p>

System Number	Description	Samples	System under test	Support equipment
1	EUT	S01	<input checked="" type="checkbox"/>	<input type="checkbox"/>
	Support	S02	<input type="checkbox"/>	<input checked="" type="checkbox"/>

<p>Tested By : Jose Aguirre</p>	<p>Date of testing: 01-Feb-17 - 01-Feb-17</p>
<p>Test Result : PASS</p>	

See Appendix C for list of test equipment



Frequency (MHz)	Mode	Data Rate (Mbps)	6dB BW (MHz)	Limit (kHz)	Margin (MHz)
2402	GFSK, 1 Mbps	1	0.7	>500	0.2
2426	GFSK, 1 Mbps	1	0.7	>500	0.2
2480	GFSK, 1 Mbps	1	0.7	>500	0.2

6dB Bandwidth, 2426 MHz, 1 Mbps, GFSK

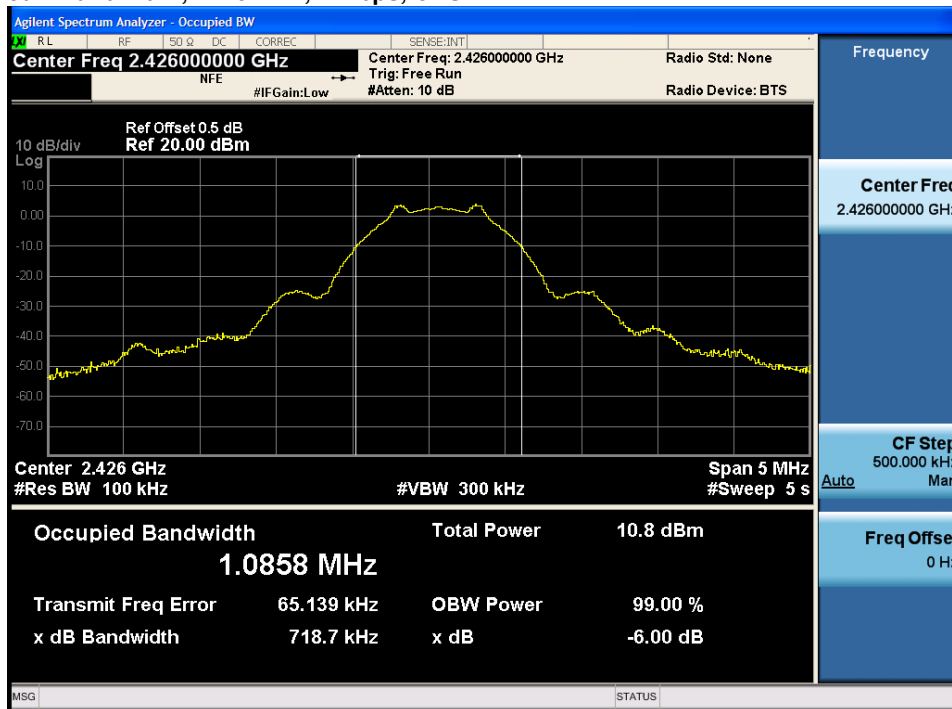



A.2 99% and 26dB Bandwidth

The 99% occupied bandwidth is the frequency bandwidth such that, below its lower and above its upper frequency limits, the mean powers are each equal to 0.5% of the total mean power of the given emission. There is no limit for 99% OBW.

The 26 dB emission is the width of the emission that is constrained by the frequencies associated with the two outermost amplitude points (upper and lower frequencies) that are attenuated by 26 dB relative to the maximum level measured in the fundamental emission.

Test Procedure

Ref. ANSI C63.10: 2013

<p>26 BW & 99% BW Test Procedure</p> <ol style="list-style-type: none"> 1. Set the radio in the continuous transmitting mode. 2. Allow the trace to stabilize. 3. Setting the x-dB bandwidth mode to -26dB & OBW to 99% within the measurement set up function. 4. Select the automatic OBW measurement function of an instrument to perform bandwidth measurement. 5. Capture graphs and record pertinent measurement data.
--

Ref. ANSI C63.10: 2013 section 6.9.3

<p>26 BW & 99% BW Test parameters</p> <p>X dB BW = -26dB (using the OBW function of the spectrum analyzer) OBW = 99% Span = 1.5 to 5 times the OBW RBW = 1% to 5% of the OBW VBW ≥ 3 x RBW Sweep = Auto couple Detector = Peak or where practical sample shall be used Trace = Max. Hold</p>
--

System Number	Description	Samples	System under test	Support equipment
1	EUT	S01	<input checked="" type="checkbox"/>	<input type="checkbox"/>
	Support	S02	<input type="checkbox"/>	<input checked="" type="checkbox"/>

<p>Tested By : Jose Aguirre</p>	<p>Date of testing: 01-Feb-17 - 01-Feb-17</p>
<p>Test Result : PASS</p>	

See Appendix C for list of test equipment



Frequency (MHz)	Mode	Data Rate (Mbps)	26dB BW (MHz)	99% BW (MHz)
2402	GFSK, 1 Mbps	1	1.3	1.067
2426	GFSK, 1 Mbps	1	1.3	1.067
2480	GFSK, 1 Mbps	1	1.3	1.071

26dB / 99% Bandwidth, 2402 MHz, 1 Mbps, GFSK

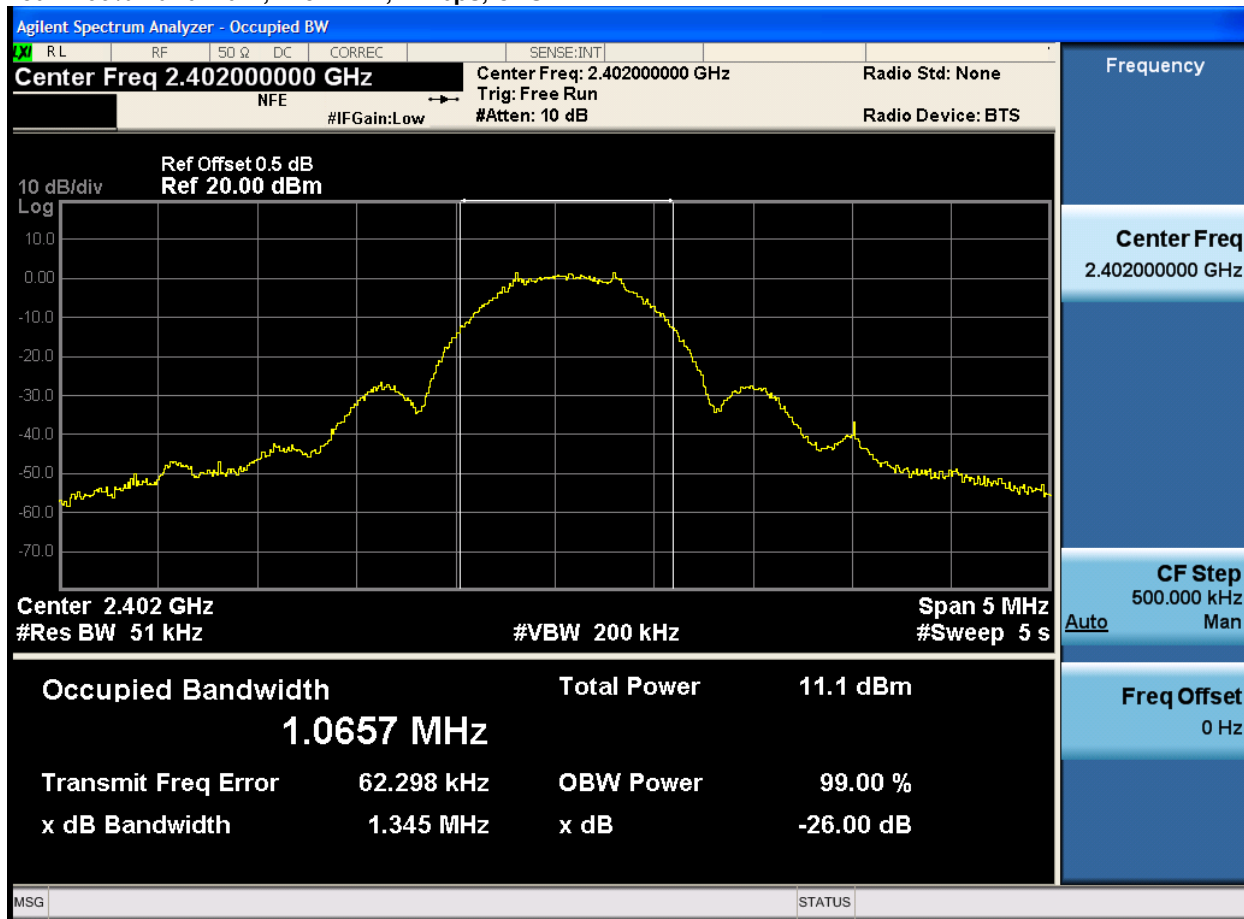



A.3 Maximum Conducted Output Power

15.247 / RSS-247 section 5.4 / LP0002:3.10.1(2.3) The maximum conducted output power of the intentional radiator for systems using digital modulation in the 2400-2483.5 MHz band shall not exceed 1 Watt (30dBm). If transmitting antennas of directional gain greater than 6 dBi are used, the maximum conducted output power shall be reduced by the amount in dB that the directional gain of the antenna exceeds 6 dBi.

As an alternative to a peak power measurement, compliance can be based on a measurement of the maximum conducted output power. The maximum conducted output power is the total transmit power delivered to all antennas and antenna elements, averaged across all symbols in the signaling alphabet when the transmitter is operating at its maximum power control level. Power must be summed across all antennas and antenna elements. The average must not include any time intervals during which the transmitter is off or transmitting at a reduced power level. If multiple modes of operation are implemented, the maximum conducted output power is the highest total transmit power occurring in any mode.

The maximum supported antenna gain is 1dBi. The peak correlated gain for each mode is listed in the table below.

Test Procedure

Ref. KDB 558074 D01 DTS Meas Guidance v03r05
ANSI C63.10: 2013

<p>Maximum Conducted Output power Test Procedure</p> <ol style="list-style-type: none"> 1. Set the radio in the continuous transmitting mode at full power 2. Compute power by integrating the spectrum across the EBW (or alternatively entire 99% OBW) of the signal using the instrument's band power measurement function. The integration shall be performed using the spectrum analyzer band-power measurement function with band limits set equal to the EBW or the OBW band edges. 3. Capture graphs and record pertinent measurement data.

Ref. 558074 D01 DTS Meas Guidance v03r05 section 9.2 Method AVGSA-1
ANSI C63.10: 2013 section 11.9.2 Method AVGSA-1

<p>Maximum Conducted Output power Test parameters</p> <p>Span = >1.5 times the OBW RBW = 3MHz VBW ≥ 3 x RBW Sweep = Auto couple Detector = Peak Allow trace to fully stabilize Use peak marker function to determine the Peak amplitude level</p>

The “measure-and-sum technique” is used for measuring in-band transmit power of a device. In the measure-and-sum approach, the conducted emission level is measured at each antenna port. The measured results at the various antenna ports are then summed mathematically to determine the total emission level from the device. Summing is performed in linear power units. (See ANSI C63.10 section 14.3 for Guidance)

System Number	Description	Samples	System under test	Support equipment
1	EUT	S01	<input checked="" type="checkbox"/>	<input type="checkbox"/>
	Support	S02	<input type="checkbox"/>	<input checked="" type="checkbox"/>

<p>Tested By : Jose Aguirre</p>	<p>Date of testing: 01-Feb-17 - 01-Feb-17</p>
<p>Test Result : PASS</p>	

See Appendix C for list of test equipment



Frequency (MHz)	Mode	Tx Paths	Correlated Antenna Gain (dBi)	Tx 1 Max Power (dBm)	Total Tx Channel Power (dBm)	Limit (dBm)	Margin (dB)
2402	GFSK, 1 Mbps	1	1	<u>2.3</u>	3.3	25.0	21.7
2426	GFSK, 1 Mbps	1	1	<u>3.1</u>	4.1	25.0	20.9
2480	GFSK, 1 Mbps	1	1	<u>4.4</u>	5.4	25.0	19.6

Maximum Output Power, 2480 MHz, 1 Mbps, GFSK

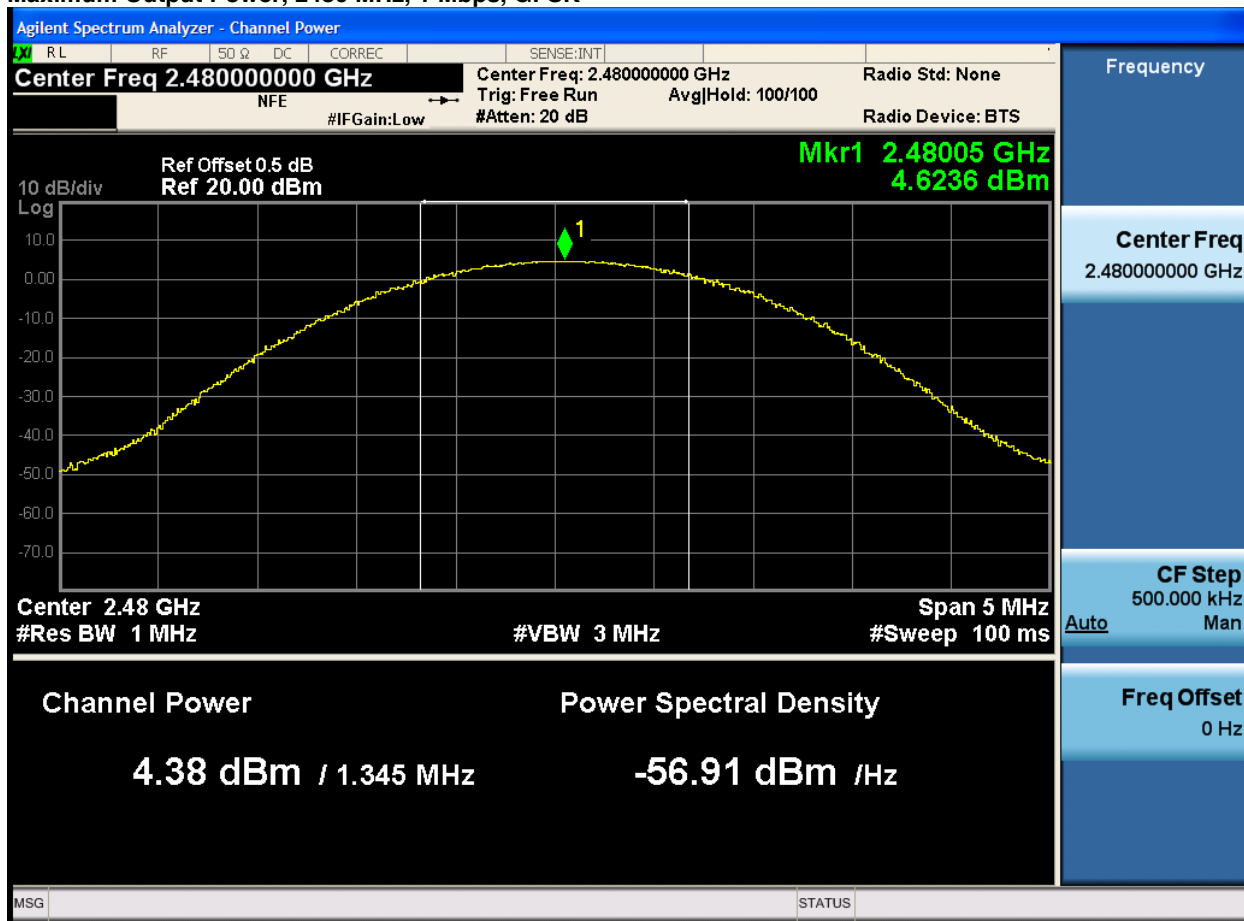



A.4 Power Spectral Density

15.247 / RSS-247 / LP0002:3.10.1(6.2.2) For digitally modulated systems, the peak power spectral density conducted from the intentional radiator to the antenna shall not be greater than 8 dBm in any 3 kHz band during any time interval of continuous transmission.

Test Procedure

Ref. KDB 558074 D01 DTS Meas Guidance v03r05
ANSI C63.10: 2013

Power Spectral Density Test Procedure
1. Set the radio in the continuous transmitting mode at full power 2. Configure Spectrum analyzer as per test parameters below and Peak search marker 3. Capture graphs and record pertinent measurement data.

Ref. 558074 D01 DTS Meas Guidance v03r05 section 10.2 Peak PSD
ANSI C63.10: 2013 section 11.10.2 Peak PSD

Power Spectral Density Test parameters
Span = >1.5 times the OBW RBW = 3 kHz ≤ RBW ≤ 100 kHz. VBW ≥ 3 x RBW Sweep = Auto couple Detector = Peak Allow trace to fully stabilize Use peak marker function to determine the Peak amplitude level

The “Measure and add 10 log(N) dB technique”, where N is the number of outputs, is used for measuring in-band Power Spectral Density. (See ANSI C63.10 section 14.3.2.3)

System Number	Description	Samples	System under test	Support equipment
1	EUT	S01	<input checked="" type="checkbox"/>	<input type="checkbox"/>
	Support	S02	<input type="checkbox"/>	<input checked="" type="checkbox"/>

Tested By : Jose Aguirre	Date of testing: 01-Feb-17 - 01-Feb-17
Test Result : PASS	

See Appendix C for list of test equipment



Frequency (MHz)	Mode	Data Rate (Mbps)	PSD / Tx Path (dBm/3kHz)	Total PSD (dBm/3kHz)	Limit (dBm/3kHz)	Margin (dB)
2402	GFSK, 1 Mbps	1	<u>-8.5</u>	-8.5	8.0	16.5
2426	GFSK, 1 Mbps	1	<u>-8.1</u>	-8.1	8.0	16.1
2480	GFSK, 1 Mbps	1	<u>-5.9</u>	-5.9	8.0	13.9

Power Spectral Density, 2480 MHz, 1 Mbps, GFSK

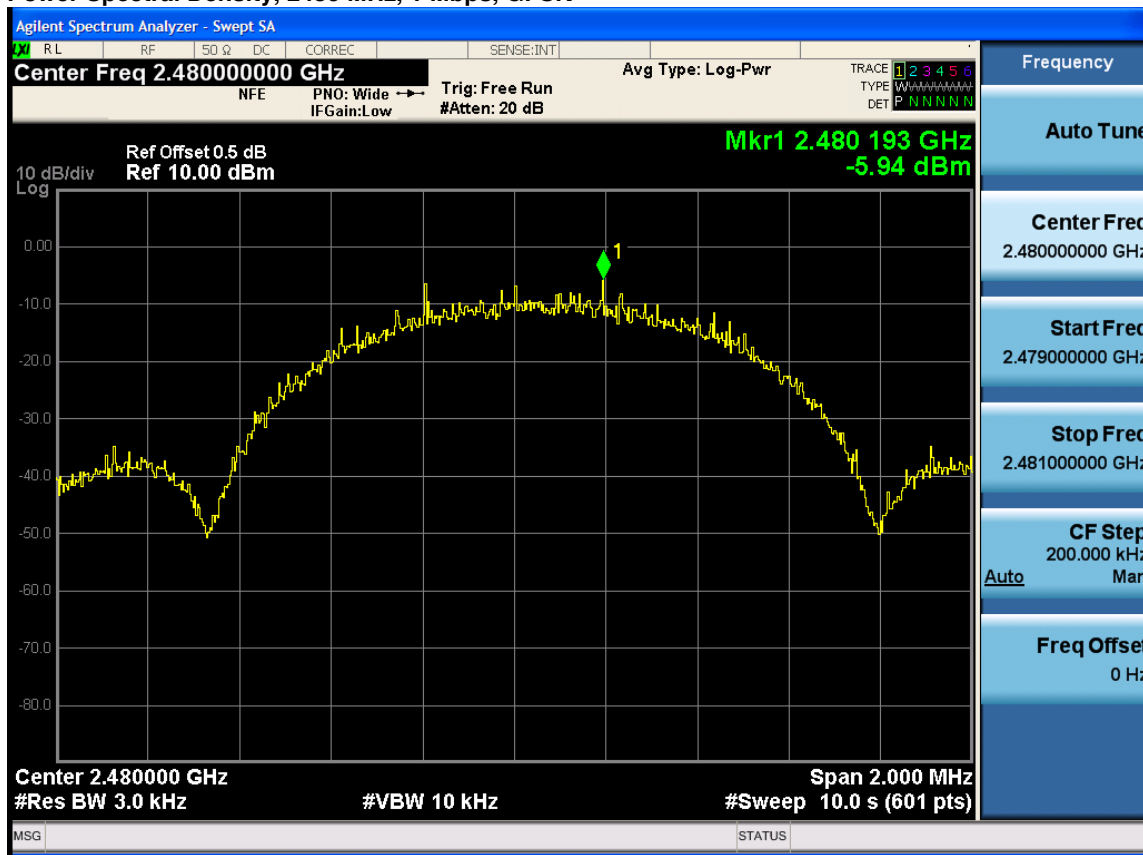



A.5 Conducted Spurious Emissions

15.205 / 15.209 / LP0002 - Radiated emissions which fall in the restricted bands, as defined in Section 15.205(a), must also comply with the radiated emission limits specified in Section 15.209(a) (see Section 15.205(c)).

RSS-Gen 8.9: Except when the requirements applicable to a given device state otherwise, emissions from licence-exempt transmitters shall comply with the field strength limits shown in Table 4 and Table 5 below. Additionally, the level of any transmitter emission shall not exceed the level of the transmitter’s fundamental emission.

RSS-Gen 8.10 (b) Unwanted emissions that fall into restricted bands of Table 6 shall comply with the limits specified in RSS-Gen; and **(c)** Unwanted emissions that do not fall within the restricted frequency bands of Table 6 shall comply either with the limits specified in the applicable RSS or with those specified in this RSS-Gen.

Use formula below to substitute conducted measurements in place of radiated measurements

$$E[\text{dB}\mu\text{V}/\text{m}] = \text{EIRP}[\text{dBm}] - 20 \log(d[\text{meters}]) + 104.77, \text{ where } E = \text{field strength and } d = 3 \text{ meter}$$

- 1) Average Plot, Limit= -41.25 dBm eirp
- 2) Peak plot, Limit = -21.25 dBm eirp

Test Procedure

Ref. KDB 558074 D01 DTS Meas Guidance v03r05
ANSI C63.10: 2013

<p>Conducted Spurious Emissions Test Procedure</p>
<ol style="list-style-type: none"> 1. Connect the antenna port(s) to the spectrum analyzer input. 2. Place the radio in continuous transmit mode 3. Configure Spectrum analyzer as per test parameters below (be sure to enter all losses between the transmitter output and the spectrum analyzer). 4. Use the peak marker function to determine the maximum spurs amplitude level. 5. The “measure-and-sum technique” is used for measuring in-band transmit power of a device. In the measure-and-sum approach, the conducted emission level is measured at each antenna port. The measured results at the various antenna ports are then summed mathematically to determine the total emission level from the device. Summing is performed in linear power units. The worst case output is recorded. (see ANSI C63.10 2013 section 14.3.2.2) 6. Capture graphs and record pertinent measurement data.

Ref. 558074 D01 DTS Meas Guidance v03r05 section 11.1b, 11.2-3, 12.2.4 & 12.2.5.3
ANSI C63.10: 2013 section 11.10.3 & 11.12.2.4 & 11.12.2.5.3

<p>Conducted Spurious Emissions Test parameters</p>
<p>RBW = 1 MHz VBW ≥ 3 x RBW for Peak, 1kHz for Average Sweep = Auto couple Detector = Peak Trace = Max Hold.</p>

KDB: 558074 D01 DTS Meas Guidance v03r05 section 12.2.2 © add the max antenna gain + ground reflection factor (4.7 dB for frequencies between 30 MHz and 1000 MHz, and 0 dB for frequencies > 1000 MHz).



System Number	Description	Samples	System under test	Support equipment
1	EUT	S01	<input checked="" type="checkbox"/>	<input type="checkbox"/>
	Support	S02	<input type="checkbox"/>	<input checked="" type="checkbox"/>

Tested By : Jose Aguirre	Date of testing: 01-Feb-17 - 01-Feb-17
Test Result : PASS	

See Appendix C for list of test equipment

Conducted Spurs Average, All Antennas

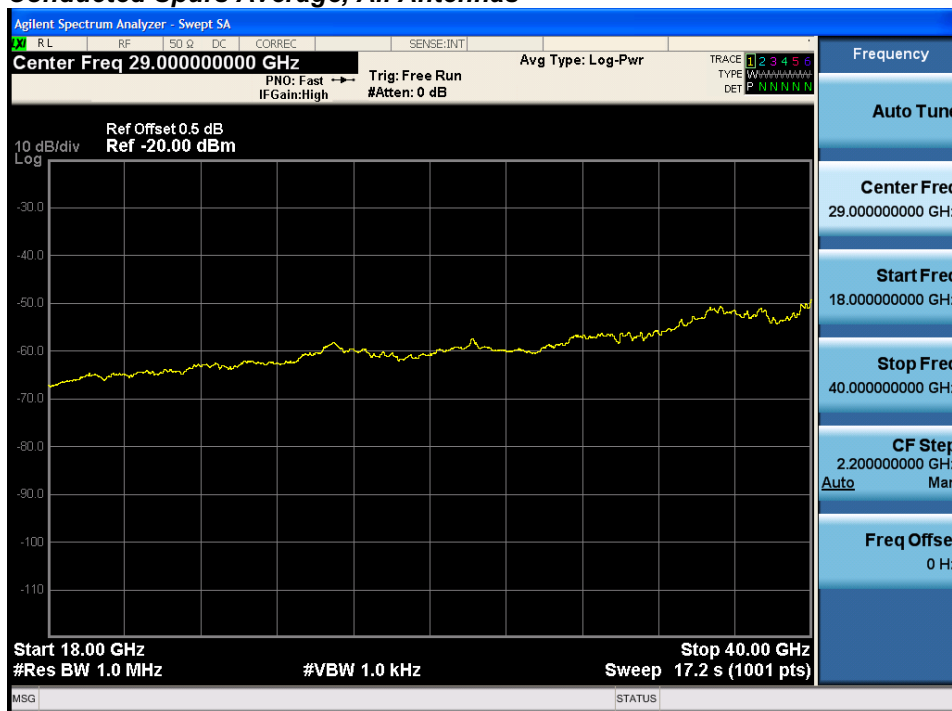

Conducted Spurs Peak, All Antennas





Frequency (MHz)	Mode	Tx Paths	Correlated Antenna Gain (dBi)	Tx 1 Spur Power (dBm)	Total Conducted Spur (dBm)	Limit (dB)	Margin (dB)
2402	GFSK, 1 Mbps	1	1	<u>-49.0</u>	-48.0	-41.25	6.8
2426	GFSK, 1 Mbps	1	1	<u>-53.1</u>	-52.1	-41.25	10.9
2480	GFSK, 1 Mbps	1	1	<u>-55.9</u>	-54.9	-41.25	13.7

Conducted Spurs Average, 2402 MHz, 1 Mbps, GFSK

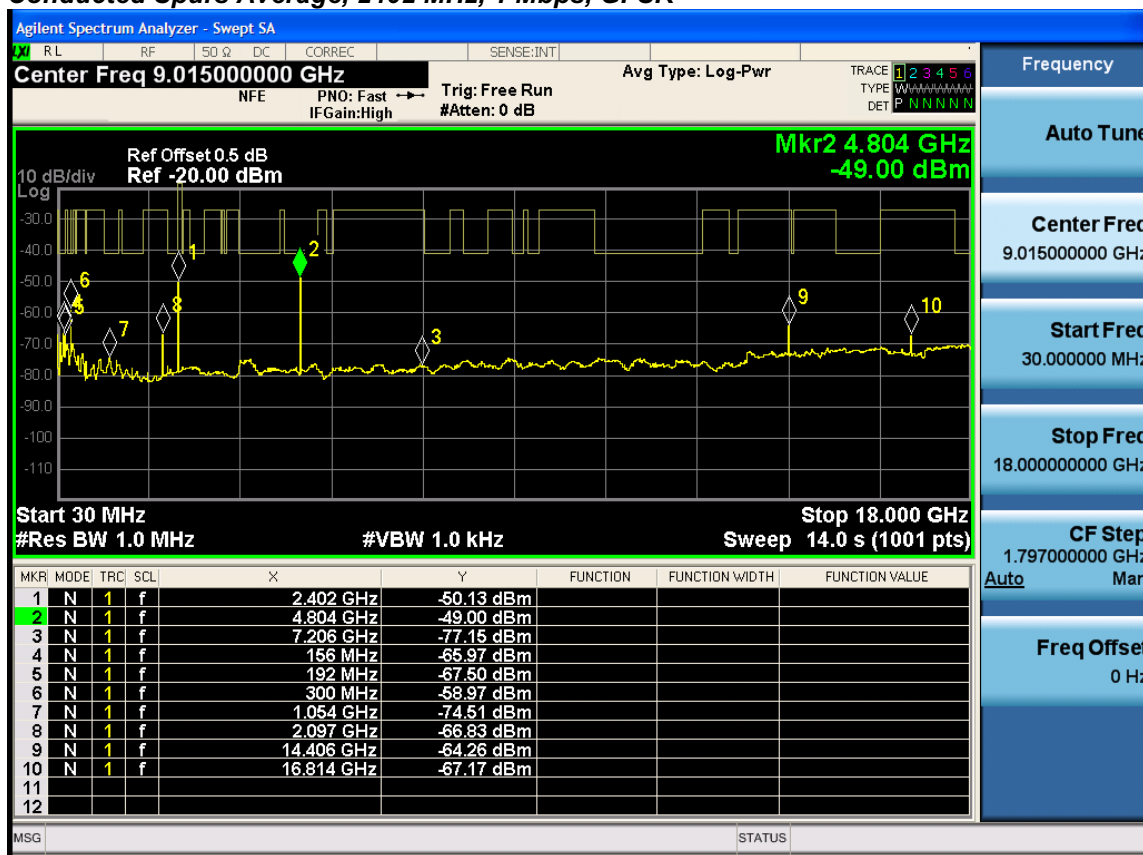



Frequency (MHz)	Mode	Tx Paths	Correlated Antenna Gain (dBi)	Tx 1 Spur Power (dBm)	Total Conducted Spur (dBm)	Limit (dB)	Margin (dB)
2402	GFSK, 1 Mbps	1	1	-45.6	-44.6	-21.25	23.4
2426	GFSK, 1 Mbps	1	1	-47.4	-46.4	-21.25	25.2
2480	GFSK, 1 Mbps	1	1	-49.2	-48.2	-21.25	27.0

Conducted Spurs Peak, 2402 MHz, 1 Mbps, GFSK

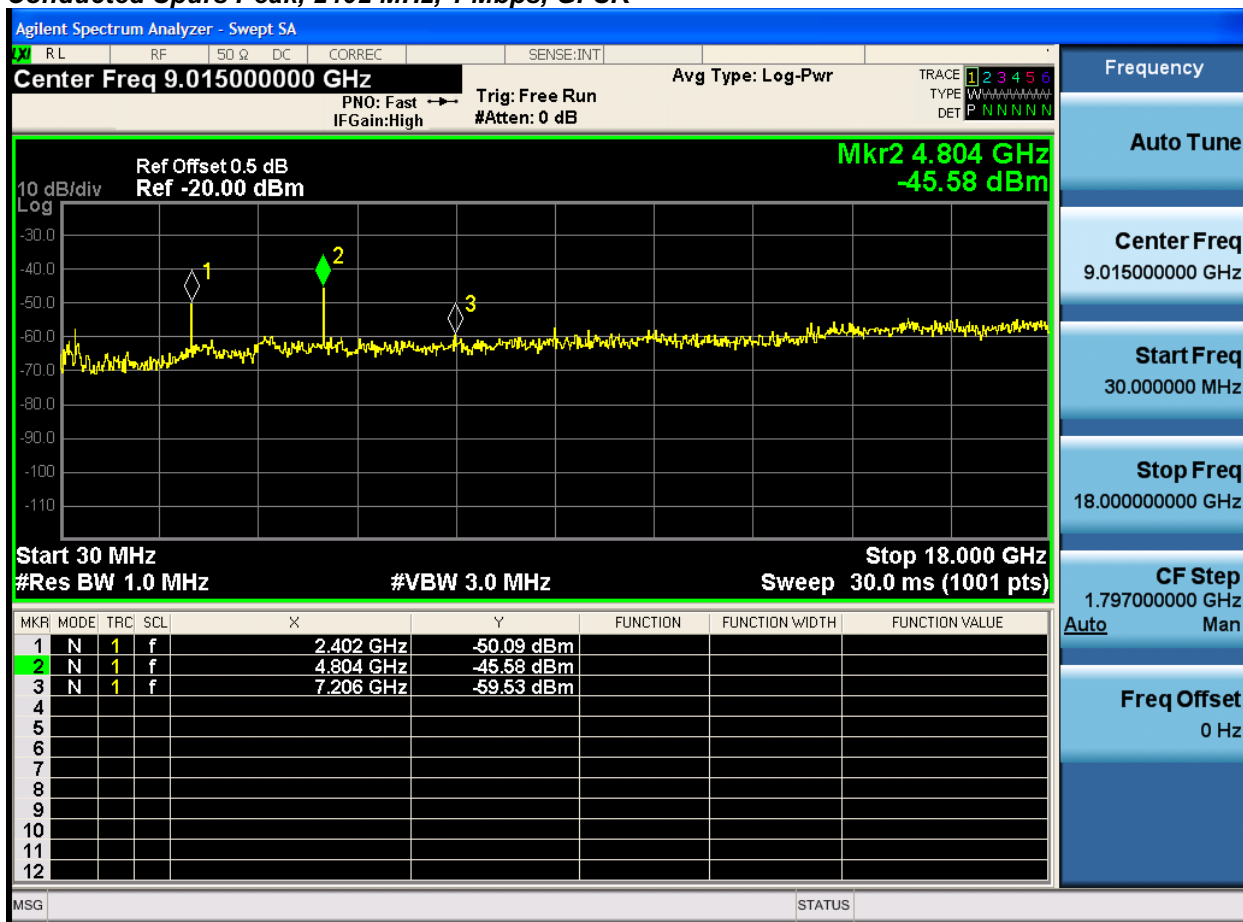



A.6 Conducted Bandedge

15.205 / 15.247 / RSS-Gen / RSS-247 / LP0002:3.10.1(5) & 2.8 In any 100 kHz bandwidth outside the frequency band in which the digitally modulated intentional radiator is operating, the radio frequency power that is produced by the intentional radiator shall be at least 30 dB below that in the 100 kHz bandwidth within the band that contains the highest level of the desired power.

Radiated emissions which fall in the restricted bands, as defined in Section 15.205(a), and RSS-Gen 8.10 must also comply with the radiated emission limits specified in Section 15.209(a) (see Section 15.205(c)) and RSS-Gen 8.9..

Test Procedure

Ref. KDB 558074 D01 DTS Meas Guidance v03r05
ANSI C63.10: 2013

<p>Conducted Band edge Test Procedure</p> <ol style="list-style-type: none"> 1. Connect the antenna port(s) to the spectrum analyzer input. 2. Place the radio in continuous transmit mode. Use the procedures in KDB 558074 D01 DTS Meas Guidance v03r05 to substitute conducted measurements in place of radiated measurements. 3. Configure Spectrum analyzer as per test parameters below below (be sure to enter all losses between the transmitter output and the spectrum analyzer). 4. Place a marker at the end of the restricted band closest to the transmit frequency to show compliance. Also measure any emissions in the restricted bands.. 5. The “measure-and-sum technique” is used for measuring in-band transmit power of a device. In the measure-and-sum approach, the conducted emission level is measured at each antenna port. The measured results at the various antenna ports are then summed mathematically to determine the total emission level from the device. Summing is performed in linear power units. The worst case output is recorded. 6. Place a marker at the end of the restricted band closest to the transmit frequency to show compliance. Also measure any emissions in the restricted bands 7. Capture graphs and record pertinent measurement data.
--

<p>Conducted Bandedge Test parameters non-restricted Band KDB 558074 D01 v03r05 section 11.1b, 11.2-3, also see ANSI C63.10: 2013 section 11.10.3</p> <p>RBW = 100 kHz VBW ≥ 3 x RBW Sweep = Auto couple Detector = Peak Trace = Max Hold.</p>	<p>Conducted Bandedge Test parameters restricted Band KDB 558074 D01 v03r05 section 12.2.4 & 12.2.5.3 also see ANSI C63.10: 2013 section 11.12.4 & 11.12.5.3</p> <p>RBW = 1 MHz VBW ≥ 3 x RBW for Peak, 100Hz for Average Sweep = Auto couple Detector = Peak Trace = Max Hold.</p>
---	--

System Number	Description	Samples	System under test	Support equipment
1	EUT	S01	<input checked="" type="checkbox"/>	<input type="checkbox"/>
	Support	S02	<input type="checkbox"/>	<input checked="" type="checkbox"/>

<p>Tested By : Jose Aguirre</p>	<p>Date of testing: 01-Feb-17 - 01-Feb-17</p>
<p>Test Result : PASS</p>	

See Appendix C for list of test equipment



Restricted Band Average

Frequency (MHz)	Mode	Tx Paths	Correlated Antenna Gain (dBi)	Tx 1 Bandedge Level (dBm)	Total Tx Bandedge Level (dBm)	Limit (dB)	Margin (dB)
2402	GFSK, 1 Mbps	1	1	-60.6	-59.6	-41.25	18.4
2480	GFSK, 1 Mbps	1	1	-54.0	-53.0	-41.25	11.75



Conducted Bandedge Average, 2402 MHz, 1 Mbps, GFSK

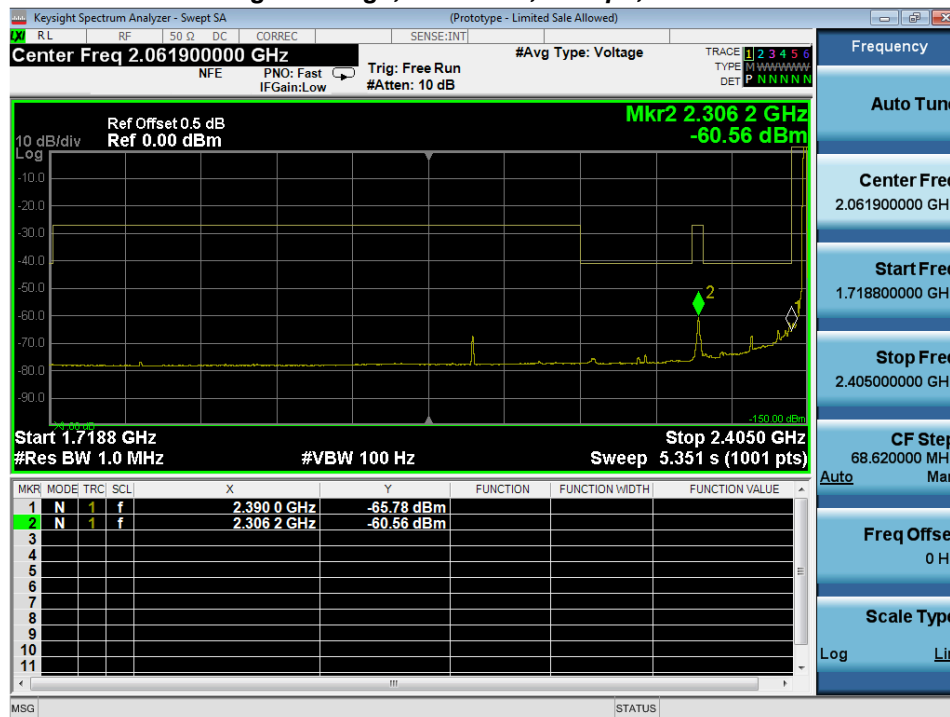

Conducted Bandedge Average, 2480 MHz, 1 Mbps, GFSK

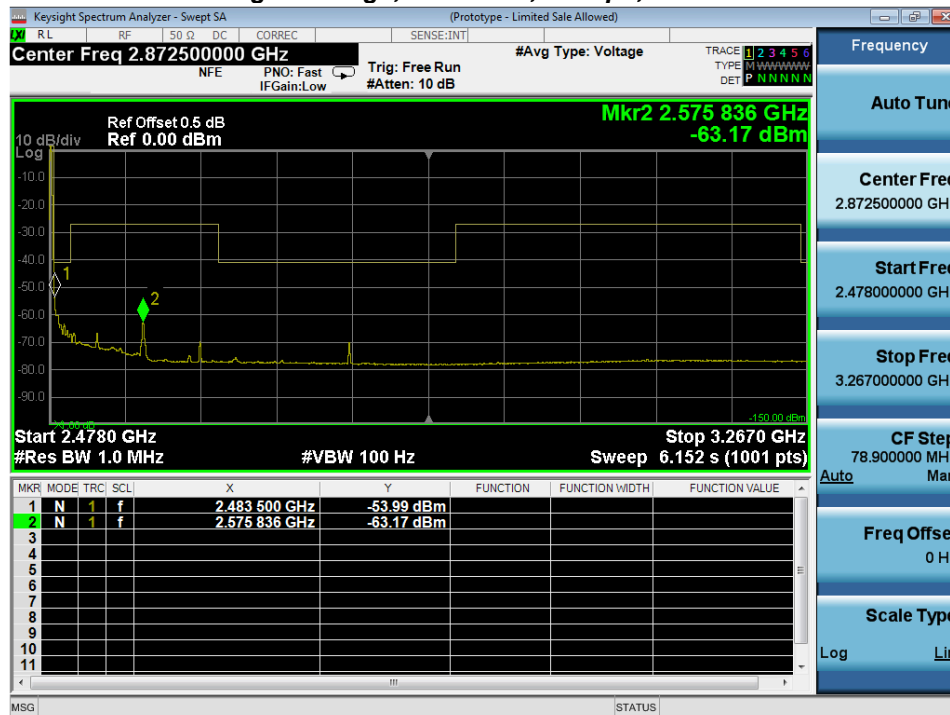



Restricted Band Peak

Frequency (MHz)	Mode	Tx Paths	Correlated Antenna Gain (dBi)	Tx 1 Bandedge Level (dBm)	Total Tx Bandedge Level (dBm)	Limit (dB)	Margin (dB)
2402	GFSK, 1 Mbps	1	1	<u>-55.5</u>	-54.5	-21.25	33.3
2480	GFSK, 1 Mbps	1	1	<u>-44.9</u>	-43.9	-21.25	22.7



Conducted Bandedge Peak, 2402 MHz, 1 Mbps, GFSK

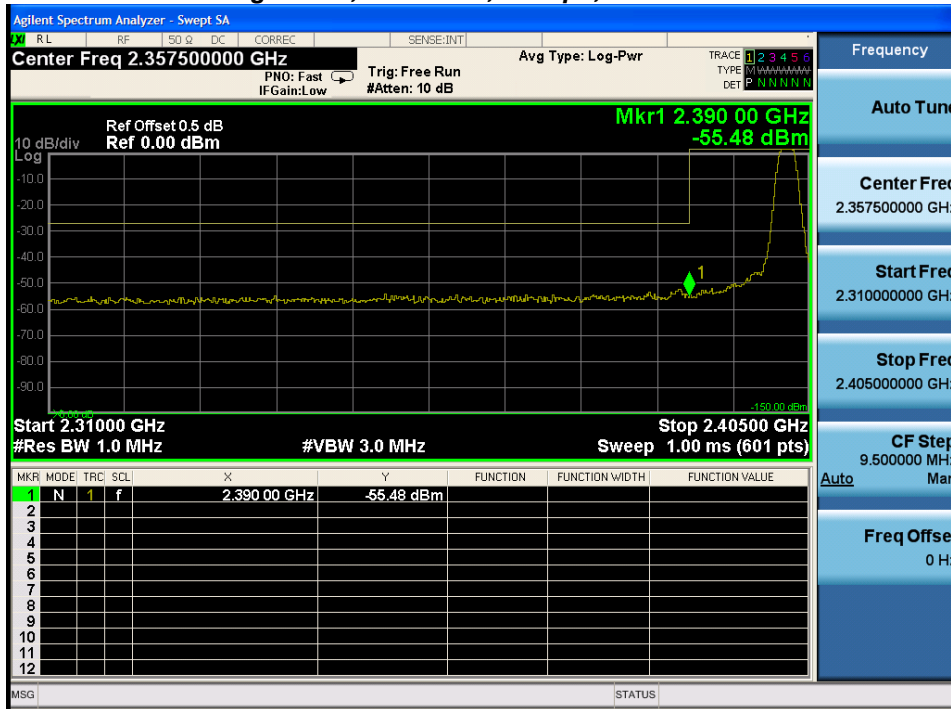

Conducted Bandedge Peak, 2480 MHz, 1 Mbps, GFSK





Non-Restricted Band

Frequency (MHz)	Mode	Data Rate (Mbps)	Conducted Bandedge Delta (dB)	Limit (dBc)	Margin (dB)
2402	GFSK, 1 Mbps	1	42.6	>30	12.6

Conducted Bandedge Average, 2402 MHz, 1 Mbps, GFSK

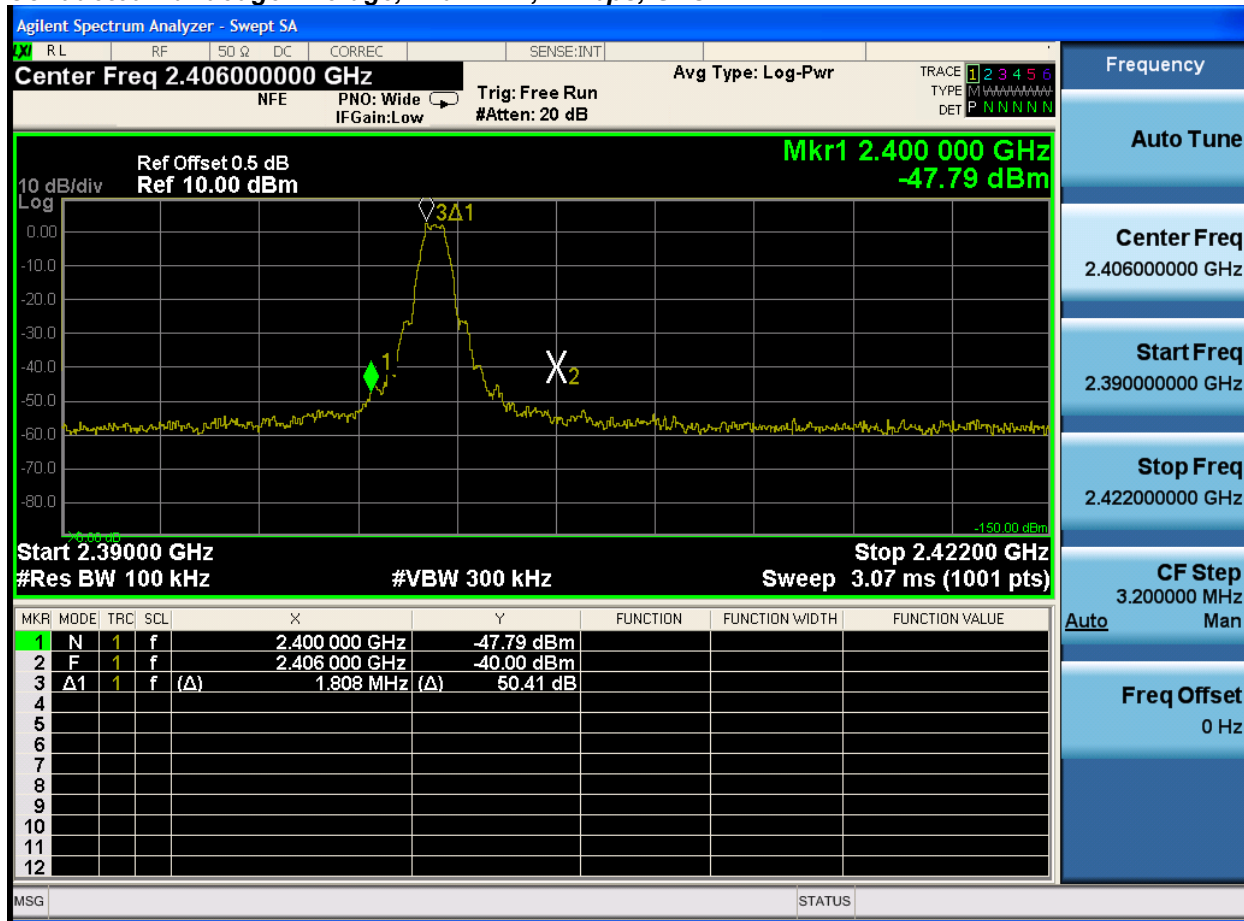

Appendix B: Emission Test Results

Testing Laboratory: Cisco Systems, Inc., 125 West Tasman Drive, San Jose, CA 95134, USA

Radiated Emission Setup Diagram-Below 1G

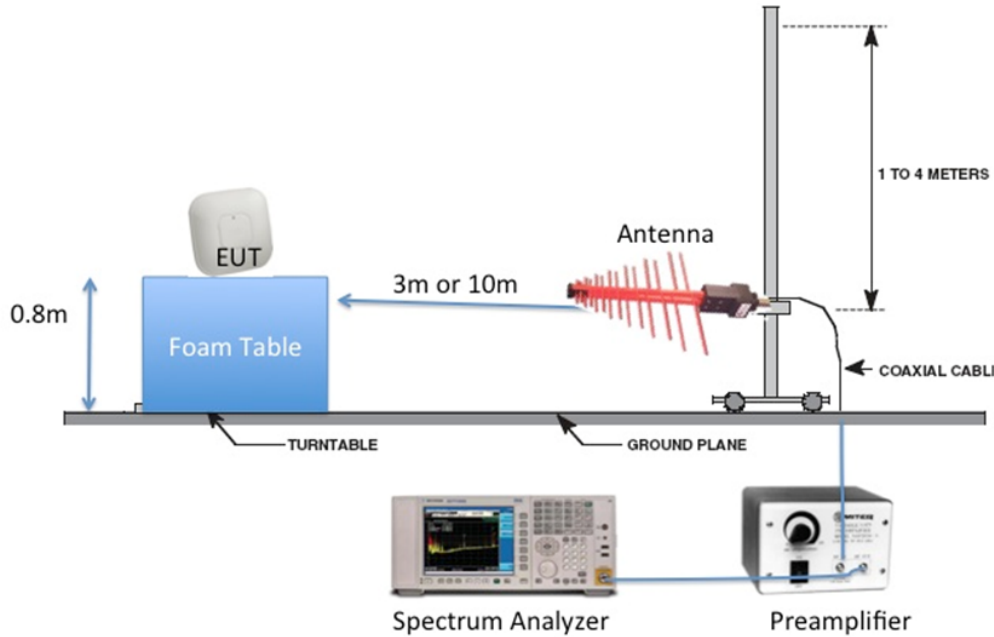

Radiated Emission Setup Diagram-Above 1G

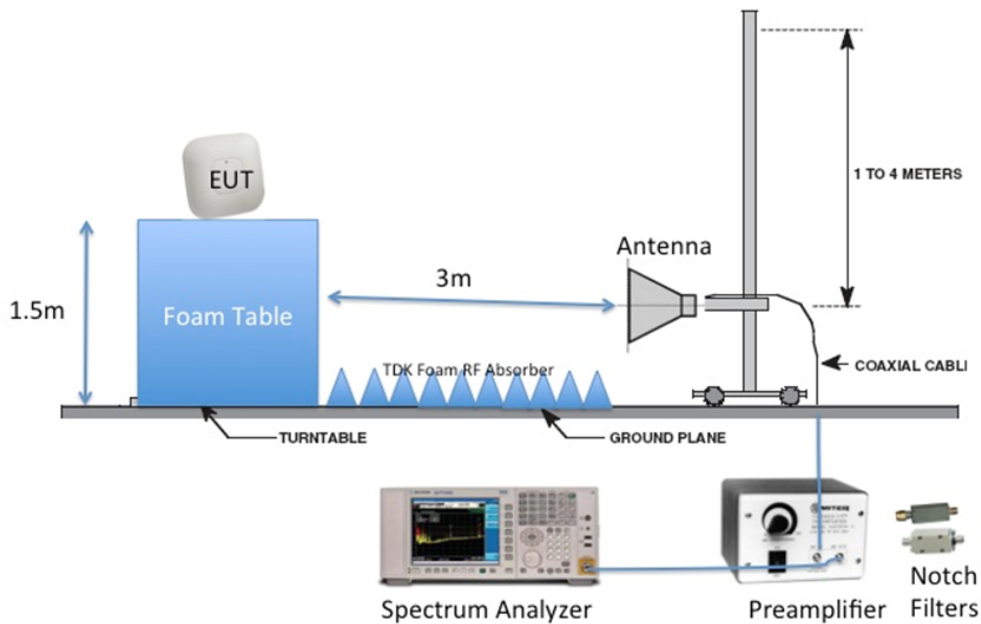



B.1 Radiated Spurious Emissions

15.205 / RSS-Gen / LP0002:3.10.1(5)/2.8 Radiated emissions which fall in the restricted bands, as defined in Section 15.205(a) and RSS-Gen 8.10, must also comply with the radiated emission limits specified in Section 15.209(a) (see Section 15.205(c)) and RSS-Gen 8.9.

Ref. ANSI C63.10: 2013 section 4.1.4.2.2, 4.1.4.2.3, 6.6.4 & 11.12.2

Using Vasona, configure the spectrum analyzer as shown below (be sure to enter all losses between the transmitter output and the spectrum analyzer). Place the radio in continuous transmit mode.

Span:	1GHz – 18 GHz
Reference Level:	80 dBuV
Attenuation:	10 dB
Sweep Time:	Coupled
Resolution Bandwidth:	1MHz
Video Bandwidth:	3 MHz for peak, 1 KHz for average
Detector:	Peak

Terminate the access Point RF ports with 50 ohm loads.

Maximize Turntable (find worst case table angle), Maximize Antenna (find worst case height)

Save 2 plots: 1) Average plot, Limit= 54dBuV/m @3m
 2) Peak plot, Limit = 74dBuV/m @3m

Place a marker at the end of the restricted band closest to the transmit frequency to show compliance. Also measure any emissions in the restricted bands.

This report represents the worst case data for all supported operating modes and antennas. There are no measurable emissions above 18 GHz.

System Number	Description	Samples	System under test	Support equipment
2	EUT	S03	<input checked="" type="checkbox"/>	<input type="checkbox"/>
	Support	S04	<input type="checkbox"/>	<input checked="" type="checkbox"/>

Tested By : Jose Aguirre	Date of testing: 01-Feb-17 - 07-Feb-17
Test Result : PASS	

See Appendix C for list of test equipment

B.1.A Transmitter Radiated Spurious Emissions-Average Worst Case

Frequency (MHz)	Mode	Data Rate (Mbps)	Spurious Emission Level (dBuV/m)	Limit (dBuV/m)	Margin (dBuV/m)
2402	GFSK, 1 Mbps	1	48.0	54.0	6.0
2426	GFSK, 1 Mbps	1	47.3	54.0	6.7
2480	GFSK, 1 Mbps	1	47.9	54.0	6.1

Average Radiated Transmitter Spurs, 2402 MHz, GFSK, 1 Mbps



Average Radiated Transmitter Spurs, 2426 MHz, GFSK, 1 Mbps



Average Radiated Transmitter Spurs, 2480 MHz, GFSK, 1 Mbps



Average Radiated Transmitter Spurs, All rates, All Modes



No emissions seen above 18GHz, the plot above is representative of all modes tested.

B.1.P Transmitter Radiated Spurious Emissions-Peak Worst Case

Frequency (MHz)	Mode	Data Rate (Mbps)	Spurious Emission Level (dBuV/m)	Limit (dBuV/m)	Margin (dBuV/m)
2402	GFSK, 1 Mbps	1	60.5	74.0	13.5
2426	GFSK, 1 Mbps	1	60.2	74.0	13.8
2480	GFSK, 1 Mbps	1	61.1	74.0	12.9

Peak Radiated Transmitter Spurs, 2402 MHz, GFSK, 1 Mbps

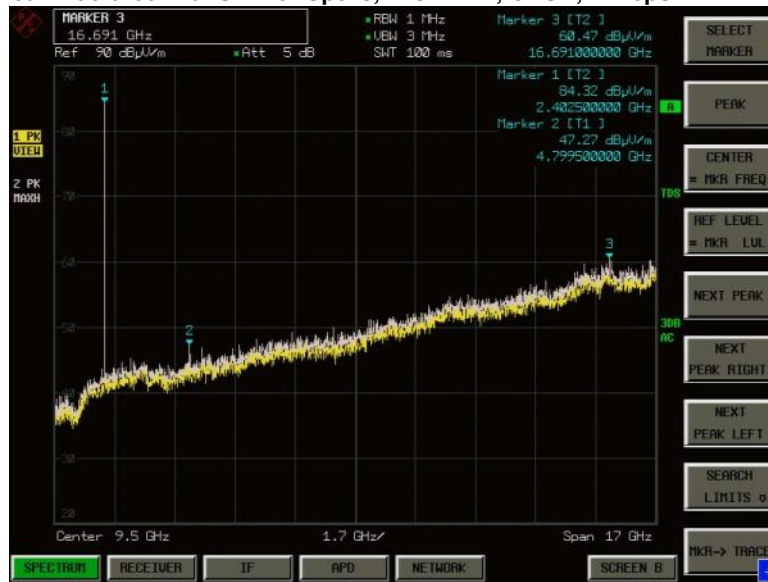

Peak Radiated Transmitter Spurs, 2426 MHz, GFSK, 1 Mbps

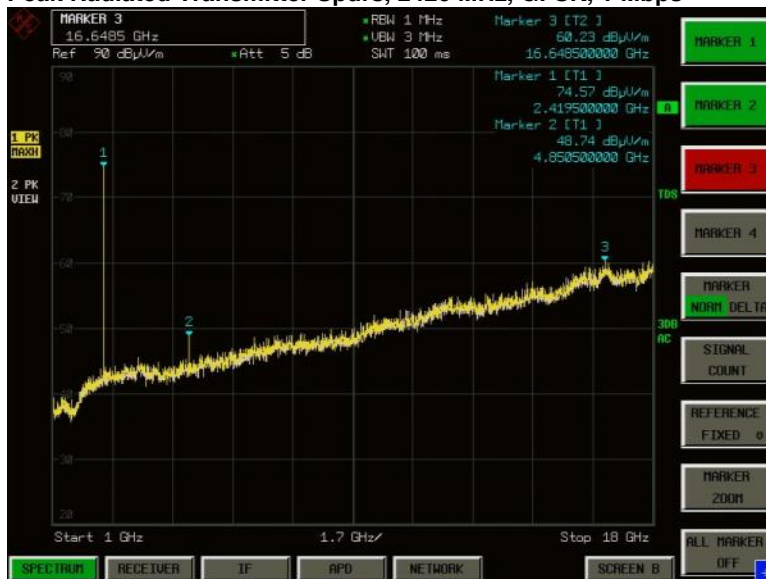

Peak Radiated Transmitter Spurs, 2480 MHz, GFSK, 1 Mbps



Peak Radiated Transmitter Spurs, All rates, All Modes

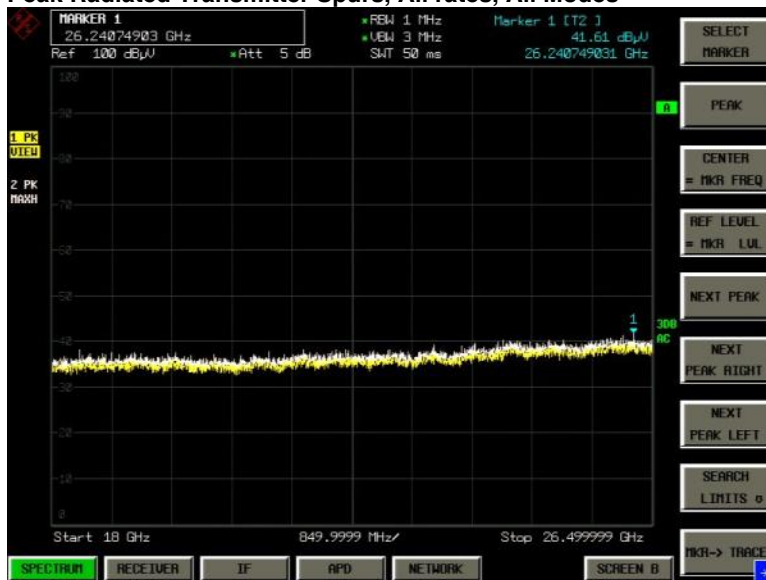

No emissions seen above 18GHz, the plot above represents worst case for all modes tested.



B.2 Receiver Spurious Emissions

RSS-Gen Receivers are required to comply with the limits of spurious emissions as set out in this section. Receiver emission measurements are to be performed as per the normative test method referenced in Section 3.

Radiated emissions which fall in the restricted bands, as defined in RSS-Gen section 8.10, must also comply with the radiated emission limits specified in RSS-Gen section 8.9.

For emissions at frequencies below 1 GHz, measurements shall be performed using a CISPR quasi-peak detector and the related measurement bandwidth. At frequencies above 1 GHz, measurements shall be performed using a linear average detector with a minimum resolution bandwidth of 1 MHz.

Ref. RSS-Gen section 8.9 & 8.10
ANSI C63.10: 2013 section 4.1.4.2.2, 4.1.4.2.3, 6.6.4 & 11.12.2

Using Vasona, configure the spectrum analyzer as shown below (be sure to enter all losses between the transmitter output and the spectrum analyzer). Place the radio in continuous transmit mode.

Span:	1GHz – 18 GHz
Reference Level:	80 dBuV
Attenuation:	10 dB
Sweep Time:	Coupled
Resolution Bandwidth:	1MHz
Video Bandwidth:	3MHz for Peak, 1 kHz for average
Detector:	Peak

Radiated emission measurements shall be performed with the receiver antenna connected to the receiver antenna terminals.

Maximize Turntable (find worst case table angle), Maximize Antenna (find worst case height)

Save plot: 1) Average Plot (Vertical and Horizontal), Limit= 54dBuV/m @3m
 2) Peak Plot (Vertical and Horizontal), Limit= 74dBuV/m @3m

This report represents the worst case data for all supported operating modes and antennas. There are no measurable emissions above 18 GHz.

System Number	Description	Samples	System under test	Support equipment
2	EUT	S03	<input checked="" type="checkbox"/>	<input type="checkbox"/>
	Support	S04	<input type="checkbox"/>	<input checked="" type="checkbox"/>

Tested By : Jose Aguirre	Date of testing: 01-Feb-17 - 07-Feb-17
Test Result : PASS	

See Appendix C for list of test equipment

B.2.A Receiver Radiated Spurious Emissions (Average Measurements)

Average Radiated Receiver Spurs, All Rates, All Modes, (1-18GHz)



Radiated Receiver Spurs, All rate, All modes, Average (18-26.5GHz)

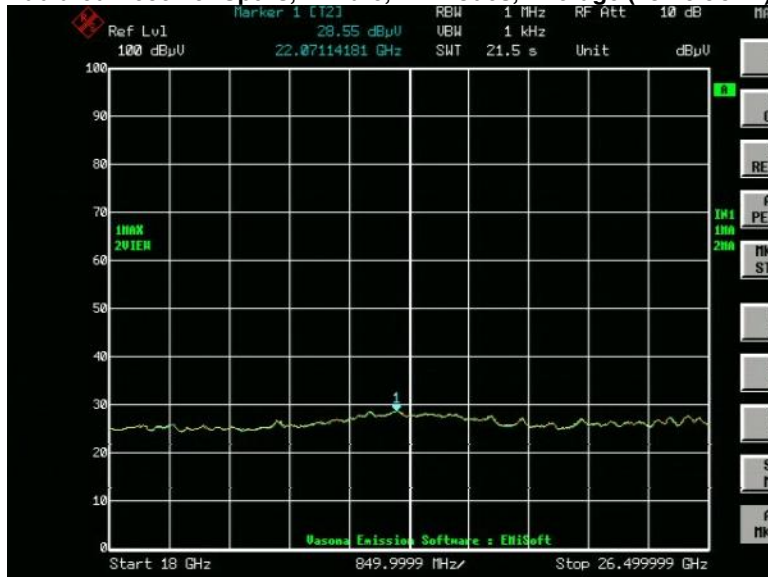

No emissions seen above 18GHz. The plots above are representative of all modes tested.

B.2.A Receiver Radiated Spurious Emissions (Peak Measurements)

Peak Radiated Receiver Spurs, All Rates, All Modes, (1-18GHz)



Radiated Receiver Spurs, All rate, All modes, Peak (18-26.5GHz)

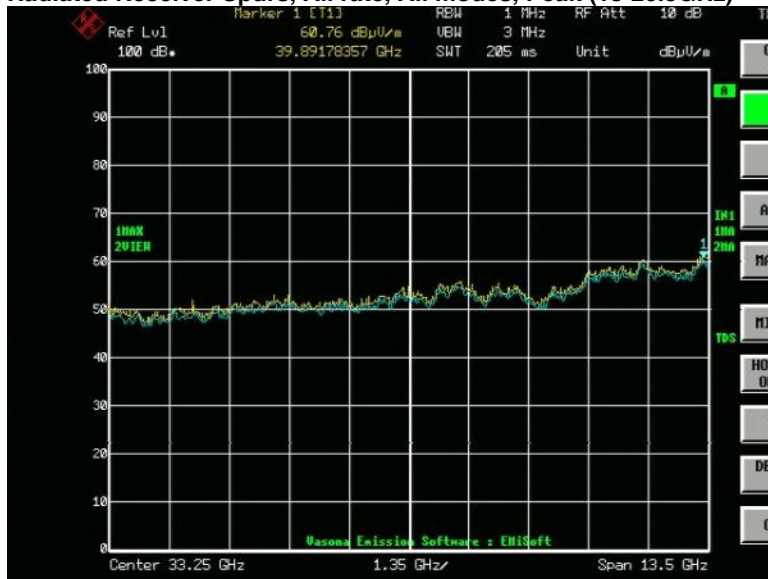

No emissions seen above 18GHz. The plots above are representative of all modes tested.



B.3 Radiated Emissions 30MHz to 1GHz

15.205 / 15.209 / RSS-Gen / LP0002:3.10.1(5)/2.8 Radiated emissions which fall in the restricted bands, as defined in Section 15.205(a), must also comply with the radiated emission limits specified in Section 15.209(a) (see Section 15.205(c)) and RSS-Gen section 8.9.

Ref. ANSI C63.10: 2013 section 6.5

Using Vasona, configure the spectrum analyzer as shown below (be sure to enter all losses between the transmitter output and the spectrum analyzer). Place the radio in continuous transmit mode.

Span:	30MHz – 1GHz
Reference Level:	80 dBuV
Attenuation:	10 dB
Sweep Time:	Coupled
Resolution Bandwidth:	100kHz
Video Bandwidth:	300kHz
Detector:	Peak for Pre-scan, Quasi-Peak

Compliance shall be determined using CISPR quasi-peak detection; however, peak detection is permitted as an alternative to quasi-peak detection.

Terminate the access Point RF ports with 50 ohm loads.

Maximize Turntable (find worst case table angle), Maximize Antenna (find worst case height)

This report represents the worst case data for all supported operating modes and antennas.

System Number	Description	Samples	System under test	Support equipment
1	EUT	S01	<input checked="" type="checkbox"/>	<input type="checkbox"/>
	Support	S02	<input type="checkbox"/>	<input checked="" type="checkbox"/>

Tested By : Jose Aguirre	Date of testing: 01-Feb-17 - 07-Feb-17
Test Result : PASS	

See Appendix C for list of test equipment



Graphical Test Results

Note that the data displayed on the plots detailed in this appendix were measured using a 'Peak Detector'. Please refer to the results table for the detectors used during formal measurements

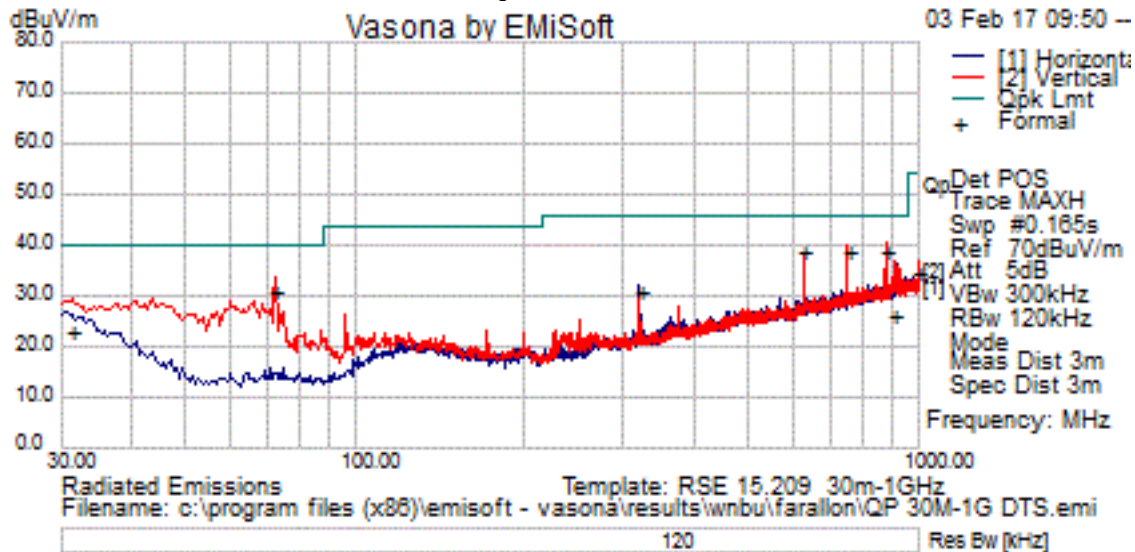

Test Results

Frequency MHz	Raw dBuV	Cable Loss	AF dB	Level dBuV/m	Measurement Type	Pol	Hgt cm	Azt Deg	Limit dBuV/m	Margin dB	Pass /Fail
874.988	14.4	2.6	22.1	39	Quasi Max	V	101	77	46	-7	Pass
749.986	15.7	2.4	20.8	38.9	Quasi Max	V	103	133	46	-7.1	Pass
72.138	22.3	0.8	8.1	31.1	Quasi Max	V	189	360	40	-8.9	Pass
624.994	17.5	2.2	19.4	39	Quasi Max	V	120	95	46	-7	Pass
909.735	1	2.6	22.5	26.1	Quasi Max	V	109	270	46	-19.9	Pass
31.282	2.3	0.4	20.3	23.1	Quasi Max	V	115	74	40	-16.9	Pass
319.993	15.6	1.6	13.9	31	Quasi Max	H	120	76	46	-15	Pass
999.984	8.4	2.7	23.3	34.5	Quasi Max	V	102	338	54	-19.5	Pass



B.4 AC Conducted Emissions

FCC 15.207 (a) & RSS-Gen 8.8 / LP0002:2.3 Except when the requirements applicable to a given device state otherwise, for any radio apparatus equipped to operate from the public utility AC power supply, either directly or indirectly (such as with a battery charger), the radio frequency voltage of emissions conducted back onto the AC power lines in the frequency range of 0.15 MHz to 30 MHz shall not exceed the limits shown in the table in these sections. The more stringent limit applies at the frequency range boundaries.

Measurement Procedure
 Accordance with ANSI C63.10:2013 section 6.2

Using Vasona, configure the spectrum analyzer as shown below (be sure to enter all losses between the transmitter output and the spectrum analyzer). Place the radio in continuous transmit mode.

Span: 150 KHz – 30 MHz
 Attenuation: 10 dB
 Sweep Time: Coupled
 Resolution Bandwidth: 9 KHz
 Video Bandwidth: 30 KHz
 Detector: Quasi-Peak / Average

System Number	Description	Samples	System under test	Support equipment
2	EUT	S03	<input checked="" type="checkbox"/>	<input type="checkbox"/>
	Support	S04	<input type="checkbox"/>	<input checked="" type="checkbox"/>

Tested By : Jose Aguirre	Date of testing: 01-Feb-17 - 07-Feb-17
Test Result : PASS	

See separate EMC test report for test data.



Graphical Test Results

Note that the data displayed on the plots detailed in this appendix were measured using a 'Peak Detector'. Please refer to the results table for the detectors used during formal measurements

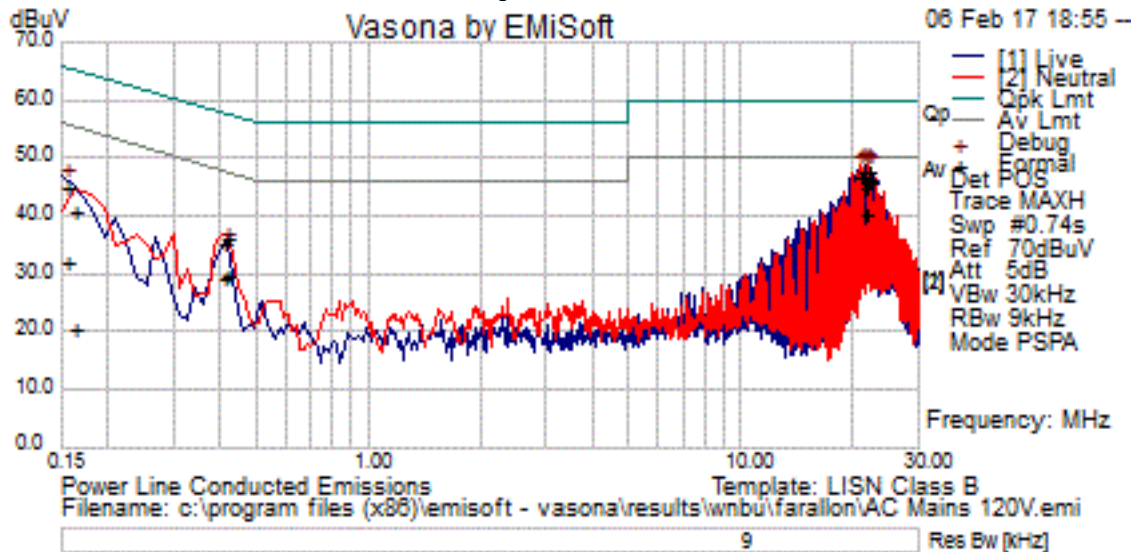

Test Results

Frequency MHz	Raw dBuV	Cable Loss	Factors dB	Level dBuV	Measurement Type	Line	Limit dBuV	Margin dB	Pass /Fail
21.661	24.2	20.4	0.3	44.9	Quasi Peak	Live	60	-15.1	Pass
0.155	24	21	0.1	45.1	Quasi Peak	Live	65.7	-20.6	Pass
21.063	27.4	20.4	0.3	48.1	Quasi Peak	Live	60	-11.9	Pass
22.255	25.9	20.4	0.3	46.6	Quasi Peak	Live	60	-13.4	Pass
0.416	16.2	20	0	36.2	Quasi Peak	Live	57.5	-21.3	Pass
22.056	27.1	20.4	0.3	47.9	Quasi Peak	Live	60	-12.1	Pass
21.858	25.6	20.4	0.3	46.3	Quasi Peak	Live	60	-13.7	Pass
20.866	26.1	20.4	0.3	46.8	Quasi Peak	Live	60	-13.2	Pass
22.058	27.3	20.4	0.3	48	Quasi Peak	Neutral	60	-12	Pass
21.66	24.5	20.4	0.3	45.2	Quasi Peak	Neutral	60	-14.8	Pass
0.41	15.5	20	0	35.6	Quasi Peak	Neutral	57.6	-22.1	Pass
21.859	25.8	20.4	0.3	46.4	Quasi Peak	Neutral	60	-13.6	Pass
0.163	19.8	21	0.1	40.8	Quasi Peak	Neutral	65.3	-24.5	Pass
21.065	27.3	20.4	0.3	48	Quasi Peak	Neutral	60	-12	Pass
20.867	26.1	20.4	0.3	46.8	Quasi Peak	Neutral	60	-13.2	Pass
22.256	25.4	20.4	0.3	46.2	Quasi Peak	Neutral	60	-13.8	Pass
21.661	19.8	20.4	0.3	40.5	Average	Live	50	-9.5	Pass
0.155	11.1	21	0.1	32.2	Average	Live	55.7	-23.6	Pass
21.063	27.3	20.4	0.3	48	Average	Live	50	-2	Pass
22.255	25.8	20.4	0.3	46.5	Average	Live	50	-3.5	Pass
0.416	9.6	20	0	29.6	Average	Live	47.5	-17.9	Pass
22.056	27.1	20.4	0.3	47.8	Average	Live	50	-2.2	Pass
21.858	25.5	20.4	0.3	46.2	Average	Live	50	-3.8	Pass
20.866	26.1	20.4	0.3	46.8	Average	Live	50	-3.2	Pass
22.058	27.2	20.4	0.3	47.9	Average	Neutral	50	-2.1	Pass
21.66	19.6	20.4	0.3	40.3	Average	Neutral	50	-9.7	Pass
0.41	9.5	20	0	29.6	Average	Neutral	47.6	-18.1	Pass
21.859	25.7	20.4	0.3	46.4	Average	Neutral	50	-3.6	Pass
0.163	-0.4	21	0.1	20.6	Average	Neutral	55.3	-34.7	Pass
21.065	27.1	20.4	0.3	47.7	Average	Neutral	50	-2.3	Pass
20.867	26.1	20.4	0.3	46.8	Average	Neutral	50	-3.2	Pass
22.256	25.4	20.4	0.3	46.1	Average	Neutral	50	-3.9	Pass

Photographs of setup

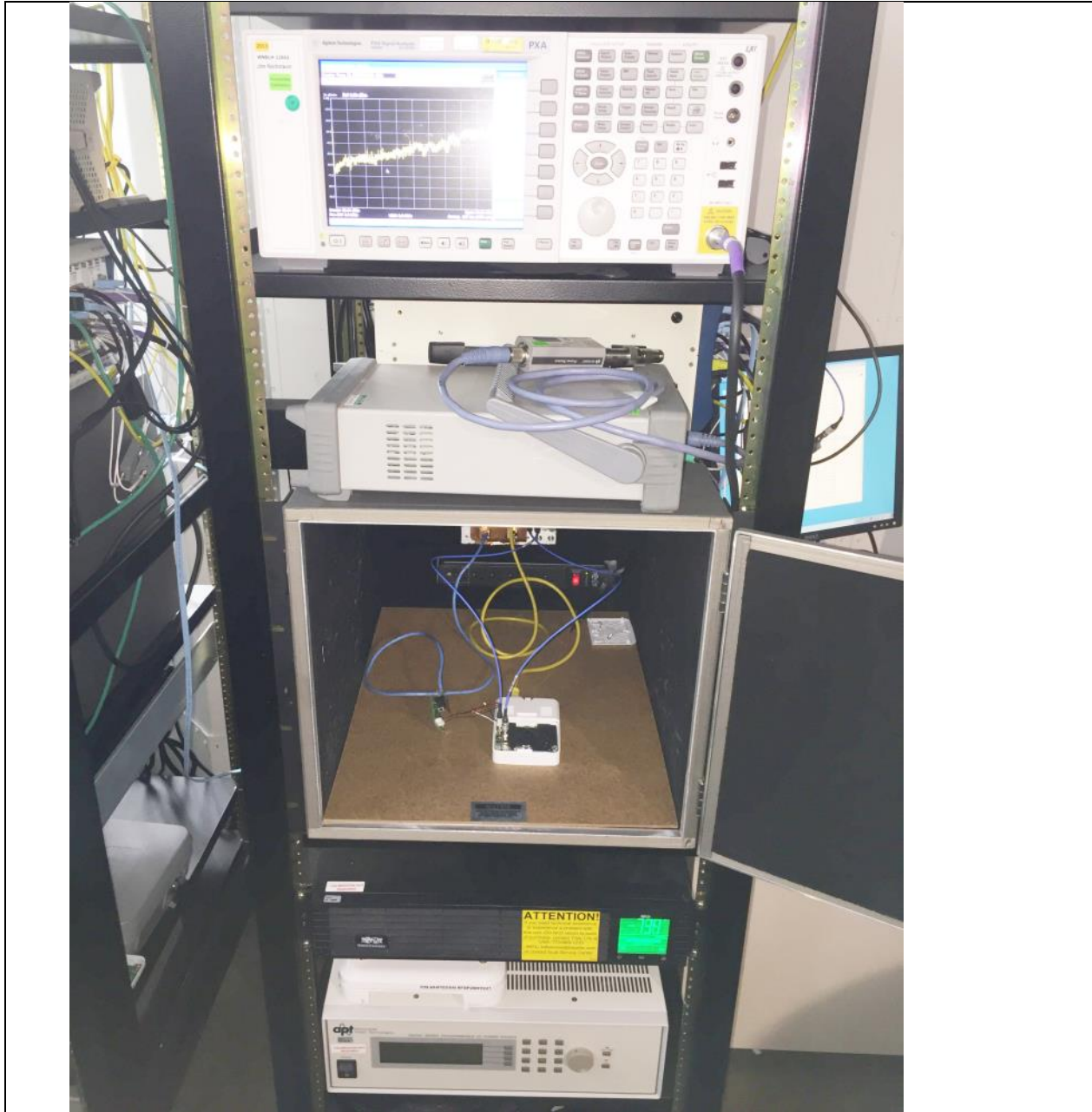

Title: Conducted Test Setup

This is a dual band 2.4GHz / 5GHz device. All ports in this test set up photo are connected as all testing is automated. Section 2.6 of this test report given an overview of the different Tx antenna combinations used by this device.

AIR-AP1800I-x-K9 AC Mains Conducted Emissions setup



AIR-AP1800I-x-K9 Radiated Emissions setup 30MHz – 1GHz

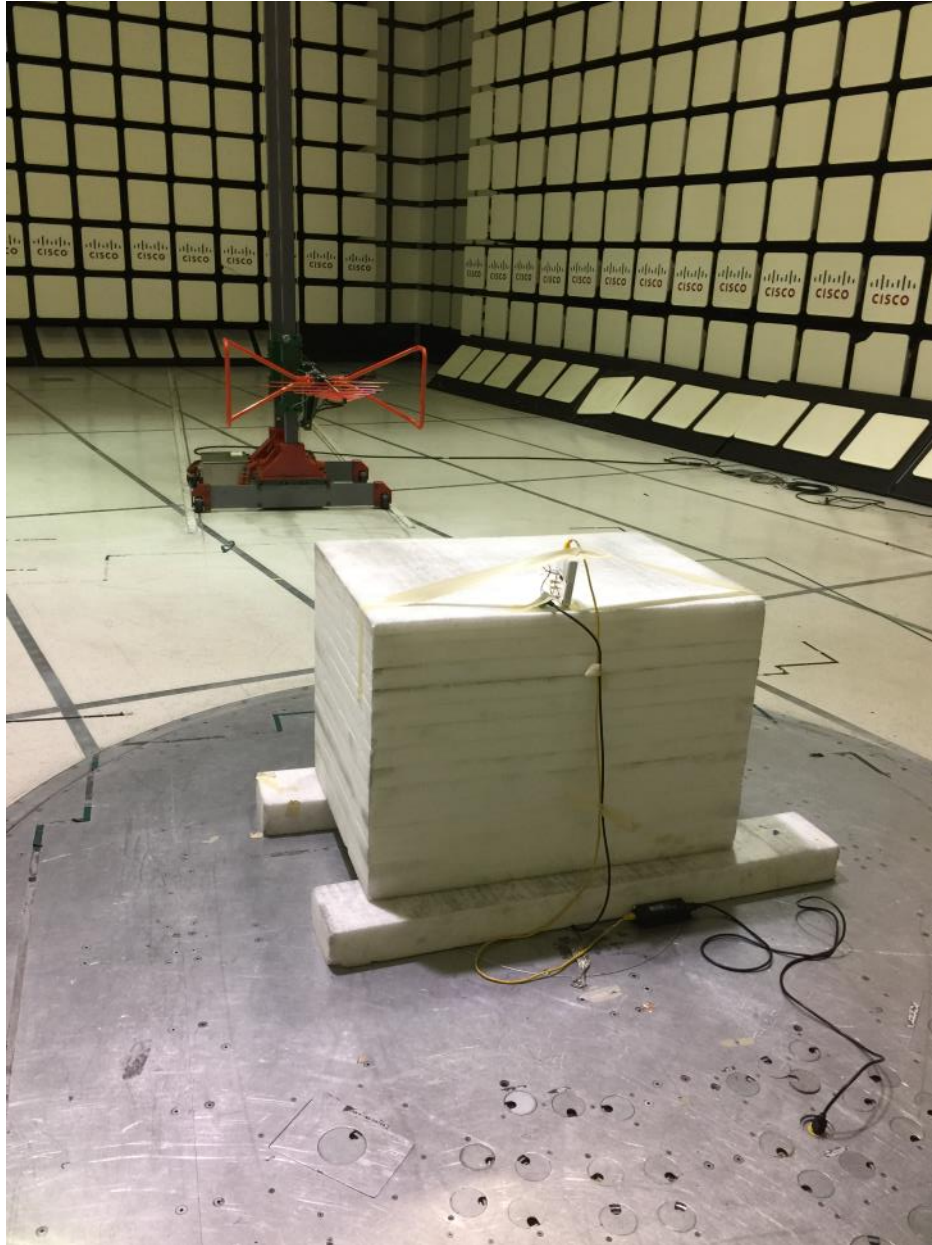

AIR-AP1800I-x-K9 Radiated Emissions setup above 1GHz

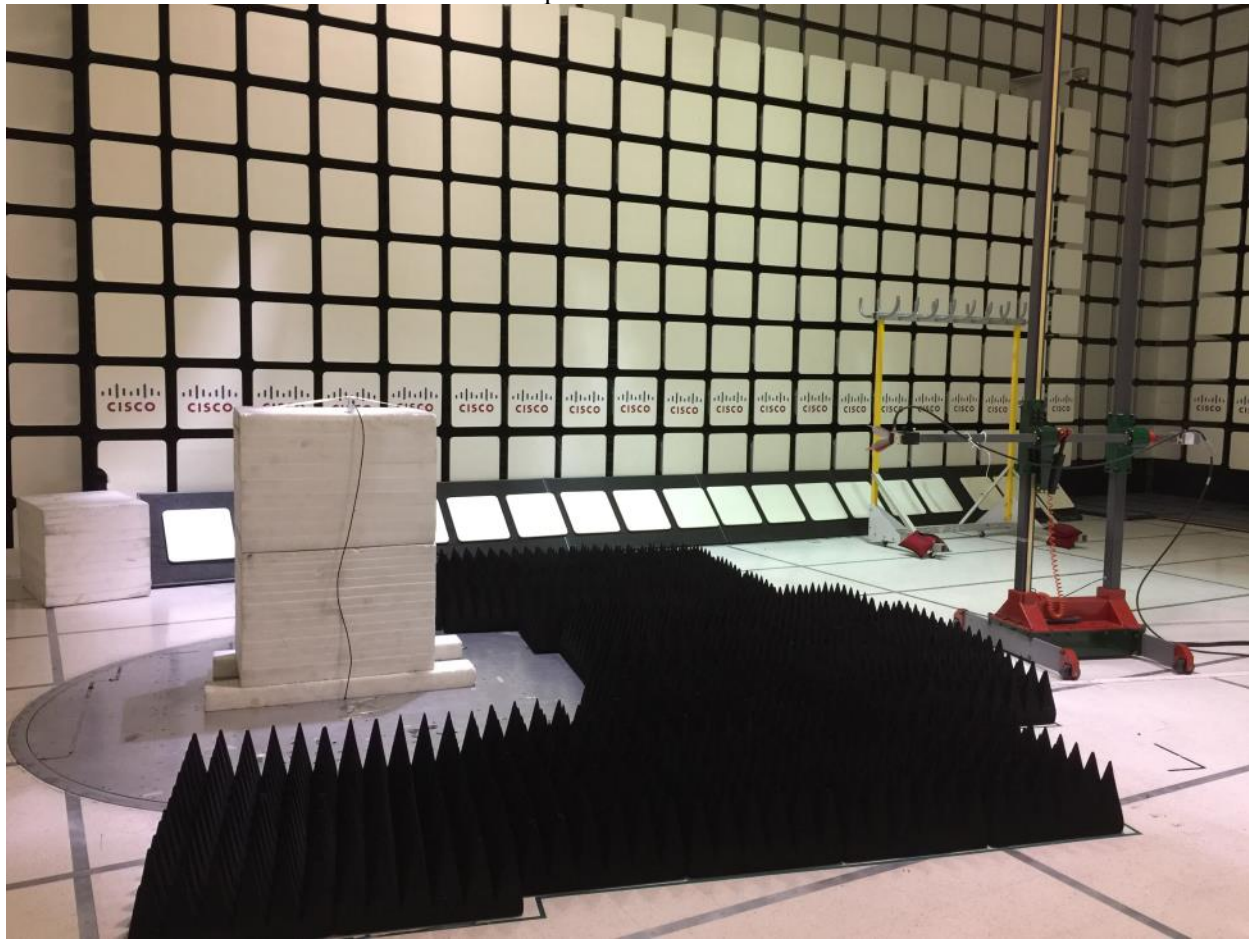

Appendix C: List of Test Equipment Used to perform the test

Test Equipment used for Radiated Emissions					
Equip No	Model Manufacturer	Description	Last Cal	Next Cal	Test Item
CIS041929	iBTHP-5-DB9 Newport	5 inch Temp/RH/Press Sensor w/20ft cable	22-Dec-16	22-Dec-17	B.1, B.2, B.3
CIS001937	NSA 5m Chamber Cisco	NSA 5m Chamber	12-Feb-16	12-Feb-17	B.3
CIS049535	Above 1GHz Site Cal Cisco	Above 1GHz CISPR Site Validation	13-Feb-16	13-Feb-17	B.1, B.2
CIS028072	1840 Cisco	18-40GHz EMI Test Head	22-Feb-16	22-Feb-17	B.1, B.2
CIS045588	JB1 Sunol Sciences	Combination Antenna, 30MHz-2GHz	9-Mar-16	9-Mar-17	B.3
CIS042000	E4440A Agilent	Spectrum Analyzer	6-Jul-16	6-Jul-17	B.1, B.2
CIS037581	3117 ETS-Lindgren	Horn Antenna	7-Oct-16	7-Oct-17	B.1, B.2
CIS045098	TH0118 Cisco	Mast Mount Preamplifier Array, 1-18GHz	31-Oct-16	31-Oct-17	B.1, B.2
CIS033602	CSY-NMNM-80-273001 Midwest Microwave	RF Coaxial Cable, to 18GHz	8-Nov-16	8-Nov-17	B.1, B.2, B.3
CIS030443	UFB311A-0-1560-520520 Micro-Coax	RF Coaxial Cable, to 18GHz	8-Nov-16	8-Nov-17	B.1, B.2, B.3
CIS008024	SF106A Huber + Suhner	3 meter Sucoflex cable	8-Nov-16	8-Nov-17	B.1, B.2, B.3
CIS024201	FSEK30 Rohde & Schwarz	Spectrum Analyzer 20Hz - 40GHz	23-Nov-16	23-Nov-17	B.1, B.2
CIS037235	50CB-015 JFW	GPIB Control Box	Cal not Required	Cal not Required	B.1, B.2
CIS035244	926-8ME Klein Tools	8 Meter Tape Measure	Cal not Required	Cal not Required	B.1, B.2, B.3
CIS043124	Above 1GHz Site Cal Cisco	Above 1GHz Cispr Site Verification	14-Jan-16	14-Jan-17	B.1, B.2
CIS043124	Above 1GHz Site Cal Cisco	Above 1GHz Cispr Site Verification	14-Jan-17	14-Jan-18	B.1, B.2
CIS047300	N9038A Agilent Technologies	MXE EMI Receiver 20Hz to 26.5 Ghz	28-Jan-16	28-Jan-17	B.1, B.2, B.3
CIS047299	N9030A Agilent Technologies	PXA Signal Analyzer, 3Hz to 44GHz	17-Oct-16	17-Oct-17	B.1, B.2, B.3
CIS030559	UFB311A-1-0950-504504 Micro-Coax	RF Coaxial Cable, to 18GHz, 95 in	15-Feb-16	15-Feb-17	B.1, B.2, B.3
CIS020975	UFB311A-0-1344-520520 Micro-Coax	RF Coaxial Cable, to 18GHz, 134.4 in	17-Feb-16	17-Feb-17	B.1, B.2, B.3
CIS019630	ESI 40(ESIB 40) Rohde & Schwarz	EMI Test Receiver, 20Hz - 40GHz	22-Feb-16	22-Feb-17	B.1, B.2
CIS008447	NSA 10m Chamber Cisco	NSA 10m Chamber	14-Oct-16	14-Oct-17	B.3
CIS036710	1840 Cisco	18-40GHz EMI Test Head/Verification Fixture	17-Nov-16	17-Nov-17	B.1, B.2
CIS030652	JB1 Sunol Sciences	Combination Antenna, 30MHz-2GHz	16-Dec-16	16-Dec-17	B.3



Test Equipment used for AC Mains Conducted Emissions					
Equip No	Model Manufacturer	Description	Last Cal	Next Cal	Test Item
CIS051642	Sucoflex 106PA Huber+Suhner	RF N Type Cable 8.5m	11-Feb-16	11-Feb-17	B.4
CIS030559	UFB311A-1-0950-504504 Micro-Coax	RF Coaxial Cable, to 18GHz, 95 in	15-Feb-16	15-Feb-17	B.4
CIS020975	UFB311A-0-1344-520520 Micro-Coax	RF Coaxial Cable, to 18GHz, 134.4 in	17-Feb-16	17-Feb-17	B.4
CIS046717	5-T-MB Bird	5W 50 Ohm BNC Termination 4GHz	9-Mar-16	9-Mar-17	B.4
CIS008510	FCC-450B-2.4-N Fischer Custom Communications	Instrumentation Limiter	16-May-16	16-May-17	B.4
CIS023796	FCC-LISN-PA-520R Fischer Custom Communications	POWER ADAPTOR, POLARIZED 120VAC	27-Jul-16	27-Jul-17	B.4
CIS023794	FCC-LISN-50/250-50-2-02 Fischer Custom Communications	LISN	27-Jul-16	27-Jul-17	B.4
CIS019206	H785-150K-50-21378 TTE	High Pas Filter, Fo=150kHz	13-Sep-16	13-Sep-17	B.4
CIS005687	73 III Fluke	Digital Multimeter	3-Nov-16	3-Nov-17	B.4
CIS041929	iBTHP-5-DB9 Newport	5 inch Temp/RH/Press Sensor w/20ft cable	22-Dec-16	22-Dec-17	B.4
CIS054645	33-428 Stanley	Tape measure 8 meter	Cal Not Required	Cal Not Required	B.4

Test Equipment used for RF Conducted Tests					
Equip No	Model Manufacturer	Description	Last Cal	Next Cal	Test Item
CIS049445	BRC50704-02 Micro-Tronics	Notch Filter, SB:5.470-5.725GHz, to 12GHz	12-Apr-16	12-Apr-17	A1 thru A6
CIS035038	BRC50703-02 Micro-Tronics	Notch Filter, SB:5.150-5.350GHz, to 11GHz	6-Jul-16	6-Jul-17	A1 thru A6
CIS055561	F120-S1S1-48 MegaPhase	SMA Cable 48"	15-Jul-16	15-Jul-17	A1 thru A6
CIS054635	F120-S1S1-48 Megaphase	SMA cable 48"	15-Jul-16	15-Jul-17	A1 thru A6
CIS055588	BWS30-W2 Aeroflex	SMA 30dB Attenuator	21-Jul-16	21-Jul-17	A1 thru A6
CIS055578	BWS20-W2 Aeroflex	SMA 20dB Attenuator	21-Jul-16	21-Jul-17	A1 thru A6
CIS054656	BRC50705-02 Micro-Tronics	Band Reject Filter	19-Sep-16	19-Sep-17	A1 thru A6
CIS054653	BRM50702-02 Micro-Tronics	Notch Filter, SB:2.400-2.500GHz, to 18GHz	19-Sep-16	19-Sep-17	A1 thru A6
CIS055858	SMSM-A2PH-012 Dynawave	12" SMA Cable	29-Sep-16	29-Sep-17	A1 thru A6
CIS055856	SMSM-A2PH-012 Dynawave	12" SMA Cable	29-Sep-16	29-Sep-17	A1 thru A6
CIS055849	SMSM-A2PH-012 Dynawave	12" SMA Cable	29-Sep-16	29-Sep-17	A1 thru A6
CIS055848	SMSM-A2PH-012 Dynawave	12" SMA Cable	29-Sep-16	29-Sep-17	A1 thru A6
CIS055847	SMSM-A2PH-012 Dynawave	12" SMA Cable	29-Sep-16	29-Sep-17	A1 thru A6
CIS055846	SMSM-A2PH-012 Dynawave	12" SMA Cable	29-Sep-16	29-Sep-17	A1 thru A6

CIS055845	SMSM-A2PH-012 Dynawave	12" SMA Cable	29-Sep-16	29-Sep-17	A1 thru A6
CIS055844	SMSM-A2PH-012 Dynawave	12" SMA Cable	29-Sep-16	29-Sep-17	A1 thru A6
CIS055843	SMSM-A2PH-012 Dynawave	12" SMA Cable	29-Sep-16	29-Sep-17	A1 thru A6
CIS055842	SMSM-A2PH-012 Dynawave	12" SMA cable	29-Sep-16	29-Sep-17	A1 thru A6
CIS055874	SMSM-A2PH-024 Dynawave	24" SMA Cable	7-Oct-16	7-Oct-17	A1 thru A6
CIS055872	SMSM-A2PH-024 Dynawave	24" SMA Cable	7-Oct-16	7-Oct-17	A1 thru A6
CIS055868	SMSM-A2PH-024 Dynawave	24" SMA Cable	7-Oct-16	7-Oct-17	A1 thru A6
CIS055867	SMSM-A2PH-024 Dynawave	24" SMA Cable	7-Oct-16	7-Oct-17	A1 thru A6
CIS055885	SMSM-A2PH-018 Dynawave	18" SMA Cable	10-Oct-16	10-Oct-17	A1 thru A6
CIS055170	RFLT4WDC40GK RF Lambda	4 Way Power Divider 40GHz	29-Nov-16	29-Nov-17	A1 thru A6
CIS050721	N9030A Keysight	PXA Signal Analyzer	30-Mar-16	30-Mar-17	A1 thru A6
CIS054303	N5182B Keysight	MXG X-Series RF Vector Signal Generator	6-Apr-16	6-Apr-17	A1 thru A6
CIS055099	SMART2200RM2U Tripp-Lite	Power Supply	Cal Not Required	Cal Not Required	A1 thru A6
CIS055094	PXI-1042 National Instruments	Chassis	Cal Not Required	Cal Not Required	A1 thru A6

Appendix E: Abbreviation Key and Definitions

The following table defines abbreviations used within this test report.

Abbreviation	Description	Abbreviation	Description
EMC	Electro Magnetic Compatibility	°F	Degrees Fahrenheit
EMI	Electro Magnetic Interference	°C	Degrees Celsius
EUT	Equipment Under Test	Temp	Temperature
ITE	Information Technology Equipment	S/N	Serial Number
TAP	Test Assessment Schedule	Qty	Quantity
ESD	Electro Static Discharge	emf	Electromotive force
EFT	Electric Fast Transient	RMS	Root mean square
EDCS	Engineering Document Control System	Qp	Quasi Peak
Config	Configuration	Av	Average
CIS#	Cisco Number (unique identification number for Cisco test equipment)	Pk	Peak
Cal	Calibration	kHz	Kilohertz (1×10^3)
EN	European Norm	MHz	MegaHertz (1×10^6)
IEC	International Electro technical Commission	GHz	Gigahertz (1×10^9)
CISPR	International Special Committee on Radio Interference	H	Horizontal
CDN	Coupling/Decoupling Network	V	Vertical
LISN	Line Impedance Stabilization Network	dB	decibel
PE	Protective Earth	V	Volt
GND	Ground	kV	Kilovolt (1×10^3)
L1	Line 1	μ V	Microvolt (1×10^{-6})
L2	Line2	A	Amp
L3	Line 3	μ A	Micro Amp (1×10^{-6})
DC	Direct Current	mS	Milli Second (1×10^{-3})
RAW	Uncorrected measurement value, as indicated by the measuring device	μ S	Micro Second (1×10^{-6})
RF	Radio Frequency	μ S	Micro Second (1×10^{-6})
SLCE	Signal Line Conducted Emissions	m	Meter
Meas dist	Measurement distance	Spec dist	Specification distance
N/A or NA	Not Applicable	SL	Signal Line (or Telecom Line)
P	Power Line	L	Live Line
N	Neutral Line	R	Return
S	Supply	AC	Alternating Current

End