

Test Report
AIR-AP1815M-x-K9

FCC ID: LDK102110
AIR-AP1815M-B-K9

IC: 2461B-102110
AIR-AP1815M-A-K9
(x=A,B,K,S)

Cisco Aironet 802.11ac Dual Band Access Points

5725-5850 MHz

Against the following Specifications:

CFR47 Part 15.407

RSS-247

LP0002



Cisco Systems

170 West Tasman Drive

San Jose, CA 95134

	
Author: Jose Aguirre Tested By: Jose Aguirre	Approved By: Jim Nicholson Title: Technical Leader, Engineering Revision: 2

This report replaces any previously entered test report under EDCS 11591572..This test report has been electronically authorized and archived using the CISCO Engineering Document Control system.

This test report has been electronically authorized and archived using the CISCO Engineering Document Control system.

SECTION 1: OVERVIEW	3
SECTION 2: ASSESSMENT INFORMATION	4
2.1 GENERAL	4
2.2 DATE OF TESTING.....	6
2.3 REPORT ISSUE DATE	6
2.4 TESTING FACILITIES	6
2.5 EQUIPMENT ASSESSED (EUT).....	6
2.6 EUT DESCRIPTION.....	7
SECTION 3: RESULT SUMMARY	8
3.1 RESULTS SUMMARY TABLE	8
SECTION 4: SAMPLE DETAILS.....	10
4.1 SAMPLE DETAILS	10
4.2 SYSTEM DETAILS	10
4.3 MODE OF OPERATION DETAILS.....	10
APPENDIX A: EMISSION TEST RESULTS	11
CONDUCTED TEST SETUP DIAGRAM.....	11
TARGET MAXIMUM CHANNEL POWER	11
A.1 6DB BANDWIDTH.....	12
A.2 99% AND 26DB BANDWIDTH.....	15
A.3 MAXIMUM CONDUCTED OUTPUT POWER	18
A.4 POWER SPECTRAL DENSITY	22
A.5 CONDUCTED SPURIOUS EMISSIONS.....	26
A.6 CONDUCTED BANDEDGE.....	35
APPENDIX B: EMISSION TEST RESULTS	38
RADIATED EMISSION SETUP DIAGRAM-BELOW 1G	38
B.1 RADIATED SPURIOUS EMISSIONS	39
B.2 RECEIVER SPURIOUS EMISSIONS	48
B.3 RADIATED EMISSIONS 30MHZ TO 1GHZ	53
B.4 AC CONDUCTED EMISSIONS	55
APPENDIX C: LIST OF TEST EQUIPMENT USED TO PERFORM THE TEST	61
APPENDIX E: ABBREVIATION KEY AND DEFINITIONS.....	64



Section 1: Overview

The samples were assessed against the tests detailed in section 3 under the requirements of the following specifications:

Specifications:
CFR47 Part 15.407 RSS-247 Issue 2: February 2017

Measurements were made in accordance with

- ANSI C63.10:2013
- KDB 789033 D02 General UNII Test Procedures New Rules v01r03
- KDB 662911 D01 Multiple Transmitter Output v02r01

Section 2: Assessment Information

2.1 General

This report contains an assessment of an apparatus against Electromagnetic Compatibility Standards based upon tests carried out on the samples submitted. The testing was performed by and for the use of Cisco systems Inc:

With regard to this assessment, the following points should be noted:

- a) The results contained in this report relate only to the items tested and were obtained in the period between the date of the initial assessment and the date of issue of the report. Manufactured products will not necessarily give identical results due to production and measurement tolerances.
- b) The apparatus was set up and exercised using the configuration and modes of operation defined in this report only.
- c) Where relevant, the apparatus was only assessed using the susceptibility criteria defined in this report and the Test Assessment Plan (TAP).
- d) All testing was performed under the following environmental conditions:

Temperature	15°C to 35°C (54°F to 95°F)
Atmospheric Pressure	860mbar to 1060mbar (25.4" to 31.3")
Humidity	10% to 75*%
- e) All AC testing was performed at one or more of the following supply voltages:
110V 60 Hz (+/-20%)

Units of Measurement

The units of measurements defined in the appendices are reported in specific terms, which are test dependent. Where radiated measurements are concerned these are defined at a particular distance. Basic voltage measurements are defined in units of [dBuV]

As an example, the basic calculation for all measurements is as follows:

$$\text{Emission level [dBuV]} = \text{Indicated voltage level [dBuV]} + \text{Cable Loss [dB]} + \text{Other correction factors [dB]}$$

The combinations of correction factors are dependent upon the exact test configurations [see test equipment lists for further details] and may include:-

Antenna Factors, Pre Amplifier Gain, LISN Loss, Pulse Limiter Loss and Filter Insertion Loss

Note: to convert the results from dBuV/m to uV/m use the following formula:-

$$\text{Level in uV/m} = \text{Common Antilogarithm} [(X \text{ dBuV/m})/20] = Y \text{ uV/m}$$

Measurement Uncertainty Values

voltage and power measurements	± 2 dB
conducted EIRP measurements	± 1.4 dB
radiated measurements	± 3.2 dB
frequency measurements	± 2.4 10 ⁻⁷
temperature measurements	± 0.54°
humidity measurements	± 2.3%
DC and low frequency measurements	± 2.5%

Where relevant measurement uncertainty levels have been estimated for tests performed on the apparatus. This uncertainty represents an expanded uncertainty expressed at approximately the 95% confidence level using a coverage factor of k=2.

Radiated emissions (expanded uncertainty, confidence interval 95%)

30 MHz - 300 MHz	+/- 3.8 dB
300 MHz - 1000 MHz	+/- 4.3 dB
1 GHz - 10 GHz	+/- 4.0 dB
10 GHz - 18GHz	+/- 8.2 dB
18GHz - 26.5GHz	+/- 4.1 dB
26.5GHz - 40GHz	+/- 3.9 dB

Conducted emissions (expanded uncertainty, confidence interval 95%)

30 MHz – 40GHz	+/- 0.38 dB
----------------	-------------

A product is considered to comply with a requirement if the nominal measured value is below the limit line. The product is considered to not be in compliance in case the nominal measured value is above the limit line.

This report must not be reproduced except in full, without written approval of Cisco Systems.

2.2 Date of testing

16-Dec-16 - 06-Feb-17

2.3 Report Issue Date

06-Feb-17

Cisco uses an electronic system to issue, store and control the revision of test reports. This system is called the Engineering Document Control System (EDCS). The actual report issue date is embedded into the original file on EDCS. Any copies of this report, either electronic or paper, that are not on EDCS must be considered uncontrolled.

2.4 Testing facilities

This assessment was performed by:

Testing Laboratory

Cisco Systems, Inc.,
125 West Tasman Drive
San Jose, CA 95134, USA

Registration Numbers for Industry Canada

Cisco System Site	Address	Site Identifier
Building P, 10m Chamber	125 West Tasman Dr San Jose, CA 95134	Company #: 2461N-2
Building P, 5m Chamber	125 West Tasman Dr San Jose, CA 95134	Company #: 2461N-1
Building I, 5m Chamber	285 W. Tasman Drive San Jose, California 95134	Company #: 2461M-1

Test Engineers

Jose Aguirre

2.5 Equipment Assessed (EUT)

AIR-AP1815M-B-K9

2.6 EUT Description

The Cisco Aironet 802.11ac Radio supports the following modes of operation. The modes are further defined in the radio Theory of Operation. The modes included in this report represent the worst case data for all modes.

- 802.11a - Non HT20, One Antenna, 6 to 54 Mbps, 1ss
- 802.11a - Non HT20, Two Antennas, 6 to 54 Mbps, 1ss

- 802.11a - Non HT20 Beam Forming, Two Antennas, 6 to 54 Mbps, 1ss

- 802.11n/ac - HT/VHT20, One Antenna, M0 to M7, 1ss
- 802.11n/ac - HT/VHT20, Two Antennas, M0 to M7, 1ss
- 802.11n/ac - HT/VHT20, Two Antennas, M8 to M15, 2ss

- 802.11n/ac - HT/VHT20 Beam Forming, Two Antennas, M0 to M7, 1ss
- 802.11n/ac - HT/VHT20 Beam Forming, Two Antennas, M8 to M15, 2ss

- 802.11n/ac - HT/VHT20 STBC, Two Antennas, M0 to M7, 2ss

- 802.11a - Non HT40, One Antenna, 6 to 54 Mbps, 1ss
- 802.11a - Non HT40, Two Antennas, 6 to 54 Mbps, 1ss

- 802.11n/ac - HT/VHT40, One Antenna, M0 to M7, 1ss
- 802.11n/ac - HT/VHT40, Two Antennas, M0 to M7, 1ss
- 802.11n/ac - HT/VHT40, Two Antennas, M8 to M15, 2ss

- 802.11n/ac - HT/VHT40 Beam Forming, Two Antennas, M0 to M7, 1ss
- 802.11n/ac - HT/VHT40 Beam Forming, Two Antennas, M8 to M15, 2ss

- 802.11n/ac - HT/VHT40 STBC, Two Antennas, M0 to M7, 2ss

- 802.11a - Non HT80, One Antenna, 6 to 54 Mbps, 1ss
- 802.11a - Non HT80, Two Antennas, 6 to 54 Mbps, 1ss

- 802.11n/ac - HT/VHT80, One Antenna, M0 to M9 1ss
- 802.11n/ac - HT/VHT80, Two Antennas, M0 to M9 1ss
- 802.11n/ac - HT/VHT80, Two Antennas, M0 to M9 2ss

- 802.11n/ac - HT/VHT80 Beam Forming, Two Antennas, M0 to M9 1ss
- 802.11n/ac - HT/VHT80 Beam Forming, Two Antennas, M0 to M9 2ss

- 802.11n/ac - HT/VHT80 STBC, Two Antennas, M0 to M9 2ss

The following antennas are supported by this product series.
The data included in this report represent the worst case data for all antennas.

Frequency	Part Number	Antenna Type	Antenna Gain (dBi)	>30 degree 5 GHz Antenna Gain (dBi)
2.4/5 GHz	Internal	BT/BLE	2 / NA	NA
	Internal	HP Omni	2 / 4	NA

Section 3: Result Summary

3.1 Results Summary Table

Conducted emissions

Basic Standard	Technical Requirements / Details	Result
FCC 15.407 RSS-247 LP0002: 3.10.1(6.2.1)	6dB Bandwidth: Systems using digital modulation techniques may operate in the 5725-5850 MHz band. The minimum 6dB bandwidth shall be at least 500 kHz.	Pass
FCC 15.407 RSS-GEN	99% & 26 dB Bandwidth: The 99% occupied bandwidth is the frequency bandwidth such that, below its lower and above its upper frequency limits, the mean powers are each equal to 0.5% of the total mean power of the given emission. There is no limit for 99% OBW. The 26 dB emission is the width of the emission that is constrained by the frequencies associated with the two outermost amplitude points (upper and lower frequencies) that are attenuated by 26 dB relative to the maximum level measured in the fundamental emission.	Pass
FCC 15.407 RSS-247 / LP0002: 3.10.1(2.3)	Output Power: For the band 5.725-5.85 GHz, the maximum conducted output power over the frequency band of operation shall not exceed 1 W.	Pass
FCC 15.407 RSS-247 LP0002: 3.10.1(6.2.1)	Power Spectral Density: 15.407 The maximum power spectral density shall not exceed 30 dBm in any 500-kHz band.	Pass
FCC 15.209 FCC 152.05 RSS-GEN	Conducted Spurious Emissions / Restricted band: Unwanted emissions falling within the restricted bands, as defined in FCC 15.205 (a) must also comply with the radiated emission limits specified in FCC 15.209 (a).	Pass
FCC 15.247 RSS-247 LP0002: 3.10.1(5)	Conducted Spurious Emissions / Band-Edge: In any 100 kHz bandwidth outside the frequency band in which the digitally modulated intentional radiator is operating, the radio frequency power that is produced by the intentional radiator shall be at least 30 dB below that in the 100 kHz bandwidth within the band that contains the highest level of the desired power. Devices certified before March 2, 2018 with antenna gain of 10 dBi or less may demonstrate compliance with the emission limits in §15.247(d), but manufacturing, marketing and importing of devices certified under this alternative must cease before March 2, 2020.	Pass

Radiated Emissions (General requirements)

Basic Standard	Technical Requirements / Details	Result
FCC 15.209 FCC 15.205 RSS-GEN LP0002: 3.10.1(5)& 2.7 & 2.8	TX Spurious Emissions: Except as provided elsewhere in this subpart, the emissions from an intentional radiator shall not exceed the field strength levels specified in the filed strength limits table in this section.	Pass
FCC 15.207 RSS-GEN LP0002: 2.3	AC conducted Emissions: Except when the requirements applicable to a given device state otherwise, for any radio apparatus equipped to operate from the public utility AC power supply, either directly or indirectly (such as with a battery charger), the radio frequency voltage of emissions conducted back onto the AC power lines in the frequency range of 0.15 MHz to 30 MHz shall not exceed the limits shown in the table in these sections. The more stringent limit applies at the frequency range boundaries.	Pass

* MPE calculation is recorded in a separate report

Section 4: Sample Details

Note: Each sample was evaluated to ensure that its condition was suitable to be used as a test sample prior to the commencement of testing.

4.1 Sample Details

Sample No.	Equipment Details	Manufacturer	Hardware Rev.	Firmware Rev.	Software Rev.	Serial Number
S01	AIR-AP1815M-B-K9	Cisco Systems	P2	28bb3ae8 d7576e23 8bd6a752 bdc8dc74	8.3.15.124	FOC20377ZFK
S02*	AIR-PWRINJ6	Cisco Systems	V01	NA	NA	C15456663000 0247

(*) S02 is support equipment Power supply for EUT S01

4.2 System Details

System #	Description	Samples
1	AIR-AP1815M-B-K9	S01
2	AIR-PWRINJ6	S02

4.3 Mode of Operation Details

Mode#	Description	Comments
1	Continuous Transmitting	Continuous Transmitting ≥98% duty cycle

All measurements were made in accordance with

- ANSI C63.10:2013
- KDB 789033 D02 General UNII Test Procedures New Rules v01r03
- KDB 662911 D01 Multiple Transmitter Output v02r01

Appendix A: Emission Test Results

Conducted Test Setup Diagram

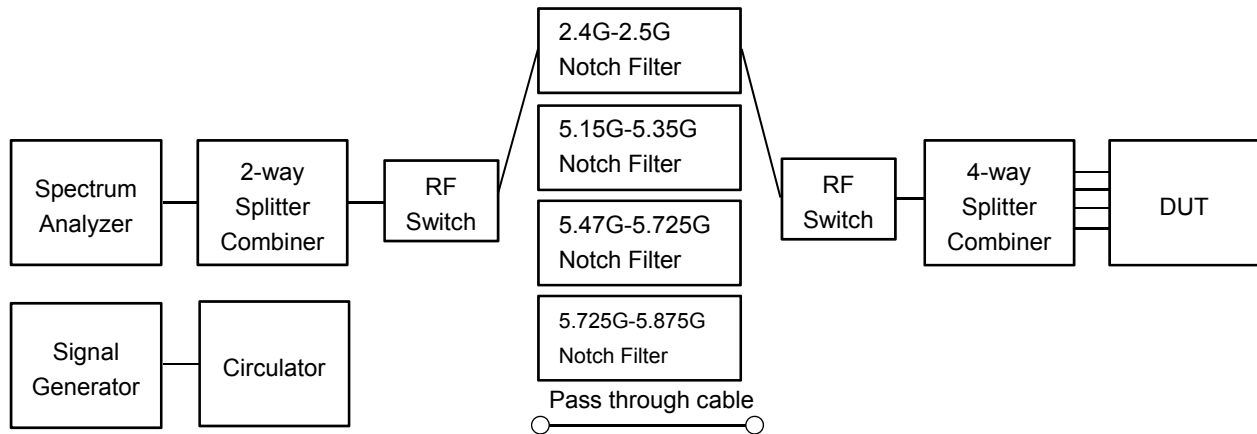

Target Maximum Channel Power

The following table details the maximum supported Total Channel Power for all operating modes.

Operating Mode	Maximum Channel Power (dBm)		
	Frequency (MHz)		
	5745	5785	5825
Non HT20, 6 to 54 Mbps	22	22	23
Non HT20 Beam Forming, 6 to 54 Mbps	22	22	23
HT/VHT20, M0 to M15	22	23	23
HT/VHT20 Beam Forming, M0 to M15	22	23	23
HT/VHT20 STBC, M0 to M7	22	23	23
	5755	5795	
Non HT40, 6 to 54 Mbps	20	22	
HT/VHT40, M0 to M15	22	23	
HT/VHT40 Beam Forming, M0 to M15	22	23	
HT/VHT40 STBC, M0 to M7	22	23	
	5775		
Non HT80, 6 to 54 Mbps	21		
HT/VHT80, M0 to M9, M0 to M9 1-1ss	21		
HT/VHT80 Beam Forming, M0 to M9, M0 to M9 1-1ss	21		
HT/VHT80 STBC, M0 to M9 2ss	21		

A.1 6dB Bandwidth

15.407 / RSS-247/ LP0002:3.10.1(6.2.1) Within the 5.725-5.85 GHz band, the minimum 6 dB bandwidth of U-NII devices shall be at least 500 kHz.

Test Procedure

Ref. KDB 789033 D02 General UNII Test Procedures New Rules v01r03
ANSI C63.10: 2013

6 BW

Test Procedure

1. Set the radio in the continuous transmitting mode.
2. Allow the trace to stabilize.
3. Setting the x-dB bandwidth mode to -6dB within the measurement set up function.
4. Select the automatic OBW measurement function of an instrument to perform bandwidth measurement.
5. Capture graphs and record pertinent measurement data.

Ref. KDB 789033 D02 General UNII Test Procedures New Rules v01r03
ANSI C63.10: 2013 section 11.8.2 Option 2

6 BW

Test parameters

X dB BW = 6dB (using the OBW function of the spectrum analyzer)
Span = Large enough to capture the entire EBW
RBW = 100 KHz
VBW \geq 3 x RBW
Sweep = Auto couple
Detector = Peak or where practical sample shall be used
Trace = Max. Hold

System Number	Description	Samples	System under test	Support equipment
1	EUT	S01	<input checked="" type="checkbox"/>	<input type="checkbox"/>
	Support	S02	<input type="checkbox"/>	<input checked="" type="checkbox"/>

Tested By :

Jose Aguirre

Date of testing:

16-Dec-16 - 06-Feb-17

Test Result : **PASS**

See Appendix C for list of test equipment

Frequency (MHz)	Mode	Data Rate (Mbps)	6dB BW (MHz)	Limit (kHz)	Margin (MHz)
5745	Non HT20, 6 to 54 Mbps	6	16.4	>500	15.9
	HT/VHT20, M0 to M15	m0	17.6	>500	17.1
5755	Non HT40, 6 to 54 Mbps	6	36.3	>500	35.8
	HT/VHT40, M0 to M15	m0	36.3	>500	35.8
5775	Non HT80, 6 to 54 Mbps	6	76.4	>500	75.9
	HT/VHT80, M0 to M9, M0 to M9 1-1ss	m0x1	76.4	>500	75.9
5785	Non HT20, 6 to 54 Mbps	6	16.4	>500	15.9
	HT/VHT20, M0 to M15	m0	17.6	>500	17.1
5795	Non HT40, 6 to 54 Mbps	6	35.7	>500	35.2
	HT/VHT40, M0 to M15	m0	36.3	>500	35.8
5825	Non HT20, 6 to 54 Mbps	6	16.4	>500	15.9
	HT/VHT20, M0 to M15	m0	17.6	>500	17.1



6dB Bandwidth, 5745 MHz, Non HT20, 6 to 54 Mbps

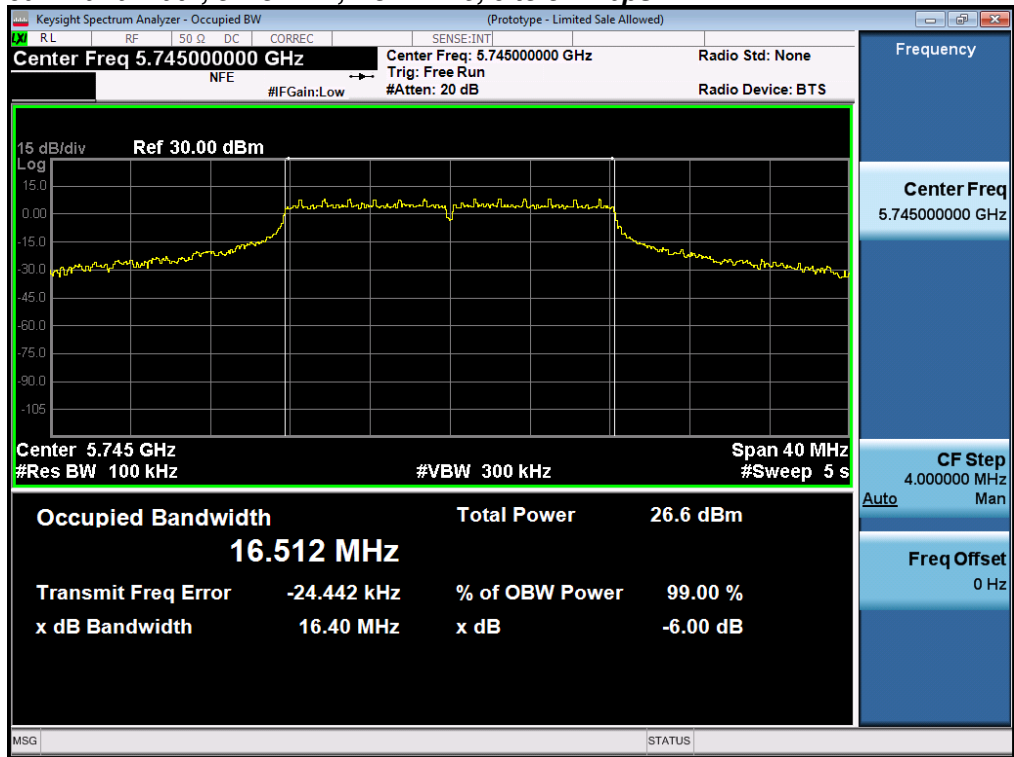



A.2 99% and 26dB Bandwidth

FCC 15.407 / RSS-GEN The 99% occupied bandwidth is the frequency bandwidth such that, below its lower and above its upper frequency limits, the mean powers are each equal to 0.5% of the total mean power of the given emission. There is no limit for 99% OBW.

The 26 dB emission is the width of the emission that is constrained by the frequencies associated with the two outermost amplitude points (upper and lower frequencies) that are attenuated by 26 dB relative to the maximum level measured in the fundamental emission.

Test Procedure

Ref. ANSI C63.10: 2013 Section 6.9.3

99% BW and EBW (-26dB)
Test Procedure
<ol style="list-style-type: none"> 1. Set the radio in the continuous transmitting mode. 2. Allow the trace to stabilize. 3. Setting the x-dB bandwidth mode to -26dB and OBW power function to 99% within the measurement set up function. 4. Select the automatic OBW measurement function of an instrument to perform bandwidth measurement. 5. Capture graphs and record pertinent measurement data.

Ref. ANSI C63.10: 2013 Section 6.9.3

99% BW and EBW (-26dB)
Test parameters
Span = 1.5 x to 5.0 times OBW RBW = approx. 1% to 5% of the OBW VBW ≥ 3 x RBW Detector = Peak or where practical sample shall be used Trace = Max. Hold

System Number	Description	Samples	System under test	Support equipment
1	EUT	S01	<input checked="" type="checkbox"/>	<input type="checkbox"/>
	Support	S02	<input type="checkbox"/>	<input checked="" type="checkbox"/>

Tested By : Jose Aguirre	Date of testing: 16-Dec-16 - 06-Feb-17
Test Result : PASS	

See Appendix C for list of test equipment

Frequency (MHz)	Mode	Data Rate (Mbps)	26dB BW (MHz)	99% BW (MHz)
5745	Non HT20, 6 to 54 Mbps	6	28.3	18.618
	HT/VHT20, M0 to M15	m0	32.1	19.809
5755	Non HT40, 6 to 54 Mbps	6	72.7	37.979
	HT/VHT40, M0 to M15	m0	64.6	37.716
5775	Non HT80, 6 to 54 Mbps	6	106.3	76.682
	HT/VHT80, M0 to M9, M0 to M9 1-1ss	m0x1	98.1	76.899
5785	Non HT20, 6 to 54 Mbps	6	33.4	18.960
	HT/VHT20, M0 to M15	m0	36.2	20.163
5795	Non HT40, 6 to 54 Mbps	6	76.9	43.756
	HT/VHT40, M0 to M15	m0	72.6	37.954
5825	Non HT20, 6 to 54 Mbps	6	33.8	18.942
	HT/VHT20, M0 to M15	m0	36.9	20.264



26dB / 99% Bandwidth, 5745 MHz, Non HT20, 6 to 54 Mbps

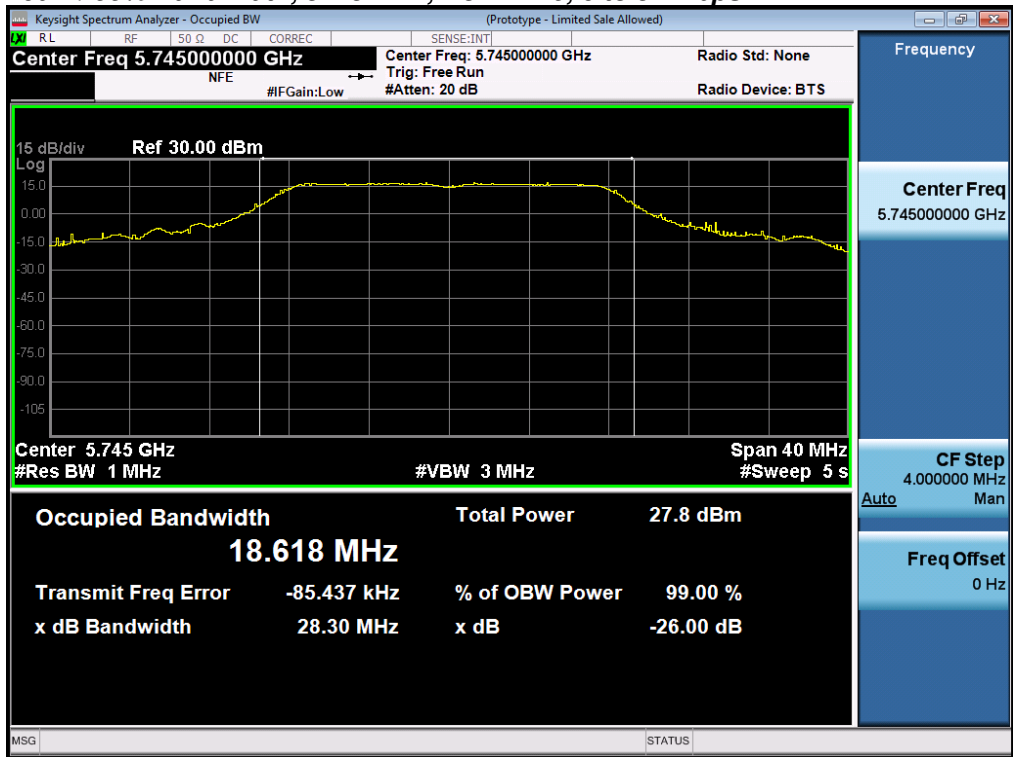

A.3 Maximum Conducted Output Power

15.407 / RSS-247/ LP0002:3.10.1(2.3) For the band 5.725-5.85 GHz, the maximum conducted output power over the frequency band of operation shall not exceed 1 W. If transmitting antennas of directional gain greater than 6 dBi are used, both the maximum conducted output power and the maximum power spectral density shall be reduced by the amount in dB that the directional gain of the antenna exceeds 6 dBi. However, fixed point-to-point U-NII devices operating in this band may employ transmitting antennas with directional gain greater than 6 dBi without any corresponding reduction in transmitter conducted power. Fixed, point-to-point operations exclude the use of point-to-multipoint systems, omnidirectional applications, and multiple collocated transmitters transmitting the same information. The operator of the U-NII device, or if the equipment is professionally installed, the installer, is responsible for ensuring that systems employing high gain directional antennas are used exclusively for fixed, point-to-point operations.

The peak correlated gain for each mode is listed in the table below. See the Theory of Operation for details on the correlated gain for each mode.

Test Procedure

Ref. KDB 789033 D02 General UNII Test Procedures New Rules v01r03
ANSI C63.10: 2013

Output Power Test Procedure
<ol style="list-style-type: none"> 1. Set the radio in the continuous transmitting mode at full power 2. Compute power by integrating the spectrum across the EBW (or alternatively entire 99% OBW) of the signal using the instrument's band power measurement function. The integration shall be performed using the spectrum analyzer band-power measurement function with band limits set equal to the EBW or the OBW band edges. 3. Capture graphs and record pertinent measurement data.

Ref. KDB 789033 D02 General UNII Test Procedures New Rules v01r03
ANSI C63.10: 2013 section 12.3.2.2 Method SA-1

Output Power Test parameters
Span = >1.5 times the OBW RBW = 1MHz VBW ≥ 3 x RBW Sweep = Auto couple Detector = sample Trace = Trace Average 100

The “measure-and-sum technique” is used for measuring in-band transmit power of a device. In the measure-and-sum approach, the conducted emission level is measured at each antenna port. The measured results at the various antenna ports are then summed mathematically to determine the total emission level from the device. Summing is performed in linear power units. (See ANSI C63.10 section 14.3.2.2)

System Number	Description	Samples	System under test	Support equipment
1	EUT	S01	<input checked="" type="checkbox"/>	<input type="checkbox"/>
	Support	S02	<input type="checkbox"/>	<input checked="" type="checkbox"/>

Tested By : Jose Aguirre	Date of testing: 16-Dec-16 - 06-Feb-17
Test Result : PASS	

See Appendix C for list of test equipment

Frequency (MHz)	Mode	Tx Paths	Correlated Antenna Gain (dBi)	Tx 1 Max Power (dBm)	Tx 2 Max Power (dBm)	Total Tx Channel Power (dBm)	Limit (dBm)	Margin (dB)
5745	Non HT20, 6 to 54 Mbps	1	4	19.7		19.7	30.0	10.3
	Non HT20, 6 to 54 Mbps	2	4	19.7	19.2	22.5	30.0	7.5
	Non HT20 Beam Forming, 6 to 54 Mbps	2	7	19.7	19.2	22.5	29.0	6.5
	HT/VHT20, M0 to M7	1	4	19.7		19.7	30.0	10.3
	HT/VHT20, M0 to M7	2	4	19.7	19.2	22.5	30.0	7.5
	HT/VHT20, M8 to M15	2	4	19.7	19.2	22.5	30.0	7.5
	HT/VHT20 Beam Forming, M0 to M7	2	7	19.7	19.2	22.5	29.0	6.5
	HT/VHT20 Beam Forming, M8 to M15	2	4	19.7	19.2	22.5	30.0	7.5
	HT/VHT20 STBC, M0 to M7	2	4	19.7	19.2	22.5	30.0	7.5
5755	Non HT40, 6 to 54 Mbps	1	4	17.6		17.6	30.0	12.4
	Non HT40, 6 to 54 Mbps	2	4	17.6	17.3	20.5	30.0	9.5
	HT/VHT40, M0 to M7	1	4	19.5		19.5	30.0	10.5
	HT/VHT40, M0 to M7	2	4	19.5	19.3	22.4	30.0	7.6
	HT/VHT40, M8 to M15	2	4	19.5	19.3	22.4	30.0	7.6
	HT/VHT40 Beam Forming, M0 to M7	2	7	19.5	19.3	22.4	29.0	6.6
	HT/VHT40 Beam Forming, M8 to M15	2	4	19.5	19.3	22.4	30.0	7.6
	HT/VHT40 STBC, M0 to M7	2	4	19.5	19.3	22.4	30.0	7.6
	5775	Non HT80, 6 to 54 Mbps	1	4	17.5		17.5	30.0
Non HT80, 6 to 54 Mbps		2	4	17.5	17.6	20.6	30.0	9.4
HT/VHT80, M0 to M9 1ss		1	4	17.9		17.9	30.0	12.1
HT/VHT80, M0 to M9 1ss		2	4	17.9	18.0	21.0	30.0	9.0
HT/VHT80, M0 to M9 2ss		2	4	17.9	18.0	21.0	30.0	9.0
HT/VHT80 Beam Forming, M0 to M9 1ss		2	7	17.9	18.0	21.0	29.0	8.0
HT/VHT80 Beam Forming, M0 to M9 2ss		2	4	17.9	18.0	21.0	30.0	9.0
HT/VHT80 STBC, M0 to M9 2ss		2	4	17.9	18.0	21.0	30.0	9.0
5785		Non HT20, 6 to 54 Mbps	1	4	19.2		19.2	30.0
	Non HT20, 6 to 54 Mbps	2	4	19.2	19.6	22.4	30.0	7.6
	Non HT20 Beam Forming, 6 to 54 Mbps	2	7	19.2	19.6	22.4	29.0	6.6
	HT/VHT20, M0 to M7	1	4	19.4		19.4	30.0	10.6
	HT/VHT20, M0 to M7	2	4	19.4	19.7	22.6	30.0	7.4
	HT/VHT20, M8 to M15	2	4	19.4	19.7	22.6	30.0	7.4
	HT/VHT20 Beam Forming, M0 to M7	2	7	19.4	19.7	22.6	29.0	6.4
	HT/VHT20 Beam Forming, M8 to M15	2	4	19.4	19.7	22.6	30.0	7.4



	HT/VHT20 STBC, M0 to M7	2	4	19.4	19.7	22.6	30.0	7.4
5795	Non HT40, 6 to 54 Mbps	1	4	19.2		19.2	30.0	10.8
	Non HT40, 6 to 54 Mbps	2	4	19.2	19.6	22.4	30.0	7.6
	HT/VHT40, M0 to M7	1	4	19.6		19.6	30.0	10.4
	HT/VHT40, M0 to M7	2	4	19.6	20.1	22.9	30.0	7.1
	HT/VHT40, M8 to M15	2	4	19.6	20.1	22.9	30.0	7.1
	HT/VHT40 Beam Forming, M0 to M7	2	7	19.6	20.1	22.9	29.0	6.1
	HT/VHT40 Beam Forming, M8 to M15	2	4	19.6	20.1	22.9	30.0	7.1
	HT/VHT40 STBC, M0 to M7	2	4	19.6	20.1	22.9	30.0	7.1
5825	Non HT20, 6 to 54 Mbps	1	4	19.8		19.8	30.0	10.2
	Non HT20, 6 to 54 Mbps	2	4	19.8	19.7	22.8	30.0	7.2
	Non HT20 Beam Forming, 6 to 54 Mbps	2	7	19.8	19.7	22.8	29.0	6.2
	HT/VHT20, M0 to M7	1	4	19.8		19.8	30.0	10.2
	HT/VHT20, M0 to M7	2	4	19.8	19.8	22.8	30.0	7.2
	HT/VHT20, M8 to M15	2	4	19.8	19.8	22.8	30.0	7.2
	HT/VHT20 Beam Forming, M0 to M7	2	7	19.8	19.8	22.8	29.0	6.2
	HT/VHT20 Beam Forming, M8 to M15	2	4	19.8	19.8	22.8	30.0	7.2
	HT/VHT20 STBC, M0 to M7	2	4	19.8	19.8	22.8	30.0	7.2

Maximum Transmit Output Power, 5795 MHz, HT/VHT40 Beam Forming, M0 to M7



Antenna A

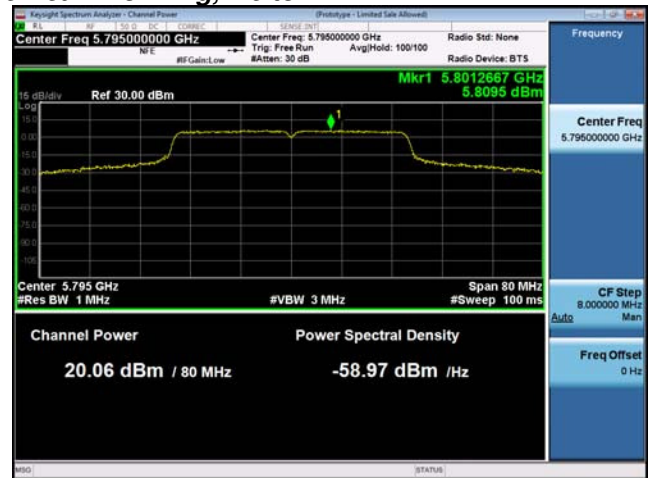

Antenna B

A.4 Power Spectral Density

15.407 / RSS-247/ LP0002:3.10.1(2.3) The power spectral density shall not exceed 30 dBm in any 500 kHz band. If transmitting antennas of directional gain greater than 6 dBi are used, both the maximum conducted output power and the power spectral density shall be reduced by the amount in dB that the directional gain of the antenna exceeds 6 dBi.

Test Procedure

Ref. KDB 789033 D02 General UNII Test Procedures New Rules v01

Power Spectral Density
Test Procedure
<ol style="list-style-type: none"> 1. Connect the antenna port(s) to the spectrum analyzer input. 2. Set the radio in the continuous transmitting mode at full power 3. Configure Spectrum analyzer as per test parameters below and Peak search marker 4. Capture graphs and record pertinent measurement data.

Ref. KDB 789033 D02 v01 section F.5

Power Spectral Density
Test parameters
Span = >1.5 times the OBW RBW = 500 kHz. VBW ≥ 3 x RBW Sweep = 10s Detector = Peak Trace = Single Sweep Marker = Peak Search

The “Measure and add 10 log(N) dB technique”, where N is the number of outputs, is used for measuring in-band Power Spectral Density. With this technique, spectrum measurements are performed at each output of the device, and the quantity 10 log(4) (or 6dB) is added to the worst case spectrum value before comparing to the emission limit. (ANSI C63.10 2013 section 14.3.2.3)

System Number	Description	Samples	System under test	Support equipment
1	EUT	S01	<input checked="" type="checkbox"/>	<input type="checkbox"/>
	Support	S02	<input type="checkbox"/>	<input checked="" type="checkbox"/>

Tested By : Jose Aguirre	Date of testing: 16-Dec-16 - 06-Feb-17
Test Result : PASS	

See Appendix C for list of test equipment

Frequency (MHz)	Mode	Tx Paths	Correlated Antenna Gain (dBi)	Tx 1 PSD (dBm/500kHz)	Tx 2 PSD (dBm/500kHz)	Total PSD (dBm/500kHz)	Limit (dBm/500kHz)	Margin (dB)
5745	Non HT20, 6 to 54 Mbps	1	4	5.9		5.9	30.0	24.1
	Non HT20, 6 to 54 Mbps	2	7	5.9	5.5	8.7	29.0	20.3
	Non HT20 Beam Forming, 6 to 54 Mbps	2	7	5.9	5.5	8.7	29.0	20.3
	HT/VHT20, M0 to M7	1	4	5.9		5.9	30.0	24.1
	HT/VHT20, M0 to M7	2	7	5.9	5.3	8.6	29.0	20.4
	HT/VHT20, M8 to M15	2	4	5.9	5.3	8.6	30.0	21.4
	HT/VHT20 Beam Forming, M0 to M7	2	7	5.9	5.3	8.6	29.0	20.4
	HT/VHT20 Beam Forming, M8 to M15	2	4	5.9	5.3	8.6	30.0	21.4
	HT/VHT20 STBC, M0 to M7	2	4	5.9	5.3	8.6	30.0	21.4
5755	Non HT40, 6 to 54 Mbps	1	4	1.3		1.3	30.0	28.7
	Non HT40, 6 to 54 Mbps	2	7	1.3	1.0	4.2	29.0	24.8
	HT/VHT40, M0 to M7	1	4	2.4		2.4	30.0	27.6
	HT/VHT40, M0 to M7	2	7	2.4	2.2	5.3	29.0	23.7
	HT/VHT40, M8 to M15	2	4	2.4	2.2	5.3	30.0	24.7
	HT/VHT40 Beam Forming, M0 to M7	2	7	2.4	2.2	5.3	29.0	23.7
	HT/VHT40 Beam Forming, M8 to M15	2	4	2.4	2.2	5.3	30.0	24.7
	HT/VHT40 STBC, M0 to M7	2	4	2.4	2.2	5.3	30.0	24.7
	5775	Non HT80, 6 to 54 Mbps	1	4	-1.7		-1.7	30.0
Non HT80, 6 to 54 Mbps		2	7	-1.7	-2.0	1.2	29.0	27.8
HT/VHT80, M0 to M9 1ss		1	4	-2.1		-2.1	30.0	32.1
HT/VHT80, M0 to M9 1ss		2	7	-2.1	-2.2	0.9	29.0	28.1
HT/VHT80, M0 to M9 2ss		2	4	-2.1	-2.2	0.9	30.0	29.1
HT/VHT80 Beam Forming, M0 to M9 1ss		2	7	-2.1	-2.2	0.9	29.0	28.1
HT/VHT80 Beam Forming, M0 to M9 2ss		2	4	-2.1	-2.2	0.9	30.0	29.1
HT/VHT80 STBC, M0 to M9 2ss		2	4	-2.1	-2.2	0.9	30.0	29.1
5785		Non HT20, 6 to 54 Mbps	1	4	5.6		5.6	30.0
	Non HT20, 6 to 54 Mbps	2	7	5.6	6.2	8.9	29.0	20.1
	Non HT20 Beam Forming, 6 to 54 Mbps	2	7	5.6	6.2	8.9	29.0	20.1
	HT/VHT20, M0 to M7	1	4	5.3		5.3	30.0	24.7
	HT/VHT20, M0 to M7	2	7	5.3	5.9	8.6	29.0	20.4
	HT/VHT20, M8 to M15	2	4	5.3	5.9	8.6	30.0	21.4
	HT/VHT20 Beam Forming, M0 to M7	2	7	5.3	5.9	8.6	29.0	20.4
	HT/VHT20 Beam Forming, M8 to M15	2	4	5.3	5.9	8.6	30.0	21.4

	HT/VHT20 STBC, M0 to M7	2	4	5.3	5.9	8.6	30.0	21.4
5795	Non HT40, 6 to 54 Mbps	1	4	2.7		2.7	30.0	27.3
	Non HT40, 6 to 54 Mbps	2	7	2.7	2.8	5.8	29.0	23.2
	HT/VHT40, M0 to M7	1	4	2.8		2.8	30.0	27.2
	HT/VHT40, M0 to M7	2	7	2.8	3.0	5.9	29.0	23.1
	HT/VHT40, M8 to M15	2	4	2.8	3.0	5.9	30.0	24.1
	HT/VHT40 Beam Forming, M0 to M7	2	7	2.8	3.0	5.9	29.0	23.1
	HT/VHT40 Beam Forming, M8 to M15	2	4	2.8	3.0	5.9	30.0	24.1
	HT/VHT40 STBC, M0 to M7	2	4	2.8	3.0	5.9	30.0	24.1
5825	Non HT20, 6 to 54 Mbps	1	4	6.4		6.4	30.0	23.6
	Non HT20, 6 to 54 Mbps	2	7	6.4	6.0	9.2	29.0	19.8
	Non HT20 Beam Forming, 6 to 54 Mbps	2	7	6.4	6.0	9.2	29.0	19.8
	HT/VHT20, M0 to M7	1	4	5.9		5.9	30.0	24.1
	HT/VHT20, M0 to M7	2	7	5.9	5.8	8.9	29.0	20.1
	HT/VHT20, M8 to M15	2	4	5.9	5.8	8.9	30.0	21.1
	HT/VHT20 Beam Forming, M0 to M7	2	7	5.9	5.8	8.9	29.0	20.1
	HT/VHT20 Beam Forming, M8 to M15	2	4	5.9	5.8	8.9	30.0	21.1
	HT/VHT20 STBC, M0 to M7	2	4	5.9	5.8	8.9	30.0	21.1

Power Spectral Density, 5825 MHz, Non HT20, 6 to 54 Mbps

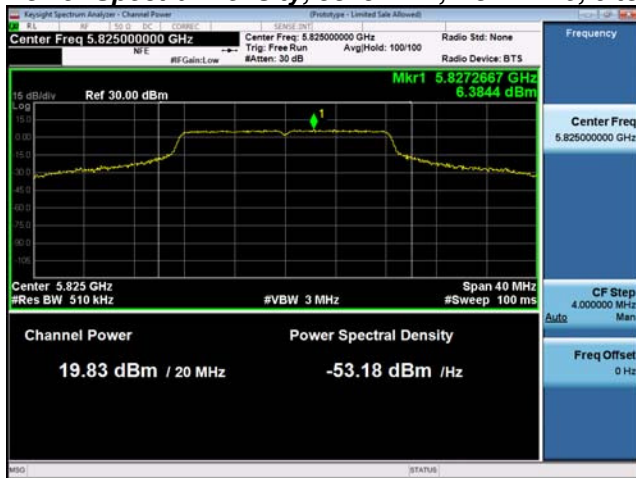

Antenna A

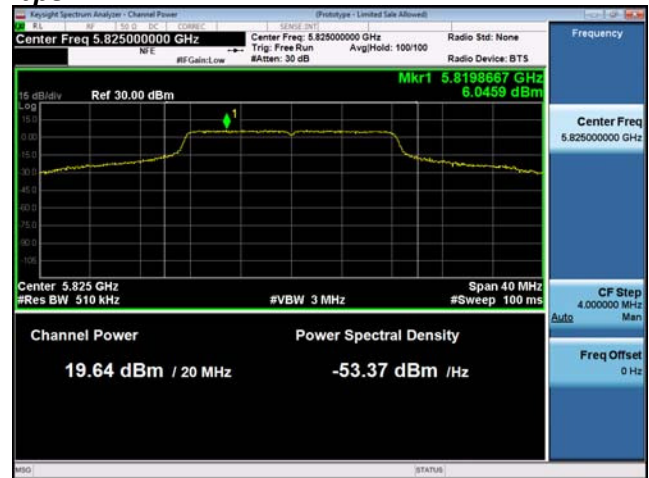

Antenna B

A.5 Conducted Spurious Emissions

15.205 / 15.209 / LP0002 - Radiated emissions which fall in the restricted bands, as defined in Section 15.205(a), must also comply with the radiated emission limits specified in Section 15.209(a) (see Section 15.205(c)).

RSS-Gen 8.9: Except when the requirements applicable to a given device state otherwise, emissions from licence-exempt transmitters shall comply with the field strength limits shown in Table 4 and Table 5 below. Additionally, the level of any transmitter emission shall not exceed the level of the transmitter's fundamental emission.

RSS-Gen 8.10 (b) Unwanted emissions that fall into restricted bands of Table 6 shall comply with the limits specified in RSS-Gen; and **(c)** Unwanted emissions that do not fall within the restricted frequency bands of Table 6 shall comply either with the limits specified in the applicable RSS or with those specified in this RSS-Gen.

Use formula below to substitute conducted measurements in place of radiated measurements

$$E[\text{dB}\mu\text{V}/\text{m}] = \text{EIRP}[\text{dBm}] - 20 \log(d[\text{meters}]) + 104.77, \text{ where } E = \text{field strength and } d = 3 \text{ meter}$$

- 1) Average Plot, Limit= -41.25 dBm eirp
- 2) Peak plot, Limit = -21.25 dBm eirp

Test Procedure

Ref. KDB 789033 D02 General UNII Test Procedures New Rules v01r03
ANSI C63.10: 2013

Conducted Spurious Emissions Test Procedure
<ol style="list-style-type: none"> 1. Connect the antenna port(s) to the spectrum analyzer input. 2. Place the radio in continuous transmit mode. Use the procedures in KDB 789033 D02 General UNII Test Procedures New Rules v01r03 to substitute conducted measurements in place of radiated measurements. 3. Configure Spectrum analyzer as per test parameters below (be sure to enter all losses between the transmitter output and the spectrum analyzer). 4. Record the marker waveform peak to spur difference. Also measure any emissions in the restricted bands. 5. The "measure-and-sum technique" is used for measuring in-band transmit power of a device. In the measure-and-sum approach, the conducted emission level is measured at each antenna port. The measured results at the various antenna ports are then summed mathematically to determine the total emission level from the device. Summing is performed in linear power units. The worst case output is recorded. 6. Capture graphs and record pertinent measurement data.

Ref. KDB 789033 D02 General UNII Test Procedures New Rules v01r03
ANSI C63.10: 2013 section 12.7.7.3 (average) & 12.7.6 (peak)

Conducted Spurious Emissions Test parameters
Span = 30MHz to 18GHz / 18GHz to 40GHz RBW = 1 MHz VBW ≥ 3 x RBW for Peak, 1kHz for Average Sweep = Auto couple Detector = Peak Trace = Max Hold.

System Number	Description	Samples	System under test	Support equipment
1	EUT	S01	<input checked="" type="checkbox"/>	<input type="checkbox"/>
	Support	S02	<input type="checkbox"/>	<input checked="" type="checkbox"/>

Tested By : Jose Aguirre	Date of testing: 16-Dec-16 - 06-Feb-17
Test Result : PASS	

See Appendix C for list of test equipment

Conducted Spurs Average Upper, All Antennas

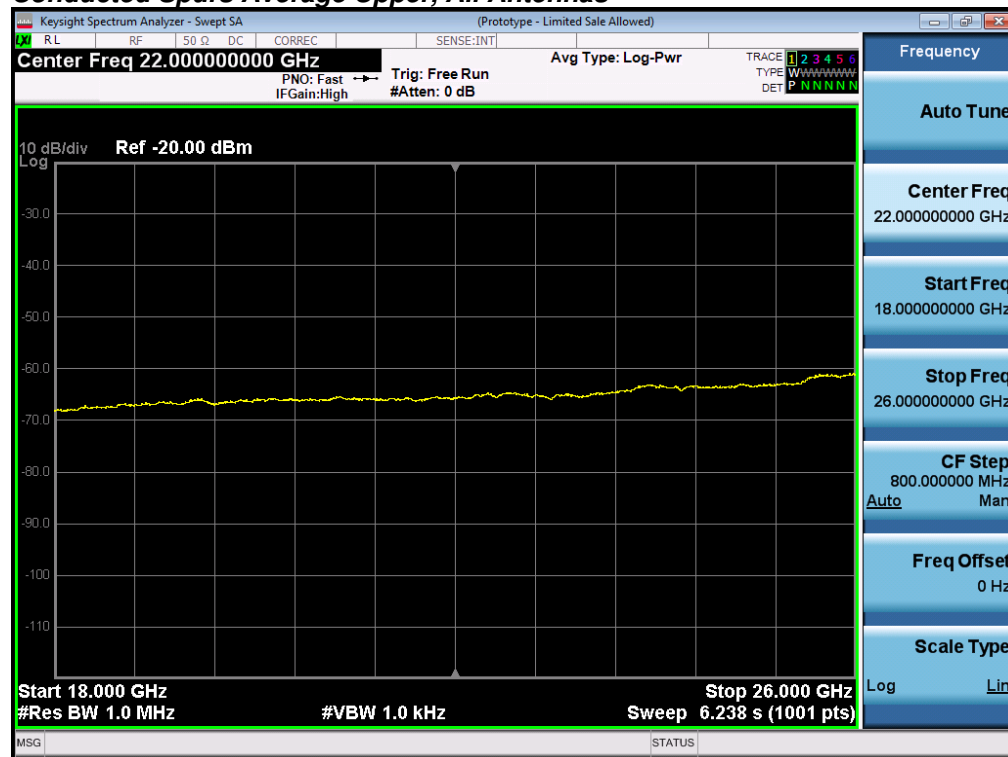

Conducted Spurs Peak Upper, All Antennas

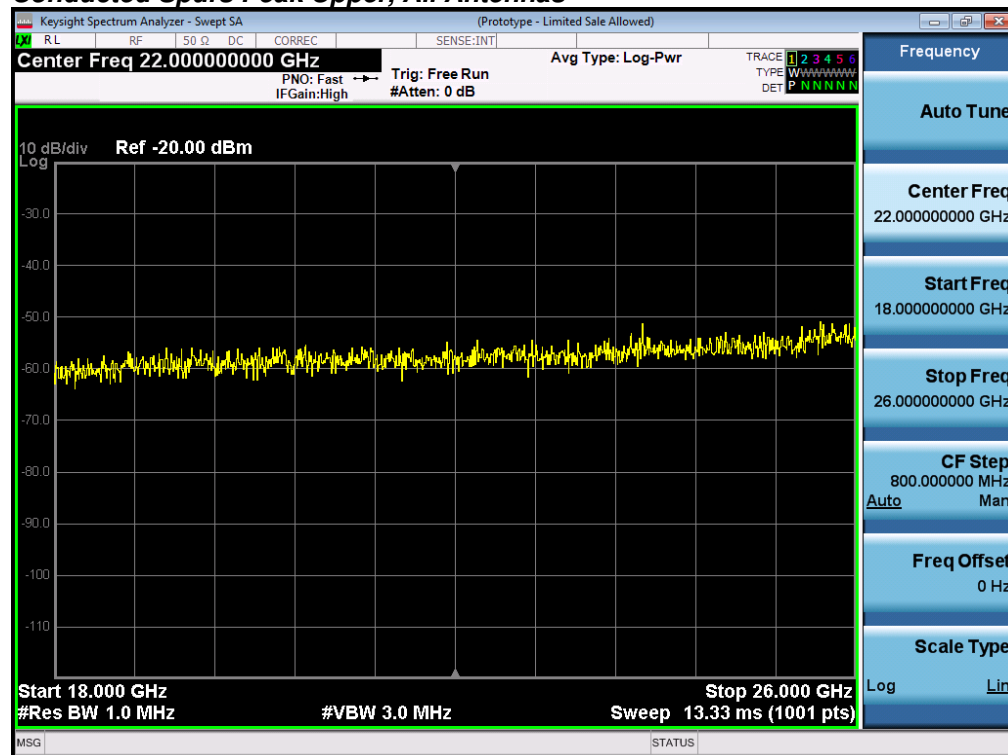

Frequency (MHz)	Mode	Tx Paths	Correlated Antenna Gain (dBi)	Tx 1 Spur Power (dBm)	Tx 2 Spur Power (dBm)	Total Conducted Spur (dBm)	Limit (dBm)	Margin (dB)
5745	Non HT20, 6 to 54 Mbps	1	4	-65.5		-61.5	-41.25	20.3
	Non HT20, 6 to 54 Mbps	2	4	-65.5	-57.2	-52.6	-41.25	11.4
	Non HT20 Beam Forming, 6 to 54 Mbps	2	7	-65.5	-57.2	-49.6	-41.25	8.4
	HT/VHT20, M0 to M7	1	4	-57.6		-53.6	-41.25	12.4
	HT/VHT20, M0 to M7	2	4	-57.6	-57.0	-50.3	-41.25	9.0
	HT/VHT20, M8 to M15	2	4	-57.6	-57.0	-50.3	-41.25	9.0
	HT/VHT20 Beam Forming, M0 to M7	2	7	-57.6	-57.0	-47.3	-41.25	6.0
	HT/VHT20 Beam Forming, M8 to M15	2	4	-57.6	-57.0	-50.3	-41.25	9.0
	HT/VHT20 STBC, M0 to M7	2	4	-57.6	-57.0	-50.3	-41.25	9.0
5755	Non HT40, 6 to 54 Mbps	1	4	-57.0		-53.0	-41.25	11.8
	Non HT40, 6 to 54 Mbps	2	4	-57.0	-57.0	-50.0	-41.25	8.7
	HT/VHT40, M0 to M7	1	4	-57.3		-53.3	-41.25	12.1
	HT/VHT40, M0 to M7	2	4	-57.3	-57.2	-50.2	-41.25	9.0
	HT/VHT40, M8 to M15	2	4	-57.3	-57.2	-50.2	-41.25	9.0
	HT/VHT40 Beam Forming, M0 to M7	2	7	-57.3	-57.2	-47.2	-41.25	6.0
	HT/VHT40 Beam Forming, M8 to M15	2	4	-57.3	-57.2	-50.2	-41.25	9.0
	HT/VHT40 STBC, M0 to M7	2	4	-57.3	-57.2	-50.2	-41.25	9.0
5775	Non HT80, 6 to 54 Mbps	1	4	-57.1		-53.1	-41.25	11.9
	Non HT80, 6 to 54 Mbps	2	4	-57.1	-56.8	-49.9	-41.25	8.7
	HT/VHT80, M0 to M9 1ss	1	4	-57.3		-53.3	-41.25	12.1
	HT/VHT80, M0 to M9 1ss	2	4	-57.3	-57.2	-50.2	-41.25	9.0
	HT/VHT80, M0 to M9 2ss	2	4	-57.3	-57.2	-50.2	-41.25	9.0
	HT/VHT80 Beam Forming, M0 to M9 1ss	2	7	-57.3	-57.2	-47.2	-41.25	6.0
	HT/VHT80 Beam Forming, M0 to M9 2ss	2	4	-57.3	-57.2	-50.2	-41.25	9.0
	HT/VHT80 STBC, M0 to M9 2ss	2	4	-57.3	-57.2	-50.2	-41.25	9.0
5785	Non HT20, 6 to 54 Mbps	1	4	-57.4		-53.4	-41.25	12.2
	Non HT20, 6 to 54 Mbps	2	4	-57.4	-57.9	-50.6	-41.25	9.4
	Non HT20 Beam Forming, 6 to 54 Mbps	2	7	-57.4	-57.9	-47.6	-41.25	6.4
	HT/VHT20, M0 to M7	1	4	-57.3		-53.3	-41.25	12.1
	HT/VHT20, M0 to M7	2	4	-57.3	-57.1	-50.2	-41.25	8.9
	HT/VHT20, M8 to M15	2	4	-57.3	-57.1	-50.2	-41.25	8.9
	HT/VHT20 Beam Forming, M0 to M7	2	7	-57.3	-57.1	-47.2	-41.25	5.9
	HT/VHT20 Beam Forming, M8 to M15	2	4	-57.3	-57.1	-50.2	-41.25	8.9

	HT/VHT20 STBC, M0 to M7	2	4	-57.3	-57.1	-50.2	-41.25	8.9
5795	Non HT40, 6 to 54 Mbps	1	4	-57.9		-53.9	-41.25	12.7
	Non HT40, 6 to 54 Mbps	2	4	-57.9	-57.8	-50.8	-41.25	9.6
	HT/VHT40, M0 to M7	1	4	-66.9		-62.9	-41.25	21.7
	HT/VHT40, M0 to M7	2	4	-66.9	-57.4	-52.9	-41.25	11.7
	HT/VHT40, M8 to M15	2	4	-66.9	-57.4	-52.9	-41.25	11.7
	HT/VHT40 Beam Forming, M0 to M7	2	7	-66.9	-57.4	-49.9	-41.25	8.7
	HT/VHT40 Beam Forming, M8 to M15	2	4	-66.9	-57.4	-52.9	-41.25	11.7
	HT/VHT40 STBC, M0 to M7	2	4	-66.9	-57.4	-52.9	-41.25	11.7
5825	Non HT20, 6 to 54 Mbps	1	4	-59.3		-55.3	-41.25	14.1
	Non HT20, 6 to 54 Mbps	2	4	-59.3	-59.1	-52.2	-41.25	10.9
	Non HT20 Beam Forming, 6 to 54 Mbps	2	7	-59.3	-59.1	-49.2	-41.25	7.9
	HT/VHT20, M0 to M7	1	4	-67.4		-63.4	-41.25	22.2
	HT/VHT20, M0 to M7	2	4	-67.4	-59.5	-54.8	-41.25	13.6
	HT/VHT20, M8 to M15	2	4	-67.4	-59.5	-54.8	-41.25	13.6
	HT/VHT20 Beam Forming, M0 to M7	2	7	-67.4	-59.5	-51.8	-41.25	10.6
	HT/VHT20 Beam Forming, M8 to M15	2	4	-67.4	-59.5	-54.8	-41.25	13.6
	HT/VHT20 STBC, M0 to M7	2	4	-67.4	-59.5	-54.8	-41.25	13.6



Conducted Spurs Average, 5785 MHz, HT/VHT20 Beam Forming, M0 to M7



Antenna A

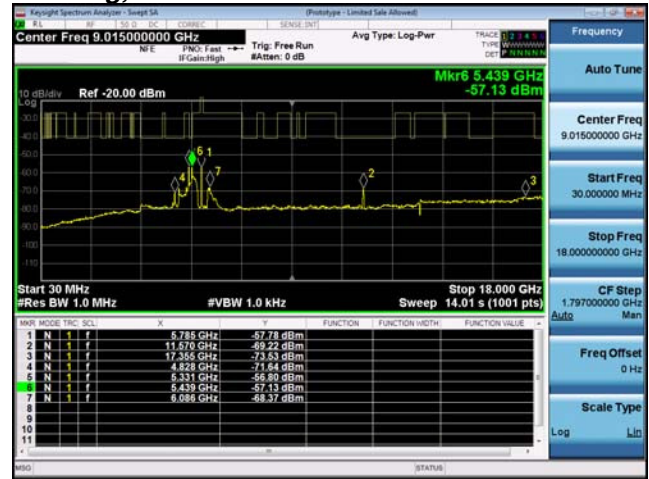

Antenna B

Frequency (MHz)	Mode	Tx Paths	Correlated Antenna Gain (dBi)	Tx 1 Spur Power (dBm)	Tx 2 Spur Power (dBm)	Total Conducted Spur (dBm)	Limit (dBm)	Margin (dB)
5745	Non HT20, 6 to 54 Mbps	1	4	-57.6		-53.6	-21.25	32.4
	Non HT20, 6 to 54 Mbps	2	4	-57.6	-52.5	-47.3	-21.25	26.1
	Non HT20 Beam Forming, 6 to 54 Mbps	2	7	-57.6	-52.5	-44.3	-21.25	23.1
	HT/VHT20, M0 to M7	1	4	-58.2		-54.2	-21.25	33.0
	HT/VHT20, M0 to M7	2	4	-58.2	-57.6	-50.9	-21.25	29.6
	HT/VHT20, M8 to M15	2	4	-58.2	-57.6	-50.9	-21.25	29.6
	HT/VHT20 Beam Forming, M0 to M7	2	7	-58.2	-57.6	-47.9	-21.25	26.6
	HT/VHT20 Beam Forming, M8 to M15	2	4	-58.2	-57.6	-50.9	-21.25	29.6
	HT/VHT20 STBC, M0 to M7	2	4	-58.2	-57.6	-50.9	-21.25	29.6
5755	Non HT40, 6 to 54 Mbps	1	4	-58.9		-54.9	-21.25	33.7
	Non HT40, 6 to 54 Mbps	2	4	-58.9	-59.5	-52.2	-21.25	30.9
	HT/VHT40, M0 to M7	1	4	-58.9		-54.9	-21.25	33.7
	HT/VHT40, M0 to M7	2	4	-58.9	-53.3	-48.2	-21.25	27.0
	HT/VHT40, M8 to M15	2	4	-58.9	-53.3	-48.2	-21.25	27.0
	HT/VHT40 Beam Forming, M0 to M7	2	7	-58.9	-53.3	-45.2	-21.25	24.0
	HT/VHT40 Beam Forming, M8 to M15	2	4	-58.9	-53.3	-48.2	-21.25	27.0
	HT/VHT40 STBC, M0 to M7	2	4	-58.9	-53.3	-48.2	-21.25	27.0
5775	Non HT80, 6 to 54 Mbps	1	4	-56.9		-52.9	-21.25	31.7
	Non HT80, 6 to 54 Mbps	2	4	-56.9	-58.2	-50.5	-21.25	29.2
	HT/VHT80, M0 to M9 1ss	1	4	-58.0		-54.0	-21.25	32.8
	HT/VHT80, M0 to M9 1ss	2	4	-58.0	-57.0	-50.5	-21.25	29.2
	HT/VHT80, M0 to M9 2ss	2	4	-58.0	-57.0	-50.5	-21.25	29.2
	HT/VHT80 Beam Forming, M0 to M9 1ss	2	7	-58.0	-57.0	-47.5	-21.25	26.2
	HT/VHT80 Beam Forming, M0 to M9 2ss	2	4	-58.0	-57.0	-50.5	-21.25	29.2
	HT/VHT80 STBC, M0 to M9 2ss	2	4	-58.0	-57.0	-50.5	-21.25	29.2
5785	Non HT20, 6 to 54 Mbps	1	4	-51.9		-47.9	-21.25	26.7
	Non HT20, 6 to 54 Mbps	2	4	-51.9	-52.2	-45.0	-21.25	23.8
	Non HT20 Beam Forming, 6 to 54 Mbps	2	7	-51.9	-52.2	-42.0	-21.25	20.8
	HT/VHT20, M0 to M7	1	4	-51.4		-47.4	-21.25	26.2
	HT/VHT20, M0 to M7	2	4	-51.4	-51.6	-44.5	-21.25	23.2
	HT/VHT20, M8 to M15	2	4	-51.4	-51.6	-44.5	-21.25	23.2
	HT/VHT20 Beam Forming, M0 to M7	2	7	-51.4	-51.6	-41.5	-21.25	20.2
	HT/VHT20 Beam Forming, M8 to M15	2	4	-51.4	-51.6	-44.5	-21.25	23.2



	HT/VHT20 STBC, M0 to M7	2	4	-51.4	-51.6	-44.5	-21.25	23.2
5795	Non HT40, 6 to 54 Mbps	1	4	-52.8		-48.8	-21.25	27.6
	Non HT40, 6 to 54 Mbps	2	4	-52.8	-57.6	-47.6	-21.25	26.3
	HT/VHT40, M0 to M7	1	4	-57.7		-53.7	-21.25	32.5
	HT/VHT40, M0 to M7	2	4	-57.7	-53.0	-47.7	-21.25	26.5
	HT/VHT40, M8 to M15	2	4	-57.7	-53.0	-47.7	-21.25	26.5
	HT/VHT40 Beam Forming, M0 to M7	2	7	-57.7	-53.0	-44.7	-21.25	23.5
	HT/VHT40 Beam Forming, M8 to M15	2	4	-57.7	-53.0	-47.7	-21.25	26.5
	HT/VHT40 STBC, M0 to M7	2	4	-57.7	-53.0	-47.7	-21.25	26.5
5825	Non HT20, 6 to 54 Mbps	1	4	-59.9		-55.9	-21.25	34.7
	Non HT20, 6 to 54 Mbps	2	4	-59.9	-55.7	-50.3	-21.25	29.1
	Non HT20 Beam Forming, 6 to 54 Mbps	2	7	-59.9	-55.7	-47.3	-21.25	26.1
	HT/VHT20, M0 to M7	1	4	-59.0		-55.0	-21.25	33.8
	HT/VHT20, M0 to M7	2	4	-59.0	-56.6	-50.6	-21.25	29.4
	HT/VHT20, M8 to M15	2	4	-59.0	-56.6	-50.6	-21.25	29.4
	HT/VHT20 Beam Forming, M0 to M7	2	7	-59.0	-56.6	-47.6	-21.25	26.4
	HT/VHT20 Beam Forming, M8 to M15	2	4	-59.0	-56.6	-50.6	-21.25	29.4
	HT/VHT20 STBC, M0 to M7	2	4	-59.0	-56.6	-50.6	-21.25	29.4

Conducted Spurs Peak, 5785 MHz, HT/VHT20 Beam Forming, M0 to M7



Antenna A



Antenna B

A.6 Conducted Bandedge

15.205 / 15.247 / LP0002 / RSS-247 In any 100 kHz bandwidth outside the frequency band in which the digitally modulated intentional radiator is operating, the radio frequency power that is produced by the intentional radiator shall be at least 30 dB below that in the 100 kHz bandwidth within the band that contains the highest level of the desired power.

Devices certified before March 2, 2018 with antenna gain of 10 dBi or less may demonstrate compliance with the emission limits in §15.247(d), but manufacturing, marketing and importing of devices certified under this alternative must cease before March 2, 2020.

Test Procedure

Ref. KDB 558074 D01 DTS Meas Guidance v03r05
ANSI C63.10: 2013

Conducted Band edge

Test Procedure

1. Connect the antenna port(s) to the spectrum analyzer input.
2. Place the radio in continuous transmit mode. Use the procedures in KDB 558074 D01 DTS Meas Guidance v03r05 to substitute conducted measurements in place of radiated measurements.
3. Configure Spectrum analyzer as per test parameters below (be sure to enter all losses between the transmitter output and the spectrum analyzer).
4. Place a marker at the end of the restricted band closest to the transmit frequency to show compliance. Also measure any emissions in the restricted bands..
5. The “measure-and-sum technique” is used for measuring in-band transmit power of a device. In the measure-and-sum approach, the conducted emission level is measured at each antenna port. The measured results at the various antenna ports are then summed mathematically to determine the total emission level from the device. Summing is performed in linear power units. The worst case output is recorded.
6. Place a marker at the end of the restricted band closest to the transmit frequency to show compliance. Also measure any emissions in the restricted bands
7. Capture graphs and record pertinent measurement data.

Conducted Bandedge

Test parameters non-restricted Band
KDB 558074 D01 v03r05 section 11.1b, 11.2-3, also see
ANSI C63.10: 2013 section 11.10.3

RBW = 100 kHz
VBW ≥ 3 x RBW
Sweep = Auto couple
Detector = Peak
Trace = Max Hold.

System Number	Description	Samples	System under test	Support equipment
1	EUT	S01	<input checked="" type="checkbox"/>	<input type="checkbox"/>
	Support	S02	<input type="checkbox"/>	<input checked="" type="checkbox"/>

Tested By :

Jose Aguirre

Date of testing:

16-Dec-16 - 06-Feb-17

Test Result : PASS

See Appendix C for list of test equipment



Frequency (MHz)	Mode	Data Rate (Mbps)	Conducted Bandedge Delta (dB)	Limit (dBc)	Margin (dB)
5745	Non HT20, 6 to 54 Mbps	6	39.9	>30	9.9
	HT/VHT20, M0 to M15	m0	37.0	>30	7.0
5755	Non HT40, 6 to 54 Mbps	6	30.8	>30	0.8
	HT/VHT40, M0 to M15	m0	34.1	>30	4.1
5775	Non HT80, 6 to 54 Mbps	6	32.2	>30	2.2
	HT/VHT80, M0 to M9, M0 to M9 1-1ss	m0x1	33.1	>30	3.1
5795	Non HT40, 6 to 54 Mbps	6	41.2	>30	11.2
	HT/VHT40, M0 to M15	m0	43.5	>30	13.5
5825	Non HT20, 6 to 54 Mbps	6	46.0	>30	16.0
	HT/VHT20, M0 to M15	m0	41.7	>30	11.7



Conducted Bandedge Delta, 5755 MHz, Non HT40, 6 to 54 Mbps

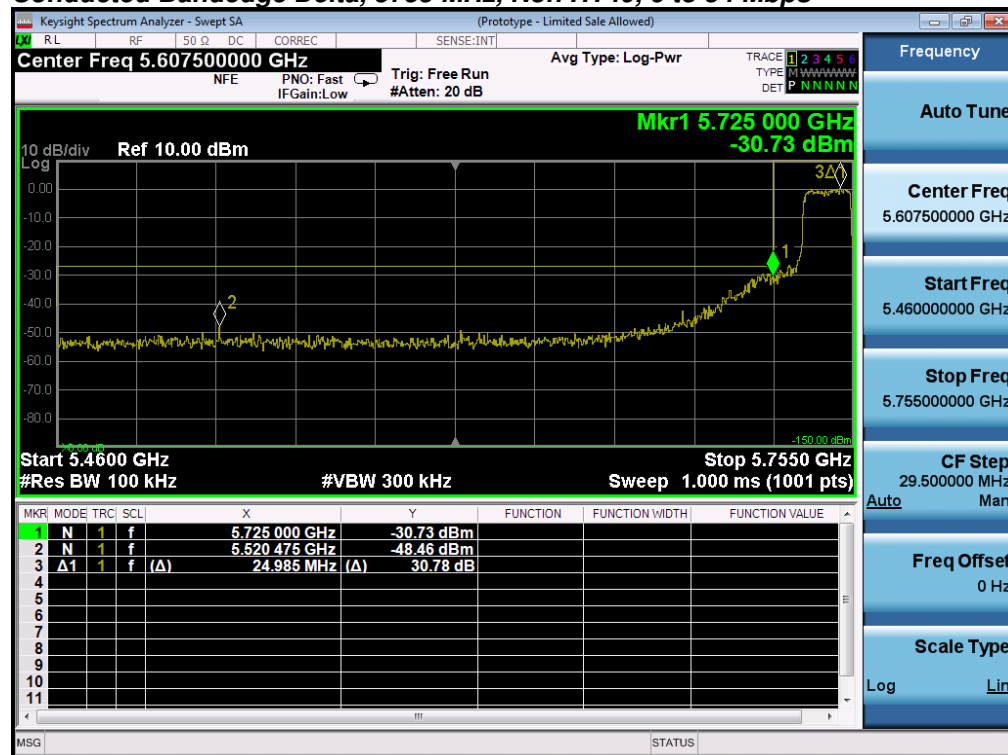

Appendix B: Emission Test Results

Testing Laboratory: Cisco Systems, Inc., 125 West Tasman Drive, San Jose, CA 95134, USA

Radiated Emission Setup Diagram-Below 1G

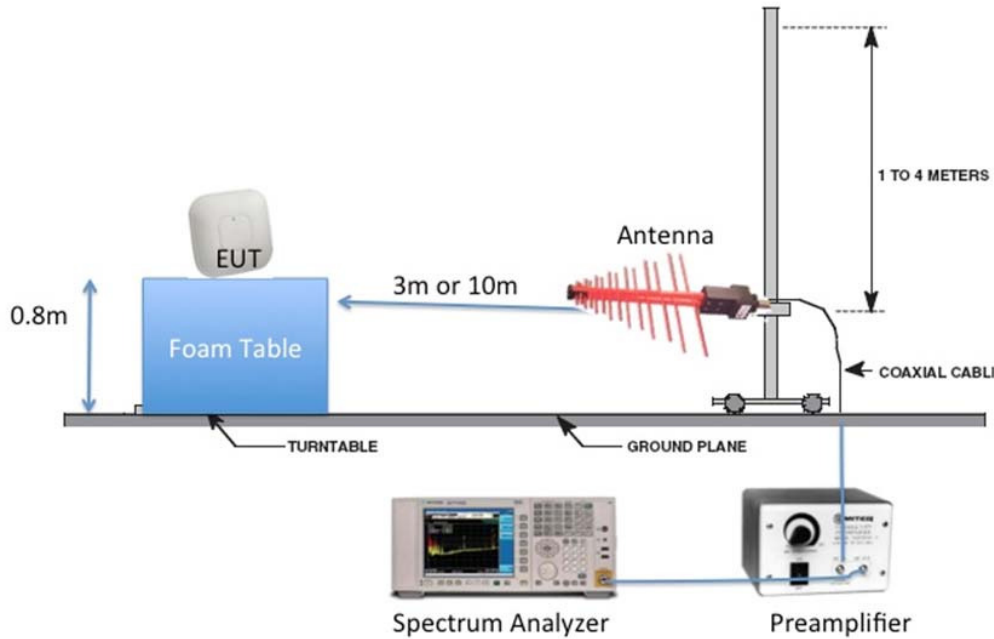

Radiated Emission Setup Diagram-Above 1G

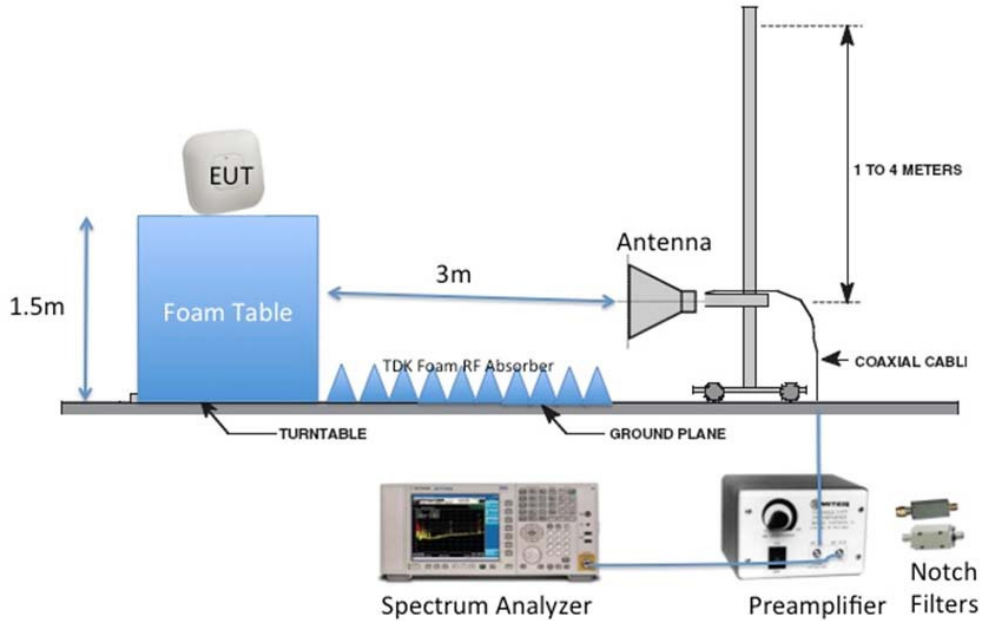

B.1 Radiated Spurious Emissions

15.407 / 15.209 / 15.205 For transmitters operating in the 5.725-5.85 GHz band: All emissions within the frequency range from the band edge to 10 MHz above or below the band edge shall not exceed an e.i.r.p. of -17 dBm/MHz; for frequencies 10 MHz or greater above or below the band edge, emissions shall not exceed an e.i.r.p. of -27 dBm/MHz. Unwanted emissions below 1 GHz must comply with the general field strength limits set forth in 15.209. The provisions of §15.205 apply to intentional radiators operating under this section. When measuring the emission limits, the nominal carrier frequency shall be adjusted as close to the upper and lower frequency band edges as the design of the equipment permits

RSS-GEN Radiated emissions which fall in the restricted bands, as defined in RSS-GEN section 8.10. must also comply with the radiated limits specified in RSS-GEN section 8.9

Ref. ANSI C63.10: 2013 section 12.7.6 (peak) & 12.7.7.3 (average)

Using Vasona, configure the spectrum analyzer as shown below (be sure to enter all losses between the transmitter output and the spectrum analyzer). Place the radio in continuous transmit mode.

Span:	1GHz – 18 GHz/18GHz-26G/26GHz-40GHz
Reference Level:	80 dBuV
Attenuation:	10 dB
Sweep Time:	Coupled
Resolution Bandwidth:	1MHz
Video Bandwidth:	3 MHz for peak, 1 KHz for average
Detector:	Peak

Terminate the access Point RF ports with 50 ohm loads.

Maximize Turntable (find worst case table angle), Maximize Antenna (find worst case height)

Save 2 plots: 1) Average plot (Vertical and Horizontal), Limit= 54dBuV/m @3m
2) Peak plot (Vertical and Horizontal), Limit = 74dBuV/m @3m

Place a marker at the end of the restricted band closest to the transmit frequency to show compliance. Also measure any emissions in the restricted bands.

This report represents the worst case data for all supported operating modes and antennas. There are no measurable emissions above 18 GHz.

System Number	Description	Samples	System under test	Support equipment
1	EUT	S01	<input checked="" type="checkbox"/>	<input type="checkbox"/>
	Support	S02	<input type="checkbox"/>	<input checked="" type="checkbox"/>

Tested By : Jose Aguirre	Date of testing: 16-Dec-16 - 06-Feb-17
Test Result : PASS	

See Appendix C for list of test equipment

B.1.A Transmitter Radiated Spurious Emissions-Average worst case

Frequency (MHz)	Mode	Data Rate (Mbps)	Spurious Emission Level (dBuV/m)	Limit (dBuV/m)	Margin (dB)
5745	Non HT/VHT20, 6 to 54 Mbps	6	52.6	54.0	1.4
5755	HT/VHT40, M0 to M15	m0	52.8	54.0	1.2
5775	HT/VHT80, M0 to M15	m0x1	49.8	54.0	4.2
5785	Non HT/VHT20, 6 to 54 Mbps	6	53.3	54.0	0.7
5795	HT/VHT40, M0 to M15	m0	52.6	54.0	1.4
5825	Non HT/VHT20, 6 to 54 Mbps	6	53.0	54.0	1.0



B.1.A.1 Radiated Transmitter Spurs, 5745 MHz, Non HT/VHT20, 6 to 54 Mbps, Average (1-18GHz)

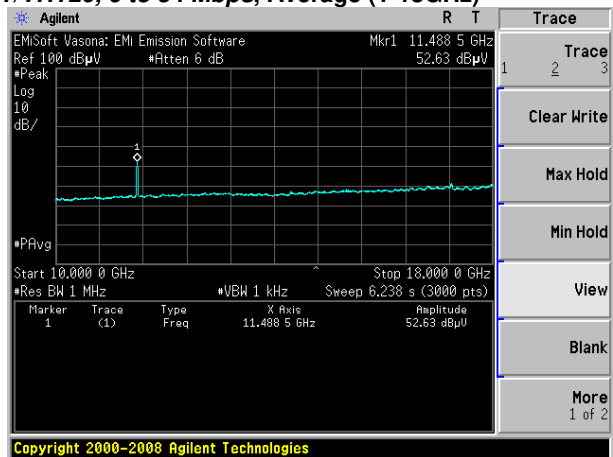
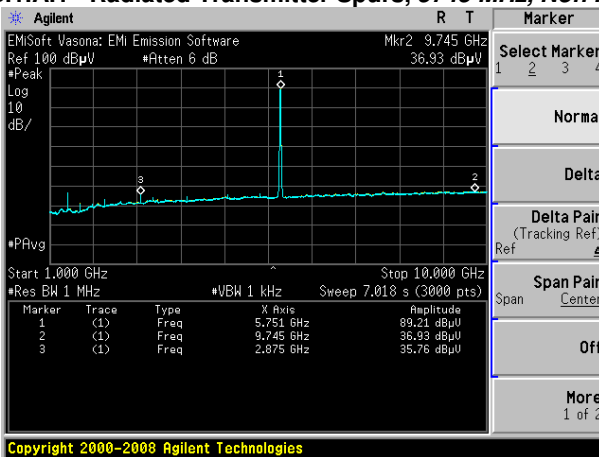

B.1.A.2 Radiated Transmitter Spurs, 5755 MHz, HT/VHT40, M0 to M15 Average (1-18GHz)

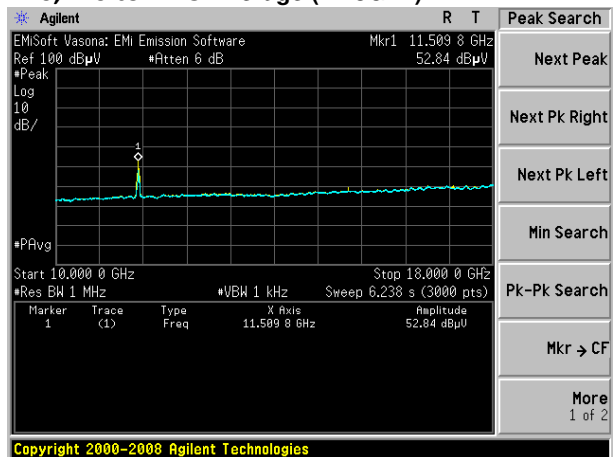
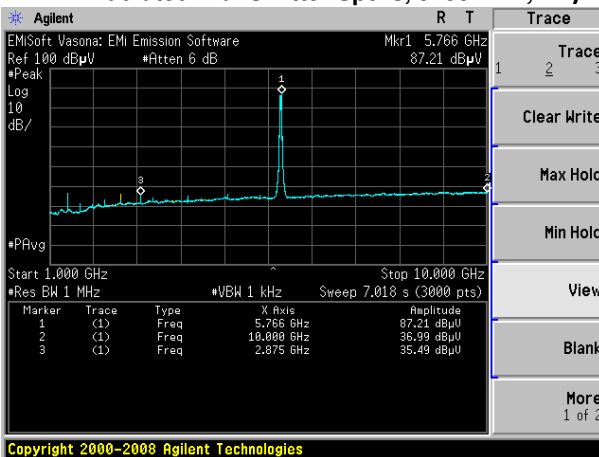

B.1.A.3 Radiated Transmitter Spurs, 5775 MHz, HT/VHT80, M0 to M15, Average (1-18GHz)

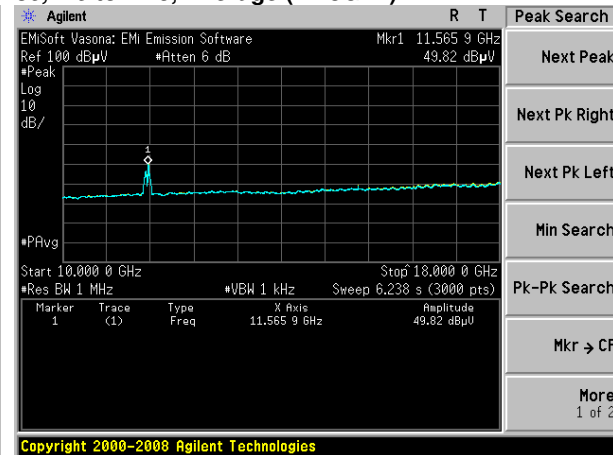
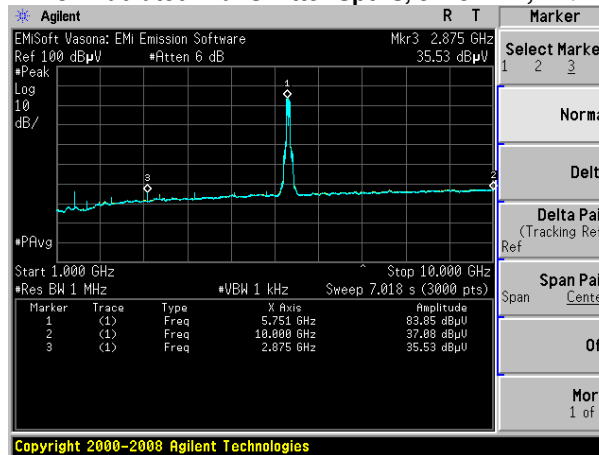



B.1.A.4 Radiated Transmitter Spurs, 5785 MHz, Non HT/VHT20, 6 to 54 Mbps, Average (1-18GHz)

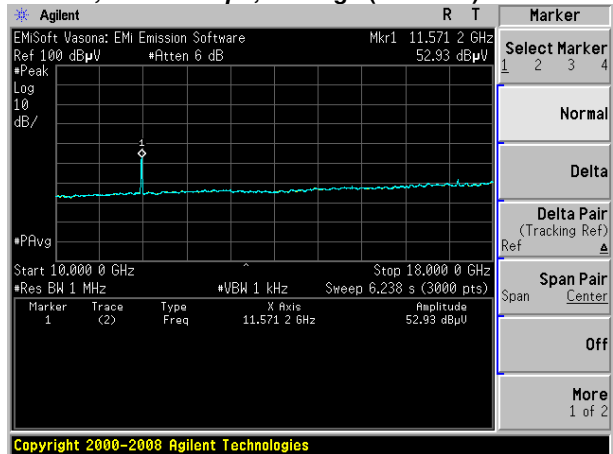
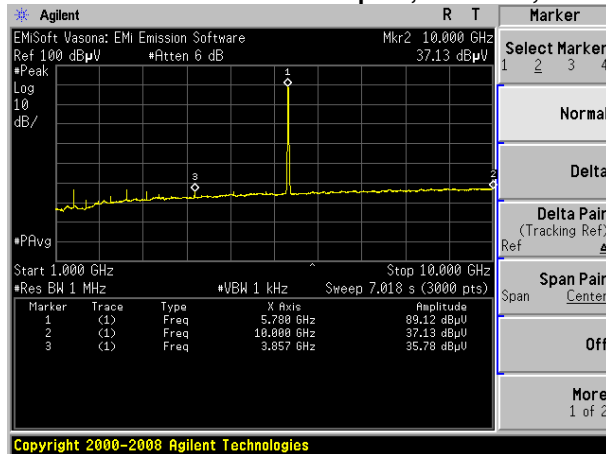

B.1.A.5 Radiated Transmitter Spurs, 5795 MHz, HT/VHT40, M0 to M15, Average (1-18GHz)

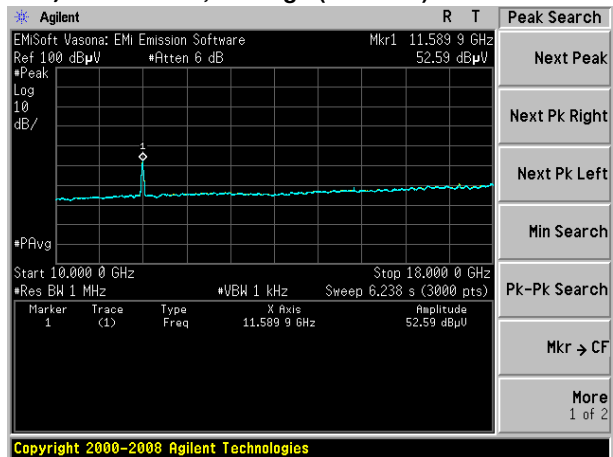
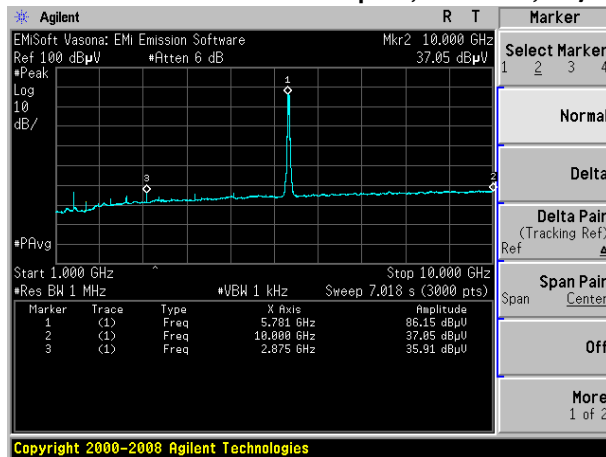

B.1.A.6 Radiated Transmitter Spurs, 5825 MHz, Non HT/VHT20, 6 to 54 Mbps, Average (1-18GHz)

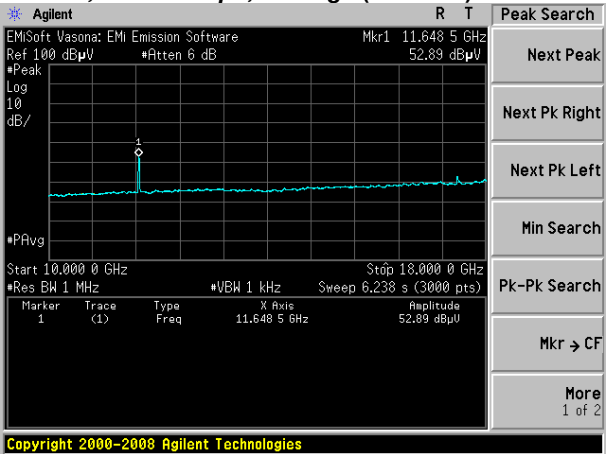
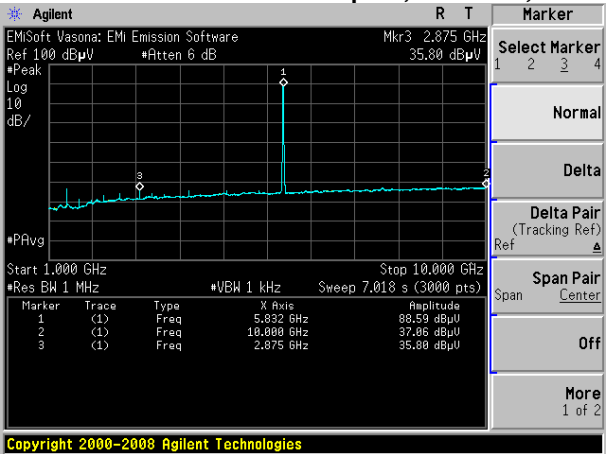

B.1.A.7 Radiated Transmitter Spurs, All rate, All modes, Average (18-26.5GHz)

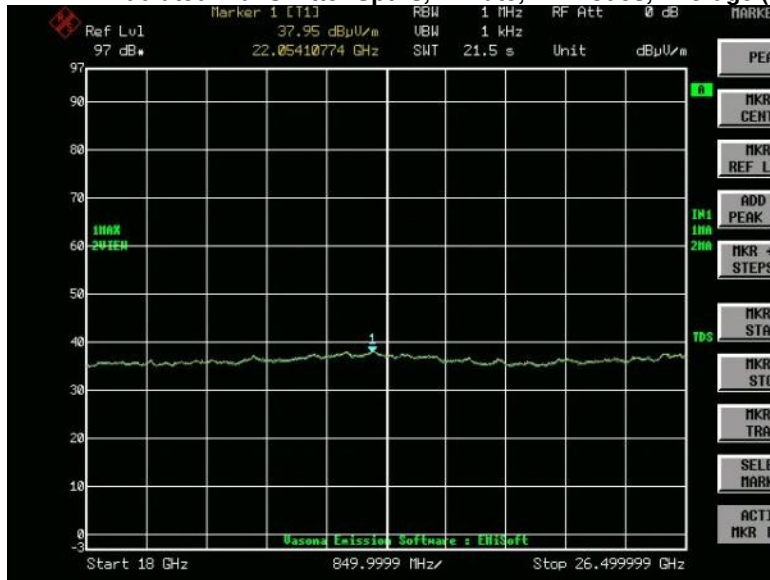

B.1.A.8 Radiated Transmitter Spurs, All rate, All modes, Average (26.5- 40GHz)

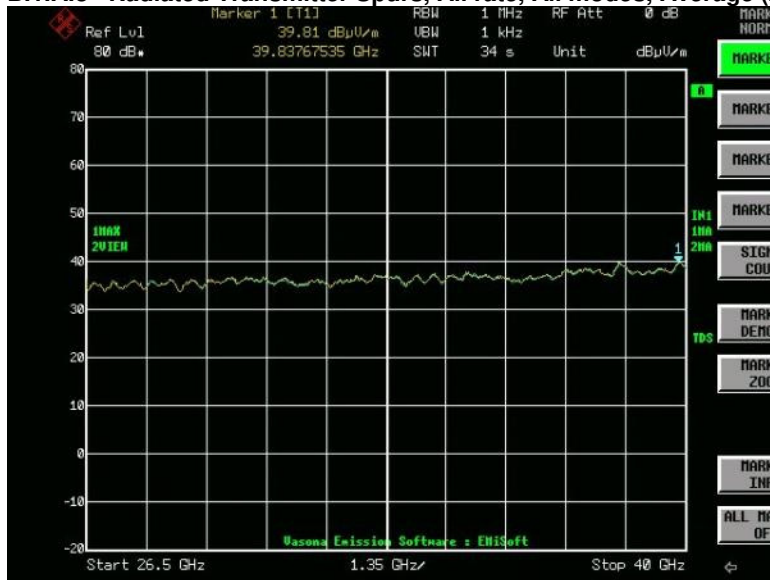

No emissions seen above 18GHz. The plots above are representative of all modes tested.

**B.1.P Transmitter Radiated Spurious Emissions-Peak worst case**

Frequency (MHz)	Mode	Data Rate (Mbps)	Spurious Emission Level (dBuV/m)	Limit (dBuV/m)	Margin (dB)
5745	Non HT/VHT20, 6 to 54 Mbps	6	60.1	74.0	13.9
5755	HT/VHT40, M0 to M15	m0	60.9	74.0	13.1
5775	HT/VHT80, M0 to M15	m0x1	58.3	74.0	15.7
5785	Non HT/VHT20, 6 to 54 Mbps	6	60.2	74.0	13.8
5795	HT/VHT40, M0 to M15	m0	60.0	74.0	14.0
5825	Non HT/VHT20, 6 to 54 Mbps	6	61.8	74.0	12.2

B.1.P.1 Radiated Transmitter Spurs, 5745 MHz, Non HT/VHT20, 6 to 54 Mbps, (1-18GHz)

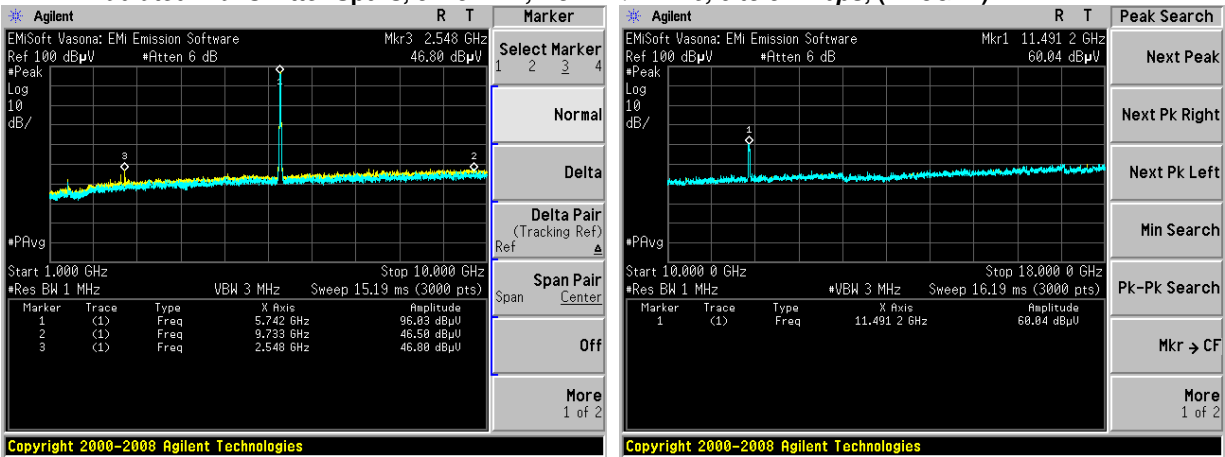

B.1.P.2 Radiated Transmitter Spurs, 5755 MHz, HT/VHT40, M0 to M15, Peak (1-18GHz)

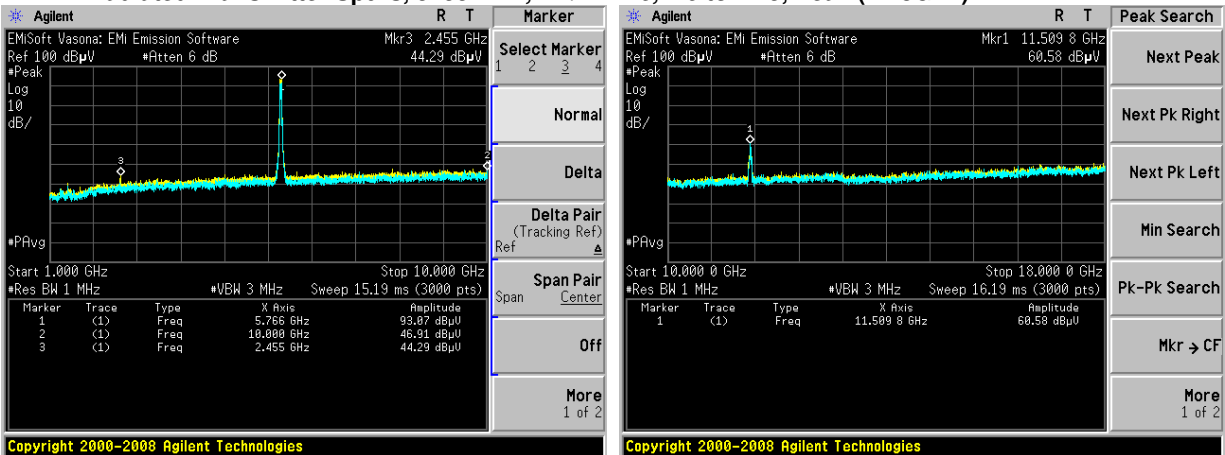

B.1.P.3 Radiated Transmitter Spurs, 5775 MHz, VHT80, M0 to M9, M0 to M9 1.1, Peak (1-18GHz)

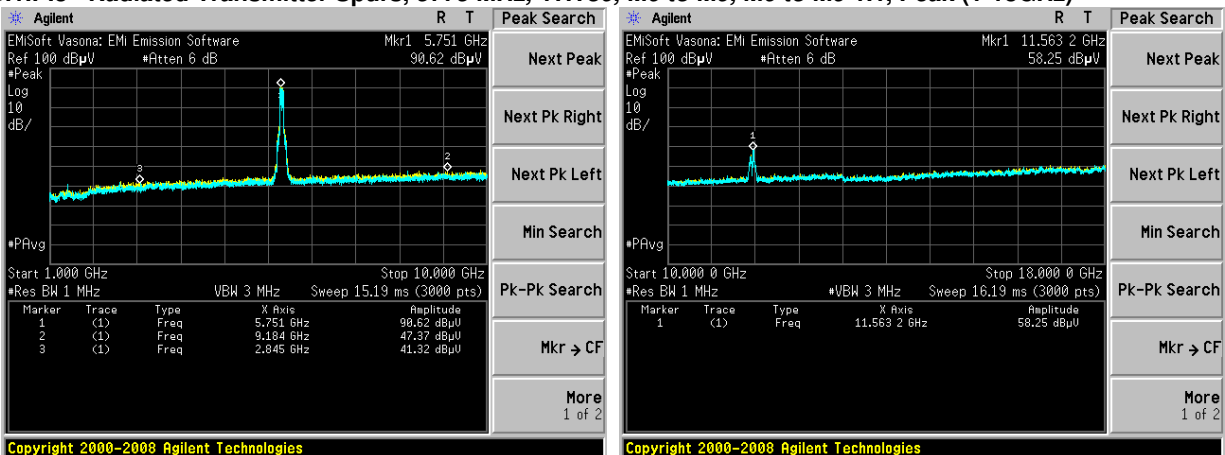



B.1.P.4 Radiated Transmitter Spurs, 5785 MHz, Non HT/VHT20, 6 to 54 Mbps, Peak (1-18GHz)

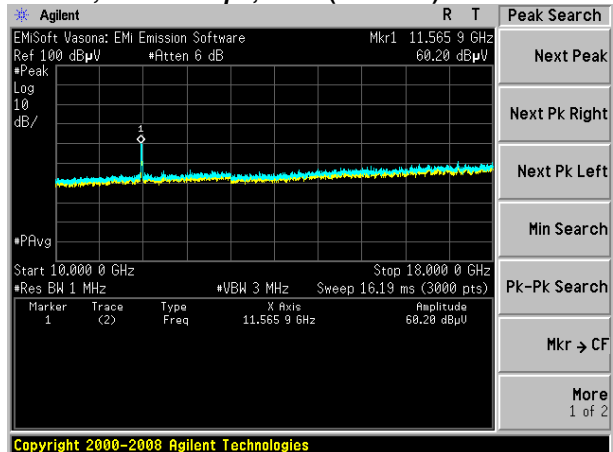
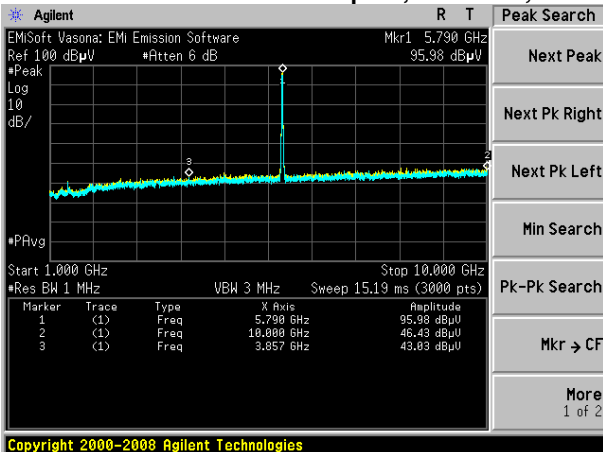

B.1.P.5 Radiated Transmitter Spurs, 5795 MHz, HT/VHT40, M0 to M15, Peak (1-18GHz)

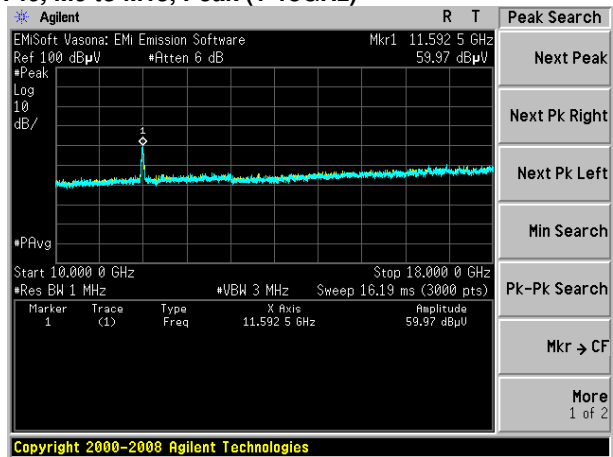
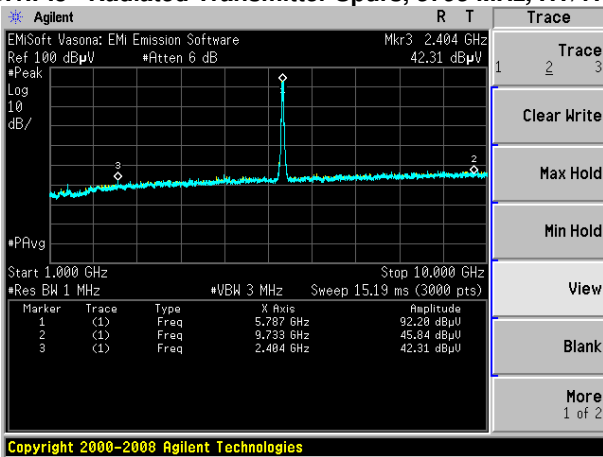

B.1.P.6 Radiated Transmitter Spurs, 5825 MHz, Non HT/VHT20, 6 to 54 Mbps, Peak (1-18GHz)

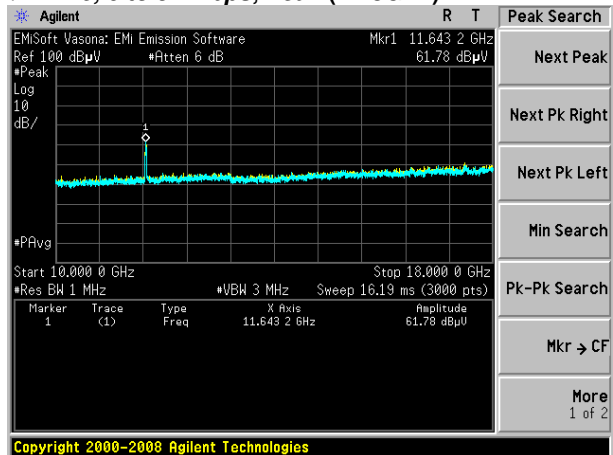
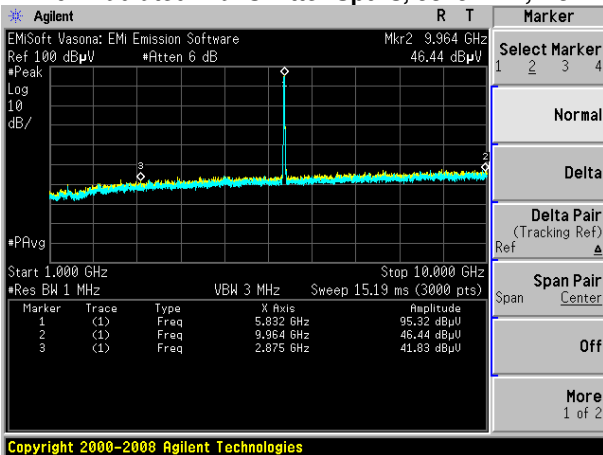



B.1.P.7 Radiated Transmitter Spurs, All rate, All modes, Peak (18-26.5GHz)

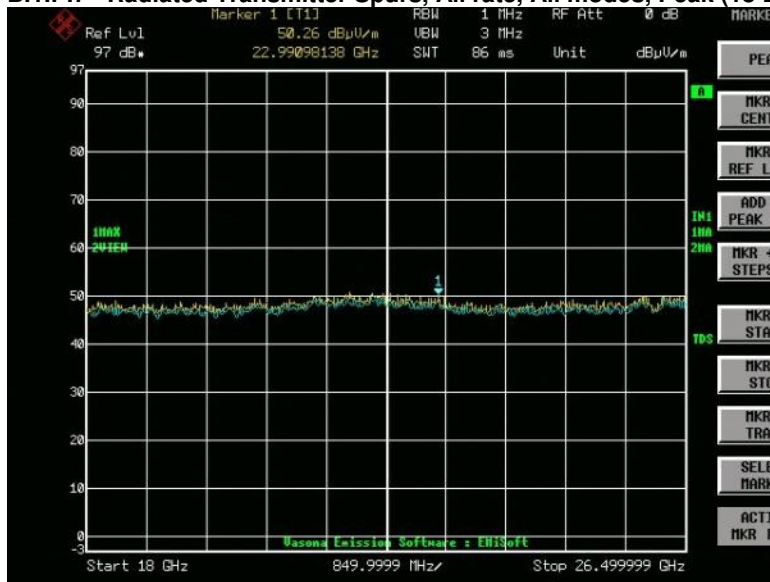

B.1.P.8 Radiated Transmitter Spurs, All rate, All modes, Peak (26.5-40GHz)

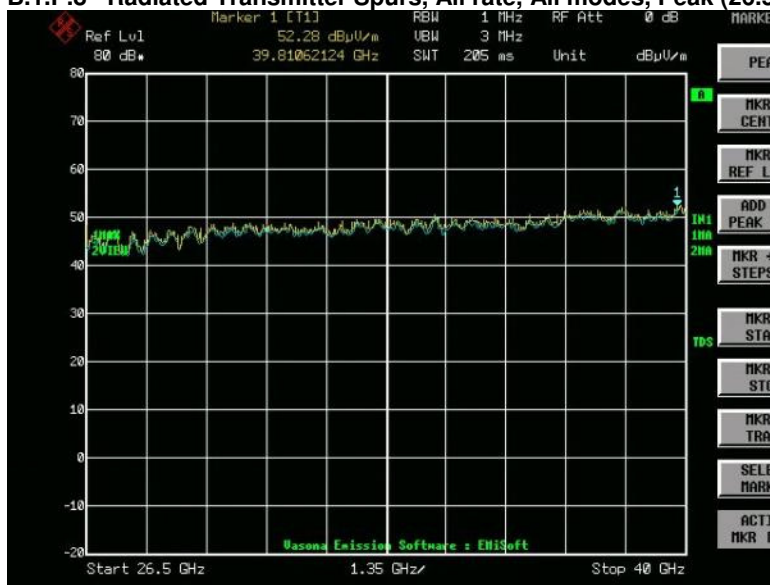

No emissions seen above 18GHz. The plots above are representative of all modes tested.

B.2 Receiver Spurious Emissions

RSS-Gen Receivers are required to comply with the limits of spurious emissions as set out in this section. Receiver emission measurements are to be performed as per the normative test method referenced in Section 3.

Radiated emissions which fall in the restricted bands, as defined in RSS-Gen section 8.10, must also comply with the radiated emission limits specified in RSS-Gen section 8.9.

For emissions at frequencies below 1 GHz, measurements shall be performed using a CISPR quasi-peak detector and the related measurement bandwidth. At frequencies above 1 GHz, measurements shall be performed using a linear average detector with a minimum resolution bandwidth of 1 MHz.

Ref. RSS-Gen section 8.9 & 8.10
ANSI C63.10: 2013 section 4.1.4.2.2, 4.1.4.2.3, 6.6.4 & 11.12.2

Using Vasona, configure the spectrum analyzer as shown below (be sure to enter all losses between the transmitter output and the spectrum analyzer). Place the radio in continuous transmit mode.

Span:	1GHz – 18 GHz
Reference Level:	80 dBuV
Attenuation:	10 dB
Sweep Time:	Coupled
Resolution Bandwidth:	1MHz
Video Bandwidth:	3MHz for Peak, 1 kHz for average
Detector:	Peak

Radiated emission measurements shall be performed with the receiver antenna connected to the receiver antenna terminals.

Maximize Turntable (find worst case table angle), Maximize Antenna (find worst case height)

Save plot: 1) Average Plot (Vertical and Horizontal), Limit= 54dBuV/m @3m
2) Peak Plot (Vertical and Horizontal), Limit= 74dBuV/m @3m

This report represents the worst case data for all supported operating modes and antennas. There are no measurable emissions above 18 GHz.

System Number	Description	Samples	System under test	Support equipment
1	EUT	S01	<input checked="" type="checkbox"/>	<input type="checkbox"/>
	Support	S02	<input type="checkbox"/>	<input checked="" type="checkbox"/>

Tested By : Jose Aguirre	Date of testing: 16-Dec-16 - 06-Feb-17
Test Result : PASS	

See Appendix C for list of test equipment

B.2.A Receiver Radiated Spurious Emissions (Average Measurements)

Average Radiated Receiver Spurs, All Rates, All Modes, (1-18GHz)



Radiated Receiver Spurs, All rate, All modes, Average (18-26.5GHz)

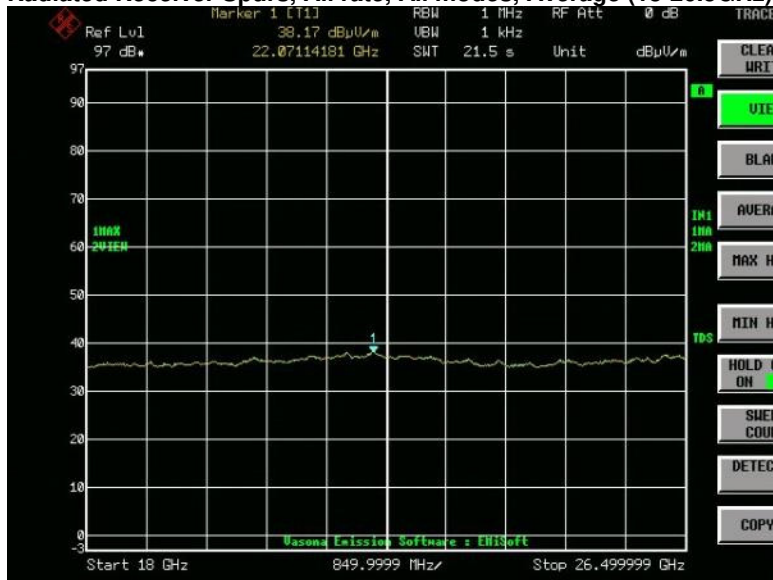

Radiated Receiver Spurs, All rate, All modes, Average (26.5-40GHz)

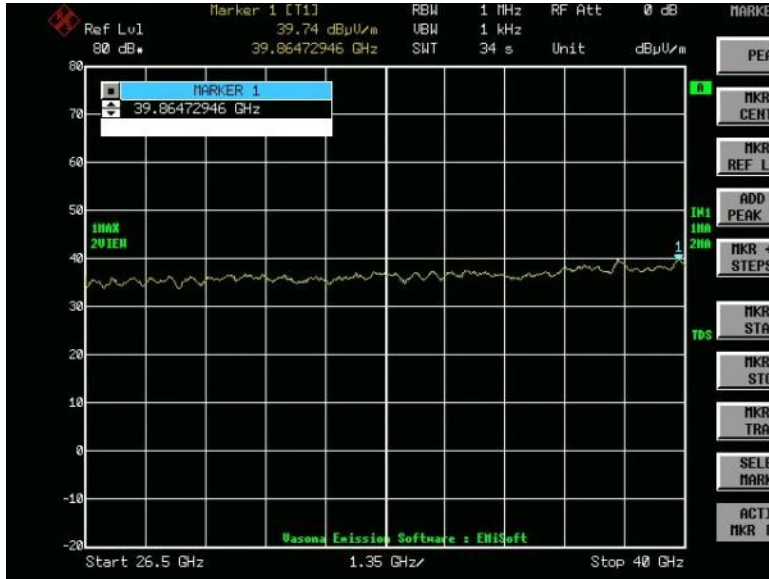

No emissions seen above 18GHz. The plots above are representative of all modes tested.

B.2.A Receiver Radiated Spurious Emissions (Peak Measurements)

Peak Radiated Receiver Spurs, All Rates, All Modes, (1-18GHz)

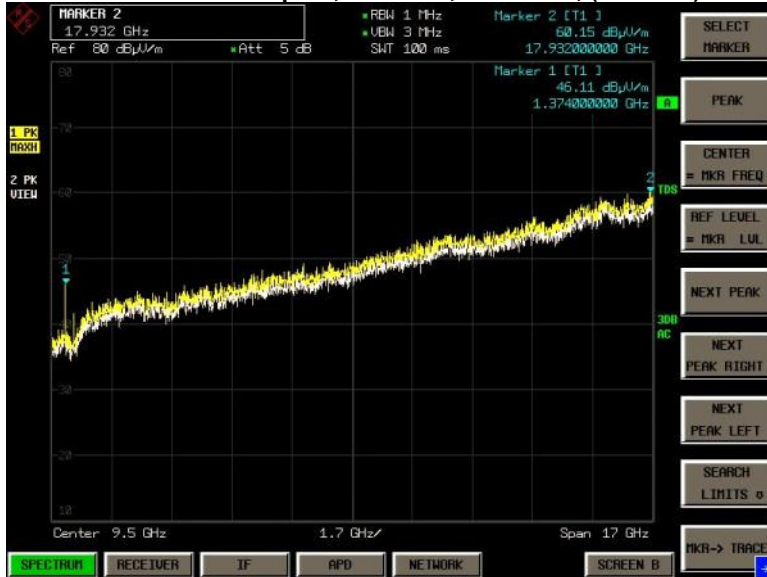

Radiated Receiver Spurs, All rate, All modes, Peak (18-26.5GHz)

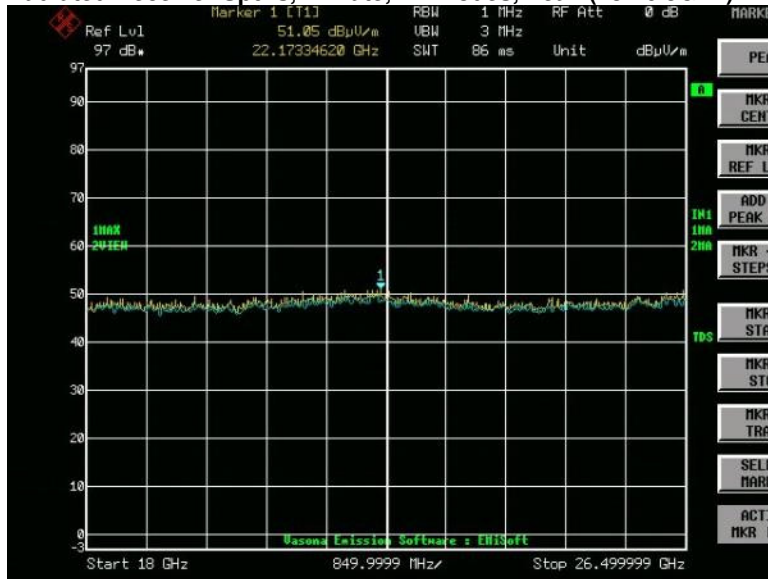

Radiated Receiver Spurs, All rate, All modes, Peak (26.5-40GHz)

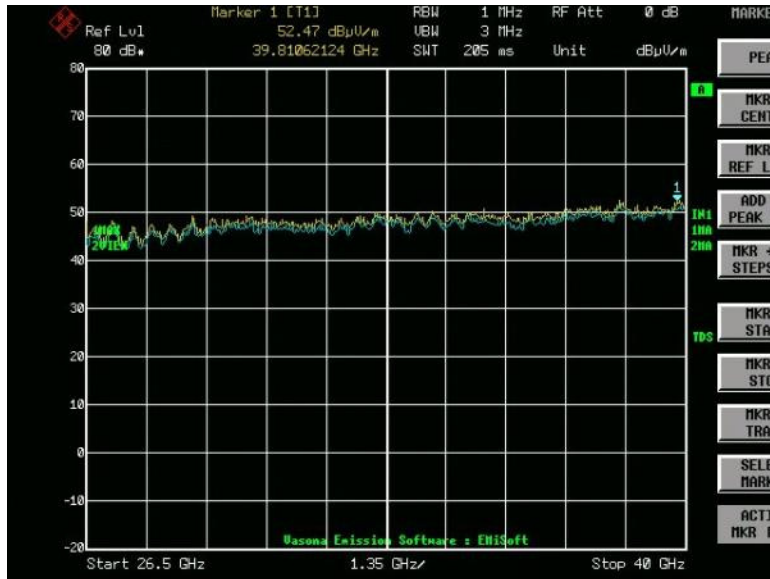

No emissions seen above 18GHz. The plots above are representative of all modes tested.

B.3 Radiated Emissions 30MHz to 1GHz

15.205 / 15.209 / RSS-Gen / LP0002:3.10.1(5)/2.8 Radiated emissions which fall in the restricted bands, as defined in Section 15.205(a), must also comply with the radiated emission limits specified in Section 15.209(a) (see Section 15.205(c)) and RSS-Gen section 8.9.

Ref. ANSI C63.10: 2013 section 6.5

Using Vasona, configure the spectrum analyzer as shown below (be sure to enter all losses between the transmitter output and the spectrum analyzer). Place the radio in continuous transmit mode.

Span:	30MHz – 1GHz
Reference Level:	80 dBuV
Attenuation:	10 dB
Sweep Time:	Coupled
Resolution Bandwidth:	100kHz
Video Bandwidth:	300kHz
Detector:	Peak for Pre-scan, Quasi-Peak

Compliance shall be determined using CISPR quasi-peak detection; however, peak detection is permitted as an alternative to quasi-peak detection.

Terminate the access Point RF ports with 50 ohm loads.

Maximize Turntable (find worst case table angle), Maximize Antenna (find worst case height)

This report represents the worst case data for all supported operating modes and antennas.

System Number	Description	Samples	System under test	Support equipment
1	EUT	S01	<input checked="" type="checkbox"/>	<input type="checkbox"/>
	Support	S02	<input type="checkbox"/>	<input checked="" type="checkbox"/>

Tested By : Jose Aguirre	Date of testing: 16-Dec-16 - 06-Feb-17
Test Result : PASS	

See Appendix C for list of test equipment



Graphical Test Results

Note that the data displayed on the plots detailed in this appendix were measured using a 'Peak Detector'. Please refer to the results table for the detectors used during formal measurements

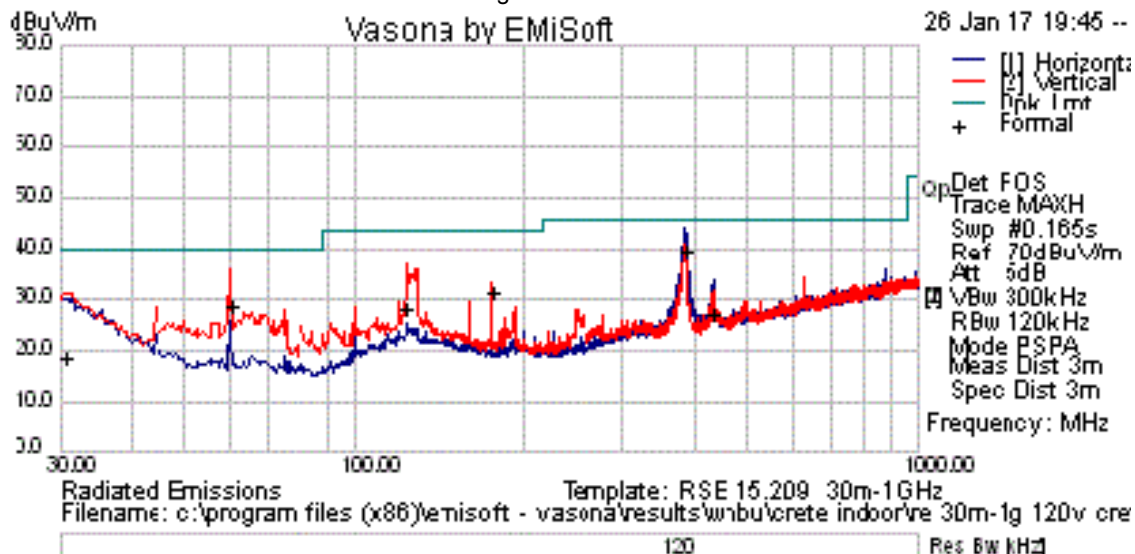

Test Results

Frequency MHz	Raw dBuV	Cable Loss	AF dB	Level dBuV/m	Measurement Type	Pol	Hgt cm	Azt Deg	Limit dBuV/m	Margin dB	Pass /Fail
385.505	23.1	1.6	15.1	39.8	Quasi Max	H	109	76	46	-6.2	Pass
59.998	20.6	0.7	7.4	28.6	Quasi Max	V	162	304	40	-11.4	Pass
123.12	13.1	0.9	14.1	28.1	Quasi Max	V	180	92	43.5	-15.4	Pass
30.485	-2.7	0.5	21	18.8	Quasi Max	V	308	352	40	-21.2	Pass
175.009	19.2	1.1	11.3	31.6	Quasi Max	V	134	245	43.5	-11.9	Pass
430.61	8.8	1.7	16.6	27.2	Quasi Max	H	265	272	46	-18.8	Pass

B.4 AC Conducted Emissions

FCC 15.207 (a) & RSS-Gen 8.8 / LP0002:2.3 Except when the requirements applicable to a given device state otherwise, for any radio apparatus equipped to operate from the public utility AC power supply, either directly or indirectly (such as with a battery charger), the radio frequency voltage of emissions conducted back onto the AC power lines in the frequency range of 0.15 MHz to 30 MHz shall not exceed the limits shown in the table in these sections. The more stringent limit applies at the frequency range boundaries.

Measurement Procedure

Accordance with ANSI C63.10:2013 section 6.2

Using Vasona, configure the spectrum analyzer as shown below (be sure to enter all losses between the transmitter output and the spectrum analyzer). Place the radio in continuous transmit mode.

Span:	150 KHz – 30 MHz
Attenuation:	10 dB
Sweep Time:	Coupled
Resolution Bandwidth:	9 KHz
Video Bandwidth:	30 KHz
Detector:	Quasi-Peak / Average

System Number	Description	Samples	System under test	Support equipment
1	EUT	S01	<input checked="" type="checkbox"/>	<input type="checkbox"/>
	Support	S02	<input type="checkbox"/>	<input checked="" type="checkbox"/>

Tested By : Jose Aguirre	Date of testing: 16-Dec-16 - 06-Feb-17
Test Result : PASS	

See separate EMC test report for test data.



Graphical Test Results

Note that the data displayed on the plots detailed in this appendix were measured using a 'Peak Detector'. Please refer to the results table for the detectors used during formal measurements

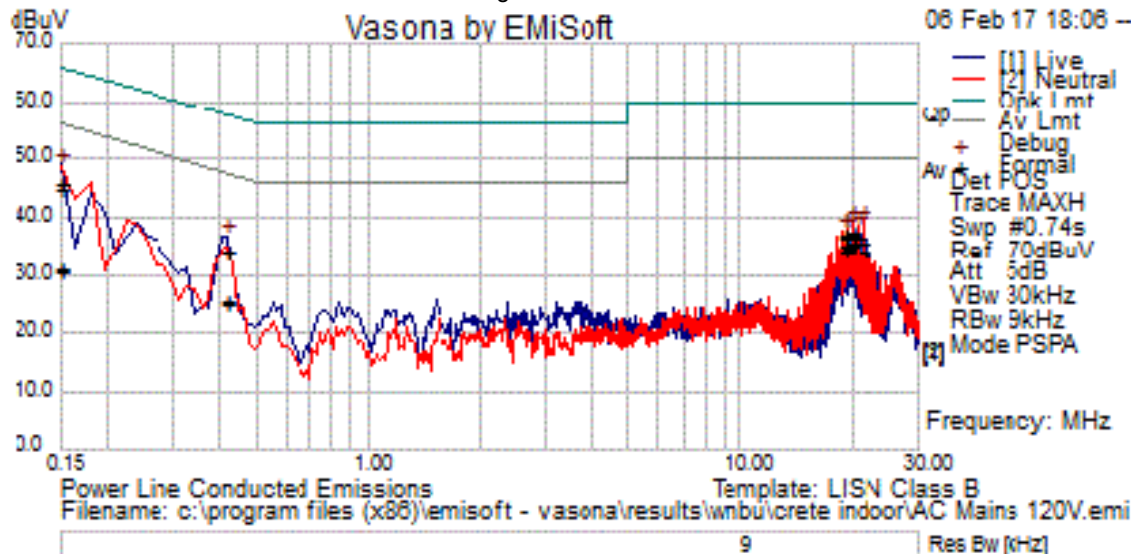

Test Results

Frequency MHz	Raw dBuV	Cable Loss	Factors dB	Level dBuV	Measurement Type	Line	Limit dBuV	Margin dB	Pass /Fail
0.417	14	20	0	34.1	Quasi Peak	Live	57.5	-23.5	Pass
0.15	24.9	21.1	0.1	46.1	Quasi Peak	Live	66	-19.9	Pass
21.295	15	20.4	0.3	35.7	Quasi Peak	Live	60	-24.3	Pass
20.594	16.3	20.4	0.3	37	Quasi Peak	Live	60	-23	Pass
19.89	17.2	20.4	0.3	37.9	Quasi Peak	Live	60	-22.1	Pass
19.189	16.2	20.4	0.2	36.8	Quasi Peak	Live	60	-23.2	Pass
18.72	16.5	20.4	0.2	37.1	Quasi Peak	Live	60	-22.9	Pass
21.295	15	20.4	0.3	35.7	Quasi Peak	Neutral	60	-24.3	Pass
0.15	24	21.1	0.1	45.2	Quasi Peak	Neutral	66	-20.8	Pass
19.189	16.2	20.4	0.2	36.8	Quasi Peak	Neutral	60	-23.2	Pass
0.417	14.3	20	0	34.4	Quasi Peak	Neutral	57.5	-23.1	Pass
20.594	16.2	20.4	0.3	36.9	Quasi Peak	Neutral	60	-23.1	Pass
18.72	16.3	20.4	0.2	36.9	Quasi Peak	Neutral	60	-23.1	Pass
19.89	16.4	20.4	0.3	37.1	Quasi Peak	Neutral	60	-22.9	Pass
0.417	5.3	20	0	25.3	Average	Live	47.5	-22.2	Pass
0.15	10.2	21.1	0.1	31.3	Average	Live	56	-24.7	Pass
21.295	13.9	20.4	0.3	34.6	Average	Live	50	-15.4	Pass
20.594	15.2	20.4	0.3	35.9	Average	Live	50	-14.1	Pass
19.89	15.4	20.4	0.3	36	Average	Live	50	-14	Pass
19.189	14.4	20.4	0.2	35	Average	Live	50	-15	Pass
18.72	14.7	20.4	0.2	35.3	Average	Live	50	-14.7	Pass
21.295	13.9	20.4	0.3	34.6	Average	Neutral	50	-15.4	Pass
0.15	9.6	21.1	0.1	30.7	Average	Neutral	56	-25.3	Pass
19.189	14.2	20.4	0.2	34.8	Average	Neutral	50	-15.2	Pass
0.417	5.5	20	0	25.6	Average	Neutral	47.5	-21.9	Pass
20.594	15.2	20.4	0.3	35.9	Average	Neutral	50	-14.1	Pass
18.72	14	20.4	0.2	34.6	Average	Neutral	50	-15.4	Pass
19.89	14.7	20.4	0.3	35.3	Average	Neutral	50	-14.7	Pass

Photographs of setup**Title: Conducted Test Setup**

This is a dual band 2.4GHz / 5GHz device. All ports in this test set up photo are connected as all testing is automated. Section 2.6 of this test report given an overview of the different Tx antenna combinations used by this device.

AIR-AP1815M-x-K9 AC Mains Conducted Emissions setup



AIR-AP1815M-x-K9 Radiated Emissions setup 30MHz – 1GHz

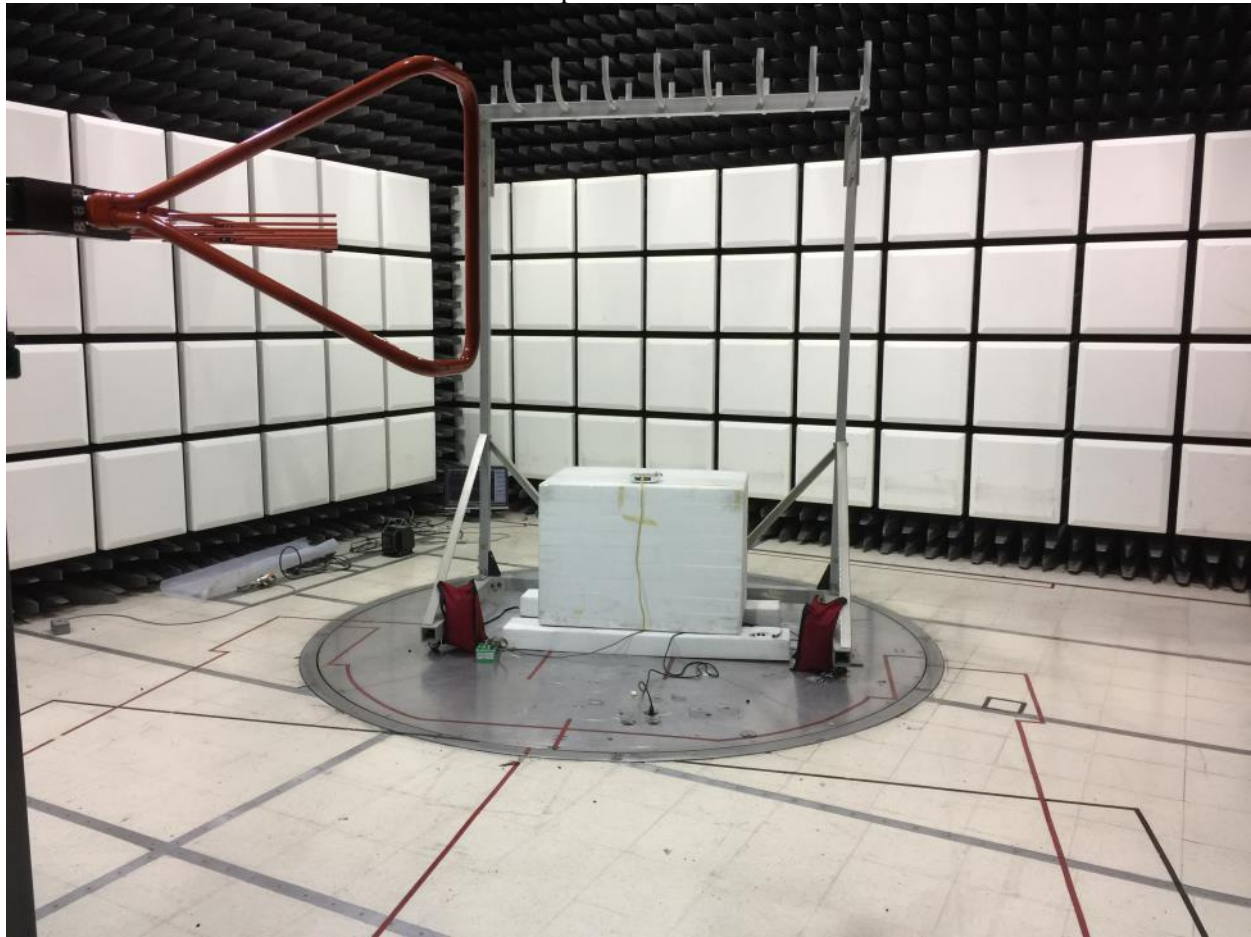

AIR-AP1815M-x-K9 Radiated Emissions setup above 1GHz

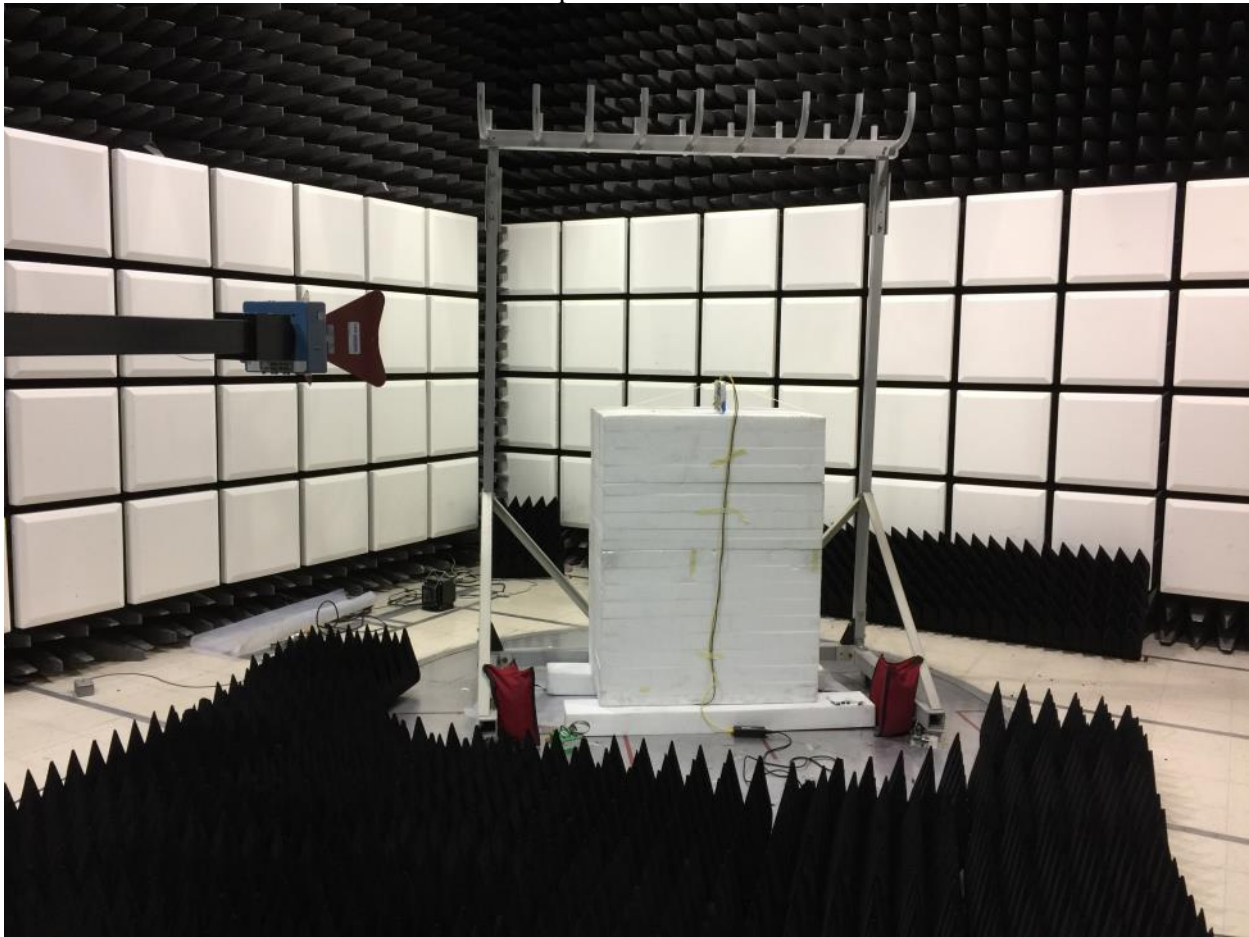

Appendix C: List of Test Equipment Used to perform the test

Test Equipment used for Radiated Emissions					
Equip No	Model Manufacturer	Description	Last Cal	Next Cal	Test Item
CIS041929	iBTHP-5-DB9 Newport	5 inch Temp/RH/Press Sensor w/20ft cable	22-Dec-16	22-Dec-17	B.1, B.2, B.3
CIS001937	NSA 5m Chamber Cisco	NSA 5m Chamber	12-Feb-16	12-Feb-17	B.3
CIS049535	Above 1GHz Site Cal Cisco	Above 1GHz CISPR Site Validation	13-Feb-16	13-Feb-17	B.1, B.2
CIS028072	1840 Cisco	18-40GHz EMI Test Head	22-Feb-16	22-Feb-17	B.1, B.2
CIS045588	JB1 Sunol Sciences	Combination Antenna, 30MHz-2GHz	9-Mar-16	9-Mar-17	B.3
CIS042000	E4440A Agilent	Spectrum Analyzer	6-Jul-16	6-Jul-17	B.1, B.2
CIS037581	3117 ETS-Lindgren	Horn Antenna	7-Oct-16	7-Oct-17	B.1, B.2
CIS045098	TH0118 Cisco	Mast Mount Preamplifier Array, 1-18GHz	31-Oct-16	31-Oct-17	B.1, B.2
CIS033602	CSY-NMNM-80-273001 Midwest Microwave	RF Coaxial Cable, to 18GHz	8-Nov-16	8-Nov-17	B.1, B.2, B.3
CIS030443	UFB311A-0-1560-520520 Micro-Coax	RF Coaxial Cable, to 18GHz	8-Nov-16	8-Nov-17	B.1, B.2, B.3
CIS008024	SF106A Huber + Suhner	3 meter Sucoflex cable	8-Nov-16	8-Nov-17	B.1, B.2, B.3
CIS024201	FSEK30 Rohde & Schwarz	Spectrum Analyzer 20Hz - 40GHz	23-Nov-16	23-Nov-17	B.1, B.2
CIS037235	50CB-015 JFW	GPIB Control Box	Cal not Required	Cal not Required	B.1, B.2
CIS035244	926-8ME Klein Tools	8 Meter Tape Measure	Cal not Required	Cal not Required	B.1, B.2, B.3
CIS043124	Above 1GHz Site Cal Cisco	Above 1GHz Cispr Site Verification	14-Jan-16	14-Jan-17	B.1, B.2
CIS047300	N9038A Agilent Technologies	MXE EMI Receiver 20Hz to 26.5 Ghz	28-Jan-16	28-Jan-17	B.1, B.2, B.3
CIS030559	UFB311A-1-0950-504504 Micro-Coax	RF Coaxial Cable, to 18GHz, 95 in	15-Feb-16	15-Feb-17	B.1, B.2, B.3
CIS020975	UFB311A-0-1344-520520 Micro-Coax	RF Coaxial Cable, to 18GHz, 134.4 in	17-Feb-16	17-Feb-17	B.1, B.2, B.3
CIS019630	ESI 40(ESIB 40) Rohde & Schwarz	EMI Test Receiver, 20Hz - 40GHz	22-Feb-16	22-Feb-17	B.1, B.2
CIS008447	NSA 10m Chamber Cisco	NSA 10m Chamber	14-Oct-16	14-Oct-17	B.3
CIS036710	1840 Cisco	18-40GHz EMI Test Head/Verification Fixture	17-Nov-16	17-Nov-17	B.1, B.2
CIS030652	JB1 Sunol Sciences	Combination Antenna, 30MHz-2GHz	16-Dec-16	16-Dec-17	B.3

Test Equipment used for AC Mains Conducted Emissions					
Equip No	Model Manufacturer	Description	Last Cal	Next Cal	Test Item
CIS051642	Sucoflex 106PA Huber+Suhner	RF N Type Cable 8.5m	11-Feb-16	11-Feb-17	B.4
CIS030559	UFB311A-1-0950-504504 Micro-Coax	RF Coaxial Cable, to 18GHz, 95 in	15-Feb-16	15-Feb-17	B.4
CIS020975	UFB311A-0-1344-520520 Micro-Coax	RF Coaxial Cable, to 18GHz, 134.4 in	17-Feb-16	17-Feb-17	B.4
CIS046717	5-T-MB Bird	5W 50 Ohm BNC Termination 4GHz	9-Mar-16	9-Mar-17	B.4
CIS008510	FCC-450B-2.4-N Fischer Custom Communications	Instrumentation Limiter	16-May-16	16-May-17	B.4
CIS023796	FCC-LISN-PA-520R Fischer Custom Communications	POWER ADAPTOR, POLARIZED 120VAC	27-Jul-16	27-Jul-17	B.4
CIS023794	FCC-LISN-50/250-50-2-02 Fischer Custom Communications	LISN	27-Jul-16	27-Jul-17	B.4
CIS019206	H785-150K-50-21378 TTE	High Pas Filter, Fo=150kHz	13-Sep-16	13-Sep-17	B.4
CIS005687	73 III Fluke	Digital Multimeter	3-Nov-16	3-Nov-17	B.4
CIS041929	iBTHP-5-DB9 Newport	5 inch Temp/RH/Press Sensor w/20ft cable	22-Dec-16	22-Dec-17	B.4
CIS054645	33-428 Stanley	Tape measure 8 meter	Cal Not Required	Cal Not Required	B.4

Test Equipment used for RF Conducted Tests					
Equip No	Model Manufacturer	Description	Last Cal	Next Cal	Test Item
CIS049445	BRC50704-02 Micro-Tronics	Notch Filter, SB:5.470-5.725GHz, to 12GHz	12-Apr-16	12-Apr-17	A1 thru A6
CIS035038	BRC50703-02 Micro-Tronics	Notch Filter, SB:5.150-5.350GHz, to 11GHz	6-Jul-16	6-Jul-17	A1 thru A6
CIS055561	F120-S1S1-48 MegaPhase	SMA Cable 48"	15-Jul-16	15-Jul-17	A1 thru A6
CIS054635	F120-S1S1-48 Megaphase	SMA cable 48"	15-Jul-16	15-Jul-17	A1 thru A6
CIS055588	BWS30-W2 Aeroflex	SMA 30dB Attenuator	21-Jul-16	21-Jul-17	A1 thru A6
CIS055578	BWS20-W2 Aeroflex	SMA 20dB Attenuator	21-Jul-16	21-Jul-17	A1 thru A6
CIS054656	BRC50705-02 Micro-Tronics	Band Reject Filter	19-Sep-16	19-Sep-17	A1 thru A6
CIS054653	BRM50702-02 Micro-Tronics	Notch Filter, SB:2.400-2.500GHz, to 18GHz	19-Sep-16	19-Sep-17	A1 thru A6
CIS055858	SMSM-A2PH-012 Dynawave	12" SMA Cable	29-Sep-16	29-Sep-17	A1 thru A6
CIS055856	SMSM-A2PH-012 Dynawave	12" SMA Cable	29-Sep-16	29-Sep-17	A1 thru A6
CIS055849	SMSM-A2PH-012 Dynawave	12" SMA Cable	29-Sep-16	29-Sep-17	A1 thru A6
CIS055848	SMSM-A2PH-012 Dynawave	12" SMA Cable	29-Sep-16	29-Sep-17	A1 thru A6
CIS055847	SMSM-A2PH-012 Dynawave	12" SMA Cable	29-Sep-16	29-Sep-17	A1 thru A6
CIS055846	SMSM-A2PH-012 Dynawave	12" SMA Cable	29-Sep-16	29-Sep-17	A1 thru A6

CIS055845	SMSM-A2PH-012 Dynawave	12" SMA Cable	29-Sep-16	29-Sep-17	A1 thru A6
CIS055844	SMSM-A2PH-012 Dynawave	12" SMA Cable	29-Sep-16	29-Sep-17	A1 thru A6
CIS055843	SMSM-A2PH-012 Dynawave	12" SMA Cable	29-Sep-16	29-Sep-17	A1 thru A6
CIS055842	SMSM-A2PH-012 Dynawave	12" SMA cable	29-Sep-16	29-Sep-17	A1 thru A6
CIS055874	SMSM-A2PH-024 Dynawave	24" SMA Cable	7-Oct-16	7-Oct-17	A1 thru A6
CIS055872	SMSM-A2PH-024 Dynawave	24" SMA Cable	7-Oct-16	7-Oct-17	A1 thru A6
CIS055868	SMSM-A2PH-024 Dynawave	24" SMA Cable	7-Oct-16	7-Oct-17	A1 thru A6
CIS055867	SMSM-A2PH-024 Dynawave	24" SMA Cable	7-Oct-16	7-Oct-17	A1 thru A6
CIS055885	SMSM-A2PH-018 Dynawave	18" SMA Cable	10-Oct-16	10-Oct-17	A1 thru A6
CIS055170	RFLT4WDC40GK RF Lambda	4 Way Power Divider 40GHz	29-Nov-16	29-Nov-17	A1 thru A6
CIS050721	N9030A Keysight	PXA Signal Analyzer	30-Mar-16	30-Mar-17	A1 thru A6
CIS054303	N5182B Keysight	MXG X-Series RF Vector Signal Generator	6-Apr-16	6-Apr-17	A1 thru A6
CIS055099	SMART2200RM2U Tripp-Lite	Power Supply	Cal Not Required	Cal Not Required	A1 thru A6
CIS055094	PXI-1042 National Instruments	Chassis	Cal Not Required	Cal Not Required	A1 thru A6

Appendix E: Abbreviation Key and Definitions

The following table defines abbreviations used within this test report.

Abbreviation	Description	Abbreviation	Description
EMC	Electro Magnetic Compatibility	°F	Degrees Fahrenheit
EMI	Electro Magnetic Interference	°C	Degrees Celsius
EUT	Equipment Under Test	Temp	Temperature
ITE	Information Technology Equipment	S/N	Serial Number
TAP	Test Assessment Schedule	Qty	Quantity
ESD	Electro Static Discharge	emf	Electromotive force
EFT	Electric Fast Transient	RMS	Root mean square
EDCS	Engineering Document Control System	Qp	Quasi Peak
Config	Configuration	Av	Average
CIS#	Cisco Number (unique identification number for Cisco test equipment)	Pk	Peak
Cal	Calibration	kHz	Kilohertz (1×10^3)
EN	European Norm	MHz	MegaHertz (1×10^6)
IEC	International Electro technical Commission	GHz	Gigahertz (1×10^9)
CISPR	International Special Committee on Radio Interference	H	Horizontal
CDN	Coupling/Decoupling Network	V	Vertical
LISN	Line Impedance Stabilization Network	dB	decibel
PE	Protective Earth	V	Volt
GND	Ground	kV	Kilovolt (1×10^3)
L1	Line 1	μ V	Microvolt (1×10^{-6})
L2	Line2	A	Amp
L3	Line 3	μ A	Micro Amp (1×10^{-6})
DC	Direct Current	mS	Milli Second (1×10^{-3})
RAW	Uncorrected measurement value, as indicated by the measuring device	μ S	Micro Second (1×10^{-6})
RF	Radio Frequency	μ S	Micro Second (1×10^{-6})
SLCE	Signal Line Conducted Emissions	m	Meter
Meas dist	Measurement distance	Spec dist	Specification distance
N/A or NA	Not Applicable	SL	Signal Line (or Telecom Line)
P	Power Line	L	Live Line
N	Neutral Line	R	Return
S	Supply	AC	Alternating Current

End