



Test Report
AIR-AP1542D-B-K9
AIR-AP1542I-B-K9

Cisco Aironet 802.11ac Dual Band Access Points

FCC ID: LDK102109P

5250-5350 MHz

Against the following Specifications:

CFR47 Part 15.407



Cisco Systems

170 West Tasman Drive

San Jose, CA 95134

	
Author: Jose Aguirre Tested By: Jose Aguirre	Approved By: Jim Nicholson Title: Technical Leader, Engineering Revision: 2

This report replaces any previously entered test report under EDCS – **11569238**. This test report has been electronically authorized and archived using the CISCO Engineering Document Control system.



This test report has been electronically authorized and archived using the CISCO Engineering Document Control system.

SECTION 1: OVERVIEW	4
SECTION 2: ASSESSMENT INFORMATION	5
2.1 GENERAL	5
2.2 DATE OF TESTING.....	7
2.3 REPORT ISSUE DATE	7
2.4 TESTING FACILITIES	7
2.5 EQUIPMENT ASSESSED (EUT).....	7
2.6 EUT DESCRIPTION.....	8
SECTION 3: RESULT SUMMARY	9
3.1 RESULTS SUMMARY TABLE	9
SECTION 4: SAMPLE DETAILS.....	11
4.1 SAMPLE DETAILS	11
4.2 SYSTEM DETAILS	11
4.3 MODE OF OPERATION DETAILS.....	11
APPENDIX A: EMISSION TEST RESULTS	12
CONDUCTED TEST SETUP DIAGRAM.....	12
TARGET MAXIMUM CHANNEL POWER	12
Antenna Gain: 5 (0) dBi.....	12
Antenna Gain: 9 (1) dBi.....	13
A.1 99% AND 26DB BANDWIDTH	14
A.2 MAXIMUM CONDUCTED OUTPUT POWER/ POWER SPECTRAL DENSITY	17
Antenna Gain: 5 (0) dBi.....	19
Antenna Gain: 9 (1) dBi.....	22
Antenna Gain: 5 (0) dBi.....	25
Antenna Gain: 9 (1) dBi.....	28
A.3 CONDUCTED SPURIOUS EMISSIONS	31
Antenna Gain: 5 (0) dBi.....	33
Antenna Gain: 9 (1) dBi.....	36
Antenna Gain: 5 (0) dBi.....	39
Antenna Gain: 9 (1) dBi.....	42
A.4 CONDUCTED BANDEDGE.....	45
Antenna Gain: 5 (0) dBi.....	46
Antenna Gain: 9 (1) dBi.....	48
Antenna Gain: 5 (0) dBi.....	50
Antenna Gain: 9 (1) dBi.....	52
APPENDIX B: EMISSION TEST RESULTS	54
RADIATED EMISSION SETUP DIAGRAM-BELOW 1G.....	54
B.1 RADIATED SPURIOUS EMISSIONS	55
B.2 RADIATED EMISSIONS 30MHZ TO 1GHZ	66
B.3 AC CONDUCTED EMISSIONS	68



APPENDIX C: LIST OF TEST EQUIPMENT USED TO PERFORM THE TEST74
APPENDIX E: ABBREVIATION KEY AND DEFINITIONS77



Section 1: Overview

The samples were assessed against the tests detailed in section 3 under the requirements of the following specifications:

Specifications:
CFR47 Part 15.407

Measurements were made in accordance with

- ANSI C63.10:2013
- KDB 789033 D02 General UNII Test Procedures New Rules v01r03
- KDB 662911 D01 Multiple Transmitter Output v02r01



Section 2: Assessment Information

2.1 General

This report contains an assessment of an apparatus against Electromagnetic Compatibility Standards based upon tests carried out on the samples submitted. The testing was performed by and for the use of Cisco systems Inc:

With regard to this assessment, the following points should be noted:

- a) The results contained in this report relate only to the items tested and were obtained in the period between the date of the initial assessment and the date of issue of the report. Manufactured products will not necessarily give identical results due to production and measurement tolerances.
- b) The apparatus was set up and exercised using the configuration and modes of operation defined in this report only.
- c) Where relevant, the apparatus was only assessed using the susceptibility criteria defined in this report and the Test Assessment Plan (TAP).
- d) All testing was performed under the following environmental conditions:

Temperature	15°C to 35°C (54°F to 95°F)
Atmospheric Pressure	860mbar to 1060mbar (25.4" to 31.3")
Humidity	10% to 75*%
- e) All AC testing was performed at one or more of the following supply voltages:

110V 60 Hz (+/-20%)

Units of Measurement

The units of measurements defined in the appendices are reported in specific terms, which are test dependent. Where radiated measurements are concerned these are defined at a particular distance. Basic voltage measurements are defined in units of [dBuV]

As an example, the basic calculation for all measurements is as follows:

$$\text{Emission level [dBuV]} = \text{Indicated voltage level [dBuV]} + \text{Cable Loss [dB]} + \text{Other correction factors [dB]}$$

The combinations of correction factors are dependent upon the exact test configurations [see test equipment lists for further details] and may include:-

Antenna Factors, Pre Amplifier Gain, LISN Loss, Pulse Limiter Loss and Filter Insertion Loss

Note: to convert the results from dBuV/m to uV/m use the following formula:-

$$\text{Level in uV/m} = \text{Common Antilogarithm} [(X \text{ dBuV/m})/20] = Y \text{ uV/m}$$



Measurement Uncertainty Values

voltage and power measurements	± 2 dB
conducted EIRP measurements	± 1.4 dB
radiated measurements	± 3.2 dB
frequency measurements	± 2.4 10 ⁻⁷
temperature measurements	± 0.54°
humidity measurements	± 2.3%
DC and low frequency measurements	± 2.5%

Where relevant measurement uncertainty levels have been estimated for tests performed on the apparatus. This uncertainty represents an expanded uncertainty expressed at approximately the 95% confidence level using a coverage factor of k=2.

Radiated emissions (expanded uncertainty, confidence interval 95%)

30 MHz - 300 MHz	+/- 3.8 dB
300 MHz - 1000 MHz	+/- 4.3 dB
1 GHz - 10 GHz	+/- 4.0 dB
10 GHz - 18GHz	+/- 8.2 dB
18GHz - 26.5GHz	+/- 4.1 dB
26.5GHz - 40GHz	+/- 3.9 dB

Conducted emissions (expanded uncertainty, confidence interval 95%)

30 MHz – 40GHz	+/- 0.38 dB
----------------	-------------

A product is considered to comply with a requirement if the nominal measured value is below the limit line. The product is considered to not be in compliance in case the nominal measured value is above the limit line.

This report must not be reproduced except in full, without written approval of Cisco Systems.

**2.2 Date of testing**

21-Jan-17 - 06-Feb-17

2.3 Report Issue Date

14-Feb-17

Cisco uses an electronic system to issue, store and control the revision of test reports. This system is called the Engineering Document Control System (EDCS). The actual report issue date is embedded into the original file on EDCS. Any copies of this report, either electronic or paper, that are not on EDCS must be considered uncontrolled.

2.4 Testing facilities

This assessment was performed by:

Testing Laboratory

Cisco Systems, Inc.,
125 West Tasman Drive
San Jose, CA 95134, USA

Registration Numbers for Industry Canada

Cisco System Site	Address	Site Identifier
Building P, 10m Chamber	125 West Tasman Dr San Jose, CA 95134	Company #: 2461N-2
Building P, 5m Chamber	125 West Tasman Dr San Jose, CA 95134	Company #: 2461N-1
Building I, 5m Chamber	285 W. Tasman Drive San Jose, California 95134	Company #: 2461M-1

Test Engineers

Jose Aguirre

2.5 Equipment Assessed (EUT)

AIR-AP1542D-B-K9



2.6 EUT Description

The Cisco Aironet 802.11ac Radio supports the following modes of operation. The modes are further defined in the radio Theory of Operation. The modes included in this report represent the worst case data for all modes.

- 802.11a - Non HT20, One Antenna, 6 to 54 Mbps, 1ss
- 802.11a - Non HT20, Two Antennas, 6 to 54 Mbps, 1ss

- 802.11a - Non HT20 Beam Forming, Two Antennas, 6 to 54 Mbps, 1ss

- 802.11n/ac - HT/VHT20, One Antenna, M0 to M7, 1ss
- 802.11n/ac - HT/VHT20, Two Antennas, M0 to M7, 1ss
- 802.11n/ac - HT/VHT20, Two Antennas, M8 to M15, 2ss

- 802.11n/ac - HT/VHT20 Beam Forming, Two Antennas, M0 to M7, 1ss
- 802.11n/ac - HT/VHT20 Beam Forming, Two Antennas, M8 to M15, 2ss

- 802.11n/ac - HT/VHT20 STBC, Two Antennas, M0 to M7, 2ss

- 802.11a - Non HT40, One Antenna, 6 to 54 Mbps, 1ss
- 802.11a - Non HT40, Two Antennas, 6 to 54 Mbps, 1ss

- 802.11n/ac - HT/VHT40, One Antenna, M0 to M7, 1ss
- 802.11n/ac - HT/VHT40, Two Antennas, M0 to M7, 1ss
- 802.11n/ac - HT/VHT40, Two Antennas, M8 to M15, 2ss

- 802.11n/ac - HT/VHT40 Beam Forming, Two Antennas, M0 to M7, 1ss
- 802.11n/ac - HT/VHT40 Beam Forming, Two Antennas, M8 to M15, 2ss

- 802.11n/ac - HT/VHT40 STBC, Two Antennas, M0 to M7, 2ss

- 802.11a - Non HT80, One Antenna, 6 to 54 Mbps, 1ss
- 802.11a - Non HT80, Two Antennas, 6 to 54 Mbps, 1ss

- 802.11ac - VHT80, One Antenna, M0 to M9 1ss
- 802.11ac - VHT80, Two Antennas, M0 to M9 1ss
- 802.11ac - VHT80, Two Antennas, M0 to M9 2ss

- 802.11ac - VHT80 Beam Forming, Two Antennas, M0 to M9 1ss
- 802.11ac - VHT80 Beam Forming, Two Antennas, M0 to M9 2ss

- 802.11ac - VHT80 STBC, Two Antennas, M0 to M9 2ss

The following antennas are supported by this product series.
The data included in this report represent the worst case data for all antennas.

Frequency	Part Number	Antenna Type	Antenna Gain (dBi)	>30 degree 5 GHz Antenna Gain (dBi)
2.4/5 GHz	Internal	BT/BLE	3 / NA	NA
	Internal	Sector (I)	5 / 5	0
	Internal	Directional (D)	8 / 9	1

Section 3: Result Summary

3.1 Results Summary Table

Conducted emissions

Basic Standard	Technical Requirements / Details	Result
FCC 15.407	<p>99% & 26 dB Bandwidth: The 99% occupied bandwidth is the frequency bandwidth such that, below its lower and above its upper frequency limits, the mean powers are each equal to 0.5% of the total mean power of the given emission. There is no limit for 99% OBW.</p> <p>The 26 dB emission is the width of the emission that is constrained by the frequencies associated with the two outermost amplitude points (upper and lower frequencies) that are attenuated by 26 dB relative to the maximum level measured in the fundamental emission.</p>	Pass
FCC 15.407	<p>Output Power: For the 5.25-5.35 GHz and 5.47-5.725 GHz bands, the maximum conducted output power over the frequency bands of operation shall not exceed the lesser of 250 mW or 11 dBm + 10 log B, where B is the 26 dB emission bandwidth in megahertz. If transmitting antennas of directional gain greater than 6 dBi are used, both the maximum conducted output power and the maximum power spectral density shall be reduced by the amount in dB that the directional gain of the antenna exceeds 6 dBi.</p>	Pass
FCC 15.407	<p>Power Spectral Density: The maximum power spectral density shall not exceed 11 dBm in any 1 megahertz band. If transmitting antennas of directional gain greater than 6 dBi are used, both the maximum conducted output power and the maximum power spectral density shall be reduced by the amount in dB that the directional gain of the antenna exceeds 6 dBi.</p>	Pass
FCC 15.407	<p>Conducted Spurious Emissions / Band-Edge: For transmitters operating in the 5.25-5.35 GHz band: all emissions outside of the 5.15-5.35 GHz band shall not exceed an EIRP of -27dBm/MHz.</p>	Pass
FCC 15.407 FCC 15.209 FCC 15.205	<p>Restricted band: Unwanted emissions must comply with the general field strength set forth in FCC 15.209.</p>	Pass

**Radiated Emissions (General requirements)**

Basic Standard	Technical Requirements / Details	Result
FCC 15.407 FCC 15.209 FCC 15.205	TX Spurious Emissions: Except as provided elsewhere in this subpart, the emissions from an intentional radiator shall not exceed the field strength levels specified in the filed strength limits table in this section.	Pass
FCC 15.207	AC conducted Emissions: Except when the requirements applicable to a given device state otherwise, for any radio apparatus equipped to operate from the public utility AC power supply, either directly or indirectly (such as with a battery charger), the radio frequency voltage of emissions conducted back onto the AC power lines in the frequency range of 0.15 MHz to 30 MHz shall not exceed the limits shown in the table in these sections. The more stringent limit applies at the frequency range boundaries.	Pass

* MPE calculation is recorded in a separate report



Section 4: Sample Details

Note: Each sample was evaluated to ensure that its condition was suitable to be used as a test sample prior to the commencement of testing.

4.1 Sample Details

Sample No.	Equipment Details	Manufacturer	Hardware Rev.	Firmware Rev.	Software Rev.	Serial Number
S01	AIR-AP1542D-B-K9	Cisco Systems	P2	28bb3ae8 d7576e23 8bd6a752 bdc8dc74	8.4.1.10	FOC20387WJ5
S02*	AIR-PWRINJ6	Cisco Systems	V01	NA	NA	C15456663000 0247

(*) S02 are support equipment Power supplies for EUT S01

4.2 System Details

System #	Description	Samples
1	AIR-AP1542D-B-K9	S01
2	AIR-PWRINJ6	S02

4.3 Mode of Operation Details

Mode#	Description	Comments
1	Continuous Transmitting	Continuous Transmitting $\geq 98\%$ duty cycle

All measurements were made in accordance with

- ANSI C63.10:2013
- KDB 789033 D02 General UNII Test Procedures New Rules v01r03
- KDB 662911 D01 Multiple Transmitter Output v02r01

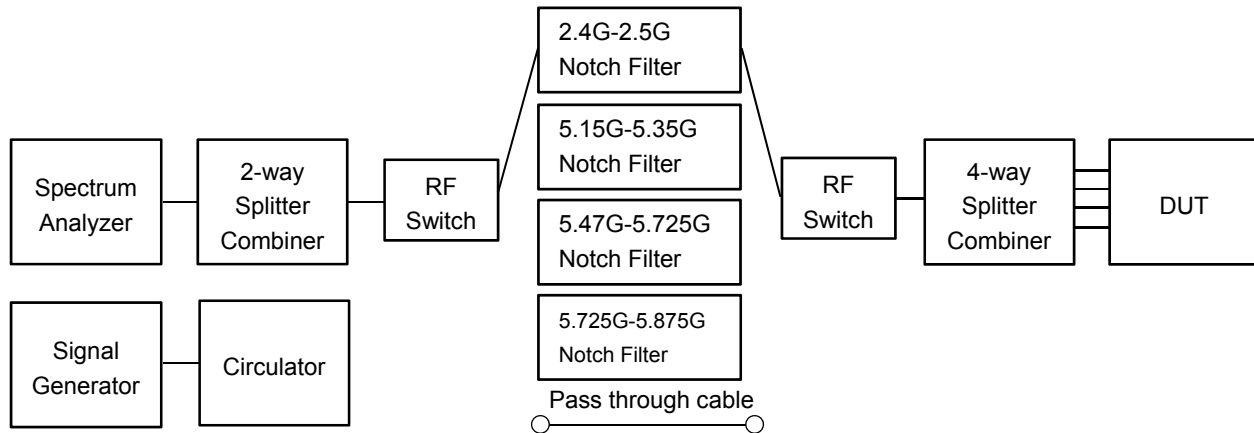
Appendix A: Emission Test Results**Conducted Test Setup Diagram****Target Maximum Channel Power**

The following table details the maximum supported Total Channel Power for all operating modes.

Antenna Gain: 5 (0) dBi

Operating Mode	Maximum Channel Power (dBm)			
	Frequency (MHz)			
	5260	5300	5320	
Non HT20, 6 to 54 Mbps	22	21	20	
Non HT20 Beam Forming, 6 to 54 Mbps	18	19	20	
HT/VHT20, M0 to M15	22	22	22	
HT/VHT20 Beam Forming, M0 to M15	21	21	22	
HT/VHT20 STBC, M0 to M7	21	21	22	
	5270	5310		
Non HT40, 6 to 54 Mbps	22	18		
HT/VHT40, M0 to M15	24	20		
HT/VHT40 Beam Forming, M0 to M15	24	20		
HT/VHT40 STBC, M0 to M7	24	20		
	5290			
Non HT80, 6 to 54 Mbps	18			
VHT80, M0 to M9, M0 to M9 1-1ss	19			
VHT80 Beam Forming, M0 to M9, M0 to M9 1-1ss	19			
VHT80 STBC, M0 to M9 1ss	19			

**Antenna Gain: 9 (1) dBi**

Operating Mode	Maximum Channel Power (dBm)			
	Frequency (MHz)			
	5260	5300	5320	
Non HT20, 6 to 54 Mbps	19	18	18	
Non HT20 Beam Forming, 6 to 54 Mbps	15	15	15	
HT/VHT20, M0 to M15	19	18	19	
HT/VHT20 Beam Forming, M0 to M15	19	18	19	
HT/VHT20 STBC, M0 to M7	19	18	19	
	5270	5310		
Non HT40, 6 to 54 Mbps	20	15		
HT/VHT40, M0 to M15	21	18		
HT/VHT40 Beam Forming, M0 to M15	21	18		
HT/VHT40 STBC, M0 to M7	21	18		
	5290			
Non HT80, 6 to 54 Mbps	15			
VHT80, M0 to M9, M0 to M9 1-1ss	15			
VHT80 Beam Forming, M0 to M9, M0 to M9 1-1ss	15			
VHT80 STBC, M0 to M9 1ss	15			



A.1 99% and 26dB Bandwidth

FCC 15.407 The 99% occupied bandwidth is the frequency bandwidth such that, below its lower and above its upper frequency limits, the mean powers are each equal to 0.5% of the total mean power of the given emission. There is no limit for 99% OBW.

The 26 dB emission is the width of the emission that is constrained by the frequencies associated with the two outermost amplitude points (upper and lower frequencies) that are attenuated by 26 dB relative to the maximum level measured in the fundamental emission.

Test Procedure

Ref. ANSI C63.10: 2013 Section 6.9.3

99% BW and EBW (-26dB) Test Procedure
1. Set the radio in the continuous transmitting mode. 2. Allow the trace to stabilize. 3. Setting the x-dB bandwidth mode to -26dB and OBW power function to 99% within the measurement set up function. 4. Select the automatic OBW measurement function of an instrument to perform bandwidth measurement. 5. Capture graphs and record pertinent measurement data.

Ref. ANSI C63.10: 2013 Section 6.9.3

99% BW and EBW (-26dB) Test parameters
Span = 1.5 x to 5.0 times OBW RBW = approx. 1% to 5% of the OBW VBW ≥ 3 x RBW Detector = Peak or where practical sample shall be used Trace = Max. Hold

System Number	Description	Samples	System under test	Support equipment
1	EUT	S01	<input checked="" type="checkbox"/>	<input type="checkbox"/>
	Support	S02	<input type="checkbox"/>	<input checked="" type="checkbox"/>

Tested By : Jose Aguirre	Date of testing: 21-Jan-17 - 06-Feb-17
Test Result : PASS	

See Appendix C for list of test equipment



Frequency (MHz)	Mode	Data Rate (Mbps)	26dB BW (MHz)	99% BW (MHz)
5260	Non HT20, 6 to 54 Mbps	6	25.6	18.250
	HT/VHT20, M0 to M15	m0	25.6	19.405
5270	Non HT40, 6 to 54 Mbps	6	66.8	37.798
	HT/VHT40, M0 to M15	m0	45.8	37.326
5290	Non HT80, 6 to 54 Mbps	6	84.8	76.221
	VHT80, M0 to M9, M0 to M9 1-1ss	m0x1	89.0	76.594
5300	Non HT20, 6 to 54 Mbps	6	24.8	18.284
	HT/VHT20, M0 to M15	m0	25.7	19.356
5310	Non HT40, 6 to 54 Mbps	6	44.8	37.177
	HT/VHT40, M0 to M15	m0	45.4	37.114
5320	Non HT20, 6 to 54 Mbps	6	24.5	18.273
	HT/VHT20, M0 to M15	m0	25.6	19.354



26dB / 99% Bandwidth, 5260 MHz, Non HT20, 6 to 54 Mbps

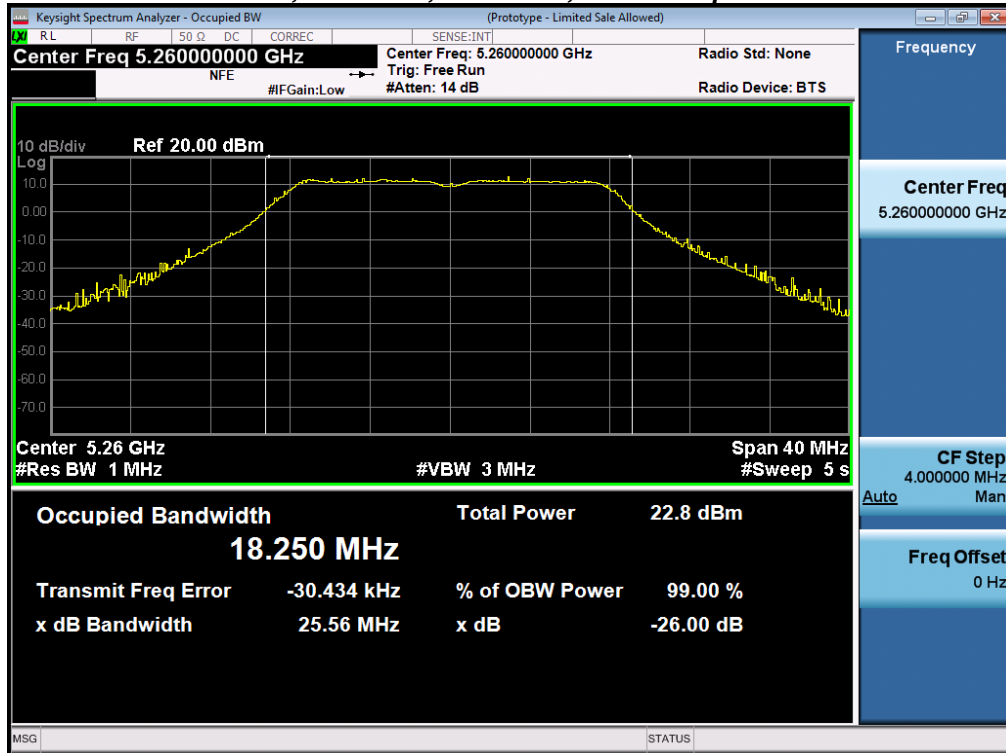



A.2 Maximum Conducted Output Power/ Power Spectral Density

15.407 (2) For the 5.25-5.35 GHz and 5.47-5.725 GHz bands, the maximum conducted output power over the frequency bands of operation shall not exceed the lesser of 250 mW or 11 dBm + 10 log B, where B is the 26 dB emission bandwidth in megahertz. In addition, the maximum power spectral density shall not exceed 11 dBm in any 1 megahertz band. If transmitting antennas of directional gain greater than 6 dBi are used, both the maximum conducted output power and the maximum power spectral density shall be reduced by the amount in dB that the directional gain of the antenna exceeds 6 dBi.

15.407 (5) The maximum power spectral density is measured as a conducted emission by direct connection of a calibrated test instrument to the equipment under test. If the device cannot be connected directly, alternative techniques acceptable to the Commission may be used. Measurements in the 5.15-5.25 GHz, 5.25-5.35 GHz, and the 5.47-5.725 GHz bands are made over a bandwidth of 1 MHz or the 26 dB emission bandwidth of the device, whichever is less. A narrower resolution bandwidth can be used, provided that the measured power is integrated over the full reference bandwidth.

Referencing “644545 D03 Guidance for IEEE 802.11ac v01”, covering signals that cross the boundary between two adjacent UNII bands, the FCC describes a procedure to measure EBW, power, and PSD in each UNII band. For the case of a 160MHz signal equally distributed between UNII-1 and UNII-2a, we apply the following alternate procedure.

Rather than measure:

- The half of the signal in UNII-1, measured against the 30dBm power / 17dBm/MHz PSD limits
- The half of the signal in UNII-2a, measured against the 24dBm power / 11dBm/MHz PSD limits

If a 160MHz signal (equally distributed between the two bands) produces a total power of 27dBm across the entire 160 MHz EBW, the total power in each band would be half of the total, or 24dBm (which meets both the UNII-1 and UNII-2a limits), and would have a PSD no greater than 11dBm/MHz in either sub-band.

Given these facts, we have measured the complete 160 MHz EBW (across both sub-bands) against 27dBm power and 11dBm/MHz PSD limits, rather than individual sub band measurements against the individual sub band limits.”

Test Procedure

Ref. KDB 789033 D02 General UNII Test Procedures New Rules v01r03
ANSI C63.10: 2013

Output Power Test Procedure
<ol style="list-style-type: none"> 1. Set the radio in the continuous transmitting mode at full power 2. Compute power by integrating the spectrum across the EBW (or alternatively entire 99% OBW) of the signal using the instrument's band power measurement function. The integration shall be performed using the spectrum analyzer band-power measurement function with band limits set equal to the EBW or the OBW band edges. 3. Capture graphs and record pertinent measurement data.

Ref. KDB 789033 D02 General UNII Test Procedures New Rules v01r03
ANSI C63.10: 2013 section 12.3.2.2 Method SA-1

Output Power Test parameters
Span = >1.5 times the OBW RBW = 1MHz VBW ≥ 3 x RBW Sweep = Auto couple Detector = sample Trace = Trace Average 100

The “measure-and-sum technique” is used for measuring in-band transmit power of a device. In the measure-and-sum approach, the conducted emission level is measured at each antenna port. The measured results at the various antenna ports are then summed mathematically to determine the total emission level from the device. Summing is performed in linear power units. (See ANSI C63.10 section 14.3.2.2)



System Number	Description	Samples	System under test	Support equipment
1	EUT	S01	<input checked="" type="checkbox"/>	<input type="checkbox"/>
	Support	S02	<input type="checkbox"/>	<input checked="" type="checkbox"/>

Tested By : Jose Aguirre	Date of testing: 21-Jan-17 - 06-Feb-17
Test Result : PASS	

See Appendix C for list of test equipment



Maximum Output Power
Antenna Gain: 5 (0) dBi

Frequency (MHz)	Mode	Tx Paths	Correlated Antenna Gain (dBi)	Tx 1 Max Power (dBm)	Tx 2 Max Power (dBm)	Total Tx Channel Power (dBm)	Limit (dBm)	Margin (dB)
5260	Non HT20, 6 to 54 Mbps	1	5	21.5		21.5	23.7	2.2
	Non HT20, 6 to 54 Mbps	2	5	14.6	15.0	17.8	23.6	5.8
	Non HT20 Beam Forming, 6 to 54 Mbps	2	8	14.6	15.0	17.8	21.6	3.8
	HT/VHT20, M0 to M7	1	5	21.5		21.5	24.0	2.5
	HT/VHT20, M0 to M7	2	5	16.7	17.1	19.9	23.9	4.0
	HT/VHT20, M8 to M15	2	5	17.9	18.0	21.0	23.9	2.9
	HT/VHT20 Beam Forming, M0 to M7	2	8	16.7	17.1	19.9	21.9	2.0
	HT/VHT20 Beam Forming, M8 to M15	2	5	17.9	18.0	21.0	23.9	2.9
HT/VHT20 STBC, M0 to M7	2	5	17.9	18.0	21.0	23.9	2.9	
5270	Non HT40, 6 to 54 Mbps	1	5	21.3		21.3	24.0	2.7
	Non HT40, 6 to 54 Mbps	2	5	18.6	19.1	21.9	24.0	2.1
	HT/VHT40, M0 to M7	1	5	21.6		21.6	24.0	2.4
	HT/VHT40, M0 to M7	2	5	19.6	20.1	22.9	24.0	1.1
	HT/VHT40, M8 to M15	2	5	20.6	21.1	23.9	24.0	0.1
	HT/VHT40 Beam Forming, M0 to M7	2	8	18.6	19.1	21.9	22.0	0.1
	HT/VHT40 Beam Forming, M8 to M15	2	5	20.6	21.1	23.9	24.0	0.1
	HT/VHT40 STBC, M0 to M7	2	5	20.6	21.1	23.9	24.0	0.1
5290	Non HT80, 6 to 54 Mbps	1	5	15.9		15.9	24.0	8.1
	Non HT80, 6 to 54 Mbps	2	5	15.0	15.4	18.2	24.0	5.8
	VHT80, M0 to M9 1ss	1	5	16.3		16.3	24.0	7.7
	VHT80, M0 to M9 1ss	2	5	15.3	15.9	18.6	24.0	5.4
	VHT80, M0 to M9 2ss	2	5	15.3	15.9	18.6	24.0	5.4
	VHT80 Beam Forming, M0 to M9 1ss	2	8	12.5	12.8	15.7	22.0	6.3
	VHT80 Beam Forming, M0 to M9 2ss	2	5	15.3	15.9	18.6	24.0	5.4
	VHT80 STBC, M0 to M9 1ss	2	5	15.3	15.9	18.6	24.0	5.4
5300	Non HT20, 6 to 54 Mbps	1	5	20.9		20.9	23.7	2.8
	Non HT20, 6 to 54 Mbps	2	5	16.0	16.7	19.4	23.6	4.2
	Non HT20 Beam Forming, 6 to 54 Mbps	2	8	16.0	16.7	19.4	21.6	2.2
	HT/VHT20, M0 to M7	1	5	21.7		21.7	24.0	2.3
	HT/VHT20, M0 to M7	2	5	15.9	16.6	19.3	23.9	4.6
	HT/VHT20, M8 to M15	2	5	18.0	18.6	21.3	23.9	2.6



	HT/VHT20 Beam Forming, M0 to M7	2	8	15.9	16.6	19.3	21.9	2.6
	HT/VHT20 Beam Forming, M8 to M15	2	5	18.0	18.6	21.3	23.9	2.6
	HT/VHT20 STBC, M0 to M7	2	5	18.0	18.6	21.3	23.9	2.6
5310	Non HT40, 6 to 54 Mbps	1	5	16.2		16.2	24.0	7.8
	Non HT40, 6 to 54 Mbps	2	5	14.5	14.8	17.7	24.0	6.3
	HT/VHT40, M0 to M7	1	5	18.2		18.2	24.0	5.8
	HT/VHT40, M0 to M7	2	5	16.2	16.8	19.5	24.0	4.5
	HT/VHT40, M8 to M15	2	5	16.2	16.8	19.5	24.0	4.5
	HT/VHT40 Beam Forming, M0 to M7	2	8	14.4	14.7	17.5	22.0	4.5
	HT/VHT40 Beam Forming, M8 to M15	2	5	16.2	16.8	19.5	24.0	4.5
	HT/VHT40 STBC, M0 to M7	2	5	16.2	16.8	19.5	24.0	4.5
5320	Non HT20, 6 to 54 Mbps	1	5	19.5		19.5	23.6	4.1
	Non HT20, 6 to 54 Mbps	2	5	16.4	16.8	19.6	23.6	4.0
	Non HT20 Beam Forming, 6 to 54 Mbps	2	8	16.4	16.8	19.6	21.6	2.0
	HT/VHT20, M0 to M7	1	5	19.6		19.6	23.9	4.3
	HT/VHT20, M0 to M7	2	5	16.5	16.8	19.7	23.9	4.2
	HT/VHT20, M8 to M15	2	5	17.5	17.7	20.6	23.9	3.3
	HT/VHT20 Beam Forming, M0 to M7	2	8	16.5	16.8	19.7	21.9	2.2
	HT/VHT20 Beam Forming, M8 to M15	2	5	17.5	17.7	20.6	23.9	3.3
	HT/VHT20 STBC, M0 to M7	2	5	17.5	17.7	20.6	23.9	3.3



Maximum Transmit Output Power, 5270 MHz, HT/VHT40, M8 to M15



Antenna A



Antenna B



Antenna Gain: 9 (1) dBi

Frequency (MHz)	Mode	Tx Paths	Correlated Antenna Gain (dBi)	Tx 1 Max Power (dBm)	Tx 2 Max Power (dBm)	Total Tx Channel Power (dBm)	Limit (dBm)	Margin (dB)
5260	Non HT20, 6 to 54 Mbps	1	9	18.7		18.7	20.6	1.9
	Non HT20, 6 to 54 Mbps	2	9	11.6	12.0	14.8	20.6	5.8
	Non HT20 Beam Forming, 6 to 54 Mbps	2	12	11.6	12.0	14.8	17.6	2.8
	HT/VHT20, M0 to M7	1	9	18.7		18.7	20.9	2.2
	HT/VHT20, M0 to M7	2	9	12.6	12.9	15.8	20.9	5.1
	HT/VHT20, M8 to M15	2	9	15.6	16.0	18.8	20.9	2.1
	HT/VHT20 Beam Forming, M0 to M7	2	12	12.6	12.9	15.8	17.9	2.1
	HT/VHT20 Beam Forming, M8 to M15	2	9	15.6	16.0	18.8	20.9	2.1
HT/VHT20 STBC, M0 to M7	2	9	15.6	16.0	18.8	20.9	2.1	
5270	Non HT40, 6 to 54 Mbps	1	9	20.4		20.4	21.0	0.6
	Non HT40, 6 to 54 Mbps	2	9	14.6	15.2	17.9	21.0	3.1
	HT/VHT40, M0 to M7	1	9	20.6		20.6	21.0	0.4
	HT/VHT40, M0 to M7	2	9	15.5	16.1	18.8	21.0	2.2
	HT/VHT40, M8 to M15	2	9	17.6	18.1	20.9	21.0	0.1
	HT/VHT40 Beam Forming, M0 to M7	2	12	14.6	15.1	17.9	18.0	0.1
	HT/VHT40 Beam Forming, M8 to M15	2	9	17.6	18.1	20.9	21.0	0.1
	HT/VHT40 STBC, M0 to M7	2	9	17.6	18.1	20.9	21.0	0.1
5290	Non HT80, 6 to 54 Mbps	1	9	14.0		14.0	21.0	7.0
	Non HT80, 6 to 54 Mbps	2	9	11.1	11.6	14.4	21.0	6.6
	VHT80, M0 to M9 1ss	1	9	12.5		12.5	21.0	8.5
	VHT80, M0 to M9 1ss	2	9	10.5	10.9	13.7	21.0	7.3
	VHT80, M0 to M9 2ss	2	9	10.5	10.9	13.7	21.0	7.3
	VHT80 Beam Forming, M0 to M9 1ss	2	12	8.4	8.9	11.7	18.0	6.3
	VHT80 Beam Forming, M0 to M9 2ss	2	9	10.5	10.9	13.7	21.0	7.3
	VHT80 STBC, M0 to M9 1ss	2	9	10.5	10.9	13.7	21.0	7.3
5300	Non HT20, 6 to 54 Mbps	1	9	18.0		18.0	20.6	2.6
	Non HT20, 6 to 54 Mbps	2	9	12.1	12.6	15.4	20.6	5.2
	Non HT20 Beam Forming, 6 to 54 Mbps	2	12	12.1	12.6	15.4	17.6	2.2
	HT/VHT20, M0 to M7	1	9	18.0		18.0	20.9	2.9
	HT/VHT20, M0 to M7	2	9	12.1	12.7	15.4	20.9	5.5
	HT/VHT20, M8 to M15	2	9	15.1	15.6	18.4	20.9	2.5



	HT/VHT20 Beam Forming, M0 to M7	2	12	12.1	12.7	15.4	17.9	2.5
	HT/VHT20 Beam Forming, M8 to M15	2	9	15.1	15.6	18.4	20.9	2.5
	HT/VHT20 STBC, M0 to M7	2	9	15.1	15.6	18.4	20.9	2.5
5310	Non HT40, 6 to 54 Mbps	1	9	13.4		13.4	21.0	7.6
	Non HT40, 6 to 54 Mbps	2	9	10.4	10.8	13.6	21.0	7.4
	HT/VHT40, M0 to M7	1	9	15.4		15.4	21.0	5.6
	HT/VHT40, M0 to M7	2	9	12.4	12.7	15.6	21.0	5.4
	HT/VHT40, M8 to M15	2	9	12.4	12.7	15.6	21.0	5.4
	HT/VHT40 Beam Forming, M0 to M7	2	12	9.3	9.7	12.5	18.0	5.5
	HT/VHT40 Beam Forming, M8 to M15	2	9	12.4	12.7	15.6	21.0	5.4
	HT/VHT40 STBC, M0 to M7	2	9	12.4	12.7	15.6	21.0	5.4
5320	Non HT20, 6 to 54 Mbps	1	9	17.5		17.5	20.6	3.1
	Non HT20, 6 to 54 Mbps	2	9	12.5	12.7	15.6	20.6	5.0
	Non HT20 Beam Forming, 6 to 54 Mbps	2	12	11.5	11.7	14.6	17.6	3.0
	HT/VHT20, M0 to M7	1	9	17.5		17.5	20.9	3.4
	HT/VHT20, M0 to M7	2	9	12.6	12.7	15.7	20.9	5.2
	HT/VHT20, M8 to M15	2	9	14.6	14.8	17.7	20.9	3.2
	HT/VHT20 Beam Forming, M0 to M7	2	12	11.6	11.7	14.7	17.9	3.2
	HT/VHT20 Beam Forming, M8 to M15	2	9	14.6	14.8	17.7	20.9	3.2
	HT/VHT20 STBC, M0 to M7	2	9	14.6	14.8	17.7	20.9	3.2



Maximum Transmit Output Power, 5270 MHz, HT/VHT40, M8 to M15

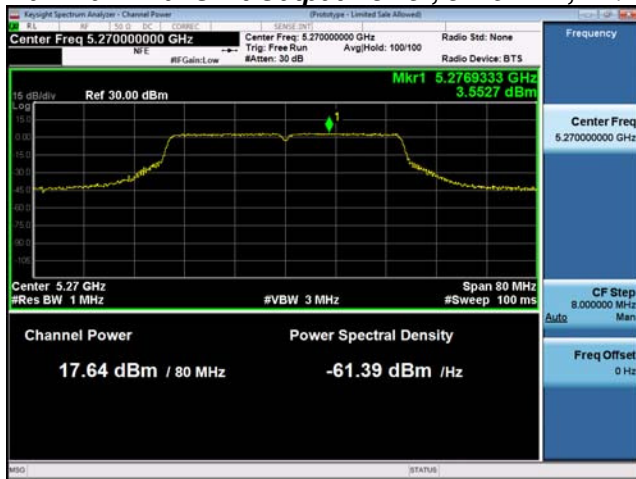

Antenna A



Antenna B



Power Spectral Density
Antenna Gain: 5 (0) dBi

Frequency (MHz)	Mode	Tx Paths	Correlated Antenna Gain (dBi)	Tx 1 PSD (dBm/MHz)	Tx 2 PSD (dBm/MHz)	Total PSD (dBm/MHz)	Limit (dBm/MHz)	Margin (dB)
5260	Non HT20, 6 to 54 Mbps	1	5	10.6		10.6	11.0	0.4
	Non HT20, 6 to 54 Mbps	2	8	3.8	4.3	7.1	9.0	1.9
	Non HT20 Beam Forming, 6 to 54 Mbps	2	8	3.8	4.3	7.1	9.0	1.9
	HT/VHT20, M0 to M7	1	5	10.2		10.2	11.0	0.8
	HT/VHT20, M0 to M7	2	8	5.7	6.2	9.0	9.0	0.0
	HT/VHT20, M8 to M15	2	5	6.7	7.1	9.9	11.0	1.1
	HT/VHT20 Beam Forming, M0 to M7	2	8	5.7	6.2	9.0	9.0	0.0
	HT/VHT20 Beam Forming, M8 to M15	2	5	6.7	7.1	9.9	11.0	1.1
	HT/VHT20 STBC, M0 to M7	2	5	6.7	7.1	9.9	11.0	1.1
5270	Non HT40, 6 to 54 Mbps	1	5	7.5		7.5	11.0	3.5
	Non HT40, 6 to 54 Mbps	2	8	5.1	5.7	8.4	9.0	0.6
	HT/VHT40, M0 to M7	1	5	7.5		7.5	11.0	3.5
	HT/VHT40, M0 to M7	2	8	5.3	6.2	8.8	9.0	0.2
	HT/VHT40, M8 to M15	2	5	6.4	7.0	9.7	11.0	1.3
	HT/VHT40 Beam Forming, M0 to M7	2	8	4.5	5.1	7.8	9.0	1.2
	HT/VHT40 Beam Forming, M8 to M15	2	5	6.4	7.0	9.7	11.0	1.3
	HT/VHT40 STBC, M0 to M7	2	5	6.4	7.0	9.7	11.0	1.3
5290	Non HT80, 6 to 54 Mbps	1	5	-0.3		-0.3	11.0	11.3
	Non HT80, 6 to 54 Mbps	2	8	-1.0	-0.3	2.4	9.0	6.6
	VHT80, M0 to M9 1ss	1	5	-0.4		-0.4	11.0	11.4
	VHT80, M0 to M9 1ss	2	8	-1.2	-0.4	2.2	9.0	6.8
	VHT80, M0 to M9 2ss	2	5	-1.2	-0.4	2.2	11.0	8.8
	VHT80 Beam Forming, M0 to M9 1ss	2	8	-4.4	-3.3	-0.8	9.0	9.8
	VHT80 Beam Forming, M0 to M9 2ss	2	5	-1.2	-0.4	2.2	11.0	8.8
	VHT80 STBC, M0 to M9 1ss	2	5	-1.2	-0.4	2.2	11.0	8.8



5300	Non HT20, 6 to 54 Mbps	1	5	10.1		10.1	11.0	0.9
	Non HT20, 6 to 54 Mbps	2	8	5.3	5.9	8.6	9.0	0.4
	Non HT20 Beam Forming, 6 to 54 Mbps	2	8	5.3	5.9	8.6	9.0	0.4
	HT/VHT20, M0 to M7	1	5	10.7		10.7	11.0	0.3
	HT/VHT20, M0 to M7	2	8	4.9	6.0	8.5	9.0	0.5
	HT/VHT20, M8 to M15	2	5	6.9	7.7	10.3	11.0	0.7
	HT/VHT20 Beam Forming, M0 to M7	2	8	4.9	6.0	8.5	9.0	0.5
	HT/VHT20 Beam Forming, M8 to M15	2	5	6.9	7.7	10.3	11.0	0.7
HT/VHT20 STBC, M0 to M7	2	5	6.9	7.7	10.3	11.0	0.7	
5310	Non HT40, 6 to 54 Mbps	1	5	2.8		2.8	11.0	8.2
	Non HT40, 6 to 54 Mbps	2	8	1.0	1.4	4.2	9.0	4.8
	HT/VHT40, M0 to M7	1	5	4.2		4.2	11.0	6.8
	HT/VHT40, M0 to M7	2	8	3.2	3.9	6.6	9.0	2.4
	HT/VHT40, M8 to M15	2	5	3.2	3.9	6.6	11.0	4.4
	HT/VHT40 Beam Forming, M0 to M7	2	8	1.3	1.9	4.6	9.0	4.4
	HT/VHT40 Beam Forming, M8 to M15	2	5	3.2	3.9	6.6	11.0	4.4
	HT/VHT40 STBC, M0 to M7	2	5	3.2	3.9	6.6	11.0	4.4
5320	Non HT20, 6 to 54 Mbps	1	5	9.5		9.5	11.0	1.5
	Non HT20, 6 to 54 Mbps	2	8	6.0	5.9	9.0	9.0	0.0
	Non HT20 Beam Forming, 6 to 54 Mbps	2	8	6.0	5.9	9.0	9.0	0.0
	HT/VHT20, M0 to M7	1	5	9.3		9.3	11.0	1.7
	HT/VHT20, M0 to M7	2	8	6.1	5.8	9.0	9.0	0.0
	HT/VHT20, M8 to M15	2	5	7.7	7.9	10.8	11.0	0.2
	HT/VHT20 Beam Forming, M0 to M7	2	8	6.1	5.8	9.0	9.0	0.0
	HT/VHT20 Beam Forming, M8 to M15	2	5	7.7	7.9	10.8	11.0	0.2
	HT/VHT20 STBC, M0 to M7	2	5	7.7	7.9	10.8	11.0	0.2



Power Spectral Density, 5260 MHz, HT/VHT20, M0 to M7

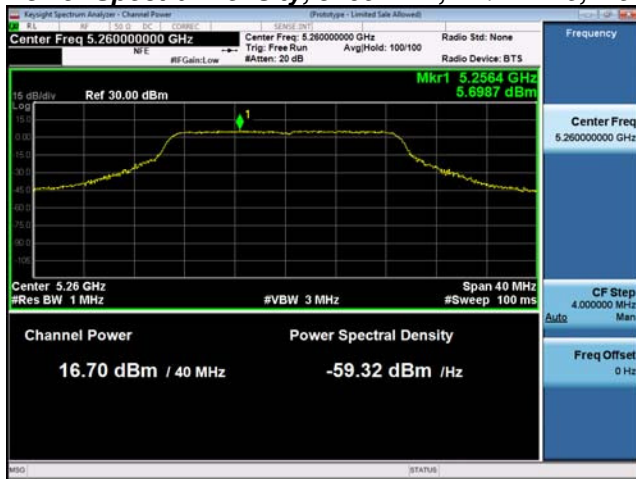

Antenna A

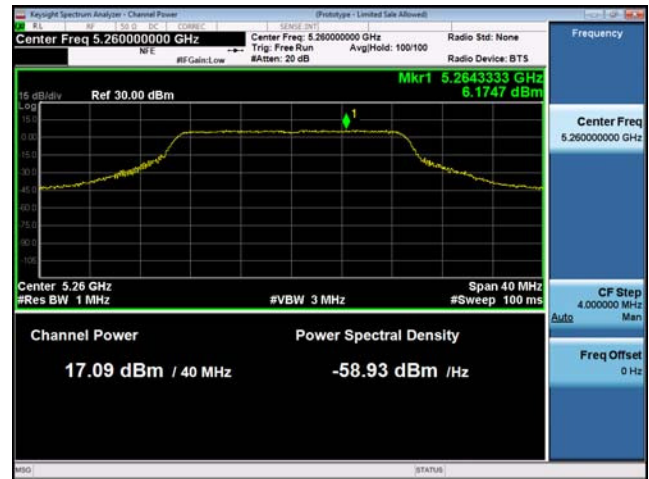

Antenna B



Antenna Gain: 9 (1) dBi

Frequency (MHz)	Mode	Tx Paths	Correlated Antenna Gain (dBi)	Tx 1 PSD (dBm/MHz)	Tx 2 PSD (dBm/MHz)	Total PSD (dBm/MHz)	Limit (dBm/MHz)	Margin (dB)
5260	Non HT20, 6 to 54 Mbps	1	9	7.9		7.9	8.0	0.1
	Non HT20, 6 to 54 Mbps	2	12	0.8	1.3	4.1	5.0	0.9
	Non HT20 Beam Forming, 6 to 54 Mbps	2	12	0.8	1.3	4.1	5.0	0.9
	HT/VHT20, M0 to M7	1	9	7.7		7.7	8.0	0.3
	HT/VHT20, M0 to M7	2	12	1.7	1.8	4.8	5.0	0.2
	HT/VHT20, M8 to M15	2	9	4.6	5.1	7.9	8.0	0.1
	HT/VHT20 Beam Forming, M0 to M7	2	12	1.7	1.8	4.8	5.0	0.2
	HT/VHT20 Beam Forming, M8 to M15	2	9	4.6	5.1	7.9	8.0	0.1
HT/VHT20 STBC, M0 to M7	2	9	4.6	5.1	7.9	8.0	0.1	
5270	Non HT40, 6 to 54 Mbps	1	9	7.0		7.0	8.0	1.0
	Non HT40, 6 to 54 Mbps	2	12	1.0	1.6	4.3	5.0	0.7
	HT/VHT40, M0 to M7	1	9	6.4		6.4	8.0	1.6
	HT/VHT40, M0 to M7	2	12	1.3	2.0	4.7	5.0	0.3
	HT/VHT40, M8 to M15	2	9	3.6	3.9	6.8	8.0	1.2
	HT/VHT40 Beam Forming, M0 to M7	2	12	0.5	1.4	4.0	5.0	1.0
	HT/VHT40 Beam Forming, M8 to M15	2	9	3.6	3.9	6.8	8.0	1.2
	HT/VHT40 STBC, M0 to M7	2	9	3.6	3.9	6.8	8.0	1.2
5290	Non HT80, 6 to 54 Mbps	1	9	-1.0		-1.0	8.0	9.0
	Non HT80, 6 to 54 Mbps	2	12	-4.8	-4.3	-1.5	5.0	6.5
	VHT80, M0 to M9 1ss	1	9	-1.2		-1.2	8.0	9.2
	VHT80, M0 to M9 1ss	2	12	-5.4	-4.1	-1.7	5.0	6.7
	VHT80, M0 to M9 2ss	2	9	-5.4	-4.1	-1.7	8.0	9.7
	VHT80 Beam Forming, M0 to M9 1ss	2	12	-7.1	-6.0	-3.5	5.0	8.5
	VHT80 Beam Forming, M0 to M9 2ss	2	9	-5.4	-4.1	-1.7	8.0	9.7
	VHT80 STBC, M0 to M9 1ss	2	9	-5.4	-4.1	-1.7	8.0	9.7
5300	Non HT20, 6 to 54 Mbps	1	9	7.3		7.3	8.0	0.7
	Non HT20, 6 to 54 Mbps	2	12	1.5	1.9	4.7	5.0	0.3
	Non HT20 Beam Forming, 6 to 54 Mbps	2	12	1.5	1.9	4.7	5.0	0.3
	HT/VHT20, M0 to M7	1	9	6.9		6.9	8.0	1.1
	HT/VHT20, M0 to M7	2	12	1.1	1.9	4.5	5.0	0.5
	HT/VHT20, M8 to M15	2	9	4.2	4.9	7.6	8.0	0.4



	HT/VHT20 Beam Forming, M0 to M7	2	12	1.1	1.9	4.5	5.0	0.5
	HT/VHT20 Beam Forming, M8 to M15	2	9	4.2	4.9	7.6	8.0	0.4
	HT/VHT20 STBC, M0 to M7	2	9	4.2	4.9	7.6	8.0	0.4
5310	Non HT40, 6 to 54 Mbps	1	9	1.8		1.8	8.0	6.2
	Non HT40, 6 to 54 Mbps	2	12	-2.2	-1.5	1.2	5.0	3.8
	HT/VHT40, M0 to M7	1	9	3.2		3.2	8.0	4.8
	HT/VHT40, M0 to M7	2	12	0.3	0.8	3.6	5.0	1.4
	HT/VHT40, M8 to M15	2	9	0.3	0.8	3.6	8.0	4.4
	HT/VHT40 Beam Forming, M0 to M7	2	12	-2.5	-2.0	0.8	5.0	4.2
	HT/VHT40 Beam Forming, M8 to M15	2	9	0.3	0.8	3.6	8.0	4.4
	HT/VHT40 STBC, M0 to M7	2	9	0.3	0.8	3.6	8.0	4.4
5320	Non HT20, 6 to 54 Mbps	1	9	7.9		7.9	8.0	0.1
	Non HT20, 6 to 54 Mbps	2	12	1.7	1.9	4.8	5.0	0.2
	Non HT20 Beam Forming, 6 to 54 Mbps	2	12	0.9	0.7	3.8	5.0	1.2
	HT/VHT20, M0 to M7	1	9	7.7		7.7	8.0	0.3
	HT/VHT20, M0 to M7	2	12	1.8	1.7	4.8	5.0	0.2
	HT/VHT20, M8 to M15	2	9	4.7	5.1	7.9	8.0	0.1
	HT/VHT20 Beam Forming, M0 to M7	2	12	0.6	0.7	3.7	5.0	1.3
	HT/VHT20 Beam Forming, M8 to M15	2	9	4.7	5.1	7.9	8.0	0.1
	HT/VHT20 STBC, M0 to M7	2	9	4.7	5.1	7.9	8.0	0.1



Power Spectral Density, 5260 MHz, Non HT20, 6 to 54 Mbps

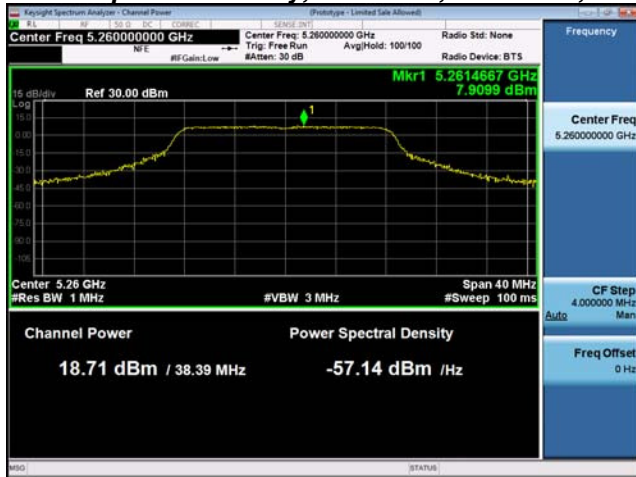

Antenna A



A.3 Conducted Spurious Emissions

15.407 (b) Undesirable emission limits. Except as shown in paragraph (b) (7) of this section, the maximum emissions outside of the frequency bands of operation shall be attenuated in accordance with the following limits:

- (2) For transmitters operating in the 5.25-5.35 GHz band: All emissions outside of the 5.15-5.35 GHz band shall not exceed an e.i.r.p. of -27 dBm/MHz.
- (6) Unwanted emissions below 1 GHz must comply with the general field strength limits set forth in §15.209.
- (7) The provisions of §15.205 apply to intentional radiators operating under this section.

Use formula below to substitute conducted measurements in place of radiated measurements

$$E[\text{dB}\mu\text{V}/\text{m}] = \text{EIRP}[\text{dBm}] - 20 \log(d[\text{meters}]) + 104.77, \text{ where } E = \text{field strength and } d = 3 \text{ meter}$$

- 1) Average Plot, Limit= -41.25 dBm eirp
- 2) Peak plot, Limit = -21.25 dBm eirp

Test Procedure

Ref. KDB 789033 D02 General UNII Test Procedures New Rules v01r03
ANSI C63.10: 2013

Conducted Spurious Emissions

Test Procedure

1. Connect the antenna port(s) to the spectrum analyzer input.
2. Place the radio in continuous transmit mode. Use the procedures in KDB 789033 D02 General UNII Test Procedures New Rules v01r03 to substitute conducted measurements in place of radiated measurements.
3. Configure Spectrum analyzer as per test parameters below (be sure to enter all losses between the transmitter output and the spectrum analyzer).
4. Record the marker waveform peak to spur difference. Also measure any emissions in the restricted bands.
5. The “measure-and-sum technique” is used for measuring in-band transmit power of a device. In the measure-and-sum approach, the conducted emission level is measured at each antenna port. The measured results at the various antenna ports are then summed mathematically to determine the total emission level from the device. Summing is performed in linear power units. The worst case output is recorded.
6. Capture graphs and record pertinent measurement data.

Ref. KDB 789033 D02 General UNII Test Procedures New Rules v01r03
ANSI C63.10: 2013 section 12.7.7.3 (average) & 12.7.6 (peak)

Conducted Spurious Emissions

Test parameters

Span = 30MHz to 18GHz / 18GHz to 40GHz
RBW = 1 MHz
VBW ≥ 3 x RBW for Peak, 1kHz for Average
Sweep = Auto couple
Detector = Peak
Trace = Max Hold.

System Number	Description	Samples	System under test	Support equipment
1	EUT	S01	<input checked="" type="checkbox"/>	<input type="checkbox"/>
	Support	S02	<input type="checkbox"/>	<input checked="" type="checkbox"/>

Tested By :

Jose Aguirre

Date of testing:

21-Jan-17 - 06-Feb-17

Test Result : PASS

See Appendix C for list of test equipment



Conducted Spurs Average Upper, All Antennas

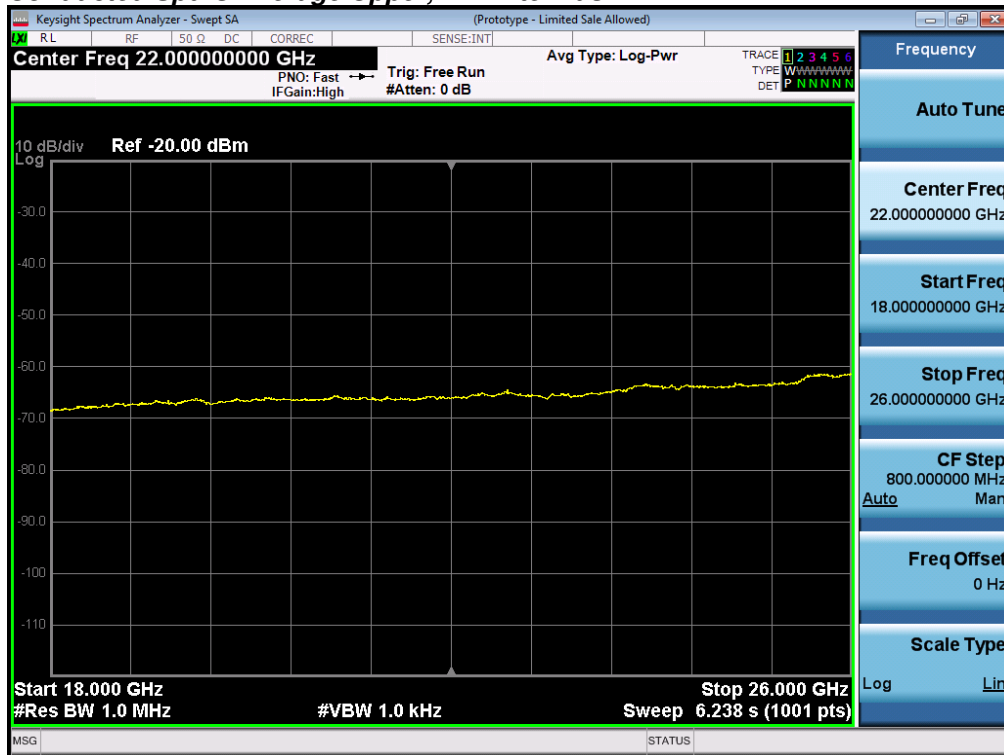

Conducted Spurs Peak Upper, All Antennas

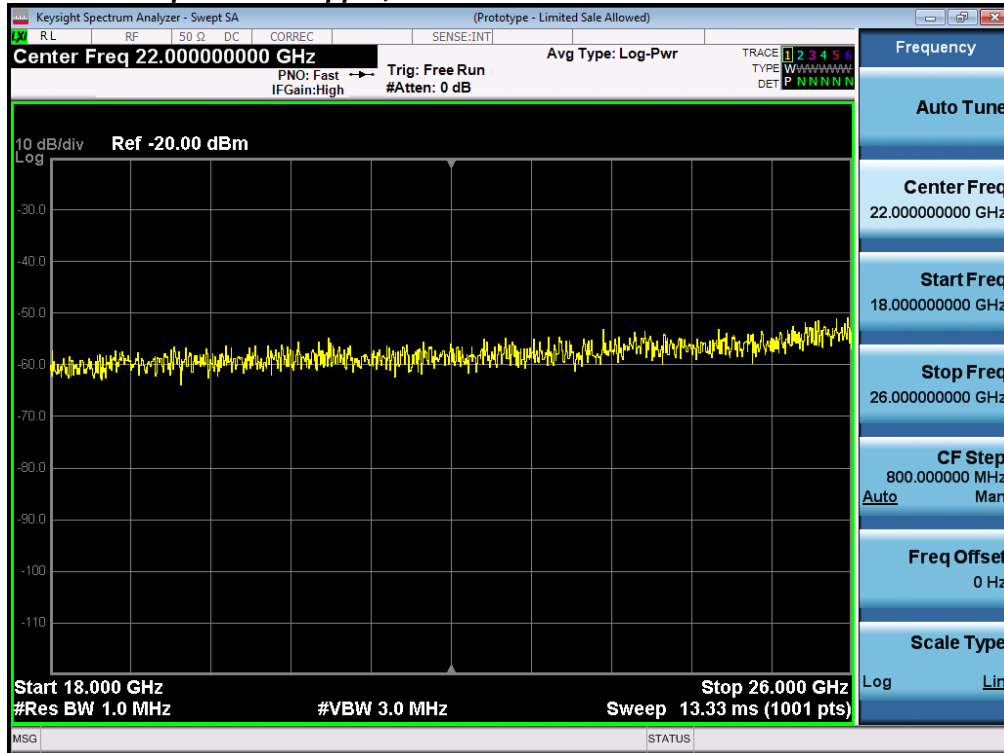



Antenna Gain: 5 (0) dBi

Frequency (MHz)	Mode	Tx Paths	Correlated Antenna Gain (dBi)	Tx 1 Spur Power (dBm)	Tx 2 Spur Power (dBm)	Total Conducted Spur (dBm)	Limit (dBm)	Margin (dB)
5260	Non HT20, 6 to 54 Mbps	1	5	-63.8		-58.8	-41.25	17.6
	Non HT20, 6 to 54 Mbps	2	5	-65.2	-59.5	-53.5	-41.25	12.2
	Non HT20 Beam Forming, 6 to 54 Mbps	2	8	-65.2	-59.5	-50.5	-41.25	9.2
	HT/VHT20, M0 to M7	1	5	-64.0		-59.0	-41.25	17.8
	HT/VHT20, M0 to M7	2	5	-66.0	-58.8	-53.0	-41.25	11.8
	HT/VHT20, M8 to M15	2	5	-64.0	-58.3	-52.3	-41.25	11.0
	HT/VHT20 Beam Forming, M0 to M7	2	8	-66.0	-58.8	-50.0	-41.25	8.8
	HT/VHT20 Beam Forming, M8 to M15	2	5	-64.0	-58.3	-52.3	-41.25	11.0
	HT/VHT20 STBC, M0 to M7	2	5	-64.0	-58.3	-52.3	-41.25	11.0
5270	Non HT40, 6 to 54 Mbps	1	5	-65.0		-60.0	-41.25	18.8
	Non HT40, 6 to 54 Mbps	2	5	-64.7	-64.2	-56.4	-41.25	15.2
	HT/VHT40, M0 to M7	1	5	-65.3		-60.3	-41.25	19.1
	HT/VHT40, M0 to M7	2	5	-65.7	-65.6	-57.6	-41.25	16.4
	HT/VHT40, M8 to M15	2	5	-65.5	-64.8	-57.1	-41.25	15.9
	HT/VHT40 Beam Forming, M0 to M7	2	8	-64.8	-64.8	-53.8	-41.25	12.5
	HT/VHT40 Beam Forming, M8 to M15	2	5	-65.5	-64.8	-57.1	-41.25	15.9
	HT/VHT40 STBC, M0 to M7	2	5	-65.5	-64.8	-57.1	-41.25	15.9
5290	Non HT80, 6 to 54 Mbps	1	5	-66.7		-61.7	-41.25	20.5
	Non HT80, 6 to 54 Mbps	2	5	-65.5	-62.8	-55.9	-41.25	14.7
	VHT80, M0 to M9 1ss	1	5	-67.6		-62.6	-41.25	21.4
	VHT80, M0 to M9 1ss	2	5	-66.9	-62.4	-56.1	-41.25	14.8
	VHT80, M0 to M9 2ss	2	5	-66.9	-62.4	-56.1	-41.25	14.8
	VHT80 Beam Forming, M0 to M9 1ss	2	8	-66.8	-62.5	-53.1	-41.25	11.9
	VHT80 Beam Forming, M0 to M9 2ss	2	5	-66.9	-62.4	-56.1	-41.25	14.8
	VHT80 STBC, M0 to M9 1ss	2	5	-66.9	-62.4	-56.1	-41.25	14.8
5300	Non HT20, 6 to 54 Mbps	1	5	-65.7		-60.7	-41.25	19.5
	Non HT20, 6 to 54 Mbps	2	5	-66.8	-59.2	-53.5	-41.25	12.3
	Non HT20 Beam Forming, 6 to 54 Mbps	2	8	-66.8	-59.2	-50.5	-41.25	9.3
	HT/VHT20, M0 to M7	1	5	-64.8		-59.8	-41.25	18.6
	HT/VHT20, M0 to M7	2	5	-66.8	-59.0	-53.3	-41.25	12.1
	HT/VHT20, M8 to M15	2	5	-66.6	-58.0	-52.4	-41.25	11.2



	HT/VHT20 Beam Forming, M0 to M7	2	8	-66.8	-59.0	-50.3	-41.25	9.1
	HT/VHT20 Beam Forming, M8 to M15	2	5	-66.6	-58.0	-52.4	-41.25	11.2
	HT/VHT20 STBC, M0 to M7	2	5	-66.6	-58.0	-52.4	-41.25	11.2
5310	Non HT40, 6 to 54 Mbps	1	5	-66.8		-61.8	-41.25	20.6
	Non HT40, 6 to 54 Mbps	2	5	-67.7	-63.8	-57.3	-41.25	16.1
	HT/VHT40, M0 to M7	1	5	-66.0		-61.0	-41.25	19.8
	HT/VHT40, M0 to M7	2	5	-66.8	-63.3	-56.7	-41.25	15.4
	HT/VHT40, M8 to M15	2	5	-66.8	-63.3	-56.7	-41.25	15.4
	HT/VHT40 Beam Forming, M0 to M7	2	8	-67.5	-64.9	-55.0	-41.25	13.7
	HT/VHT40 Beam Forming, M8 to M15	2	5	-66.8	-63.3	-56.7	-41.25	15.4
	HT/VHT40 STBC, M0 to M7	2	5	-66.8	-63.3	-56.7	-41.25	15.4
5320	Non HT20, 6 to 54 Mbps	1	5	-65.1		-60.1	-41.25	18.9
	Non HT20, 6 to 54 Mbps	2	5	-66.2	-63.4	-56.6	-41.25	15.3
	Non HT20 Beam Forming, 6 to 54 Mbps	2	8	-66.2	-63.4	-53.6	-41.25	12.3
	HT/VHT20, M0 to M7	1	5	-65.5		-60.5	-41.25	19.3
	HT/VHT20, M0 to M7	2	5	-66.9	-63.9	-57.1	-41.25	15.9
	HT/VHT20, M8 to M15	2	5	-68.1	-64.8	-58.1	-41.25	16.9
	HT/VHT20 Beam Forming, M0 to M7	2	8	-66.9	-63.9	-54.1	-41.25	12.9
	HT/VHT20 Beam Forming, M8 to M15	2	5	-68.1	-64.8	-58.1	-41.25	16.9
	HT/VHT20 STBC, M0 to M7	2	5	-68.1	-64.8	-58.1	-41.25	16.9



Conducted Spurs Average, 5260 MHz, HT/VHT20 Beam Forming, M0 to M7



Antenna A



Antenna B



Antenna Gain: 9 (1) dBi

Frequency (MHz)	Mode	Tx Paths	Correlated Antenna Gain (dBi)	Tx 1 Spur Power (dBm)	Tx 2 Spur Power (dBm)	Total Conducted Spur (dBm)	Limit (dBm)	Margin (dB)
5260	Non HT20, 6 to 54 Mbps	1	9	-63.1		-54.1	-41.25	12.9
	Non HT20, 6 to 54 Mbps	2	9	-65.3	-59.9	-49.8	-41.25	8.5
	Non HT20 Beam Forming, 6 to 54 Mbps	2	12	-65.3	-59.9	-46.8	-41.25	5.5
	HT/VHT20, M0 to M7	1	9	-63.6		-54.6	-41.25	13.4
	HT/VHT20, M0 to M7	2	9	-65.2	-59.7	-49.6	-41.25	8.4
	HT/VHT20, M8 to M15	2	9	-66.2	-59.8	-49.9	-41.25	8.7
	HT/VHT20 Beam Forming, M0 to M7	2	12	-65.2	-59.7	-46.6	-41.25	5.4
	HT/VHT20 Beam Forming, M8 to M15	2	9	-66.2	-59.8	-49.9	-41.25	8.7
	HT/VHT20 STBC, M0 to M7	2	9	-66.2	-59.8	-49.9	-41.25	8.7
5270	Non HT40, 6 to 54 Mbps	1	9	-65.5		-56.5	-41.25	15.3
	Non HT40, 6 to 54 Mbps	2	9	-65.7	-59.1	-49.2	-41.25	8.0
	HT/VHT40, M0 to M7	1	9	-65.5		-56.5	-41.25	15.3
	HT/VHT40, M0 to M7	2	9	-66.4	-59.7	-49.9	-41.25	8.6
	HT/VHT40, M8 to M15	2	9	-65.0	-65.2	-53.1	-41.25	11.8
	HT/VHT40 Beam Forming, M0 to M7	2	12	-67.1	-59.3	-46.6	-41.25	5.4
	HT/VHT40 Beam Forming, M8 to M15	2	9	-65.0	-65.2	-53.1	-41.25	11.8
	HT/VHT40 STBC, M0 to M7	2	9	-65.0	-65.2	-53.1	-41.25	11.8
5290	Non HT80, 6 to 54 Mbps	1	9	-65.5		-56.5	-41.25	15.3
	Non HT80, 6 to 54 Mbps	2	9	-68.2	-63.6	-53.3	-41.25	12.1
	VHT80, M0 to M9 1ss	1	9	-66.9		-57.9	-41.25	16.7
	VHT80, M0 to M9 1ss	2	9	-67.4	-62.6	-52.4	-41.25	11.1
	VHT80, M0 to M9 2ss	2	9	-67.4	-62.6	-52.4	-41.25	11.1
	VHT80 Beam Forming, M0 to M9 1ss	2	12	-68.3	-64.2	-50.8	-41.25	9.5
	VHT80 Beam Forming, M0 to M9 2ss	2	9	-67.4	-62.6	-52.4	-41.25	11.1
	VHT80 STBC, M0 to M9 1ss	2	9	-67.4	-62.6	-52.4	-41.25	11.1
5300	Non HT20, 6 to 54 Mbps	1	9	-66.8		-57.8	-41.25	16.6
	Non HT20, 6 to 54 Mbps	2	9	-67.2	-59.1	-49.5	-41.25	8.2
	Non HT20 Beam Forming, 6 to 54 Mbps	2	12	-67.2	-59.1	-46.5	-41.25	5.2
	HT/VHT20, M0 to M7	1	9	-66.6		-57.6	-41.25	16.4
	HT/VHT20, M0 to M7	2	9	-67.2	-59.4	-49.7	-41.25	8.5
	HT/VHT20, M8 to M15	2	9	-66.9	-59.0	-49.3	-41.25	8.1



	HT/VHT20 Beam Forming, M0 to M7	2	12	-67.2	-59.4	-46.7	-41.25	5.5
	HT/VHT20 Beam Forming, M8 to M15	2	9	-66.9	-59.0	-49.3	-41.25	8.1
	HT/VHT20 STBC, M0 to M7	2	9	-66.9	-59.0	-49.3	-41.25	8.1
5310	Non HT40, 6 to 54 Mbps	1	9	-66.7		-57.7	-41.25	16.5
	Non HT40, 6 to 54 Mbps	2	9	-66.7	-64.8	-53.6	-41.25	12.4
	HT/VHT40, M0 to M7	1	9	-66.8		-57.8	-41.25	16.6
	HT/VHT40, M0 to M7	2	9	-68.1	-64.5	-53.9	-41.25	12.7
	HT/VHT40, M8 to M15	2	9	-68.1	-64.5	-53.9	-41.25	12.7
	HT/VHT40 Beam Forming, M0 to M7	2	12	-67.9	-65.7	-51.7	-41.25	10.4
	HT/VHT40 Beam Forming, M8 to M15	2	9	-68.1	-64.5	-53.9	-41.25	12.7
	HT/VHT40 STBC, M0 to M7	2	9	-68.1	-64.5	-53.9	-41.25	12.7
5320	Non HT20, 6 to 54 Mbps	1	9	-67.6		-58.6	-41.25	17.4
	Non HT20, 6 to 54 Mbps	2	9	-67.1	-63.0	-52.6	-41.25	11.3
	Non HT20 Beam Forming, 6 to 54 Mbps	2	12	-68.7	-64.1	-50.8	-41.25	9.6
	HT/VHT20, M0 to M7	1	9	-68.1		-59.1	-41.25	17.9
	HT/VHT20, M0 to M7	2	9	-66.9	-62.7	-52.3	-41.25	11.1
	HT/VHT20, M8 to M15	2	9	-67.0	-63.0	-52.5	-41.25	11.3
	HT/VHT20 Beam Forming, M0 to M7	2	12	-68.1	-64.4	-50.9	-41.25	9.6
	HT/VHT20 Beam Forming, M8 to M15	2	9	-67.0	-63.0	-52.5	-41.25	11.3
	HT/VHT20 STBC, M0 to M7	2	9	-67.0	-63.0	-52.5	-41.25	11.3



Conducted Spurs Average, 5300 MHz, Non HT20 Beam Forming, 6 to 54 Mbps



Antenna A

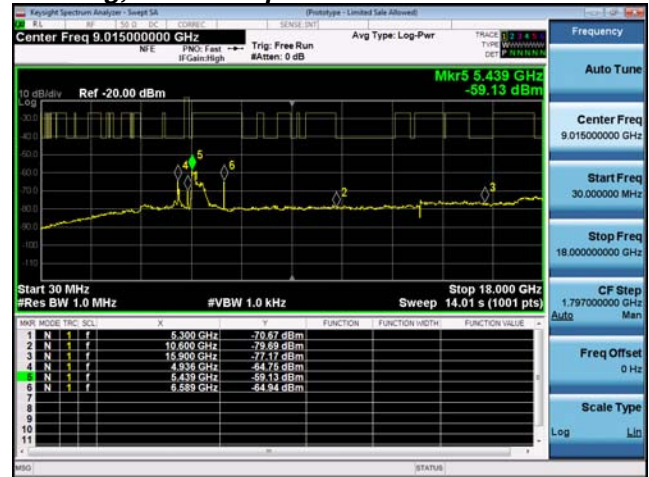

Antenna B



Antenna Gain: 5 (0) dBi

Frequency (MHz)	Mode	Tx Paths	Correlated Antenna Gain (dBi)	Tx 1 Spur Power (dBm)	Tx 2 Spur Power (dBm)	Total Conducted Spur (dBm)	Limit (dBm)	Margin (dB)
5260	Non HT20, 6 to 54 Mbps	1	5	-50.9		-45.9	-21.25	24.7
	Non HT20, 6 to 54 Mbps	2	5	-51.9	-53.2	-44.5	-21.25	23.2
	Non HT20 Beam Forming, 6 to 54 Mbps	2	8	-51.9	-53.2	-41.5	-21.25	20.2
	HT/VHT20, M0 to M7	1	5	-51.6		-46.6	-21.25	25.4
	HT/VHT20, M0 to M7	2	5	-52.0	-50.5	-43.2	-21.25	21.9
	HT/VHT20, M8 to M15	2	5	-50.4	-51.1	-42.7	-21.25	21.5
	HT/VHT20 Beam Forming, M0 to M7	2	8	-52.0	-50.5	-40.2	-21.25	18.9
	HT/VHT20 Beam Forming, M8 to M15	2	5	-50.4	-51.1	-42.7	-21.25	21.5
	HT/VHT20 STBC, M0 to M7	2	5	-50.4	-51.1	-42.7	-21.25	21.5
5270	Non HT40, 6 to 54 Mbps	1	5	-48.5		-43.5	-21.25	22.3
	Non HT40, 6 to 54 Mbps	2	5	-50.6	-49.7	-42.1	-21.25	20.9
	HT/VHT40, M0 to M7	1	5	-49.9		-44.9	-21.25	23.7
	HT/VHT40, M0 to M7	2	5	-47.4	-48.6	-39.9	-21.25	18.7
	HT/VHT40, M8 to M15	2	5	-46.9	-48.7	-39.7	-21.25	18.4
	HT/VHT40 Beam Forming, M0 to M7	2	8	-49.6	-50.1	-38.8	-21.25	17.6
	HT/VHT40 Beam Forming, M8 to M15	2	5	-46.9	-48.7	-39.7	-21.25	18.4
	HT/VHT40 STBC, M0 to M7	2	5	-46.9	-48.7	-39.7	-21.25	18.4
5290	Non HT80, 6 to 54 Mbps	1	5	-48.9		-43.9	-21.25	22.7
	Non HT80, 6 to 54 Mbps	2	5	-49.3	-59.0	-43.9	-21.25	22.6
	VHT80, M0 to M9 1ss	1	5	-50.1		-45.1	-21.25	23.9
	VHT80, M0 to M9 1ss	2	5	-50.3	-48.7	-41.4	-21.25	20.2
	VHT80, M0 to M9 2ss	2	5	-50.3	-48.7	-41.4	-21.25	20.2
	VHT80 Beam Forming, M0 to M9 1ss	2	8	-50.6	-60.0	-42.1	-21.25	20.9
	VHT80 Beam Forming, M0 to M9 2ss	2	5	-50.3	-48.7	-41.4	-21.25	20.2
	VHT80 STBC, M0 to M9 1ss	2	5	-50.3	-48.7	-41.4	-21.25	20.2
5300	Non HT20, 6 to 54 Mbps	1	5	-49.8		-44.8	-21.25	23.6
	Non HT20, 6 to 54 Mbps	2	5	-50.1	-51.2	-42.6	-21.25	21.4
	Non HT20 Beam Forming, 6 to 54 Mbps	2	8	-50.1	-51.2	-39.6	-21.25	18.4
	HT/VHT20, M0 to M7	1	5	-50.9		-45.9	-21.25	24.7
	HT/VHT20, M0 to M7	2	5	-51.1	-52.2	-43.6	-21.25	22.4
	HT/VHT20, M8 to M15	2	5	-50.7	-49.7	-42.2	-21.25	20.9



	HT/VHT20 Beam Forming, M0 to M7	2	8	-51.1	-52.2	-40.6	-21.25	19.4
	HT/VHT20 Beam Forming, M8 to M15	2	5	-50.7	-49.7	-42.2	-21.25	20.9
	HT/VHT20 STBC, M0 to M7	2	5	-50.7	-49.7	-42.2	-21.25	20.9
5310	Non HT40, 6 to 54 Mbps	1	5	-50.7		-45.7	-21.25	24.5
	Non HT40, 6 to 54 Mbps	2	5	-50.8	-52.8	-43.7	-21.25	22.4
	HT/VHT40, M0 to M7	1	5	-50.3		-45.3	-21.25	24.1
	HT/VHT40, M0 to M7	2	5	-49.0	-47.9	-40.4	-21.25	19.2
	HT/VHT40, M8 to M15	2	5	-49.0	-47.9	-40.4	-21.25	19.2
	HT/VHT40 Beam Forming, M0 to M7	2	8	-51.0	-60.2	-42.5	-21.25	21.3
	HT/VHT40 Beam Forming, M8 to M15	2	5	-49.0	-47.9	-40.4	-21.25	19.2
	HT/VHT40 STBC, M0 to M7	2	5	-49.0	-47.9	-40.4	-21.25	19.2
5320	Non HT20, 6 to 54 Mbps	1	5	-58.2		-53.2	-21.25	32.0
	Non HT20, 6 to 54 Mbps	2	5	-61.9	-61.3	-53.6	-21.25	32.3
	Non HT20 Beam Forming, 6 to 54 Mbps	2	8	-61.9	-61.3	-50.6	-21.25	29.3
	HT/VHT20, M0 to M7	1	5	-58.1		-53.1	-21.25	31.9
	HT/VHT20, M0 to M7	2	5	-59.9	-60.2	-52.0	-21.25	30.8
	HT/VHT20, M8 to M15	2	5	-59.1	-60.4	-51.7	-21.25	30.4
	HT/VHT20 Beam Forming, M0 to M7	2	8	-59.9	-60.2	-49.0	-21.25	27.8
	HT/VHT20 Beam Forming, M8 to M15	2	5	-59.1	-60.4	-51.7	-21.25	30.4
	HT/VHT20 STBC, M0 to M7	2	5	-59.1	-60.4	-51.7	-21.25	30.4



Conducted Spurs Peak, 5270 MHz, HT/VHT40 Beam Forming, M0 to M7



Antenna A

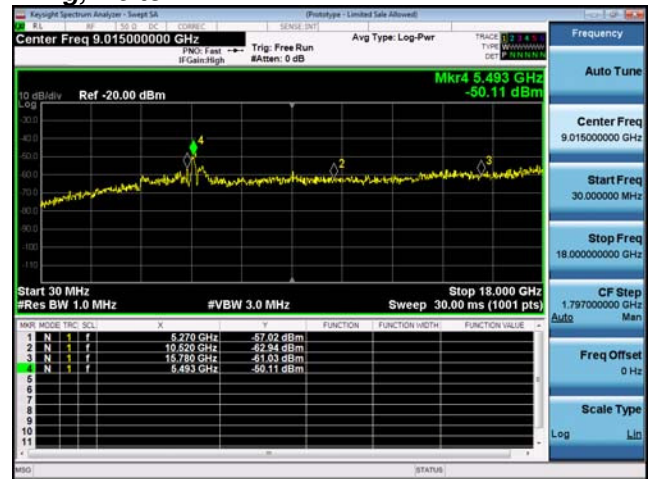

Antenna B



Antenna Gain: 9 (1) dBi

Frequency (MHz)	Mode	Tx Paths	Correlated Antenna Gain (dBi)	Tx 1 Spur Power (dBm)	Tx 2 Spur Power (dBm)	Total Conducted Spur (dBm)	Limit (dBm)	Margin (dB)
5260	Non HT20, 6 to 54 Mbps	1	9	-50.7		-41.7	-21.25	20.5
	Non HT20, 6 to 54 Mbps	2	9	-53.0	-51.5	-40.2	-21.25	18.9
	Non HT20 Beam Forming, 6 to 54 Mbps	2	12	-53.0	-51.5	-37.2	-21.25	15.9
	HT/VHT20, M0 to M7	1	9	-51.4		-42.4	-21.25	21.2
	HT/VHT20, M0 to M7	2	9	-51.5	-52.3	-39.9	-21.25	18.6
	HT/VHT20, M8 to M15	2	9	-52.9	-50.6	-39.6	-21.25	18.3
	HT/VHT20 Beam Forming, M0 to M7	2	12	-51.5	-52.3	-36.9	-21.25	15.6
	HT/VHT20 Beam Forming, M8 to M15	2	9	-52.9	-50.6	-39.6	-21.25	18.3
	HT/VHT20 STBC, M0 to M7	2	9	-52.9	-50.6	-39.6	-21.25	18.3
5270	Non HT40, 6 to 54 Mbps	1	9	-50.6		-41.6	-21.25	20.4
	Non HT40, 6 to 54 Mbps	2	9	-48.3	-52.4	-37.9	-21.25	16.6
	HT/VHT40, M0 to M7	1	9	-46.9		-37.9	-21.25	16.7
	HT/VHT40, M0 to M7	2	9	-50.8	-51.0	-38.9	-21.25	17.6
	HT/VHT40, M8 to M15	2	9	-49.9	-49.1	-37.5	-21.25	16.2
	HT/VHT40 Beam Forming, M0 to M7	2	12	-50.3	-52.1	-36.1	-21.25	14.8
	HT/VHT40 Beam Forming, M8 to M15	2	9	-49.9	-49.1	-37.5	-21.25	16.2
	HT/VHT40 STBC, M0 to M7	2	9	-49.9	-49.1	-37.5	-21.25	16.2
5290	Non HT80, 6 to 54 Mbps	1	9	-49.3		-40.3	-21.25	19.1
	Non HT80, 6 to 54 Mbps	2	9	-53.6	-49.8	-39.3	-21.25	18.0
	VHT80, M0 to M9 1ss	1	9	-50.3		-41.3	-21.25	20.1
	VHT80, M0 to M9 1ss	2	9	-52.0	-49.6	-38.6	-21.25	17.4
	VHT80, M0 to M9 2ss	2	9	-52.0	-49.6	-38.6	-21.25	17.4
	VHT80 Beam Forming, M0 to M9 1ss	2	12	-51.6	-52.0	-36.8	-21.25	15.5
	VHT80 Beam Forming, M0 to M9 2ss	2	9	-52.0	-49.6	-38.6	-21.25	17.4
	VHT80 STBC, M0 to M9 1ss	2	9	-52.0	-49.6	-38.6	-21.25	17.4
5300	Non HT20, 6 to 54 Mbps	1	9	-50.1		-41.1	-21.25	19.9
	Non HT20, 6 to 54 Mbps	2	9	-49.9	-51.7	-38.7	-21.25	17.4
	Non HT20 Beam Forming, 6 to 54 Mbps	2	12	-49.9	-51.7	-35.7	-21.25	14.4
	HT/VHT20, M0 to M7	1	9	-50.7		-41.7	-21.25	20.5
	HT/VHT20, M0 to M7	2	9	-51.5	-48.5	-37.7	-21.25	16.5
	HT/VHT20, M8 to M15	2	9	-51.3	-51.5	-39.4	-21.25	18.1



	HT/VHT20 Beam Forming, M0 to M7	2	12	-51.5	-48.5	-34.7	-21.25	13.5
	HT/VHT20 Beam Forming, M8 to M15	2	9	-51.3	-51.5	-39.4	-21.25	18.1
	HT/VHT20 STBC, M0 to M7	2	9	-51.3	-51.5	-39.4	-21.25	18.1
5310	Non HT40, 6 to 54 Mbps	1	9	-50.1		-41.1	-21.25	19.9
	Non HT40, 6 to 54 Mbps	2	9	-53.5	-53.2	-41.3	-21.25	20.1
	HT/VHT40, M0 to M7	1	9	-49.0		-40.0	-21.25	18.8
	HT/VHT40, M0 to M7	2	9	-50.8	-50.3	-38.5	-21.25	17.3
	HT/VHT40, M8 to M15	2	9	-50.8	-50.3	-38.5	-21.25	17.3
	HT/VHT40 Beam Forming, M0 to M7	2	12	-53.0	-61.6	-40.4	-21.25	19.2
	HT/VHT40 Beam Forming, M8 to M15	2	9	-50.8	-50.3	-38.5	-21.25	17.3
	HT/VHT40 STBC, M0 to M7	2	9	-50.8	-50.3	-38.5	-21.25	17.3
5320	Non HT20, 6 to 54 Mbps	1	9	-60.2		-51.2	-21.25	30.0
	Non HT20, 6 to 54 Mbps	2	9	-50.4	-50.4	-38.4	-21.25	17.1
	Non HT20 Beam Forming, 6 to 54 Mbps	2	12	-60.7	-61.5	-46.1	-21.25	24.8
	HT/VHT20, M0 to M7	1	9	-59.1		-50.1	-21.25	28.9
	HT/VHT20, M0 to M7	2	9	-50.4	-58.7	-40.8	-21.25	19.6
	HT/VHT20, M8 to M15	2	9	-49.9	-61.6	-40.6	-21.25	19.4
	HT/VHT20 Beam Forming, M0 to M7	2	12	-59.6	-61.5	-45.4	-21.25	24.2
	HT/VHT20 Beam Forming, M8 to M15	2	9	-49.9	-61.6	-40.6	-21.25	19.4
	HT/VHT20 STBC, M0 to M7	2	9	-49.9	-61.6	-40.6	-21.25	19.4



Conducted Spurs Peak, 5300 MHz, HT/VHT20 Beam Forming, M0 to M7

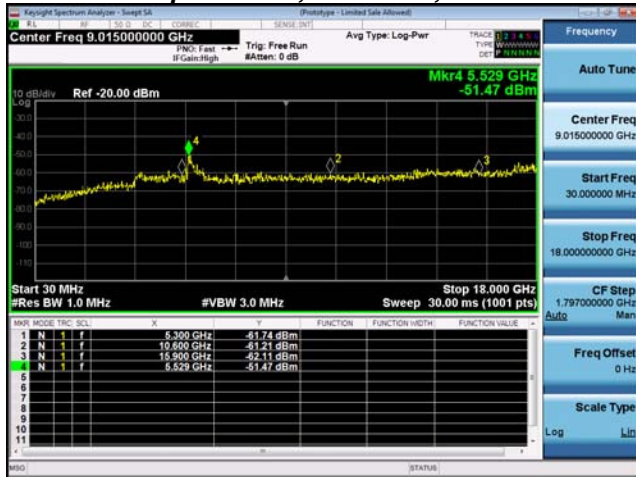

Antenna A

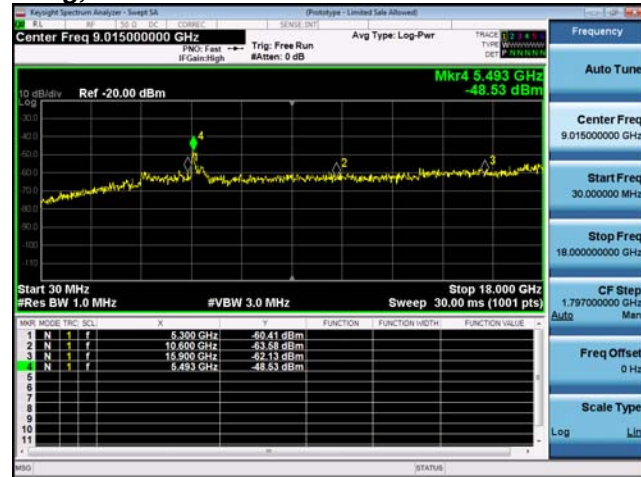

Antenna B



A.4 Conducted Bandedge

15.205 / 15.209 - Radiated emissions which fall in the restricted bands, as defined in Section 15.205(a), must also comply with the radiated emission limits specified in Section 15.209(a) (see Section 15.205(c)).

Use formula below to substitute conducted measurements in place of radiated measurements

$$E[\text{dB}\mu\text{V/m}] = \text{EIRP}[\text{dBm}] - 20 \log(d[\text{meters}]) + 104.77, \text{ where } E = \text{field strength and } d = 3 \text{ meter}$$

- 1) Average Plot, Limit= -41.25 dBm eirp
- 2) Peak plot, Limit = -21.25 dBm eirp

Test Procedure

Ref. KDB 789033 D02 General UNII Test Procedures New Rules v01r03
ANSI C63.10: 2013

Conducted Bandedge
Test Procedure
<ol style="list-style-type: none"> 1. Connect the antenna port(s) to the spectrum analyzer input. 2. Place the radio in continuous transmit mode. Use the procedures in ANSI C63.10: 2013 to substitute conducted measurements in place of radiated measurements. 3. Configure Spectrum analyzer as per test parameters below (be sure to enter all losses between the transmitter output and the spectrum analyzer). 4. Place a marker at the end of the restricted band closest to the transmit frequency to show compliance. Also measure any emissions in the restricted bands. 5. The “measure-and-sum technique” is used for measuring in-band transmit power of a device. In the measure-and-sum approach, the conducted emission level is measured at each antenna port. The measured results at the various antenna ports are then summed mathematically to determine the total emission level from the device. Summing is performed in linear power units. The worst case output is recorded. 6. Place a marker at the end of the restricted band closest to the transmit frequency to show compliance. Also measure any emissions in the restricted bands 7. Capture graphs and record pertinent measurement data.

Ref. ANSI C63.10: 2013 section 12.7.6 (peak) & 12.7.7.3 (average, Method VB-A (Alternative))

Conducted Bandedge
Test parameters restricted Band
RBW = 1 MHz VBW ≥ 3 x RBW for Peak, 100Hz for Average Sweep = Auto couple Detector = Peak Trace = Max Hold.

System Number	Description	Samples	System under test	Support equipment
1	EUT	S01	<input checked="" type="checkbox"/>	<input type="checkbox"/>
	Support	S02	<input type="checkbox"/>	<input checked="" type="checkbox"/>

Tested By : Jose Aguirre	Date of testing: 21-Jan-17 - 06-Feb-17
Test Result : PASS	

See Appendix C for list of test equipment



Antenna Gain: 5 (0) dBi

Frequency (MHz)	Mode	Tx Paths	Correlated Antenna Gain (dBi)	Tx 1 Bandedge Level (dBm)	Tx 2 Bandedge Level (dBm)	Total Tx Bandedge Level (dBm)	Limit (dBm)	Margin (dB)
5290	Non HT80, 6 to 54 Mbps	1	5	-49.0		-44.0	-41.25	2.8
	Non HT80, 6 to 54 Mbps	2	5	-49.7	-49.4	-41.5	-41.25	0.3
	VHT80, M0 to M9 1ss	1	5	-47.9		-42.9	-41.25	1.7
	VHT80, M0 to M9 1ss	2	5	-48.9	-51.4	-42.0	-41.25	0.7
	VHT80, M0 to M9 2ss	2	5	-48.9	-51.4	-42.0	-41.25	0.7
	VHT80 Beam Forming, M0 to M9 1ss	2	8	-52.3	-53.0	-41.6	-41.25	0.4
	VHT80 Beam Forming, M0 to M9 2ss	2	5	-48.9	-51.4	-42.0	-41.25	0.7
	VHT80 STBC, M0 to M9 1ss	2	5	-48.9	-51.4	-42.0	-41.25	0.7
5310	Non HT40, 6 to 54 Mbps	1	5	-47.5		-42.5	-41.25	1.3
	Non HT40, 6 to 54 Mbps	2	5	-49.8	-49.9	-41.8	-41.25	0.6
	HT/VHT40, M0 to M7	1	5	-48.2		-43.2	-41.25	2.0
	HT/VHT40, M0 to M7	2	5	-49.9	-50.8	-42.3	-41.25	1.1
	HT/VHT40, M8 to M15	2	5	-49.9	-50.8	-42.3	-41.25	1.1
	HT/VHT40 Beam Forming, M0 to M7	2	8	-52.6	-52.6	-41.6	-41.25	0.3
	HT/VHT40 Beam Forming, M8 to M15	2	5	-49.9	-50.8	-42.3	-41.25	1.1
	HT/VHT40 STBC, M0 to M7	2	5	-49.9	-50.8	-42.3	-41.25	1.1
5320	Non HT20, 6 to 54 Mbps	1	5	-48.1		-43.1	-41.25	1.9
	Non HT20, 6 to 54 Mbps	2	5	-53.1	-52.5	-44.8	-41.25	3.5
	Non HT20 Beam Forming, 6 to 54 Mbps	2	8	-53.1	-52.5	-41.8	-41.25	0.5
	HT/VHT20, M0 to M7	1	5	-48.2		-43.2	-41.25	2.0
	HT/VHT20, M0 to M7	2	5	-52.8	-52.3	-44.5	-41.25	3.3
	HT/VHT20, M8 to M15	2	5	-52.1	-51.5	-43.8	-41.25	2.5
	HT/VHT20 Beam Forming, M0 to M7	2	8	-52.8	-52.3	-41.5	-41.25	0.3
	HT/VHT20 Beam Forming, M8 to M15	2	5	-52.1	-51.5	-43.8	-41.25	2.5
HT/VHT20 STBC, M0 to M7	2	5	-52.1	-51.5	-43.8	-41.25	2.5	



Conducted Bandedge Average, 5290 MHz, Non HT80, 6 to 54 Mbps



Antenna A



Antenna B



Antenna Gain: 9 (1) dBi

Frequency (MHz)	Mode	Tx Paths	Correlated Antenna Gain (dBi)	Tx 1 Bandedge Level (dBm)	Tx 2 Bandedge Level (dBm)	Total Tx Bandedge Level (dBm)	Limit (dBm)	Margin (dB)
5290	Non HT80, 6 to 54 Mbps	1	9	-50.4		-41.4	-41.25	0.2
	Non HT80, 6 to 54 Mbps	2	9	-54.1	-53.2	-41.6	-41.25	0.4
	VHT80, M0 to M9 1ss	1	9	-51.3		-42.3	-41.25	1.1
	VHT80, M0 to M9 1ss	2	9	-54.7	-53.4	-42.0	-41.25	0.7
	VHT80, M0 to M9 2ss	2	9	-54.7	-53.4	-42.0	-41.25	0.7
	VHT80 Beam Forming, M0 to M9 1ss	2	12	-57.1	-55.7	-41.3	-41.25	0.1
	VHT80 Beam Forming, M0 to M9 2ss	2	9	-54.7	-53.4	-42.0	-41.25	0.7
	VHT80 STBC, M0 to M9 1ss	2	9	-54.7	-53.4	-42.0	-41.25	0.7
5310	Non HT40, 6 to 54 Mbps	1	9	-50.8		-41.8	-41.25	0.6
	Non HT40, 6 to 54 Mbps	2	9	-54.5	-55.5	-43.0	-41.25	1.7
	HT/VHT40, M0 to M7	1	9	-50.6		-41.6	-41.25	0.4
	HT/VHT40, M0 to M7	2	9	-54.7	-53.0	-41.8	-41.25	0.5
	HT/VHT40, M8 to M15	2	9	-54.7	-53.0	-41.8	-41.25	0.5
	HT/VHT40 Beam Forming, M0 to M7	2	12	-57.4	-56.5	-41.9	-41.25	0.7
	HT/VHT40 Beam Forming, M8 to M15	2	9	-54.7	-53.0	-41.8	-41.25	0.5
	HT/VHT40 STBC, M0 to M7	2	9	-54.7	-53.0	-41.8	-41.25	0.5
5320	Non HT20, 6 to 54 Mbps	1	9	-52.3		-43.3	-41.25	2.1
	Non HT20, 6 to 54 Mbps	2	9	-57.5	-55.2	-44.2	-41.25	2.9
	Non HT20 Beam Forming, 6 to 54 Mbps	2	12	-57.6	-55.8	-41.6	-41.25	0.3
	HT/VHT20, M0 to M7	1	9	-52.1		-43.1	-41.25	1.9
	HT/VHT20, M0 to M7	2	9	-53.2	-55.0	-42.0	-41.25	0.7
	HT/VHT20, M8 to M15	2	9	-53.3	-53.7	-41.5	-41.25	0.2
	HT/VHT20 Beam Forming, M0 to M7	2	12	-57.7	-55.4	-41.4	-41.25	0.1
	HT/VHT20 Beam Forming, M8 to M15	2	9	-53.3	-53.7	-41.5	-41.25	0.2
HT/VHT20 STBC, M0 to M7	2	9	-53.3	-53.7	-41.5	-41.25	0.2	



Conducted Bandedge Average, 5290 MHz, VHT80 Beam Forming, M0 to M9 1ss



Antenna A



Antenna B



Antenna Gain: 5 (0) dBi

Frequency (MHz)	Mode	Tx Paths	Correlated Antenna Gain (dBi)	Tx 1 Bandedge Level (dBm)	Tx 2 Bandedge Level (dBm)	Total Tx Bandedge Level (dBm)	Limit (dBm)	Margin (dB)
5290	Non HT80, 6 to 54 Mbps	1	5	-29.1		-24.1	-21.25	2.9
	Non HT80, 6 to 54 Mbps	2	5	-32.9	-28.9	-22.4	-21.25	1.2
	VHT80, M0 to M9 1ss	1	5	-29.1		-24.1	-21.25	2.9
	VHT80, M0 to M9 1ss	2	5	-39.4	-33.6	-27.6	-21.25	6.3
	VHT80, M0 to M9 2ss	2	5	-39.4	-33.6	-27.6	-21.25	6.3
	VHT80 Beam Forming, M0 to M9 1ss	2	8	-43.4	-40.7	-30.8	-21.25	9.6
	VHT80 Beam Forming, M0 to M9 2ss	2	5	-39.4	-33.6	-27.6	-21.25	6.3
	VHT80 STBC, M0 to M9 1ss	2	5	-39.4	-33.6	-27.6	-21.25	6.3
5310	Non HT40, 6 to 54 Mbps	1	5	-31.4		-26.4	-21.25	5.2
	Non HT40, 6 to 54 Mbps	2	5	-35.1	-30.7	-24.4	-21.25	3.1
	HT/VHT40, M0 to M7	1	5	-30.0		-25.0	-21.25	3.8
	HT/VHT40, M0 to M7	2	5	-36.4	-30.0	-24.1	-21.25	2.9
	HT/VHT40, M8 to M15	2	5	-36.4	-30.0	-24.1	-21.25	2.9
	HT/VHT40 Beam Forming, M0 to M7	2	8	-42.5	-41.3	-30.8	-21.25	9.6
	HT/VHT40 Beam Forming, M8 to M15	2	5	-36.4	-30.0	-24.1	-21.25	2.9
	HT/VHT40 STBC, M0 to M7	2	5	-36.4	-30.0	-24.1	-21.25	2.9
5320	Non HT20, 6 to 54 Mbps	1	5	-33.0		-28.0	-21.25	6.8
	Non HT20, 6 to 54 Mbps	2	5	-44.5	-42.7	-35.5	-21.25	14.2
	Non HT20 Beam Forming, 6 to 54 Mbps	2	8	-44.5	-42.7	-32.5	-21.25	11.2
	HT/VHT20, M0 to M7	1	5	-29.2		-24.2	-21.25	3.0
	HT/VHT20, M0 to M7	2	5	-40.9	-41.3	-33.1	-21.25	11.8
	HT/VHT20, M8 to M15	2	5	-36.0	-32.7	-26.0	-21.25	4.8
	HT/VHT20 Beam Forming, M0 to M7	2	8	-40.9	-41.3	-30.1	-21.25	8.8
	HT/VHT20 Beam Forming, M8 to M15	2	5	-36.0	-32.7	-26.0	-21.25	4.8
HT/VHT20 STBC, M0 to M7	2	5	-36.0	-32.7	-26.0	-21.25	4.8	



Conducted Bandedge Peak, 5290 MHz, Non HT80, 6 to 54 Mbps

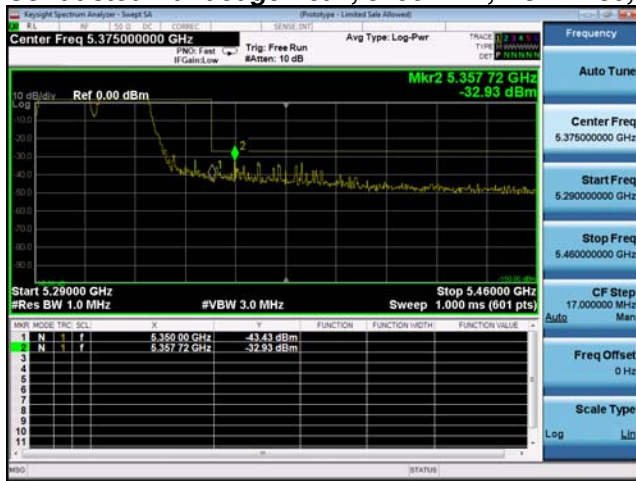

Antenna A

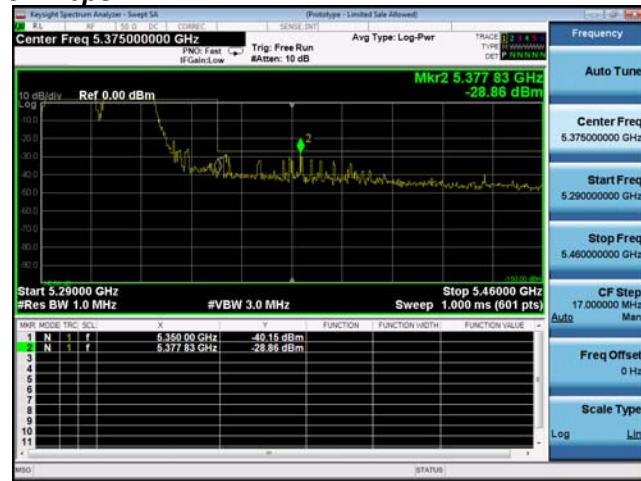

Antenna B



Antenna Gain: 9 (1) dBi

Frequency (MHz)	Mode	Tx Paths	Correlated Antenna Gain (dBi)	Tx 1 Bandedge Level (dBm)	Tx 2 Bandedge Level (dBm)	Total Tx Bandedge Level (dBm)	Limit (dBm)	Margin (dB)
5290	Non HT80, 6 to 54 Mbps	1	9	-32.9		-23.9	-21.25	2.7
	Non HT80, 6 to 54 Mbps	2	9	-43.3	-43.0	-31.1	-21.25	9.9
	VHT80, M0 to M9 1ss	1	9	-39.4		-30.4	-21.25	9.2
	VHT80, M0 to M9 1ss	2	9	-41.8	-41.7	-29.7	-21.25	8.5
	VHT80, M0 to M9 2ss	2	9	-41.8	-41.7	-29.7	-21.25	8.5
	VHT80 Beam Forming, M0 to M9 1ss	2	12	-47.7	-46.9	-32.3	-21.25	11.0
	VHT80 Beam Forming, M0 to M9 2ss	2	9	-41.8	-41.7	-29.7	-21.25	8.5
	VHT80 STBC, M0 to M9 1ss	2	9	-41.8	-41.7	-29.7	-21.25	8.5
5310	Non HT40, 6 to 54 Mbps	1	9	-30.9		-21.9	-21.25	0.7
	Non HT40, 6 to 54 Mbps	2	9	-42.7	-41.0	-29.8	-21.25	8.5
	HT/VHT40, M0 to M7	1	9	-36.4		-27.4	-21.25	6.2
	HT/VHT40, M0 to M7	2	9	-45.2	-42.6	-31.7	-21.25	10.4
	HT/VHT40, M8 to M15	2	9	-45.2	-42.6	-31.7	-21.25	10.4
	HT/VHT40 Beam Forming, M0 to M7	2	12	-47.9	-44.8	-31.1	-21.25	9.8
	HT/VHT40 Beam Forming, M8 to M15	2	9	-45.2	-42.6	-31.7	-21.25	10.4
	HT/VHT40 STBC, M0 to M7	2	9	-45.2	-42.6	-31.7	-21.25	10.4
5320	Non HT20, 6 to 54 Mbps	1	9	-43.3		-34.3	-21.25	13.1
	Non HT20, 6 to 54 Mbps	2	9	-46.0	-45.7	-33.8	-21.25	12.6
	Non HT20 Beam Forming, 6 to 54 Mbps	2	12	-48.7	-47.3	-32.9	-21.25	11.7
	HT/VHT20, M0 to M7	1	9	-36.0		-27.0	-21.25	5.8
	HT/VHT20, M0 to M7	2	9	-45.3	-44.6	-32.9	-21.25	11.7
	HT/VHT20, M8 to M15	2	9	-46.0	-42.9	-32.2	-21.25	10.9
	HT/VHT20 Beam Forming, M0 to M7	2	12	-47.6	-48.4	-33.0	-21.25	11.7
	HT/VHT20 Beam Forming, M8 to M15	2	9	-46.0	-42.9	-32.2	-21.25	10.9
HT/VHT20 STBC, M0 to M7	2	9	-46.0	-42.9	-32.2	-21.25	10.9	



Conducted Bandedge Peak, 5310 MHz, Non HT40, 6 to 54 Mbps

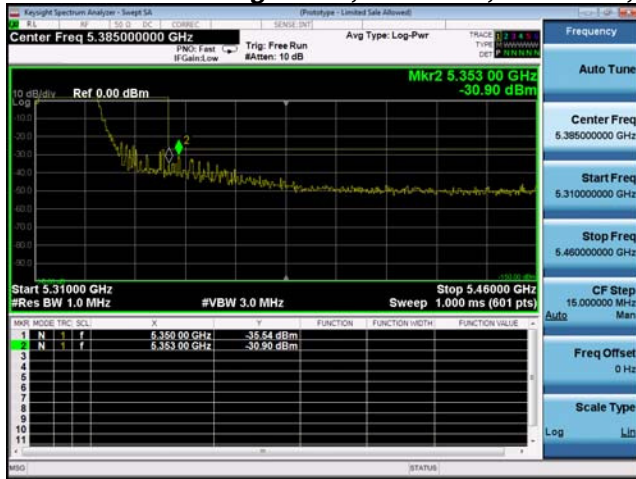

Antenna A

Appendix B: Emission Test Results

Testing Laboratory: Cisco Systems, Inc., 125 West Tasman Drive, San Jose, CA 95134, USA

Radiated Emission Setup Diagram-Below 1G

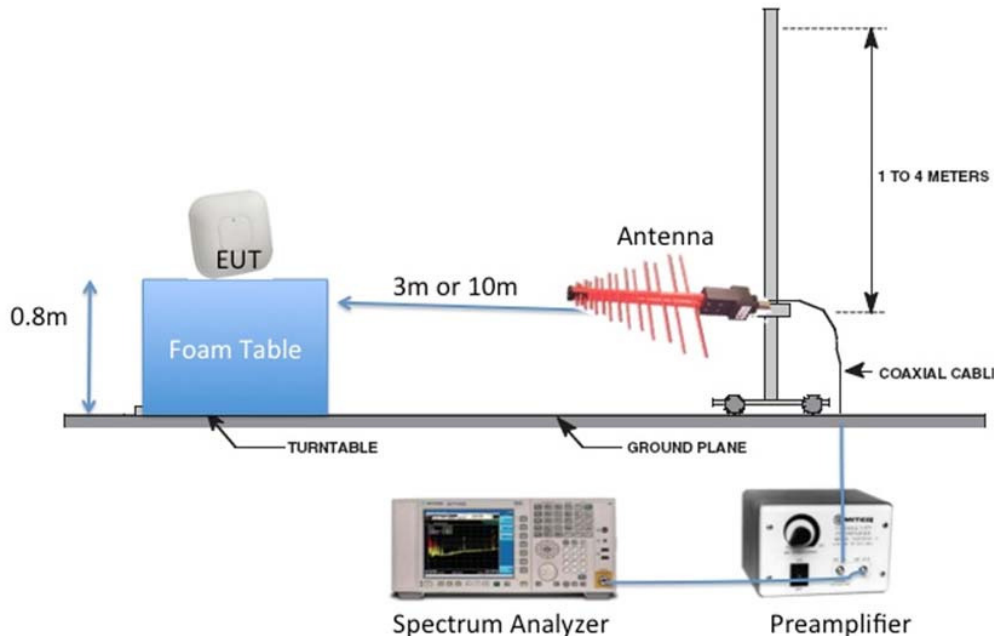

Radiated Emission Setup Diagram-Above 1G

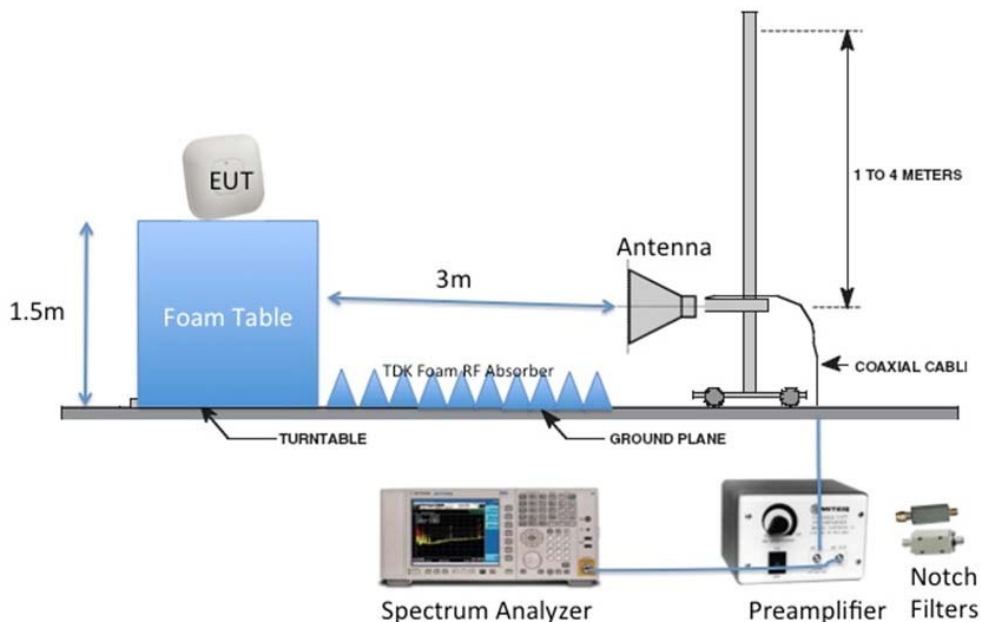



B.1 Radiated Spurious Emissions

15.407 (b) *Undesirable emission limits.* Except as shown in paragraph (b) (7) of this section, the maximum emissions outside of the frequency bands of operation shall be attenuated in accordance with the following limits:

(2) For transmitters operating in the 5.25-5.35 GHz band: All emissions outside of the 5.15-5.35 GHz band shall not exceed an e.i.r.p. of -27 dBm/MHz.

15.205 / 15.209

(7) The provisions of 15.205 apply to intentional radiators operating under this section.
 (6) Unwanted emissions below 1 GHz must comply with the general field strength limits set forth in 15.209.

Ref. ANSI C63.10: 2013 section 12.7.6 (peak) & 12.7.7.3 (average)

Using Vasona, configure the spectrum analyzer as shown below (be sure to enter all losses between the transmitter output and the spectrum analyzer). Place the radio in continuous transmit mode.

Span: 1GHz – 18 GHz/18GHz-26G/26GHz-40GHz
 Reference Level: 80 dBuV
 Attenuation: 10 dB
 Sweep Time: Coupled
 Resolution Bandwidth: 1MHz
 Video Bandwidth: 3 MHz for peak, 1 KHz for average
 Detector: Peak

Terminate the access Point RF ports with 50 ohm loads.

Maximize Turntable (find worst case table angle), Maximize Antenna (find worst case height)

Save 2 plots: 1) Average plot (Vertical and Horizontal), Limit= 54dBuV/m @3m
 2) Peak plot (Vertical and Horizontal), Limit = 74dBuV/m @3m

Place a marker at the end of the restricted band closest to the transmit frequency to show compliance. Also measure any emissions in the restricted bands.

This report represents the worst case data for all supported operating modes and antennas. There are no measurable emissions above 18 GHz.

System Number	Description	Samples	System under test	Support equipment
1	EUT	S01	<input checked="" type="checkbox"/>	<input type="checkbox"/>
	Support	S02	<input type="checkbox"/>	<input checked="" type="checkbox"/>

Tested By : Jose Aguirre	Date of testing: 21-Jan-17 - 06-Feb-17
Test Result : PASS	

See Appendix C for list of test equipment

**B.1.A Transmitter Radiated Spurious Emissions-Average Worst Case**

Frequency (MHz)	Mode	Data Rate (Mbps)	Spurious Emission Level (dBuV/m)	Limit (dBuV/m)	Margin dBuV/m)
5260	Non HT/VHT20, 6 to 54 Mbps	6	47.5	54.0	6.5
5270	HT/VHT40, M0 to M15	m0	46.9	54.0	7.1
5280	Non HT/VHT20, 6 to 54 Mbps	m0x1	46.9	54.0	7.1
5290	HT/VHT80, M0 to M15	6	43.9	54.0	10.1
5310	HT/VHT40, M0 to M15	m0	46.2	54.0	7.8
5320	Non HT/VHT20, 6 to 54 Mbps	6	47.4	54.0	6.6



B.1.A.1 Radiated Transmitter Spurs, 5260 MHz, Non HT/VHT20, 6 to 54 Mbps, Average (1-18GHz)



B.1.A.2 Radiated Transmitter Spurs, 5270 MHz, HT/VHT40, M0 to M15 Average (1-18GHz)





B.1.A.3 Radiated Transmitter Spurs, 5280 MHz, Non HT/VHT20, 6 to 54 Mbps, Average (1-18GHz)



B.1.A.4 Radiated Transmitter Spurs, 5290 MHz, HT/VHT80, M0 to M15, Average (1-18GHz)





B.1.A.5 Radiated Transmitter Spurs, 5310 MHz, HT/VHT40, M0 to M15, Average (1-18GHz)



B.1.A.6 Radiated Transmitter Spurs, 5320 MHz, Non HT/VHT20, 6 to 54 Mbps, Average (1-18GHz)





B.1.P.7 Radiated Transmitter Spurs, All rate, All modes, Peak (18-26.5GHz)

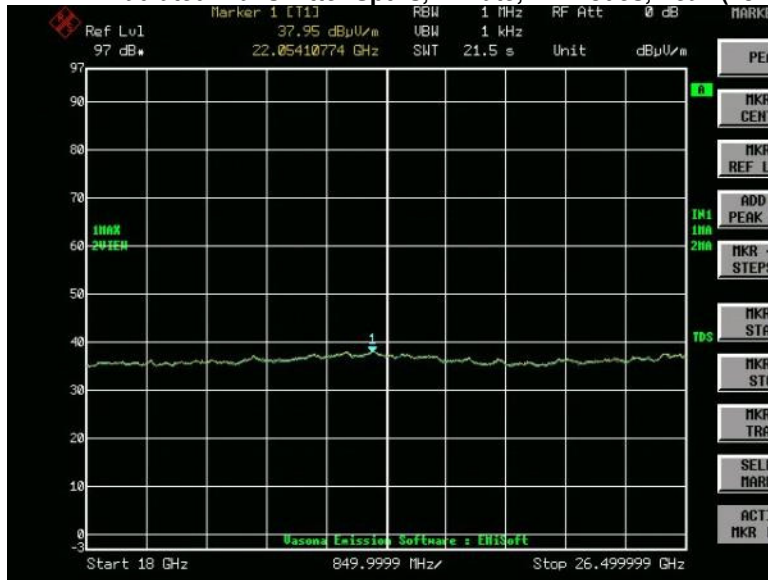

B.1.P.8 Radiated Transmitter Spurs, All rate, All modes, Peak (26.5-40GHz)

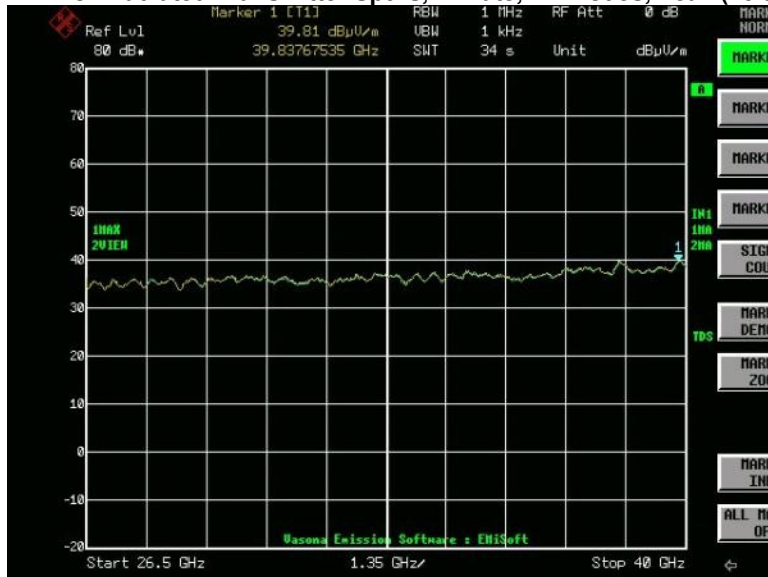

No emissions seen above 18GHz. The plots above are representative of all modes tested.

**B.1.P Transmitter Radiated Spurious Emissions-Peak worst case**

Frequency (MHz)	Mode	Data Rate (Mbps)	Spurious Emission Level (dBuV/m)	Limit (dBuV/m)	Margin dBuV/m)
5260	Non HT/VHT20, 6 to 54 Mbps	6	58.7	74.0	15.3
5270	HT/VHT40, M0 to M15	m0	55.6	74.0	18.4
5280	Non HT/VHT20, 6 to 54 Mbps	6	57.1	74.0	16.9
5290	HT/VHT80, M0 to M15	m0x1	51.8	74.0	22.2
5310	HT/VHT40, M0 to M15	m0	54.7	74.0	19.3
5320	Non HT/VHT20, 6 to 54 Mbps	6	55.3	74.0	18.7



B.1.P.1 Radiated Transmitter Spurs, 5260 MHz, Non HT/VHT20, 6 to 54 Mbps, (1-18GHz)



B.1.P.2 Radiated Transmitter Spurs, 5270 MHz, HT/VHT40, M0 to M15, Peak (1-18GHz)

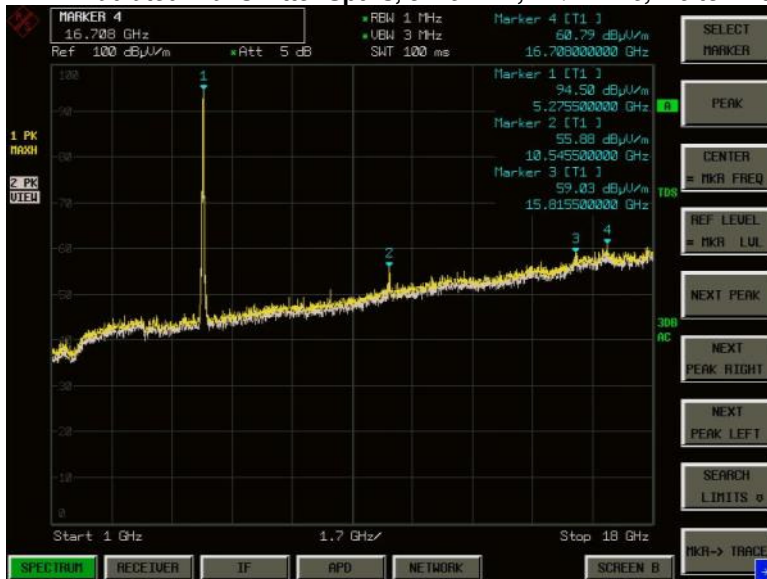



B.1.P.4 Radiated Transmitter Spurs, 5280 MHz, Non HT/VHT20, 6 to 54 Mbps, Peak (1-18GHz)

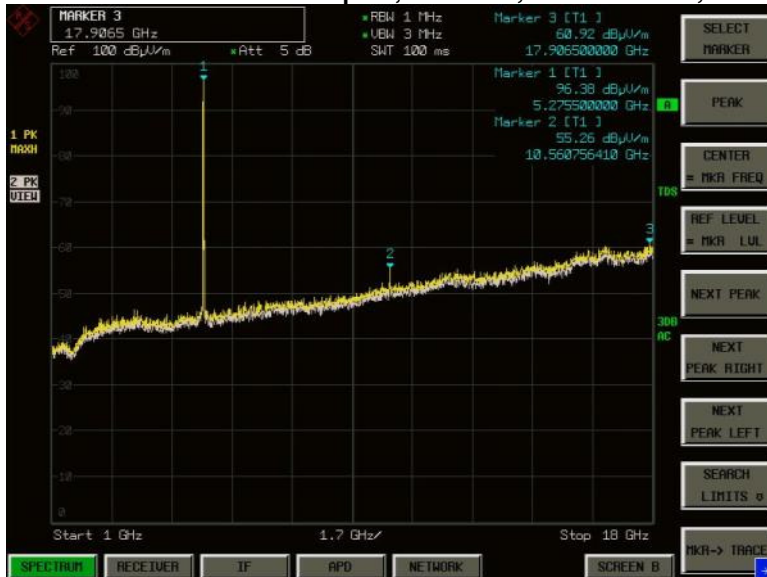

B.1.P.3 Radiated Transmitter Spurs, 5290 MHz, VHT80, M0 to M9, M0 to M9 1.1, Peak (1-18GHz)

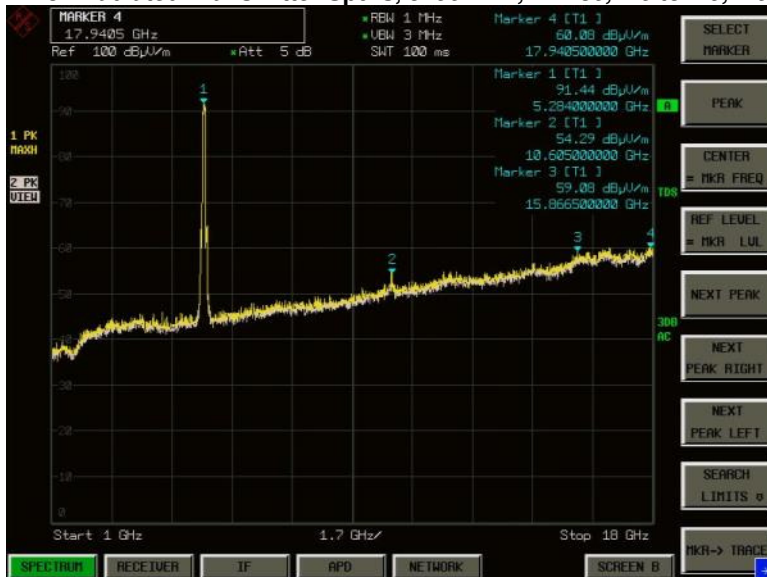



B.1.P.5 Radiated Transmitter Spurs, 5310 MHz, HT/VHT40, M0 to M15, Peak (1-18GHz)

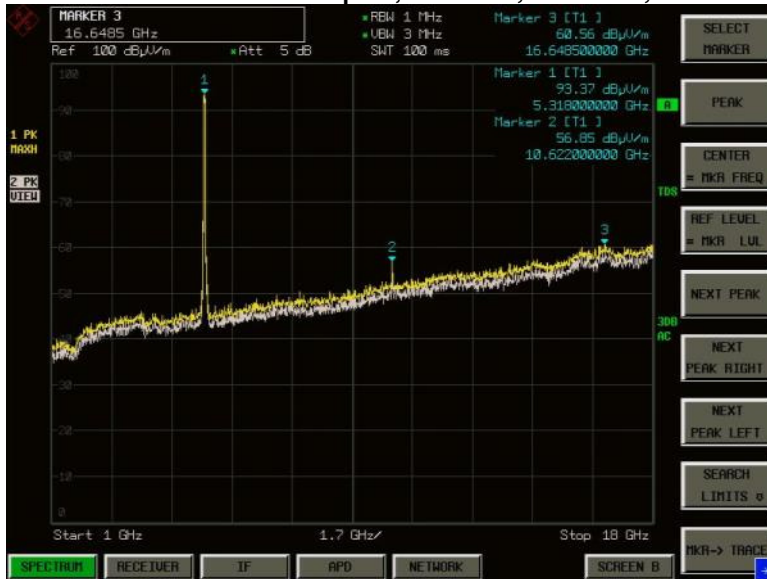

B.1.P.6 Radiated Transmitter Spurs, 5320 MHz, Non HT/VHT20, 6 to 54 Mbps, Peak (1-18GHz)





B.1.P.7 Radiated Transmitter Spurs, All rate, All modes, Peak (18-26.5GHz)

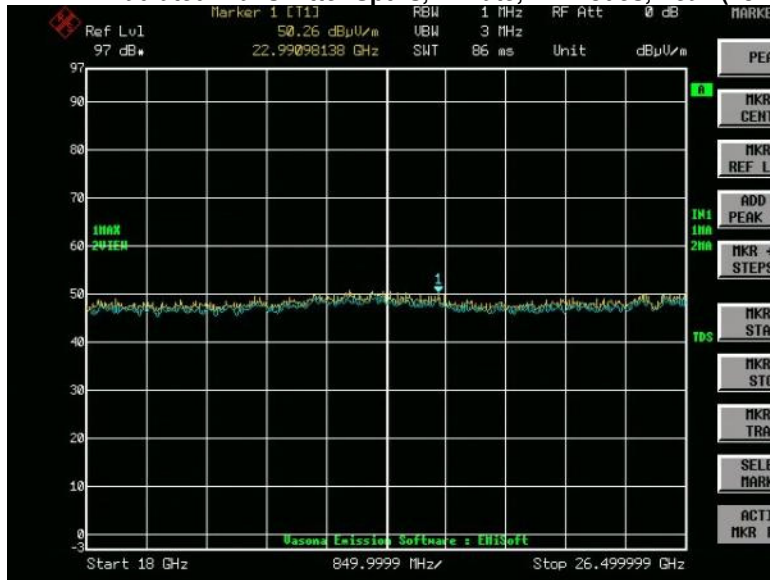

B.1.P.8 Radiated Transmitter Spurs, All rate, All modes, Peak (26.5-40GHz)

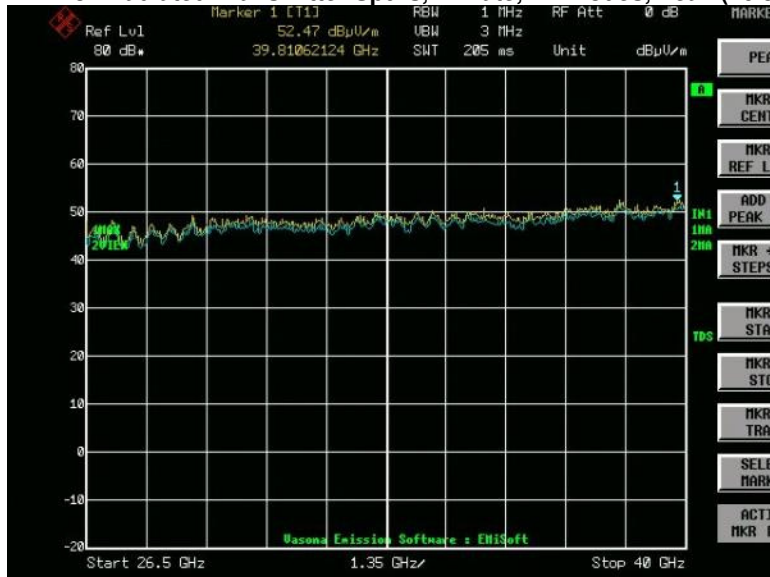

No emissions seen above 18GHz. The plots above are representative of all modes tested.



B.2 Radiated Emissions 30MHz to 1GHz

FCC 15.205 / 15.209

- (7) The provisions of 15.205 apply to intentional radiators operating under this section.
- (6) Unwanted emissions below 1 GHz must comply with the general field strength limits set forth in 15.209.

Ref. ANSI C63.10: 2013 section 6.5

Using Vasona, configure the spectrum analyzer as shown below (be sure to enter all losses between the transmitter output and the spectrum analyzer). Place the radio in continuous transmit mode.

Span:	30MHz – 1GHz
Reference Level:	80 dBuV
Attenuation:	10 dB
Sweep Time:	Coupled
Resolution Bandwidth:	100kHz
Video Bandwidth:	300kHz
Detector:	Peak for Pre-scan, Quasi-Peak

Compliance shall be determined using CISPR quasi-peak detection; however, peak detection is permitted as an alternative to quasi-peak detection.

Terminate the access Point RF ports with 50 ohm loads.

Maximize Turntable (find worst case table angle), Maximize Antenna (find worst case height)

This report represents the worst case data for all supported operating modes and antennas.

System Number	Description	Samples	System under test	Support equipment
1	EUT	S01	<input checked="" type="checkbox"/>	<input type="checkbox"/>
	Support	S02	<input type="checkbox"/>	<input checked="" type="checkbox"/>

Tested By : Jose Aguirre	Date of testing: 21-Jan-17 - 06-Feb-17
Test Result : PASS	

See Appendix C for list of test equipment



Graphical Test Results

Note that the data displayed on the plots detailed in this appendix were measured using a 'Peak Detector'. Please refer to the results table for the detectors used during formal measurements

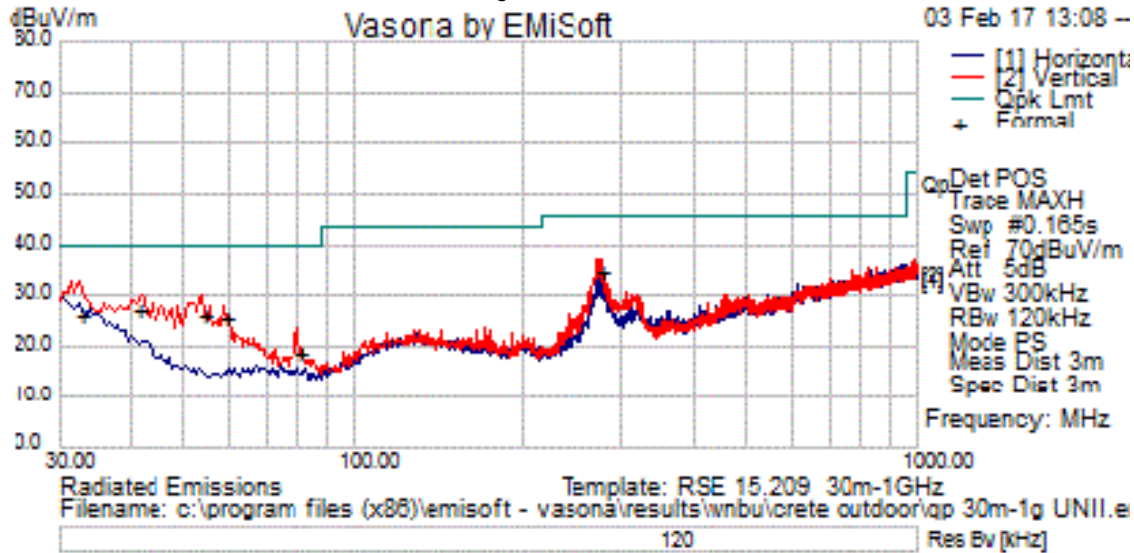

Test Results

Frequency MHz	Raw dBuV	Cable Loss	AF dB	Level dBuV/m	Measurement Type	Pol	Hgt cm	Azt Deg	Limit dBuV/m	Margin dB	Pass /Fail
32.635	6.3	0.4	19.4	26.2	Quasi Max	V	104	360	40	-13.8	Pass
274.02	19.6	1.5	13.4	34.5	Quasi Max	V	101	327	46	-11.5	Pass
41.223	13.8	0.5	13.1	27.4	Quasi Max	V	103	22	40	-12.6	Pass
53.853	18.6	0.7	7.2	26.4	Quasi Max	V	102	258	40	-13.6	Pass
58.698	17.7	0.7	7.3	25.7	Quasi Max	V	107	135	40	-14.3	Pass
79.843	10.3	0.8	7.7	18.9	Quasi Max	V	127	160	40	-21.1	Pass



B.3 AC Conducted Emissions

FCC 15.207 (a) & RSS-Gen 8.8 / LP0002:2.3 Except when the requirements applicable to a given device state otherwise, for any radio apparatus equipped to operate from the public utility AC power supply, either directly or indirectly (such as with a battery charger), the radio frequency voltage of emissions conducted back onto the AC power lines in the frequency range of 0.15 MHz to 30 MHz shall not exceed the limits shown in the table in these sections. The more stringent limit applies at the frequency range boundaries.

Measurement Procedure
Accordance with ANSI C63.10:2013 section 6.2

Using Vasona, configure the spectrum analyzer as shown below (be sure to enter all losses between the transmitter output and the spectrum analyzer). Place the radio in continuous transmit mode.

Span:	150 KHz – 30 MHz
Attenuation:	10 dB
Sweep Time:	Coupled
Resolution Bandwidth:	9 KHz
Video Bandwidth:	30 KHz
Detector:	Quasi-Peak / Average

System Number	Description	Samples	System under test	Support equipment
1	EUT	S01	<input checked="" type="checkbox"/>	<input type="checkbox"/>
	Support	S02	<input type="checkbox"/>	<input checked="" type="checkbox"/>

Tested By : Jose Aguirre	Date of testing: 21-Jan-17 - 06-Feb-17
Test Result : PASS	

See separate EMC test report for test data.



Graphical Test Results

Note that the data displayed on the plots detailed in this appendix were measured using a 'Peak Detector'. Please refer to the results table for the detectors used during formal measurements

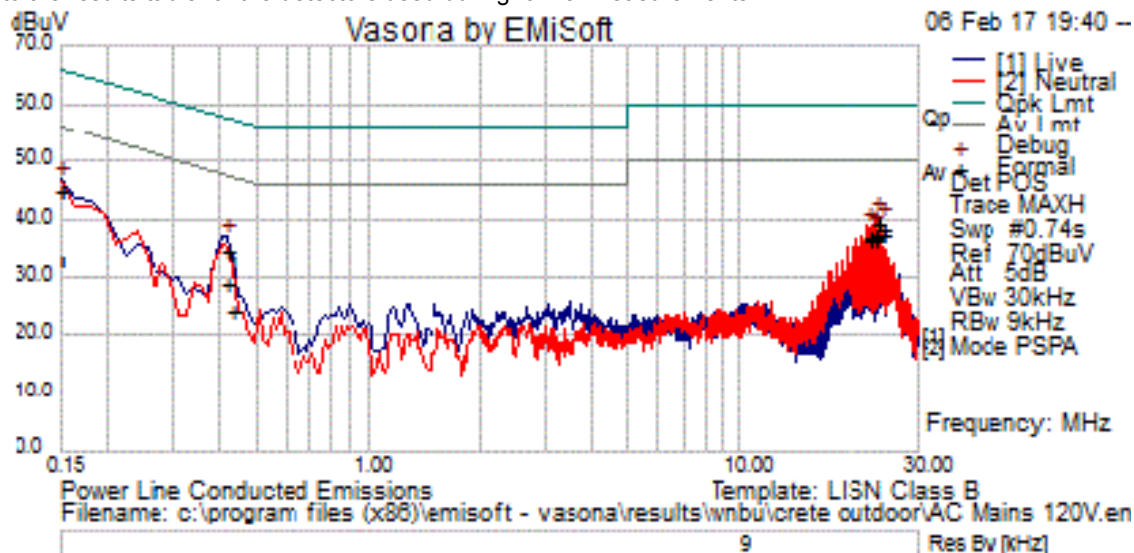

Test Results

Frequency MHz	Raw dBuV	Cable Loss	Factors dB	Level dBuV	Measurement Type	Line	Limit dBuV	Margin dB	Pass /Fail
0.429	12.9	20	0	32.9	Quasi Peak	Live	57.3	-24.3	Pass
23.287	19	20.4	0.3	39.7	Quasi Peak	Live	60	-20.3	Pass
0.15	23.8	21.1	0.1	44.9	Quasi Peak	Live	66	-21.1	Pass
24.015	17.7	20.4	0.3	38.4	Quasi Peak	Live	60	-21.6	Pass
22.802	16.8	20.4	0.3	37.6	Quasi Peak	Live	60	-22.4	Pass
22.074	16.6	20.4	0.3	37.4	Quasi Peak	Live	60	-22.6	Pass
23.285	19	20.4	0.3	39.8	Quasi Peak	Neutral	60	-20.2	Pass
0.15	23.8	21	0.1	45	Quasi Peak	Neutral	66	-21	Pass
22.802	16.7	20.4	0.3	37.4	Quasi Peak	Neutral	60	-22.6	Pass
22.073	16.6	20.4	0.3	37.4	Quasi Peak	Neutral	60	-22.6	Pass
24.014	17.7	20.4	0.3	38.5	Quasi Peak	Neutral	60	-21.5	Pass
0.416	14.9	20	0	34.9	Quasi Peak	Neutral	57.5	-22.6	Pass
0.429	4.2	20	0	24.2	Average	Live	47.3	-23.1	Pass
23.287	18.7	20.4	0.3	39.4	Average	Live	50	-10.6	Pass
0.15	11.8	21.1	0.1	32.9	Average	Live	56	-23.1	Pass
24.015	17.1	20.4	0.3	37.8	Average	Live	50	-12.2	Pass
22.802	16.4	20.4	0.3	37.1	Average	Live	50	-12.9	Pass
22.074	16	20.4	0.3	36.7	Average	Live	50	-13.3	Pass
23.285	18.6	20.4	0.3	39.4	Average	Neutral	50	-10.6	Pass
0.15	11.9	21	0.1	33	Average	Neutral	56	-23	Pass
22.802	16.1	20.4	0.3	36.8	Average	Neutral	50	-13.2	Pass
22.073	15.9	20.4	0.3	36.7	Average	Neutral	50	-13.3	Pass
24.014	17.1	20.4	0.3	37.8	Average	Neutral	50	-12.2	Pass
0.416	8.8	20	0	28.9	Average	Neutral	47.5	-18.7	Pass

Photographs of setup**Title: Conducted Test Setup**

This is a dual band 2.4GHz / 5GHz device. All ports in this test set up photo are connected as all testing is automated. Section 2.6 of this test report given an overview of the different Tx antenna combinations used by this device.

AIR-AP1542D-x-K9 AC Mains Conducted Emissions setup





AIR-AP1542D-x-K9 Radiated Emissions setup 30MHz – 1GHz



AIR-AP1542D-x-K9 Radiated Emissions setup above 1GHz

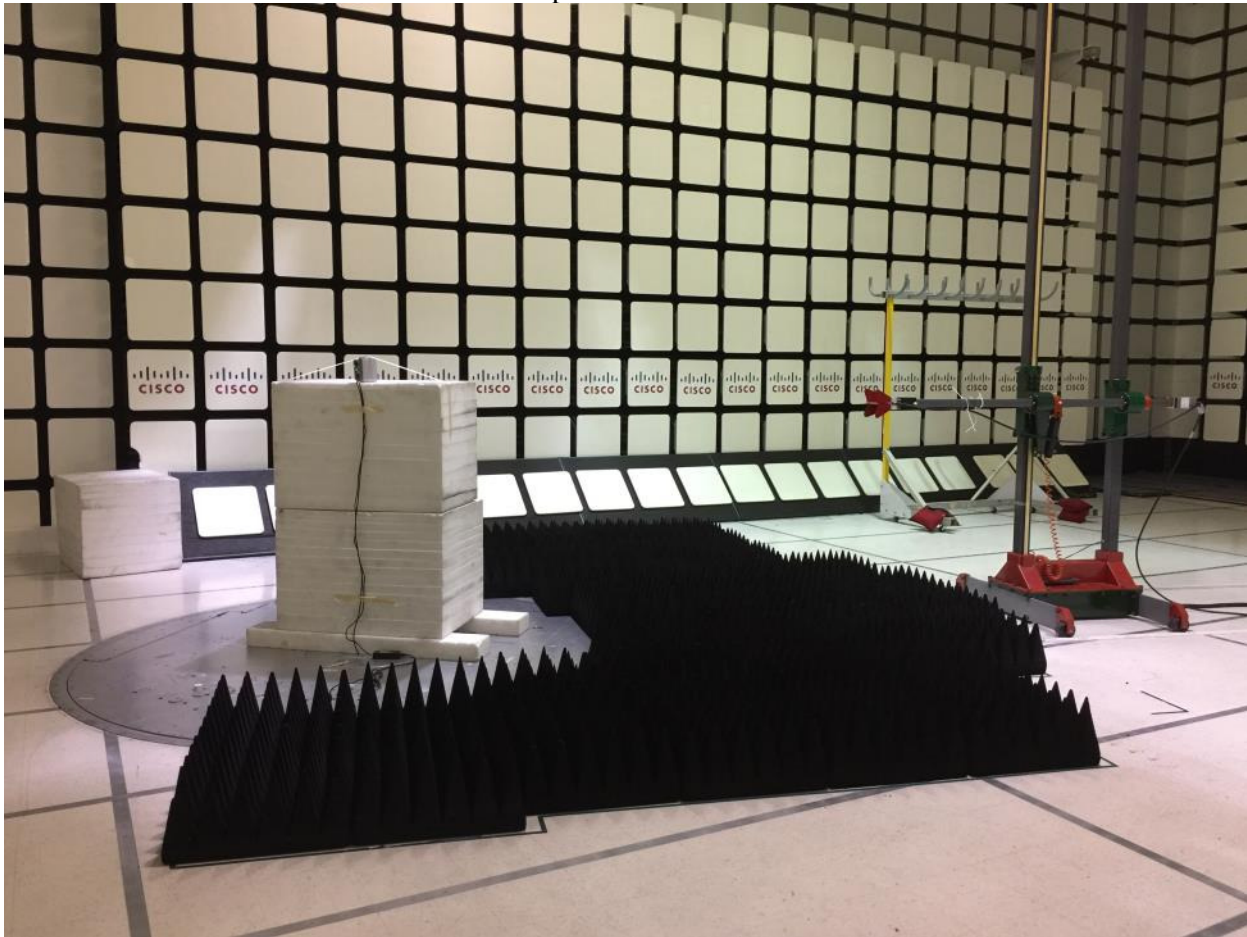



Appendix C: List of Test Equipment Used to perform the test

Test Equipment used for Radiated Emissions					
Equip No	Model Manufacturer	Description	Last Cal	Next Cal	Test Item
CIS041929	iBTHP-5-DB9 Newport	5 inch Temp/RH/Press Sensor w/20ft cable	22-Dec-16	22-Dec-17	B.1, B.2, B.3
CIS001937	NSA 5m Chamber Cisco	NSA 5m Chamber	12-Feb-16	12-Feb-17	B.3
CIS049535	Above 1GHz Site Cal Cisco	Above 1GHz CISPR Site Validation	13-Feb-16	13-Feb-17	B.1, B.2
CIS028072	1840 Cisco	18-40GHz EMI Test Head	22-Feb-16	22-Feb-17	B.1, B.2
CIS045588	JB1 Sunol Sciences	Combination Antenna, 30MHz-2GHz	9-Mar-16	9-Mar-17	B.3
CIS042000	E4440A Agilent	Spectrum Analyzer	6-Jul-16	6-Jul-17	B.1, B.2
CIS037581	3117 ETS-Lindgren	Horn Antenna	7-Oct-16	7-Oct-17	B.1, B.2
CIS045098	TH0118 Cisco	Mast Mount Preamp Array, 1-18GHz	31-Oct-16	31-Oct-17	B.1, B.2
CIS033602	CSY-NMNM-80-273001 Midwest Microwave	RF Coaxial Cable, to 18GHz	8-Nov-16	8-Nov-17	B.1, B.2, B.3
CIS030443	UFB311A-0-1560-520520 Micro-Coax	RF Coaxial Cable, to 18GHz	8-Nov-16	8-Nov-17	B.1, B.2, B.3
CIS008024	SF106A Huber + Suhner	3 meter Sucoflex cable	8-Nov-16	8-Nov-17	B.1, B.2, B.3
CIS024201	FSEK30 Rohde & Schwarz	Spectrum Analyzer 20Hz - 40GHz	23-Nov-16	23-Nov-17	B.1, B.2
CIS037235	50CB-015 JFW	GPIB Control Box	Cal not Required	Cal not Required	B.1, B.2
CIS035244	926-8ME Klein Tools	8 Meter Tape Measure	Cal not Required	Cal not Required	B.1, B.2, B.3
CIS043124	Above 1GHz Site Cal Cisco	Above 1GHz Cispr Site Verification	14-Jan-16	14-Jan-17	B.1, B.2
CIS047300	N9038A Agilent Technologies	MXE EMI Receiver 20Hz to 26.5 Ghz	28-Jan-16	28-Jan-17	B.1, B.2, B.3
CIS030559	UFB311A-1-0950-504504 Micro-Coax	RF Coaxial Cable, to 18GHz, 95 in	15-Feb-16	15-Feb-17	B.1, B.2, B.3
CIS020975	UFB311A-0-1344-520520 Micro-Coax	RF Coaxial Cable, to 18GHz, 134.4 in	17-Feb-16	17-Feb-17	B.1, B.2, B.3
CIS019630	ESI 40(ESIB 40) Rohde & Schwarz	EMI Test Receiver, 20Hz - 40GHz	22-Feb-16	22-Feb-17	B.1, B.2
CIS008447	NSA 10m Chamber Cisco	NSA 10m Chamber	14-Oct-16	14-Oct-17	B.3
CIS036710	1840 Cisco	18-40GHz EMI Test Head/Verification Fixture	17-Nov-16	17-Nov-17	B.1, B.2
CIS030652	JB1 Sunol Sciences	Combination Antenna, 30MHz-2GHz	16-Dec-16	16-Dec-17	B.3



Test Equipment used for AC Mains Conducted Emissions					
Equip No	Model Manufacturer	Description	Last Cal	Next Cal	Test Item
CIS051642	Sucoflex 106PA Huber+Suhner	RF N Type Cable 8.5m	11-Feb-16	11-Feb-17	B.4
CIS030559	UFB311A-1-0950-504504 Micro-Coax	RF Coaxial Cable, to 18GHz, 95 in	15-Feb-16	15-Feb-17	B.4
CIS020975	UFB311A-0-1344-520520 Micro-Coax	RF Coaxial Cable, to 18GHz, 134.4 in	17-Feb-16	17-Feb-17	B.4
CIS046717	5-T-MB Bird	5W 50 Ohm BNC Termination 4GHz	9-Mar-16	9-Mar-17	B.4
CIS008510	FCC-450B-2.4-N Fischer Custom Communications	Instrumentation Limiter	16-May-16	16-May-17	B.4
CIS023796	FCC-LISN-PA-520R Fischer Custom Communications	POWER ADAPTOR, POLARIZED 120VAC	27-Jul-16	27-Jul-17	B.4
CIS023794	FCC-LISN-50/250-50-2-02 Fischer Custom Communications	LISN	27-Jul-16	27-Jul-17	B.4
CIS019206	H785-150K-50-21378 TTE	High Pas Filter, Fo=150kHz	13-Sep-16	13-Sep-17	B.4
CIS005687	73 III Fluke	Digital Multimeter	3-Nov-16	3-Nov-17	B.4
CIS041929	iBTHP-5-DB9 Newport	5 inch Temp/RH/Press Sensor w/20ft cable	22-Dec-16	22-Dec-17	B.4
CIS054645	33-428 Stanley	Tape measure 8 meter	Cal Not Required	Cal Not Required	B.4

Test Equipment used for RF Conducted Tests					
Equip No	Model Manufacturer	Description	Last Cal	Next Cal	Test Item
CIS049445	BRC50704-02 Micro-Tronics	Notch Filter, SB:5.470-5.725GHz, to 12GHz	12-Apr-16	12-Apr-17	A1 thru A6
CIS035038	BRC50703-02 Micro-Tronics	Notch Filter, SB:5.150-5.350GHz, to 11GHz	6-Jul-16	6-Jul-17	A1 thru A6
CIS055561	F120-S1S1-48 MegaPhase	SMA Cable 48"	15-Jul-16	15-Jul-17	A1 thru A6
CIS054635	F120-S1S1-48 Megaphase	SMA cable 48"	15-Jul-16	15-Jul-17	A1 thru A6
CIS055588	BWS30-W2 Aeroflex	SMA 30dB Attenuator	21-Jul-16	21-Jul-17	A1 thru A6
CIS055578	BWS20-W2 Aeroflex	SMA 20dB Attenuator	21-Jul-16	21-Jul-17	A1 thru A6
CIS054656	BRC50705-02 Micro-Tronics	Band Reject Filter	19-Sep-16	19-Sep-17	A1 thru A6
CIS054653	BRM50702-02 Micro-Tronics	Notch Filter, SB:2.400-2.500GHz, to 18GHz	19-Sep-16	19-Sep-17	A1 thru A6
CIS055858	SMSM-A2PH-012 Dynawave	12" SMA Cable	29-Sep-16	29-Sep-17	A1 thru A6
CIS055856	SMSM-A2PH-012 Dynawave	12" SMA Cable	29-Sep-16	29-Sep-17	A1 thru A6
CIS055849	SMSM-A2PH-012 Dynawave	12" SMA Cable	29-Sep-16	29-Sep-17	A1 thru A6
CIS055848	SMSM-A2PH-012 Dynawave	12" SMA Cable	29-Sep-16	29-Sep-17	A1 thru A6
CIS055847	SMSM-A2PH-012 Dynawave	12" SMA Cable	29-Sep-16	29-Sep-17	A1 thru A6
CIS055846	SMSM-A2PH-012	12" SMA Cable	29-Sep-16	29-Sep-17	A1 thru A6



	Dynawave				
CIS055845	SMSM-A2PH-012 Dynawave	12" SMA Cable	29-Sep-16	29-Sep-17	A1 thru A6
CIS055844	SMSM-A2PH-012 Dynawave	12" SMA Cable	29-Sep-16	29-Sep-17	A1 thru A6
CIS055843	SMSM-A2PH-012 Dynawave	12" SMA Cable	29-Sep-16	29-Sep-17	A1 thru A6
CIS055842	SMSM-A2PH-012 Dynawave	12" SMA cable	29-Sep-16	29-Sep-17	A1 thru A6
CIS055874	SMSM-A2PH-024 Dynawave	24" SMA Cable	7-Oct-16	7-Oct-17	A1 thru A6
CIS055872	SMSM-A2PH-024 Dynawave	24" SMA Cable	7-Oct-16	7-Oct-17	A1 thru A6
CIS055868	SMSM-A2PH-024 Dynawave	24" SMA Cable	7-Oct-16	7-Oct-17	A1 thru A6
CIS055867	SMSM-A2PH-024 Dynawave	24" SMA Cable	7-Oct-16	7-Oct-17	A1 thru A6
CIS055885	SMSM-A2PH-018 Dynawave	18" SMA Cable	10-Oct-16	10-Oct-17	A1 thru A6
CIS055170	RFLT4WDC40GK RF Lambda	4 Way Power Divider 40GHz	29-Nov-16	29-Nov-17	A1 thru A6
CIS050721	N9030A Keysight	PXA Signal Analyzer	30-Mar-16	30-Mar-17	A1 thru A6
CIS054303	N5182B Keysight	MXG X-Series RF Vector Signal Generator	6-Apr-16	6-Apr-17	A1 thru A6
CIS055099	SMART2200RM2U Tripp-Lite	Power Supply	Cal Not Required	Cal Not Required	A1 thru A6
CIS055094	PXI-1042 National Instruments	Chassis	Cal Not Required	Cal Not Required	A1 thru A6



Appendix E: Abbreviation Key and Definitions

The following table defines abbreviations used within this test report.

Abbreviation	Description	Abbreviation	Description
EMC	Electro Magnetic Compatibility	°F	Degrees Fahrenheit
EMI	Electro Magnetic Interference	°C	Degrees Celsius
EUT	Equipment Under Test	Temp	Temperature
ITE	Information Technology Equipment	S/N	Serial Number
TAP	Test Assessment Schedule	Qty	Quantity
ESD	Electro Static Discharge	emf	Electromotive force
EFT	Electric Fast Transient	RMS	Root mean square
EDCS	Engineering Document Control System	Qp	Quasi Peak
Config	Configuration	Av	Average
CIS#	Cisco Number (unique identification number for Cisco test equipment)	Pk	Peak
Cal	Calibration	kHz	Kilohertz (1×10^3)
EN	European Norm	MHz	MegaHertz (1×10^6)
IEC	International Electro technical Commission	GHz	Gigahertz (1×10^9)
CISPR	International Special Committee on Radio Interference	H	Horizontal
CDN	Coupling/Decoupling Network	V	Vertical
LISN	Line Impedance Stabilization Network	dB	decibel
PE	Protective Earth	V	Volt
GND	Ground	kV	Kilovolt (1×10^3)
L1	Line 1	μ V	Microvolt (1×10^{-6})
L2	Line2	A	Amp
L3	Line 3	μ A	Micro Amp (1×10^{-6})
DC	Direct Current	mS	Milli Second (1×10^{-3})
RAW	Uncorrected measurement value, as indicated by the measuring device	μ S	Micro Second (1×10^{-6})
RF	Radio Frequency	μ S	Micro Second (1×10^{-6})
SLCE	Signal Line Conducted Emissions	m	Meter
Meas dist	Measurement distance	Spec dist	Specification distance
N/A or NA	Not Applicable	SL	Signal Line (or Telecom Line)
P	Power Line	L	Live Line
N	Neutral Line	R	Return
S	Supply	AC	Alternating Current



End