

Test Report

AIR-AP1815I-B-K9

Cisco Aironet 802.11ac Dual Band Access Points

FCC ID: LDK102108

5470-5725 MHz

Against the following Specifications:

CFR47 Part 15.407



Cisco Systems

170 West Tasman Drive

San Jose, CA 95134

| | |
|---|---|
|  |  |
| <p>Author: Jose Aguirre Tested By:</p> | <p>Approved By: Jim Nicholson Title: Technical Leader, Engineering Revision: 1</p> |

This report replaces any previously entered test report under EDCS – **1570573**. This test report has been electronically authorized and archived using the CISCO Engineering Document Control system.

This test report has been electronically authorized and archived using the CISCO Engineering Document Control system.

| | |
|--|-----------|
| SECTION 1: OVERVIEW | 3 |
| SECTION2: ASSESSMENT INFORMATION | 4 |
| 2.1 GENERAL | 4 |
| 2.2 DATE OF TESTING..... | 6 |
| 2.3 REPORT ISSUE DATE | 6 |
| 2.4 TESTING FACILITIES | 6 |
| 2.5 EQUIPMENT ASSESSED (EUT)..... | 6 |
| 2.6 EUT DESCRIPTION..... | 7 |
| SECTION 3: RESULT SUMMARY | 8 |
| 3.1 RESULTS SUMMARY TABLE | 8 |
| SECTION 4: SAMPLE DETAILS..... | 9 |
| 4.1 SAMPLE DETAILS | 9 |
| 4.2 SYSTEM DETAILS | 9 |
| 4.3 MODE OF OPERATION DETAILS..... | 9 |
| APPENDIX A: EMISSION TEST RESULTS | 10 |
| CONDUCTED TEST SETUP DIAGRAM..... | 10 |
| TARGET MAXIMUM CHANNEL POWER | 10 |
| A.1 99% AND 26DB BANDWIDTH | 11 |
| A.2 MAXIMUM CONDUCTED OUTPUT POWER/ POWER SPECTRAL DENSITY | 25 |
| A.3 CONDUCTED SPURIOUS EMISSIONS | 36 |
| A.4 CONDUCTED BANDEDGE..... | 46 |
| APPENDIX B: EMISSION TEST RESULTS | 51 |
| RADIATED EMISSION SETUP DIAGRAM-BELOW 1G..... | 51 |
| B.1 RADIATED SPURIOUS EMISSIONS | 52 |
| B.2 RADIATED EMISSIONS 30MHZ TO 1GHZ | 65 |
| B.3 AC CONDUCTED EMISSIONS | 67 |
| APPENDIX C: LIST OF TEST EQUIPMENT USED TO PERFORM THE TEST | 72 |
| APPENDIX E: ABBREVIATION KEY AND DEFINITIONS | 75 |

Section 1: Overview

The samples were assessed against the tests detailed in section 3 under the requirements of the following specifications:

| |
|------------------------|
| Specifications: |
| CFR47 Part 15.407 |

Measurements were made in accordance with

- ANSI C63.10:2013
- KDB 789033 D02 General UNII Test Procedures New Rules v01r03
- KDB 662911 D01 Multiple Transmitter Output v02r01

Section2: Assessment Information

2.1 General

This report contains an assessment of an apparatus against Electromagnetic Compatibility Standards based upon tests carried out on the samples submitted. The testing was performed by and for the use of Cisco systems Inc:

With regard to this assessment, the following points should be noted:

- a) The results contained in this report relate only to the items tested and were obtained in the period between the date of the initial assessment and the date of issue of the report. Manufactured products will not necessarily give identical results due to production and measurement tolerances.
- b) The apparatus was set up and exercised using the configuration and modes of operation defined in this report only.
- c) Where relevant, the apparatus was only assessed using the susceptibility criteria defined in this report and the Test Assessment Plan (TAP).
- d) All testing was performed under the following environmental conditions:

| | |
|----------------------|--------------------------------------|
| Temperature | 15°C to 35°C (54°F to 95°F) |
| Atmospheric Pressure | 860mbar to 1060mbar (25.4" to 31.3") |
| Humidity | 10% to 75*% |
- e) All AC testing was performed at one or more of the following supply voltages:
110V 60 Hz (+/-20%)

Units of Measurement

The units of measurements defined in the appendices are reported in specific terms, which are test dependent. Where radiated measurements are concerned these are defined at a particular distance. Basic voltage measurements are defined in units of [dBuV]

As an example, the basic calculation for all measurements is as follows:

$$\text{Emission level [dBuV]} = \text{Indicated voltage level [dBuV]} + \text{Cable Loss [dB]} + \text{Other correction factors [dB]}$$

The combinations of correction factors are dependent upon the exact test configurations [see test equipment lists for further details] and may include:-

Antenna Factors, Pre Amplifier Gain, LISN Loss, Pulse Limiter Loss and Filter Insertion Loss

Note: to convert the results from dBuV/m to uV/m use the following formula:-

$$\text{Level in uV/m} = \text{Common Antilogarithm} [(X \text{ dBuV/m})/20] = Y \text{ uV/m}$$

Measurement Uncertainty Values

| | |
|-----------------------------------|-------------------------|
| voltage and power measurements | ± 2 dB |
| conducted EIRP measurements | ± 1.4 dB |
| radiated measurements | ± 3.2 dB |
| frequency measurements | $\pm 2.4 \cdot 10^{-7}$ |
| temperature measurements | $\pm 0.54^{\circ}$ |
| humidity measurements | $\pm 2.3\%$ |
| DC and low frequency measurements | $\pm 2.5\%$ |

Where relevant measurement uncertainty levels have been estimated for tests performed on the apparatus. This uncertainty represents an expanded uncertainty expressed at approximately the 95% confidence level using a coverage factor of $k=2$.

Radiated emissions (expanded uncertainty, confidence interval 95%)

| | |
|--------------------|------------|
| 30 MHz - 300 MHz | +/- 3.8 dB |
| 300 MHz - 1000 MHz | +/- 4.3 dB |
| 1 GHz - 10 GHz | +/- 4.0 dB |
| 10 GHz - 18GHz | +/- 8.2 dB |
| 18GHz - 26.5GHz | +/- 4.1 dB |
| 26.5GHz - 40GHz | +/- 3.9 dB |

Conducted emissions (expanded uncertainty, confidence interval 95%)

| | |
|----------------|-------------|
| 30 MHz – 40GHz | +/- 0.38 dB |
|----------------|-------------|

A product is considered to comply with a requirement if the nominal measured value is below the limit line. The product is considered to not be in compliance in case the nominal measured value is above the limit line.

This report must not be reproduced except in full, without written approval of Cisco Systems.

2.2 Date of testing

01-Jun-16 - 26-Jun-16

2.3 Report Issue Date

30-June-2016

Cisco uses an electronic system to issue, store and control the revision of test reports. This system is called the Engineering Document Control System (EDCS). The actual report issue date is embedded into the original file on EDCS. Any copies of this report, either electronic or paper, that are not on EDCS must be considered uncontrolled.

2.4 Testing facilities

This assessment was performed by:

Testing Laboratory

Cisco Systems, Inc.,
125 West Tasman Drive
San Jose, CA 95134, USA

Registration Numbers for Industry Canada

| Cisco System Site | Address | Site Identifier |
|--------------------------|---|------------------------|
| Building P, 10m Chamber | 125 West Tasman Dr San Jose, CA 95134 | Company #: 2461N-2 |
| Building P, 5m Chamber | 125 West Tasman Dr San Jose, CA 95134 | Company #: 2461N-1 |
| Building I, 5m Chamber | 285 W. Tasman Drive San Jose, California 95134 | Company #: 2461M-1 |

Test Engineers

Jose Aguirre

2.5 Equipment Assessed (EUT)

AIR-AP1815I-A-K9

2.6 EUT Description

The Cisco Aironet 802.11ac Radio supports the following modes of operation. The modes are further defined in the radio Theory of Operation. The modes included in this report represent the worst case data for all modes.

- 802.11n/ac - Non HT20, One Antenna, 6 to 54 Mbps
- 802.11n/ac - Non HT20, Two Antennas, 6 to 54 Mbps

- 802.11n/ac - HT/VHT20, One Antenna, M0 to M7
- 802.11n/ac - HT/VHT20, Two Antennas, M0 to M7
- 802.11n/ac - HT/VHT20, Two Antennas, M8 to M15

- 802.11n/ac - HT/VHT20 Beam Forming, Two Antennas, M0 to M7
- 802.11n/ac - HT/VHT20 Beam Forming, Two Antennas, M8 to M15

- 802.11n/ac - HT/VHT20 STBC, Two Antennas, M0 to M7

- 802.11n/ac - Non HT40 Duplicate, One Antenna, 6 to 54 Mbps
- 802.11n/ac - Non HT40 Duplicate, Two Antennas, 6 to 54 Mbps

- 802.11n/ac - HT/VHT40, One Antenna, M0 to M7
- 802.11n/ac - HT/VHT40, Two Antennas, M0 to M7
- 802.11n/ac - HT/VHT40, Two Antennas, M8 to M15

- 802.11n/ac - HT/VHT40 Beam Forming, Two Antennas, M0 to M7
- 802.11n/ac - HT/VHT40 Beam Forming, Two Antennas, M8 to M15

- 802.11n/ac - HT/VHT40 STBC, Two Antennas, M0 to M7

- 802.11n/ac - Non HT80 Duplicate, One Antenna, 6 to 54 Mbps
- 802.11n/ac - Non HT80 Duplicate, Two Antennas, 6 to 54 Mbps

- 802.11ac - VHT80, One Antenna, M0 to M9 1ss
- 802.11ac - VHT80, Two Antennas, M0 to M9 1ss
- 802.11ac - VHT80, Two Antennas, M0 to M9 2ss

- 802.11ac - VHT80 Beam Forming, Two Antennas, M0 to M9 1ss
- 802.11ac - VHT80 Beam Forming, Two Antennas, M0 to M9 2ss

- 802.11ac - VHT80 STBC, Two Antennas, M0 to M9 1ss

The following antennas are supported by this product series.
The data included in this report represent the worst case data for all antennas.

| Frequency | Part Number | Antenna Type | Antenna Gain (dBi) |
|--------------------|--------------|--------------|--------------------|
| 2.4 / 5 GHz | 2x2 Internal | Omni | 2 / 4 |

Section 3: Result Summary

3.1 Results Summary Table

Conducted emissions

| Basic Standard | Technical Requirements / Details | Result |
|--|---|--------|
| FCC 15.407 | <p>99% & 26 dB Bandwidth: The 99% occupied bandwidth is the frequency bandwidth such that, below its lower and above its upper frequency limits, the mean powers are each equal to 0.5% of the total mean power of the given emission. There is no limit for 99% OBW.</p> <p>The 26 dB emission is the width of the emission that is constrained by the frequencies associated with the two outermost amplitude points (upper and lower frequencies) that are attenuated by 26 dB relative to the maximum level measured in the fundamental emission.</p> | Pass |
| FCC 15.407 | <p>Output Power: 15.407 (2) For the 5.25-5.35 GHz and 5.47-5.725 GHz bands, the maximum conducted output power over the frequency bands of operation shall not exceed the lesser of 250 mW or 11 dBm + 10 log B, where B is the 26 dB emission bandwidth in megahertz. In addition, the maximum power spectral density shall not exceed 11 dBm in any 1 megahertz band. If transmitting antennas of directional gain greater than 6 dBi are used, both the maximum conducted output power and the maximum power spectral density shall be reduced by the amount in dB that the directional gain of the antenna exceeds 6 dBi.</p> | Pass |
| FCC 15.407 | <p>Power Spectral Density: 15.407 The maximum power spectral density shall not exceed 17 dBm in any 1 megahertz band. If transmitting antennas of directional gain greater than 6 dBi are used, both the maximum conducted output power and the maximum power spectral density shall be reduced by the amount in dB that the directional gain of the antenna exceeds 6 dBi.</p> | Pass |
| FCC 15.407 | <p>Conducted Spurious Emissions / Band-Edge: 15.407 (3) For transmitters operating in the 5.47-5.725 GHz band: All emissions outside of the 5.47-5.725 GHz band shall not exceed an e.i.r.p. of -27 dBm/MHz.</p> | Pass |
| FCC 15.407 FCC 15.209 FCC 15.205 | <p>Restricted band: Unwanted emissions falling within the restricted bands, as defined in FCC 15.205 (a) must also comply with the radiated emission limits specified in FCC 15.209 (a).</p> | Pass |

Radiated Emissions (General requirements)

| Basic Standard | Technical Requirements / Details | Result |
|--------------------------|--|--------|
| FCC 15.209 FCC 15.205 | <p>TX Spurious Emissions: Except as provided elsewhere in this subpart, the emissions from an intentional radiator shall not exceed the field strength levels specified in the filed strength limits table in this section.</p> | Pass |
| FCC 15.207 | <p>AC conducted Emissions: Except when the requirements applicable to a given device state otherwise, for any radio apparatus equipped to operate from the public utility AC power supply, either directly or indirectly (such as with a battery charger), the radio frequency voltage of emissions conducted back onto the AC power lines in the frequency range of 0.15 MHz to 30 MHz shall not exceed the limits shown in the table in these sections. The more stringent limit applies at the frequency range boundaries.</p> | Pass |

* MPE calculation is recorded in a separate report

Section 4: Sample Details

Note: Each sample was evaluated to ensure that its condition was suitable to be used as a test sample prior to the commencement of testing.

4.1 Sample Details

| Sample No. | Equipment Details | Manufacturer | Hardware Rev. | Firmware Rev. | Software Rev. | Serial Number |
|------------|--------------------------|---------------|---------------|---------------|----------------------|---------------|
| S01 | AIR-AP1815I-A-K9 | Cisco Systems | P2 | 8.3.15.124 | AP1G5 | FOC20041PJB |
| S02* | Catalyst 3750E-24PD-E | Cisco Systems | A0 | 12.2(50)SE2 | C3750E-UNIVERSALK9-M | FDO15422DE4 |

(*) is support equipment Power supply for EUT

4.2 System Details

| System # | Description | Samples |
|----------|------------------|---------|
| 1 | AIR-AP1815I-A-K9 | S01 |
| 2 | POE | S02 |

4.3 Mode of Operation Details

| Mode# | Description | Comments |
|-------|-------------------------|--|
| 1 | Continuous Transmitting | Continuous Transmitting $\geq 98\%$ duty cycle |

All measurements were made in accordance with

- ANSI C63.10:2013
- KDB 789033 D02 General UNII Test Procedures New Rules v01r03
- KDB 662911 D01 Multiple Transmitter Output v02r01

Appendix A: Emission Test Results

Conducted Test Setup Diagram

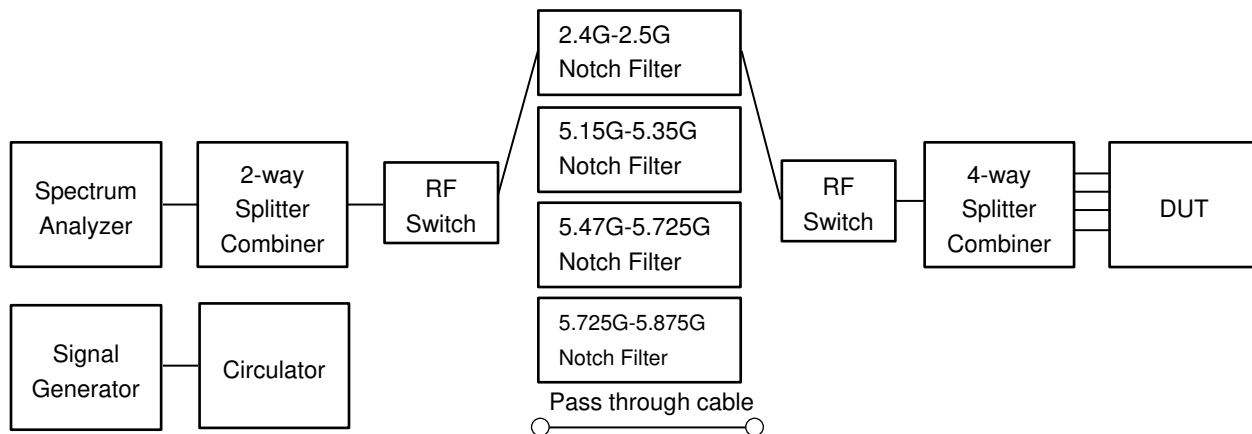

Target Maximum Channel Power

The following table details the maximum supported Total Channel Power for all operating modes.

| Operating Mode | Maximum Channel Power (dBm) | | |
|--|-----------------------------|------|------|
| | Frequency (MHz) | | |
| | 5500 | 5560 | 5660 |
| Non HT20, 6 to 54 Mbps | 19 | 19 | 19 |
| Non HT20 Beam Forming, 6 to 54 Mbps | 19 | 19 | 19 |
| HT/VHT20, M0 to M15 | 19 | 19 | 19 |
| HT/VHT20 Beam Forming, M0 to M15 | 19 | 19 | 19 |
| HT/VHT20 STBC, M0 to M7 | 19 | 19 | 19 |
| | 5510 | 5550 | 5670 |
| Non HT40, 6 to 54 Mbps | 16 | 19 | 19 |
| HT/VHT40, M0 to M15 | 17 | 19 | 20 |
| HT/VHT40 Beam Forming, M0 to M15 | 17 | 19 | 20 |
| HT/VHT40 STBC, M0 to M7 | 17 | 19 | 20 |
| | 5530 | 5690 | |
| Non HT80, 6 to 54 Mbps | 16 | 19 | |
| VHT80, M0 to M9, M0 to M9 1-1ss | 16 | 19 | |
| VHT80 Beam Forming, M0 to M9, M0 to M9 1-1ss | 16 | 19 | |
| VHT80 STBC, M0 to M9 1ss | 16 | 19 | |

A.1 99% and 26dB Bandwidth

FCC 15.407 The 99% occupied bandwidth is the frequency bandwidth such that, below its lower and above its upper frequency limits, the mean powers are each equal to 0.5% of the total mean power of the given emission. There is no limit for 99% OBW.

The 26 dB emission is the width of the emission that is constrained by the frequencies associated with the two outermost amplitude points (upper and lower frequencies) that are attenuated by 26 dB relative to the maximum level measured in the fundamental emission.

KDB 644545 D03 v01 section D1b

Band-crossing emissions: For an emission that crosses the boundary between two adjacent U-NII bands, the boundary frequency between the bands serves as one edge for defining the portion of the EBW that falls within a particular U-NII band. However, the -26 dB points are measured relative to the highest point on the contiguous segment—regardless of which band contains that highest point (Figure4).

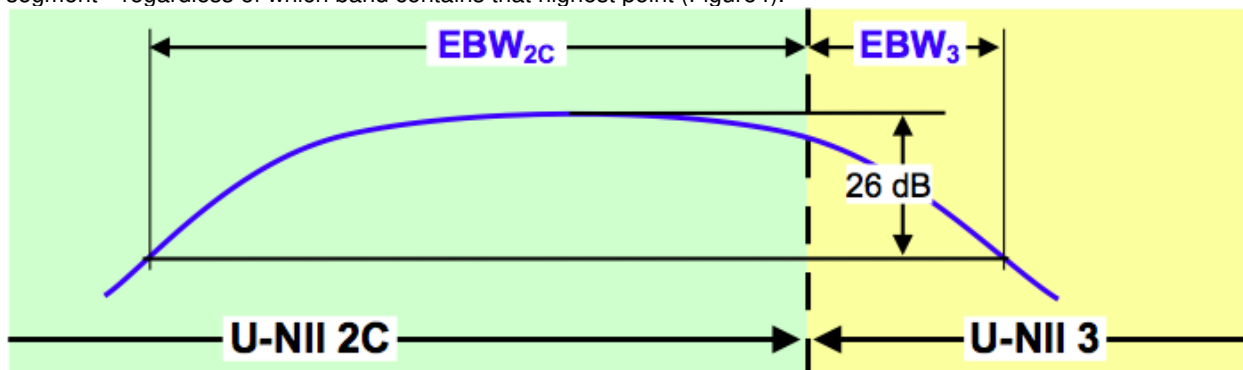

Figure 4. Emission Bandwidth (EBW) within a Band for Band-Crossing Signals

Test Procedure

Ref. ANSI C63.10: 2013 Section 6.9.3

KDB 644545 D03 v01

KDB 789033 D02 General UNII Test Procedures New Rules v01r03

KDB 662911

99% BW and EBW (-26dB)

Test Procedure

1. Set the radio in the continuous transmitting mode.
2. Allow the trace to stabilize.
3. Setting the x-dB bandwidth mode to -26dB and OBW power function to 99% within the measurement set up function.
4. Select the automatic OBW measurement function of an instrument to perform bandwidth measurement.
5. Capture graphs and record pertinent measurement data.

Ref. ANSI C63.10: 2013 Section 6.9.3

99% BW and EBW (-26dB)

Test parameters

X dB BW = -26dB (using the OBW function of the spectrum analyzer)

OBW = 99% (using the OBW function of the spectrum analyzer)

Span = 1.5 x to 5.0 times OBW

RBW = approx. 1% to 5% of the OBW

VBW \geq 3 x RBW

Detector = Peak or where practical sample shall be used

Trace = Max. Hold

| System Number | Description | Samples | System under test | Support equipment |
|---------------|-------------|---------|-------------------------------------|-------------------------------------|
| 1 | EUT | S01 | <input checked="" type="checkbox"/> | <input type="checkbox"/> |
| | Support | S02 | <input type="checkbox"/> | <input checked="" type="checkbox"/> |

| | |
|------------------------------------|--|
| Tested By : Jose Aguirre | Date of testing: 01-Jun-16 - 26-Jun-16 |
| Test Result : PASS | |

See Appendix C for list of test equipment

| Frequency (MHz) | Mode | Data Rate (Mbps) | 26dB BW (MHz) | 99% BW (MHz) |
|-----------------|---------------------------------|------------------|---------------|--------------|
| 5500 | Non HT20, 6 to 54 Mbps | 6 | 24.1 | 17.605 |
| | HT/VHT20, M0 to M15 | m0 | 25.43 | 18.485 |
| 5510 | Non HT40, 6 to 54 Mbps | 6 | 39.9 | 35.588 |
| | HT/VHT40, M0 to M15 | m0 | 41.1 | 36.417 |
| 5530 | Non HT80, 6 to 54 Mbps | 6 | 79.4 | 74.559 |
| | VHT80, M0 to M9, M0 to M9 1-1ss | m0x1 | 80.6 | 75.963 |
| 5550 | Non HT40, 6 to 54 Mbps | 6 | 39.6 | 35.574 |
| | HT/VHT40, M0 to M15 | m0 | 42.5 | 36.435 |
| 5560 | Non HT20, 6 to 54 Mbps | 6 | 21.1 | 17.317 |
| | HT/VHT20, M0 to M15 | m0 | 21.8 | 18.292 |
| 5660 | Non HT20, 6 to 54 Mbps | 6 | 22.6 | 17.475 |
| | HT/VHT20, M0 to M15 | m0 | 23.4 | 18.408 |
| 5670 | Non HT40, 6 to 54 Mbps | 6 | 40.1 | 35.784 |
| | HT/VHT40, M0 to M15 | m0 | 43.3 | 36.621 |
| 5690 | Non HT80, 6 to 54 Mbps | 6 | 79.5 | 74.634 |
| | VHT80, M0 to M9, M0 to M9 1-1ss | m0x1 | 91.2 | 76.111 |
| 5700 | Non HT20, 6 to 54 Mbps | 6 | 20.6 | 17.287 |
| | HT/VHT20, M0 to M15 | m0 | 21.7 | 18.257 |
| 5710 | Non HT40, 6 to 54 Mbps | 6 | 39.7 | 35.571 |
| | HT/VHT40, M0 to M15 | m0 | 41.1 | 36.424 |
| 5720 | Non HT20, 6 to 54 Mbps | 6 | 20.7 | 17.264 |
| | HT/VHT20, M0 to M15 | m0 | 21.7 | 18.255 |

26dB / 99% Bandwidth, 5500 MHz, Non HT20, 6 to 54 Mbps

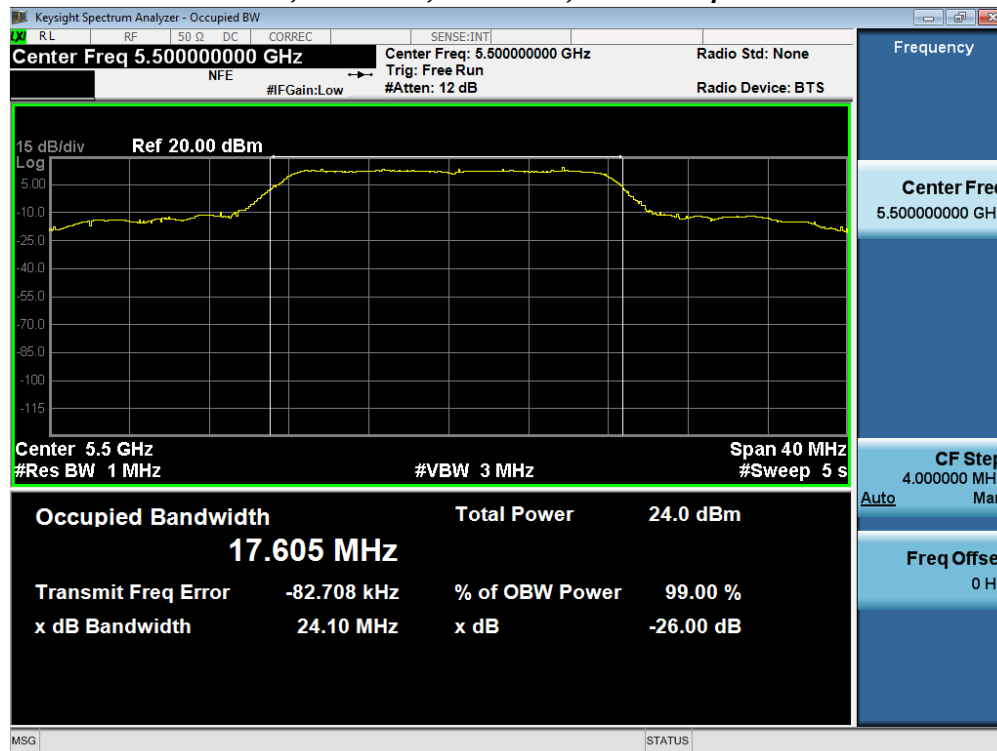

26dB / 99% Bandwidth, 5500 MHz, HT/VHT20, M0 to M15

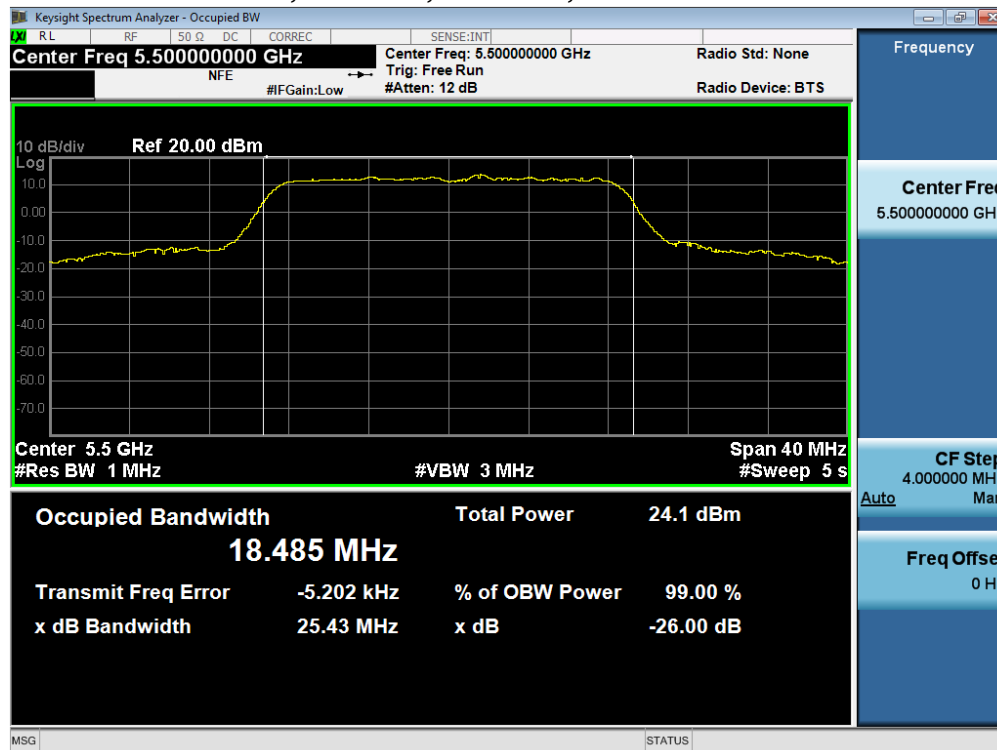

26dB / 99% Bandwidth, 5510 MHz, Non HT40, 6 to 54 Mbps

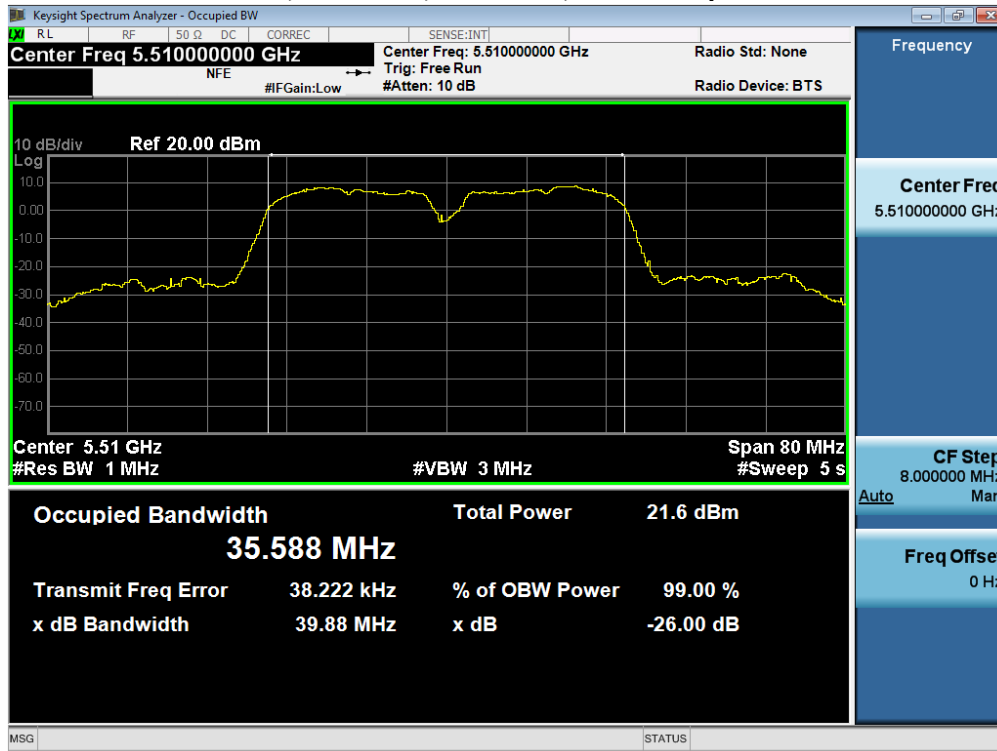

26dB / 99% Bandwidth, 5510 MHz, HT/VHT40, M0 to M15

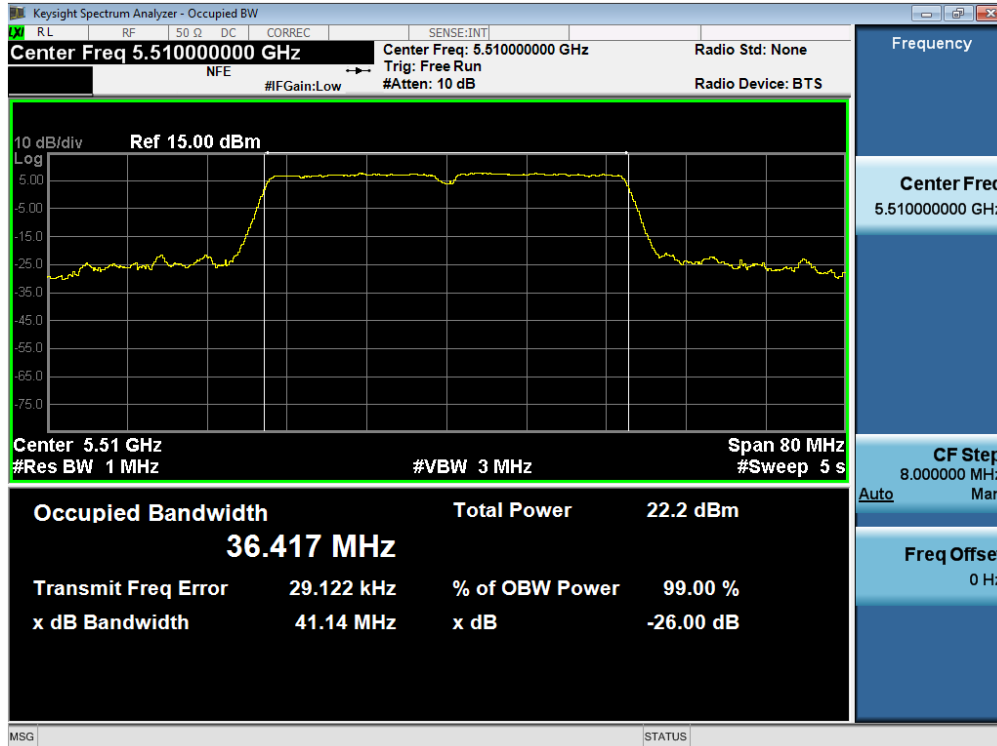

26dB / 99% Bandwidth, 5530 MHz, Non HT80, 6 to 54 Mbps

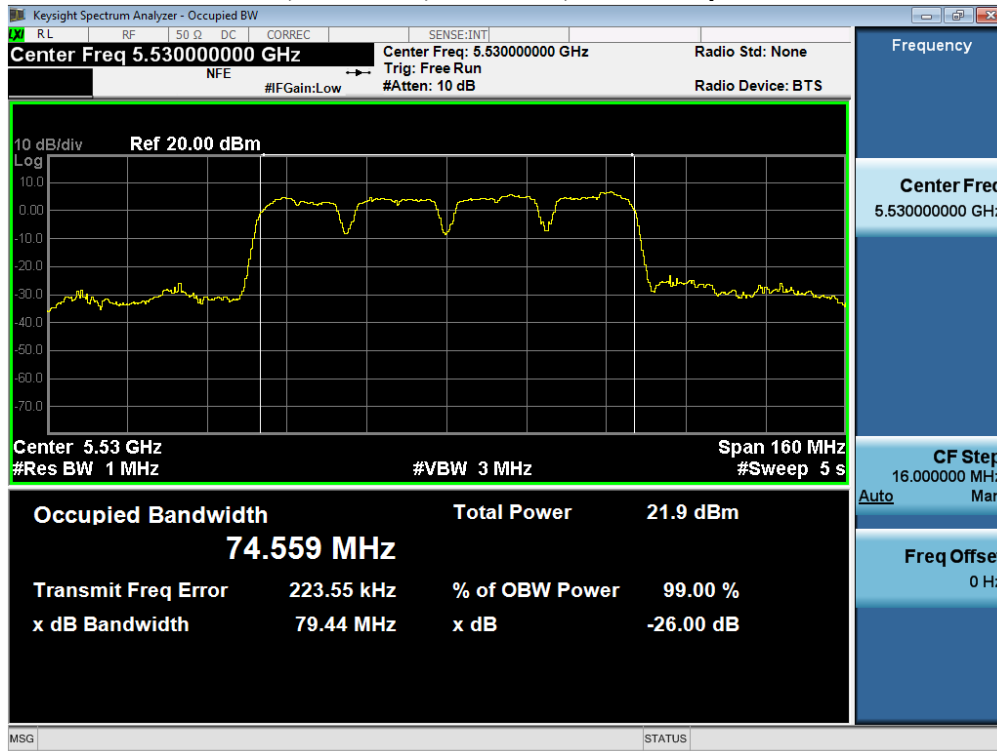

26dB / 99% Bandwidth, 5530 MHz, VHT80, M0 to M9, M0 to M9 1-1ss

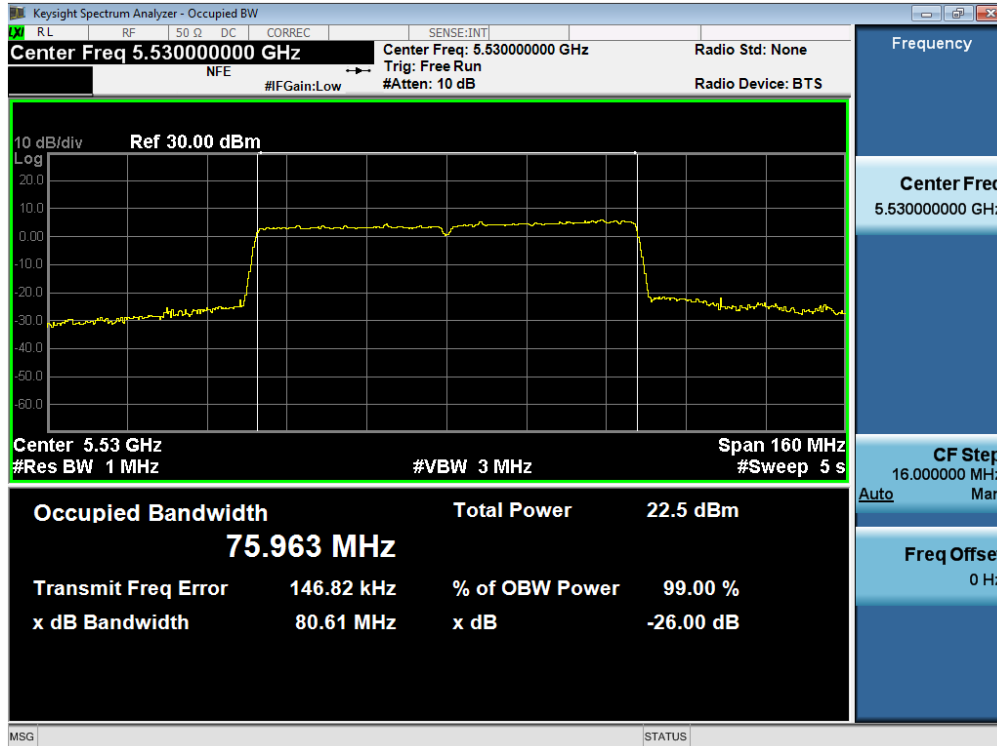

26dB / 99% Bandwidth, 5550 MHz, Non HT40, 6 to 54 Mbps

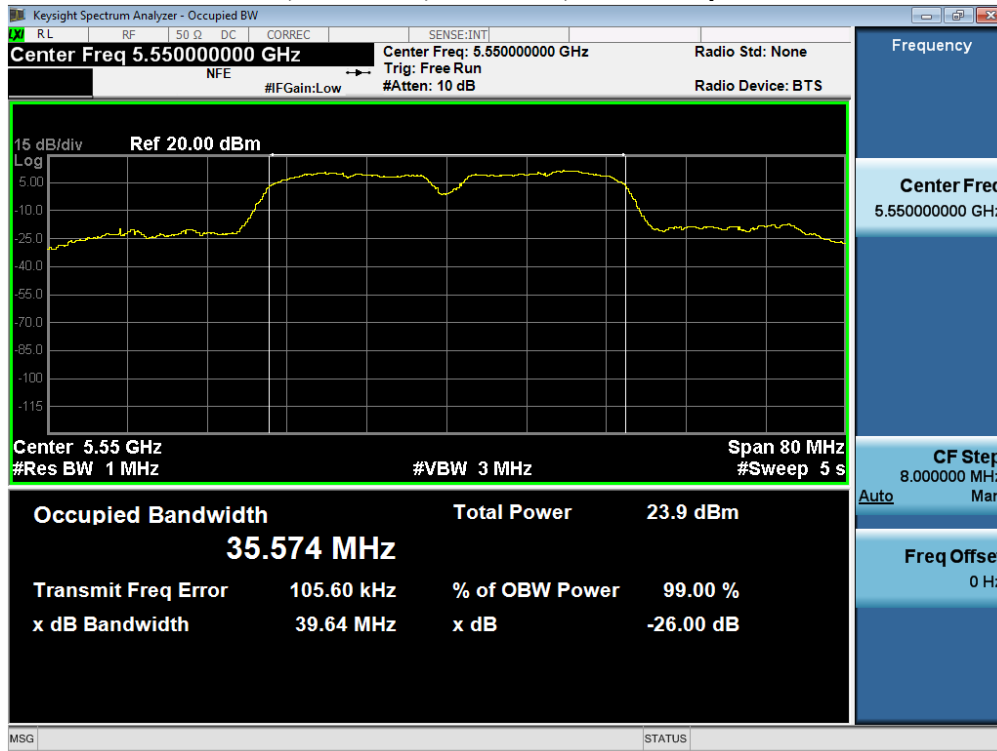

26dB / 99% Bandwidth, 5550 MHz, HT/VHT40, M0 to M15

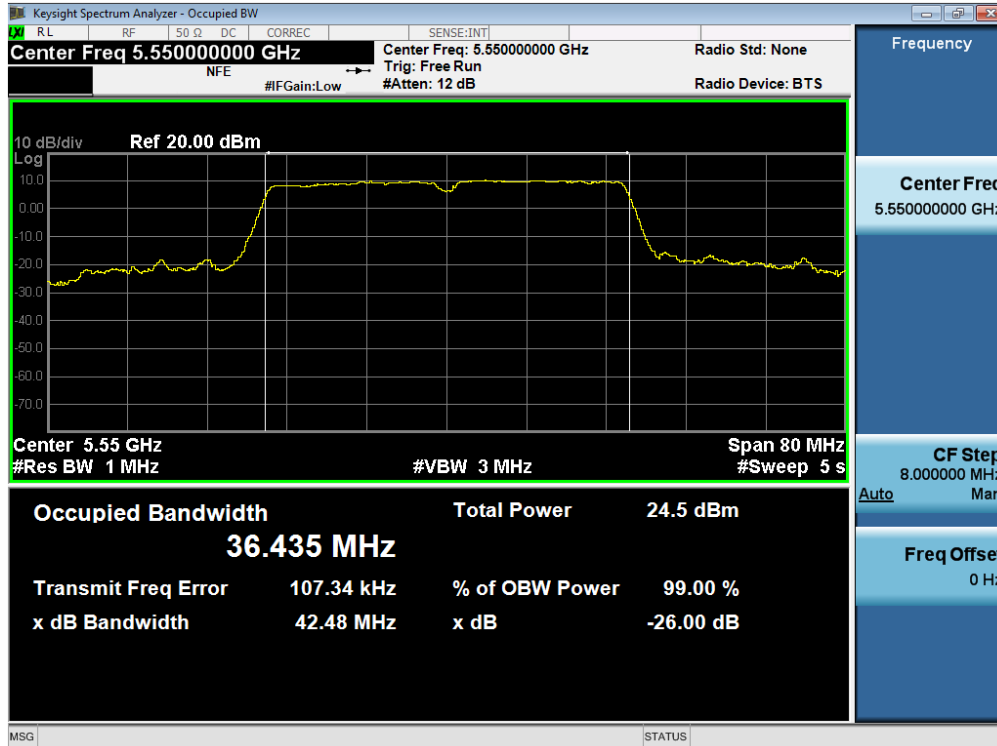

26dB / 99% Bandwidth, 5560 MHz, Non HT20, 6 to 54 Mbps

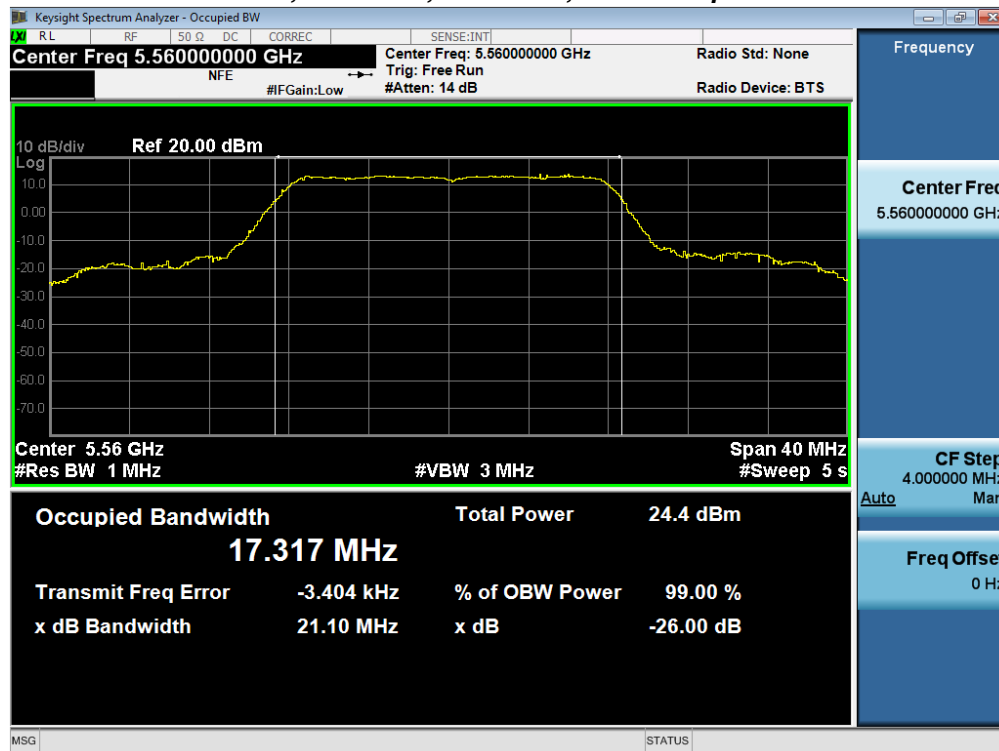

26dB / 99% Bandwidth, 5560 MHz, HT/VHT20, M0 to M15

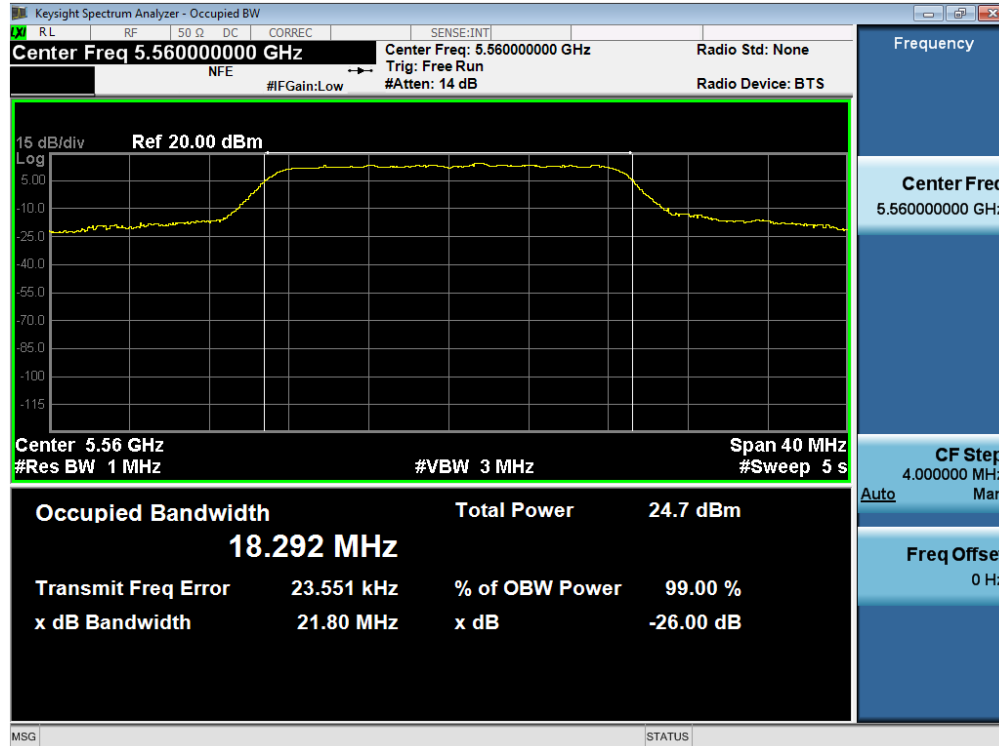

26dB / 99% Bandwidth, 5660 MHz, Non HT20, 6 to 54 Mbps

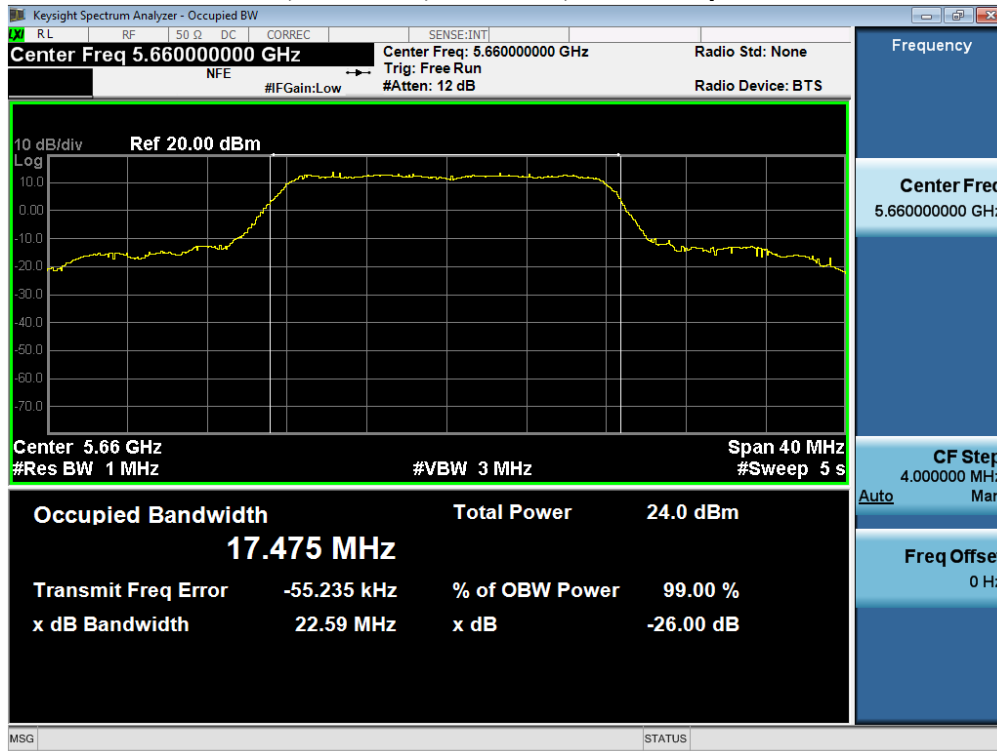

26dB / 99% Bandwidth, 5660 MHz, HT/VHT20, M0 to M15

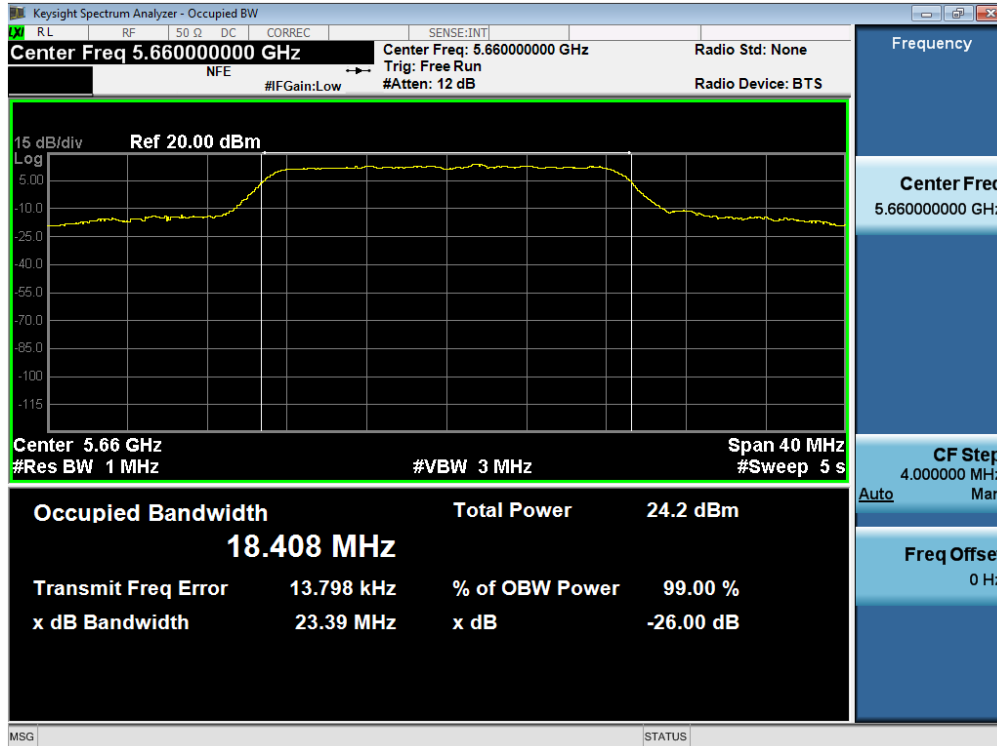

26dB / 99% Bandwidth, 5670 MHz, Non HT40, 6 to 54 Mbps

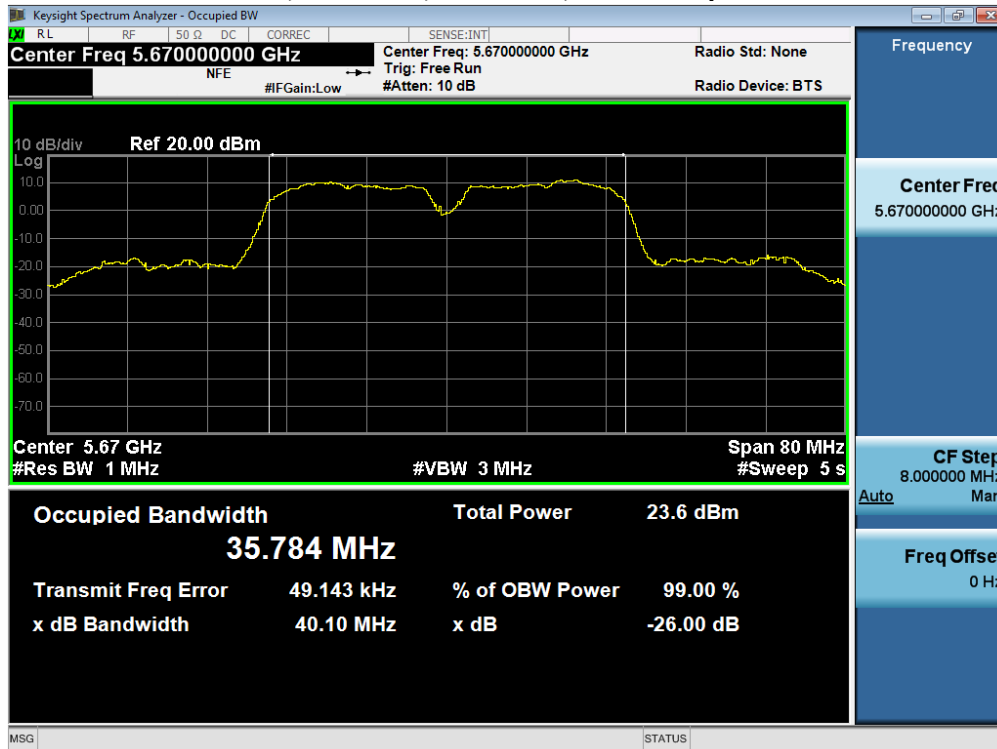

26dB / 99% Bandwidth, 5670 MHz, HT/VHT40, M0 to M15

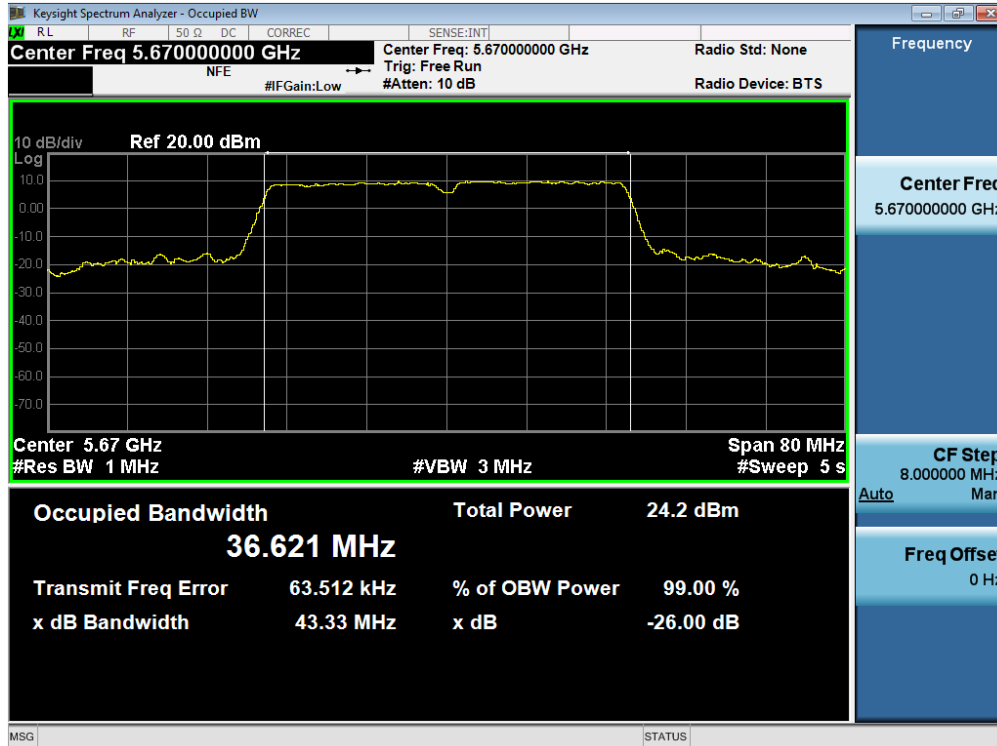

26dB / 99% Bandwidth, 5690 MHz, Non HT80, 6 to 54 Mbps

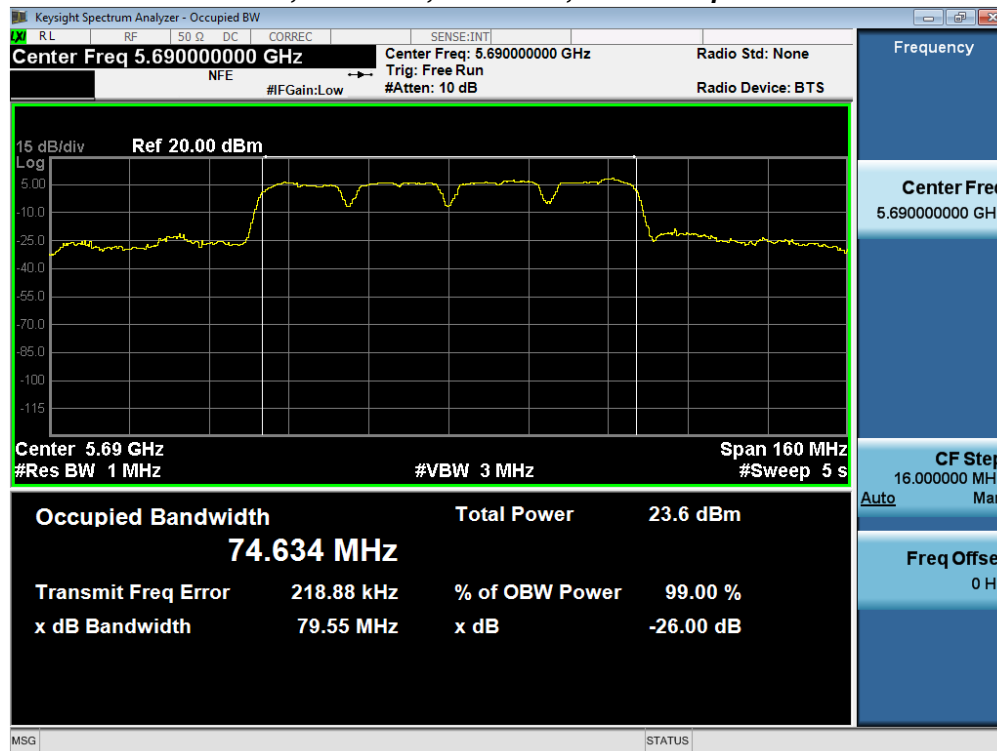

26dB / 99% Bandwidth, 5690 MHz, VHT80, M0 to M9, M0 to M9 1-1ss

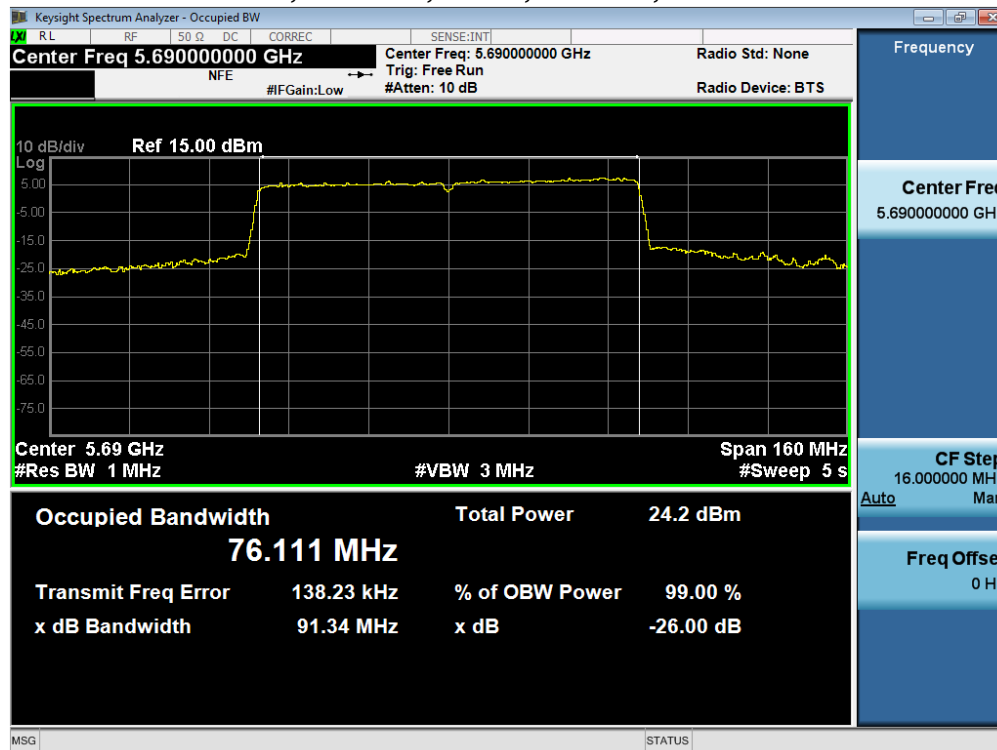

26dB / 99% Bandwidth, 5700 MHz, Non HT20, 6 to 54 Mbps

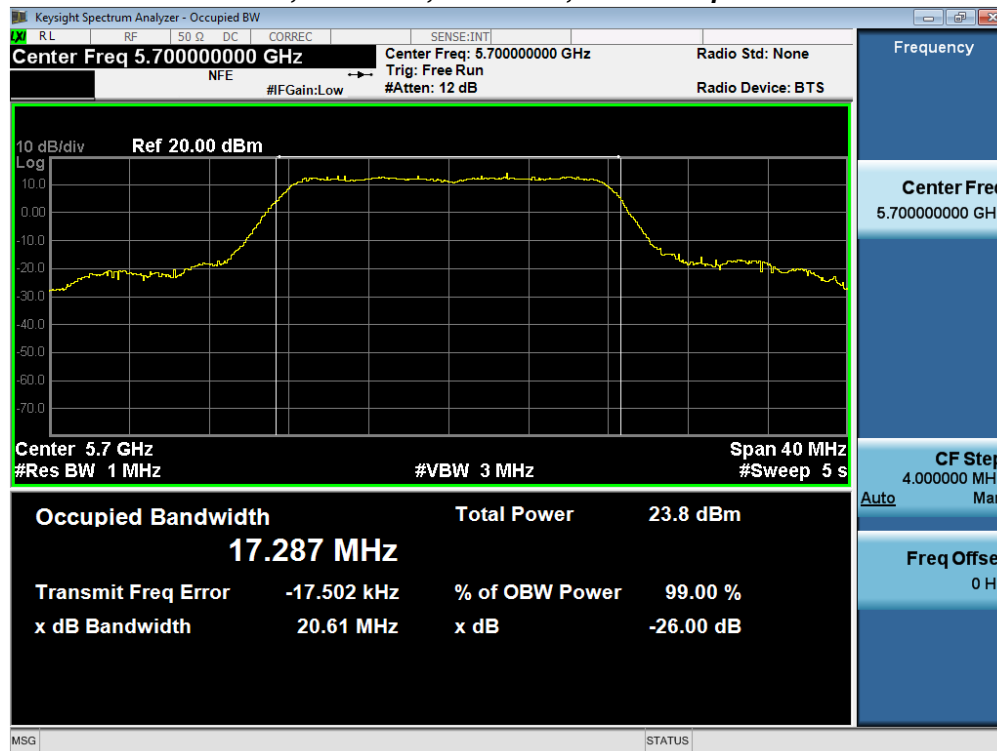

26dB / 99% Bandwidth, 5700 MHz, HT/VHT20, M0 to M15

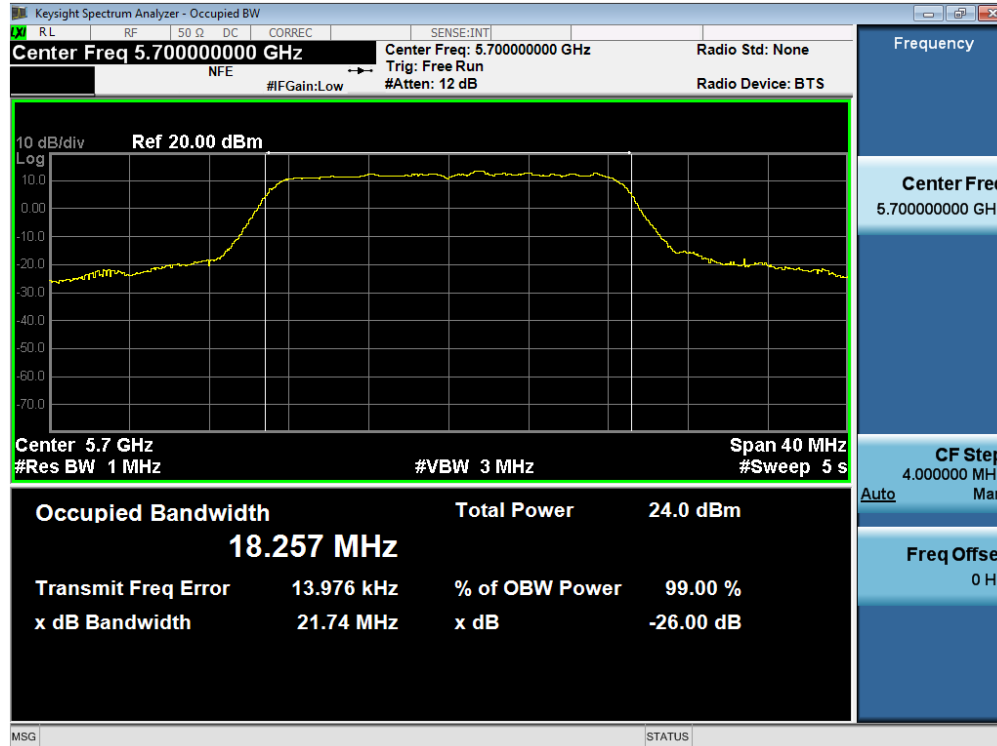

26dB / 99% Bandwidth, 5710 MHz, Non HT40, 6 to 54 Mbps

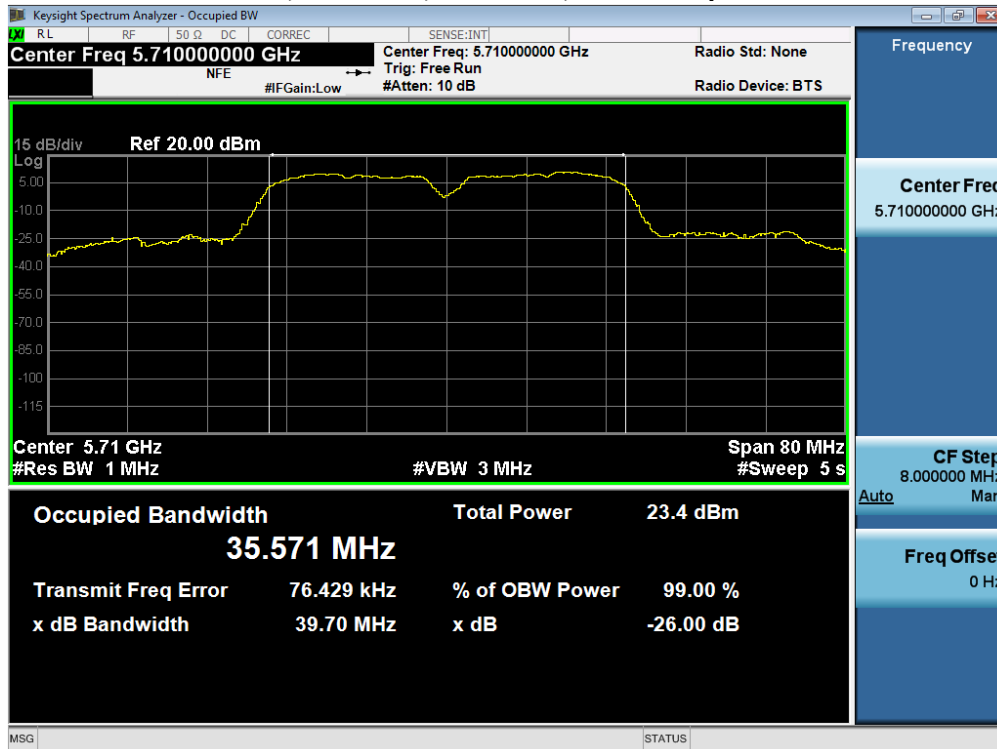

26dB / 99% Bandwidth, 5710 MHz, HT/VHT40, M0 to M15

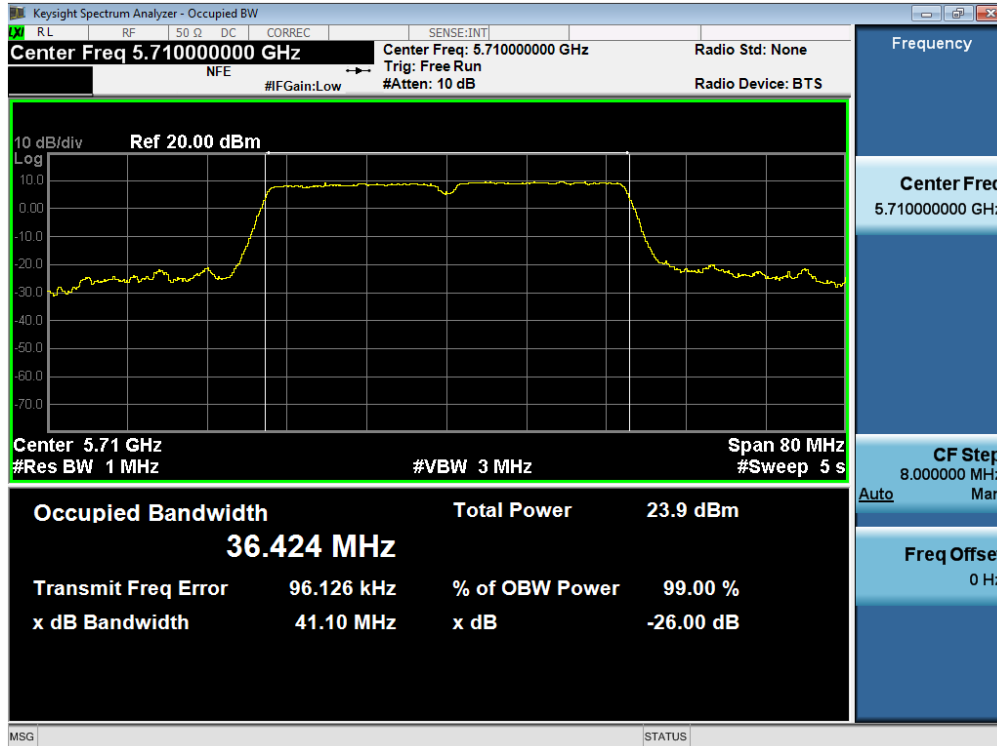

26dB / 99% Bandwidth, 5720 MHz, Non HT20, 6 to 54 Mbps

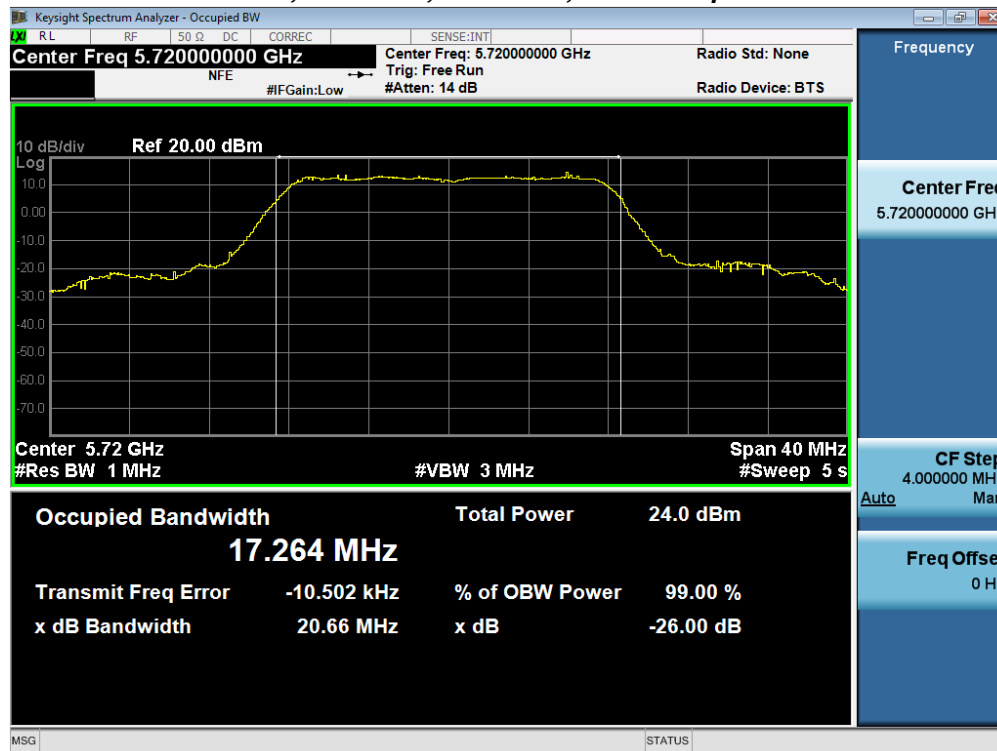

26dB / 99% Bandwidth, 5720 MHz, HT/VHT20, M0 to M15

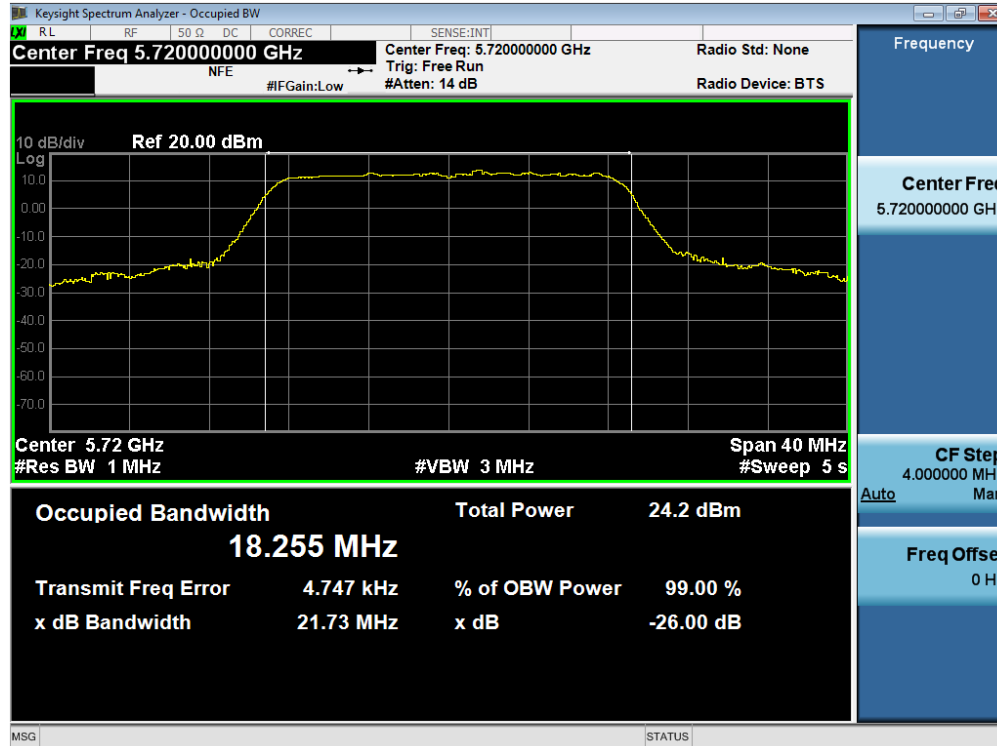

A.2 Maximum Conducted Output Power/ Power Spectral Density

15.407 (2) For the 5.25-5.35 GHz and 5.47-5.725 GHz bands, the maximum conducted output power over the frequency bands of operation shall not exceed the lesser of 250 mW or $11 \text{ dBm} + 10 \log B$, where B is the 26 dB emission bandwidth in megahertz. In addition, the maximum power spectral density shall not exceed 11 dBm in any 1 megahertz band. If transmitting antennas of directional gain greater than 6 dBi are used, both the maximum conducted output power and the maximum power spectral density shall be reduced by the amount in dB that the directional gain of the antenna exceeds 6 dBi.

15.407 a (3) For the band 5.725-5.85 GHz, the maximum conducted output power over the frequency band of operation shall not exceed 1 W. If transmitting antennas of directional gain greater than 6 dBi are used, both the maximum conducted output power and the maximum power spectral density shall be reduced by the amount in dB that the directional gain of the antenna exceeds 6 dBi. However, fixed point-to-point U-NII devices operating in this band may employ transmitting antennas with directional gain greater than 6 dBi without any corresponding reduction in transmitter conducted power. Fixed, point-to-point operations exclude the use of point-to-multipoint systems, omnidirectional applications, and multiple collocated transmitters transmitting the same information. The operator of the U-NII device, or if the equipment is professionally installed, the installer, is responsible for ensuring that systems employing high gain directional antennas are used exclusively for fixed, point-to-point operations.

The power spectral density shall not exceed 30 dBm in any 500 kHz band. If transmitting antennas of directional gain greater than 6 dBi are used, both the maximum conducted output power and the power spectral density shall be reduced by the amount in dB that the directional gain of the antenna exceeds 6 dBi.

KDB 644545 D03 (section F.2.b.ii)

When measuring the portion of the maximum conducted output power within a single U-NII band, the power shall be integrated across only the portion of the EBW that falls within that band. That is, if an EBW extends across the boundary between two adjacent bands, the boundary frequency between the bands serves as one edge of the frequency range to be integrated. Integration across an entire U-NII band without regard to 26 dB points is also acceptable for determining conducted output power within that band.

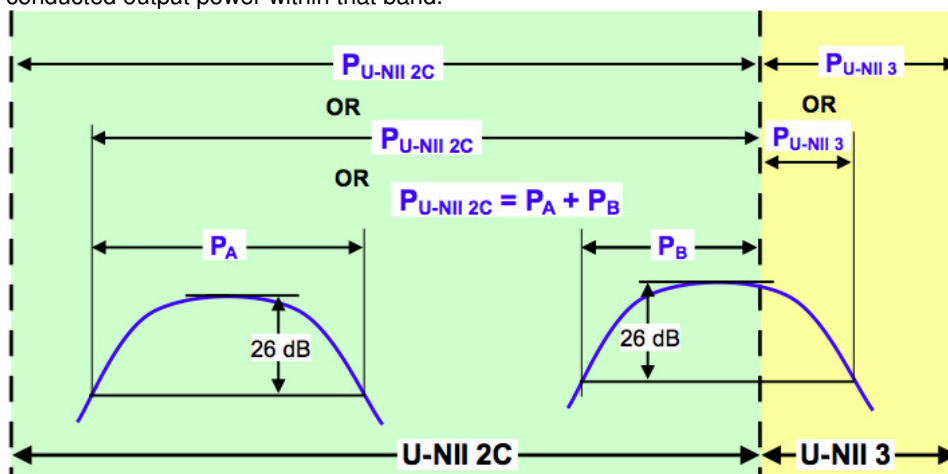

Conducted output power within a U-NII band: Integrate over the band, or integrate over a span including the 26 dB EBWs of transmission segments within the band, or integrate over 26 dB EBW of each transmission segment in the band and sum.

Figure 5. Conducted Output Power Measurement Examples

The “measure-and-sum technique” is used for measuring in-band transmit power of a device. In the measure-and-sum approach, the conducted emission level is measured at each antenna port. The measured results at the various antenna ports are then summed mathematically to determine the total emission level from the device. Summing is performed in linear power units. (ANSI C63.10: 2013, section 14.3.2.2)

Test Procedure

Ref. KDB 789033 D02 General UNII Test Procedures New Rules v01r03
ANSI C63.10: 2013
KDB 644545 D03 v01

| |
|---|
| Output Power Test Procedure |
| <ol style="list-style-type: none"> 1. Set the radio in the continuous transmitting mode at full power 2. Compute power by integrating the spectrum across the EBW (or alternatively entire 99% OBW) of the signal using the instrument's band power measurement function. The integration shall be performed using the spectrum analyzer band-power measurement function with band limits set equal to the EBW or the OBW band edges. 3. Capture graphs and record pertinent measurement data. |

Ref. KDB 789033 D02 General UNII Test Procedures New Rules v01r03
ANSI C63.10: 2013 section 12.3.2.2 Method SA-1

| |
|---|
| Output Power Test parameters |
| Span = >1.5 times the OBW RBW = 1MHz VBW ≥ 3 x RBW Sweep = Auto couple Detector = sample Trace = Trace Average 100 |

The "measure-and-sum technique" is used for measuring in-band transmit power of a device. In the measure-and-sum approach, the conducted emission level is measured at each antenna port. The measured results at the various antenna ports are then summed mathematically to determine the total emission level from the device. Summing is performed in linear power units. (See ANSI C63.10 section 14.3.2.2)

| Power Spectral Density (UNII 2C band) | Power Spectral Density (UNII 3 band) |
|---|--|
| Test parameters ANSI C63.10: 2013 , sec12.3.2.2 Method SA-1 | Test parameters KDB 789033 D02 v01 section F.5 |
| Span = >1.5 times the OBW RBW = 1MHz VBW ≥ 3 x RBW Sweep = Auto couple Detector = Sample Trace = Trace Average 100 Marker = Peak Search | Span = >1.5 times the OBW RBW = 500 kHz. VBW ≥ 3 x RBW Sweep = 10s Detector = Peak Trace = Single Sweep Marker = Peak Search |

The "Measure and add 10 log(N) dB technique", where N is the number of outputs, is used for measuring in-band Power Spectral Density. With this technique, spectrum measurements are performed at each output of the device, and the quantity 10 log(4) (or 6dB) is added to the worst case spectrum value before comparing to the emission limit. (ANSI C63.10 2013 section 14.3.2.3)

| System Number | Description | Samples | System under test | Support equipment |
|----------------------|--------------------|----------------|-------------------------------------|-------------------------------------|
| 1 | EUT | S01 | <input checked="" type="checkbox"/> | <input type="checkbox"/> |
| | Support | S02 | <input type="checkbox"/> | <input checked="" type="checkbox"/> |

| | |
|------------------------------------|--|
| Tested By : Jose Aguirre | Date of testing: 01-Jun-16 - 26-Jun-16 |
| Test Result : PASS | |

See Appendix C for list of test equipment

Rather Than Measure:

- The portion of the signal in the UNII-2C Band , 250 mW or 11 dBm+ 10 log B power / 11dBm/MHz PSD
- The portion of the signal in the UNII-3 Band , 36dBm EIRP power / 30dBm/500kHz PSD

If the band crossing waveforms are typical , then doing the calculations across the full signal bandwidth and comparing it to the lower (UNII-2C) limit should meet our requirements. The only time the band crossing waveforms need to do individual calculations is when they can not meet the more restrictive limit.

| Frequency (MHz) | Mode | Tx Paths | Correlated Antenna Gain (dBi) | Tx 1 Max Power (dBm) | Tx 2 Max Power (dBm) | Total Tx Channel Power (dBm) | Limit (dBm) | Margin (dB) |
|-----------------|-------------------------------------|----------|-------------------------------|----------------------|----------------------|------------------------------|-------------|-------------|
| 5500 | Non HT20, 6 to 54 Mbps | 1 | 4 | 15.7 | | 15.7 | 23.5 | 7.8 |
| | Non HT20, 6 to 54 Mbps | 2 | 4 | 15.7 | 17.1 | 19.5 | 23.5 | 4.0 |
| | Non HT20 Beam Forming, 6 to 54 Mbps | 2 | 7 | 14.8 | 16.2 | 18.6 | 22.4 | 3.8 |
| | HT/VHT20, M0 to M7 | 1 | 4 | 15.6 | | 15.6 | 23.7 | 8.1 |
| | HT/VHT20, M0 to M7 | 2 | 4 | 15.6 | 17.0 | 19.4 | 23.7 | 4.3 |
| | HT/VHT20, M8 to M15 | 2 | 4 | 15.6 | 17.0 | 19.4 | 23.7 | 4.3 |
| | HT/VHT20 Beam Forming, M0 to M7 | 2 | 7 | 14.7 | 16.1 | 18.5 | 22.6 | 4.1 |
| | HT/VHT20 Beam Forming, M8 to M15 | 2 | 4 | 15.6 | 17.0 | 19.4 | 23.7 | 4.3 |
| | HT/VHT20 STBC, M0 to M7 | 2 | 4 | 15.6 | 17.0 | 19.4 | 23.7 | 4.3 |
| 5510 | Non HT40, 6 to 54 Mbps | 1 | 4 | 13.4 | | 13.4 | 24.0 | 10.6 |
| | Non HT40, 6 to 54 Mbps | 2 | 4 | 12.4 | 13.8 | 16.2 | 24.0 | 7.8 |
| | HT/VHT40, M0 to M7 | 1 | 4 | 13.8 | | 13.8 | 24.0 | 10.2 |
| | HT/VHT40, M0 to M7 | 2 | 4 | 12.8 | 14.2 | 16.6 | 24.0 | 7.4 |
| | HT/VHT40, M8 to M15 | 2 | 4 | 12.8 | 14.2 | 16.6 | 24.0 | 7.4 |
| | HT/VHT40 Beam Forming, M0 to M7 | 2 | 7 | 11.8 | 13.2 | 15.6 | 23.0 | 7.4 |
| | HT/VHT40 Beam Forming, M8 to M15 | 2 | 4 | 12.8 | 14.2 | 16.6 | 24.0 | 7.4 |
| | HT/VHT40 STBC, M0 to M7 | 2 | 4 | 12.8 | 14.2 | 16.6 | 24.0 | 7.4 |
| 5530 | Non HT80, 6 to 54 Mbps | 1 | 4 | 13.6 | | 13.6 | 24.0 | 10.4 |
| | Non HT80, 6 to 54 Mbps | 2 | 4 | 12.6 | 13.3 | 16.0 | 24.0 | 8.0 |
| | VHT80, M0 to M9 1ss | 1 | 4 | 13.4 | | 13.4 | 24.0 | 10.6 |
| | VHT80, M0 to M9 1ss | 2 | 4 | 12.5 | 13.2 | 15.9 | 24.0 | 8.1 |
| | VHT80, M0 to M9 2ss | 2 | 4 | 12.5 | 13.2 | 15.9 | 24.0 | 8.1 |
| | VHT80 Beam Forming, M0 to M9 1ss | 2 | 7 | 11.5 | 12.2 | 14.9 | 23.0 | 8.1 |
| | VHT80 Beam Forming, M0 to M9 2ss | 2 | 4 | 12.5 | 13.2 | 15.9 | 24.0 | 8.1 |
| | VHT80 STBC, M0 to M9 1ss | 2 | 4 | 12.5 | 13.2 | 15.9 | 24.0 | 8.1 |
| 5550 | Non HT40, 6 to 54 Mbps | 1 | 4 | 15.7 | | 15.7 | 24.0 | 8.3 |
| | Non HT40, 6 to 54 Mbps | 2 | 4 | 15.7 | 15.8 | 18.8 | 24.0 | 5.2 |
| | HT/VHT40, M0 to M7 | 1 | 4 | 16.1 | | 16.1 | 24.0 | 7.9 |
| | HT/VHT40, M0 to M7 | 2 | 4 | 16.1 | 16.2 | 19.2 | 24.0 | 4.8 |
| | HT/VHT40, M8 to M15 | 2 | 4 | 16.1 | 16.2 | 19.2 | 24.0 | 4.8 |
| | HT/VHT40 Beam Forming, M0 to M7 | 2 | 7 | 16.1 | 16.2 | 19.2 | 23.0 | 3.8 |
| | HT/VHT40 Beam Forming, M8 to M15 | 2 | 4 | 16.1 | 16.2 | 19.2 | 24.0 | 4.8 |
| | HT/VHT40 STBC, M0 to M7 | 2 | 4 | 16.1 | 16.2 | 19.2 | 24.0 | 4.8 |

| | | | | | | | | |
|------|--|----------|----------|-------------|-------------|-------------|-------------|------------|
| 5560 | Non HT20, 6 to 54 Mbps | 1 | 4 | 16.3 | | 16.3 | 23.4 | 7.1 |
| | Non HT20, 6 to 54 Mbps | 2 | 4 | 16.3 | 15.9 | 19.1 | 23.4 | 4.3 |
| | Non HT20 Beam Forming, 6 to 54 Mbps | 2 | 7 | 16.3 | 15.9 | 19.1 | 22.4 | 3.3 |
| | HT/VHT20, M0 to M7 | 1 | 4 | 16.3 | | 16.3 | 23.6 | 7.3 |
| | HT/VHT20, M0 to M7 | 2 | 4 | 16.3 | 15.9 | 19.1 | 23.6 | 4.5 |
| | HT/VHT20, M8 to M15 | 2 | 4 | 16.3 | 15.9 | 19.1 | 23.6 | 4.5 |
| | HT/VHT20 Beam Forming, M0 to M7 | 2 | 7 | 16.3 | 15.9 | 19.1 | 22.6 | 3.5 |
| | HT/VHT20 Beam Forming, M8 to M15 | 2 | 4 | 16.3 | 15.9 | 19.1 | 23.6 | 4.5 |
| | HT/VHT20 STBC, M0 to M7 | 2 | 4 | 16.3 | 15.9 | 19.1 | 23.6 | 4.5 |
| 5660 | Non HT20, 6 to 54 Mbps | 1 | 4 | 15.7 | | 15.7 | 23.4 | 7.7 |
| | Non HT20, 6 to 54 Mbps | 2 | 4 | 15.7 | 16.9 | 19.4 | 23.4 | 4.0 |
| | Non HT20 Beam Forming, 6 to 54 Mbps | 2 | 7 | 15.7 | 16.9 | 19.4 | 22.4 | 3.0 |
| | HT/VHT20, M0 to M7 | 1 | 4 | 15.7 | | 15.7 | 23.7 | 8.0 |
| | HT/VHT20, M0 to M7 | 2 | 4 | 15.7 | 16.9 | 19.4 | 23.6 | 4.2 |
| | HT/VHT20, M8 to M15 | 2 | 4 | 15.7 | 16.9 | 19.4 | 23.6 | 4.2 |
| | HT/VHT20 Beam Forming, M0 to M7 | 2 | 7 | 15.7 | 16.9 | 19.4 | 22.6 | 3.2 |
| | HT/VHT20 Beam Forming, M8 to M15 | 2 | 4 | 15.7 | 16.9 | 19.4 | 23.6 | 4.2 |
| | HT/VHT20 STBC, M0 to M7 | 2 | 4 | 15.7 | 16.9 | 19.4 | 23.6 | 4.2 |
| 5670 | Non HT40, 6 to 54 Mbps | 1 | 4 | 15.4 | | 15.4 | 24.0 | 8.6 |
| | Non HT40, 6 to 54 Mbps | 2 | 4 | 15.4 | 16.8 | 19.2 | 24.0 | 4.8 |
| | HT/VHT40, M0 to M7 | 1 | 4 | 15.8 | | 15.8 | 24.0 | 8.2 |
| | HT/VHT40, M0 to M7 | 2 | 4 | 15.8 | 17.2 | 19.6 | 24.0 | 4.4 |
| | HT/VHT40, M8 to M15 | 2 | 4 | 15.8 | 17.2 | 19.6 | 24.0 | 4.4 |
| | HT/VHT40 Beam Forming, M0 to M7 | 2 | 7 | 15.8 | 17.2 | 19.6 | 23.0 | 3.4 |
| | HT/VHT40 Beam Forming, M8 to M15 | 2 | 4 | 15.8 | 17.2 | 19.6 | 24.0 | 4.4 |
| | HT/VHT40 STBC, M0 to M7 | 2 | 4 | 15.8 | 17.2 | 19.6 | 24.0 | 4.4 |
| 5690 | Non HT80, 6 to 54 Mbps | 1 | 4 | 15.4 | | 15.4 | 24.0 | 8.6 |
| | Non HT80, 6 to 54 Mbps | 2 | 4 | 15.4 | 16.5 | 19.0 | 24.0 | 5.0 |
| | VHT80, M0 to M9 1ss | 1 | 4 | 15.1 | | 15.1 | 24.0 | 8.9 |
| | VHT80, M0 to M9 1ss | 2 | 4 | 15.1 | 16.1 | 18.6 | 24.0 | 5.4 |
| | VHT80, M0 to M9 2ss | 2 | 4 | 15.1 | 16.1 | 18.6 | 24.0 | 5.4 |
| | VHT80 Beam Forming, M0 to M9 1ss | 2 | 7 | 15.1 | 16.1 | 18.6 | 23.0 | 4.4 |
| | VHT80 Beam Forming, M0 to M9 2ss | 2 | 4 | 15.1 | 16.1 | 18.6 | 24.0 | 5.4 |
| | VHT80 STBC, M0 to M9 1ss | 2 | 4 | 15.1 | 16.1 | 18.6 | 24.0 | 5.4 |

| | | | | | | | | |
|------|-------------------------------------|---|---|------|------|------|------|-----|
| 5700 | Non HT20, 6 to 54 Mbps | 1 | 4 | 15.6 | | 15.6 | 23.4 | 7.8 |
| | Non HT20, 6 to 54 Mbps | 2 | 4 | 15.6 | 16.6 | 19.1 | 23.4 | 4.3 |
| | Non HT20 Beam Forming, 6 to 54 Mbps | 2 | 7 | 15.6 | 16.6 | 19.1 | 22.4 | 3.3 |
| | HT/VHT20, M0 to M7 | 1 | 4 | 15.6 | | 15.6 | 23.6 | 8.0 |
| | HT/VHT20, M0 to M7 | 2 | 4 | 15.6 | 16.6 | 19.1 | 23.6 | 4.5 |
| | HT/VHT20, M8 to M15 | 2 | 4 | 15.6 | 16.6 | 19.1 | 23.6 | 4.5 |
| | HT/VHT20 Beam Forming, M0 to M7 | 2 | 7 | 15.6 | 16.6 | 19.1 | 22.6 | 3.5 |
| | HT/VHT20 Beam Forming, M8 to M15 | 2 | 4 | 15.6 | 16.6 | 19.1 | 23.6 | 4.5 |
| | HT/VHT20 STBC, M0 to M7 | 2 | 4 | 15.6 | 16.6 | 19.1 | 23.6 | 4.5 |
| 5710 | Non HT40, 6 to 54 Mbps | 1 | 4 | 15.2 | | 15.2 | 24.0 | 8.8 |
| | Non HT40, 6 to 54 Mbps | 2 | 4 | 15.2 | 15.9 | 18.6 | 24.0 | 5.4 |
| | HT/VHT40, M0 to M7 | 1 | 4 | 15.5 | | 15.5 | 24.0 | 8.5 |
| | HT/VHT40, M0 to M7 | 2 | 4 | 15.5 | 16.3 | 18.9 | 24.0 | 5.1 |
| | HT/VHT40, M8 to M15 | 2 | 4 | 15.5 | 16.3 | 18.9 | 24.0 | 5.1 |
| | HT/VHT40 Beam Forming, M0 to M7 | 2 | 7 | 15.5 | 16.3 | 18.9 | 23.0 | 4.1 |
| | HT/VHT40 Beam Forming, M8 to M15 | 2 | 4 | 15.5 | 16.3 | 18.9 | 24.0 | 5.1 |
| | HT/VHT40 STBC, M0 to M7 | 2 | 4 | 15.5 | 16.3 | 18.9 | 24.0 | 5.1 |
| 5720 | Non HT20, 6 to 54 Mbps | 1 | 4 | 15.7 | | 15.7 | 23.4 | 7.7 |
| | Non HT20, 6 to 54 Mbps | 2 | 4 | 15.7 | 15.9 | 18.8 | 23.4 | 4.6 |
| | Non HT20 Beam Forming, 6 to 54 Mbps | 2 | 7 | 15.7 | 15.9 | 18.8 | 22.4 | 3.6 |
| | HT/VHT20, M0 to M7 | 1 | 4 | 15.7 | | 15.7 | 23.6 | 7.9 |
| | HT/VHT20, M0 to M7 | 2 | 4 | 15.7 | 15.8 | 18.8 | 23.6 | 4.8 |
| | HT/VHT20, M8 to M15 | 2 | 4 | 15.7 | 15.8 | 18.8 | 23.6 | 4.8 |
| | HT/VHT20 Beam Forming, M0 to M7 | 2 | 7 | 15.7 | 15.8 | 18.8 | 22.6 | 3.8 |
| | HT/VHT20 Beam Forming, M8 to M15 | 2 | 4 | 15.7 | 15.8 | 18.8 | 23.6 | 4.8 |
| | HT/VHT20 STBC, M0 to M7 | 2 | 4 | 15.7 | 15.8 | 18.8 | 23.6 | 4.8 |

| Frequency (MHz) | Mode | Tx Paths | Correlated Antenna Gain (dBi) | Tx 1 PSD (dBm/MHz) | Tx 2 PSD (dBm/MHz) | Total PSD (dBm/MHz) | Limit (dBm/MHz) | Margin (dB) |
|-----------------|-------------------------------------|----------|-------------------------------|--------------------|--------------------|---------------------|-----------------|-------------|
| 5500 | Non HT20, 6 to 54 Mbps | 1 | 4 | 4.8 | | 4.8 | 11.0 | 6.2 |
| | Non HT20, 6 to 54 Mbps | 2 | 7 | 4.8 | 6.6 | 8.8 | 10.0 | 1.2 |
| | Non HT20 Beam Forming, 6 to 54 Mbps | 2 | 7 | 4.3 | 5.5 | 8.0 | 10.0 | 2.0 |
| | HT/VHT20, M0 to M7 | 1 | 4 | 4.4 | | 4.4 | 11.0 | 6.6 |
| | HT/VHT20, M0 to M7 | 2 | 7 | 4.4 | 5.9 | 8.2 | 10.0 | 1.8 |
| | HT/VHT20, M8 to M15 | 2 | 4 | 4.4 | 5.9 | 8.2 | 11.0 | 2.8 |
| | HT/VHT20 Beam Forming, M0 to M7 | 2 | 7 | 4.0 | 5.4 | 7.8 | 10.0 | 2.2 |
| | HT/VHT20 Beam Forming, M8 to M15 | 2 | 4 | 4.4 | 5.9 | 8.2 | 11.0 | 2.8 |
| | HT/VHT20 STBC, M0 to M7 | 2 | 4 | 4.4 | 5.9 | 8.2 | 11.0 | 2.8 |
| 5510 | Non HT40, 6 to 54 Mbps | 1 | 4 | 0.7 | | 0.7 | 11.0 | 10.3 |
| | Non HT40, 6 to 54 Mbps | 2 | 7 | -0.3 | 1.7 | 3.8 | 10.0 | 6.2 |
| | HT/VHT40, M0 to M7 | 1 | 4 | -0.3 | | -0.3 | 11.0 | 11.3 |
| | HT/VHT40, M0 to M7 | 2 | 7 | -1.3 | 0.2 | 2.5 | 10.0 | 7.5 |
| | HT/VHT40, M8 to M15 | 2 | 4 | -1.3 | 0.2 | 2.5 | 11.0 | 8.5 |
| | HT/VHT40 Beam Forming, M0 to M7 | 2 | 7 | -2.2 | -0.9 | 1.5 | 10.0 | 8.5 |
| | HT/VHT40 Beam Forming, M8 to M15 | 2 | 4 | -1.3 | 0.2 | 2.5 | 11.0 | 8.5 |
| | HT/VHT40 STBC, M0 to M7 | 2 | 4 | -1.3 | 0.2 | 2.5 | 11.0 | 8.5 |
| 5530 | Non HT80, 6 to 54 Mbps | 1 | 4 | -1.5 | | -1.5 | 11.0 | 12.5 |
| | Non HT80, 6 to 54 Mbps | 2 | 7 | -2.4 | -2.6 | 0.5 | 10.0 | 9.5 |
| | VHT80, M0 to M9 1ss | 1 | 4 | -3.0 | | -3.0 | 11.0 | 14.0 |
| | VHT80, M0 to M9 1ss | 2 | 7 | -3.9 | -4.1 | -1.0 | 10.0 | 11.0 |
| | VHT80, M0 to M9 2ss | 2 | 4 | -3.9 | -4.1 | -1.0 | 11.0 | 12.0 |
| | VHT80 Beam Forming, M0 to M9 1ss | 2 | 7 | -5.0 | -5.1 | -2.0 | 10.0 | 12.0 |
| | VHT80 Beam Forming, M0 to M9 2ss | 2 | 4 | -3.9 | -4.1 | -1.0 | 11.0 | 12.0 |
| | VHT80 STBC, M0 to M9 1ss | 2 | 4 | -3.9 | -4.1 | -1.0 | 11.0 | 12.0 |
| 5550 | Non HT40, 6 to 54 Mbps | 1 | 4 | 3.5 | | 3.5 | 11.0 | 7.5 |
| | Non HT40, 6 to 54 Mbps | 2 | 7 | 3.5 | 3.3 | 6.4 | 10.0 | 3.6 |
| | HT/VHT40, M0 to M7 | 1 | 4 | 2.2 | | 2.2 | 11.0 | 8.8 |
| | HT/VHT40, M0 to M7 | 2 | 7 | 2.2 | 2.3 | 5.3 | 10.0 | 4.7 |
| | HT/VHT40, M8 to M15 | 2 | 4 | 2.2 | 2.3 | 5.3 | 11.0 | 5.7 |
| | HT/VHT40 Beam Forming, M0 to M7 | 2 | 7 | 2.2 | 2.3 | 5.3 | 10.0 | 4.7 |
| | HT/VHT40 Beam Forming, M8 to M15 | 2 | 4 | 2.2 | 2.3 | 5.3 | 11.0 | 5.7 |
| | HT/VHT40 STBC, M0 to M7 | 2 | 4 | 2.2 | 2.3 | 5.3 | 11.0 | 5.7 |

| | | | | | | | | |
|------|-------------------------------------|---|---|------|------|------|------|------|
| 5560 | Non HT20, 6 to 54 Mbps | 1 | 4 | 5.4 | | 5.4 | 11.0 | 5.6 |
| | Non HT20, 6 to 54 Mbps | 2 | 7 | 5.4 | 4.9 | 8.2 | 10.0 | 1.8 |
| | Non HT20 Beam Forming, 6 to 54 Mbps | 2 | 7 | 5.4 | 4.9 | 8.2 | 10.0 | 1.8 |
| | HT/VHT20, M0 to M7 | 1 | 4 | 5.3 | | 5.3 | 11.0 | 5.7 |
| | HT/VHT20, M0 to M7 | 2 | 7 | 5.3 | 4.8 | 8.1 | 10.0 | 1.9 |
| | HT/VHT20, M8 to M15 | 2 | 4 | 5.3 | 4.8 | 8.1 | 11.0 | 2.9 |
| | HT/VHT20 Beam Forming, M0 to M7 | 2 | 7 | 5.3 | 4.8 | 8.1 | 10.0 | 1.9 |
| | HT/VHT20 Beam Forming, M8 to M15 | 2 | 4 | 5.3 | 4.8 | 8.1 | 11.0 | 2.9 |
| | HT/VHT20 STBC, M0 to M7 | 2 | 4 | 5.3 | 4.8 | 8.1 | 11.0 | 2.9 |
| 5660 | Non HT20, 6 to 54 Mbps | 1 | 4 | 5.0 | | 5.0 | 11.0 | 6.0 |
| | Non HT20, 6 to 54 Mbps | 2 | 7 | 5.0 | 6.2 | 8.7 | 10.0 | 1.3 |
| | Non HT20 Beam Forming, 6 to 54 Mbps | 2 | 7 | 5.0 | 6.2 | 8.7 | 10.0 | 1.3 |
| | HT/VHT20, M0 to M7 | 1 | 4 | 4.7 | | 4.7 | 11.0 | 6.3 |
| | HT/VHT20, M0 to M7 | 2 | 7 | 4.7 | 5.9 | 8.4 | 10.0 | 1.6 |
| | HT/VHT20, M8 to M15 | 2 | 4 | 4.7 | 5.9 | 8.4 | 11.0 | 2.6 |
| | HT/VHT20 Beam Forming, M0 to M7 | 2 | 7 | 4.7 | 5.9 | 8.4 | 10.0 | 1.6 |
| | HT/VHT20 Beam Forming, M8 to M15 | 2 | 4 | 4.7 | 5.9 | 8.4 | 11.0 | 2.6 |
| | HT/VHT20 STBC, M0 to M7 | 2 | 4 | 4.7 | 5.9 | 8.4 | 11.0 | 2.6 |
| 5670 | Non HT40, 6 to 54 Mbps | 1 | 4 | 3.2 | | 3.2 | 11.0 | 7.8 |
| | Non HT40, 6 to 54 Mbps | 2 | 7 | 3.2 | 4.0 | 6.6 | 10.0 | 3.4 |
| | HT/VHT40, M0 to M7 | 1 | 4 | 1.8 | | 1.8 | 11.0 | 9.2 |
| | HT/VHT40, M0 to M7 | 2 | 7 | 1.8 | 3.3 | 5.6 | 10.0 | 4.4 |
| | HT/VHT40, M8 to M15 | 2 | 4 | 1.8 | 3.3 | 5.6 | 11.0 | 5.4 |
| | HT/VHT40 Beam Forming, M0 to M7 | 2 | 7 | 1.8 | 3.3 | 5.6 | 10.0 | 4.4 |
| | HT/VHT40 Beam Forming, M8 to M15 | 2 | 4 | 1.8 | 3.3 | 5.6 | 11.0 | 5.4 |
| | HT/VHT40 STBC, M0 to M7 | 2 | 4 | 1.8 | 3.3 | 5.6 | 11.0 | 5.4 |
| 5690 | Non HT80, 6 to 54 Mbps | 1 | 4 | 0.1 | | 0.1 | 11.0 | 10.9 |
| | Non HT80, 6 to 54 Mbps | 2 | 7 | 0.1 | 0.7 | 3.4 | 10.0 | 6.6 |
| | VHT80, M0 to M9 1ss | 1 | 4 | -1.5 | | -1.5 | 11.0 | 12.5 |
| | VHT80, M0 to M9 1ss | 2 | 7 | -1.5 | -1.1 | 1.7 | 10.0 | 8.3 |
| | VHT80, M0 to M9 2ss | 2 | 4 | -1.5 | -1.1 | 1.7 | 11.0 | 9.3 |
| | VHT80 Beam Forming, M0 to M9 1ss | 2 | 7 | -1.5 | -1.1 | 1.7 | 10.0 | 8.3 |
| | VHT80 Beam Forming, M0 to M9 2ss | 2 | 4 | -1.5 | -1.1 | 1.7 | 11.0 | 9.3 |
| | VHT80 STBC, M0 to M9 1ss | 2 | 4 | -1.5 | -1.1 | 1.7 | 11.0 | 9.3 |
| 5700 | Non HT20, 6 to 54 Mbps | 1 | 4 | 4.8 | | 4.8 | 11.0 | 6.2 |
| | Non HT20, 6 to 54 Mbps | 2 | 7 | 4.8 | 5.9 | 8.4 | 10.0 | 1.6 |

| | | | | | | | | |
|------|-------------------------------------|---|---|-----|-----|-----|------|-----|
| | Non HT20 Beam Forming, 6 to 54 Mbps | 2 | 7 | 4.8 | 5.9 | 8.4 | 10.0 | 1.6 |
| | HT/VHT20, M0 to M7 | 1 | 4 | 4.6 | | 4.6 | 11.0 | 6.4 |
| | HT/VHT20, M0 to M7 | 2 | 7 | 4.6 | 5.5 | 8.1 | 10.0 | 1.9 |
| | HT/VHT20, M8 to M15 | 2 | 4 | 4.6 | 5.5 | 8.1 | 11.0 | 2.9 |
| | HT/VHT20 Beam Forming, M0 to M7 | 2 | 7 | 4.6 | 5.5 | 8.1 | 10.0 | 1.9 |
| | HT/VHT20 Beam Forming, M8 to M15 | 2 | 4 | 4.6 | 5.5 | 8.1 | 11.0 | 2.9 |
| | HT/VHT20 STBC, M0 to M7 | 2 | 4 | 4.6 | 5.5 | 8.1 | 11.0 | 2.9 |
| 5710 | Non HT40, 6 to 54 Mbps | 1 | 4 | 3.5 | | 3.5 | 11.0 | 7.5 |
| | Non HT40, 6 to 54 Mbps | 2 | 7 | 3.5 | 3.3 | 6.4 | 10.0 | 3.6 |
| | HT/VHT40, M0 to M7 | 1 | 4 | 1.7 | | 1.7 | 11.0 | 9.3 |
| | HT/VHT40, M0 to M7 | 2 | 7 | 1.7 | 2.1 | 4.9 | 10.0 | 5.1 |
| | HT/VHT40, M8 to M15 | 2 | 4 | 1.7 | 2.1 | 4.9 | 11.0 | 6.1 |
| | HT/VHT40 Beam Forming, M0 to M7 | 2 | 7 | 1.7 | 2.1 | 4.9 | 10.0 | 5.1 |
| | HT/VHT40 Beam Forming, M8 to M15 | 2 | 4 | 1.7 | 2.1 | 4.9 | 11.0 | 6.1 |
| | HT/VHT40 STBC, M0 to M7 | 2 | 4 | 1.7 | 2.1 | 4.9 | 11.0 | 6.1 |
| 5720 | Non HT20, 6 to 54 Mbps | 1 | 4 | 5.3 | | 5.3 | 11.0 | 5.7 |
| | Non HT20, 6 to 54 Mbps | 2 | 7 | 5.3 | 5.3 | 8.3 | 10.0 | 1.7 |
| | Non HT20 Beam Forming, 6 to 54 Mbps | 2 | 7 | 5.3 | 5.3 | 8.3 | 10.0 | 1.7 |
| | HT/VHT20, M0 to M7 | 1 | 4 | 4.5 | | 4.5 | 11.0 | 6.5 |
| | HT/VHT20, M0 to M7 | 2 | 7 | 4.5 | 4.8 | 7.7 | 10.0 | 2.3 |
| | HT/VHT20, M8 to M15 | 2 | 4 | 4.5 | 4.8 | 7.7 | 11.0 | 3.3 |
| | HT/VHT20 Beam Forming, M0 to M7 | 2 | 7 | 4.5 | 4.8 | 7.7 | 10.0 | 2.3 |
| | HT/VHT20 Beam Forming, M8 to M15 | 2 | 4 | 4.5 | 4.8 | 7.7 | 11.0 | 3.3 |
| | HT/VHT20 STBC, M0 to M7 | 2 | 4 | 4.5 | 4.8 | 7.7 | 11.0 | 3.3 |

Peak Output Power, 5660 MHz, Non HT20 Beam Forming, 6 to 54 Mbps

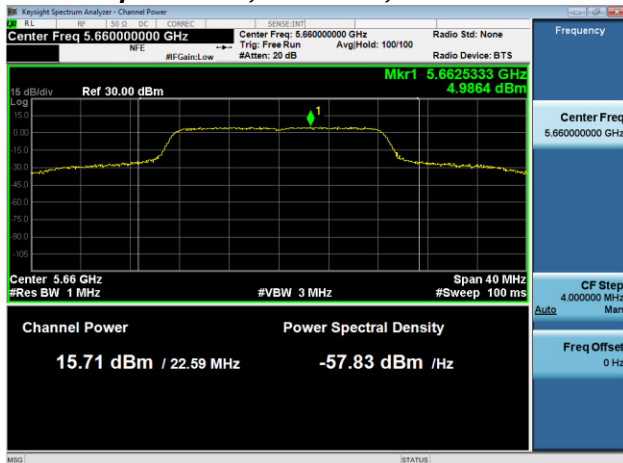

Antenna A

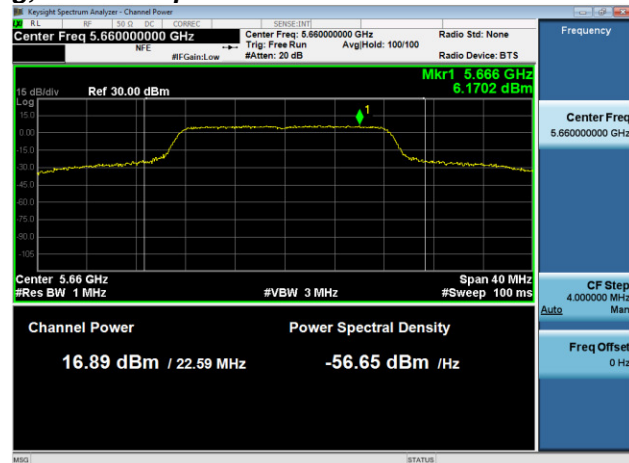

Antenna B

Power Spectral Density, 5500 MHz, Non HT20, 6 to 54 Mbps

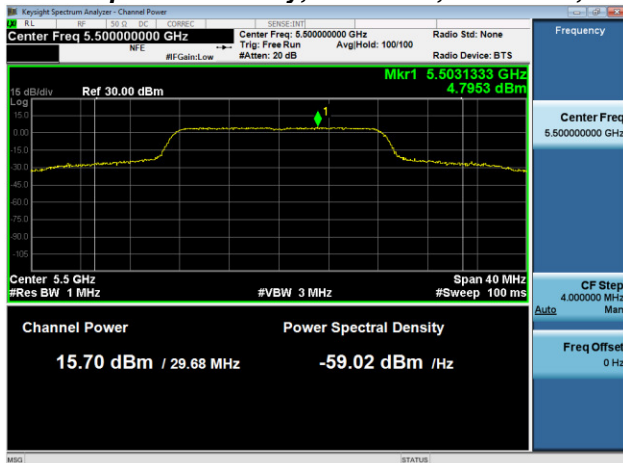

Antenna A

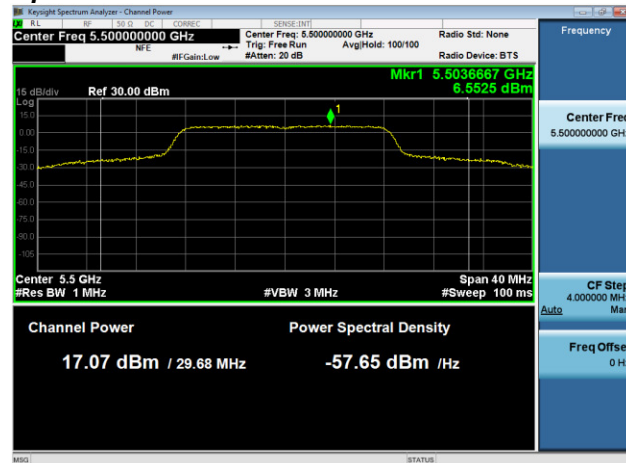

Antenna B

A.3 Conducted Spurious Emissions

15.407 (b) Undesirable emission limits. Except as shown in paragraph (b) (7) of this section, the maximum emissions outside of the frequency bands of operation shall be attenuated in accordance with the following limits:

- (3) For transmitters operating in the 5.47-5.725 GHz band: All emissions outside of the 5.47-5.725 GHz band shall not exceed an e.i.r.p. of -27 dBm/MHz..
- (6) Unwanted emissions below 1 GHz must comply with the general field strength limits set forth in §15.209.
- (7) The provisions of §15.205 apply to intentional radiators operating under this section.

Test Procedure

Ref. KDB 789033 D02 General UNII Test Procedures New Rules v01r03
ANSI C63.10: 2013

Conducted Spurious Emissions

Test Procedure

1. Connect the antenna port(s) to the spectrum analyzer input.
2. Place the radio in continuous transmit mode. Use the procedures in KDB 789033 D02 General UNII Test Procedures New Rules v01r03 to substitute conducted measurements in place of radiated measurements.
3. Configure Spectrum analyzer as per test parameters below (be sure to enter all losses between the transmitter output and the spectrum analyzer).
4. Record the marker waveform peak to spur difference. Also measure any emissions in the restricted bands.
5. The "measure-and-sum technique" is used for measuring in-band transmit power of a device. In the measure-and-sum approach, the conducted emission level is measured at each antenna port. The measured results at the various antenna ports are then summed mathematically to determine the total emission level from the device. Summing is performed in linear power units. The worst case output is recorded.
6. Capture graphs and record pertinent measurement data.

Ref. KDB 789033 D02 General UNII Test Procedures New Rules v01r03
ANSI C63.10: 2013 section 12.7.7.3 (average) & 12.7.6 (peak)

Conducted Spurious Emissions

Test parameters

Span = 30MHz to 18GHz / 18GHz to 40GHz
RBW = 1 MHz
VBW ≥ 3 x RBW for Peak, 1kHz for Average
Sweep = Auto couple
Detector = Peak
Trace = Max Hold.

| System Number | Description | Samples | System under test | Support equipment |
|---------------|-------------|---------|-------------------------------------|-------------------------------------|
| 1 | EUT | S01 | <input checked="" type="checkbox"/> | <input type="checkbox"/> |
| | Support | S02 | <input type="checkbox"/> | <input checked="" type="checkbox"/> |

| | |
|------------------------------------|--|
| Tested By : Jose Aguirre | Date of testing: 01-Jun-16 - 26-Jun-16 |
| Test Result : PASS | |

See Appendix C for list of test equipment

| Frequency (MHz) | Mode | Tx Paths | Correlated Antenna Gain (dBi) | Tx 1 Spur Power (dBm) | Tx 2 Spur Power (dBm) | Total Conducted Spur (dBm) | Limit (dBm) | Margin (dB) |
|-----------------|--|----------|-------------------------------|-----------------------|-----------------------|----------------------------|---------------|-------------|
| 5500 | Non HT20, 6 to 54 Mbps | 1 | 4 | -57.7 | | -53.7 | -41.25 | 12.5 |
| | Non HT20, 6 to 54 Mbps | 2 | 4 | -57.7 | -56.3 | -49.9 | -41.25 | 8.7 |
| | Non HT20 Beam Forming, 6 to 54 Mbps | 2 | 7 | -57.3 | -56.0 | -46.6 | -41.25 | 5.3 |
| | HT/VHT20, M0 to M7 | 1 | 4 | -57.1 | | -53.1 | -41.25 | 11.9 |
| | HT/VHT20, M0 to M7 | 2 | 4 | -57.1 | -56.3 | -49.7 | -41.25 | 8.4 |
| | HT/VHT20, M8 to M15 | 2 | 4 | -57.1 | -56.3 | -49.7 | -41.25 | 8.4 |
| | HT/VHT20 Beam Forming, M0 to M7 | 2 | 7 | -57.9 | -55.5 | -46.5 | -41.25 | 5.3 |
| | HT/VHT20 Beam Forming, M8 to M15 | 2 | 4 | -57.1 | -56.3 | -49.7 | -41.25 | 8.4 |
| | HT/VHT20 STBC, M0 to M7 | 2 | 4 | -57.1 | -56.3 | -49.7 | -41.25 | 8.4 |
| 5510 | Non HT40, 6 to 54 Mbps | 1 | 4 | -58.1 | | -54.1 | -41.25 | 12.9 |
| | Non HT40, 6 to 54 Mbps | 2 | 4 | -58.1 | -56.6 | -50.3 | -41.25 | 9.0 |
| | HT/VHT40, M0 to M7 | 1 | 4 | -56.5 | | -52.5 | -41.25 | 11.3 |
| | HT/VHT40, M0 to M7 | 2 | 4 | -58.0 | -56.4 | -50.1 | -41.25 | 8.9 |
| | HT/VHT40, M8 to M15 | 2 | 4 | -58.0 | -56.4 | -50.1 | -41.25 | 8.9 |
| | HT/VHT40 Beam Forming, M0 to M7 | 2 | 7 | -57.0 | -56.9 | -46.9 | -41.25 | 5.7 |
| | HT/VHT40 Beam Forming, M8 to M15 | 2 | 4 | -58.0 | -56.4 | -50.1 | -41.25 | 8.9 |
| | HT/VHT40 STBC, M0 to M7 | 2 | 4 | -58.0 | -56.4 | -50.1 | -41.25 | 8.9 |
| 5530 | Non HT80, 6 to 54 Mbps | 1 | 4 | -57.4 | | -53.4 | -41.25 | 12.2 |
| | Non HT80, 6 to 54 Mbps | 2 | 4 | -57.3 | -57.0 | -50.1 | -41.25 | 8.9 |
| | VHT80, M0 to M9 1ss | 1 | 4 | -56.8 | | -52.8 | -41.25 | 11.6 |
| | VHT80, M0 to M9 1ss | 2 | 4 | -56.8 | -56.2 | -49.5 | -41.25 | 8.2 |
| | VHT80, M0 to M9 2ss | 2 | 4 | -56.8 | -56.2 | -49.5 | -41.25 | 8.2 |
| | VHT80 Beam Forming, M0 to M9 1ss | 2 | 7 | -57.8 | -58.3 | -48.0 | -41.25 | 6.8 |
| | VHT80 Beam Forming, M0 to M9 2ss | 2 | 4 | -56.8 | -56.2 | -49.5 | -41.25 | 8.2 |
| | VHT80 STBC, M0 to M9 1ss | 2 | 4 | -56.8 | -56.2 | -49.5 | -41.25 | 8.2 |
| 5550 | Non HT40, 6 to 54 Mbps | 1 | 4 | -57.0 | | -53.0 | -41.25 | 11.8 |
| | Non HT40, 6 to 54 Mbps | 2 | 4 | -57.0 | -56.5 | -49.7 | -41.25 | 8.5 |
| | HT/VHT40, M0 to M7 | 1 | 4 | -57.1 | | -53.1 | -41.25 | 11.9 |
| | HT/VHT40, M0 to M7 | 2 | 4 | -57.1 | -57.1 | -50.1 | -41.25 | 8.8 |
| | HT/VHT40, M8 to M15 | 2 | 4 | -57.1 | -57.1 | -50.1 | -41.25 | 8.8 |
| | HT/VHT40 Beam Forming, M0 to M7 | 2 | 7 | -57.1 | -57.1 | -47.1 | -41.25 | 5.8 |
| | HT/VHT40 Beam Forming, M8 to M15 | 2 | 4 | -57.1 | -57.1 | -50.1 | -41.25 | 8.8 |
| | HT/VHT40 STBC, M0 to M7 | 2 | 4 | -57.1 | -57.1 | -50.1 | -41.25 | 8.8 |

| | | | | | | | | |
|------|-------------------------------------|---|---|-------|-------|-------|--------|------|
| 5560 | Non HT20, 6 to 54 Mbps | 1 | 4 | -57.8 | | -53.8 | -41.25 | 12.6 |
| | Non HT20, 6 to 54 Mbps | 2 | 4 | -57.8 | -56.5 | -50.1 | -41.25 | 8.8 |
| | Non HT20 Beam Forming, 6 to 54 Mbps | 2 | 7 | -57.8 | -56.5 | -47.1 | -41.25 | 5.8 |
| | HT/VHT20, M0 to M7 | 1 | 4 | -58.3 | | -54.3 | -41.25 | 13.1 |
| | HT/VHT20, M0 to M7 | 2 | 4 | -58.3 | -56.8 | -50.5 | -41.25 | 9.2 |
| | HT/VHT20, M8 to M15 | 2 | 4 | -58.3 | -56.8 | -50.5 | -41.25 | 9.2 |
| | HT/VHT20 Beam Forming, M0 to M7 | 2 | 7 | -58.3 | -56.8 | -47.5 | -41.25 | 6.2 |
| | HT/VHT20 Beam Forming, M8 to M15 | 2 | 4 | -58.3 | -56.8 | -50.5 | -41.25 | 9.2 |
| | HT/VHT20 STBC, M0 to M7 | 2 | 4 | -58.3 | -56.8 | -50.5 | -41.25 | 9.2 |
| 5660 | Non HT20, 6 to 54 Mbps | 1 | 4 | -58.2 | | -54.2 | -41.25 | 13.0 |
| | Non HT20, 6 to 54 Mbps | 2 | 4 | -58.2 | -57.2 | -50.7 | -41.25 | 9.4 |
| | Non HT20 Beam Forming, 6 to 54 Mbps | 2 | 7 | -58.2 | -57.2 | -47.7 | -41.25 | 6.4 |
| | HT/VHT20, M0 to M7 | 1 | 4 | -58.2 | | -54.2 | -41.25 | 13.0 |
| | HT/VHT20, M0 to M7 | 2 | 4 | -58.2 | -58.1 | -51.1 | -41.25 | 9.9 |
| | HT/VHT20, M8 to M15 | 2 | 4 | -58.2 | -58.1 | -51.1 | -41.25 | 9.9 |
| | HT/VHT20 Beam Forming, M0 to M7 | 2 | 7 | -58.2 | -58.1 | -48.1 | -41.25 | 6.9 |
| | HT/VHT20 Beam Forming, M8 to M15 | 2 | 4 | -58.2 | -58.1 | -51.1 | -41.25 | 9.9 |
| | HT/VHT20 STBC, M0 to M7 | 2 | 4 | -58.2 | -58.1 | -51.1 | -41.25 | 9.9 |
| 5670 | Non HT40, 6 to 54 Mbps | 1 | 4 | -57.6 | | -53.6 | -41.25 | 12.4 |
| | Non HT40, 6 to 54 Mbps | 2 | 4 | -57.6 | -57.1 | -50.3 | -41.25 | 9.1 |
| | HT/VHT40, M0 to M7 | 1 | 4 | -58.7 | | -54.7 | -41.25 | 13.5 |
| | HT/VHT40, M0 to M7 | 2 | 4 | -58.7 | -57.1 | -50.8 | -41.25 | 9.6 |
| | HT/VHT40, M8 to M15 | 2 | 4 | -58.7 | -57.1 | -50.8 | -41.25 | 9.6 |
| | HT/VHT40 Beam Forming, M0 to M7 | 2 | 7 | -58.7 | -57.1 | -47.8 | -41.25 | 6.6 |
| | HT/VHT40 Beam Forming, M8 to M15 | 2 | 4 | -58.7 | -57.1 | -50.8 | -41.25 | 9.6 |
| | HT/VHT40 STBC, M0 to M7 | 2 | 4 | -58.7 | -57.1 | -50.8 | -41.25 | 9.6 |
| 5690 | Non HT80, 6 to 54 Mbps | 1 | 4 | -58.3 | | -54.3 | -41.25 | 13.1 |
| | Non HT80, 6 to 54 Mbps | 2 | 4 | -58.3 | -57.3 | -50.8 | -41.25 | 9.5 |
| | VHT80, M0 to M9 1ss | 1 | 4 | -58.1 | | -54.1 | -41.25 | 12.9 |
| | VHT80, M0 to M9 1ss | 2 | 4 | -58.1 | -59.5 | -51.7 | -41.25 | 10.5 |
| | VHT80, M0 to M9 2ss | 2 | 4 | -58.1 | -59.5 | -51.7 | -41.25 | 10.5 |
| | VHT80 Beam Forming, M0 to M9 1ss | 2 | 7 | -58.1 | -59.5 | -48.7 | -41.25 | 7.5 |
| | VHT80 Beam Forming, M0 to M9 2ss | 2 | 4 | -58.1 | -59.5 | -51.7 | -41.25 | 10.5 |
| | VHT80 STBC, M0 to M9 1ss | 2 | 4 | -58.1 | -59.5 | -51.7 | -41.25 | 10.5 |
| 5700 | Non HT20, 6 to 54 Mbps | 1 | 4 | -58.1 | | -54.1 | -41.25 | 12.9 |
| | Non HT20, 6 to 54 Mbps | 2 | 4 | -58.1 | -57.9 | -51.0 | -41.25 | 9.7 |

| | | | | | | | | |
|------|-------------------------------------|---|---|-------|-------|-------|--------|------|
| | Non HT20 Beam Forming, 6 to 54 Mbps | 2 | 7 | -58.1 | -57.9 | -48.0 | -41.25 | 6.7 |
| | HT/VHT20, M0 to M7 | 1 | 4 | -58.6 | | -54.6 | -41.25 | 13.4 |
| | HT/VHT20, M0 to M7 | 2 | 4 | -58.6 | -57.7 | -51.1 | -41.25 | 9.9 |
| | HT/VHT20, M8 to M15 | 2 | 4 | -58.6 | -57.7 | -51.1 | -41.25 | 9.9 |
| | HT/VHT20 Beam Forming, M0 to M7 | 2 | 7 | -58.6 | -57.7 | -48.1 | -41.25 | 6.9 |
| | HT/VHT20 Beam Forming, M8 to M15 | 2 | 4 | -58.6 | -57.7 | -51.1 | -41.25 | 9.9 |
| | HT/VHT20 STBC, M0 to M7 | 2 | 4 | -58.6 | -57.7 | -51.1 | -41.25 | 9.9 |
| 5710 | Non HT40, 6 to 54 Mbps | 1 | 4 | -57.5 | | -53.5 | -41.25 | 12.3 |
| | Non HT40, 6 to 54 Mbps | 2 | 4 | -57.5 | -57.4 | -50.4 | -41.25 | 9.2 |
| | HT/VHT40, M0 to M7 | 1 | 4 | -57.5 | | -53.5 | -41.25 | 12.3 |
| | HT/VHT40, M0 to M7 | 2 | 4 | -57.5 | -57.5 | -50.5 | -41.25 | 9.2 |
| | HT/VHT40, M8 to M15 | 2 | 4 | -57.5 | -57.5 | -50.5 | -41.25 | 9.2 |
| | HT/VHT40 Beam Forming, M0 to M7 | 2 | 7 | -57.5 | -57.5 | -47.5 | -41.25 | 6.2 |
| | HT/VHT40 Beam Forming, M8 to M15 | 2 | 4 | -57.5 | -57.5 | -50.5 | -41.25 | 9.2 |
| | HT/VHT40 STBC, M0 to M7 | 2 | 4 | -57.5 | -57.5 | -50.5 | -41.25 | 9.2 |
| 5720 | Non HT20, 6 to 54 Mbps | 1 | 4 | -58.2 | | -54.2 | -41.25 | 13.0 |
| | Non HT20, 6 to 54 Mbps | 2 | 4 | -58.2 | -57.1 | -50.6 | -41.25 | 9.4 |
| | Non HT20 Beam Forming, 6 to 54 Mbps | 2 | 7 | -58.2 | -57.1 | -47.6 | -41.25 | 6.4 |
| | HT/VHT20, M0 to M7 | 1 | 4 | -58.0 | | -54.0 | -41.25 | 12.8 |
| | HT/VHT20, M0 to M7 | 2 | 4 | -58.0 | -56.8 | -50.3 | -41.25 | 9.1 |
| | HT/VHT20, M8 to M15 | 2 | 4 | -58.0 | -56.8 | -50.3 | -41.25 | 9.1 |
| | HT/VHT20 Beam Forming, M0 to M7 | 2 | 7 | -58.0 | -56.8 | -47.3 | -41.25 | 6.1 |
| | HT/VHT20 Beam Forming, M8 to M15 | 2 | 4 | -58.0 | -56.8 | -50.3 | -41.25 | 9.1 |
| | HT/VHT20 STBC, M0 to M7 | 2 | 4 | -58.0 | -56.8 | -50.3 | -41.25 | 9.1 |

| Frequency (MHz) | Mode | Tx Paths | Correlated Antenna Gain (dBi) | Tx 1 Spur Power (dBm) | Tx 2 Spur Power (dBm) | Total Conducted Spur (dBm) | Limit (dBm) | Margin (dB) |
|-----------------|-------------------------------------|----------|-------------------------------|-----------------------|-----------------------|----------------------------|-------------|-------------|
| 5500 | Non HT20, 6 to 54 Mbps | 1 | 4 | -58.0 | | -54.0 | -21.25 | 32.8 |
| | Non HT20, 6 to 54 Mbps | 2 | 4 | -58.0 | -59.7 | -51.8 | -21.25 | 30.5 |
| | Non HT20 Beam Forming, 6 to 54 Mbps | 2 | 7 | -58.0 | -57.6 | -47.8 | -21.25 | 26.5 |
| | HT/VHT20, M0 to M7 | 1 | 4 | -58.7 | | -54.7 | -21.25 | 33.5 |
| | HT/VHT20, M0 to M7 | 2 | 4 | -58.7 | -52.6 | -47.6 | -21.25 | 26.4 |
| | HT/VHT20, M8 to M15 | 2 | 4 | -58.7 | -52.6 | -47.6 | -21.25 | 26.4 |
| | HT/VHT20 Beam Forming, M0 to M7 | 2 | 7 | -58.7 | -56.8 | -47.6 | -21.25 | 26.4 |
| | HT/VHT20 Beam Forming, M8 to M15 | 2 | 4 | -58.7 | -52.6 | -47.6 | -21.25 | 26.4 |
| | HT/VHT20 STBC, M0 to M7 | 2 | 4 | -58.7 | -52.6 | -47.6 | -21.25 | 26.4 |
| 5510 | Non HT40, 6 to 54 Mbps | 1 | 4 | -56.8 | | -52.8 | -21.25 | 31.6 |
| | Non HT40, 6 to 54 Mbps | 2 | 4 | -59.0 | -60.2 | -52.5 | -21.25 | 31.3 |
| | HT/VHT40, M0 to M7 | 1 | 4 | -57.9 | | -53.9 | -21.25 | 32.7 |
| | HT/VHT40, M0 to M7 | 2 | 4 | -59.9 | -58.9 | -52.4 | -21.25 | 31.1 |
| | HT/VHT40, M8 to M15 | 2 | 4 | -59.9 | -58.9 | -52.4 | -21.25 | 31.1 |
| | HT/VHT40 Beam Forming, M0 to M7 | 2 | 7 | -59.4 | -58.7 | -49.0 | -21.25 | 27.8 |
| | HT/VHT40 Beam Forming, M8 to M15 | 2 | 4 | -59.9 | -58.9 | -52.4 | -21.25 | 31.1 |
| | HT/VHT40 STBC, M0 to M7 | 2 | 4 | -59.9 | -58.9 | -52.4 | -21.25 | 31.1 |
| 5530 | Non HT80, 6 to 54 Mbps | 1 | 4 | -57.0 | | -53.0 | -21.25 | 31.8 |
| | Non HT80, 6 to 54 Mbps | 2 | 4 | -59.7 | -60.8 | -53.2 | -21.25 | 32.0 |
| | VHT80, M0 to M9 1ss | 1 | 4 | -59.3 | | -55.3 | -21.25 | 34.1 |
| | VHT80, M0 to M9 1ss | 2 | 4 | -52.0 | -58.1 | -47.0 | -21.25 | 25.8 |
| | VHT80, M0 to M9 2ss | 2 | 4 | -52.0 | -58.1 | -47.0 | -21.25 | 25.8 |
| | VHT80 Beam Forming, M0 to M9 1ss | 2 | 7 | -50.1 | -53.1 | -41.3 | -21.25 | 20.1 |
| | VHT80 Beam Forming, M0 to M9 2ss | 2 | 4 | -52.0 | -58.1 | -47.0 | -21.25 | 25.8 |
| | VHT80 STBC, M0 to M9 1ss | 2 | 4 | -52.0 | -58.1 | -47.0 | -21.25 | 25.8 |
| 5550 | Non HT40, 6 to 54 Mbps | 1 | 4 | -58.6 | | -54.6 | -21.25 | 33.4 |
| | Non HT40, 6 to 54 Mbps | 2 | 4 | -58.6 | -59.1 | -51.8 | -21.25 | 30.6 |
| | HT/VHT40, M0 to M7 | 1 | 4 | -60.4 | | -56.4 | -21.25 | 35.2 |
| | HT/VHT40, M0 to M7 | 2 | 4 | -60.4 | -57.3 | -51.6 | -21.25 | 30.3 |
| | HT/VHT40, M8 to M15 | 2 | 4 | -60.4 | -57.3 | -51.6 | -21.25 | 30.3 |
| | HT/VHT40 Beam Forming, M0 to M7 | 2 | 7 | -60.4 | -57.3 | -48.6 | -21.25 | 27.3 |
| | HT/VHT40 Beam Forming, M8 to M15 | 2 | 4 | -60.4 | -57.3 | -51.6 | -21.25 | 30.3 |
| | HT/VHT40 STBC, M0 to M7 | 2 | 4 | -60.4 | -57.3 | -51.6 | -21.25 | 30.3 |

| | | | | | | | | |
|------|--|----------|----------|--------------|--------------|--------------|---------------|-------------|
| 5560 | Non HT20, 6 to 54 Mbps | 1 | 4 | -58.2 | | -54.2 | -21.25 | 33.0 |
| | Non HT20, 6 to 54 Mbps | 2 | 4 | -58.2 | -58.7 | -51.4 | -21.25 | 30.2 |
| | Non HT20 Beam Forming, 6 to 54 Mbps | 2 | 7 | -58.2 | -58.7 | -48.4 | -21.25 | 27.2 |
| | HT/VHT20, M0 to M7 | 1 | 4 | -57.2 | | -53.2 | -21.25 | 32.0 |
| | HT/VHT20, M0 to M7 | 2 | 4 | -57.2 | -59.8 | -51.3 | -21.25 | 30.0 |
| | HT/VHT20, M8 to M15 | 2 | 4 | -57.2 | -59.8 | -51.3 | -21.25 | 30.0 |
| | HT/VHT20 Beam Forming, M0 to M7 | 2 | 7 | -57.2 | -59.8 | -48.3 | -21.25 | 27.0 |
| | HT/VHT20 Beam Forming, M8 to M15 | 2 | 4 | -57.2 | -59.8 | -51.3 | -21.25 | 30.0 |
| | HT/VHT20 STBC, M0 to M7 | 2 | 4 | -57.2 | -59.8 | -51.3 | -21.25 | 30.0 |
| 5660 | Non HT20, 6 to 54 Mbps | 1 | 4 | -57.1 | | -53.1 | -21.25 | 31.9 |
| | Non HT20, 6 to 54 Mbps | 2 | 4 | -57.1 | -48.5 | -43.9 | -21.25 | 22.7 |
| | Non HT20 Beam Forming, 6 to 54 Mbps | 2 | 7 | -57.1 | -48.5 | -40.9 | -21.25 | 19.7 |
| | HT/VHT20, M0 to M7 | 1 | 4 | -58.5 | | -54.5 | -21.25 | 33.3 |
| | HT/VHT20, M0 to M7 | 2 | 4 | -58.5 | -51.2 | -46.5 | -21.25 | 25.2 |
| | HT/VHT20, M8 to M15 | 2 | 4 | -58.5 | -51.2 | -46.5 | -21.25 | 25.2 |
| | HT/VHT20 Beam Forming, M0 to M7 | 2 | 7 | -58.5 | -51.2 | -43.5 | -21.25 | 22.2 |
| | HT/VHT20 Beam Forming, M8 to M15 | 2 | 4 | -58.5 | -51.2 | -46.5 | -21.25 | 25.2 |
| | HT/VHT20 STBC, M0 to M7 | 2 | 4 | -58.5 | -51.2 | -46.5 | -21.25 | 25.2 |
| 5670 | Non HT40, 6 to 54 Mbps | 1 | 4 | -58.7 | | -54.7 | -21.25 | 33.5 |
| | Non HT40, 6 to 54 Mbps | 2 | 4 | -58.7 | -57.5 | -51.0 | -21.25 | 29.8 |
| | HT/VHT40, M0 to M7 | 1 | 4 | -58.3 | | -54.3 | -21.25 | 33.1 |
| | HT/VHT40, M0 to M7 | 2 | 4 | -58.3 | -59.1 | -51.7 | -21.25 | 30.4 |
| | HT/VHT40, M8 to M15 | 2 | 4 | -58.3 | -59.1 | -51.7 | -21.25 | 30.4 |
| | HT/VHT40 Beam Forming, M0 to M7 | 2 | 7 | -58.3 | -59.1 | -48.7 | -21.25 | 27.4 |
| | HT/VHT40 Beam Forming, M8 to M15 | 2 | 4 | -58.3 | -59.1 | -51.7 | -21.25 | 30.4 |
| | HT/VHT40 STBC, M0 to M7 | 2 | 4 | -58.3 | -59.1 | -51.7 | -21.25 | 30.4 |
| 5690 | Non HT80, 6 to 54 Mbps | 1 | 4 | -58.9 | | -54.9 | -21.25 | 33.7 |
| | Non HT80, 6 to 54 Mbps | 2 | 4 | -58.9 | -58.2 | -51.5 | -21.25 | 30.3 |
| | VHT80, M0 to M9 1ss | 1 | 4 | -57.6 | | -53.6 | -21.25 | 32.4 |
| | VHT80, M0 to M9 1ss | 2 | 4 | -57.6 | -57.6 | -50.6 | -21.25 | 29.3 |
| | VHT80, M0 to M9 2ss | 2 | 4 | -57.6 | -57.6 | -50.6 | -21.25 | 29.3 |
| | VHT80 Beam Forming, M0 to M9 1ss | 2 | 7 | -57.6 | -57.6 | -47.6 | -21.25 | 26.3 |
| | VHT80 Beam Forming, M0 to M9 2ss | 2 | 4 | -57.6 | -57.6 | -50.6 | -21.25 | 29.3 |
| | VHT80 STBC, M0 to M9 1ss | 2 | 4 | -57.6 | -57.6 | -50.6 | -21.25 | 29.3 |
| 5700 | Non HT20, 6 to 54 Mbps | 1 | 4 | -58.1 | | -54.1 | -21.25 | 32.9 |
| | Non HT20, 6 to 54 Mbps | 2 | 4 | -58.1 | -57.9 | -51.0 | -21.25 | 29.7 |

| | | | | | | | | |
|------|-------------------------------------|---|---|-------|-------|-------|--------|------|
| | Non HT20 Beam Forming, 6 to 54 Mbps | 2 | 7 | -58.1 | -57.9 | -48.0 | -21.25 | 26.7 |
| | HT/VHT20, M0 to M7 | 1 | 4 | -58.3 | | -54.3 | -21.25 | 33.1 |
| | HT/VHT20, M0 to M7 | 2 | 4 | -58.3 | -59.6 | -51.9 | -21.25 | 30.6 |
| | HT/VHT20, M8 to M15 | 2 | 4 | -58.3 | -59.6 | -51.9 | -21.25 | 30.6 |
| | HT/VHT20 Beam Forming, M0 to M7 | 2 | 7 | -58.3 | -59.6 | -48.9 | -21.25 | 27.6 |
| | HT/VHT20 Beam Forming, M8 to M15 | 2 | 4 | -58.3 | -59.6 | -51.9 | -21.25 | 30.6 |
| | HT/VHT20 STBC, M0 to M7 | 2 | 4 | -58.3 | -59.6 | -51.9 | -21.25 | 30.6 |
| 5710 | Non HT40, 6 to 54 Mbps | 1 | 4 | -59.0 | | -55.0 | -21.25 | 33.8 |
| | Non HT40, 6 to 54 Mbps | 2 | 4 | -59.0 | -59.0 | -52.0 | -21.25 | 30.7 |
| | HT/VHT40, M0 to M7 | 1 | 4 | -57.7 | | -53.7 | -21.25 | 32.5 |
| | HT/VHT40, M0 to M7 | 2 | 4 | -57.7 | -56.6 | -50.1 | -21.25 | 28.9 |
| | HT/VHT40, M8 to M15 | 2 | 4 | -57.7 | -56.6 | -50.1 | -21.25 | 28.9 |
| | HT/VHT40 Beam Forming, M0 to M7 | 2 | 7 | -57.7 | -56.6 | -47.1 | -21.25 | 25.9 |
| | HT/VHT40 Beam Forming, M8 to M15 | 2 | 4 | -57.7 | -56.6 | -50.1 | -21.25 | 28.9 |
| | HT/VHT40 STBC, M0 to M7 | 2 | 4 | -57.7 | -56.6 | -50.1 | -21.25 | 28.9 |
| 5720 | Non HT20, 6 to 54 Mbps | 1 | 4 | -58.1 | | -54.1 | -21.25 | 32.9 |
| | Non HT20, 6 to 54 Mbps | 2 | 4 | -58.1 | -60.5 | -52.1 | -21.25 | 30.9 |
| | Non HT20 Beam Forming, 6 to 54 Mbps | 2 | 7 | -58.1 | -60.5 | -49.1 | -21.25 | 27.9 |
| | HT/VHT20, M0 to M7 | 1 | 4 | -60.2 | | -56.2 | -21.25 | 35.0 |
| | HT/VHT20, M0 to M7 | 2 | 4 | -60.2 | -58.1 | -52.0 | -21.25 | 30.8 |
| | HT/VHT20, M8 to M15 | 2 | 4 | -60.2 | -58.1 | -52.0 | -21.25 | 30.8 |
| | HT/VHT20 Beam Forming, M0 to M7 | 2 | 7 | -60.2 | -58.1 | -49.0 | -21.25 | 27.8 |
| | HT/VHT20 Beam Forming, M8 to M15 | 2 | 4 | -60.2 | -58.1 | -52.0 | -21.25 | 30.8 |
| | HT/VHT20 STBC, M0 to M7 | 2 | 4 | -60.2 | -58.1 | -52.0 | -21.25 | 30.8 |

Conducted Spurs Average Upper, All Antennas



Conducted Spurs Peak Upper, All Antennas



Conducted Spurs Average, 5500 MHz, HT/VHT20 Beam Forming, M0 to M7



Antenna A

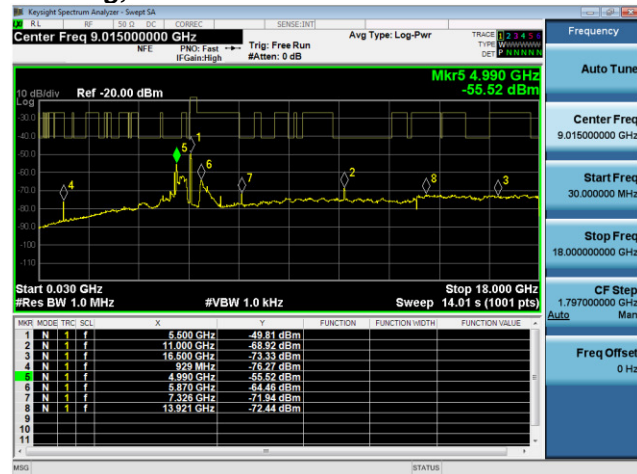

Antenna B

Conducted Spurs Peak, 5660 MHz, Non HT20 Beam Forming, 6 to 54 Mbps

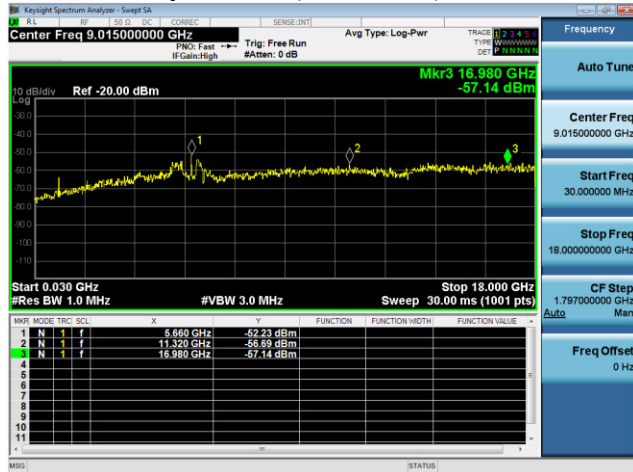

Antenna A

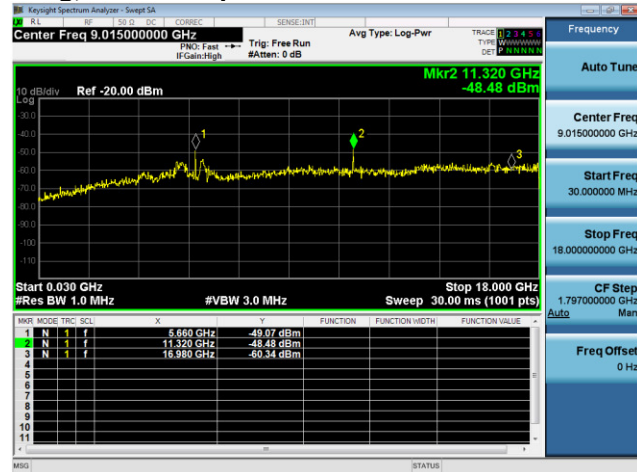

Antenna B

A.4 Conducted Bandedge

15.205 / 15.209 - Radiated emissions which fall in the restricted bands, as defined in Section 15.205(a), must also comply with the radiated emission limits specified in Section 15.209(a) (see Section 15.205(c)).

Use formula below to substitute conducted measurements in place of radiated measurements

$$E[\text{dB}\mu\text{V}/\text{m}] = \text{EIRP}[\text{dBm}] - 20 \log(d[\text{meters}]) + 104.77, \text{ where } E = \text{field strength and } d = 3 \text{ meter}$$

- 1) Average Plot, Limit= -41.25 dBm eirp
- 2) Peak plot, Limit = -21.25 dBm eirp

Test Procedure

Ref. KDB 789033 D02 General UNII Test Procedures New Rules v01r03
ANSI C63.10: 2013

| Conducted Bandedge |
|--|
| Test Procedure |
| <ol style="list-style-type: none"> 1. Connect the antenna port(s) to the spectrum analyzer input. 2. Place the radio in continuous transmit mode. Use the procedures in ANSI C63.10: 2013 to substitute conducted measurements in place of radiated measurements. 3. Configure Spectrum analyzer as per test parameters below (be sure to enter all losses between the transmitter output and the spectrum analyzer). 4. Place a marker at the end of the restricted band closest to the transmit frequency to show compliance. Also measure any emissions in the restricted bands. 5. The "measure-and-sum technique" is used for measuring in-band transmit power of a device. In the measure-and-sum approach, the conducted emission level is measured at each antenna port. The measured results at the various antenna ports are then summed mathematically to determine the total emission level from the device. Summing is performed in linear power units. The worst case output is recorded. 6. Place a marker at the end of the restricted band closest to the transmit frequency to show compliance. Also measure any emissions in the restricted bands 7. Capture graphs and record pertinent measurement data. |

Ref. ANSI C63.10: 2013 section 12.7.6 (peak) & 12.7.7.3 (average, Method VB-A (Alternative))

| Conducted Bandedge |
|---|
| Test parameters restricted Band |
| RBW = 1 MHz VBW ≥ 3 x RBW for Peak, 100Hz for Average Sweep = Auto couple Detector = Peak Trace = Max Hold. |

| System Number | Description | Samples | System under test | Support equipment |
|---------------|-------------|---------|-------------------------------------|-------------------------------------|
| 1 | EUT | S01 | <input checked="" type="checkbox"/> | <input type="checkbox"/> |
| | Support | S02 | <input type="checkbox"/> | <input checked="" type="checkbox"/> |

| | |
|------------------------------------|--|
| Tested By : Jose Aguirre | Date of testing: 01-Jun-16 - 26-Jun-16 |
| Test Result : PASS | |

See Appendix C for list of test equipment

| Frequency (MHz) | Mode | Tx Paths | Correlated Antenna Gain (dBi) | Tx 1 Bandedge Level (dBm) | Tx 2 Bandedge Level (dBm) | Total Tx Bandedge Level (dBm) | Limit (dBm) | Margin (dB) |
|----------------------------------|--|------------------------|-------------------------------|---------------------------|---------------------------|-------------------------------|---------------|-------------|
| 5500 | Non HT20, 6 to 54 Mbps | 1 | 4 | -51.0 | | -47.0 | -41.25 | 5.8 |
| | Non HT20, 6 to 54 Mbps | 2 | 4 | -51.0 | -49.3 | -43.1 | -41.25 | 1.8 |
| | Non HT20 Beam Forming, 6 to 54 Mbps | 2 | 7 | -53.8 | -52.2 | -42.9 | -41.25 | 1.7 |
| | HT/VHT20, M0 to M7 | 1 | 4 | -50.4 | | -46.4 | -41.25 | 5.2 |
| | HT/VHT20, M0 to M7 | 2 | 4 | -50.4 | -48.5 | -42.3 | -41.25 | 1.1 |
| | HT/VHT20, M8 to M15 | 2 | 4 | -50.4 | -48.5 | -42.3 | -41.25 | 1.1 |
| | HT/VHT20 Beam Forming, M0 to M7 | 2 | 7 | -52.6 | -50.9 | -41.7 | -41.25 | 0.4 |
| | HT/VHT20 Beam Forming, M8 to M15 | 2 | 4 | -50.4 | -48.5 | -42.3 | -41.25 | 1.1 |
| | HT/VHT20 STBC, M0 to M7 | 2 | 4 | -50.4 | -48.5 | -42.3 | -41.25 | 1.1 |
| 5510 | Non HT40, 6 to 54 Mbps | 1 | 4 | -47.6 | | -43.6 | -41.25 | 2.4 |
| | Non HT40, 6 to 54 Mbps | 2 | 4 | -52.8 | -49.4 | -43.8 | -41.25 | 2.5 |
| | HT/VHT40, M0 to M7 | 1 | 4 | -47.2 | | -43.2 | -41.25 | 2.0 |
| | HT/VHT40, M0 to M7 | 2 | 4 | -52.4 | -48.4 | -42.9 | -41.25 | 1.7 |
| | HT/VHT40, M8 to M15 | 2 | 4 | -52.4 | -48.4 | -42.9 | -41.25 | 1.7 |
| | HT/VHT40 Beam Forming, M0 to M7 | 2 | 7 | -57.3 | -53.6 | -45.1 | -41.25 | 3.8 |
| | HT/VHT40 Beam Forming, M8 to M15 | 2 | 4 | -52.4 | -48.4 | -42.9 | -41.25 | 1.7 |
| | HT/VHT40 STBC, M0 to M7 | 2 | 4 | -52.4 | -48.4 | -42.9 | -41.25 | 1.7 |
| | 5530 | Non HT80, 6 to 54 Mbps | 1 | 4 | -47.6 | | -43.6 | -41.25 |
| Non HT80, 6 to 54 Mbps | | 2 | 4 | -50.9 | -53.9 | -45.1 | -41.25 | 3.9 |
| VHT80, M0 to M9 1ss | | 1 | 4 | -46.2 | | -42.2 | -41.25 | 1.0 |
| VHT80, M0 to M9 1ss | | 2 | 4 | -50.7 | -48.6 | -42.5 | -41.25 | 1.3 |
| VHT80, M0 to M9 2ss | | 2 | 4 | -50.7 | -48.6 | -42.5 | -41.25 | 1.3 |
| VHT80 Beam Forming, M0 to M9 1ss | | 2 | 7 | -53.3 | -52.2 | -42.7 | -41.25 | 1.5 |
| VHT80 Beam Forming, M0 to M9 2ss | | 2 | 4 | -50.7 | -48.6 | -42.5 | -41.25 | 1.3 |
| VHT80 STBC, M0 to M9 1ss | | 2 | 4 | -50.7 | -48.6 | -42.5 | -41.25 | 1.3 |

| Frequency (MHz) | Mode | Tx Paths | Correlated Antenna Gain (dBi) | Tx 1 Bandedge Level (dBm) | Tx 2 Bandedge Level (dBm) | Total Tx Bandedge Level (dBm) | Limit (dBm) | Margin (dB) |
|----------------------------------|-------------------------------------|------------------------|-------------------------------|---------------------------|---------------------------|-------------------------------|---------------|-------------|
| 5500 | Non HT20, 6 to 54 Mbps | 1 | 4 | -34.9 | | -30.9 | -21.25 | 9.7 |
| | Non HT20, 6 to 54 Mbps | 2 | 4 | -34.9 | -33.1 | -26.9 | -21.25 | 5.6 |
| | Non HT20 Beam Forming, 6 to 54 Mbps | 2 | 7 | -34.9 | -34.3 | -24.6 | -21.25 | 3.3 |
| | HT/VHT20, M0 to M7 | 1 | 4 | -32.4 | | -28.4 | -21.25 | 7.2 |
| | HT/VHT20, M0 to M7 | 2 | 4 | -32.4 | -32.6 | -25.5 | -21.25 | 4.2 |
| | HT/VHT20, M8 to M15 | 2 | 4 | -32.4 | -32.6 | -25.5 | -21.25 | 4.2 |
| | HT/VHT20 Beam Forming, M0 to M7 | 2 | 7 | -35.1 | -33.3 | -24.1 | -21.25 | 2.8 |
| | HT/VHT20 Beam Forming, M8 to M15 | 2 | 4 | -32.4 | -32.6 | -25.5 | -21.25 | 4.2 |
| | HT/VHT20 STBC, M0 to M7 | 2 | 4 | -32.4 | -32.6 | -25.5 | -21.25 | 4.2 |
| 5510 | Non HT40, 6 to 54 Mbps | 1 | 4 | -33.6 | | -29.6 | -21.25 | 8.4 |
| | Non HT40, 6 to 54 Mbps | 2 | 4 | -38.5 | -35.4 | -29.7 | -21.25 | 8.4 |
| | HT/VHT40, M0 to M7 | 1 | 4 | -30.0 | | -26.0 | -21.25 | 4.8 |
| | HT/VHT40, M0 to M7 | 2 | 4 | -34.7 | -31.3 | -25.7 | -21.25 | 4.4 |
| | HT/VHT40, M8 to M15 | 2 | 4 | -34.7 | -31.3 | -25.7 | -21.25 | 4.4 |
| | HT/VHT40 Beam Forming, M0 to M7 | 2 | 7 | -40.0 | -35.5 | -27.2 | -21.25 | 5.9 |
| | HT/VHT40 Beam Forming, M8 to M15 | 2 | 4 | -34.7 | -31.3 | -25.7 | -21.25 | 4.4 |
| | HT/VHT40 STBC, M0 to M7 | 2 | 4 | -34.7 | -31.3 | -25.7 | -21.25 | 4.4 |
| | 5530 | Non HT80, 6 to 54 Mbps | 1 | 4 | -27.7 | | -23.7 | -21.25 |
| Non HT80, 6 to 54 Mbps | | 2 | 4 | -35.0 | -34.0 | -27.5 | -21.25 | 6.2 |
| VHT80, M0 to M9 1ss | | 1 | 4 | -27.6 | | -23.6 | -21.25 | 2.4 |
| VHT80, M0 to M9 1ss | | 2 | 4 | -32.9 | -30.2 | -24.3 | -21.25 | 3.1 |
| VHT80, M0 to M9 2ss | | 2 | 4 | -32.9 | -30.2 | -24.3 | -21.25 | 3.1 |
| VHT80 Beam Forming, M0 to M9 1ss | | 2 | 7 | -36.8 | -35.2 | -25.9 | -21.25 | 4.7 |
| VHT80 Beam Forming, M0 to M9 2ss | | 2 | 4 | -32.9 | -30.2 | -24.3 | -21.25 | 3.1 |
| VHT80 STBC, M0 to M9 1ss | | 2 | 4 | -32.9 | -30.2 | -24.3 | -21.25 | 3.1 |

Conducted Bandedge Average, 5500 MHz, HT/VHT20 Beam Forming, M0 to M7

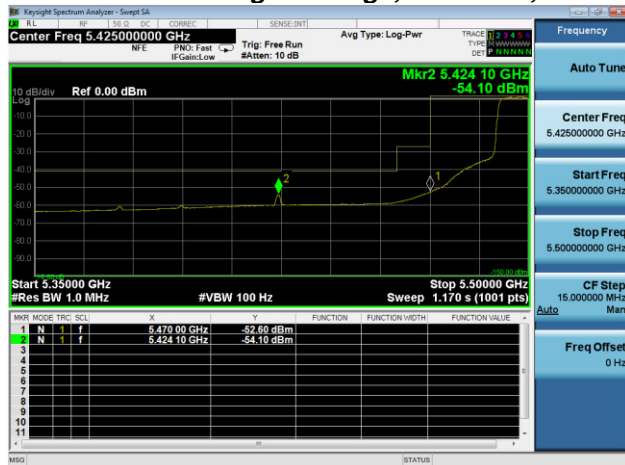

Antenna A

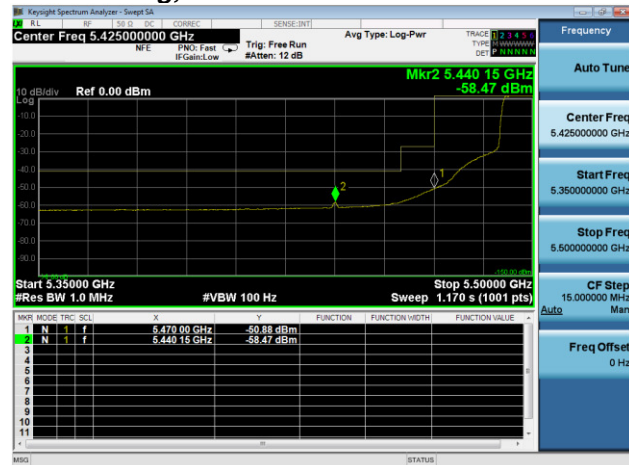

Antenna B

Conducted Bandedge Peak, 5530 MHz, VHT80, M0 to M9 1ss



Antenna A

Appendix B: Emission Test Results

Testing Laboratory: Cisco Systems, Inc., 125 West Tasman Drive, San Jose, CA 95134, USA

Radiated Emission Setup Diagram-Below 1G

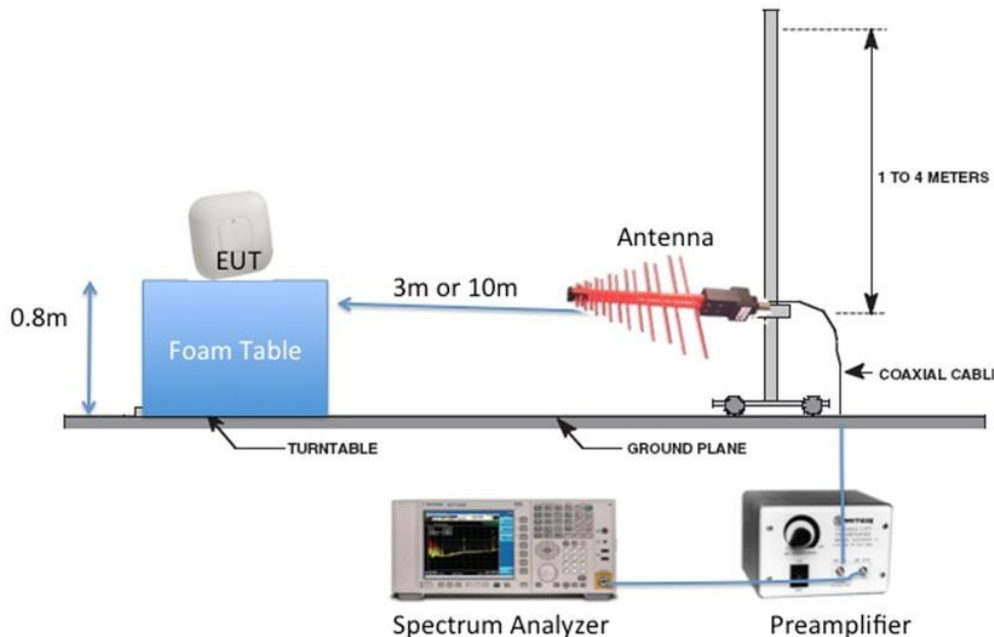

Radiated Emission Setup Diagram-Above 1G

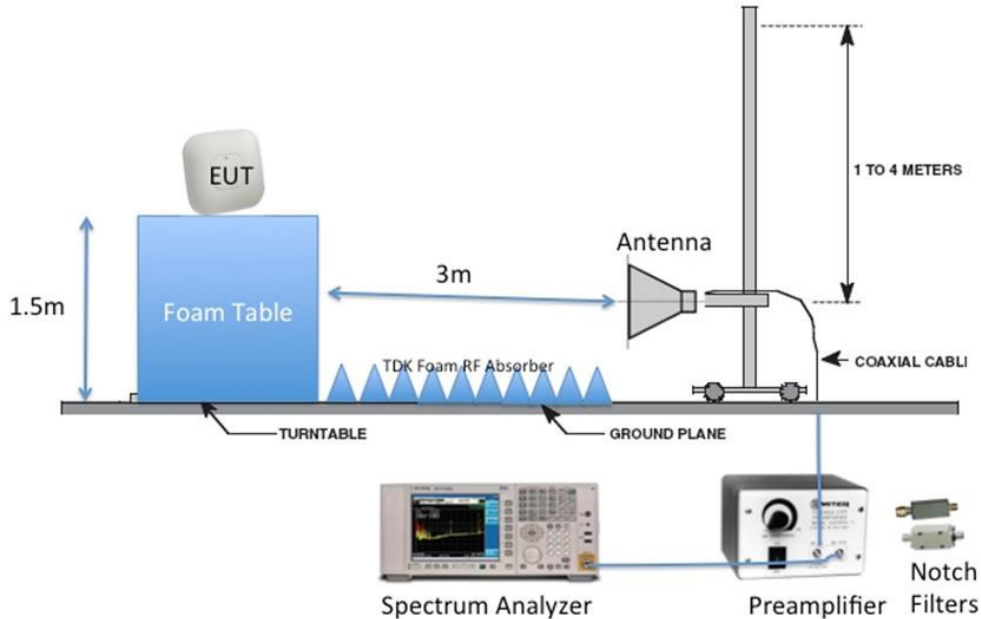



B.1 Radiated Spurious Emissions

15.407 (b) *Undesirable emission limits.* Except as shown in paragraph (b) (7) of this section, the maximum emissions outside of the frequency bands of operation shall be attenuated in accordance with the following limits:

(3) For transmitters operating in the 5.47-5.725 GHz band: All emissions outside of the 5.47-5.725 GHz band shall not exceed an e.i.r.p. of -27 dBm/MHz.

15.205 / 15.209

(7) The provisions of 15.205 apply to intentional radiators operating under this section.

(6) Unwanted emissions below 1 GHz must comply with the general field strength limits set forth in 15.209.

Ref. ANSI C63.10: 2013 section 12.7.6 (peak) & 12.7.7.3 (average)

Using Vasona, configure the spectrum analyzer as shown below (be sure to enter all losses between the transmitter output and the spectrum analyzer). Place the radio in continuous transmit mode.

Span: 1GHz – 18 GHz/18GHz-26G/26GHz-40GHz
 Reference Level: 80 dBuV
 Attenuation: 10 dB
 Sweep Time: Coupled
 Resolution Bandwidth: 1MHz
 Video Bandwidth: 3 MHz for peak, 1 KHz for average
 Detector: Peak

Terminate the access Point RF ports with 50 ohm loads.

Maximize Turntable (find worst case table angle), Maximize Antenna (find worst case height)

Save 2 plots: 1) Average plot (Vertical and Horizontal), Limit= 54dBuV/m @3m
 2) Peak plot (Vertical and Horizontal), Limit = 74dBuV/m @3m

Place a marker at the end of the restricted band closest to the transmit frequency to show compliance. Also measure any emissions in the restricted bands.

This report represents the worst case data for all supported operating modes and antennas. There are no measurable emissions above 18 GHz.

| System Number | Description | Samples | System under test | Support equipment |
|---------------|-------------|---------|-------------------------------------|-------------------------------------|
| 1 | EUT | S01 | <input checked="" type="checkbox"/> | <input type="checkbox"/> |
| | Support | S02 | <input type="checkbox"/> | <input checked="" type="checkbox"/> |

| | |
|------------------------------------|--|
| Tested By : Jose Aguirre | Date of testing: 01-Jun-16 - 26-Jun-16 |
| Test Result : PASS | |

See Appendix C for list of test equipment

B.1.A Transmitter Radiated Spurious Emissions-Average Worst Case

| Frequency (MHz) | Mode | Data Rate (Mbps) | Spurious Emission Level (dBuV/m) | Limit (dBuV/m) | Margin (MHz) |
|-----------------|---------------------|------------------|----------------------------------|----------------|--------------|
| 5500 | HT/VHT20, M0 to M23 | M0 | 51.7 | 54 | 2.3 |
| 5510 | HT/VHT40, M0 to M23 | M0 | 51.8 | 54 | 2.2 |
| 5530 | VHT80, M0.1 to M9.3 | M0x1 | 51.3 | 54 | 2.7 |
| 5560 | HT/VHT20, M0 to M23 | M0 | 51.6 | 54 | 2.4 |
| 5670 | HT/VHT20, M0 to M23 | M0 | 51.3 | 54 | 2.7 |
| 5690 | VHT80, M0.1 to M9.3 | M0x1 | 51.9 | 54 | 2.1 |
| 5710 | HT/VHT20, M0 to M23 | M0 | 51.5 | 54 | 2.5 |
| 5720 | HT/VHT20, M0 to M23 | M0 | 51.7 | 54 | 2.3 |

B.1.P.1 Radiated Transmitter Spurs, 5500 MHz, HT/VHT20, M0 to M23, Average (1-18GHz)



B.1.P.2 Radiated Transmitter Spurs, 5510 MHz, HT/VHT40, M0 to M23, Average (1-18GHz)



B.1.P.3 Radiated Transmitter Spurs, 5530 MHz, VHT80, M0.1 to M9.3, Average (1-18GHz)



B.1.P.4 Radiated Transmitter Spurs, 5560 MHz, HT/VHT20, M0 to M23, Average (1-18GHz)



B.1.P.6 Radiated Transmitter Spurs, 5670 MHz, HT/VHT40, M0 to M23, M0.0 to M9.4, Average (1-18GHz)



B.1.P.7 Radiated Transmitter Spurs, 5690 MHz, VHT80, M0.1 to M9.3, Average (1-18GHz)



B.1.P.8 Radiated Transmitter Spurs, 5710 MHz, HT/VHT40, M0 to M23, Average (1-18GHz)



B.1.P.9 Radiated Transmitter Spurs, 5720 MHz, HT/VHT20, M0 to M23, Average (1-18GHz)



B.1.P.10 Radiated Transmitter Spurs, All rate, All modes, Average (18-26.5GHz) Horizontal & Vertical



B.1.P.11 Radiated Transmitter Spurs, All rate, All modes, Average (26.5-40GHz) Horizontal & Vertical



B.1.P Transmitter Radiated Spurious Emissions-Peak worst case

| Frequency (MHz) | Mode | Data Rate (Mbps) | Spurious Emission Level (dBuV/m) | Limit (dBuV/m) | Margin (MHz) |
|-----------------|---------------------|------------------|----------------------------------|----------------|--------------|
| 5500 | HT/VHT20, M0 to M23 | M0 | 63 | 74 | 11 |
| 5510 | HT/VHT40, M0 to M23 | M0 | 63.4 | 74 | 10.6 |
| 5530 | VHT80, M0.1 to M9.3 | M0x1 | 64.5 | 74 | 9.5 |
| 5560 | HT/VHT20, M0 to M23 | M0 | 64.1 | 74 | 9.9 |
| 5670 | HT/VHT20, M0 to M23 | M0 | 64 | 74 | 10 |
| 5690 | VHT80, M0.1 to M9.3 | M0x1 | 63.7 | 74 | 10.3 |
| 5710 | HT/VHT20, M0 to M23 | M0 | 63.1 | 74 | 10.9 |
| 5720 | HT/VHT20, M0 to M23 | M0 | 63.6 | 74 | 10.4 |

B.1.P.1 Radiated Transmitter Spurs, 5500 MHz, HT/VHT20, M0 to M23, Peak (1-18GHz)

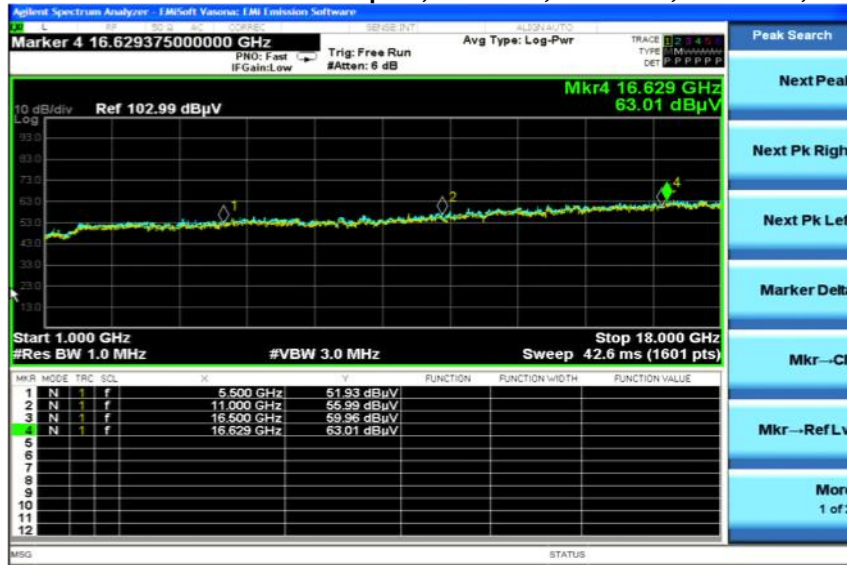

B.1.P.2 Radiated Transmitter Spurs, 5510 MHz, HT/VHT40, M0 to M23, Peak (1-18GHz)



B.1.P.3 Radiated Transmitter Spurs, 5530 MHz, VHT80, M0.1 to M9.3, Peak (1-18GHz)

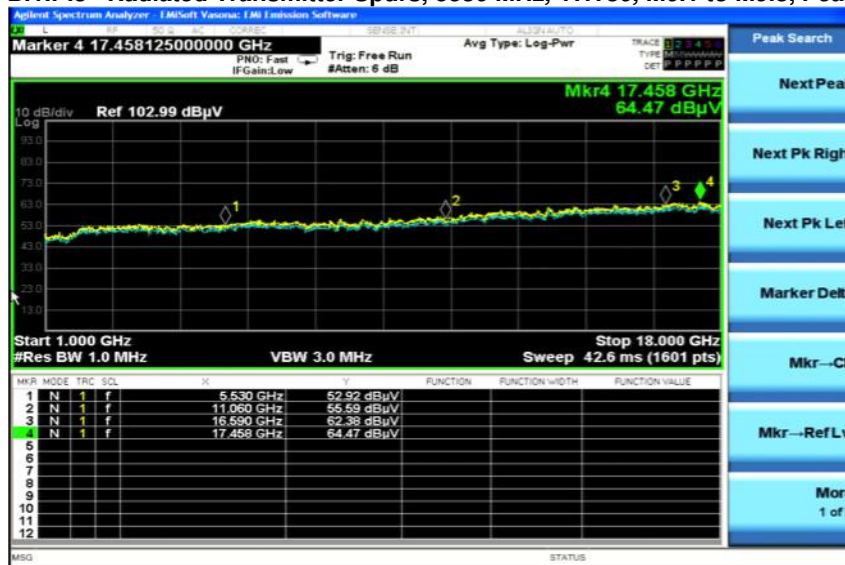

B.1.P.4 Radiated Transmitter Spurs, 5560 MHz, HT/VHT20, M0 to M23, Peak (1-18GHz)



B.1.P.6 Radiated Transmitter Spurs, 5670 MHz, HT/VHT40, M0 to M23, M0.0 to M9.4, Peak (1-18GHz)

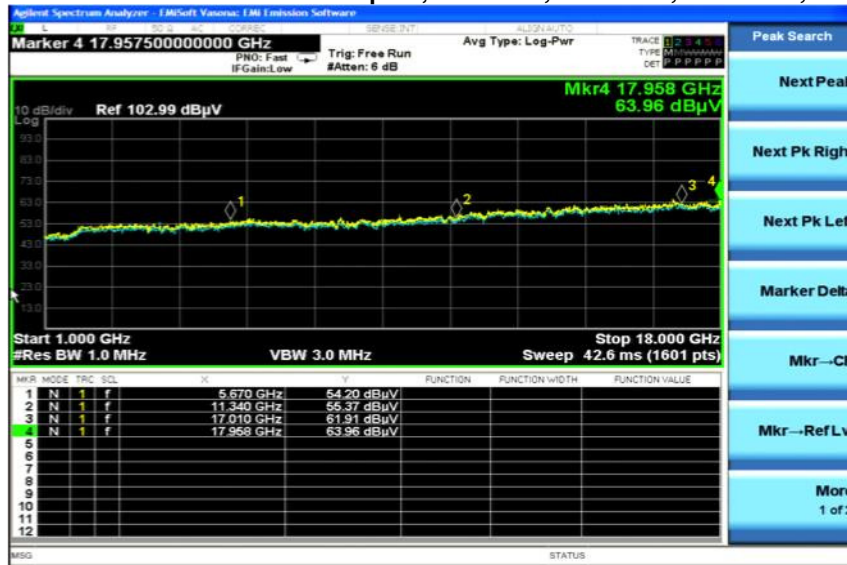

B.1.P.7 Radiated Transmitter Spurs, 5690 MHz, VHT80, M0.1 to M9.3, Peak (1-18GHz)



B.1.P.8 Radiated Transmitter Spurs, 5710 MHz, HT/VHT40, M0 to M23, Peak (1-18GHz)



B.1.P.9 Radiated Transmitter Spurs, 5720 MHz, HT/VHT20, M0 to M23, Peak (1-18GHz)



B.1.P.10 Radiated Transmitter Spurs, All rate, All modes, Peak (18-26.5GHz) Horizontal & Vertical

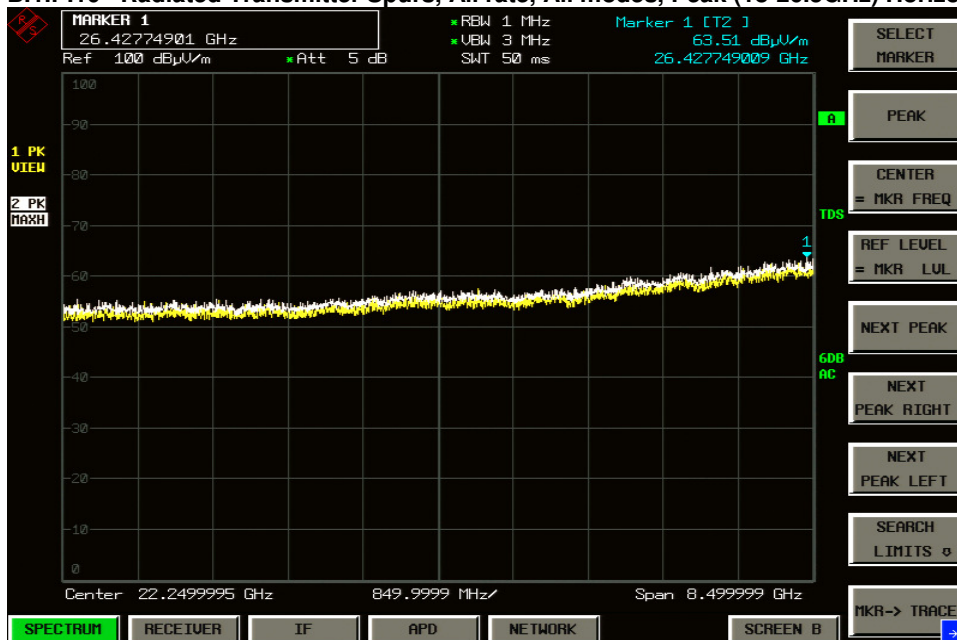

B.1.P.11 Radiated Transmitter Spurs, All rate, All modes, Peak (26.5-40GHz) Horizontal & Vertical



B.2 Radiated Emissions 30MHz to 1GHz

FCC 15.205 / 15.209

(7) The provisions of 15.205 apply to intentional radiators operating under this section.

(6) Unwanted emissions below 1 GHz must comply with the general field strength limits set forth in 15.209.

Ref. ANSI C63.10: 2013 section 6.5

Using Vasona, configure the spectrum analyzer as shown below (be sure to enter all losses between the transmitter output and the spectrum analyzer). Place the radio in continuous transmit mode.

| | |
|-----------------------|-------------------------------|
| Span: | 30MHz – 1GHz |
| Reference Level: | 80 dBuV |
| Attenuation: | 10 dB |
| Sweep Time: | Coupled |
| Resolution Bandwidth: | 100kHz |
| Video Bandwidth: | 300kHz |
| Detector: | Peak for Pre-scan, Quasi-Peak |

Compliance shall be determined using CISPR quasi-peak detection; however, peak detection is permitted as an alternative to quasi-peak detection.

Terminate the access Point RF ports with 50 ohm loads.

Maximize Turntable (find worst case table angle), Maximize Antenna (find worst case height)

This report represents the worst case data for all supported operating modes and antennas.

| System Number | Description | Samples | System under test | Support equipment |
|---------------|-------------|---------|-------------------------------------|-------------------------------------|
| 1 | EUT | S01 | <input checked="" type="checkbox"/> | <input type="checkbox"/> |
| | Support | S02 | <input type="checkbox"/> | <input checked="" type="checkbox"/> |

| | |
|------------------------------------|--|
| Tested By : Jose Aguirre | Date of testing: 01-Jun-16 - 26-Jun-16 |
| Test Result : PASS | |

See Appendix C for list of test equipment

Graphical Test Results

Note that the data displayed on the plots detailed in this appendix were measured using a 'Peak Detector'. Please refer to the results table for the detectors used during formal measurements

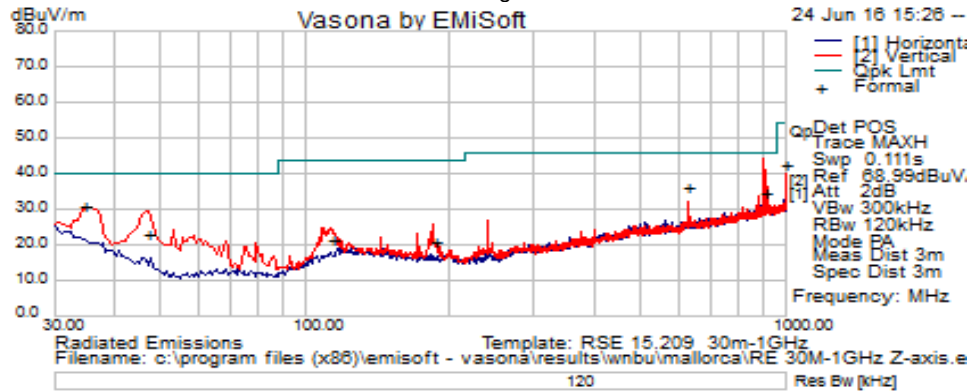

Test Results Table

| Frequency MHz | Raw dBuV | Cable Loss | AF dB | Level dBuV/m | Measurement Type | P ol | Hgt cm | Azt Deg | Limit dBuV/m | Margin dB | Pass /Fail |
|---------------|----------|------------|-------|--------------|------------------|------|--------|---------|--------------|-----------|------------|
| 903.813 | 9.34 | 2.5 | 22.55 | 34.39 | Quasi Max | V | 183 | 210 | 46 | -11.61 | Pass |
| 34.556 | 12.48 | 0.45 | 17.9 | 30.82 | Quasi Max | V | 103 | 114 | 40 | -9.18 | Pass |
| 46.975 | 13.4 | 0.52 | 9.24 | 23.17 | Quasi Max | V | 123 | 266 | 40 | -16.83 | Pass |
| 1000 | 16.48 | 2.63 | 23.4 | 42.51 | Quasi Max | V | 118 | 55 | 54 | -11.49 | Pass |
| 625 | 14.71 | 2.06 | 19.5 | 36.27 | Quasi Max | V | 104 | 62 | 46 | -9.73 | Pass |
| 184.766 | 8.66 | 1.12 | 11.2 | 20.98 | Quasi Max | V | 198 | 72 | 43.5 | -22.52 | Pass |
| 113.056 | 7.25 | 0.87 | 13.09 | 21.21 | Quasi Max | V | 157 | 329 | 43.5 | -22.29 | Pass |

B.3 AC Conducted Emissions

FCC 15.207 Except when the requirements applicable to a given device state otherwise, for any radio apparatus equipped to operate from the public utility AC power supply, either directly or indirectly (such as with a battery charger), the radio frequency voltage of emissions conducted back onto the AC power lines in the frequency range of 0.15 MHz to 30 MHz shall not exceed the limits shown in the table in these sections. The more stringent limit applies at the frequency range boundaries.

Measurement Procedure

Accordance with ANSI C63.10:2013 section 6.2

Using Vasona, configure the spectrum analyzer as shown below (be sure to enter all losses between the transmitter output and the spectrum analyzer). Place the radio in continuous transmit mode.

| | |
|-----------------------|----------------------|
| Span: | 150 KHz – 30 MHz |
| Attenuation: | 10 dB |
| Sweep Time: | Coupled |
| Resolution Bandwidth: | 9 KHz |
| Video Bandwidth: | 30 KHz |
| Detector: | Quasi-Peak / Average |

| System Number | Description | Samples | System under test | Support equipment |
|---------------|-------------|---------|-------------------------------------|-------------------------------------|
| 1 | EUT | S01 | <input checked="" type="checkbox"/> | <input type="checkbox"/> |
| | Support | S02 | <input type="checkbox"/> | <input checked="" type="checkbox"/> |

| | |
|--|-------------------------|
| Tested By : Jose Aguirre | Date of testing: |
| Test Result : Not tested , POE powered only | |

See Appendix C for list of test equipment

Test Setup Photo for Conducted Measurements



This is a dual band 2.4GHz / 5GHz device. All ports in this test set up photo are connected as all testing is automated. Section 2.6 of this test report given an overview of the different Tx antenna combinations used by this device.

Test Setup for Radiated Measurements

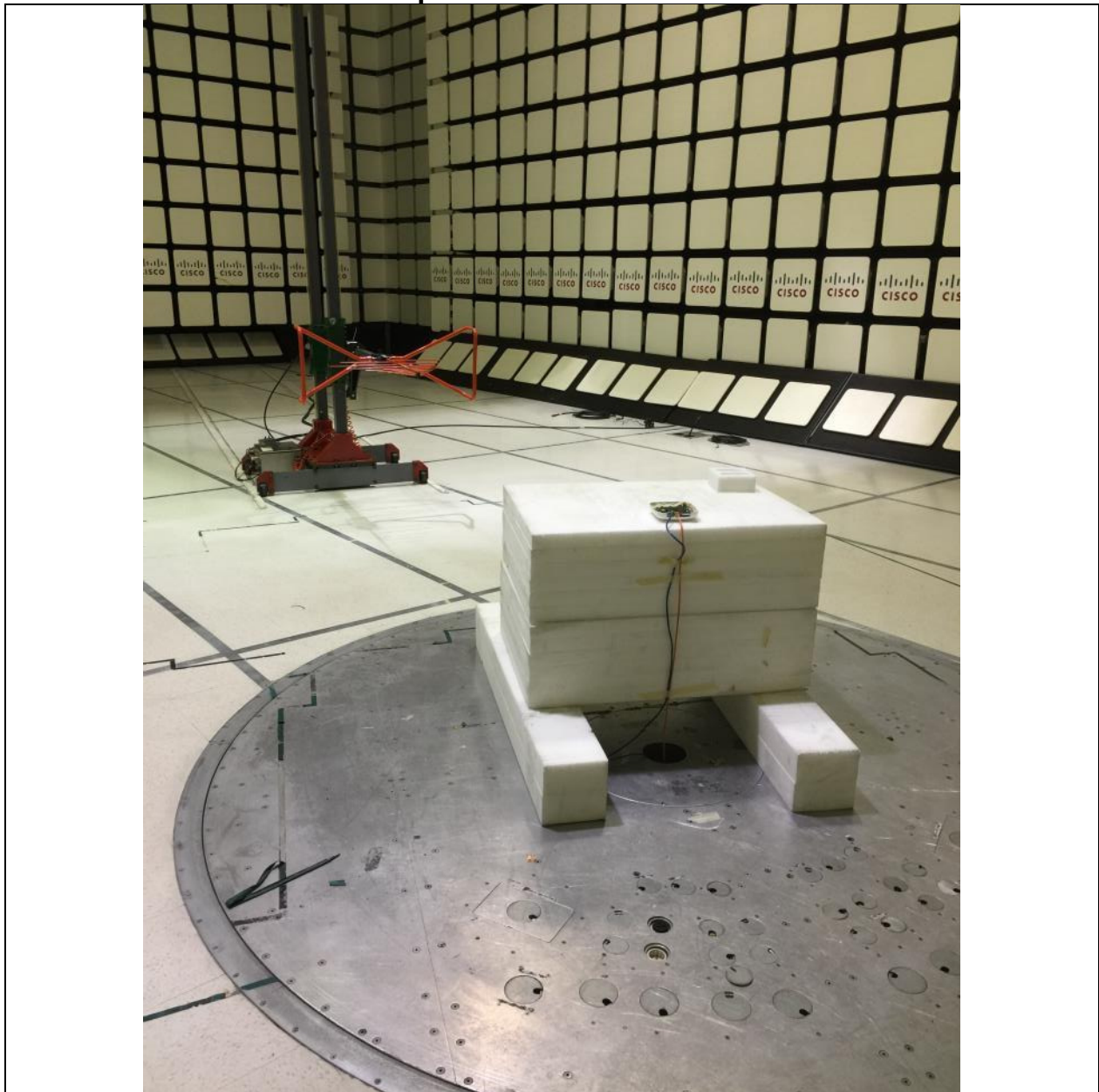

Title: Radiated Emissions Configuration Photograph

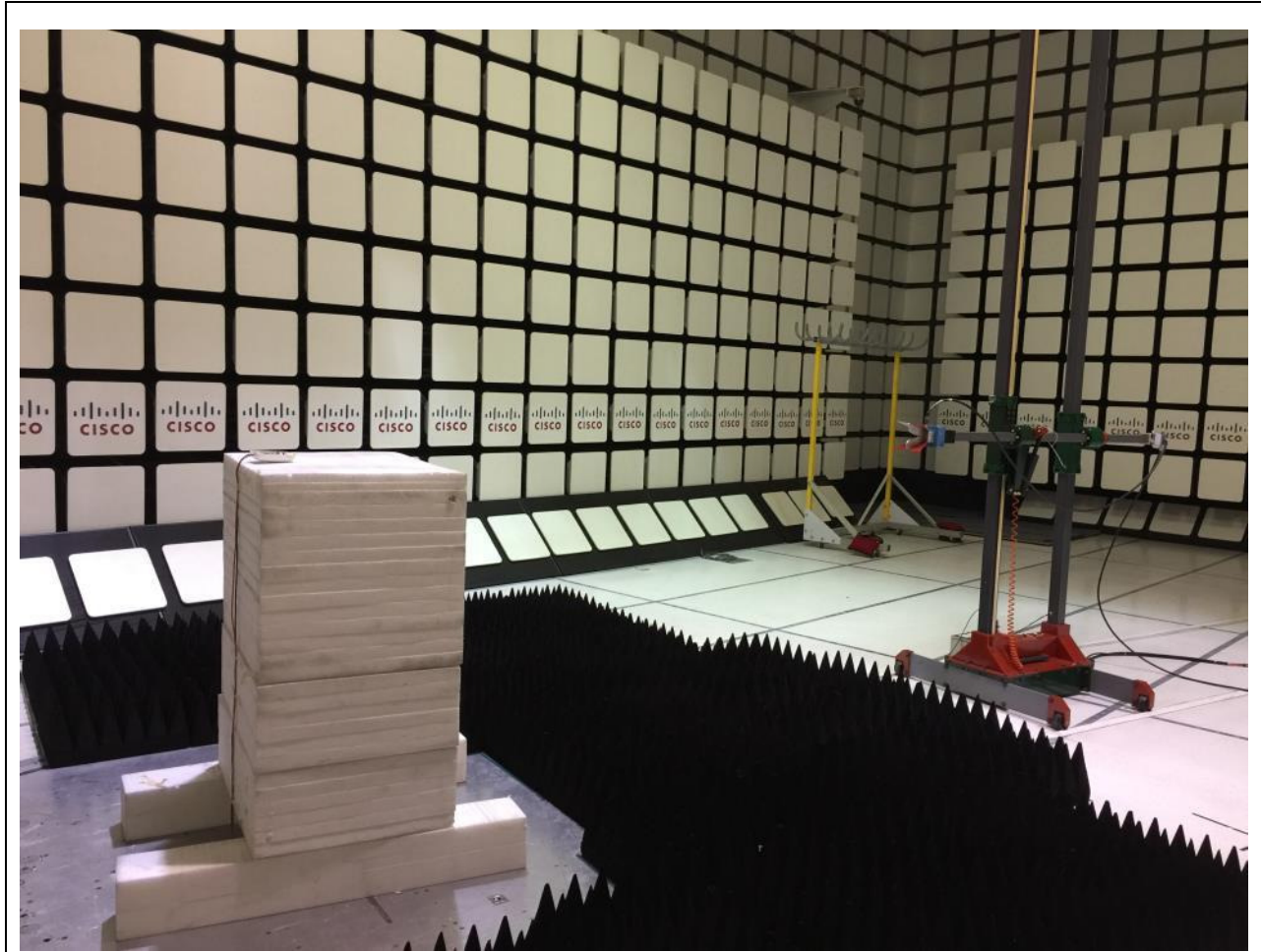

Title: Radiated Emissions Configuration Photograph

Test Setup for AC Conducted Emissions

Not tested, the Radio is power over Ethernet (POE) only .

Appendix C: List of Test Equipment Used to perform the test

| Equip No | Model Manufacturer | Description | Last Cal | Next Cal | Tet Item |
|-----------|-------------------------------------|---|------------------|---------------------|---------------|
| CIS051796 | TTA1800-30-HG Miteq | SMA 18 GHz Pre-Amplifier | 29-Sep-15 | 29-Sep-16 | B.1, B.2 |
| CIS035285 | 3117 ETS-Lindgren | Double Ridged Waveguide Horn Antenna | 30-Sep-15 | 30-Sep-16 | B.1, B.2 |
| CIS008447 | NSA 10m Chamber Cisco | NSA 10m Chamber | 14-Oct-15 | 14-Oct-16 | B.3 |
| CIS045096 | TH0118 Cisco | Mast Mount Preamplifier Array, 1-18GHz | 4-Nov-15 | 4-Nov-16 | B.1, B.2 |
| CIS030652 | JB1 Sunol Sciences | Combination Antenna, 30MHz-2GHz | 4-Dec-15 | 4-Dec-16 | B.3 |
| CIS041929 | iBTHP-5-DB9 Newport | 5 inch Temp/RH/Press Sensor w/20ft cable | 22-Dec-15 | 22-Dec-16 | B.1, B.2, B.3 |
| CIS043124 | Above 1GHz Site Cal Cisco | Above 1GHz Cisp Site Verification | 14-Jan-16 | 14-Jan-17 | B.1, B.2 |
| CIS047300 | N9038A Agilent Technologies | MXE EMI Receiver 20Hz to 26.5 Ghz | 28-Jan-16 | 28-Jan-17 | B.1, B.2, B.3 |
| CIS051642 | Sucoflex 106PA Huber+Suhner | RF N Type Cable 8.5m | 11-Feb-16 | 11-Feb-17 | B.1, B.2, B.3 |
| CIS030559 | UFB311A-1-0950-504504 Micro-Coax | RF Coaxial Cable, to 18GHz, 95 in | 15-Feb-16 | 15-Feb-17 | B.1, B.2, B.3 |
| CIS020975 | UFB311A-0-1344-520520 Micro-Coax | RF Coaxial Cable, to 18GHz, 134.4 in | 17-Feb-16 | 17-Feb-17 | B.1, B.2, B.3 |
| CIS051708 | UFB293C-2-0840-300504 Micro-Coax | RF Coaxial SMA-N Type Cable | 28-Jun-16 | 28-Jun-17 | B.1, B.2, B.3 |
| CIS044940 | ESU40 Rohde & Schwarz | EMI Test Receiver, 20Hz-40GHz | 2-Nov-15 | 2-Nov-16 | B.1, B.2 |
| CIS034075 | RSG 2000 Schaffner | Reference Spectrum Generator, 1-18GHz | Cal Not Required | Cal Not Required | B.1, B.2 |
| CIS041979 | 1840 Cisco | 18-40GHz EMI Test Head/ Verification Fixture | 13-Jul-15 | 13-Jul-16 | B.1, B.2 |
| CIS044940 | ESU40 Rohde & Schwarz | EMI Test Receiver, 20Hz-40GHz | 2-Nov-15 | 2-Nov-16 | B.1, B.2, |
| CIS030652 | JB1 Sunol Sciences | Combination Antenna, 30MHz-2GHz | 4-Dec-15 | 4-Dec-16 | B.3 |
| CIS003003 | 83731B HP | Synthesized Signal Generator | 29-Jan-16 | 29-Jan-17 | B.1, B.2 |
| CIS037236 | 50CB-015 JFW | GPIB Control Box | | | B.1, B.2 |

| Test Equipment used for AC Mains Conducted Emissions | | | | | |
|--|-----------------------|-------------|----------|----------|-----------|
| Equip No | Model Manufacturer | Description | Last Cal | Next Cal | Test Item |
| | | | | | B.4 |

| Test Equipment used for RF Conducted Tests | | | | | |
|--|-------------------------------------|--|-----------|-----------|------------|
| Equip No | Model Manufacturer | Description | Last Cal | Next Cal | Test Item |
| CIS054666 | RA08-S1S1-18 MegaPhase | SMA 18" Cable | 25-Sep-15 | 25-Sep-16 | A1 thru A7 |
| CIS054667 | RA08-S1S1-18 MegaPhase | SMA 18" Cable | 25-Sep-15 | 25-Sep-16 | A1 thru A7 |
| CIS054668 | RA08-S1S1-18 MegaPhase | SMA 18" Cable | 25-Sep-15 | 25-Sep-16 | A1 thru A7 |
| CIS054669 | RA08-S1S1-18 MegaPhase | SMA 18" Cable | 25-Sep-15 | 25-Sep-16 | A1 thru A7 |
| CIS054686 | NI PXI-2796 National Instruments | Plug-in switch module | 6-Oct-15 | 6-Oct-16 | A1 thru A7 |
| CIS055166 | RFLT4WDC40GK RF Lambda | 4 Way Power Divider 40GHz | 23-Nov-15 | 23-Nov-16 | A1 thru A7 |
| CIS054662 | SF18-S1S1-36 MegaPhase | SMA 36" cable | 24-Sep-15 | 24-Sep-16 | A1 thru A7 |
| CIS054656 | BRC50705-02 Micro-Tronics | Band Reject Filter | 24-Sep-15 | 24-Sep-16 | A1 thru A7 |
| CIS054655 | BRC50704-02 Micro-Tronics | Notch Filter, SB:5.470-5.725GHz, to 12GHz | 24-Sep-15 | 24-Sep-16 | A1 thru A7 |
| CIS054654 | BRC50703-02 Micro-Tronics | Notch Filter, SB:5.150-5.350GHz, to 11GHz | 24-Sep-15 | 24-Sep-16 | A1 thru A7 |
| CIS054653 | BRM50702-02 Micro-Tronics | Notch Filter, SB:2.400-2.500GHz, to 18GHz | 24-Sep-15 | 24-Sep-16 | A1 thru A7 |
| CIS054678 | RA08-S1S1-12 MegaPhase | SMA 12" Cable | 25-Sep-15 | 25-Sep-16 | A1 thru A7 |
| CIS054677 | RA08-S1S1-12 MegaPhase | SMA 12" Cable | 25-Sep-15 | 25-Sep-16 | A1 thru A7 |
| CIS054676 | RA08-S1S1-12 MegaPhase | SMA 12" Cable | 25-Sep-15 | 25-Sep-16 | A1 thru A7 |
| CIS054675 | RA08-S1S1-12 MegaPhase | SMA 12" Cable | 25-Sep-15 | 25-Sep-16 | A1 thru A7 |
| CIS054674 | RA08-S1S1-12 MegaPhase | SMA 12" Cable | 25-Sep-15 | 25-Sep-16 | A1 thru A7 |
| CIS054673 | RA08-S1S1-12 MegaPhase | SMA 12" Cable | 25-Sep-15 | 25-Sep-16 | A1 thru A7 |
| CIS054672 | RA08-S1S1-12 MegaPhase | SMA 12" Cable | 25-Sep-15 | 25-Sep-16 | A1 thru A7 |
| CIS054671 | RA08-S1S1-12 MegaPhase | SMA 12" Cable | 25-Sep-15 | 25-Sep-16 | A1 thru A7 |
| CIS054670 | RA08-S1S1-12 MegaPhase | SMA 12" Cable | 25-Sep-15 | 25-Sep-16 | A1 thru A7 |
| CIS054664 | GC12-8181-16 MegaPhase | SMA 16" Cable | 25-Sep-15 | 25-Sep-16 | A1 thru A7 |
| CIS054663 | F120-S1S1-48 MegaPhase | SMA 48" Cable | 25-Sep-15 | 25-Sep-16 | A1 thru A7 |

| | | | | | |
|-----------|-------------------------------------|---|------------------|-----------|------------|
| CIS054686 | NI PXI-2796 National Instruments | Plug-in switch module | 6-Oct-15 | 6-Oct-16 | A1 thru A7 |
| CIS042005 | BWS30W2+ Mini-Circuits | SMA 30dB Attenuator | 16-Oct-15 | 16-Oct-16 | A1 thru A7 |
| CIS041995 | BW-S6W2 Mini-Circuits | 6dB Attenuator | 16-Oct-15 | 16-Oct-16 | A1 thru A7 |
| CIS054695 | D3C2060 Ditom | Circulator | 20-Oct-15 | 20-Oct-16 | A1 thru A7 |
| CIS055146 | RA08-S1S1-12 Megaphase | 12" SMA Cable | 17-Nov-15 | 17-Nov-16 | A1 thru A7 |
| CIS050721 | N9030A Keysight | PXA Signal Analyzer | 30-Mar-16 | 30-Mar-17 | A1 thru A7 |
| CIS054303 | N5182B Keysight | MXG X-Series RF Vector Signal Generator | 6-Apr-16 | 6-Apr-17 | A1 thru A7 |
| CIS055358 | ZFSC-2-10G Mini-Circuits | Splitter | 11-Apr-16 | 11-Apr-17 | A1 thru A7 |
| CIS055099 | SMART2200RM2U Tripp-Lite | Power Supply | Cal Not Required | | A1 thru A7 |
| CIS055094 | PXI-1042 National Instruments | Chassis | Cal Not Required | | A1 thru A7 |

Appendix E: Abbreviation Key and Definitions

The following table defines abbreviations used within this test report.

| Abbreviation | Description | Abbreviation | Description |
|--------------|--|--------------|------------------------------------|
| EMC | Electro Magnetic Compatibility | °F | Degrees Fahrenheit |
| EMI | Electro Magnetic Interference | °C | Degrees Celsius |
| EUT | Equipment Under Test | Temp | Temperature |
| ITE | Information Technology Equipment | S/N | Serial Number |
| TAP | Test Assessment Schedule | Qty | Quantity |
| ESD | Electro Static Discharge | emf | Electromotive force |
| EFT | Electric Fast Transient | RMS | Root mean square |
| EDCS | Engineering Document Control System | Qp | Quasi Peak |
| Config | Configuration | Av | Average |
| CIS# | Cisco Number (unique identification number for Cisco test equipment) | Pk | Peak |
| Cal | Calibration | kHz | Kilohertz (1x10 ³) |
| EN | European Norm | MHz | MegaHertz (1x10 ⁶) |
| IEC | International Electro technical Commission | GHz | Gigahertz (1x10 ⁹) |
| CISPR | International Special Committee on Radio Interference | H | Horizontal |
| CDN | Coupling/Decoupling Network | V | Vertical |
| LISN | Line Impedance Stabilization Network | dB | decibel |
| PE | Protective Earth | V | Volt |
| GND | Ground | kV | Kilovolt (1x10 ³) |
| L1 | Line 1 | μV | Microvolt (1x10 ⁻⁶) |
| L2 | Line2 | A | Amp |
| L3 | Line 3 | μA | Micro Amp (1x10 ⁻⁶) |
| DC | Direct Current | mS | Milli Second (1x10 ⁻³) |
| RAW | Uncorrected measurement value, as indicated by the measuring device | μS | Micro Second (1x10 ⁻⁶) |
| RF | Radio Frequency | μS | Micro Second (1x10 ⁻⁶) |
| SLCE | Signal Line Conducted Emissions | m | Meter |
| Meas dist | Measurement distance | Spec dist | Specification distance |
| N/A or NA | Not Applicable | SL | Signal Line (or Telecom Line) |
| P | Power Line | L | Live Line |
| N | Neutral Line | R | Return |
| S | Supply | AC | Alternating Current |

End