

**Test Report**  
**AIR-AP1562I-x-K9**  
**AIR-AP1562D-x-K9**  
**(x=B,S)**

Cisco Aironet 802.11ac Dual Band Outdoor Access Points

FCC ID: LDK102104

**5470-5725 MHz**

Against the following Specifications:

CFR47 Part 15.407



Cisco Systems

170 West Tasman Drive

San Jose, CA 95134

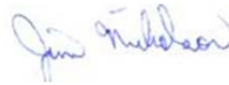
	
<b>Author:</b> Jose Aguirre <b>Tested By:</b>	<b>Approved By:</b> Jim Nicholson <b>Title:</b> Technical Leader, Engineering <b>Revision:</b> 1

This report replaces any previously entered test report under EDCS – **11386274**. This test report has been electronically authorized and archived using the CISCO Engineering Document Control system.



This test report has been electronically authorized and archived using the CISCO Engineering Document Control system.

**SECTION 1: OVERVIEW .....3**

**SECTION2: ASSESSMENT INFORMATION .....4**

    2.1 GENERAL .....4

    2.2 DATE OF TESTING.....6

    2.3 REPORT ISSUE DATE .....6

    2.4 TESTING FACILITIES .....6

    2.5 EQUIPMENT ASSESSED (EUT).....6

    2.6 EUT DESCRIPTION.....7

**SECTION 3: RESULT SUMMARY .....9**

    3.1 RESULTS SUMMARY TABLE .....9

**SECTION 4: SAMPLE DETAILS.....10**

    4.1 SAMPLE DETAILS .....10

    4.2 SYSTEM DETAILS .....10

    4.3 MODE OF OPERATION DETAILS.....10

**APPENDIX A: EMISSION TEST RESULTS .....11**

    CONDUCTED TEST SETUP DIAGRAM.....11

    TARGET MAXIMUM CHANNEL POWER .....11

        Antenna Gain: 4 dBi .....11

        Antenna Gain: 10 dBi .....12

    A.1 99% AND 26DB BANDWIDTH.....13

    A.2 MAXIMUM CONDUCTED OUTPUT POWER/ POWER SPECTRAL DENSITY.....25

        Antenna Gain: 4 dBi .....27

        Antenna Gain: 10 dBi .....32

        Antenna Gain: 4 dBi .....37

        Antenna Gain: 10 dBi .....42

    A.3 CONDUCTED SPURIOUS EMISSIONS .....47

    A.4 CONDUCTED BANDEDGE.....59

        Antenna Gain: 4 dBi .....60

        Antenna Gain: 10 dBi .....63

        Antenna Gain: 4 dBi .....66

        Antenna Gain: 10 dBi .....69

**APPENDIX B: EMISSION TEST RESULTS .....73**

    RADIATED EMISSION SETUP DIAGRAM-BELOW 1G .....73

    B.1 RADIATED SPURIOUS EMISSIONS .....74

    B.2 RADIATED EMISSIONS 30MHZ TO 1GHZ .....91

    B.3 AC CONDUCTED EMISSIONS .....94

**APPENDIX C: LIST OF TEST EQUIPMENT USED TO PERFORM THE TEST .....98**

**APPENDIX E: ABBREVIATION KEY AND DEFINITIONS.....101**

## Section 1: Overview

The samples were assessed against the tests detailed in section 3 under the requirements of the following specifications:

<b>Specifications:</b>
CFR47 Part 15.407

Measurements were made in accordance with

- ANSI C63.10:2013
- KDB 789033 D02 General UNII Test Procedures New Rules v01r03
- KDB 662911 D01 Multiple Transmitter Output v02r01

## Section2: Assessment Information

### 2.1 General

This report contains an assessment of an apparatus against Electromagnetic Compatibility Standards based upon tests carried out on the samples submitted. The testing was performed by and for the use of Cisco systems Inc:

With regard to this assessment, the following points should be noted:

- a) The results contained in this report relate only to the items tested and were obtained in the period between the date of the initial assessment and the date of issue of the report. Manufactured products will not necessarily give identical results due to production and measurement tolerances.
- b) The apparatus was set up and exercised using the configuration and modes of operation defined in this report only.
- c) Where relevant, the apparatus was only assessed using the susceptibility criteria defined in this report and the Test Assessment Plan (TAP).
- d) All testing was performed under the following environmental conditions:

Temperature	15°C to 35°C (54°F to 95°F)
Atmospheric Pressure	860mbar to 1060mbar (25.4" to 31.3")
Humidity	10% to 75*%
- e) All AC testing was performed at one or more of the following supply voltages:  
110V 60 Hz (+/-20%)

### Units of Measurement

The units of measurements defined in the appendices are reported in specific terms, which are test dependent. Where radiated measurements are concerned these are defined at a particular distance. Basic voltage measurements are defined in units of [dBuV]

As an example, the basic calculation for all measurements is as follows:

$$\text{Emission level [dBuV]} = \text{Indicated voltage level [dBuV]} + \text{Cable Loss [dB]} + \text{Other correction factors [dB]}$$

The combinations of correction factors are dependent upon the exact test configurations [see test equipment lists for further details] and may include:-

Antenna Factors, Pre Amplifier Gain, LISN Loss, Pulse Limiter Loss and Filter Insertion Loss

Note: to convert the results from dBuV/m to uV/m use the following formula:-

$$\text{Level in uV/m} = \text{Common Antilogarithm} [(X \text{ dBuV/m})/20] = Y \text{ uV/m}$$



Measurement Uncertainty Values

voltage and power measurements	± 2 dB
conducted EIRP measurements	± 1.4 dB
radiated measurements	± 3.2 dB
frequency measurements	± 2.4 10 <sup>-7</sup>
temperature measurements	± 0.54°
humidity measurements	± 2.3%
DC and low frequency measurements	± 2.5%

Where relevant measurement uncertainty levels have been estimated for tests performed on the apparatus. This uncertainty represents an expanded uncertainty expressed at approximately the 95% confidence level using a coverage factor of k=2.

Radiated emissions (expanded uncertainty, confidence interval 95%)

30 MHz - 300 MHz	+/- 3.8 dB
300 MHz - 1000 MHz	+/- 4.3 dB
1 GHz - 10 GHz	+/- 4.0 dB
10 GHz - 18GHz	+/- 8.2 dB
18GHz - 26.5GHz	+/- 4.1 dB
26.5GHz - 40GHz	+/- 3.9 dB

Conducted emissions (expanded uncertainty, confidence interval 95%)

30 MHz – 40GHz	+/- 0.38 dB
----------------	-------------

A product is considered to comply with a requirement if the nominal measured value is below the limit line. The product is considered to not be in compliance in case the nominal measured value is above the limit line.

**This report must not be reproduced except in full, without written approval of Cisco Systems.**

**2.2 Date of testing**

20-April-16 - 08-Aug-16

**2.3 Report Issue Date**

09-September-2016

Cisco uses an electronic system to issue, store and control the revision of test reports. This system is called the Engineering Document Control System (EDCS). The actual report issue date is embedded into the original file on EDCS. Any copies of this report, either electronic or paper, that are not on EDCS must be considered uncontrolled.

**2.4 Testing facilities**

This assessment was performed by:

**Testing Laboratory**

Cisco Systems, Inc.,  
125 West Tasman Drive  
San Jose, CA 95134, USA

**Registration Numbers for Industry Canada**

<b>Cisco System Site</b>	<b>Address</b>	<b>Site Identifier</b>
Building P, 10m Chamber	125 West Tasman Dr San Jose, CA 95134	Company #: 2461N-2
Building P, 5m Chamber	125 West Tasman Dr San Jose, CA 95134	Company #: 2461N-1
Building I, 5m Chamber	285 W. Tasman Drive San Jose, California 95134	Company #: 2461M-1

**Test Engineers**

Jose Aguirre

**2.5 Equipment Assessed (EUT)**

AIR-AP1562I-B-K9

## 2.6 EUT Description

The Cisco Aironet 802.11ac Radio supports the following modes of operation. The modes are further defined in the radio Theory of Operation. The modes included in this report represent the worst case data for all modes.

- 802.11n/ac - Non HT20, One Antenna, 6 to 54 Mbps
- 802.11n/ac - Non HT20, Two Antennas, 6 to 54 Mbps
- 802.11n/ac - Non HT20, Three Antennas, 6 to 54 Mbps
  
- 802.11n/ac - Non HT20 Beam Forming, Two Antennas, 6 to 54 Mbps
- 802.11n/ac - Non HT20 Beam Forming, Three Antennas, 6 to 54 Mbps
  
- 802.11n/ac - HT/VHT20, One Antenna, M0 to M7
- 802.11n/ac - HT/VHT20, Two Antennas, M0 to M7
- 802.11n/ac - HT/VHT20, Two Antennas, M8 to M15
- 802.11n/ac - HT/VHT20, Three Antennas, M0 to M7
- 802.11n/ac - HT/VHT20, Three Antennas, M8 to M15
  
- 802.11n/ac - HT/VHT20 Beam Forming, Two Antennas, M0 to M7
- 802.11n/ac - HT/VHT20 Beam Forming, Two Antennas, M8 to M15
- 802.11n/ac - HT/VHT20 Beam Forming, Three Antennas, M0 to M7
- 802.11n/ac - HT/VHT20 Beam Forming, Three Antennas, M8 to M15
  
- 802.11n/ac - HT/VHT20 STBC, Two Antennas, M0 to M7
- 802.11n/ac - HT/VHT20 STBC, Three Antennas, M0 to M7
  
- 802.11n/ac - Non HT40 Duplicate, One Antenna, 6 to 54 Mbps
- 802.11n/ac - Non HT40 Duplicate, Two Antennas, 6 to 54 Mbps
- 802.11n/ac - Non HT40 Duplicate, Three Antennas, 6 to 54 Mbps
  
- 802.11n/ac - HT/VHT40, One Antenna, M0 to M7
- 802.11n/ac - HT/VHT40, Two Antennas, M0 to M7
- 802.11n/ac - HT/VHT40, Two Antennas, M8 to M15
- 802.11n/ac - HT/VHT40, Three Antennas, M0 to M7
- 802.11n/ac - HT/VHT40, Three Antennas, M8 to M15
  
- 802.11n/ac - HT/VHT40 Beam Forming, Two Antennas, M0 to M7
- 802.11n/ac - HT/VHT40 Beam Forming, Two Antennas, M8 to M15
- 802.11n/ac - HT/VHT40 Beam Forming, Three Antennas, M0 to M7
- 802.11n/ac - HT/VHT40 Beam Forming, Three Antennas, M8 to M15
  
- 802.11n/ac - HT/VHT40 STBC, Two Antennas, M0 to M7
- 802.11n/ac - HT/VHT40 STBC, Three Antennas, M0 to M7
  
- 802.11n/ac - Non HT80 Duplicate, One Antenna, 6 to 54 Mbps
- 802.11n/ac - Non HT80 Duplicate, Two Antennas, 6 to 54 Mbps
- 802.11n/ac - Non HT80 Duplicate, Three Antennas, 6 to 54 Mbps
  
- 802.11ac - VHT80, One Antenna, M0 to M9 1ss
- 802.11ac - VHT80, Two Antennas, M0 to M9 1ss
- 802.11ac - VHT80, Two Antennas, M0 to M9 2ss
- 802.11ac - VHT80, Three Antennas, M0 to M9 1ss
- 802.11ac - VHT80, Three Antennas, M0 to M9 2ss
  
- 802.11ac - VHT80 Beam Forming, Two Antennas, M0 to M9 1ss
- 802.11ac - VHT80 Beam Forming, Two Antennas, M0 to M9 2ss
- 802.11ac - VHT80 Beam Forming, Three Antennas, M0 to M9 1ss
- 802.11ac - VHT80 Beam Forming, Three Antennas, M0 to M9 2ss
  
- 802.11ac - VHT80 STBC, Two Antennas, M0 to M9 1ss



802.11ac - VHT80 STBC, Three Antennas, M0 to M9 1ss

The following antennas are supported by this product series.  
 The data included in this report represent the worst case data for all antennas.

Frequency	Part Number	Antenna Type	Antenna Gain (dBi)
<b>5 GHz</b>	Internal (*)	Omni	<b>4</b>
	Internal (**)	Directional (Cross Polarized)	<b>10</b>

(\*) Internal antenna for AIR-AP1562I-x-K9  
 (\*\*) Internal antenna for AIR-AP1562D-x-K9



## Section 3: Result Summary

### 3.1 Results Summary Table

#### Conducted emissions

Basic Standard	Technical Requirements / Details	Result
FCC 15.407	<p><b>99% &amp; 26 dB Bandwidth:</b> The 99% occupied bandwidth is the frequency bandwidth such that, below its lower and above its upper frequency limits, the mean powers are each equal to 0.5% of the total mean power of the given emission. There is no limit for 99% OBW.</p> <p>The 26 dB emission is the width of the emission that is constrained by the frequencies associated with the two outermost amplitude points (upper and lower frequencies) that are attenuated by 26 dB relative to the maximum level measured in the fundamental emission.</p>	Pass
FCC 15.407	<p><b>Output Power:</b> <b>15.407</b> (2) For the 5.25-5.35 GHz and 5.47-5.725 GHz bands, the maximum conducted output power over the frequency bands of operation shall not exceed the lesser of 250 mW or 11 dBm + 10 log B, where B is the 26 dB emission bandwidth in megahertz. In addition, the maximum power spectral density shall not exceed 11 dBm in any 1 megahertz band. If transmitting antennas of directional gain greater than 6 dBi are used, both the maximum conducted output power and the maximum power spectral density shall be reduced by the amount in dB that the directional gain of the antenna exceeds 6 dBi.</p>	Pass
FCC 15.407	<p><b>Power Spectral Density:</b> <b>15.407</b> The maximum power spectral density shall not exceed 17 dBm in any 1 megahertz band. If transmitting antennas of directional gain greater than 6 dBi are used, both the maximum conducted output power and the maximum power spectral density shall be reduced by the amount in dB that the directional gain of the antenna exceeds 6 dBi.</p>	Pass
FCC 15.407	<p><b>Conducted Spurious Emissions / Band-Edge:</b> <b>15.407</b> (3) For transmitters operating in the 5.47-5.725 GHz band: All emissions outside of the 5.47-5.725 GHz band shall not exceed an e.i.r.p. of -27 dBm/MHz.</p>	Pass
FCC 15.407 FCC 15.209 FCC 15.205	<p><b>Restricted band:</b> Unwanted emissions falling within the restricted bands, as defined in FCC 15.205 (a) must also comply with the radiated emission limits specified in FCC 15.209 (a).</p>	Pass

#### Radiated Emissions (General requirements)

Basic Standard	Technical Requirements / Details	Result
FCC 15.209 FCC 15.205	<p><b>TX Spurious Emissions:</b> Except as provided elsewhere in this subpart, the emissions from an intentional radiator shall not exceed the field strength levels specified in the filed strength limits table in this section.</p>	Pass
FCC 15.207	<p><b>AC conducted Emissions:</b> Except when the requirements applicable to a given device state otherwise, for any radio apparatus equipped to operate from the public utility AC power supply, either directly or indirectly (such as with a battery charger), the radio frequency voltage of emissions conducted back onto the AC power lines in the frequency range of 0.15 MHz to 30 MHz shall not exceed the limits shown in the table in these sections. The more stringent limit applies at the frequency range boundaries.</p>	Pass

\* MPE calculation is recorded in a separate report

## Section 4: Sample Details

Note: Each sample was evaluated to ensure that its condition was suitable to be used as a test sample prior to the commencement of testing.

### 4.1 Sample Details

Sample No.	Equipment Details	Manufacturer	Hardware Rev.	Firmware Rev.	Software Rev.	Serial Number
S01	AIR-AP1562I-B-K9	Cisco Systems	P2	9.1.8.1	9.0.5.5-W8964	RFDP2BML009
S02*	AIR-PWRADPT-RGD1	Meanwell	A0	NA	NA	EB3F71752

(\*) S02 is support equipment Power supply for EUT S01

### 4.2 System Details

System #	Description	Samples
1	AIR-AP1562I-B-K9	S01
2	AIR-PWRADPT-RGD1	S02

### 4.3 Mode of Operation Details

Mode#	Description	Comments
1	Continuous Transmitting	Continuous Transmitting $\geq 98\%$ duty cycle

All measurements were made in accordance with

- ANSI C63.10:2013
- KDB 789033 D02 General UNII Test Procedures New Rules v01r03
- KDB 662911 D01 Multiple Transmitter Output v02r01

**Appendix A: Emission Test Results**

**Conducted Test Setup Diagram**

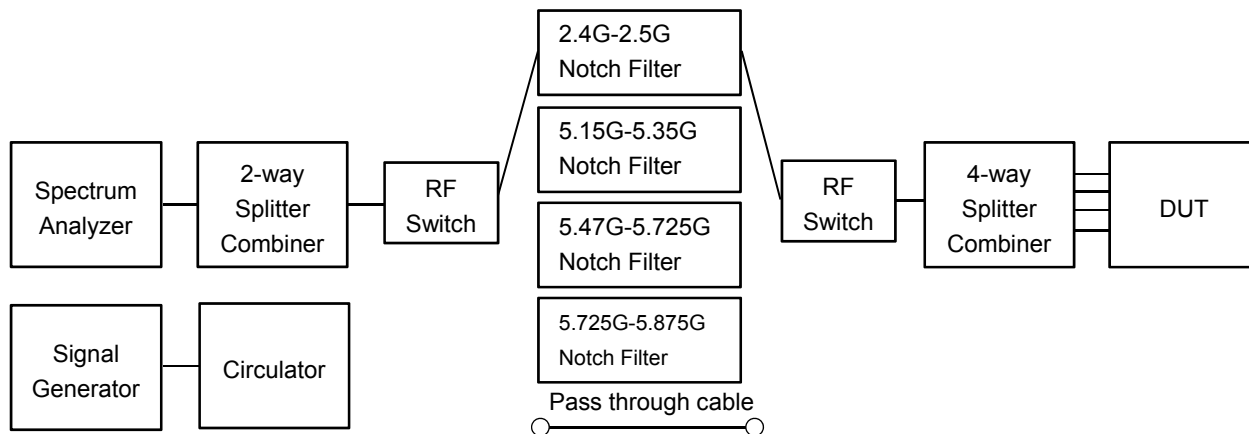

**Target Maximum Channel Power**

The following table details the maximum supported Total Channel Power for all operating modes.

**Antenna Gain: 4 dBi**

Operating Mode	Maximum Channel Power (dBm)		
	Frequency (MHz)		
	5500	5580	5720
Non HT20, 6 to 54 Mbps	21	21	21
Non HT20 Beam Forming, 6 to 54 Mbps	19	20	20
HT/VHT20, M0 to M15	21	22	22
HT/VHT20 Beam Forming, M0 to M15	21	22	22
HT/VHT20 STBC, M0 to M7	21	22	22
	5510	5590	5710
Non HT40, 6 to 54 Mbps	15	24	24
HT/VHT40, M0 to M15	19	24	24
HT/VHT40 Beam Forming, M0 to M15	18	24	23
HT/VHT40 STBC, M0 to M7	19	24	23
	5530	5610	5690
Non HT80, 6 to 54 Mbps	17	23	22
VHT80, M0 to M9, M0 to M9 1-1ss	18	24	24
VHT80 Beam Forming, M0 to M9, M0 to M9 1-1ss	18	24	24
VHT80 STBC, M0 to M9 1ss	18	24	24



**Antenna Gain: 10 dBi**

Operating Mode	Maximum Channel Power (dBm)		
	Frequency (MHz)		
	5500	5580	5720
Non HT20, 6 to 54 Mbps	17	17	17
Non HT20 Beam Forming, 6 to 54 Mbps	17	17	17
HT/VHT20, M0 to M15	17	17	17
HT/VHT20 Beam Forming, M0 to M15	17	17	17
HT/VHT20 STBC, M0 to M7	17	17	17
	<b>5510</b>	<b>5590</b>	<b>5710</b>
Non HT40, 6 to 54 Mbps	10	19	19
HT/VHT40, M0 to M15	14	19	20
HT/VHT40 Beam Forming, M0 to M15	14	19	19
HT/VHT40 STBC, M0 to M7	14	19	19
	<b>5530</b>	<b>5610</b>	<b>5690</b>
Non HT80, 6 to 54 Mbps	13	17	16
VHT80, M0 to M9, M0 to M9 1-1ss	14	19	19
VHT80 Beam Forming, M0 to M9, M0 to M9 1-1ss	14	19	19
VHT80 STBC, M0 to M9 1ss	14	19	19

## A.1 99% and 26dB Bandwidth

**FCC 15.407** The 99% occupied bandwidth is the frequency bandwidth such that, below its lower and above its upper frequency limits, the mean powers are each equal to 0.5% of the total mean power of the given emission. There is no limit for 99% OBW.

The 26 dB emission is the width of the emission that is constrained by the frequencies associated with the two outermost amplitude points (upper and lower frequencies) that are attenuated by 26 dB relative to the maximum level measured in the fundamental emission.

### KDB 644545 D03 v01 section D1b

**Band-crossing emissions:** For an emission that crosses the boundary between two adjacent U-NII bands, the boundary frequency between the bands serves as one edge for defining the portion of the EBW that falls within a particular U-NII band. However, the -26 dB points are measured relative to the highest point on the contiguous segment—regardless of which band contains that highest point (Figure4).

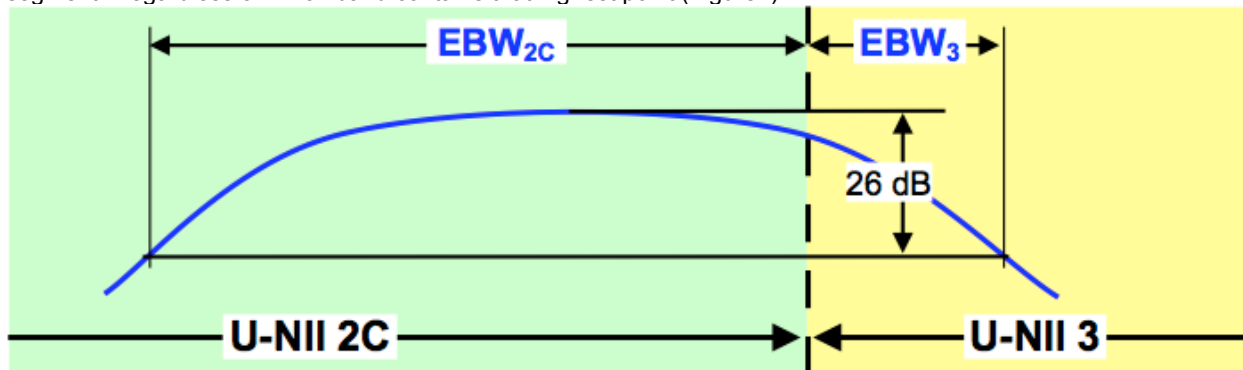

**Figure 4. Emission Bandwidth (EBW) within a Band for Band-Crossing Signals**

### Test Procedure

**Ref. ANSI C63.10: 2013 Section 6.9.3**

KDB 644545 D03 v01

KDB 789033 D02 General UNII Test Procedures New Rules v01r03

KDB 662911

#### 99% BW and EBW (-26dB)

Test Procedure

1. Set the radio in the continuous transmitting mode.
2. Allow the trace to stabilize.
3. Setting the x-dB bandwidth mode to -26dB and OBW power function to 99% within the measurement set up function.
4. Select the automatic OBW measurement function of an instrument to perform bandwidth measurement.
5. Capture graphs and record pertinent measurement data.

**Ref. ANSI C63.10: 2013 Section 6.9.3**

#### 99% BW and EBW (-26dB)

Test parameters

X dB BW = -26dB (using the OBW function of the spectrum analyzer)

OBW = 99% (using the OBW function of the spectrum analyzer)

Span = 1.5 x to 5.0 times OBW

RBW = approx. 1% to 5% of the OBW

VBW ≥ 3 x RBW

Detector = Peak or where practical sample shall be used

Trace = Max. Hold



System Number	Description	Samples	System under test	Support equipment
1	EUT	S01	<input checked="" type="checkbox"/>	<input type="checkbox"/>
	Support	S02	<input type="checkbox"/>	<input checked="" type="checkbox"/>

<b>Tested By :</b> Jose Aguirre	<b>Date of testing:</b> 20-April-16 - 08-Aug-16
<b>Test Result : PASS</b>	

See Appendix C for list of test equipment

Frequency (MHz)	Mode	Data Rate (Mbps)	26dB BW (MHz)	99% BW (MHz)
5500	Non HT20, 6 to 54 Mbps	6	22.4	18.012
	HT/VHT20, M0 to M15	m0	22.7	18.321
5510	Non HT40, 6 to 54 Mbps	6	51.4	36.951
	HT/VHT40, M0 to M15	m0	44.4	36.624
5530	Non HT80, 6 to 54 Mbps	6	83.5	76.412
	VHT80, M0 to M9, M0 to M9 1-1ss	m0x1	82.8	76.623
5580	Non HT20, 6 to 54 Mbps	6	23.5	17.978
	HT/VHT20, M0 to M15	m0	22.3	18.301
5590	Non HT40, 6 to 54 Mbps	6	66.8	37.335
	HT/VHT40, M0 to M15	m0	42.9	36.665
5610	Non HT80, 6 to 54 Mbps	6	99.1	76.404
	VHT80, M0 to M9, M0 to M9 1-1ss	m0x1	82.4	76.528
5690	Non HT80, 6 to 54 Mbps	6	91.7	76.502
	VHT80, M0 to M9, M0 to M9 1-1ss	m0x1	83.5	76.734
5710	Non HT40, 6 to 54 Mbps	6	73.3	37.711
	HT/VHT40, M0 to M15	m0	46.5	36.681
5720	Non HT20, 6 to 54 Mbps	6	22.5	17.966
	HT/VHT20, M0 to M15	m0	22.3	18.328



**26dB / 99% Bandwidth, 5500 MHz, Non HT20, 6 to 54 Mbps**

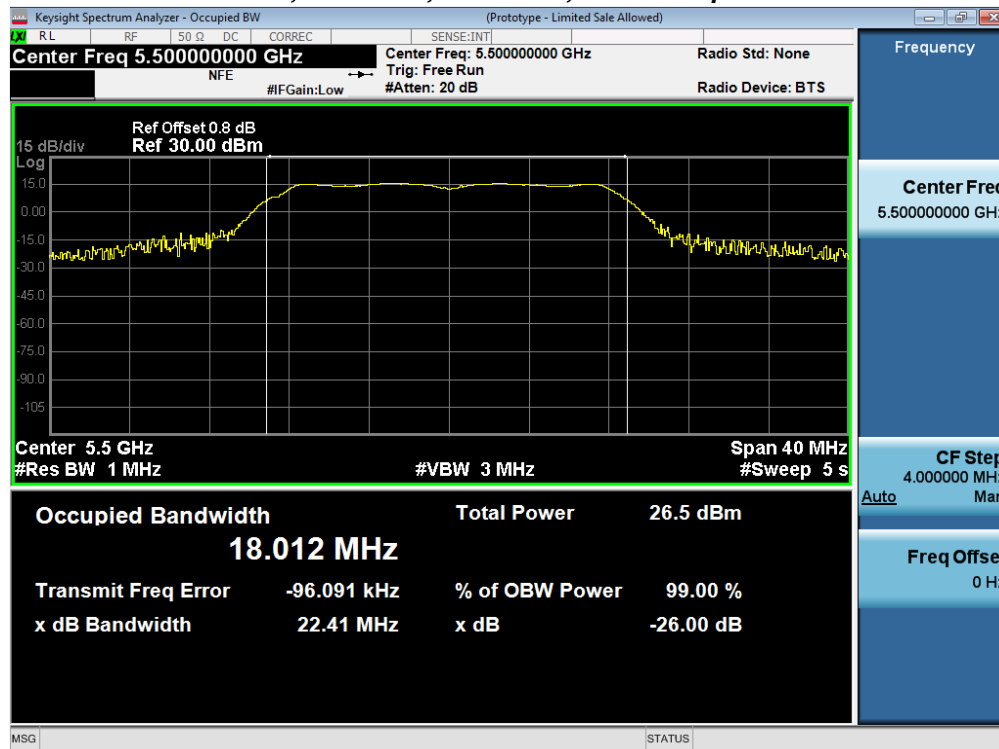

**26dB / 99% Bandwidth, 5500 MHz, HT/VHT20, M0 to M15**

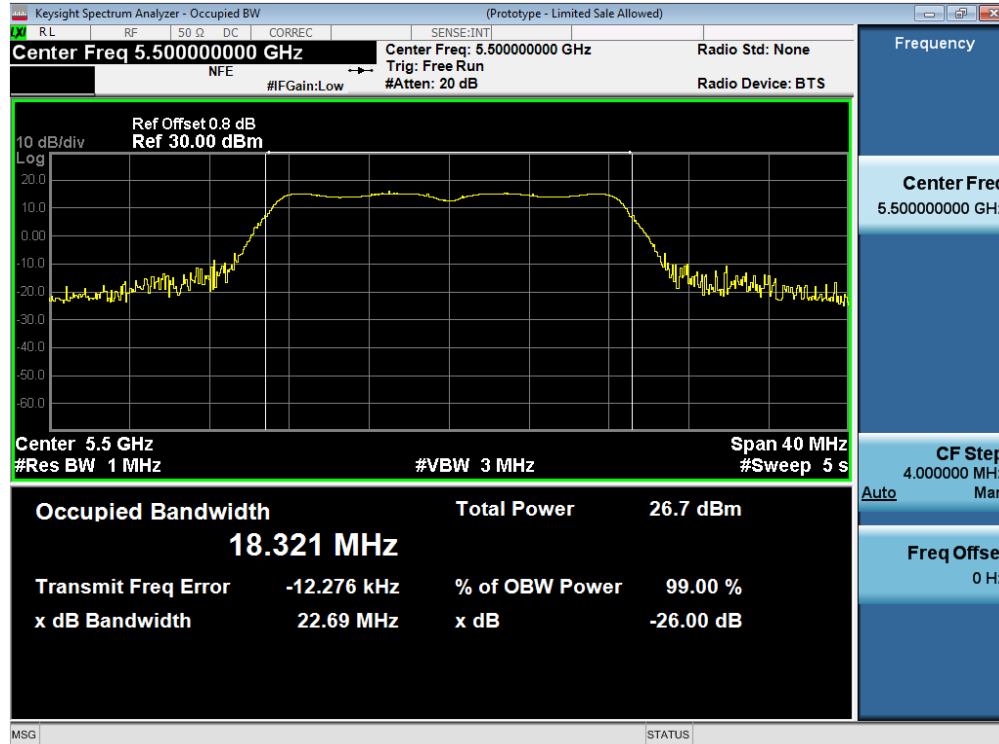



**26dB / 99% Bandwidth, 5510 MHz, Non HT40, 6 to 54 Mbps**

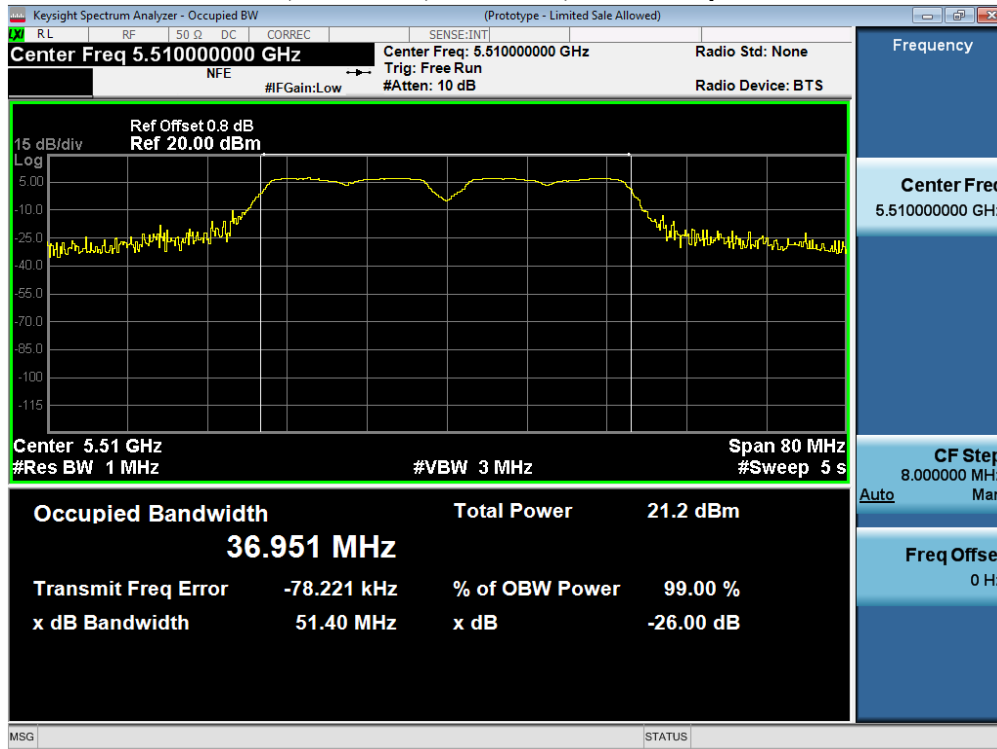

**26dB / 99% Bandwidth, 5510 MHz, HT/VHT40, M0 to M15**

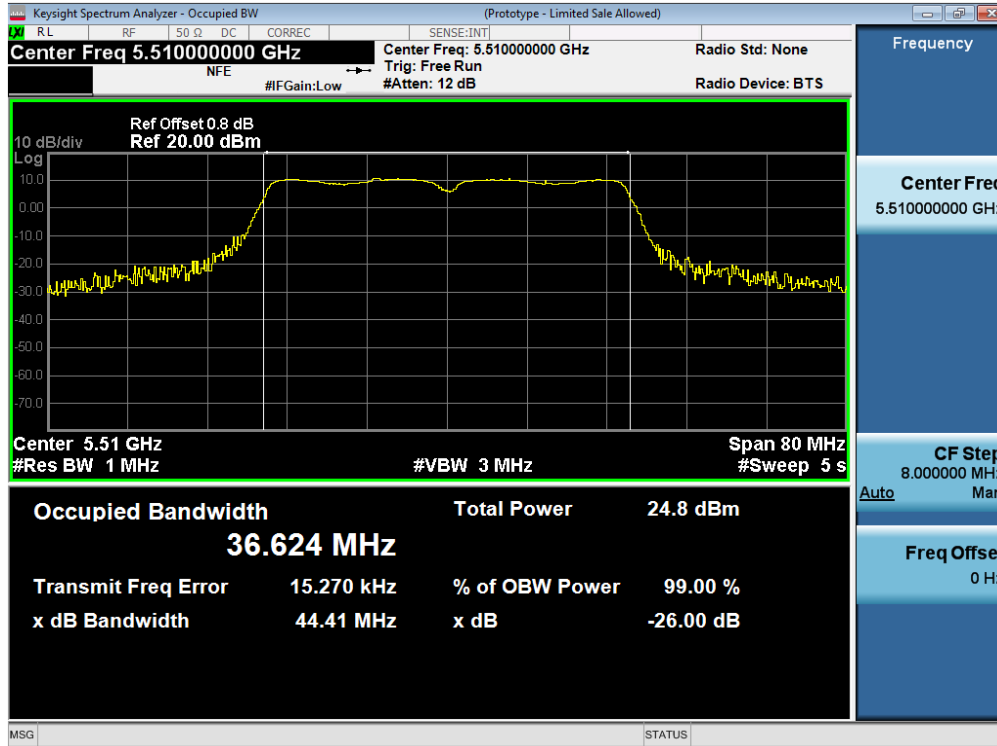

**26dB / 99% Bandwidth, 5530 MHz, Non HT80, 6 to 54 Mbps**

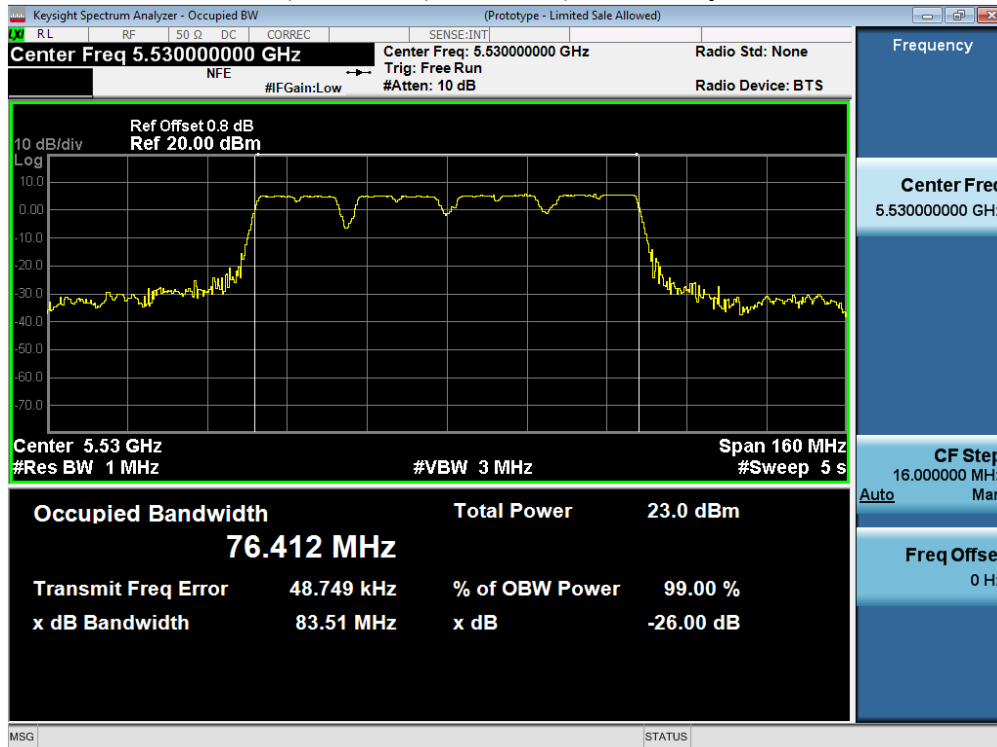

**26dB / 99% Bandwidth, 5530 MHz, VHT80, M0 to M9, M0 to M9 1-1ss**

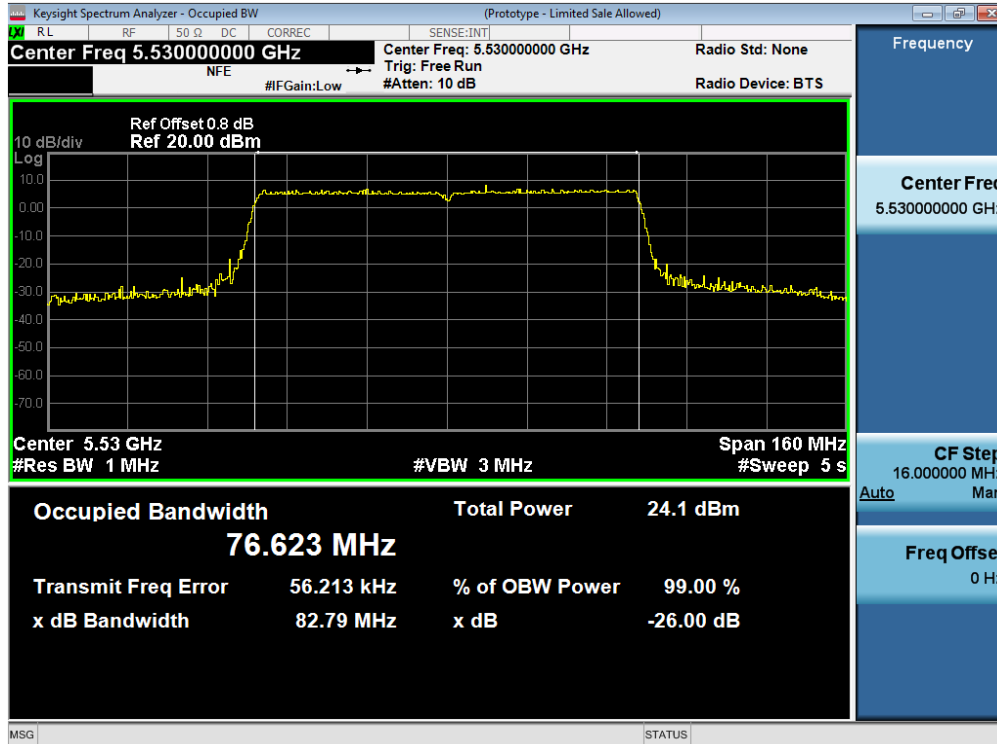



**26dB / 99% Bandwidth, 5580 MHz, Non HT20, 6 to 54 Mbps**

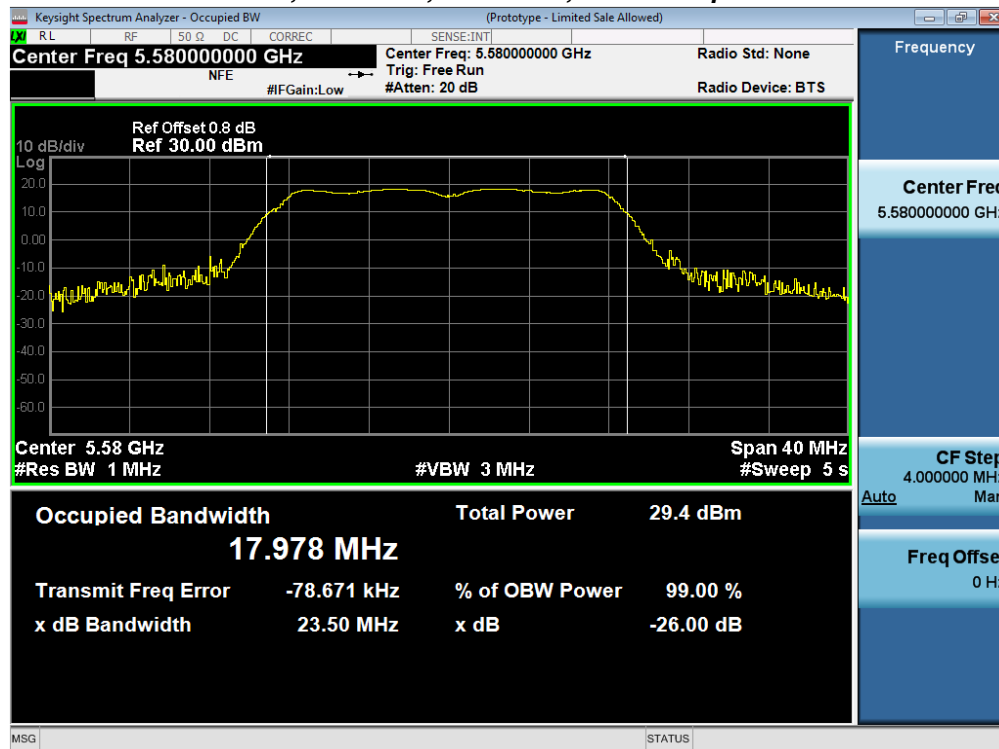

**26dB / 99% Bandwidth, 5580 MHz, HT/VHT20, M0 to M15**

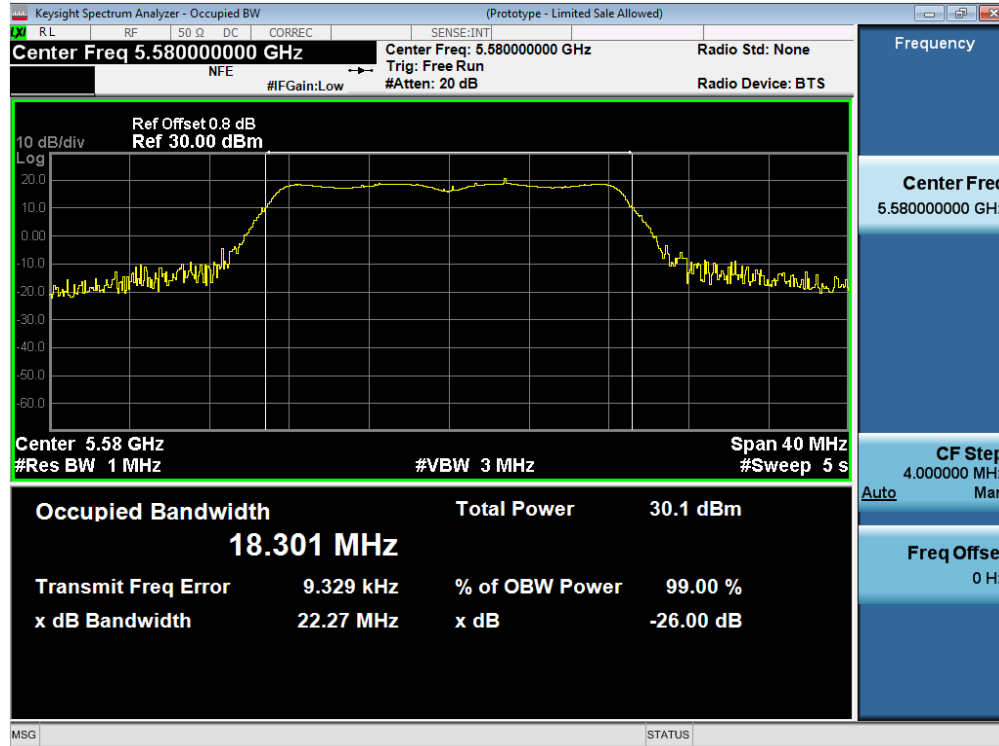



**26dB / 99% Bandwidth, 5590 MHz, Non HT40, 6 to 54 Mbps**

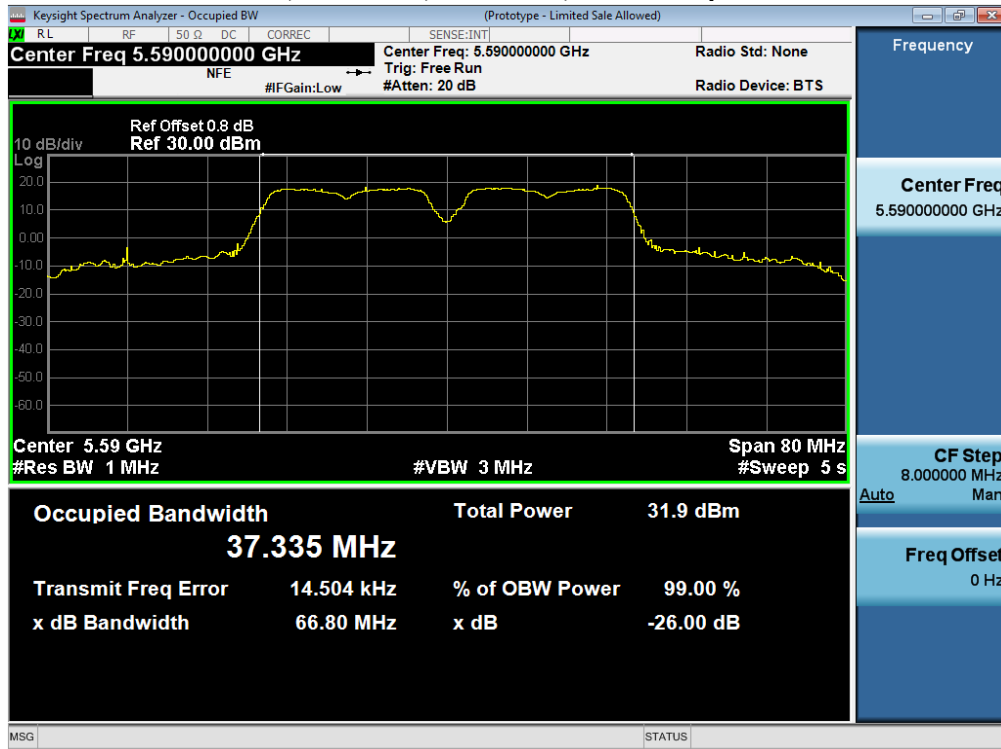

**26dB / 99% Bandwidth, 5590 MHz, HT/VHT40, M0 to M15**

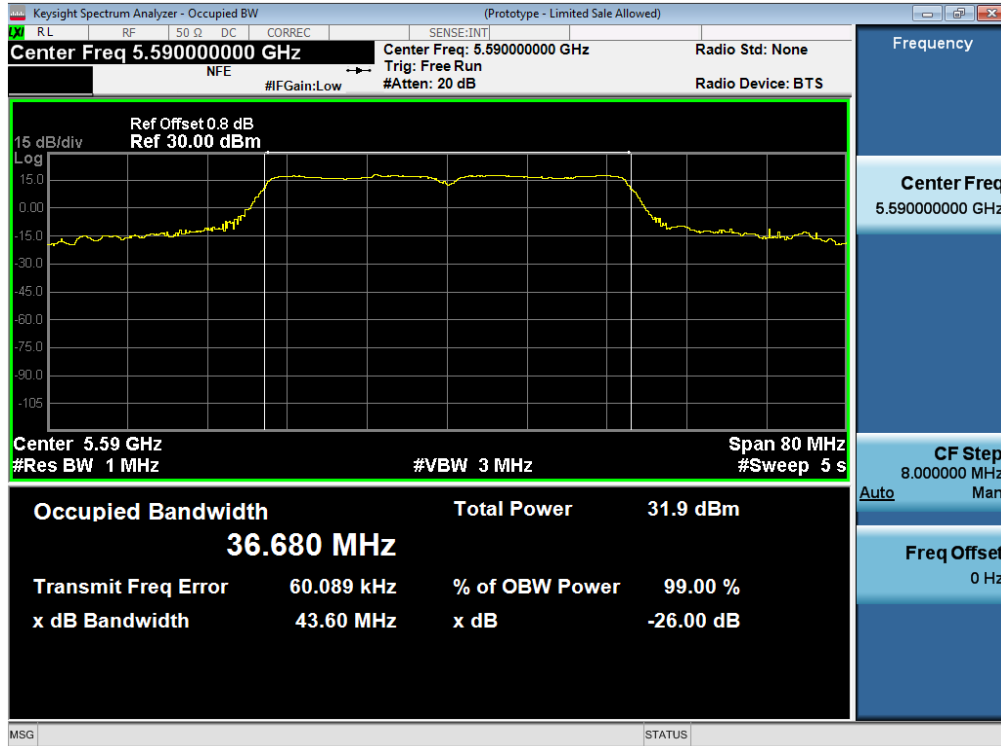

**26dB / 99% Bandwidth, 5610 MHz, Non HT80, 6 to 54 Mbps**

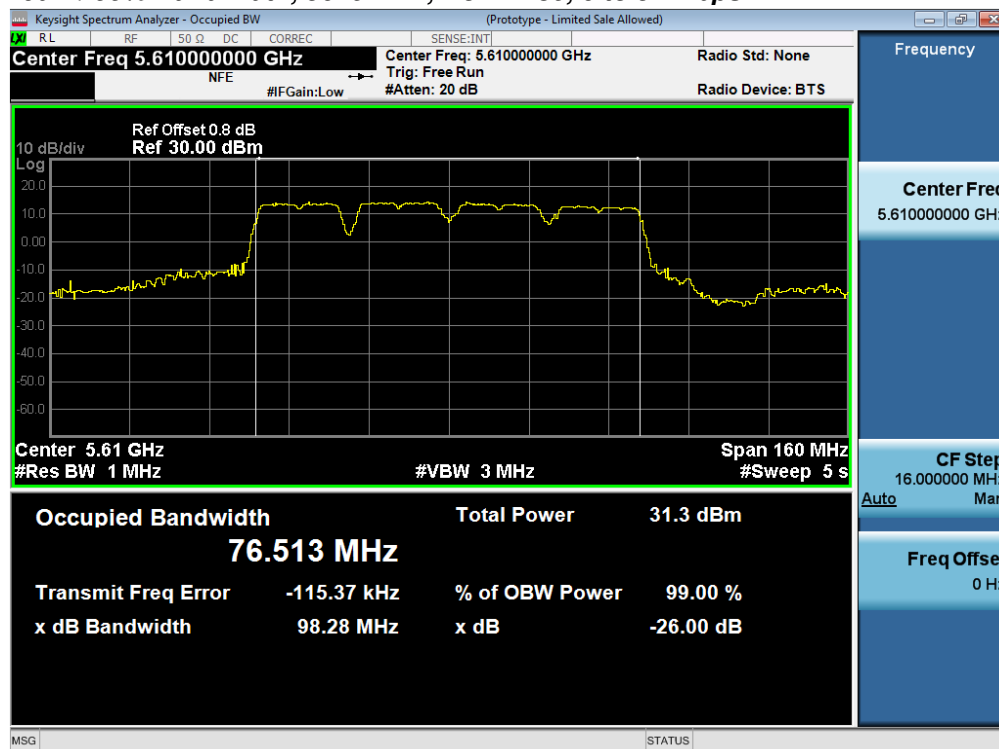

**26dB / 99% Bandwidth, 5610 MHz, VHT80, M0 to M9, M0 to M9 1-1ss**

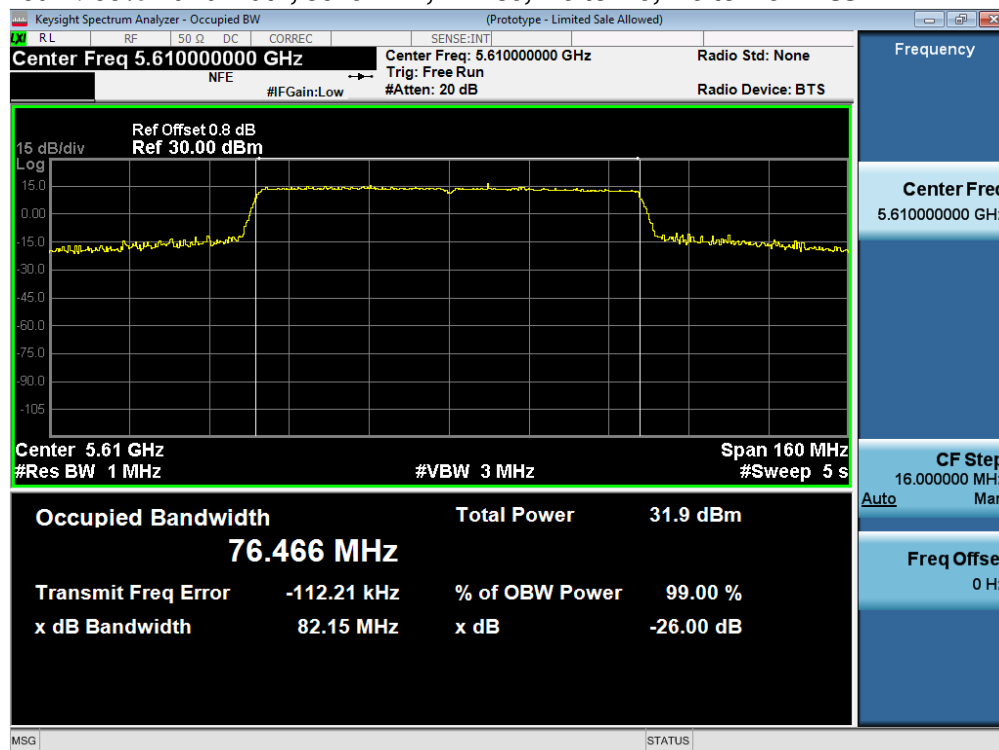



**26dB / 99% Bandwidth, 5690 MHz, Non HT80, 6 to 54 Mbps**

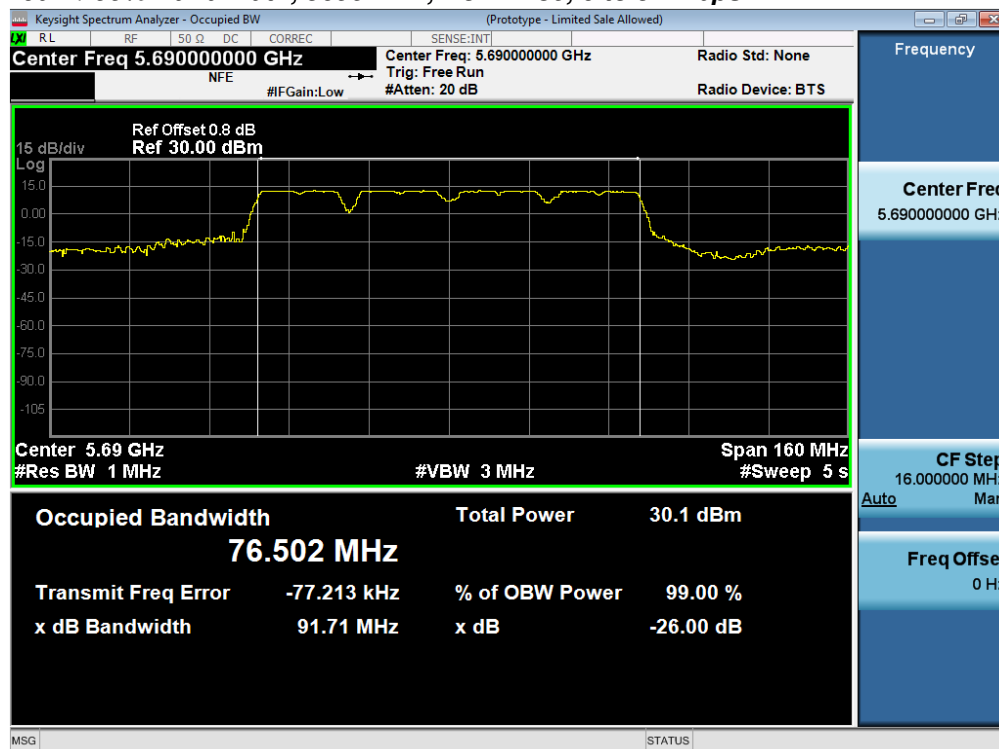

**26dB / 99% Bandwidth, 5690 MHz, VHT80, M0 to M9, M0 to M9 1-1ss**

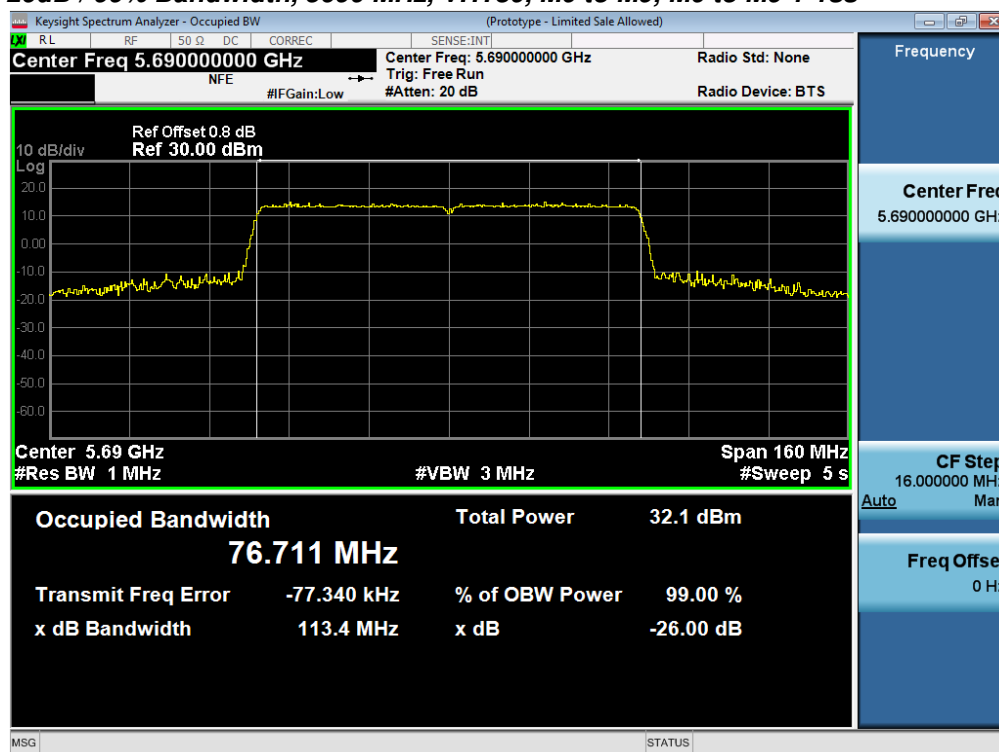

**26dB / 99% Bandwidth, 5710 MHz, Non HT40, 6 to 54 Mbps**

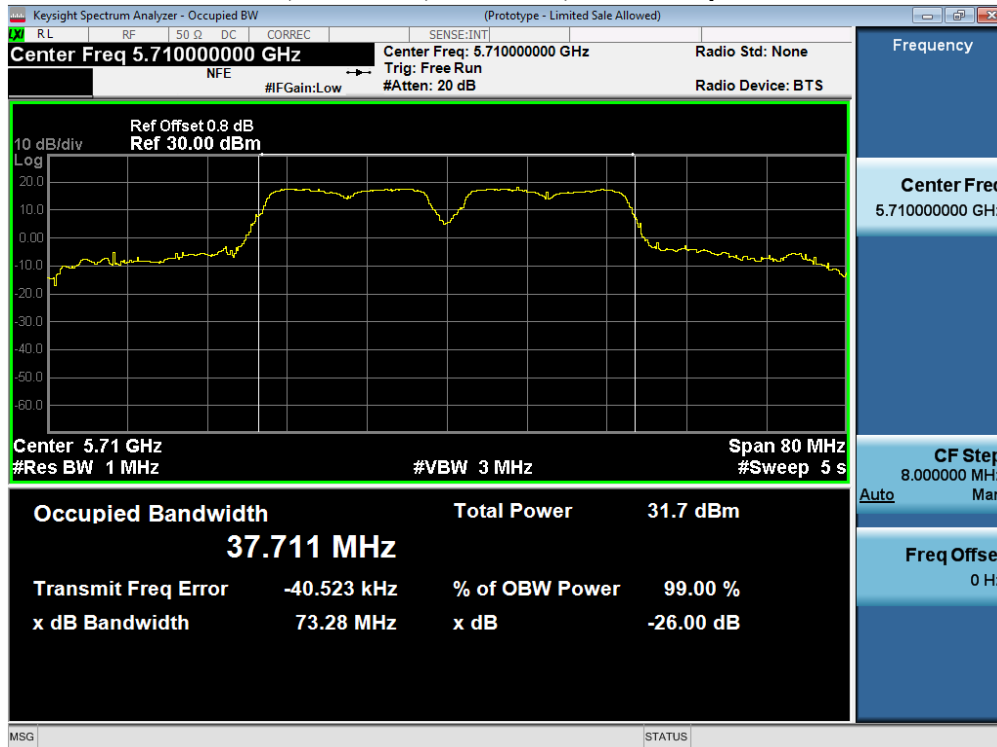

**26dB / 99% Bandwidth, 5710 MHz, HT/VHT40, M0 to M15**

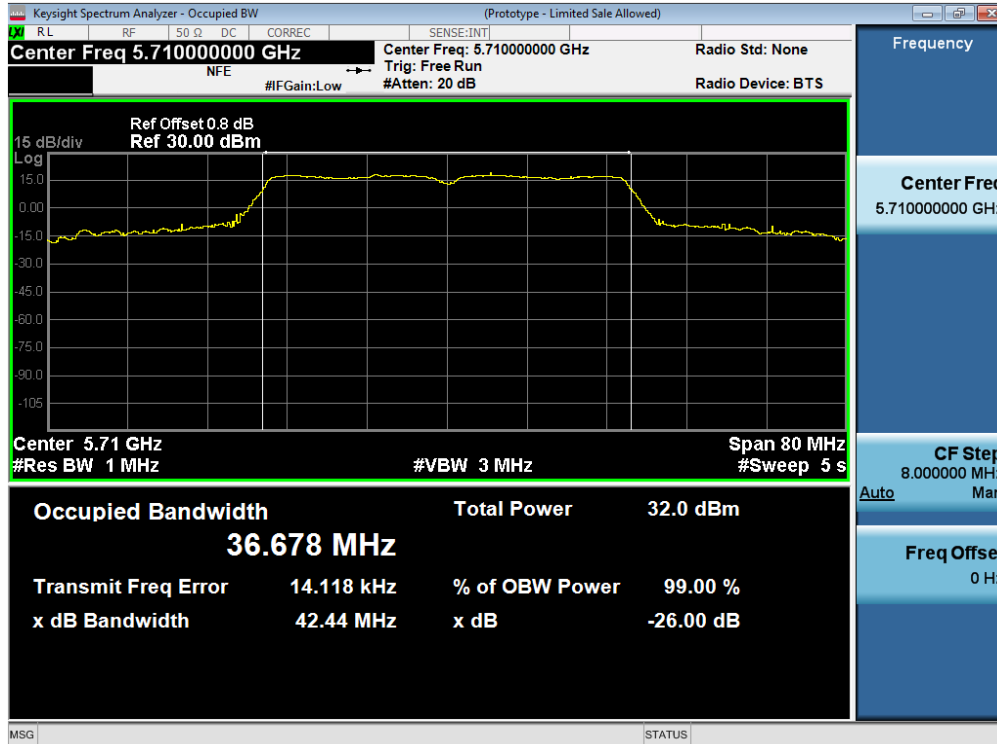

**26dB / 99% Bandwidth, 5720 MHz, Non HT20, 6 to 54 Mbps**

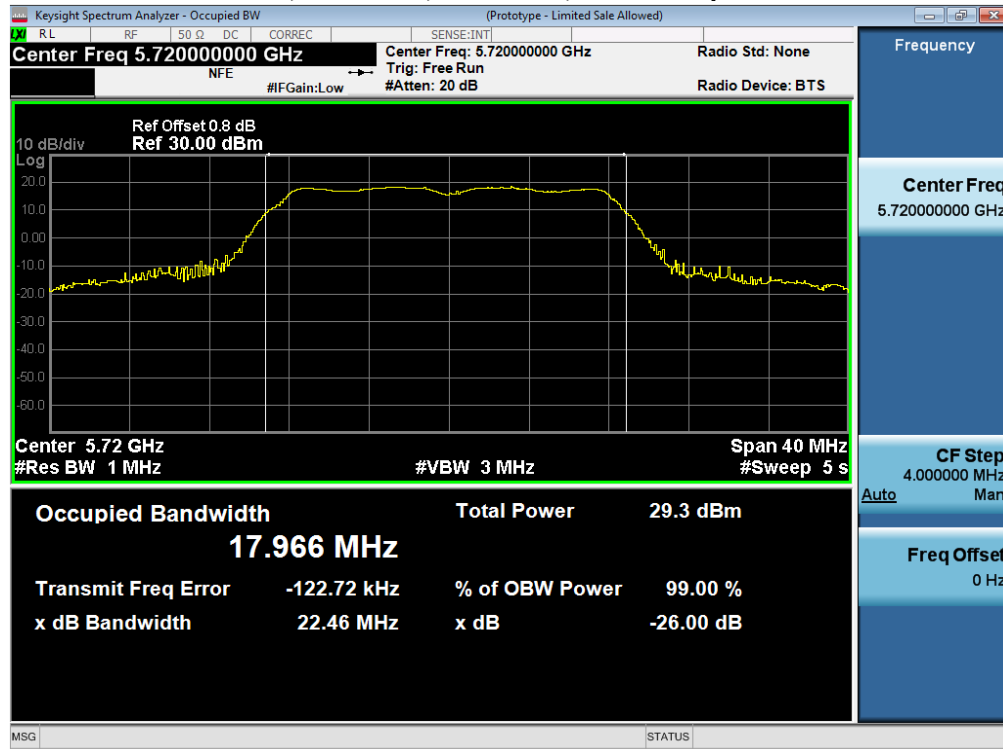

**26dB / 99% Bandwidth, 5720 MHz, HT/VHT20, M0 to M15**

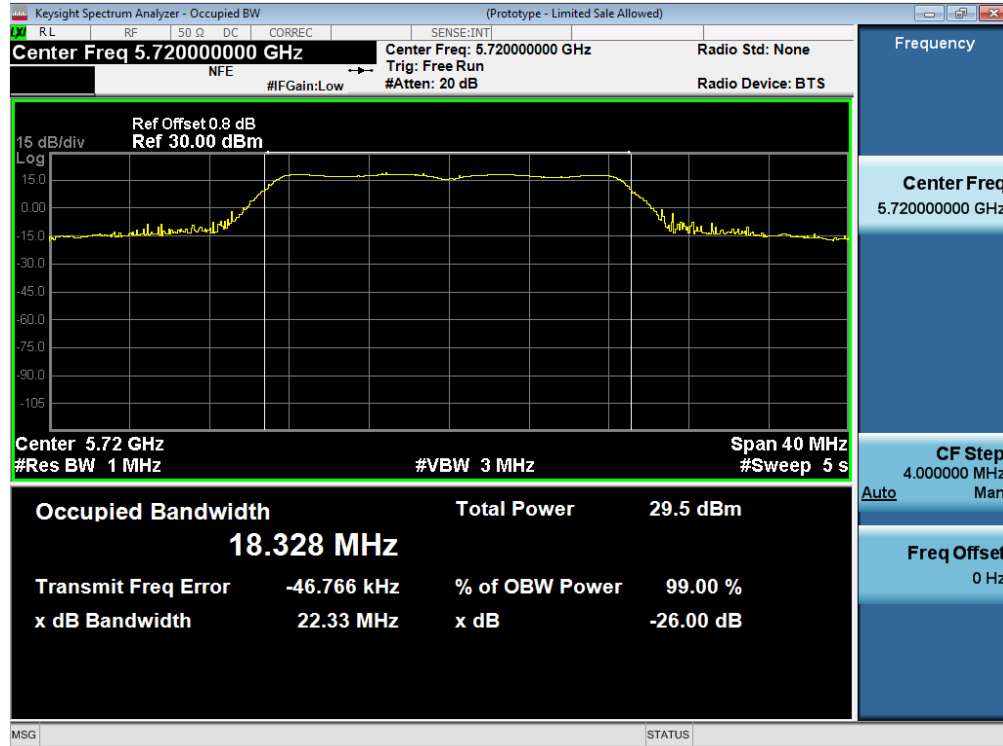



## A.2 Maximum Conducted Output Power/ Power Spectral Density

**15.407 (2)** For the 5.25-5.35 GHz and 5.47-5.725 GHz bands, the maximum conducted output power over the frequency bands of operation shall not exceed the lesser of 250 mW or  $11 \text{ dBm} + 10 \log B$ , where B is the 26 dB emission bandwidth in megahertz. In addition, the maximum power spectral density shall not exceed 11 dBm in any 1 megahertz band. If transmitting antennas of directional gain greater than 6 dBi are used, both the maximum conducted output power and the maximum power spectral density shall be reduced by the amount in dB that the directional gain of the antenna exceeds 6 dBi.

**15.407 a (3)** For the band 5.725-5.85 GHz, the maximum conducted output power over the frequency band of operation shall not exceed 1 W. If transmitting antennas of directional gain greater than 6 dBi are used, both the maximum conducted output power and the maximum power spectral density shall be reduced by the amount in dB that the directional gain of the antenna exceeds 6 dBi. However, fixed point-to-point U-NII devices operating in this band may employ transmitting antennas with directional gain greater than 6 dBi without any corresponding reduction in transmitter conducted power. Fixed, point-to-point operations exclude the use of point-to-multipoint systems, omnidirectional applications, and multiple collocated transmitters transmitting the same information. The operator of the U-NII device, or if the equipment is professionally installed, the installer, is responsible for ensuring that systems employing high gain directional antennas are used exclusively for fixed, point-to-point operations.

The power spectral density shall not exceed 30 dBm in any 500 kHz band. If transmitting antennas of directional gain greater than 6 dBi are used, both the maximum conducted output power and the power spectral density shall be reduced by the amount in dB that the directional gain of the antenna exceeds 6 dBi.

### KDB 644545 D03 (section F.2.b.ii)

When measuring the portion of the maximum conducted output power within a single U-NII band, the power shall be integrated across only the portion of the EBW that falls within that band. That is, if an EBW extends across the boundary between two adjacent bands, the boundary frequency between the bands serves as one edge of the frequency range to be integrated. Integration across an entire U-NII band without regard to 26 dB points is also acceptable for determining conducted output power within that band.

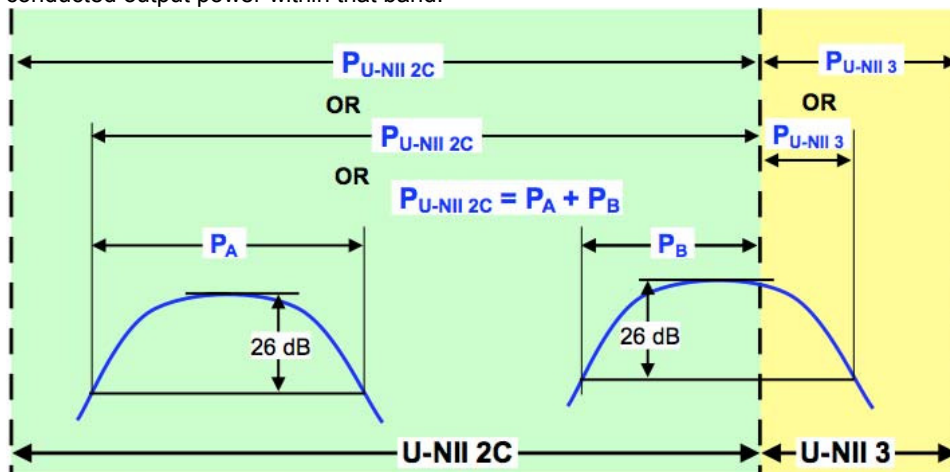

**Conducted output power within a U-NII band:** Integrate over the band, or integrate over a span including the 26 dB EBWs of transmission segments within the band, or integrate over 26 dB EBW of each transmission segment in the band and sum.

**Figure 5. Conducted Output Power Measurement Examples**

The “measure-and-sum technique” is used for measuring in-band transmit power of a device. In the measure-and-sum approach, the conducted emission level is measured at each antenna port. The measured results at the various antenna ports are then summed mathematically to determine the total emission level from the device. Summing is performed in linear power units. (ANSI C63.10: 2013, section 14.3.2.2)

### Test Procedure



**Ref.** KDB 789033 D02 General UNII Test Procedures New Rules v01r03  
 ANSI C63.10: 2013  
 KDB 644545 D03 v01

<b>Output Power</b>
Test Procedure
1. Set the radio in the continuous transmitting mode at full power 2. Compute power by integrating the spectrum across the EBW (or alternatively entire 99% OBW) of the signal using the instrument's band power measurement function. The integration shall be performed using the spectrum analyzer band-power measurement function with band limits set equal to the EBW or the OBW band edges. 3. Capture graphs and record pertinent measurement data.

**Ref.** KDB 789033 D02 General UNII Test Procedures New Rules v01r03  
 ANSI C63.10: 2013 section 12.3.2.2 Method SA-1

<b>Output Power</b>
Test parameters
Span = >1.5 times the OBW RBW = 1MHz VBW ≥ 3 x RBW Sweep = Auto couple Detector = sample Trace = Trace Average 100

The "measure-and-sum technique" is used for measuring in-band transmit power of a device. In the measure-and-sum approach, the conducted emission level is measured at each antenna port. The measured results at the various antenna ports are then summed mathematically to determine the total emission level from the device. Summing is performed in linear power units. (See ANSI C63.10 section 14.3.2.2)

<b>Power Spectral Density (UNII 2C band)</b>	<b>Power Spectral Density (UNII 3 band)</b>
Test parameters	Test parameters
ANSI C63.10: 2013 , sec12.3.2.2 Method SA-1	KDB 789033 D02 v03 section F.5
Span = >1.5 times the OBW RBW = 1MHz VBW ≥ 3 x RBW Sweep = Auto couple Detector = Sample Trace = Trace Average 100 Marker = Peak Search	Span = >1.5 times the OBW RBW = 500 kHz. VBW ≥ 3 x RBW Sweep = 10s Detector = Peak Trace = Single Sweep Marker = Peak Search

The "Measure and add 10 log(N) dB technique", where N is the number of outputs, is used for measuring in-band Power Spectral Density. With this technique, spectrum measurements are performed at each output of the device, and the quantity 10 log(4) (or 6dB) is added to the worst case spectrum value before comparing to the emission limit. (ANSI C63.10 2013 section 14.3.2.3)

System Number	Description	Samples	System under test	Support equipment
1	EUT	S01	<input checked="" type="checkbox"/>	<input type="checkbox"/>
	Support	S02	<input type="checkbox"/>	<input checked="" type="checkbox"/>

<b>Tested By :</b> Jose Aguirre	<b>Date of testing:</b> 20-April-16 - 08-Aug-16
<b>Test Result : PASS</b>	

See Appendix C for list of test equipment



**Antenna Gain: 4 dBi**

Frequency (MHz)	Mode	Tx Paths	Correlated Antenna Gain (dBi)	Tx 1 Max Power (dBm)	Tx 2 Max Power (dBm)	Tx 3 Max Power (dBm)	Total Tx Channel Power (dBm)	Limit (dBm)	Margin (dB)
5500	Non HT20, 6 to 54 Mbps	1	4	18.4			18.4	23.6	5.2
	Non HT20, 6 to 54 Mbps	2	4	18.0	17.3		20.7	23.5	2.8
	Non HT20, 6 to 54 Mbps	3	4	12.8	12.4	12.3	17.3	23.5	6.2
	Non HT20 Beam Forming, 6 to 54 Mbps	2	7	16.7	16.2		19.5	22.5	3.0
	Non HT20 Beam Forming, 6 to 54 Mbps	3	9	12.8	12.4	12.3	17.3	20.5	3.2
	HT/VHT20, M0 to M7	1	4	18.5			18.5	23.6	5.1
	HT/VHT20, M0 to M7	2	4	18.0	17.4		20.7	23.6	2.9
	HT/VHT20, M8 to M15	2	4	18.0	17.4		20.7	23.6	2.9
	HT/VHT20, M0 to M7	3	4	14.2	13.7	13.6	18.6	23.6	5.0
	HT/VHT20, M8 to M15	3	4	17.0	16.4	16.2	21.3	23.6	2.3
	HT/VHT20 Beam Forming, M0 to M7	2	7	16.0	15.5		18.8	22.6	3.8
	HT/VHT20 Beam Forming, M8 to M15	2	4	18.0	17.4		20.7	23.6	2.9
	HT/VHT20 Beam Forming, M0 to M7	3	9	12.9	12.5	12.4	17.4	20.6	3.2
	HT/VHT20 Beam Forming, M8 to M15	3	6	16.0	15.5	16.0	20.6	23.6	3.0
	HT/VHT20 STBC, M0 to M7	2	4	18.0	17.4		20.7	23.6	2.9
	HT/VHT20 STBC, M0 to M7	3	4	17.0	16.4	16.2	21.3	23.6	2.3
5510	Non HT40, 6 to 54 Mbps	1	4	13.1			13.1	24.0	10.9
	Non HT40, 6 to 54 Mbps	2	4	12.2	12.0		15.1	24.0	8.9
	Non HT40, 6 to 54 Mbps	3	4	10.2	9.9	10.0	14.8	24.0	9.2
	HT/VHT40, M0 to M7	1	4	16.7			16.7	24.0	7.3
	HT/VHT40, M0 to M7	2	4	14.9	14.7		17.8	24.0	6.2
	HT/VHT40, M8 to M15	2	4	14.9	14.7		17.8	24.0	6.2
	HT/VHT40, M0 to M7	3	4	13.9	13.7	13.7	18.5	24.0	5.5
	HT/VHT40, M8 to M15	3	4	13.9	13.7	13.7	18.5	24.0	5.5
	HT/VHT40 Beam Forming, M0 to M7	2	7	12.8	12.4		15.6	23.0	7.4
	HT/VHT40 Beam Forming, M8 to M15	2	4	14.9	14.7		17.8	24.0	6.2
	HT/VHT40 Beam Forming, M0 to M7	3	9	10.2	9.8	9.9	14.7	21.0	6.3
	HT/VHT40 Beam Forming, M8 to M15	3	6	11.8	11.5	11.8	16.5	24.0	7.5
	HT/VHT40 STBC, M0 to M7	2	4	14.9	14.7		17.8	24.0	6.2
	HT/VHT40 STBC, M0 to M7	3	4	13.9	13.7	13.7	18.5	24.0	5.5



5530	Non HT80, 6 to 54 Mbps	1	4	14.8			14.8	24.0	9.2
	Non HT80, 6 to 54 Mbps	2	4	13.0	13.5		16.3	24.0	7.7
	Non HT80, 6 to 54 Mbps	3	4	12.1	12.4	11.5	16.8	24.0	7.2
	VHT80, M0 to M9 1ss	1	4	15.6			15.6	24.0	8.4
	VHT80, M0 to M9 1ss	2	4	14.7	15.1		17.9	24.0	6.1
	VHT80, M0 to M9 2ss	2	4	14.7	15.1		17.9	24.0	6.1
	VHT80, M0 to M9 1ss	3	4	12.6	12.9	13.2	17.7	24.0	6.3
	VHT80, M0 to M9 2ss	3	4	12.6	12.9	13.2	17.7	24.0	6.3
	VHT80 Beam Forming, M0 to M9 1ss	2	7	12.6	12.9		15.8	23.0	7.2
	VHT80 Beam Forming, M0 to M9 2ss	2	4	14.7	15.1		17.9	24.0	6.1
	VHT80 Beam Forming, M0 to M9 1ss	3	9	9.8	10.2	10.3	14.9	21.0	6.1
	VHT80 Beam Forming, M0 to M9 2ss	3	6	11.7	12.0	12.3	16.8	24.0	7.2
	VHT80 STBC, M0 to M9 1ss	2	4	14.7	15.1		17.9	24.0	6.1
	VHT80 STBC, M0 to M9 1ss	3	4	12.6	12.9	13.2	17.7	24.0	6.3
5580	Non HT20, 6 to 54 Mbps	1	4	21.4			21.4	23.5	2.1
	Non HT20, 6 to 54 Mbps	2	4	16.9	16.7		19.8	23.5	3.7
	Non HT20, 6 to 54 Mbps	3	4	12.9	13.0	12.8	17.7	23.5	5.8
	Non HT20 Beam Forming, 6 to 54 Mbps	2	7	16.9	16.7		19.8	22.5	2.7
	Non HT20 Beam Forming, 6 to 54 Mbps	3	9	12.9	13.0	12.8	17.7	20.5	2.8
	HT/VHT20, M0 to M7	1	4	21.9			21.9	23.6	1.7
	HT/VHT20, M0 to M7	2	4	17.3	17.2		20.3	23.6	3.3
	HT/VHT20, M8 to M15	2	4	18.7	18.6		21.7	23.6	1.9
	HT/VHT20, M0 to M7	3	4	13.3	13.4	13.2	18.1	23.6	5.5
	HT/VHT20, M8 to M15	3	4	16.4	16.2	15.7	20.9	23.6	2.7
	HT/VHT20 Beam Forming, M0 to M7	2	7	17.3	17.2		20.3	22.6	2.3
	HT/VHT20 Beam Forming, M8 to M15	2	4	18.7	18.6		21.7	23.6	1.9
	HT/VHT20 Beam Forming, M0 to M7	3	9	13.3	13.4	13.2	18.1	20.6	2.5
	HT/VHT20 Beam Forming, M8 to M15	3	6	16.4	16.2	15.7	20.9	23.6	2.7
	HT/VHT20 STBC, M0 to M7	2	4	18.7	18.6		21.7	23.6	1.9
	HT/VHT20 STBC, M0 to M7	3	4	16.4	16.2	15.7	20.9	23.6	2.7
5590	Non HT40, 6 to 54 Mbps	1	4	23.8			23.8	24.0	0.2
	Non HT40, 6 to 54 Mbps	2	4	19.6	19.9		22.8	24.0	1.2
	Non HT40, 6 to 54 Mbps	3	4	16.4	16.2	15.3	20.8	24.0	3.2
	HT/VHT40, M0 to M7	1	4	23.8			23.8	24.0	0.2
	HT/VHT40, M0 to M7	2	4	20.2	20.0		23.1	24.0	0.9
	<b>HT/VHT40, M8 to M15</b>	<b>2</b>	<b>4</b>	<b>21.0</b>	<b>20.8</b>		<b>23.9</b>	<b>24.0</b>	<b>0.1</b>
	HT/VHT40, M0 to M7	3	4	16.3	16.1	15.5	20.8	24.0	3.2
	HT/VHT40, M8 to M15	3	4	18.6	18.4	18.8	23.4	24.0	0.6
	HT/VHT40 Beam Forming, M0 to M7	2	7	18.3	18.1		21.2	23.0	1.8
	HT/VHT40 Beam Forming, M8 to M15	2	4	21.0	20.8		23.9	24.0	0.1
	HT/VHT40 Beam Forming, M0 to M7	3	9	13.2	13.0	13.1	17.9	21.0	3.1



	HT/VHT40 Beam Forming, M8 to M15	3	6	17.3	17.1	16.7	21.8	24.0	2.2
	HT/VHT40 STBC, M0 to M7	2	4	21.0	20.8		23.9	24.0	0.1
	HT/VHT40 STBC, M0 to M7	3	4	18.6	18.4	18.8	23.4	24.0	0.6
5610	Non HT80, 6 to 54 Mbps	1	4	23.0			23.0	24.0	1.0
	Non HT80, 6 to 54 Mbps	2	4	14.9	15.8		18.4	24.0	5.6
	Non HT80, 6 to 54 Mbps	3	4	14.9	15.8	16.4	20.5	24.0	3.5
	VHT80, M0 to M9 1ss	1	4	23.2			23.2	24.0	0.8
	VHT80, M0 to M9 1ss	2	4	20.9	20.6		23.8	24.0	0.2
	VHT80, M0 to M9 2ss	2	4	20.9	20.6		23.8	24.0	0.2
	VHT80, M0 to M9 1ss	3	4	18.4	18.5	18.8	23.3	24.0	0.7
	VHT80, M0 to M9 2ss	3	4	18.4	18.5	18.8	23.3	24.0	0.7
	VHT80 Beam Forming, M0 to M9 1ss	2	7	18.4	18.5		21.5	23.0	1.5
	VHT80 Beam Forming, M0 to M9 2ss	2	4	20.9	20.6		23.8	24.0	0.2
	VHT80 Beam Forming, M0 to M9 1ss	3	9	14.2	14.2	13.9	18.9	21.0	2.1
	VHT80 Beam Forming, M0 to M9 2ss	3	6	17.0	17.3	16.5	21.7	24.0	2.3
	VHT80 STBC, M0 to M9 1ss	2	4	20.9	20.6		23.8	24.0	0.2
VHT80 STBC, M0 to M9 1ss	3	4	18.4	18.5	18.8	23.3	24.0	0.7	
5690	Non HT80, 6 to 54 Mbps	1	4	22.0			22.0	24.0	2.0
	Non HT80, 6 to 54 Mbps	2	4	14.1	14.7		17.4	24.0	6.6
	Non HT80, 6 to 54 Mbps	3	4	14.1	14.7	14.9	19.4	24.0	4.6
	VHT80, M0 to M9 1ss	1	4	23.5			23.5	24.0	0.5
	VHT80, M0 to M9 1ss	2	4	20.4	20.7		23.6	24.0	0.4
	VHT80, M0 to M9 2ss	2	4	20.4	20.7		23.6	24.0	0.4
	VHT80, M0 to M9 1ss	3	4	18.1	18.8	18.5	23.2	24.0	0.8
	VHT80, M0 to M9 2ss	3	4	18.1	18.8	18.5	23.2	24.0	0.8
	VHT80 Beam Forming, M0 to M9 1ss	2	7	18.1	18.8		21.5	23.0	1.5
	VHT80 Beam Forming, M0 to M9 2ss	2	4	20.4	20.7		23.6	24.0	0.4
	VHT80 Beam Forming, M0 to M9 1ss	3	9	14.9	15.2	15.0	19.8	21.0	1.2
	VHT80 Beam Forming, M0 to M9 2ss	3	6	17.8	17.8	17.6	22.5	24.0	1.5
	VHT80 STBC, M0 to M9 1ss	2	4	20.4	20.7		23.6	24.0	0.4
VHT80 STBC, M0 to M9 1ss	3	4	18.1	18.8	18.5	23.2	24.0	0.8	
5710	Non HT40, 6 to 54 Mbps	1	4	23.7			23.7	24.0	0.3
	Non HT40, 6 to 54 Mbps	2	4	19.3	19.6		22.5	24.0	1.5
	Non HT40, 6 to 54 Mbps	3	4	16.0	14.6	15.0	20.0	24.0	4.0
	HT/VHT40, M0 to M7	1	4	23.9			23.9	24.0	0.1
	HT/VHT40, M0 to M7	2	4	19.7	19.4		22.6	24.0	1.4
	HT/VHT40, M8 to M15	2	4	20.6	20.3		23.5	24.0	0.5
	HT/VHT40, M0 to M7	3	4	16.9	15.9	16.4	21.2	24.0	2.8
	HT/VHT40, M8 to M15	3	4	18.3	18.4	18.6	23.2	24.0	0.8
	HT/VHT40 Beam Forming, M0 to M7	2	7	19.7	19.4		22.6	23.0	0.4



	HT/VHT40 Beam Forming, M8 to M15	2	4	20.6	20.3		23.5	24.0	0.5
	HT/VHT40 Beam Forming, M0 to M7	3	9	14.9	14.7	15.0	19.6	21.0	1.4
	HT/VHT40 Beam Forming, M8 to M15	3	6	18.0	17.3	17.7	22.4	24.0	1.6
	HT/VHT40 STBC, M0 to M7	2	4	20.6	20.3		23.5	24.0	0.5
	HT/VHT40 STBC, M0 to M7	3	4	18.3	18.4	18.6	23.2	24.0	0.8
5720	Non HT20, 6 to 54 Mbps	1	4	21.4			21.4	23.5	2.1
	Non HT20, 6 to 54 Mbps	2	4	17.7	17.0		20.4	23.5	3.1
	Non HT20, 6 to 54 Mbps	3	4	13.9	13.4	13.4	18.3	23.5	5.2
	Non HT20 Beam Forming, 6 to 54 Mbps	2	7	17.7	17.0		20.4	22.5	2.1
	Non HT20 Beam Forming, 6 to 54 Mbps	3	9	13.9	13.4	13.4	18.3	20.5	2.2
	HT/VHT20, M0 to M7	1	4	21.5			21.5	23.6	2.1
	HT/VHT20, M0 to M7	2	4	17.9	17.2		20.6	23.6	3.0
	HT/VHT20, M8 to M15	2	4	18.8	18.6		21.7	23.6	1.9
	HT/VHT20, M0 to M7	3	4	14.1	13.6	13.5	18.5	23.6	5.1
	HT/VHT20, M8 to M15	3	4	17.0	16.0	15.9	21.1	23.6	2.5
	HT/VHT20 Beam Forming, M0 to M7	2	7	17.9	17.2		20.6	22.6	2.0
	HT/VHT20 Beam Forming, M8 to M15	2	4	18.8	18.6		21.7	23.6	1.9
	HT/VHT20 Beam Forming, M0 to M7	3	9	14.1	13.6	13.5	18.5	20.6	2.1
	HT/VHT20 Beam Forming, M8 to M15	3	6	17.0	16.0	15.9	21.1	23.6	2.5
	HT/VHT20 STBC, M0 to M7	2	4	18.8	18.6		21.7	23.6	1.9
	HT/VHT20 STBC, M0 to M7	3	4	17.0	16.0	15.9	21.1	23.6	2.5

**Peak Output Power, 5590 MHz, HT/VHT40, M8 to M15**



**Antenna A**



**Antenna B**



**Antenna Gain: 10 dBi**

Frequency (MHz)	Mode	Tx Paths	Correlated Antenna Gain (dBi)	Tx 1 Max Power (dBm)	Tx 2 Max Power (dBm)	Tx 3 Max Power (dBm)	Total Tx Channel Power (dBm)	Limit (dBm)	Margin (dB)
5500	Non HT20, 6 to 54 Mbps	1	10	16.7			16.7	19.5	2.8
	Non HT20, 6 to 54 Mbps	2	10	14.0	13.5		16.8	19.5	2.7
	Non HT20, 6 to 54 Mbps	3	10	11.0	10.5	10.4	15.4	19.5	4.1
	Non HT20 Beam Forming, 6 to 54 Mbps	2	10	14.0	13.5		16.8	19.5	2.7
	Non HT20 Beam Forming, 6 to 54 Mbps	3	13	9.2	8.5	8.6	13.5	16.5	3.0
	HT/VHT20, M0 to M7	1	10	16.0			16.0	19.6	3.6
	HT/VHT20, M0 to M7	2	10	14.2	13.7		17.0	19.6	2.6
	HT/VHT20, M8 to M15	2	10	14.2	13.7		17.0	19.6	2.6
	HT/VHT20, M0 to M7	3	10	11.2	10.7	10.7	15.6	19.6	4.0
	HT/VHT20, M8 to M15	3	10	12.9	12.5	12.4	17.4	19.6	2.2
	HT/VHT20 Beam Forming, M0 to M7	2	10	14.2	13.7		17.0	19.6	2.6
	HT/VHT20 Beam Forming, M8 to M15	2	10	14.2	13.7		17.0	19.6	2.6
	HT/VHT20 Beam Forming, M0 to M7	3	13	10.3	9.7	9.7	14.7	16.6	1.9
	HT/VHT20 Beam Forming, M8 to M15	3	10	12.9	12.5	12.4	17.4	19.6	2.2
	HT/VHT20 STBC, M0 to M7	2	10	14.2	13.7		17.0	19.6	2.6
	HT/VHT20 STBC, M0 to M7	3	10	12.9	12.5	12.4	17.4	19.6	2.2
5510	Non HT40, 6 to 54 Mbps	1	10	9.3			9.3	20.0	10.7
	Non HT40, 6 to 54 Mbps	2	10	6.8	6.7		9.8	20.0	10.2
	Non HT40, 6 to 54 Mbps	3	10	5.2	4.9	5.9	10.1	20.0	9.9
	HT/VHT40, M0 to M7	1	10	13.9			13.9	20.0	6.1
	HT/VHT40, M0 to M7	2	10	10.9	10.6		13.8	20.0	6.2
	HT/VHT40, M8 to M15	2	10	10.9	10.6		13.8	20.0	6.2
	HT/VHT40, M0 to M7	3	10	9.2	8.9	8.9	13.8	20.0	6.2
	HT/VHT40, M8 to M15	3	10	9.2	8.9	8.9	13.8	20.0	6.2
	HT/VHT40 Beam Forming, M0 to M7	2	10	10.9	10.6		13.8	20.0	6.2
	HT/VHT40 Beam Forming, M8 to M15	2	10	10.9	10.6		13.8	20.0	6.2
	HT/VHT40 Beam Forming, M0 to M7	3	13	4.5	4.2	4.7	9.2	17.0	7.8
	HT/VHT40 Beam Forming, M8 to M15	3	10	9.2	8.9	8.9	13.8	20.0	6.2
	HT/VHT40 STBC, M0 to M7	2	10	10.9	10.6		13.8	20.0	6.2
	HT/VHT40 STBC, M0 to M7	3	10	9.2	8.9	8.9	13.8	20.0	6.2





5530	Non HT80, 6 to 54 Mbps	1	10	12.1			12.1	20.0	7.9
	Non HT80, 6 to 54 Mbps	2	10	10.2	10.6		13.4	20.0	6.6
	Non HT80, 6 to 54 Mbps	3	10	6.2	6.8	6.9	11.4	20.0	8.6
	VHT80, M0 to M9 1ss	1	10	12.6			12.6	20.0	7.4
	VHT80, M0 to M9 1ss	2	10	10.8	11.1		14.0	20.0	6.0
	VHT80, M0 to M9 2ss	2	10	10.8	11.1		14.0	20.0	6.0
	VHT80, M0 to M9 1ss	3	10	8.9	9.2	9.5	14.0	20.0	6.0
	VHT80, M0 to M9 2ss	3	10	8.9	9.2	9.5	14.0	20.0	6.0
	VHT80 Beam Forming, M0 to M9 1ss	2	10	10.8	11.1		14.0	20.0	6.0
	VHT80 Beam Forming, M0 to M9 2ss	2	10	10.8	11.1		14.0	20.0	6.0
	VHT80 Beam Forming, M0 to M9 1ss	3	13	5.8	6.4	6.5	11.0	17.0	6.0
	VHT80 Beam Forming, M0 to M9 2ss	3	10	8.9	9.2	9.5	14.0	20.0	6.0
	VHT80 STBC, M0 to M9 1ss	2	10	10.8	11.1		14.0	20.0	6.0
	VHT80 STBC, M0 to M9 1ss	3	10	8.9	9.2	9.5	14.0	20.0	6.0
5580	Non HT20, 6 to 54 Mbps	1	10	16.9			16.9	19.5	2.6
	Non HT20, 6 to 54 Mbps	2	10	14.2	13.9		17.1	19.5	2.4
	Non HT20, 6 to 54 Mbps	3	10	11.2	11.0	11.1	15.9	19.5	3.6
	Non HT20 Beam Forming, 6 to 54 Mbps	2	10	14.2	13.9		17.1	19.5	2.4
	Non HT20 Beam Forming, 6 to 54 Mbps	3	13	9.3	9.2	9.2	14.0	16.5	2.5
	HT/VHT20, M0 to M7	1	10	17.3			17.3	19.6	2.3
	HT/VHT20, M0 to M7	2	10	13.3	13.4		16.4	19.6	3.2
	HT/VHT20, M8 to M15	2	10	13.3	13.4		16.4	19.6	3.2
	HT/VHT20, M0 to M7	3	10	11.5	11.3	11.4	16.2	19.6	3.4
	HT/VHT20, M8 to M15	3	10	12.5	12.3	12.3	17.1	19.6	2.5
	HT/VHT20 Beam Forming, M0 to M7	2	10	13.3	13.4		16.4	19.6	3.2
	HT/VHT20 Beam Forming, M8 to M15	2	10	13.3	13.4		16.4	19.6	3.2
	HT/VHT20 Beam Forming, M0 to M7	3	13	9.6	9.5	9.4	14.3	16.6	2.3
	HT/VHT20 Beam Forming, M8 to M15	3	10	12.5	12.3	12.3	17.1	19.6	2.5
	HT/VHT20 STBC, M0 to M7	2	10	13.3	13.4		16.4	19.6	3.2
	HT/VHT20 STBC, M0 to M7	3	10	12.5	12.3	12.3	17.1	19.6	2.5
5590	Non HT40, 6 to 54 Mbps	1	10	17.3			17.3	20.0	2.7
	Non HT40, 6 to 54 Mbps	2	10	16.4	16.2		19.3	20.0	0.7
	Non HT40, 6 to 54 Mbps	3	10	11.6	11.4	11.4	16.2	20.0	3.8
	HT/VHT40, M0 to M7	1	10	18.3			18.3	20.0	1.7
	HT/VHT40, M0 to M7	2	10	16.3	16.1		19.2	20.0	0.8
	HT/VHT40, M8 to M15	2	10	16.3	16.1		19.2	20.0	0.8
	HT/VHT40, M0 to M7	3	10	13.2	13.0	13.1	17.9	20.0	2.1
	HT/VHT40, M8 to M15	3	10	13.2	13.0	13.1	17.9	20.0	2.1
	HT/VHT40 Beam Forming, M0 to M7	2	10	16.3	16.1		19.2	20.0	0.8
	HT/VHT40 Beam Forming, M8 to M15	2	10	16.3	16.1		19.2	20.0	0.8
	HT/VHT40 Beam Forming, M0 to M7	3	13	10.5	10.1	10.1	15.0	17.0	2.0



	HT/VHT40 Beam Forming, M8 to M15	3	10	13.2	13.0	13.1	17.9	20.0	2.1
	HT/VHT40 STBC, M0 to M7	2	10	16.3	16.1		19.2	20.0	0.8
	HT/VHT40 STBC, M0 to M7	3	10	13.2	13.0	13.1	17.9	20.0	2.1
5610	Non HT80, 6 to 54 Mbps	1	10	17.4			17.4	20.0	2.6
	Non HT80, 6 to 54 Mbps	2	10	12.7	11.0		14.9	20.0	5.1
	Non HT80, 6 to 54 Mbps	3	10	9.9	9.9	9.2	14.5	20.0	5.5
	VHT80, M0 to M9 1ss	1	10	18.4			18.4	20.0	1.6
	VHT80, M0 to M9 1ss	2	10	16.0	16.2		19.1	20.0	0.9
	VHT80, M0 to M9 2ss	2	10	16.0	16.2		19.1	20.0	0.9
	VHT80, M0 to M9 1ss	3	10	13.0	13.1	12.8	17.7	20.0	2.3
	VHT80, M0 to M9 2ss	3	10	13.0	13.1	12.8	17.7	20.0	2.3
	VHT80 Beam Forming, M0 to M9 1ss	2	10	16.0	16.2		19.1	20.0	0.9
	VHT80 Beam Forming, M0 to M9 2ss	2	10	16.0	16.2		19.1	20.0	0.9
	VHT80 Beam Forming, M0 to M9 1ss	3	13	10.2	10.2	10.1	14.9	17.0	2.1
	VHT80 Beam Forming, M0 to M9 2ss	3	10	13.0	13.1	12.8	17.7	20.0	2.3
	VHT80 STBC, M0 to M9 1ss	2	10	16.0	16.2		19.1	20.0	0.9
VHT80 STBC, M0 to M9 1ss	3	10	13.0	13.1	12.8	17.7	20.0	2.3	
5690	Non HT80, 6 to 54 Mbps	1	10	16.1			16.1	20.0	3.9
	Non HT80, 6 to 54 Mbps	2	10	11.3	10.3		13.8	20.0	6.2
	Non HT80, 6 to 54 Mbps	3	10	9.5	9.7	9.5	14.3	20.0	5.7
	VHT80, M0 to M9 1ss	1	10	18.1			18.1	20.0	1.9
	VHT80, M0 to M9 1ss	2	10	15.9	16.4		19.2	20.0	0.8
	VHT80, M0 to M9 2ss	2	10	15.9	16.4		19.2	20.0	0.8
	VHT80, M0 to M9 1ss	3	10	12.7	13.0	12.7	17.6	20.0	2.4
	VHT80, M0 to M9 2ss	3	10	12.7	13.0	12.7	17.6	20.0	2.4
	VHT80 Beam Forming, M0 to M9 1ss	2	10	15.9	16.4		19.2	20.0	0.8
	VHT80 Beam Forming, M0 to M9 2ss	2	10	15.9	16.4		19.2	20.0	0.8
	VHT80 Beam Forming, M0 to M9 1ss	3	13	10.9	10.9	11.0	15.7	17.0	1.3
	VHT80 Beam Forming, M0 to M9 2ss	3	10	12.7	13.0	12.7	17.6	20.0	2.4
	VHT80 STBC, M0 to M9 1ss	2	10	15.9	16.4		19.2	20.0	0.8
VHT80 STBC, M0 to M9 1ss	3	10	12.7	13.0	12.7	17.6	20.0	2.4	
5710	Non HT40, 6 to 54 Mbps	1	10	19.3			19.3	20.0	0.7
	Non HT40, 6 to 54 Mbps	2	10	16.0	14.6		18.4	20.0	1.6
	Non HT40, 6 to 54 Mbps	3	10	12.3	11.8	12.1	16.8	20.0	3.2
	<b>HT/VHT40, M0 to M7</b>	<b>1</b>	<b>10</b>	<b>19.7</b>			<b>19.7</b>	<b>20.0</b>	<b>0.3</b>
	HT/VHT40, M0 to M7	2	10	16.0	15.8		18.9	20.0	1.1
	HT/VHT40, M8 to M15	2	10	16.0	15.8		18.9	20.0	1.1
	HT/VHT40, M0 to M7	3	10	12.7	12.4	12.8	17.4	20.0	2.6
	HT/VHT40, M8 to M15	3	10	12.7	12.4	12.8	17.4	20.0	2.6
HT/VHT40 Beam Forming, M0 to M7	2	10	16.0	15.8		18.9	20.0	1.1	



	HT/VHT40 Beam Forming, M8 to M15	2	10	16.0	15.8		18.9	20.0	1.1
	HT/VHT40 Beam Forming, M0 to M7	3	13	10.0	9.4	10.0	14.6	17.0	2.4
	HT/VHT40 Beam Forming, M8 to M15	3	10	12.7	12.4	12.8	17.4	20.0	2.6
	HT/VHT40 STBC, M0 to M7	2	10	16.0	15.8		18.9	20.0	1.1
	HT/VHT40 STBC, M0 to M7	3	10	12.7	12.4	12.8	17.4	20.0	2.6
5720	Non HT20, 6 to 54 Mbps	1	10	16.8			16.8	19.5	2.7
	Non HT20, 6 to 54 Mbps	2	10	13.9	13.4		16.7	19.5	2.8
	Non HT20, 6 to 54 Mbps	3	10	11.9	11.6	11.6	16.5	19.5	3.0
	Non HT20 Beam Forming, 6 to 54 Mbps	2	10	13.9	13.4		16.7	19.5	2.8
	Non HT20 Beam Forming, 6 to 54 Mbps	3	13	10.1	9.5	9.5	14.5	16.5	2.0
	HT/VHT20, M0 to M7	1	10	17.0			17.0	19.6	2.6
	HT/VHT20, M0 to M7	2	10	14.1	13.6		16.9	19.6	2.7
	HT/VHT20, M8 to M15	2	10	14.1	13.6		16.9	19.6	2.7
	HT/VHT20, M0 to M7	3	10	11.9	11.7	11.6	16.5	19.6	3.1
	HT/VHT20, M8 to M15	3	10	12.9	12.5	12.5	17.4	19.6	2.2
	HT/VHT20 Beam Forming, M0 to M7	2	10	14.1	13.6		16.9	19.6	2.7
	HT/VHT20 Beam Forming, M8 to M15	2	10	14.1	13.6		16.9	19.6	2.7
	HT/VHT20 Beam Forming, M0 to M7	3	13	9.1	8.6	8.7	13.6	16.6	3.0
	HT/VHT20 Beam Forming, M8 to M15	3	10	12.9	12.5	12.5	17.4	19.6	2.2
	HT/VHT20 STBC, M0 to M7	2	10	14.1	13.6		16.9	19.6	2.7
HT/VHT20 STBC, M0 to M7	3	10	12.9	12.5	12.5	17.4	19.6	2.2	

**Peak Output Power, 5710 MHz, HT/VHT40, M0 to M7**

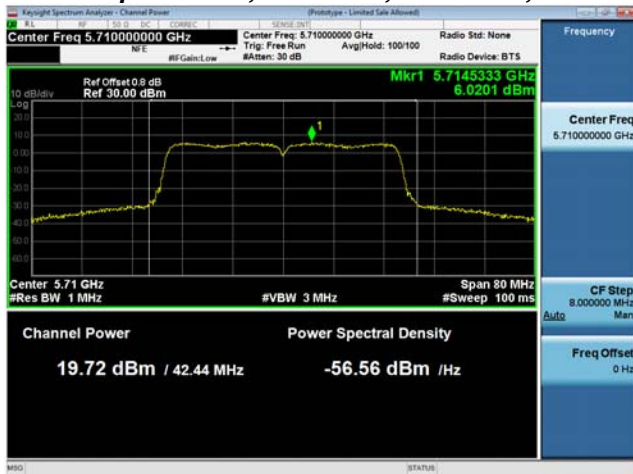

**Antenna A**



**Antenna Gain: 4 dBi**

Frequency (MHz)	Mode	Tx Paths	Correlated Antenna Gain (dBi)	Tx 1 PSD (dBm/MHz)	Tx 2 PSD (dBm/MHz)	Tx 3 PSD (dBm/MHz)	Total PSD (dBm/MHz)	Limit (dBm/MHz)	Margin (dB)
5500	Non HT20, 6 to 54 Mbps	1	4	7.8			7.8	11.0	3.2
	<b>Non HT20, 6 to 54 Mbps</b>	<b>2</b>	<b>7</b>	<b>7.3</b>	<b>6.6</b>		<b>10.0</b>	<b>10.0</b>	<b>0.0</b>
	Non HT20, 6 to 54 Mbps	3	9	2.2	1.7	1.6	6.6	8.0	1.4
	Non HT20 Beam Forming, 6 to 54 Mbps	2	7	6.1	5.5		8.8	10.0	1.2
	Non HT20 Beam Forming, 6 to 54 Mbps	3	9	2.2	1.7	1.6	6.6	8.0	1.4
	HT/VHT20, M0 to M7	1	4	7.7			7.7	11.0	3.3
	HT/VHT20, M0 to M7	2	7	7.3	6.5		9.9	10.0	0.1
	HT/VHT20, M8 to M15	2	4	7.3	6.5		9.9	11.0	1.1
	HT/VHT20, M0 to M7	3	9	3.4	3.0	2.6	7.8	8.0	0.2
	HT/VHT20, M8 to M15	3	6	6.1	5.7	5.8	10.6	11.0	0.4
	HT/VHT20 Beam Forming, M0 to M7	2	7	5.3	4.6		8.0	10.0	2.0
	HT/VHT20 Beam Forming, M8 to M15	2	4	7.3	6.5		9.9	11.0	1.1
	HT/VHT20 Beam Forming, M0 to M7	3	9	2.1	2.2	1.5	6.7	8.0	1.3
	HT/VHT20 Beam Forming, M8 to M15	3	6	5.3	4.6	5.2	9.8	11.0	1.2
	HT/VHT20 STBC, M0 to M7	2	4	7.3	6.5		9.9	11.0	1.1
HT/VHT20 STBC, M0 to M7	3	6	6.1	5.7	5.8	10.6	11.0	0.4	
5510	Non HT40, 6 to 54 Mbps	1	4	-0.5			-0.5	11.0	11.5
	Non HT40, 6 to 54 Mbps	2	7	-1.3	-1.2		1.8	10.0	8.2
	Non HT40, 6 to 54 Mbps	3	9	-3.4	-3.4	-3.3	1.4	8.0	6.6
	HT/VHT40, M0 to M7	1	4	2.8			2.8	11.0	8.2
	HT/VHT40, M0 to M7	2	7	1.3	0.9		4.1	10.0	5.9
	HT/VHT40, M8 to M15	2	4	1.3	0.9		4.1	11.0	6.9
	HT/VHT40, M0 to M7	3	9	0.2	0.2	0.2	5.0	8.0	3.0
	HT/VHT40, M8 to M15	3	6	0.2	0.2	0.2	5.0	11.0	6.0
	HT/VHT40 Beam Forming, M0 to M7	2	7	-1.0	-1.3		1.9	10.0	8.1
	HT/VHT40 Beam Forming, M8 to M15	2	4	1.3	0.9		4.1	11.0	6.9
	HT/VHT40 Beam Forming, M0 to M7	3	9	-3.6	-3.9	-3.6	1.1	8.0	6.9
	HT/VHT40 Beam Forming, M8 to M15	3	6	-1.8	-2.3	-2.2	2.7	11.0	8.3
	HT/VHT40 STBC, M0 to M7	2	4	1.3	0.9		4.1	11.0	6.9
	HT/VHT40 STBC, M0 to M7	3	6	0.2	0.2	0.2	5.0	11.0	6.0



5530	Non HT80, 6 to 54 Mbps	1	4	-2.0			-2.0	11.0	13.0
	Non HT80, 6 to 54 Mbps	2	7	-3.6	-3.4		-0.5	10.0	10.5
	Non HT80, 6 to 54 Mbps	3	9	-4.2	-4.1	-4.9	0.4	8.0	7.6
	VHT80, M0 to M9 1ss	1	4	-1.6			-1.6	11.0	12.6
	VHT80, M0 to M9 1ss	2	7	-2.7	-2.2		0.6	10.0	9.4
	VHT80, M0 to M9 2ss	2	4	-2.7	-2.2		0.6	11.0	10.4
	VHT80, M0 to M9 1ss	3	9	-4.7	-4.7	-3.7	0.4	8.0	7.6
	VHT80, M0 to M9 2ss	3	6	-4.7	-4.7	-3.7	0.4	11.0	10.6
	VHT80 Beam Forming, M0 to M9 1ss	2	7	-4.7	-4.7		-1.7	10.0	11.7
	VHT80 Beam Forming, M0 to M9 2ss	2	4	-2.7	-2.2		0.6	11.0	10.4
	VHT80 Beam Forming, M0 to M9 1ss	3	9	-7.4	-7.1	-6.6	-2.2	8.0	10.2
	VHT80 Beam Forming, M0 to M9 2ss	3	6	-5.6	-5.3	-4.7	-0.4	11.0	11.4
	VHT80 STBC, M0 to M9 1ss	2	4	-2.7	-2.2		0.6	11.0	10.4
	VHT80 STBC, M0 to M9 1ss	3	4	-4.7	-4.7	-3.7	0.4	11.0	10.6
5580	Non HT20, 6 to 54 Mbps	1	4	10.8			10.8	11.0	0.2
	Non HT20, 6 to 54 Mbps	2	7	6.6	6.0		9.3	10.0	0.7
	Non HT20, 6 to 54 Mbps	3	9	2.3	2.5	2.4	7.2	8.0	0.8
	Non HT20 Beam Forming, 6 to 54 Mbps	2	7	6.6	6.0		9.3	10.0	0.7
	Non HT20 Beam Forming, 6 to 54 Mbps	3	9	2.3	2.5	2.4	7.2	8.0	0.8
	HT/VHT20, M0 to M7	1	4	11.0			11.0	11.0	0.0
	HT/VHT20, M0 to M7	2	7	6.5	6.6		9.6	10.0	0.4
	HT/VHT20, M8 to M15	2	4	7.9	7.8		10.9	11.0	0.1
	HT/VHT20, M0 to M7	3	9	2.3	2.6	2.6	7.3	8.0	0.7
	HT/VHT20, M8 to M15	3	6	5.6	5.3	5.0	10.1	11.0	0.9
	HT/VHT20 Beam Forming, M0 to M7	2	7	6.5	6.6		9.6	10.0	0.4
	HT/VHT20 Beam Forming, M8 to M15	2	4	7.9	7.8		10.9	11.0	0.1
	HT/VHT20 Beam Forming, M0 to M7	3	9	2.3	2.6	2.6	7.3	8.0	0.7
	HT/VHT20 Beam Forming, M8 to M15	3	6	5.6	5.3	5.0	10.1	11.0	0.9
	HT/VHT20 STBC, M0 to M7	2	4	7.9	7.8		10.9	11.0	0.1
	HT/VHT20 STBC, M0 to M7	3	6	5.6	5.3	5.0	10.1	11.0	0.9
5590	Non HT40, 6 to 54 Mbps	1	4	10.5			10.5	11.0	0.5
	Non HT40, 6 to 54 Mbps	2	7	6.2	6.7		9.5	10.0	0.5
	Non HT40, 6 to 54 Mbps	3	9	3.0	3.0	2.1	7.5	8.0	0.5
	HT/VHT40, M0 to M7	1	4	10.0			10.0	11.0	1.0
	HT/VHT40, M0 to M7	2	7	6.6	6.7		9.7	10.0	0.3
	HT/VHT40, M8 to M15	2	4	7.3	7.2		10.3	11.0	0.7
	HT/VHT40, M0 to M7	3	9	2.7	2.6	2.0	7.2	8.0	0.8
	HT/VHT40, M8 to M15	3	6	5.0	5.0	5.7	10.0	11.0	1.0
	HT/VHT40 Beam Forming, M0 to M7	2	7	4.8	4.6		7.7	10.0	2.3
	HT/VHT40 Beam Forming, M8 to M15	2	4	7.3	7.2		10.3	11.0	0.7
	HT/VHT40 Beam Forming, M0 to M7	3	9	-0.5	-0.6	-0.5	4.2	8.0	3.8



	HT/VHT40 Beam Forming, M8 to M15	3	6	3.4	3.4	3.8	8.3	11.0	2.7
	HT/VHT40 STBC, M0 to M7	2	4	7.3	7.2		10.3	11.0	0.7
	HT/VHT40 STBC, M0 to M7	3	6	5.0	5.0	5.7	10.0	11.0	1.0
5610	Non HT80, 6 to 54 Mbps	1	4	6.5			6.5	11.0	4.5
	Non HT80, 6 to 54 Mbps	2	7	-1.7	-0.3		2.1	10.0	7.9
	Non HT80, 6 to 54 Mbps	3	9	-1.7	-0.3	-0.3	4.1	8.0	3.9
	VHT80, M0 to M9 1ss	1	4	6.1			6.1	11.0	4.9
	VHT80, M0 to M9 1ss	2	7	3.8	3.8		6.8	10.0	3.2
	VHT80, M0 to M9 2ss	2	4	3.8	3.8		6.8	11.0	4.2
	VHT80, M0 to M9 1ss	3	9	1.4	1.6	1.6	6.3	8.0	1.7
	VHT80, M0 to M9 2ss	3	6	1.4	1.6	1.6	6.3	11.0	4.7
	VHT80 Beam Forming, M0 to M9 1ss	2	7	1.4	1.6		4.5	10.0	5.5
	VHT80 Beam Forming, M0 to M9 2ss	2	4	3.8	3.8		6.8	11.0	4.2
	VHT80 Beam Forming, M0 to M9 1ss	3	9	-3.3	-2.8	-3.5	1.6	8.0	6.4
	VHT80 Beam Forming, M0 to M9 2ss	3	6	-0.2	0.4	-0.6	4.7	11.0	6.3
	VHT80 STBC, M0 to M9 1ss	2	4	3.8	3.8		6.8	11.0	4.2
VHT80 STBC, M0 to M9 1ss	3	4	1.4	1.6	1.6	6.3	11.0	4.7	
5690	Non HT80, 6 to 54 Mbps	1	4	5.2			5.2	11.0	5.8
	Non HT80, 6 to 54 Mbps	2	7	-2.9	-2.0		0.6	10.0	9.4
	Non HT80, 6 to 54 Mbps	3	9	-2.9	-2.0	-1.6	2.6	8.0	5.4
	VHT80, M0 to M9 1ss	1	4	6.2			6.2	11.0	4.8
	VHT80, M0 to M9 1ss	2	7	3.0	3.8		6.4	10.0	3.6
	VHT80, M0 to M9 2ss	2	4	3.0	3.8		6.4	11.0	4.6
	VHT80, M0 to M9 1ss	3	9	0.8	1.7	1.6	6.2	8.0	1.8
	VHT80, M0 to M9 2ss	3	6	0.8	1.7	1.6	6.2	11.0	4.8
	VHT80 Beam Forming, M0 to M9 1ss	2	7	0.8	1.7		4.3	10.0	5.7
	VHT80 Beam Forming, M0 to M9 2ss	2	4	3.0	3.8		6.4	11.0	4.6
	VHT80 Beam Forming, M0 to M9 1ss	3	9	-2.7	-2.0	-1.6	2.7	8.0	5.3
	VHT80 Beam Forming, M0 to M9 2ss	3	6	0.8	0.9	0.5	5.5	11.0	5.5
	VHT80 STBC, M0 to M9 1ss	2	4	3.0	3.8		6.4	11.0	4.6
VHT80 STBC, M0 to M9 1ss	3	4	0.8	1.7	1.6	6.2	11.0	4.8	
5710	Non HT40, 6 to 54 Mbps	1	4	10.3			10.3	11.0	0.7
	Non HT40, 6 to 54 Mbps	2	7	6.1	6.2		9.2	10.0	0.8
	Non HT40, 6 to 54 Mbps	3	9	2.5	1.5	1.9	6.8	8.0	1.2
	HT/VHT40, M0 to M7	1	4	10.1			10.1	11.0	0.9
	HT/VHT40, M0 to M7	2	7	6.0	5.7		8.9	10.0	1.1
	HT/VHT40, M8 to M15	2	4	7.3	6.9		10.1	11.0	0.9
	HT/VHT40, M0 to M7	3	9	3.2	2.3	2.7	7.5	8.0	0.5
	HT/VHT40, M8 to M15	3	6	4.4	5.1	5.0	9.6	11.0	1.4
	HT/VHT40 Beam Forming, M0 to M7	2	7	6.0	5.7		8.9	10.0	1.1



	HT/VHT40 Beam Forming, M8 to M15	2	4	7.3	6.9		10.1	11.0	0.9
	HT/VHT40 Beam Forming, M0 to M7	3	9	1.3	0.9	1.7	6.1	8.0	1.9
	HT/VHT40 Beam Forming, M8 to M15	3	6	4.4	3.8	4.1	8.9	11.0	2.1
	HT/VHT40 STBC, M0 to M7	2	4	7.3	6.9		10.1	11.0	0.9
	HT/VHT40 STBC, M0 to M7	3	6	4.4	5.1	5.0	9.6	11.0	1.4
5720	Non HT20, 6 to 54 Mbps	1	4	10.7			10.7	11.0	0.3
	Non HT20, 6 to 54 Mbps	2	7	7.2	6.5		9.9	10.0	0.1
	Non HT20, 6 to 54 Mbps	3	9	3.5	2.7	2.8	7.8	8.0	0.2
	Non HT20 Beam Forming, 6 to 54 Mbps	2	7	7.2	6.5		9.9	10.0	0.1
	Non HT20 Beam Forming, 6 to 54 Mbps	3	9	3.5	2.7	2.8	7.8	8.0	0.2
	HT/VHT20, M0 to M7	1	4	10.7			10.7	11.0	0.3
	HT/VHT20, M0 to M7	2	7	7.3	6.5		9.9	10.0	0.1
	HT/VHT20, M8 to M15	2	4	7.9	7.9		10.9	11.0	0.1
	HT/VHT20, M0 to M7	3	9	3.5	2.7	2.7	7.8	8.0	0.2
	HT/VHT20, M8 to M15	3	6	6.1	5.7	5.2	10.5	11.0	0.5
	HT/VHT20 Beam Forming, M0 to M7	2	7	7.3	6.5		9.9	10.0	0.1
	HT/VHT20 Beam Forming, M8 to M15	2	4	7.9	7.9		10.9	11.0	0.1
	HT/VHT20 Beam Forming, M0 to M7	3	9	3.5	2.7	2.7	7.8	8.0	0.2
	HT/VHT20 Beam Forming, M8 to M15	3	6	6.1	5.7	5.2	10.5	11.0	0.5
	HT/VHT20 STBC, M0 to M7	2	4	7.9	7.9		10.9	11.0	0.1
	HT/VHT20 STBC, M0 to M7	3	6	6.1	5.7	5.2	10.5	11.0	0.5



**Power Spectral Density, 5580 MHz, HT/VHT20, M0 to M7**



**Antenna A**



**Antenna Gain: 10 dBi**

Frequency (MHz)	Mode	Tx Paths	Correlated Antenna Gain (dBi)	Tx 1 PSD (dBm/MHz)	Tx 2 PSD (dBm/MHz)	Tx 3 PSD (dBm/MHz)	Total PSD (dBm/MHz)	Limit (dBm/MHz)	Margin (dB)
5500	Non HT20, 6 to 54 Mbps	1	10	6.1			6.1	7.0	0.9
	Non HT20, 6 to 54 Mbps	2	10	3.6	3.0		6.3	7.0	0.7
	Non HT20, 6 to 54 Mbps	3	10	0.6	-0.1	-0.3	4.9	7.0	2.1
	Non HT20 Beam Forming, 6 to 54 Mbps	2	10	3.6	3.0		6.3	7.0	0.7
	Non HT20 Beam Forming, 6 to 54 Mbps	3	13	-1.3	-1.9	-1.8	3.1	4.0	0.9
	HT/VHT20, M0 to M7	1	10	5.3			5.3	7.0	1.7
	HT/VHT20, M0 to M7	2	10	3.4	3.0		6.2	7.0	0.8
	HT/VHT20, M8 to M15	2	10	3.4	3.0		6.2	7.0	0.8
	HT/VHT20, M0 to M7	3	10	0.6	-0.1	-0.3	4.9	7.0	2.1
	HT/VHT20, M8 to M15	3	10	2.1	2.2	1.5	6.7	7.0	0.3
	HT/VHT20 Beam Forming, M0 to M7	2	10	3.4	3.0		6.2	7.0	0.8
	HT/VHT20 Beam Forming, M8 to M15	2	10	3.4	3.0		6.2	7.0	0.8
	<b>HT/VHT20 Beam Forming, M0 to M7</b>	<b>3</b>	<b>13</b>	<b>-0.5</b>	<b>-1.0</b>	<b>-1.1</b>	<b>3.9</b>	<b>4.0</b>	<b>0.1</b>
	HT/VHT20 Beam Forming, M8 to M15	3	10	2.1	2.2	1.5	6.7	7.0	0.3
	HT/VHT20 STBC, M0 to M7	2	10	3.4	3.0		6.2	7.0	0.8
HT/VHT20 STBC, M0 to M7	3	10	2.1	2.2	1.5	6.7	7.0	0.3	
5510	Non HT40, 6 to 54 Mbps	1	10	-4.4			-4.4	7.0	11.4
	Non HT40, 6 to 54 Mbps	2	10	-6.4	-6.5		-3.4	7.0	10.4
	Non HT40, 6 to 54 Mbps	3	10	-8.2	-8.5	-7.5	-3.3	7.0	10.3
	HT/VHT40, M0 to M7	1	10	0.2			0.2	7.0	6.8
	HT/VHT40, M0 to M7	2	10	-3.0	-3.1		0.0	7.0	7.0
	HT/VHT40, M8 to M15	2	10	-3.0	-3.1		0.0	7.0	7.0
	HT/VHT40, M0 to M7	3	10	-4.6	-4.5	-4.6	0.2	7.0	6.8
	HT/VHT40, M8 to M15	3	10	-4.6	-4.5	-4.6	0.2	7.0	6.8
	HT/VHT40 Beam Forming, M0 to M7	2	10	-3.0	-3.1		0.0	7.0	7.0
	HT/VHT40 Beam Forming, M8 to M15	2	10	-3.0	-3.1		0.0	7.0	7.0
	HT/VHT40 Beam Forming, M0 to M7	3	13	-8.9	-9.3	-8.9	-4.3	4.0	8.3
	HT/VHT40 Beam Forming, M8 to M15	3	10	-4.6	-4.5	-4.6	0.2	7.0	6.8
	HT/VHT40 STBC, M0 to M7	2	10	-3.0	-3.1		0.0	7.0	7.0
	HT/VHT40 STBC, M0 to M7	3	10	-4.6	-4.5	-4.6	0.2	7.0	6.8



5530	Non HT80, 6 to 54 Mbps	1	10	-4.2			-4.2	7.0	11.2
	Non HT80, 6 to 54 Mbps	2	10	-6.5	-6.2		-3.3	7.0	10.3
	Non HT80, 6 to 54 Mbps	3	10	-10.5	-10.0	-9.5	-5.2	7.0	12.2
	VHT80, M0 to M9 1ss	1	10	-4.7			-4.7	7.0	11.7
	VHT80, M0 to M9 1ss	2	10	-6.3	-6.4		-3.3	7.0	10.3
	VHT80, M0 to M9 2ss	2	10	-6.3	-6.4		-3.3	7.0	10.3
	VHT80, M0 to M9 1ss	3	10	-8.2	-8.3	-7.6	-3.3	7.0	10.3
	VHT80, M0 to M9 2ss	3	10	-8.2	-8.3	-7.6	-3.3	7.0	10.3
	VHT80 Beam Forming, M0 to M9 1ss	2	10	-6.3	-6.4		-3.3	7.0	10.3
	VHT80 Beam Forming, M0 to M9 2ss	2	10	-6.3	-6.4		-3.3	7.0	10.3
	VHT80 Beam Forming, M0 to M9 1ss	3	13	-11.6	-10.9	-10.6	-6.2	4.0	10.2
	VHT80 Beam Forming, M0 to M9 2ss	3	10	-8.2	-8.3	-7.6	-3.3	7.0	10.3
	VHT80 STBC, M0 to M9 1ss	2	10	-6.3	-6.4		-3.3	7.0	10.3
	VHT80 STBC, M0 to M9 1ss	3	10	-8.2	-8.3	-7.6	-3.3	7.0	10.3
5580	Non HT20, 6 to 54 Mbps	1	10	6.6			6.6	7.0	0.4
	Non HT20, 6 to 54 Mbps	2	10	4.0	3.2		6.6	7.0	0.4
	Non HT20, 6 to 54 Mbps	3	10	0.7	0.5	0.6	5.4	7.0	1.6
	Non HT20 Beam Forming, 6 to 54 Mbps	2	10	4.0	3.2		6.6	7.0	0.4
	Non HT20 Beam Forming, 6 to 54 Mbps	3	13	-1.2	-1.4	-0.9	3.6	4.0	0.4
	HT/VHT20, M0 to M7	1	10	6.5			6.5	7.0	0.5
	HT/VHT20, M0 to M7	2	10	2.3	2.6		5.5	7.0	1.5
	HT/VHT20, M8 to M15	2	10	2.3	2.6		5.5	7.0	1.5
	HT/VHT20, M0 to M7	3	10	0.7	0.7	0.8	5.5	7.0	1.5
	HT/VHT20, M8 to M15	3	10	1.6	1.5	1.6	6.3	7.0	0.7
	HT/VHT20 Beam Forming, M0 to M7	2	10	2.3	2.6		5.5	7.0	1.5
	HT/VHT20 Beam Forming, M8 to M15	2	10	2.3	2.6		5.5	7.0	1.5
	HT/VHT20 Beam Forming, M0 to M7	3	13	-1.3	-1.4	-1.4	3.4	4.0	0.6
	HT/VHT20 Beam Forming, M8 to M15	3	10	1.6	1.5	1.6	6.3	7.0	0.7
	HT/VHT20 STBC, M0 to M7	2	10	2.3	2.6		5.5	7.0	1.5
	HT/VHT20 STBC, M0 to M7	3	10	1.6	1.5	1.6	6.3	7.0	0.7
5590	Non HT40, 6 to 54 Mbps	1	10	3.8			3.8	7.0	3.2
	Non HT40, 6 to 54 Mbps	2	10	3.0	3.0		6.0	7.0	1.0
	Non HT40, 6 to 54 Mbps	3	10	-1.6	-1.8	-2.0	3.0	7.0	4.0
	HT/VHT40, M0 to M7	1	10	4.8			4.8	7.0	2.2
	HT/VHT40, M0 to M7	2	10	2.7	2.6		5.7	7.0	1.3
	HT/VHT40, M8 to M15	2	10	2.7	2.6		5.7	7.0	1.3
	HT/VHT40, M0 to M7	3	10	-0.5	-0.6	-0.5	4.2	7.0	2.8
	HT/VHT40, M8 to M15	3	10	-0.5	-0.6	-0.5	4.2	7.0	2.8
	HT/VHT40 Beam Forming, M0 to M7	2	10	2.7	2.6		5.7	7.0	1.3
	HT/VHT40 Beam Forming, M8 to M15	2	10	2.7	2.6		5.7	7.0	1.3
	HT/VHT40 Beam Forming, M0 to M7	3	13	-3.2	-3.2	-3.3	1.5	4.0	2.5



	HT/VHT40 Beam Forming, M8 to M15	3	10	-0.5	-0.6	-0.5	4.2	7.0	2.8
	HT/VHT40 STBC, M0 to M7	2	10	2.7	2.6		5.7	7.0	1.3
	HT/VHT40 STBC, M0 to M7	3	10	-0.5	-0.6	-0.5	4.2	7.0	2.8
5610	Non HT80, 6 to 54 Mbps	1	10	0.5			0.5	7.0	6.5
	Non HT80, 6 to 54 Mbps	2	10	-3.9	-5.3		-1.5	7.0	8.5
	Non HT80, 6 to 54 Mbps	3	10	-6.7	-6.5	-7.4	-2.1	7.0	9.1
	VHT80, M0 to M9 1ss	1	10	1.4			1.4	7.0	5.6
	VHT80, M0 to M9 1ss	2	10	-1.3	-0.7		2.0	7.0	5.0
	VHT80, M0 to M9 2ss	2	10	-1.3	-0.7		2.0	7.0	5.0
	VHT80, M0 to M9 1ss	3	10	-4.3	-3.9	-4.4	0.6	7.0	6.4
	VHT80, M0 to M9 2ss	3	10	-4.3	-3.9	-4.4	0.6	7.0	6.4
	VHT80 Beam Forming, M0 to M9 1ss	2	10	-1.3	-0.7		2.0	7.0	5.0
	VHT80 Beam Forming, M0 to M9 2ss	2	10	-1.3	-0.7		2.0	7.0	5.0
	VHT80 Beam Forming, M0 to M9 1ss	3	13	-6.9	-6.5	-7.1	-2.1	4.0	6.1
	VHT80 Beam Forming, M0 to M9 2ss	3	10	-4.3	-3.9	-4.4	0.6	7.0	6.4
	VHT80 STBC, M0 to M9 1ss	2	10	-1.3	-0.7		2.0	7.0	5.0
VHT80 STBC, M0 to M9 1ss	3	10	-4.3	-3.9	-4.4	0.6	7.0	6.4	
5690	Non HT80, 6 to 54 Mbps	1	10	-0.9			-0.9	7.0	7.9
	Non HT80, 6 to 54 Mbps	2	10	-5.7	-6.3		-3.0	7.0	10.0
	Non HT80, 6 to 54 Mbps	3	10	-7.5	-6.8	-7.2	-2.4	7.0	9.4
	VHT80, M0 to M9 1ss	1	10	0.8			0.8	7.0	6.2
	VHT80, M0 to M9 1ss	2	10	-1.7	-0.8		1.8	7.0	5.2
	VHT80, M0 to M9 2ss	2	10	-1.7	-0.8		1.8	7.0	5.2
	VHT80, M0 to M9 1ss	3	10	-4.2	-4.0	-4.3	0.6	7.0	6.4
	VHT80, M0 to M9 2ss	3	10	-4.2	-4.0	-4.3	0.6	7.0	6.4
	VHT80 Beam Forming, M0 to M9 1ss	2	10	-1.7	-0.8		1.8	7.0	5.2
	VHT80 Beam Forming, M0 to M9 2ss	2	10	-1.7	-0.8		1.8	7.0	5.2
	VHT80 Beam Forming, M0 to M9 1ss	3	13	-6.5	-6.4	-6.3	-1.6	4.0	5.6
	VHT80 Beam Forming, M0 to M9 2ss	3	10	-4.2	-4.0	-4.3	0.6	7.0	6.4
	VHT80 STBC, M0 to M9 1ss	2	10	-1.7	-0.8		1.8	7.0	5.2
VHT80 STBC, M0 to M9 1ss	3	10	-4.2	-4.0	-4.3	0.6	7.0	6.4	
5710	Non HT40, 6 to 54 Mbps	1	10	6.1			6.1	7.0	0.9
	Non HT40, 6 to 54 Mbps	2	10	2.5	1.5		5.0	7.0	2.0
	Non HT40, 6 to 54 Mbps	3	10	-1.0	-1.7	-1.1	3.5	7.0	3.5
	HT/VHT40, M0 to M7	1	10	6.0			6.0	7.0	1.0
	HT/VHT40, M0 to M7	2	10	2.0	2.0		5.0	7.0	2.0
	HT/VHT40, M8 to M15	2	10	2.0	2.0		5.0	7.0	2.0
	HT/VHT40, M0 to M7	3	10	-1.0	-1.2	-1.1	3.7	7.0	3.3
	HT/VHT40, M8 to M15	3	10	-1.0	-1.2	-1.1	3.7	7.0	3.3
HT/VHT40 Beam Forming, M0 to M7	2	10	2.0	2.0		5.0	7.0	2.0	



	HT/VHT40 Beam Forming, M8 to M15	2	10	2.0	2.0		5.0	7.0	2.0
	HT/VHT40 Beam Forming, M0 to M7	3	13	-3.5	-4.5	-3.2	1.1	4.0	2.9
	HT/VHT40 Beam Forming, M8 to M15	3	10	-1.0	-1.2	-1.1	3.7	7.0	3.3
	HT/VHT40 STBC, M0 to M7	2	10	2.0	2.0		5.0	7.0	2.0
	HT/VHT40 STBC, M0 to M7	3	10	-1.0	-1.2	-1.1	3.7	7.0	3.3
5720	Non HT20, 6 to 54 Mbps	1	10	6.5			6.5	7.0	0.5
	Non HT20, 6 to 54 Mbps	2	10	3.5	2.7		6.1	7.0	0.9
	Non HT20, 6 to 54 Mbps	3	10	1.3	1.0	1.2	5.9	7.0	1.1
	Non HT20 Beam Forming, 6 to 54 Mbps	2	10	3.5	2.7		6.1	7.0	0.9
	Non HT20 Beam Forming, 6 to 54 Mbps	3	13	-0.6	-1.1	-0.9	3.9	4.0	0.1
	HT/VHT20, M0 to M7	1	10	6.1			6.1	7.0	0.9
	HT/VHT20, M0 to M7	2	10	3.5	2.7		6.1	7.0	0.9
	HT/VHT20, M8 to M15	2	10	3.5	2.7		6.1	7.0	0.9
	HT/VHT20, M0 to M7	3	10	1.3	0.9	1.2	5.9	7.0	1.1
	HT/VHT20, M8 to M15	3	10	2.3	2.0	1.9	6.8	7.0	0.2
	HT/VHT20 Beam Forming, M0 to M7	2	10	3.5	2.7		6.1	7.0	0.9
	HT/VHT20 Beam Forming, M8 to M15	2	10	3.5	2.7		6.1	7.0	0.9
	HT/VHT20 Beam Forming, M0 to M7	3	13	-1.5	-2.2	-1.9	2.9	4.0	1.1
	HT/VHT20 Beam Forming, M8 to M15	3	10	2.3	2.0	1.9	6.8	7.0	0.2
	HT/VHT20 STBC, M0 to M7	2	10	3.5	2.7		6.1	7.0	0.9
	HT/VHT20 STBC, M0 to M7	3	10	2.3	2.0	1.9	6.8	7.0	0.2

**Power Spectral Density, 5500 MHz, HT/VHT20 Beam Forming, M0 to M7**

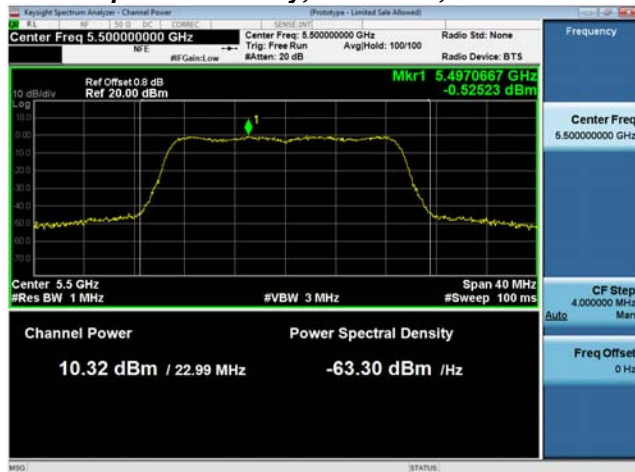

**Antenna A**

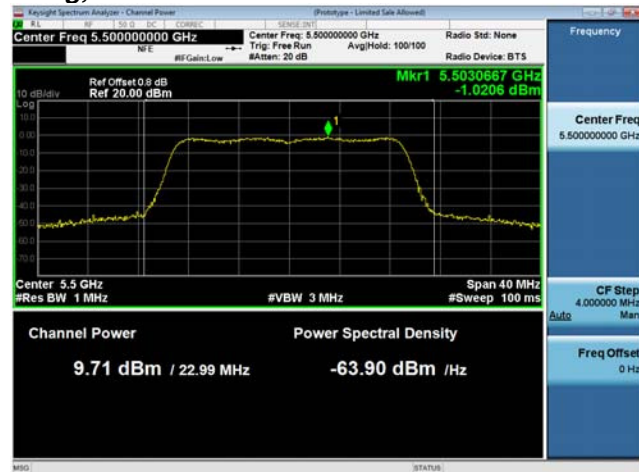

**Antenna B**

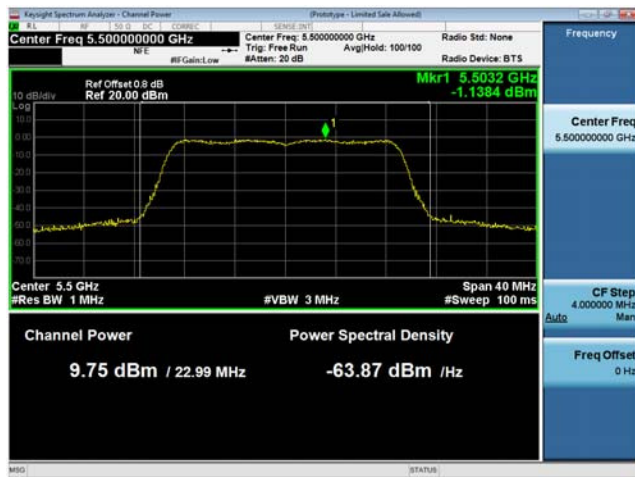

**Antenna C**



### A.3 Conducted Spurious Emissions

**15.407 (b) Undesirable emission limits.** Except as shown in paragraph (b) (7) of this section, the maximum emissions outside of the frequency bands of operation shall be attenuated in accordance with the following limits:

- (3) For transmitters operating in the 5.47-5.725 GHz band: All emissions outside of the 5.47-5.725 GHz band shall not exceed an e.i.r.p. of -27 dBm/MHz..
- (6) Unwanted emissions below 1 GHz must comply with the general field strength limits set forth in §15.209.
- (7) The provisions of §15.205 apply to intentional radiators operating under this section.

**Test Procedure**

**Ref.** KDB 789033 D02 General UNII Test Procedures New Rules v01r03  
ANSI C63.10: 2013

<p><b>Conducted Spurious Emissions</b> Test Procedure</p> <ol style="list-style-type: none"> <li>1. Connect the antenna port(s) to the spectrum analyzer input.</li> <li>2. Place the radio in continuous transmit mode. Use the procedures in KDB 789033 D02 General UNII Test Procedures New Rules v01r03 to substitute conducted measurements in place of radiated measurements.</li> <li>3. Configure Spectrum analyzer as per test parameters below (be sure to enter all losses between the transmitter output and the spectrum analyzer).</li> <li>4. Record the marker waveform peak to spur difference. Also measure any emissions in the restricted bands.</li> <li>5. The “measure-and-sum technique” is used for measuring in-band transmit power of a device. In the measure-and-sum approach, the conducted emission level is measured at each antenna port. The measured results at the various antenna ports are then summed mathematically to determine the total emission level from the device. Summing is performed in linear power units. The worst case output is recorded.</li> <li>6. Capture graphs and record pertinent measurement data.</li> </ol>
--

**Ref.** KDB 789033 D02 General UNII Test Procedures New Rules v01r03  
ANSI C63.10: 2013 section 12.7.7.3 (average) & 12.7.6 (peak)

<p><b>Conducted Spurious Emissions</b> Test parameters</p> <p>Span = 30MHz to 18GHz / 18GHz to 40GHz                  RBW = 1 MHz                  VBW ≥ 3 x RBW for Peak, 1kHz for Average                  Sweep = Auto couple                  Detector = Peak                  Trace = Max Hold.</p>
--

System Number	Description	Samples	System under test	Support equipment
1	EUT	S01	<input checked="" type="checkbox"/>	<input type="checkbox"/>
	Support	S02	<input type="checkbox"/>	<input checked="" type="checkbox"/>

<p><b>Tested By :</b> Jose Aguirre</p>	<p><b>Date of testing:</b> 20-April-16 - 08-Aug-16</p>
<p><b>Test Result : PASS</b></p>	

See Appendix C for list of test equipment

### Conducted Spurs Average Upper, All Antennas

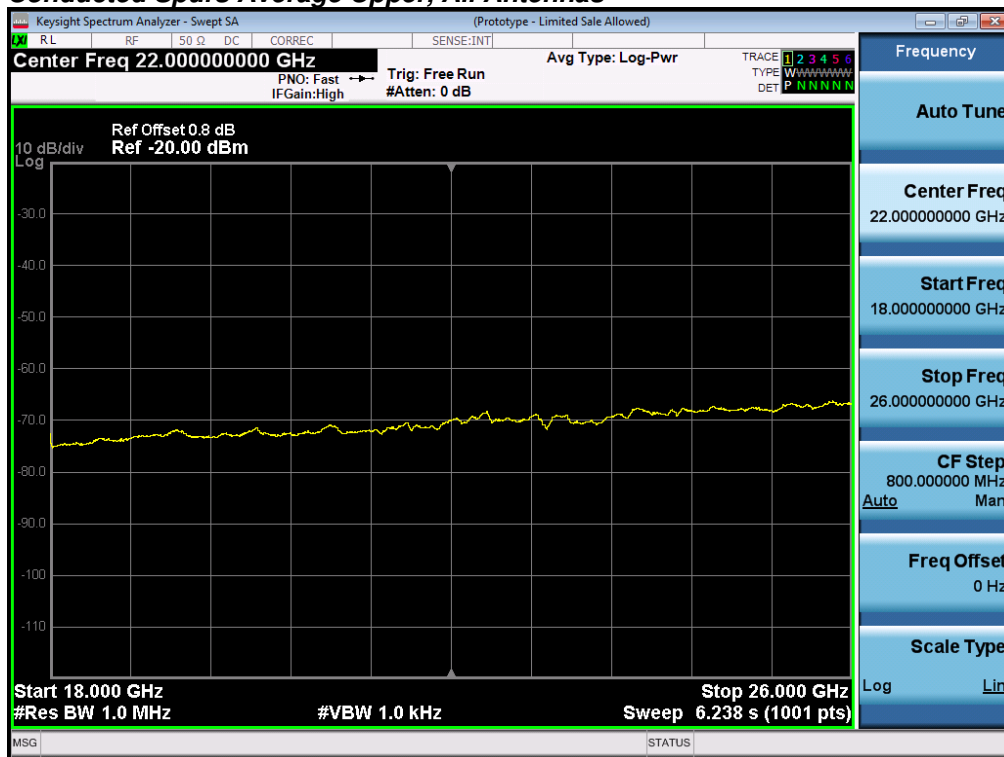

### Conducted Spurs Peak Upper, All Antennas

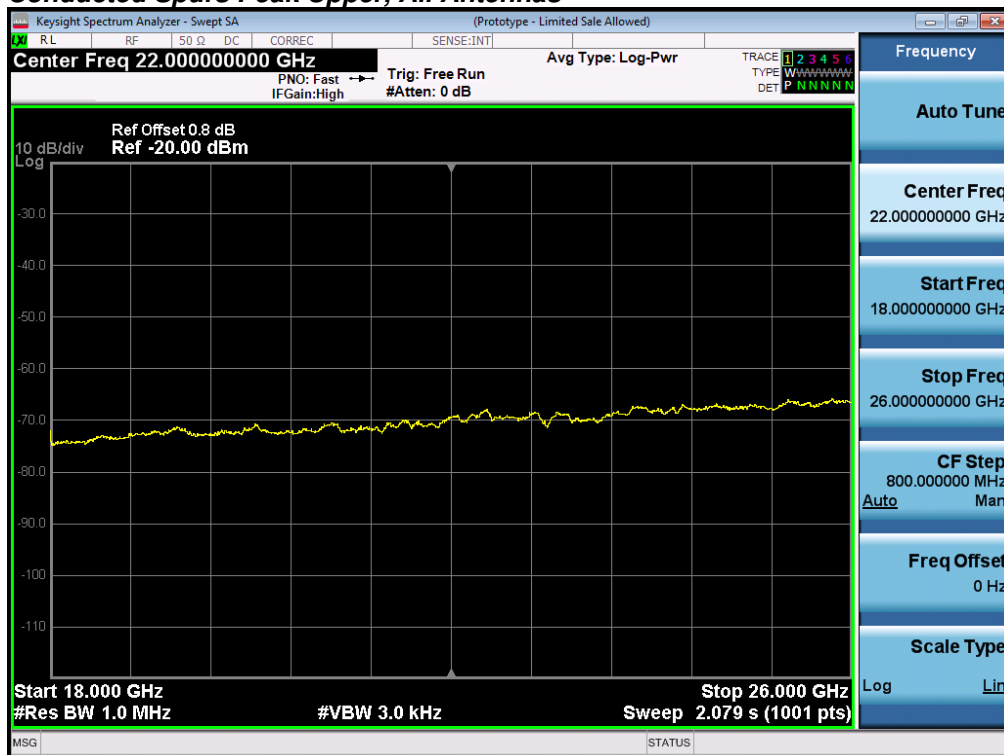





**Conducted Spurious Emission results below represent the worst case for all antenna gain**

Frequency (MHz)	Mode	Tx Paths	Correlated Antenna Gain (dBi)	Tx 1 Spur Power (dBm)	Tx 2 Spur Power (dBm)	Tx 3 Spur Power (dBm)	Total Conducted Spur (dBm)	Limit (dBm)	Margin (dB)
5500	Non HT20, 6 to 54 Mbps	1	10	-52.9			-42.9	-41.25	1.7
	Non HT20, 6 to 54 Mbps	2	10	-54.2	-55.7		-41.9	-41.25	0.6
	Non HT20, 6 to 54 Mbps	3	10	-58.7	-60.0	-71.7	-46.2	-41.25	4.9
	Non HT20 Beam Forming, 6 to 54 Mbps	2	10	-54.2	-55.7		-41.9	-41.25	0.6
	Non HT20 Beam Forming, 6 to 54 Mbps	3	13	-59.4	-60.2	-59.1	-41.8	-41.25	0.5
	HT/VHT20, M0 to M7	1	10	-53.2			-43.2	-41.25	2.0
	HT/VHT20, M0 to M7	2	10	-53.9	-55.3		-41.5	-41.25	0.3
	HT/VHT20, M8 to M15	2	10	-53.9	-55.3		-41.5	-41.25	0.3
	HT/VHT20, M0 to M7	3	10	-58.6	-59.3	-57.6	-43.7	-41.25	2.4
	HT/VHT20, M8 to M15	3	10	-57.7	-59.0	-54.5	-41.9	-41.25	0.6
	HT/VHT20 Beam Forming, M0 to M7	2	10	-53.9	-55.3		-41.5	-41.25	0.3
	HT/VHT20 Beam Forming, M8 to M15	2	10	-53.9	-55.3		-41.5	-41.25	0.3
	HT/VHT20 Beam Forming, M0 to M7	3	13	-71.8	-60.1	-58.2	-42.9	-41.25	1.7
	HT/VHT20 Beam Forming, M8 to M15	3	10	-57.7	-59.0	-54.5	-41.9	-41.25	0.6
	HT/VHT20 STBC, M0 to M7	2	10	-53.9	-55.3		-41.5	-41.25	0.3
HT/VHT20 STBC, M0 to M7	3	10	-57.7	-59.0	-54.5	-41.9	-41.25	0.6	
5510	Non HT40, 6 to 54 Mbps	1	10	-58.6			-48.6	-41.25	7.4
	Non HT40, 6 to 54 Mbps	2	10	-57.0	-58.3		-44.6	-41.25	3.3
	Non HT40, 6 to 54 Mbps	3	10	-59.0	-73.5	-73.2	-48.7	-41.25	7.4
	HT/VHT40, M0 to M7	1	10	-53.8			-43.8	-41.25	2.6
	HT/VHT40, M0 to M7	2	10	-58.2	-73.0		-48.1	-41.25	6.8
	HT/VHT40, M8 to M15	2	10	-58.2	-73.0		-48.1	-41.25	6.8
	HT/VHT40, M0 to M7	3	10	-59.0	-60.1	-58.9	-44.5	-41.25	3.3
	HT/VHT40, M8 to M15	3	10	-59.0	-60.1	-58.9	-44.5	-41.25	3.3
	HT/VHT40 Beam Forming, M0 to M7	2	10	-58.2	-73.0		-48.1	-41.25	6.8
	HT/VHT40 Beam Forming, M8 to M15	2	10	-58.2	-73.0		-48.1	-41.25	6.8
	HT/VHT40 Beam Forming, M0 to M7	3	13	-59.3	-73.4	-72.9	-46.0	-41.25	4.7
	HT/VHT40 Beam Forming, M8 to M15	3	10	-59.0	-60.1	-58.9	-44.5	-41.25	3.3
	HT/VHT40 STBC, M0 to M7	2	10	-58.2	-73.0		-48.1	-41.25	6.8
HT/VHT40 STBC, M0 to M7	3	10	-59.0	-60.1	-58.9	-44.5	-41.25	3.3	



5530	Non HT80, 6 to 54 Mbps	1	10	-54.7			-44.7	-41.25	3.5
	Non HT80, 6 to 54 Mbps	2	10	-54.9	-55.6		-42.2	-41.25	1.0
	Non HT80, 6 to 54 Mbps	3	10	-73.4	-60.5	-56.3	-44.8	-41.25	3.6
	VHT80, M0 to M9 1ss	1	10	-58.1			-48.1	-41.25	6.9
	VHT80, M0 to M9 1ss	2	10	-58.7	-60.0		-46.3	-41.25	5.0
	VHT80, M0 to M9 2ss	2	10	-58.7	-60.0		-46.3	-41.25	5.0
	VHT80, M0 to M9 1ss	3	10	-59.5	-60.5	-73.3	-46.9	-41.25	5.6
	VHT80, M0 to M9 2ss	3	10	-59.5	-60.5	-73.3	-46.9	-41.25	5.6
	VHT80 Beam Forming, M0 to M9 1ss	2	10	-58.7	-60.0		-46.3	-41.25	5.0
	VHT80 Beam Forming, M0 to M9 2ss	2	10	-58.7	-60.0		-46.3	-41.25	5.0
	VHT80 Beam Forming, M0 to M9 1ss	3	13	-74.8	-64.6	-60.5	-46.0	-41.25	4.7
	VHT80 Beam Forming, M0 to M9 2ss	3	10	-59.5	-60.5	-73.3	-46.9	-41.25	5.6
	VHT80 STBC, M0 to M9 1ss	2	10	-58.7	-60.0		-46.3	-41.25	5.0
	VHT80 STBC, M0 to M9 1ss	3	10	-59.5	-60.5	-73.3	-46.9	-41.25	5.6
5580	Non HT20, 6 to 54 Mbps	1	10	-54.4			-44.4	-41.25	3.1
	Non HT20, 6 to 54 Mbps	2	10	-55.7	-56.2		-42.9	-41.25	1.7
	Non HT20, 6 to 54 Mbps	3	10	-59.8	-60.1	-55.9	-43.4	-41.25	2.1
	Non HT20 Beam Forming, 6 to 54 Mbps	2	10	-55.7	-56.2		-42.9	-41.25	1.7
	Non HT20 Beam Forming, 6 to 54 Mbps	3	13	-72.9	-60.7	-71.6	-47.1	-41.25	5.9
	HT/VHT20, M0 to M7	1	10	-54.0			-44.0	-41.25	2.8
	HT/VHT20, M0 to M7	2	10	-58.4	-55.7		-43.8	-41.25	2.6
	HT/VHT20, M8 to M15	2	10	-58.4	-55.7		-43.8	-41.25	2.6
	HT/VHT20, M0 to M7	3	10	-59.7	-59.9	-55.8	-43.3	-41.25	2.0
	HT/VHT20, M8 to M15	3	10	-59.1	-59.4	-55.4	-42.8	-41.25	1.5
	HT/VHT20 Beam Forming, M0 to M7	2	10	-58.4	-55.7		-43.8	-41.25	2.6
	HT/VHT20 Beam Forming, M8 to M15	2	10	-58.4	-55.7		-43.8	-41.25	2.6
	HT/VHT20 Beam Forming, M0 to M7	3	13	-60.5	-60.6	-73.3	-44.4	-41.25	3.2
	HT/VHT20 Beam Forming, M8 to M15	3	10	-59.1	-59.4	-55.4	-42.8	-41.25	1.5
	HT/VHT20 STBC, M0 to M7	2	10	-58.4	-55.7		-43.8	-41.25	2.6
	HT/VHT20 STBC, M0 to M7	3	10	-59.1	-59.4	-55.4	-42.8	-41.25	1.5
5590	<b>Non HT40, 6 to 54 Mbps</b>	<b>1</b>	<b>10</b>	<b>-51.3</b>			<b>-41.3</b>	<b>-41.25</b>	<b>0.0</b>
	Non HT40, 6 to 54 Mbps	2	10	-54.4	-54.5		-41.4	-41.25	0.2
	Non HT40, 6 to 54 Mbps	3	10	-73.3	-55.6	-55.5	-42.5	-41.25	1.3
	HT/VHT40, M0 to M7	1	10	-53.2			-43.2	-41.25	2.0
	HT/VHT40, M0 to M7	2	10	-54.7	-54.6		-41.6	-41.25	0.4
	HT/VHT40, M8 to M15	2	10	-54.7	-54.6		-41.6	-41.25	0.4
	HT/VHT40, M0 to M7	3	10	-58.4	-56.0	-54.6	-41.3	-41.25	0.0
	HT/VHT40, M8 to M15	3	10	-58.4	-56.0	-54.6	-41.3	-41.25	0.0
	HT/VHT40 Beam Forming, M0 to M7	2	10	-54.7	-54.6		-41.6	-41.25	0.4
	HT/VHT40 Beam Forming, M8 to M15	2	10	-54.7	-54.6		-41.6	-41.25	0.4
	HT/VHT40 Beam Forming, M0 to M7	3	13	-60.0	-74.3	-58.3	-43.0	-41.25	1.7



	HT/VHT40 Beam Forming, M8 to M15	3	10	-58.4	-56.0	-54.6	-41.3	-41.25	0.0
	HT/VHT40 STBC, M0 to M7	2	10	-54.7	-54.6		-41.6	-41.25	0.4
	HT/VHT40 STBC, M0 to M7	3	10	-58.4	-56.0	-54.6	-41.3	-41.25	0.0
5610	Non HT80, 6 to 54 Mbps	1	10	-51.5			-41.5	-41.25	0.3
	Non HT80, 6 to 54 Mbps	2	10	-56.2	-53.8		-41.8	-41.25	0.6
	Non HT80, 6 to 54 Mbps	3	10	-57.3	-56.0	-56.7	-41.9	-41.25	0.6
	VHT80, M0 to M9 1ss	1	10	-51.4			-41.4	-41.25	0.2
	VHT80, M0 to M9 1ss	2	10	-54.9	-54.2		-41.5	-41.25	0.3
	VHT80, M0 to M9 2ss	2	10	-54.9	-54.2		-41.5	-41.25	0.3
	VHT80, M0 to M9 1ss	3	10	-58.6	-56.6	-55.1	-41.8	-41.25	0.5
	VHT80, M0 to M9 2ss	3	10	-58.6	-56.6	-55.1	-41.8	-41.25	0.5
	VHT80 Beam Forming, M0 to M9 1ss	2	10	-54.9	-54.2		-41.5	-41.25	0.3
	VHT80 Beam Forming, M0 to M9 2ss	2	10	-54.9	-54.2		-41.5	-41.25	0.3
	VHT80 Beam Forming, M0 to M9 1ss	3	13	-60.4	-74.5	-56.1	-41.7	-41.25	0.4
	VHT80 Beam Forming, M0 to M9 2ss	3	10	-58.6	-56.6	-55.1	-41.8	-41.25	0.5
	VHT80 STBC, M0 to M9 1ss	2	10	-54.9	-54.2		-41.5	-41.25	0.3
	VHT80 STBC, M0 to M9 1ss	3	10	-58.6	-56.6	-55.1	-41.8	-41.25	0.5
5690	Non HT80, 6 to 54 Mbps	1	10	-52.6			-42.6	-41.25	1.4
	Non HT80, 6 to 54 Mbps	2	10	-56.7	-53.3		-41.7	-41.25	0.4
	Non HT80, 6 to 54 Mbps	3	10	-57.2	-54.7	-57.7	-41.6	-41.25	0.3
	VHT80, M0 to M9 1ss	1	10	-51.9			-41.9	-41.25	0.7
	VHT80, M0 to M9 1ss	2	10	-55.0	-54.6		-41.8	-41.25	0.5
	VHT80, M0 to M9 2ss	2	10	-55.0	-54.6		-41.8	-41.25	0.5
	VHT80, M0 to M9 1ss	3	10	-58.5	-55.2	-56.2	-41.7	-41.25	0.4
	VHT80, M0 to M9 2ss	3	10	-58.5	-55.2	-56.2	-41.7	-41.25	0.4
	VHT80 Beam Forming, M0 to M9 1ss	2	10	-55.0	-54.6		-41.8	-41.25	0.5
	VHT80 Beam Forming, M0 to M9 2ss	2	10	-55.0	-54.6		-41.8	-41.25	0.5
	VHT80 Beam Forming, M0 to M9 1ss	3	13	-59.6	-73.4	-56.9	-42.0	-41.25	0.7
	VHT80 Beam Forming, M0 to M9 2ss	3	10	-58.5	-55.2	-56.2	-41.7	-41.25	0.4
	VHT80 STBC, M0 to M9 1ss	2	10	-55.0	-54.6		-41.8	-41.25	0.5
	VHT80 STBC, M0 to M9 1ss	3	10	-58.5	-55.2	-56.2	-41.7	-41.25	0.4
5710	Non HT40, 6 to 54 Mbps	1	10	-51.8			-41.8	-41.25	0.5
	Non HT40, 6 to 54 Mbps	2	10	-54.9	-53.8		-41.3	-41.25	0.1
	Non HT40, 6 to 54 Mbps	3	10	-56.5	-55.5	-56.2	-41.3	-41.25	0.0
	HT/VHT40, M0 to M7	1	10	-51.7			-41.7	-41.25	0.5
	HT/VHT40, M0 to M7	2	10	-54.9	-54.8		-41.8	-41.25	0.6
	HT/VHT40, M8 to M15	2	10	-54.9	-54.8		-41.8	-41.25	0.6
	HT/VHT40, M0 to M7	3	10	-58.8	-55.7	-56.0	-41.9	-41.25	0.6
	HT/VHT40, M8 to M15	3	10	-58.8	-55.7	-56.0	-41.9	-41.25	0.6
	HT/VHT40 Beam Forming, M0 to M7	2	10	-54.9	-54.8		-41.8	-41.25	0.6



	HT/VHT40 Beam Forming, M8 to M15	2	10	-54.9	-54.8		-41.8	-41.25	0.6
	HT/VHT40 Beam Forming, M0 to M7	3	13	-74.3	-60.2	-57.2	-42.4	-41.25	1.1
	HT/VHT40 Beam Forming, M8 to M15	3	10	-58.8	-55.7	-56.0	-41.9	-41.25	0.6
	HT/VHT40 STBC, M0 to M7	2	10	-54.9	-54.8		-41.8	-41.25	0.6
	HT/VHT40 STBC, M0 to M7	3	10	-58.8	-55.7	-56.0	-41.9	-41.25	0.6
5720	Non HT20, 6 to 54 Mbps	1	10	-54.5			-44.5	-41.25	3.3
	Non HT20, 6 to 54 Mbps	2	10	-55.8	-55.9		-42.8	-41.25	1.6
	Non HT20, 6 to 54 Mbps	3	10	-59.2	-54.9	-56.4	-41.7	-41.25	0.5
	Non HT20 Beam Forming, 6 to 54 Mbps	2	10	-55.8	-55.9		-42.8	-41.25	1.6
	Non HT20 Beam Forming, 6 to 54 Mbps	3	13	-73.7	-73.6	-58.9	-45.6	-41.25	4.4
	HT/VHT20, M0 to M7	1	10	-54.7			-44.7	-41.25	3.5
	HT/VHT20, M0 to M7	2	10	-55.9	-55.8		-42.8	-41.25	1.6
	HT/VHT20, M8 to M15	2	10	-55.9	-55.8		-42.8	-41.25	1.6
	HT/VHT20, M0 to M7	3	10	-73.2	-55.6	-56.4	-42.9	-41.25	1.7
	HT/VHT20, M8 to M15	3	10	-58.6	-55.9	-55.9	-41.9	-41.25	0.6
	HT/VHT20 Beam Forming, M0 to M7	2	10	-55.9	-55.8		-42.8	-41.25	1.6
	HT/VHT20 Beam Forming, M8 to M15	2	10	-55.9	-55.8		-42.8	-41.25	1.6
	HT/VHT20 Beam Forming, M0 to M7	3	13	-73.2	-74.7	-73.7	-56.1	-41.25	14.8
	HT/VHT20 Beam Forming, M8 to M15	3	10	-58.6	-55.9	-55.9	-41.9	-41.25	0.6
	HT/VHT20 STBC, M0 to M7	2	10	-55.9	-55.8		-42.8	-41.25	1.6
	HT/VHT20 STBC, M0 to M7	3	10	-58.6	-55.9	-55.9	-41.9	-41.25	0.6

**Conducted Spurs Average, 5710 MHz, Non HT40, 6 to 54 Mbps**



**Antenna A**



**Antenna B**



**Antenna C**



Frequency (MHz)	Mode	Tx Paths	Correlated Antenna Gain (dBi)	Tx 1 Spur Power (dBm)	Tx 2 Spur Power (dBm)	Tx 3 Spur Power (dBm)	Total Conducted Spur (dBm)	Limit (dBm)	Margin (dB)
5500	Non HT20, 6 to 54 Mbps	1	10	-57.0			-47.0	-21.25	25.8
	Non HT20, 6 to 54 Mbps	2	10	-45.2	-45.5		-32.3	-21.25	11.1
	Non HT20, 6 to 54 Mbps	3	10	-48.1	-49.4	-48.9	-34.0	-21.25	12.7
	Non HT20 Beam Forming, 6 to 54 Mbps	2	10	-45.2	-45.5		-32.3	-21.25	11.1
	Non HT20 Beam Forming, 6 to 54 Mbps	3	13	-49.9	-58.1	-49.8	-33.5	-21.25	12.3
	HT/VHT20, M0 to M7	1	10	-44.2			-34.2	-21.25	13.0
	HT/VHT20, M0 to M7	2	10	-43.2	-46.4		-31.5	-21.25	10.3
	HT/VHT20, M8 to M15	2	10	-43.2	-46.4		-31.5	-21.25	10.3
	HT/VHT20, M0 to M7	3	10	-48.1	-50.2	-48.6	-34.1	-21.25	12.9
	HT/VHT20, M8 to M15	3	10	-45.4	-48.7	-45.3	-31.4	-21.25	10.2
	HT/VHT20 Beam Forming, M0 to M7	2	10	-43.2	-46.4		-31.5	-21.25	10.3
	HT/VHT20 Beam Forming, M8 to M15	2	10	-43.2	-46.4		-31.5	-21.25	10.3
	HT/VHT20 Beam Forming, M0 to M7	3	13	-50.0	-50.4	-48.5	-31.8	-21.25	10.5
	HT/VHT20 Beam Forming, M8 to M15	3	10	-45.4	-48.7	-45.3	-31.4	-21.25	10.2
	HT/VHT20 STBC, M0 to M7	2	10	-43.2	-46.4		-31.5	-21.25	10.3
HT/VHT20 STBC, M0 to M7	3	10	-45.4	-48.7	-45.3	-31.4	-21.25	10.2	
5510	Non HT40, 6 to 54 Mbps	1	10	-49.6			-39.6	-21.25	18.4
	Non HT40, 6 to 54 Mbps	2	10	-47.0	-47.8		-34.4	-21.25	13.1
	Non HT40, 6 to 54 Mbps	3	10	-52.1	-51.7	-53.3	-37.5	-21.25	16.3
	HT/VHT40, M0 to M7	1	10	-43.7			-33.7	-21.25	12.5
	HT/VHT40, M0 to M7	2	10	-49.5	-49.8		-36.6	-21.25	15.4
	HT/VHT40, M8 to M15	2	10	-49.5	-49.8		-36.6	-21.25	15.4
	HT/VHT40, M0 to M7	3	10	-50.2	-51.5	-49.6	-35.6	-21.25	14.3
	HT/VHT40, M8 to M15	3	10	-50.2	-51.5	-49.6	-35.6	-21.25	14.3
	HT/VHT40 Beam Forming, M0 to M7	2	10	-49.5	-49.8		-36.6	-21.25	15.4
	HT/VHT40 Beam Forming, M8 to M15	2	10	-49.5	-49.8		-36.6	-21.25	15.4
	HT/VHT40 Beam Forming, M0 to M7	3	13	-51.5	-52.0	-52.1	-34.1	-21.25	12.8
	HT/VHT40 Beam Forming, M8 to M15	3	10	-50.2	-51.5	-49.6	-35.6	-21.25	14.3
	HT/VHT40 STBC, M0 to M7	2	10	-49.5	-49.8		-36.6	-21.25	15.4
HT/VHT40 STBC, M0 to M7	3	10	-50.2	-51.5	-49.6	-35.6	-21.25	14.3	



5530	Non HT80, 6 to 54 Mbps	1	10	-46.0			-36.0	-21.25	14.8
	Non HT80, 6 to 54 Mbps	2	10	-45.8	-47.5		-33.6	-21.25	12.3
	Non HT80, 6 to 54 Mbps	3	10	-50.9	-52.4	-48.3	-35.4	-21.25	14.2
	VHT80, M0 to M9 1ss	1	10	-48.1			-38.1	-21.25	16.9
	VHT80, M0 to M9 1ss	2	10	-49.4	-49.1		-36.2	-21.25	15.0
	VHT80, M0 to M9 2ss	2	10	-49.4	-49.1		-36.2	-21.25	15.0
	VHT80, M0 to M9 1ss	3	10	-49.8	-51.0	-50.3	-35.6	-21.25	14.3
	VHT80, M0 to M9 2ss	3	10	-49.8	-51.0	-50.3	-35.6	-21.25	14.3
	VHT80 Beam Forming, M0 to M9 1ss	2	10	-49.4	-49.1		-36.2	-21.25	15.0
	VHT80 Beam Forming, M0 to M9 2ss	2	10	-49.4	-49.1		-36.2	-21.25	15.0
	VHT80 Beam Forming, M0 to M9 1ss	3	13	-53.8	-56.1	-52.4	-36.1	-21.25	14.8
	VHT80 Beam Forming, M0 to M9 2ss	3	10	-49.8	-51.0	-50.3	-35.6	-21.25	14.3
	VHT80 STBC, M0 to M9 1ss	2	10	-49.4	-49.1		-36.2	-21.25	15.0
	VHT80 STBC, M0 to M9 1ss	3	10	-49.8	-51.0	-50.3	-35.6	-21.25	14.3
5580	Non HT20, 6 to 54 Mbps	1	10	-45.5			-35.5	-21.25	14.3
	Non HT20, 6 to 54 Mbps	2	10	-46.2	-46.5		-33.3	-21.25	12.1
	Non HT20, 6 to 54 Mbps	3	10	-50.1	-51.0	-45.0	-33.1	-21.25	11.8
	Non HT20 Beam Forming, 6 to 54 Mbps	2	10	-46.2	-46.5		-33.3	-21.25	12.1
	Non HT20 Beam Forming, 6 to 54 Mbps	3	13	-51.7	-52.0	-47.1	-31.9	-21.25	10.6
	HT/VHT20, M0 to M7	1	10	-44.4			-34.4	-21.25	13.2
	HT/VHT20, M0 to M7	2	10	-48.9	-47.2		-35.0	-21.25	13.7
	HT/VHT20, M8 to M15	2	10	-48.9	-47.2		-35.0	-21.25	13.7
	HT/VHT20, M0 to M7	3	10	-50.1	-50.3	-47.4	-34.3	-21.25	13.0
	HT/VHT20, M8 to M15	3	10	-49.3	-49.1	-46.4	-33.3	-21.25	12.0
	HT/VHT20 Beam Forming, M0 to M7	2	10	-48.9	-47.2		-35.0	-21.25	13.7
	HT/VHT20 Beam Forming, M8 to M15	2	10	-48.9	-47.2		-35.0	-21.25	13.7
	<b>HT/VHT20 Beam Forming, M0 to M7</b>	<b>3</b>	<b>13</b>	<b>-49.1</b>	<b>-48.8</b>	<b>-47.0</b>	<b>-30.4</b>	<b>-21.25</b>	<b>9.2</b>
	HT/VHT20 Beam Forming, M8 to M15	3	10	-49.3	-49.1	-46.4	-33.3	-21.25	12.0
	HT/VHT20 STBC, M0 to M7	2	10	-48.9	-47.2		-35.0	-21.25	13.7
HT/VHT20 STBC, M0 to M7	3	10	-49.3	-49.1	-46.4	-33.3	-21.25	12.0	
5590	Non HT40, 6 to 54 Mbps	1	10	-41.4			-31.4	-21.25	10.2
	Non HT40, 6 to 54 Mbps	2	10	-45.3	-46.7		-32.9	-21.25	11.7
	Non HT40, 6 to 54 Mbps	3	10	-49.6	-47.9	-46.8	-33.2	-21.25	11.9
	HT/VHT40, M0 to M7	1	10	-44.0			-34.0	-21.25	12.8
	HT/VHT40, M0 to M7	2	10	-45.1	-44.8		-31.9	-21.25	10.7
	HT/VHT40, M8 to M15	2	10	-45.1	-44.8		-31.9	-21.25	10.7
	HT/VHT40, M0 to M7	3	10	-46.7	-46.7	-45.1	-31.3	-21.25	10.1
	HT/VHT40, M8 to M15	3	10	-46.7	-46.7	-45.1	-31.3	-21.25	10.1
	HT/VHT40 Beam Forming, M0 to M7	2	10	-45.1	-44.8		-31.9	-21.25	10.7
	HT/VHT40 Beam Forming, M8 to M15	2	10	-45.1	-44.8		-31.9	-21.25	10.7
	HT/VHT40 Beam Forming, M0 to M7	3	13	-49.5	-51.0	-49.5	-32.2	-21.25	10.9



	HT/VHT40 Beam Forming, M8 to M15	3	10	-46.7	-46.7	-45.1	-31.3	-21.25	10.1
	HT/VHT40 STBC, M0 to M7	2	10	-45.1	-44.8		-31.9	-21.25	10.7
	HT/VHT40 STBC, M0 to M7	3	10	-46.7	-46.7	-45.1	-31.3	-21.25	10.1
5610	Non HT80, 6 to 54 Mbps	1	10	-42.2			-32.2	-21.25	11.0
	Non HT80, 6 to 54 Mbps	2	10	-46.9	-45.0		-32.8	-21.25	11.6
	Non HT80, 6 to 54 Mbps	3	10	-46.9	-48.5	-48.2	-33.0	-21.25	11.8
	VHT80, M0 to M9 1ss	1	10	-41.5			-31.5	-21.25	10.3
	VHT80, M0 to M9 1ss	2	10	-46.4	-45.1		-32.7	-21.25	11.4
	VHT80, M0 to M9 2ss	2	10	-46.4	-45.1		-32.7	-21.25	11.4
	VHT80, M0 to M9 1ss	3	10	-49.0	-46.1	-45.3	-31.8	-21.25	10.5
	VHT80, M0 to M9 2ss	3	10	-49.0	-46.1	-45.3	-31.8	-21.25	10.5
	VHT80 Beam Forming, M0 to M9 1ss	2	10	-46.4	-45.1		-32.7	-21.25	11.4
	VHT80 Beam Forming, M0 to M9 2ss	2	10	-46.4	-45.1		-32.7	-21.25	11.4
	VHT80 Beam Forming, M0 to M9 1ss	3	13	-50.8	-49.8	-47.5	-31.4	-21.25	10.1
	VHT80 Beam Forming, M0 to M9 2ss	3	10	-49.0	-46.1	-45.3	-31.8	-21.25	10.5
	VHT80 STBC, M0 to M9 1ss	2	10	-46.4	-45.1		-32.7	-21.25	11.4
	VHT80 STBC, M0 to M9 1ss	3	10	-49.0	-46.1	-45.3	-31.8	-21.25	10.5
5690	Non HT80, 6 to 54 Mbps	1	10	-58.9			-48.9	-21.25	27.7
	Non HT80, 6 to 54 Mbps	2	10	-48.1	-45.8		-33.8	-21.25	12.5
	Non HT80, 6 to 54 Mbps	3	10	-48.2	-48.2	-47.4	-33.1	-21.25	11.9
	VHT80, M0 to M9 1ss	1	10	-44.0			-34.0	-21.25	12.8
	VHT80, M0 to M9 1ss	2	10	-45.4	-45.8		-32.6	-21.25	11.3
	VHT80, M0 to M9 2ss	2	10	-45.4	-45.8		-32.6	-21.25	11.3
	VHT80, M0 to M9 1ss	3	10	-58.7	-46.7	-46.8	-33.6	-21.25	12.4
	VHT80, M0 to M9 2ss	3	10	-58.7	-46.7	-46.8	-33.6	-21.25	12.4
	VHT80 Beam Forming, M0 to M9 1ss	2	10	-45.4	-45.8		-32.6	-21.25	11.3
	VHT80 Beam Forming, M0 to M9 2ss	2	10	-45.4	-45.8		-32.6	-21.25	11.3
	VHT80 Beam Forming, M0 to M9 1ss	3	13	-49.4	-48.9	-48.0	-31.0	-21.25	9.7
	VHT80 Beam Forming, M0 to M9 2ss	3	10	-58.7	-46.7	-46.8	-33.6	-21.25	12.4
	VHT80 STBC, M0 to M9 1ss	2	10	-45.4	-45.8		-32.6	-21.25	11.3
VHT80 STBC, M0 to M9 1ss	3	10	-58.7	-46.7	-46.8	-33.6	-21.25	12.4	
5710	Non HT40, 6 to 54 Mbps	1	10	-58.0			-48.0	-21.25	26.8
	Non HT40, 6 to 54 Mbps	2	10	-58.0	-57.0		-44.5	-21.25	23.2
	Non HT40, 6 to 54 Mbps	3	10	-57.0	-57.5	-56.9	-42.4	-21.25	21.1
	HT/VHT40, M0 to M7	1	10	-54.5			-44.5	-21.25	23.3
	HT/VHT40, M0 to M7	2	10	-55.7	-56.6		-43.1	-21.25	21.9
	HT/VHT40, M8 to M15	2	10	-55.7	-56.6		-43.1	-21.25	21.9
	HT/VHT40, M0 to M7	3	10	-57.8	-59.8	-55.3	-42.5	-21.25	21.2
	HT/VHT40, M8 to M15	3	10	-57.8	-59.8	-55.3	-42.5	-21.25	21.2
	HT/VHT40 Beam Forming, M0 to M7	2	10	-55.7	-56.6		-43.1	-21.25	21.9





	HT/VHT40 Beam Forming, M8 to M15	2	10	-55.7	-56.6		-43.1	-21.25	21.9
	HT/VHT40 Beam Forming, M0 to M7	3	13	-58.1	-54.7	-58.4	-38.9	-21.25	17.7
	HT/VHT40 Beam Forming, M8 to M15	3	10	-57.8	-59.8	-55.3	-42.5	-21.25	21.2
	HT/VHT40 STBC, M0 to M7	2	10	-55.7	-56.6		-43.1	-21.25	21.9
	HT/VHT40 STBC, M0 to M7	3	10	-57.8	-59.8	-55.3	-42.5	-21.25	21.2
5720	Non HT20, 6 to 54 Mbps	1	10	-58.7			-48.7	-21.25	27.5
	Non HT20, 6 to 54 Mbps	2	10	-59.3	-56.8		-44.9	-21.25	23.6
	Non HT20, 6 to 54 Mbps	3	10	-56.4	-57.6	-58.2	-42.6	-21.25	21.3
	Non HT20 Beam Forming, 6 to 54 Mbps	2	10	-59.3	-56.8		-44.9	-21.25	23.6
	Non HT20 Beam Forming, 6 to 54 Mbps	3	13	-58.3	-56.7	-57.4	-39.6	-21.25	18.4
	HT/VHT20, M0 to M7	1	10	-58.3			-48.3	-21.25	27.1
	HT/VHT20, M0 to M7	2	10	-57.6	-57.6		-44.6	-21.25	23.3
	HT/VHT20, M8 to M15	2	10	-57.6	-57.6		-44.6	-21.25	23.3
	HT/VHT20, M0 to M7	3	10	-57.3	-57.4	-56.5	-42.3	-21.25	21.0
	HT/VHT20, M8 to M15	3	10	-57.7	-56.2	-58.4	-42.6	-21.25	21.3
	HT/VHT20 Beam Forming, M0 to M7	2	10	-57.6	-57.6		-44.6	-21.25	23.3
	HT/VHT20 Beam Forming, M8 to M15	2	10	-57.6	-57.6		-44.6	-21.25	23.3
	HT/VHT20 Beam Forming, M0 to M7	3	13	-59.5	-54.5	-57.3	-38.8	-21.25	17.6
	HT/VHT20 Beam Forming, M8 to M15	3	10	-57.7	-56.2	-58.4	-42.6	-21.25	21.3
	HT/VHT20 STBC, M0 to M7	2	10	-57.6	-57.6		-44.6	-21.25	23.3
	HT/VHT20 STBC, M0 to M7	3	10	-57.7	-56.2	-58.4	-42.6	-21.25	21.3

**Conducted Spurs Peak, 5580 MHz, HT/VHT20 Beam Forming, M0 to M7**

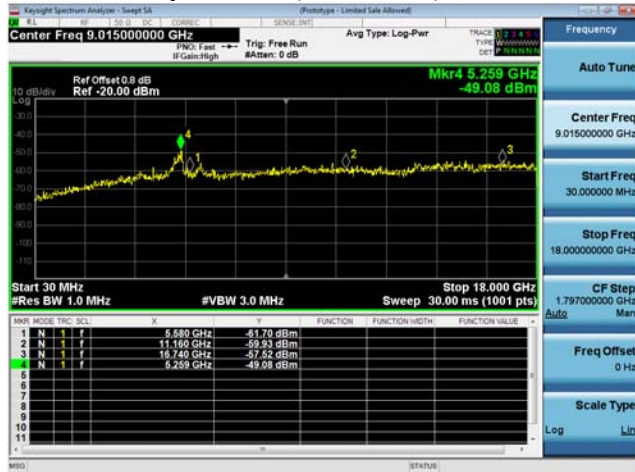

**Antenna A**

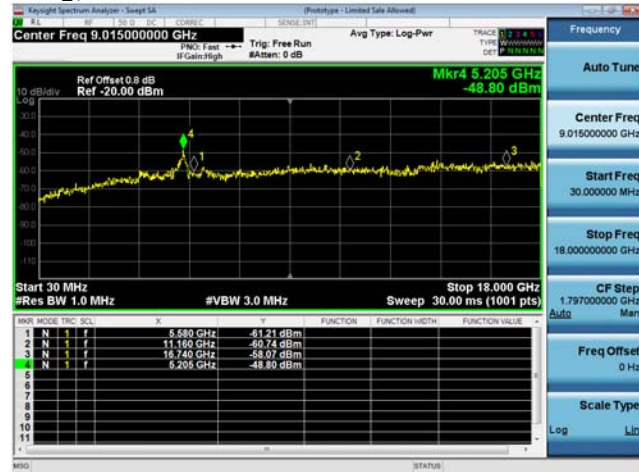

**Antenna B**

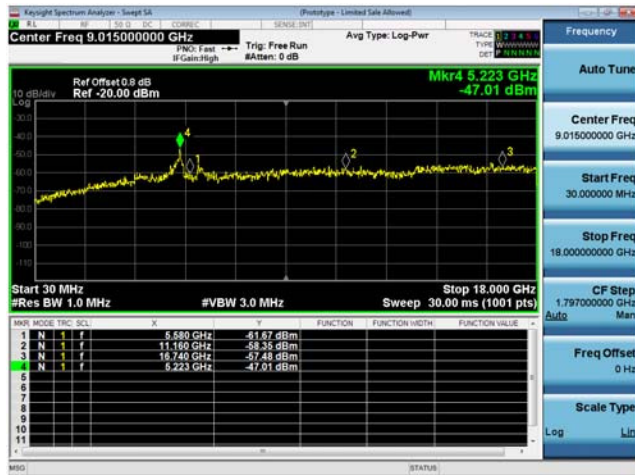

**Antenna C**



## A.4 Conducted Bandedge

**15.205 / 15.209** - Radiated emissions which fall in the restricted bands, as defined in Section 15.205(a), must also comply with the radiated emission limits specified in Section 15.209(a) (see Section 15.205(c)).

Use formula below to substitute conducted measurements in place of radiated measurements

$$E[\text{dB}\mu\text{V}/\text{m}] = \text{EIRP}[\text{dBm}] - 20 \log(d[\text{meters}]) + 104.77, \text{ where } E = \text{field strength and } d = 3 \text{ meter}$$

- 1) Average Plot, Limit= -41.25 dBm eirp
- 2) Peak plot, Limit = -21.25 dBm eirp

### Test Procedure

**Ref.** KDB 789033 D02 General UNII Test Procedures New Rules v01r03  
ANSI C63.10: 2013

<p><b>Conducted Bandedge</b> Test Procedure</p>
<ol style="list-style-type: none"> <li>1. Connect the antenna port(s) to the spectrum analyzer input.</li> <li>2. Place the radio in continuous transmit mode. Use the procedures in ANSI C63.10: 2013 to substitute conducted measurements in place of radiated measurements.</li> <li>3. Configure Spectrum analyzer as per test parameters below (be sure to enter all losses between the transmitter output and the spectrum analyzer).</li> <li>4. Place a marker at the end of the restricted band closest to the transmit frequency to show compliance. Also measure any emissions in the restricted bands.</li> <li>5. The "measure-and-sum technique" is used for measuring in-band transmit power of a device. In the measure-and-sum approach, the conducted emission level is measured at each antenna port. The measured results at the various antenna ports are then summed mathematically to determine the total emission level from the device. Summing is performed in linear power units. The worst case output is recorded.</li> <li>6. Place a marker at the end of the restricted band closest to the transmit frequency to show compliance. Also measure any emissions in the restricted bands</li> <li>7. Capture graphs and record pertinent measurement data.</li> </ol>

**Ref.** ANSI C63.10: 2013 section 12.7.6 (peak) & 12.7.7.3 (average, Method VB-A (Alternative))

<p><b>Conducted Bandedge</b> Test parameters restricted Band</p>
<p>RBW = 1 MHz VBW ≥ 3 x RBW for Peak, 100Hz for Average Sweep = Auto couple Detector = Peak Trace = Max Hold.</p>

System Number	Description	Samples	System under test	Support equipment
1	EUT	S01	<input checked="" type="checkbox"/>	<input type="checkbox"/>
	Support	S02	<input type="checkbox"/>	<input checked="" type="checkbox"/>

<p><b>Tested By :</b> Jose Aguirre</p>	<p><b>Date of testing:</b> 20-April-16 - 08-Aug-16</p>
<p><b>Test Result : PASS</b></p>	

See Appendix C for list of test equipment



**Antenna Gain: 4 dBi**

Frequency (MHz)	Mode	Tx Paths	Correlated Antenna Gain (dBi)	Tx 1 Bandedge Level (dBm)	Tx 2 Bandedge Level (dBm)	Tx 3 Bandedge Level (dBm)	Total Tx Bandedge Level (dBm)	Limit (dBm)	Margin (dB)
5500	Non HT20, 6 to 54 Mbps	1	4	-47.1			-43.1	-41.25	1.9
	Non HT20, 6 to 54 Mbps	2	4	-48.6	-50.9		-42.6	-41.25	1.3
	Non HT20, 6 to 54 Mbps	3	4	-60.6	-60.4	-57.2	-50.3	-41.25	9.1
	Non HT20 Beam Forming, 6 to 54 Mbps	2	7	-51.4	-52.8		-42.0	-41.25	0.8
	Non HT20 Beam Forming, 6 to 54 Mbps	3	9	-60.6	-60.4	-57.2	-45.3	-41.25	4.1
	HT/VHT20, M0 to M7	1	4	-46.5			-42.5	-41.25	1.3
	HT/VHT20, M0 to M7	2	4	-47.7	-50.3		-41.8	-41.25	0.5
	HT/VHT20, M8 to M15	2	4	-47.7	-50.3		-41.8	-41.25	0.5
	HT/VHT20, M0 to M7	3	4	-55.6	-55.4	-56.5	-47.0	-41.25	5.8
	HT/VHT20, M8 to M15	3	4	-50.4	-52.0	-50.8	-42.2	-41.25	1.0
	HT/VHT20 Beam Forming, M0 to M7	2	7	-52.3	-53.3		-42.8	-41.25	1.5
	HT/VHT20 Beam Forming, M8 to M15	2	4	-47.7	-50.3		-41.8	-41.25	0.5
	HT/VHT20 Beam Forming, M0 to M7	3	9	-59.7	-59.4	-57.2	-44.8	-41.25	3.6
	HT/VHT20 Beam Forming, M8 to M15	3	6	-52.3	-53.3	-52.2	-41.8	-41.25	0.6
	HT/VHT20 STBC, M0 to M7	2	4	-47.7	-50.3		-41.8	-41.25	0.5
HT/VHT20 STBC, M0 to M7	3	4	-50.4	-52.0	-50.8	-42.2	-41.25	1.0	
5510	Non HT40, 6 to 54 Mbps	1	4	-51.7			-47.7	-41.25	6.5
	Non HT40, 6 to 54 Mbps	2	4	-53.8	-54.2		-47.0	-41.25	5.7
	Non HT40, 6 to 54 Mbps	3	4	-59.7	-60.0	-56.9	-49.9	-41.25	8.6
	<b>HT/VHT40, M0 to M7</b>	<b>1</b>	<b>4</b>	<b>-45.3</b>			<b>-41.3</b>	<b>-41.25</b>	<b>0.0</b>
	HT/VHT40, M0 to M7	2	4	-49.6	-49.6		-42.6	-41.25	1.3
	HT/VHT40, M8 to M15	2	4	-49.6	-49.6		-42.6	-41.25	1.3
	HT/VHT40, M0 to M7	3	4	-51.5	-51.0	-50.3	-42.1	-41.25	0.9
	HT/VHT40, M8 to M15	3	4	-51.5	-51.0	-50.3	-42.1	-41.25	0.9
	HT/VHT40 Beam Forming, M0 to M7	2	7	-54.2	-53.4		-43.8	-41.25	2.5
	HT/VHT40 Beam Forming, M8 to M15	2	4	-49.6	-49.6		-42.6	-41.25	1.3
	HT/VHT40 Beam Forming, M0 to M7	3	9	-58.5	-57.5	-56.7	-43.7	-41.25	2.5
	HT/VHT40 Beam Forming, M8 to M15	3	6	-55.8	-54.8	-53.1	-43.6	-41.25	2.4
	HT/VHT40 STBC, M0 to M7	2	4	-49.6	-49.6		-42.6	-41.25	1.3
	HT/VHT40 STBC, M0 to M7	3	4	-51.5	-51.0	-50.3	-42.1	-41.25	0.9



5530	Non HT80, 6 to 54 Mbps	1	4	-45.3			-41.3	-41.25	0.0
	Non HT80, 6 to 54 Mbps	2	4	-49.2	-49.8		-42.5	-41.25	1.2
	Non HT80, 6 to 54 Mbps	3	4	-51.8	-52.2	-49.2	-42.1	-41.25	0.8
	VHT80, M0 to M9 1ss	1	4	-46.1			-42.1	-41.25	0.9
	VHT80, M0 to M9 1ss	2	4	-48.2	-48.8		-41.5	-41.25	0.2
	VHT80, M0 to M9 2ss	2	4	-48.2	-48.8		-41.5	-41.25	0.2
	VHT80, M0 to M9 1ss	3	4	-52.6	-51.5	-49.9	-42.4	-41.25	1.2
	VHT80, M0 to M9 2ss	3	4	-52.6	-51.5	-49.9	-42.4	-41.25	1.2
	VHT80 Beam Forming, M0 to M9 1ss	2	7	-52.6	-51.5		-42.0	-41.25	0.8
	VHT80 Beam Forming, M0 to M9 2ss	2	4	-48.2	-48.8		-41.5	-41.25	0.2
	VHT80 Beam Forming, M0 to M9 1ss	3	9	-57.0	-55.6	-53.5	-41.4	-41.25	0.1
	VHT80 Beam Forming, M0 to M9 2ss	3	6	-54.1	-52.6	-51.0	-41.6	-41.25	0.4
	VHT80 STBC, M0 to M9 1ss	2	4	-48.2	-48.8		-41.5	-41.25	0.2
	VHT80 STBC, M0 to M9 1ss	3	4	-52.6	-51.5	-49.9	-42.4	-41.25	1.2

**Conducted Bandedge Average, 5510 MHz, HT/VHT40, M0 to M7**



**Antenna A**



**Antenna Gain: 10 dBi**

Frequency (MHz)	Mode	Tx Paths	Correlated Antenna Gain (dBi)	Tx 1 Bandedge Level (dBm)	Tx 2 Bandedge Level (dBm)	Tx 3 Bandedge Level (dBm)	Total Tx Bandedge Level (dBm)	Limit (dBm)	Margin (dB)
5500	<b>Non HT20, 6 to 54 Mbps</b>	1	10	-51.4			-41.4	-41.25	0.2
	Non HT20, 6 to 54 Mbps	2	10	-56.5	-56.4		-43.4	-41.25	2.2
	Non HT20, 6 to 54 Mbps	3	10	-62.2	-61.7	-61.5	-47.0	-41.25	5.8
	Non HT20 Beam Forming, 6 to 54 Mbps	2	10	-56.5	-56.4		-43.4	-41.25	2.2
	Non HT20 Beam Forming, 6 to 54 Mbps	3	13	-63.0	-62.6	-62.1	-44.8	-41.25	3.5
	HT/VHT20, M0 to M7	1	10	-52.3			-42.3	-41.25	1.1
	HT/VHT20, M0 to M7	2	10	-55.6	-55.4		-42.5	-41.25	1.2
	HT/VHT20, M8 to M15	2	10	-55.6	-55.4		-42.5	-41.25	1.2
	HT/VHT20, M0 to M7	3	10	-62.0	-61.7	-61.4	-46.9	-41.25	5.7
	HT/VHT20, M8 to M15	3	10	-59.7	-59.4	-57.2	-43.8	-41.25	2.6
	HT/VHT20 Beam Forming, M0 to M7	2	10	-55.6	-55.4		-42.5	-41.25	1.2
	HT/VHT20 Beam Forming, M8 to M15	2	10	-55.6	-55.4		-42.5	-41.25	1.2
	HT/VHT20 Beam Forming, M0 to M7	3	13	-62.5	-61.9	-61.6	-44.2	-41.25	3.0
	HT/VHT20 Beam Forming, M8 to M15	3	10	-59.7	-59.4	-57.2	-43.8	-41.25	2.6
	HT/VHT20 STBC, M0 to M7	2	10	-55.6	-55.4		-42.5	-41.25	1.2
HT/VHT20 STBC, M0 to M7	3	10	-59.7	-59.4	-57.2	-43.8	-41.25	2.6	
5510	Non HT40, 6 to 54 Mbps	1	10	-60.8			-50.8	-41.25	9.6
	Non HT40, 6 to 54 Mbps	2	10	-62.1	-61.9		-49.0	-41.25	7.7
	Non HT40, 6 to 54 Mbps	3	10	-64.3	-63.7	-64.0	-49.2	-41.25	8.0
	HT/VHT40, M0 to M7	1	10	-51.5			-41.5	-41.25	0.3
	HT/VHT40, M0 to M7	2	10	-57.3	-56.1		-43.6	-41.25	2.4
	HT/VHT40, M8 to M15	2	10	-57.3	-56.1		-43.6	-41.25	2.4
	HT/VHT40, M0 to M7	3	10	-59.7	-58.9	-58.5	-44.2	-41.25	3.0
	HT/VHT40, M8 to M15	3	10	-59.7	-58.9	-58.5	-44.2	-41.25	3.0
	HT/VHT40 Beam Forming, M0 to M7	2	10	-57.3	-56.1		-43.6	-41.25	2.4
	HT/VHT40 Beam Forming, M8 to M15	2	10	-57.3	-56.1		-43.6	-41.25	2.4
	HT/VHT40 Beam Forming, M0 to M7	3	13	-64.1	-64.2	-64.2	-46.4	-41.25	5.1
	HT/VHT40 Beam Forming, M8 to M15	3	10	-59.7	-58.9	-58.5	-44.2	-41.25	3.0
	HT/VHT40 STBC, M0 to M7	2	10	-57.3	-56.1		-43.6	-41.25	2.4
	HT/VHT40 STBC, M0 to M7	3	10	-59.7	-58.9	-58.5	-44.2	-41.25	3.0



5530	Non HT80, 6 to 54 Mbps	1	10	-51.8			-41.8	-41.25	0.5
	Non HT80, 6 to 54 Mbps	2	10	-54.9	-54.4		-41.6	-41.25	0.4
	Non HT80, 6 to 54 Mbps	3	10	-61.3	-60.7	-54.7	-43.0	-41.25	1.8
	VHT80, M0 to M9 1ss	1	10	-52.6			-42.6	-41.25	1.4
	VHT80, M0 to M9 1ss	2	10	-55.5	-54.0		-41.7	-41.25	0.4
	VHT80, M0 to M9 2ss	2	10	-55.5	-54.0		-41.7	-41.25	0.4
	VHT80, M0 to M9 1ss	3	10	-58.1	-56.9	-55.1	-41.8	-41.25	0.5
	VHT80, M0 to M9 2ss	3	10	-58.1	-56.9	-55.1	-41.8	-41.25	0.5
	VHT80 Beam Forming, M0 to M9 1ss	2	10	-55.5	-54.0		-41.7	-41.25	0.4
	VHT80 Beam Forming, M0 to M9 2ss	2	10	-55.5	-54.0		-41.7	-41.25	0.4
	VHT80 Beam Forming, M0 to M9 1ss	3	13	-62.5	-60.8	-59.1	-42.8	-41.25	1.6
	VHT80 Beam Forming, M0 to M9 2ss	3	10	-58.1	-56.9	-55.1	-41.8	-41.25	0.5
	VHT80 STBC, M0 to M9 1ss	2	10	-55.5	-54.0		-41.7	-41.25	0.4
	VHT80 STBC, M0 to M9 1ss	3	10	-58.1	-56.9	-55.1	-41.8	-41.25	0.5



**Conducted Bandedge Average, 5500 MHz, Non HT20, 6 to 54 Mbps**



**Antenna A**



**Antenna Gain: 4 dBi**

Frequency (MHz)	Mode	Tx Paths	Correlated Antenna Gain (dBi)	Tx 1 Bandedge Level (dBm)	Tx 2 Bandedge Level (dBm)	Tx 3 Bandedge Level (dBm)	Total Tx Bandedge Level (dBm)	Limit (dBm)	Margin (dB)
5500	Non HT20, 6 to 54 Mbps	1	4	-31.8			-27.8	-21.25	6.6
	Non HT20, 6 to 54 Mbps	2	4	-32.4	-35.3		-26.6	-21.25	5.4
	Non HT20, 6 to 54 Mbps	3	4	-39.1	-42.5	-42.4	-32.3	-21.25	11.0
	Non HT20 Beam Forming, 6 to 54 Mbps	2	7	-34.9	-36.4		-25.6	-21.25	4.3
	Non HT20 Beam Forming, 6 to 54 Mbps	3	9	-39.1	-42.5	-42.4	-27.3	-21.25	6.0
	HT/VHT20, M0 to M7	1	4	-30.3			-26.3	-21.25	5.1
	HT/VHT20, M0 to M7	2	4	-30.4	-34.1		-24.9	-21.25	3.6
	HT/VHT20, M8 to M15	2	4	-30.4	-34.1		-24.9	-21.25	3.6
	HT/VHT20, M0 to M7	3	4	-36.5	-38.0	-39.1	-29.0	-21.25	7.7
	HT/VHT20, M8 to M15	3	4	-32.2	-36.2	-33.3	-24.8	-21.25	3.6
	HT/VHT20 Beam Forming, M0 to M7	2	7	-33.6	-37.5		-25.1	-21.25	3.9
	HT/VHT20 Beam Forming, M8 to M15	2	4	-30.4	-34.1		-24.9	-21.25	3.6
	HT/VHT20 Beam Forming, M0 to M7	3	9	-40.7	-38.6	-40.7	-26.1	-21.25	4.9
	HT/VHT20 Beam Forming, M8 to M15	3	6	-33.6	-37.5	-33.6	-23.8	-21.25	2.5
	HT/VHT20 STBC, M0 to M7	2	4	-30.4	-34.1		-24.9	-21.25	3.6
HT/VHT20 STBC, M0 to M7	3	4	-32.2	-36.2	-33.3	-24.8	-21.25	3.6	
5510	Non HT40, 6 to 54 Mbps	1	4	-26.9			-22.9	-21.25	1.7
	Non HT40, 6 to 54 Mbps	2	4	-29.5	-28.5		-22.0	-21.25	0.7
	<b>Non HT40, 6 to 54 Mbps</b>	<b>3</b>	<b>4</b>	<b>-30.4</b>	<b>-30.5</b>	<b>-29.9</b>	<b>-21.5</b>	<b>-21.25</b>	<b>0.2</b>
	HT/VHT40, M0 to M7	1	4	-29.1			-25.1	-21.25	3.9
	HT/VHT40, M0 to M7	2	4	-28.9	-29.7		-22.3	-21.25	1.0
	HT/VHT40, M8 to M15	2	4	-28.9	-29.7		-22.3	-21.25	1.0
	HT/VHT40, M0 to M7	3	4	-32.2	-34.3	-30.0	-23.0	-21.25	1.8
	HT/VHT40, M8 to M15	3	4	-32.2	-34.3	-30.0	-23.0	-21.25	1.8
	HT/VHT40 Beam Forming, M0 to M7	2	7	-31.8	-35.0		-23.1	-21.25	1.9
	HT/VHT40 Beam Forming, M8 to M15	2	4	-28.9	-29.7		-22.3	-21.25	1.0
	HT/VHT40 Beam Forming, M0 to M7	3	9	-35.0	-38.4	-34.9	-22.1	-21.25	0.8
	HT/VHT40 Beam Forming, M8 to M15	3	6	-32.6	-31.8	-33.7	-21.9	-21.25	0.6
	HT/VHT40 STBC, M0 to M7	2	4	-28.9	-29.7		-22.3	-21.25	1.0
	HT/VHT40 STBC, M0 to M7	3	4	-32.2	-34.3	-30.0	-23.0	-21.25	1.8



5530	Non HT80, 6 to 54 Mbps	1	4	-33.0			-29.0	-21.25	7.8
	Non HT80, 6 to 54 Mbps	2	4	-34.9	-36.5		-28.6	-21.25	7.4
	Non HT80, 6 to 54 Mbps	3	4	-36.2	-33.7	-36.6	-26.5	-21.25	5.3
	VHT80, M0 to M9 1ss	1	4	-29.3			-25.3	-21.25	4.1
	VHT80, M0 to M9 1ss	2	4	-32.5	-35.3		-26.7	-21.25	5.4
	VHT80, M0 to M9 2ss	2	4	-32.5	-35.3		-26.7	-21.25	5.4
	VHT80, M0 to M9 1ss	3	4	-32.0	-36.1	-36.0	-25.5	-21.25	4.2
	VHT80, M0 to M9 2ss	3	4	-32.0	-36.1	-36.0	-25.5	-21.25	4.2
	VHT80 Beam Forming, M0 to M9 1ss	2	7	-32.0	-36.1		-23.6	-21.25	2.3
	VHT80 Beam Forming, M0 to M9 2ss	2	4	-32.5	-35.3		-26.7	-21.25	5.4
	VHT80 Beam Forming, M0 to M9 1ss	3	9	-38.4	-37.0	-34.7	-22.7	-21.25	1.4
	VHT80 Beam Forming, M0 to M9 2ss	3	6	-33.9	-32.9	-36.7	-23.5	-21.25	2.2
	VHT80 STBC, M0 to M9 1ss	2	4	-32.5	-35.3		-26.7	-21.25	5.4
	VHT80 STBC, M0 to M9 1ss	3	4	-32.0	-36.1	-36.0	-25.5	-21.25	4.2

**Conducted Bandedge Peak, 5510 MHz, Non HT40, 6 to 54 Mbps**

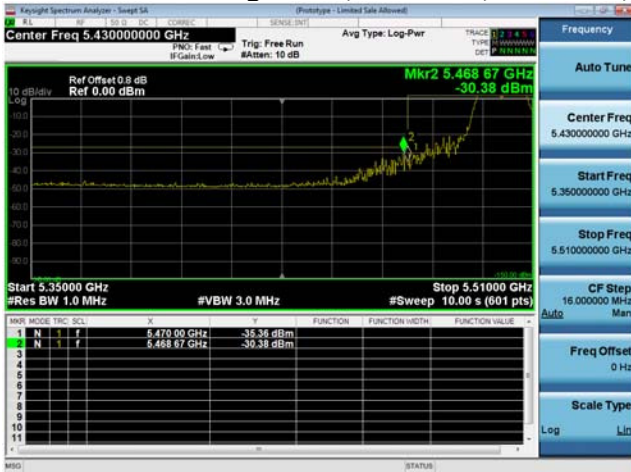

**Antenna A**

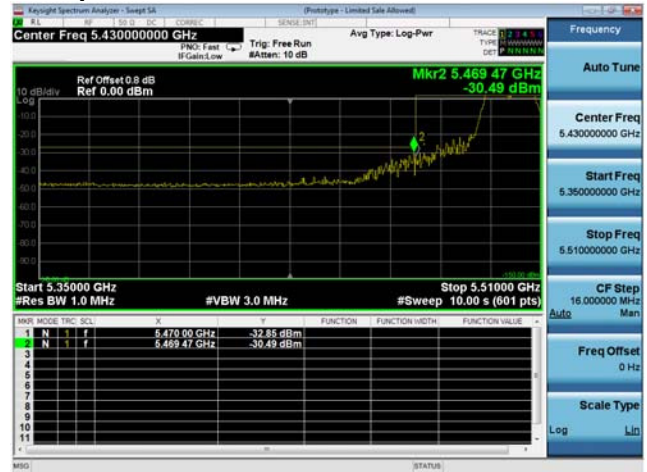

**Antenna B**



**Antenna C**



**Antenna Gain: 10 dBi**

Frequency (MHz)	Mode	Tx Paths	Correlated Antenna Gain (dBi)	Tx 1 Bandedge Level (dBm)	Tx 2 Bandedge Level (dBm)	Tx 3 Bandedge Level (dBm)	Total Tx Bandedge Level (dBm)	Limit (dBm)	Margin (dB)
5500	Non HT20, 6 to 54 Mbps	1	10	-34.9			-24.9	-21.25	3.7
	Non HT20, 6 to 54 Mbps	2	10	-40.1	-38.9		-26.4	-21.25	5.2
	Non HT20, 6 to 54 Mbps	3	10	-45.7	-43.0	-41.7	-28.4	-21.25	7.1
	Non HT20 Beam Forming, 6 to 54 Mbps	2	10	-40.1	-38.9		-26.4	-21.25	5.2
	Non HT20 Beam Forming, 6 to 54 Mbps	3	13	-43.0	-45.4	-43.9	-26.2	-21.25	5.0
	HT/VHT20, M0 to M7	1	10	-33.6			-23.6	-21.25	2.4
	HT/VHT20, M0 to M7	2	10	-36.5	-38.0		-24.2	-21.25	2.9
	HT/VHT20, M8 to M15	2	10	-36.5	-38.0		-24.2	-21.25	2.9
	HT/VHT20, M0 to M7	3	10	-42.4	-45.9	-41.2	-28.0	-21.25	6.7
	HT/VHT20, M8 to M15	3	10	-40.7	-38.6	-40.7	-25.1	-21.25	3.9
	HT/VHT20 Beam Forming, M0 to M7	2	10	-36.5	-38.0		-24.2	-21.25	2.9
	HT/VHT20 Beam Forming, M8 to M15	2	10	-36.5	-38.0		-24.2	-21.25	2.9
	HT/VHT20 Beam Forming, M0 to M7	3	13	-42.2	-42.9	-39.9	-23.7	-21.25	2.4
	HT/VHT20 Beam Forming, M8 to M15	3	10	-40.7	-38.6	-40.7	-25.1	-21.25	3.9
	HT/VHT20 STBC, M0 to M7	2	10	-36.5	-38.0		-24.2	-21.25	2.9
HT/VHT20 STBC, M0 to M7	3	10	-40.7	-38.6	-40.7	-25.1	-21.25	3.9	
5510	Non HT40, 6 to 54 Mbps	1	10	-31.7			-21.7	-21.25	0.5
	<b>Non HT40, 6 to 54 Mbps</b>	<b>2</b>	<b>10</b>	<b>-36.1</b>	<b>-33.0</b>		<b>-21.3</b>	<b>-21.25</b>	<b>0.0</b>
	Non HT40, 6 to 54 Mbps	3	10	-37.2	-36.6	-36.3	-21.9	-21.25	0.7
	HT/VHT40, M0 to M7	1	10	-32.2			-22.2	-21.25	1.0
	HT/VHT40, M0 to M7	2	10	-35.1	-34.4		-21.7	-21.25	0.5
	HT/VHT40, M8 to M15	2	10	-35.1	-34.4		-21.7	-21.25	0.5
	HT/VHT40, M0 to M7	3	10	-35.5	-35.5	-38.0	-21.4	-21.25	0.2
	HT/VHT40, M8 to M15	3	10	-35.5	-35.5	-38.0	-21.4	-21.25	0.2
	HT/VHT40 Beam Forming, M0 to M7	2	10	-35.1	-34.4		-21.7	-21.25	0.5
	HT/VHT40 Beam Forming, M8 to M15	2	10	-35.1	-34.4		-21.7	-21.25	0.5
	HT/VHT40 Beam Forming, M0 to M7	3	13	-38.9	-37.5	-42.5	-21.4	-21.25	0.2
	HT/VHT40 Beam Forming, M8 to M15	3	10	-35.5	-35.5	-38.0	-21.4	-21.25	0.2
	HT/VHT40 STBC, M0 to M7	2	10	-35.1	-34.4		-21.7	-21.25	0.5
HT/VHT40 STBC, M0 to M7	3	10	-35.5	-35.5	-38.0	-21.4	-21.25	0.2	



5530	Non HT80, 6 to 54 Mbps	1	10	-36.2			-26.2	-21.25	5.0
	Non HT80, 6 to 54 Mbps	2	10	-35.1	-36.6		-22.8	-21.25	1.5
	Non HT80, 6 to 54 Mbps	3	10	-39.9	-38.5	-38.2	-24.0	-21.25	2.8
	VHT80, M0 to M9 1ss	1	10	-32.0			-22.0	-21.25	0.8
	VHT80, M0 to M9 1ss	2	10	-35.8	-39.8		-24.3	-21.25	3.1
	VHT80, M0 to M9 2ss	2	10	-35.8	-39.8		-24.3	-21.25	3.1
	VHT80, M0 to M9 1ss	3	10	-37.6	-41.1	-36.0	-23.0	-21.25	1.7
	VHT80, M0 to M9 2ss	3	10	-37.6	-41.1	-36.0	-23.0	-21.25	1.7
	VHT80 Beam Forming, M0 to M9 1ss	2	10	-35.8	-39.8		-24.3	-21.25	3.1
	VHT80 Beam Forming, M0 to M9 2ss	2	10	-35.8	-39.8		-24.3	-21.25	3.1
	VHT80 Beam Forming, M0 to M9 1ss	3	13	-42.4	-44.6	-37.9	-22.9	-21.25	1.7
	VHT80 Beam Forming, M0 to M9 2ss	3	10	-37.6	-41.1	-36.0	-23.0	-21.25	1.7
	VHT80 STBC, M0 to M9 1ss	2	10	-35.8	-39.8		-24.3	-21.25	3.1
	VHT80 STBC, M0 to M9 1ss	3	10	-37.6	-41.1	-36.0	-23.0	-21.25	1.7

**Conducted Bandedge Peak, 5510 MHz, Non HT40, 6 to 54 Mbps**

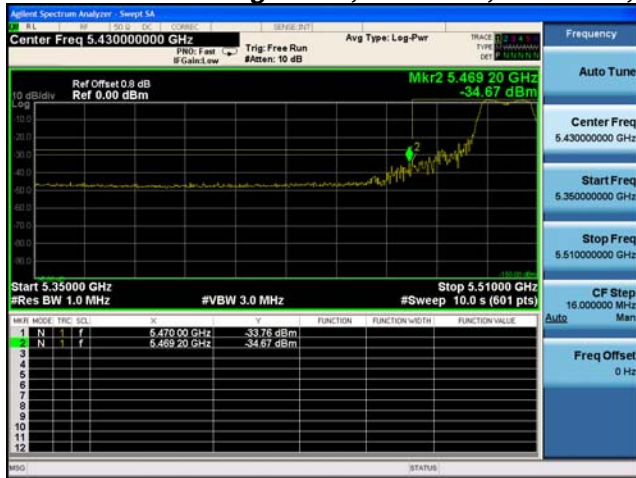

**Antenna A**



**Antenna B**



**Title:** Physical Test Arrangement Photograph

This is a dual band 2.4GHz / 5GHz device. All ports in this test set up photo are connected as all testing is automated. Section 2.6 of this test report given an overview of the different Tx antenna combinations used by this device.



### Appendix B: Emission Test Results

Testing Laboratory: Cisco Systems, Inc., 125 West Tasman Drive, San Jose, CA 95134, USA

## Radiated Emission Setup Diagram-Below 1G

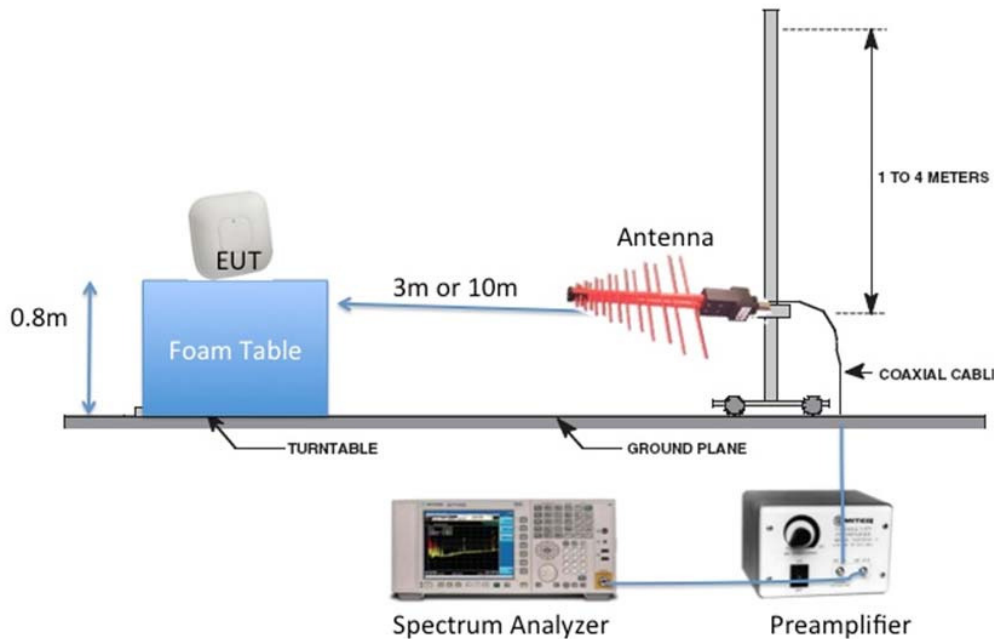

## Radiated Emission Setup Diagram-Above 1G

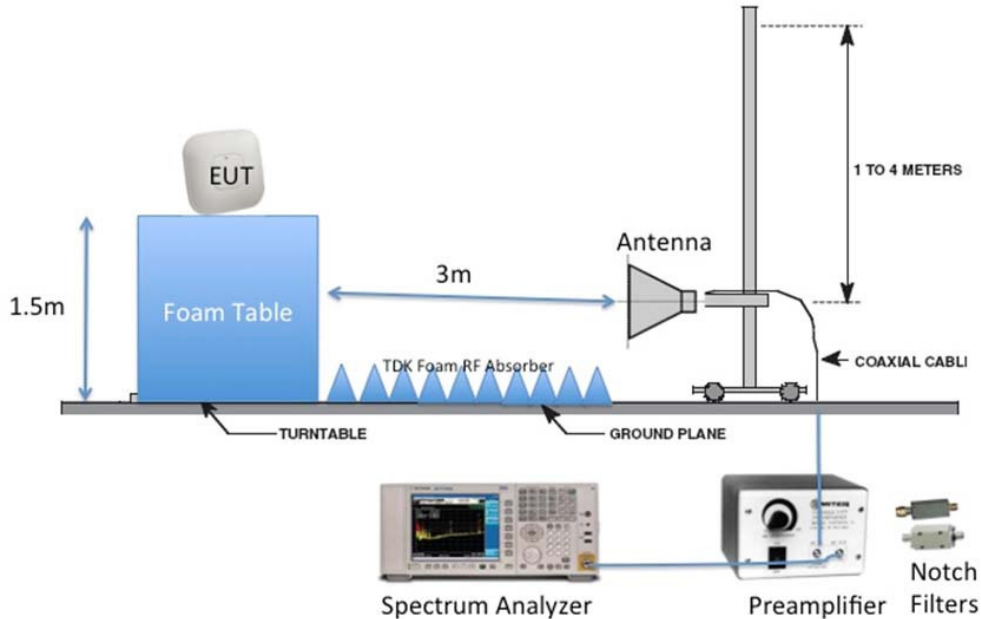



## B.1 Radiated Spurious Emissions

**15.407 (b) Undesirable emission limits.** Except as shown in paragraph (b) (7) of this section, the maximum emissions outside of the frequency bands of operation shall be attenuated in accordance with the following limits:

(3) For transmitters operating in the 5.47-5.725 GHz band: All emissions outside of the 5.47-5.725 GHz band shall not exceed an e.i.r.p. of -27 dBm/MHz.

### 15.205 / 15.209

(7) The provisions of 15.205 apply to intentional radiators operating under this section.

(6) Unwanted emissions below 1 GHz must comply with the general field strength limits set forth in 15.209.

**Ref.** ANSI C63.10: 2013 section 12.7.6 (peak) & 12.7.7.3 (average)

Using Vasona, configure the spectrum analyzer as shown below (be sure to enter all losses between the transmitter output and the spectrum analyzer). Place the radio in continuous transmit mode.

Span:	1GHz – 18 GHz/18GHz-26G/26GHz-40GHz
Reference Level:	80 dBuV
Attenuation:	10 dB
Sweep Time:	Coupled
Resolution Bandwidth:	1MHz
Video Bandwidth:	3 MHz for peak, 1 KHz for average
Detector:	Peak

Terminate the access Point RF ports with 50 ohm loads.

Maximize Turntable (find worst case table angle), Maximize Antenna (find worst case height)

Save 2 plots:     1) Average plot (Vertical and Horizontal), Limit= 54dBuV/m @3m  
                       2) Peak plot (Vertical and Horizontal), Limit = 74dBuV/m @3m

Place a marker at the end of the restricted band closest to the transmit frequency to show compliance. Also measure any emissions in the restricted bands.

This report represents the worst case data for all supported operating modes and antennas. There are no measurable emissions above 18 GHz.

System Number	Description	Samples	System under test	Support equipment
1	EUT	S01	<input checked="" type="checkbox"/>	<input type="checkbox"/>
	Support	S02	<input type="checkbox"/>	<input checked="" type="checkbox"/>

<b>Tested By :</b> Jose Aguirre	<b>Date of testing:</b> 20-April-16 - 08-Aug-16
<b>Test Result : PASS</b>	

See Appendix C for list of test equipment

### B.1.A Transmitter Radiated Spurious Emissions-Average Worst Case

Frequency (MHz)	Mode	Data Rate (Mbps)	Spurious Emission Level (dBuV/m)	Limit (dBuV/m)	Margin (MHz)
5500	HT/VHT20, M0 to M23	m0	49.8	54.0	4.2
5510	HT/VHT40, M0 to M23	m0	50.8	54.0	3.2
5530	VHT80, M0 to M9	m0x1	52.8	54.0	1.2
5550	HT/VHT40, M0 to M23	m0	50.7	54.0	3.3
5560	HT/VHT20, M0 to M23	m0	50.2	54.0	3.8
5610	VHT80, M0 to M9	m0x1	50.7	54.0	3.3
5670	HT/VHT40, M0 to M23	m0	50.8	54.0	3.2
5690	VHT80, M0 to M9	m0x1	50.7	54.0	3.3
5700	HT/VHT20, M0 to M23	m0	49.7	54.0	4.3
5710	HT/VHT40, M0 to M23	m0	50.8	54.0	3.2
5720	HT/VHT20, M0 to M23	m0	50.2	54.0	3.8

**Average Radiated Transmitter Spurs, 5500 MHz, HT/VHT20, M0 to M23**



**Average Radiated Transmitter Spurs, 5510 MHz, HT/VHT40, M0 to M23**

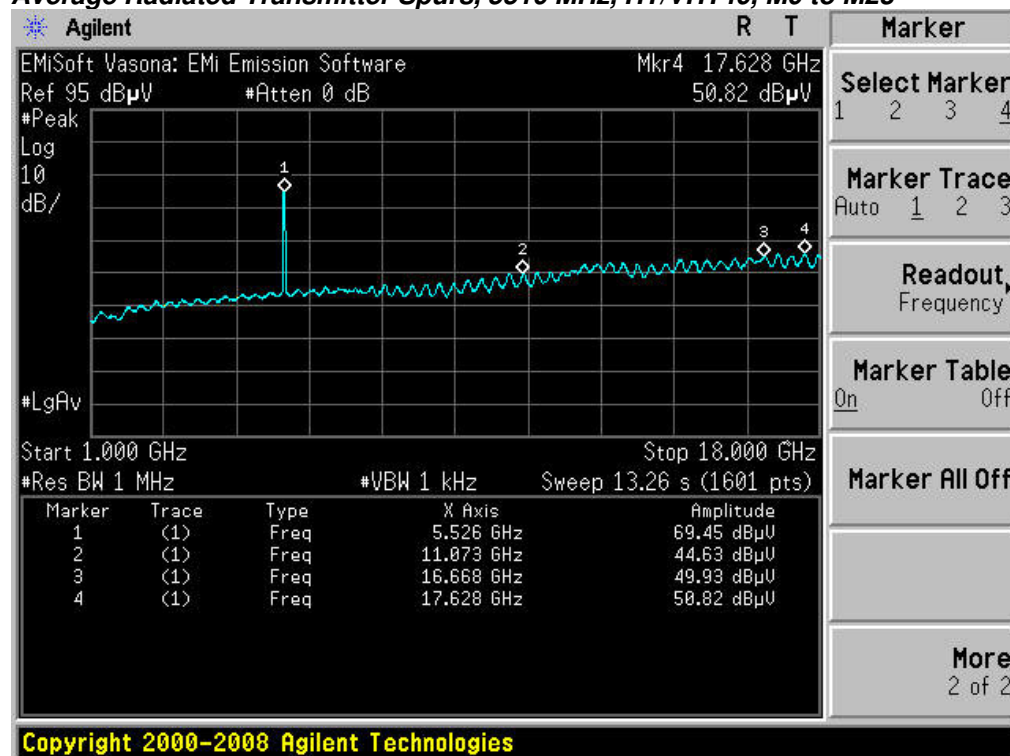

Copyright 2000-2008 Agilent Technologies

**Average Radiated Transmitter Spurs, 5530 MHz, VHT80, M0 to M9**

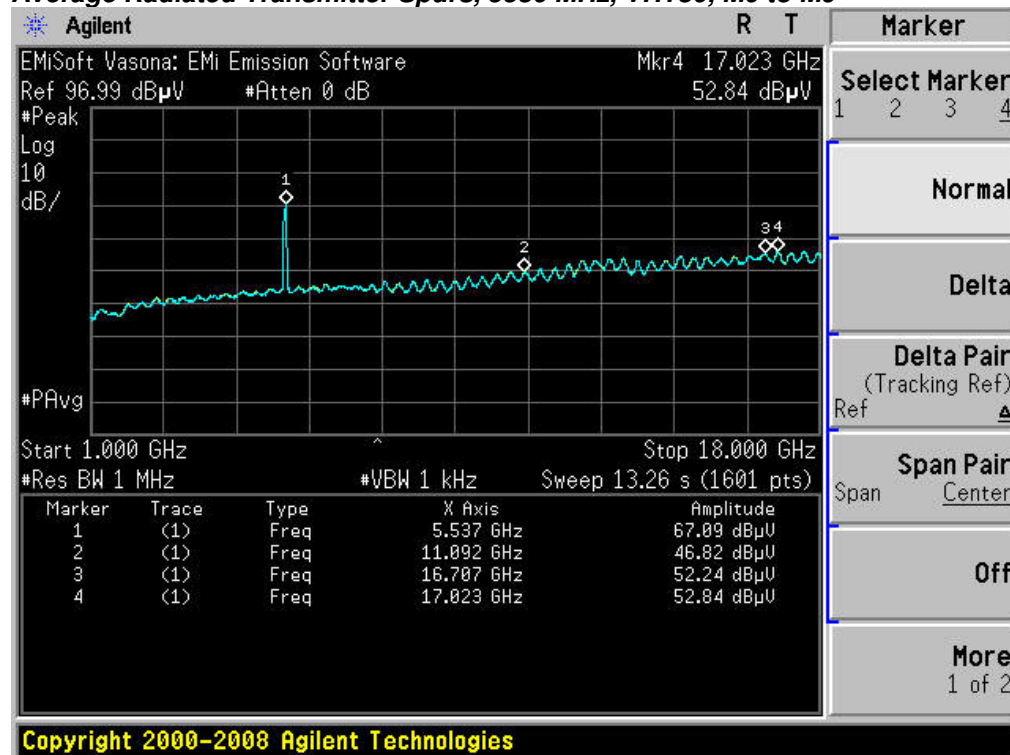

**Average Radiated Transmitter Spurs, 5550 MHz, HT/VHT40, M0 to M23**

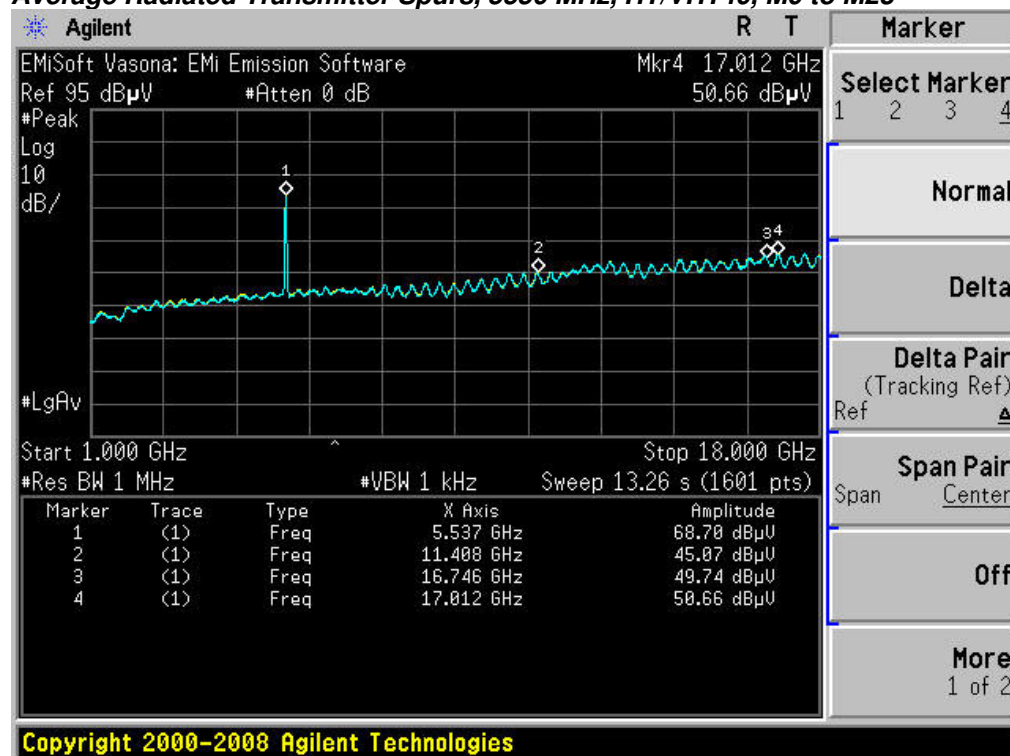

**Average Radiated Transmitter Spurs, 5560 MHz, HT/VHT20, M0 to M23**

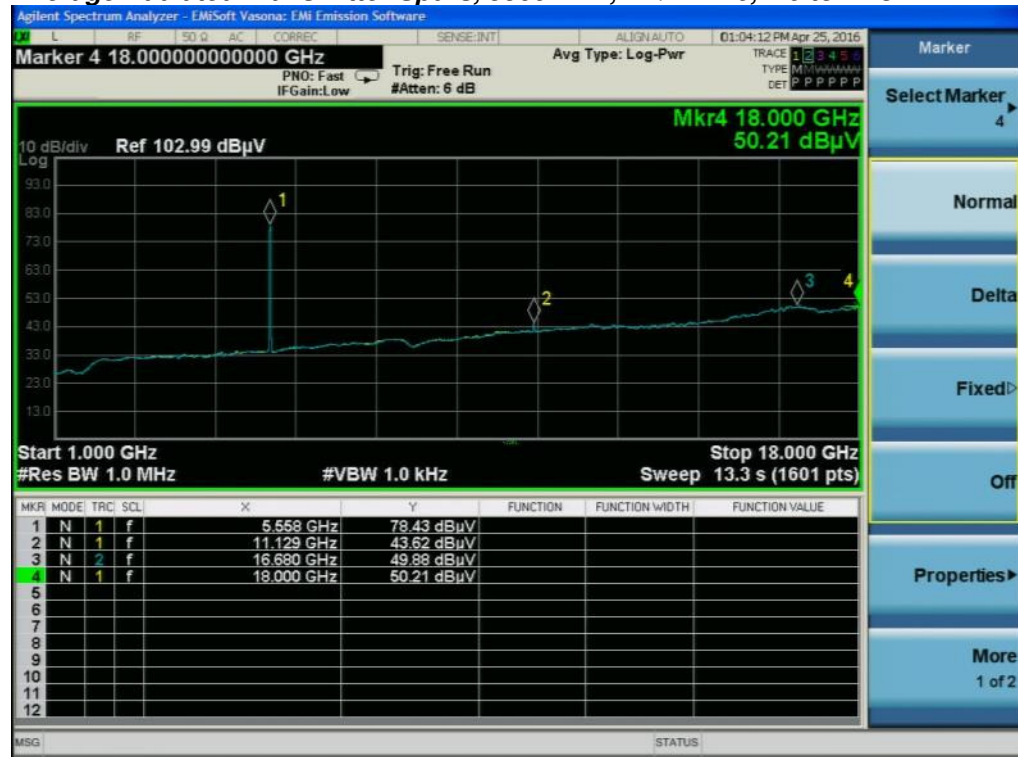

**Average Radiated Transmitter Spurs, 5610 MHz, VHT80, M0 to M9**

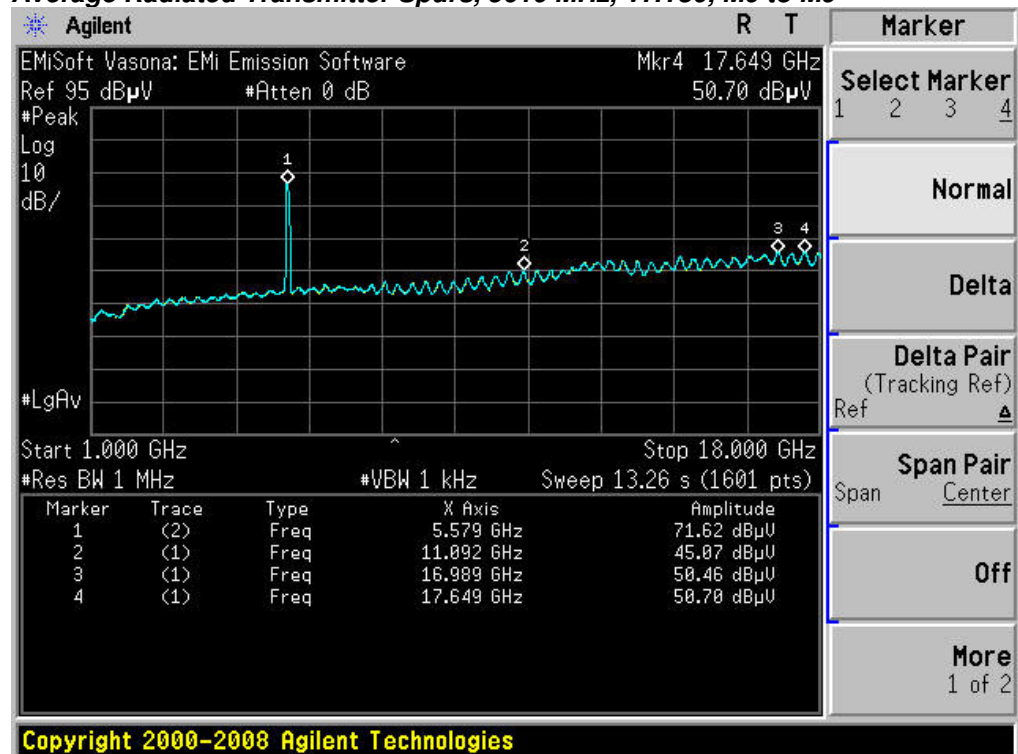

Copyright 2000-2008 Agilent Technologies

**Average Radiated Transmitter Spurs, 5670 MHz, HT/VHT40, M0 to M23**

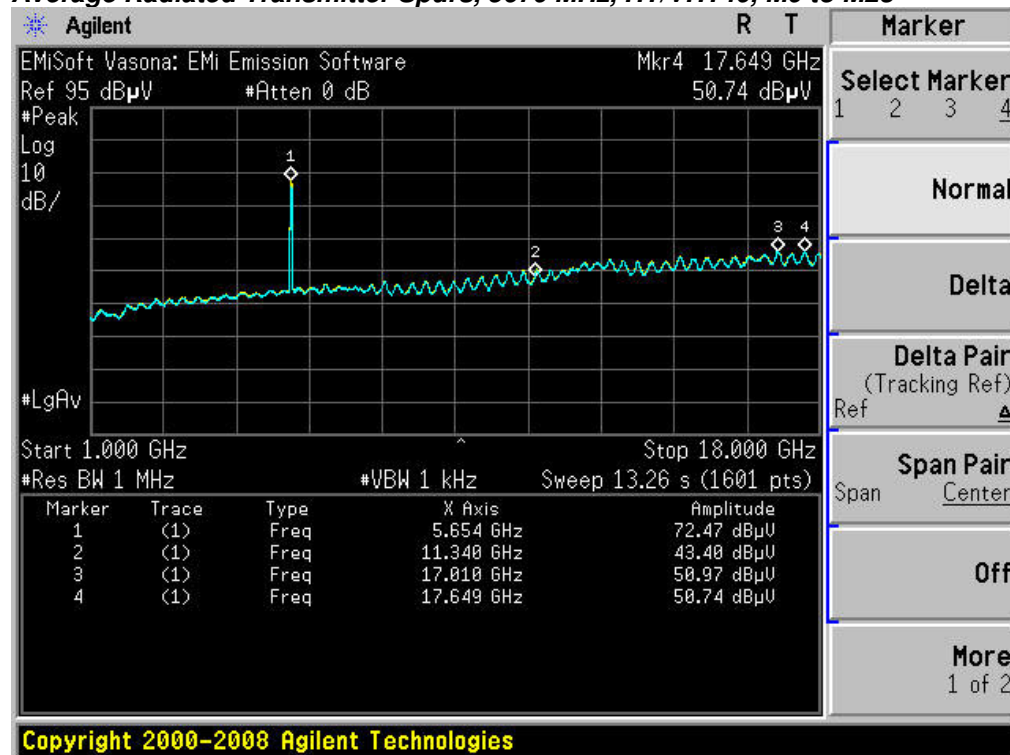

**Average Radiated Transmitter Spurs, 5690 MHz, VHT80, M0 to M9**

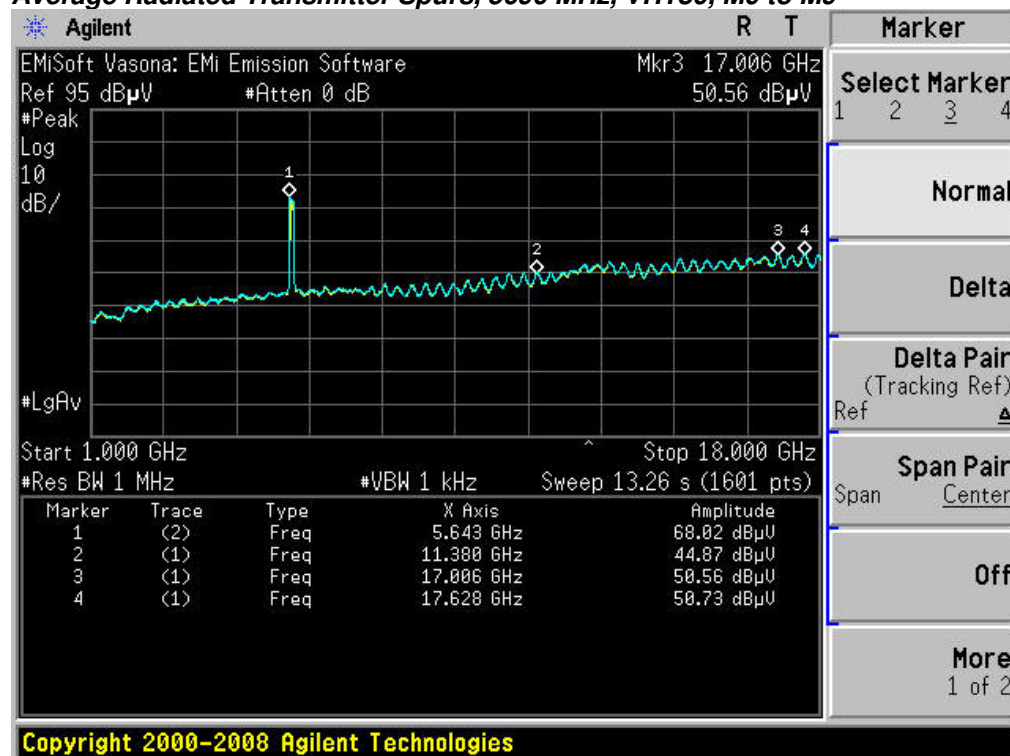

**Average Radiated Transmitter Spurs, 5700 MHz, HT/VHT20, M0 to M23**

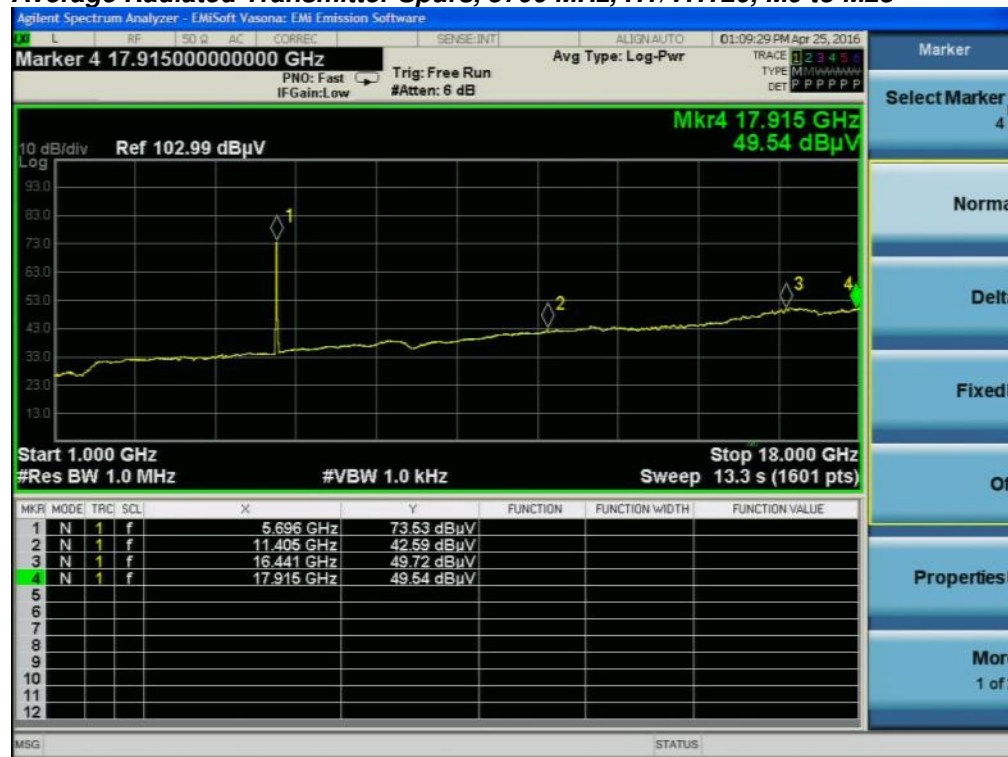

**Average Radiated Transmitter Spurs, 5710 MHz, HT/VHT40, M0 to M23**

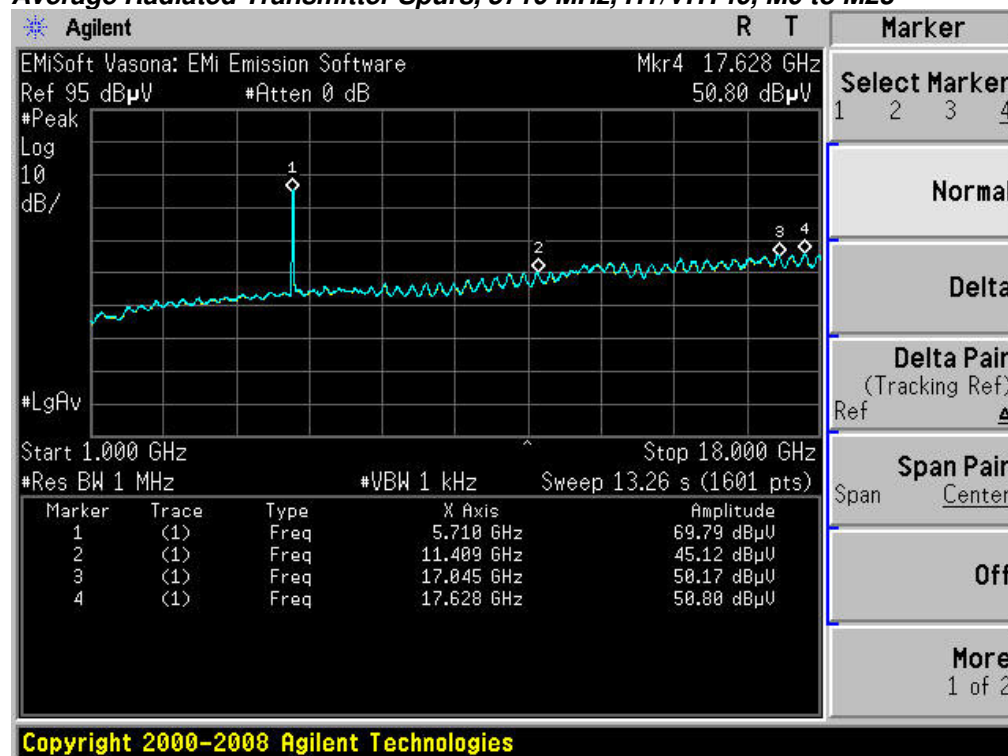





**Average Radiated Transmitter Spurs, 5720 MHz, HT/VHT20, M0 to M23**



**Average Radiated Transmitter Spurs, All modes, All rates, 18-26GHz**

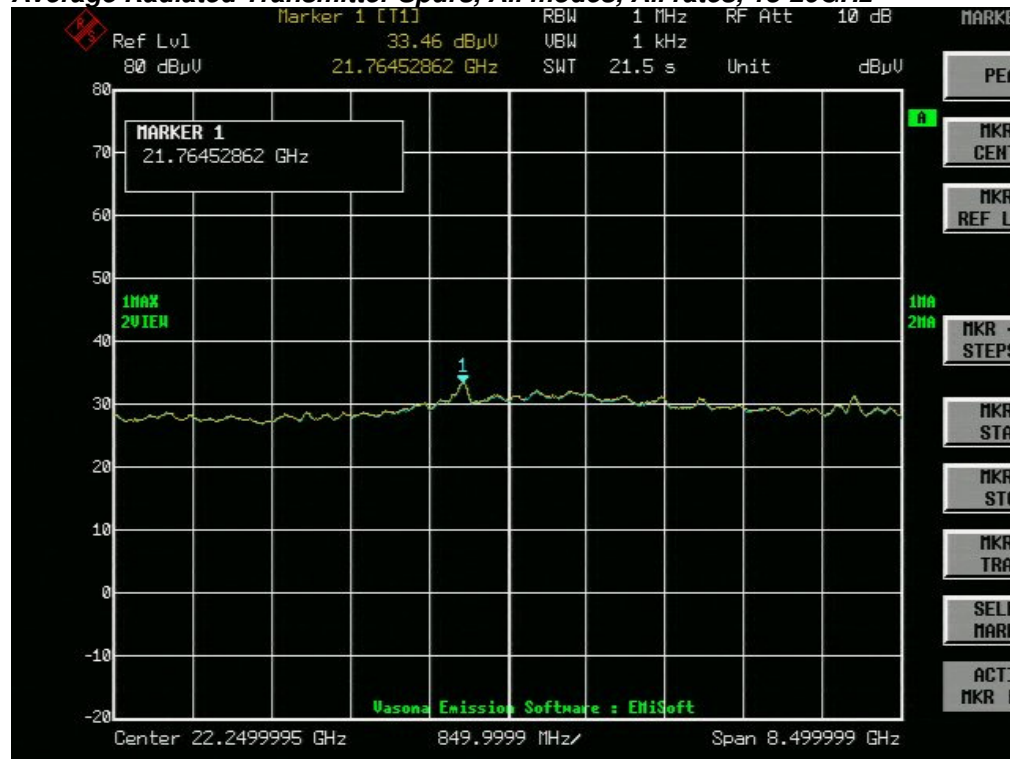

**Average Radiated Transmitter Spurs, All modes, All rates, 26-40GHz**

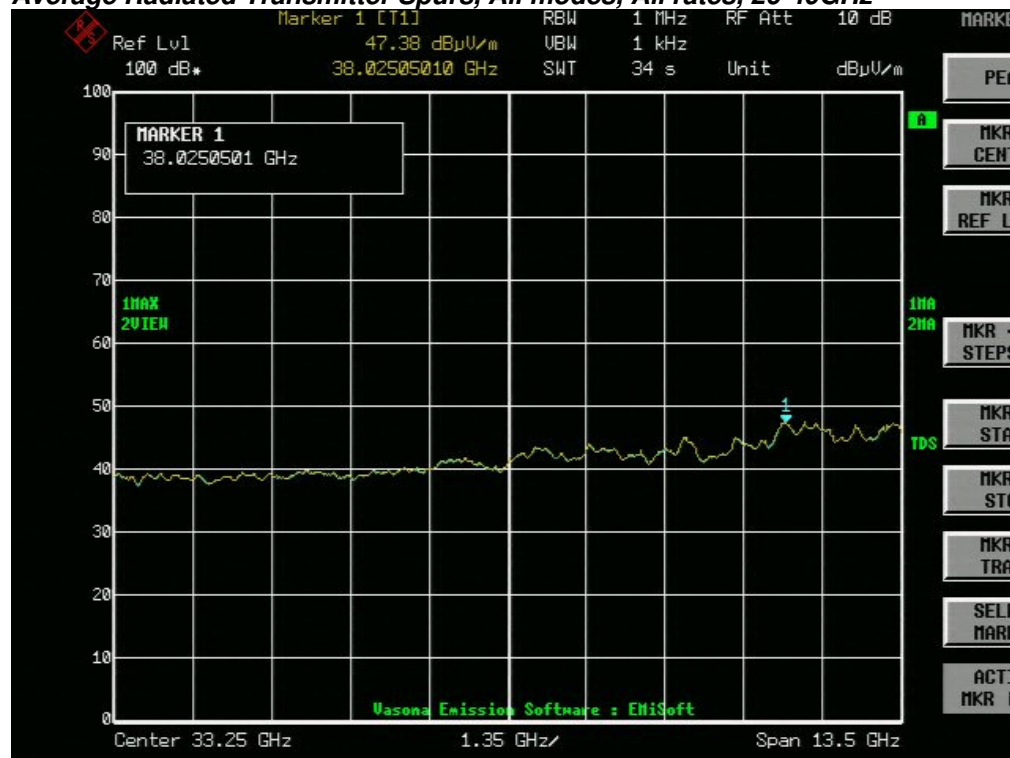

**B.1.P Transmitter Radiated Spurious Emissions-Peak Worst Case**

Frequency (MHz)	Mode	Data Rate (Mbps)	Spurious Emission Level (dBuV/m)	Limit (dBuV/m)	Margin (MHz)
5500	HT/VHT20, M0 to M23	m0	63.4	74.0	10.6
5510	HT/VHT40, M0 to M23	m0	63.2	74.0	10.8
5530	VHT80, M0 to M9	m0x1	62.1	74.0	11.9
5550	HT/VHT40, M0 to M23	m0	63.5	74.0	10.5
5560	HT/VHT20, M0 to M23	m0	62.0	74.0	12.0
5610	VHT80, M0 to M9	m0x1	61.8	74.0	12.2
5670	HT/VHT40, M0 to M23	m0	62.9	74.0	11.1
5690	VHT80, M0 to M9	m0x1	62.7	74.0	11.3
5700	HT/VHT20, M0 to M23	m0	62.6	74.0	11.4
5710	HT/VHT40, M0 to M23	m0	62.5	74.0	11.5
5720	HT/VHT20, M0 to M23	m0	63.2	74.0	10.8

**Peak Radiated Transmitter Spurs, 5500 MHz, HT/VHT20, M0 to M23**



**Peak Radiated Transmitter Spurs, 5510 MHz, HT/VHT40, M0 to M23**

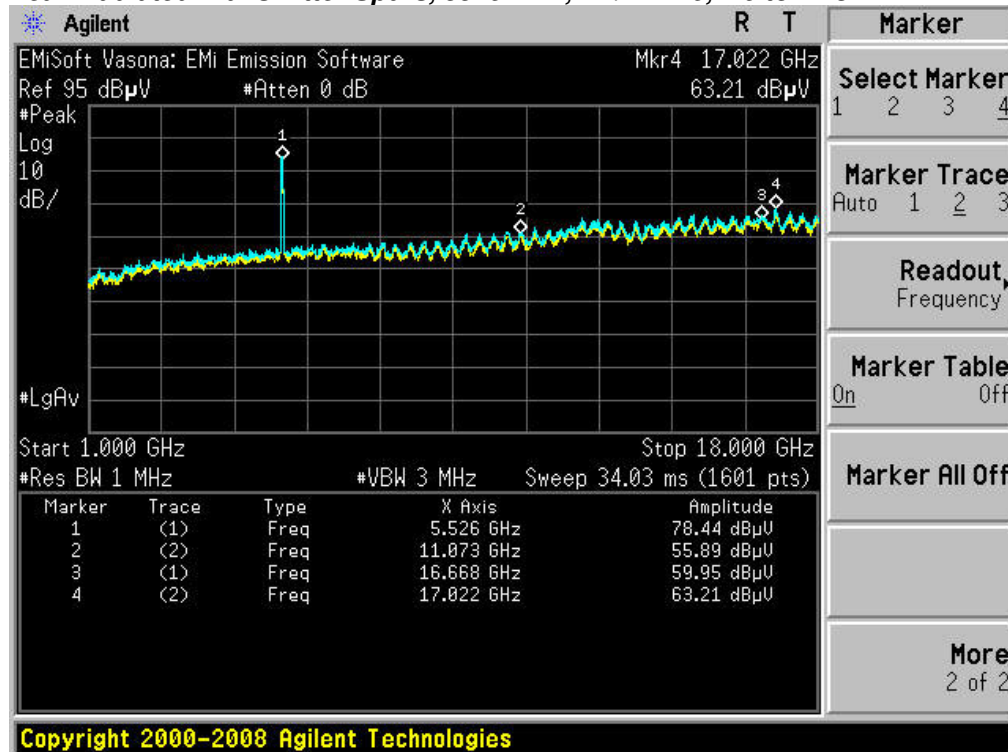

Copyright 2000-2008 Agilent Technologies

**Peak Radiated Transmitter Spurs, 5530 MHz, VHT80, M0 to M9**

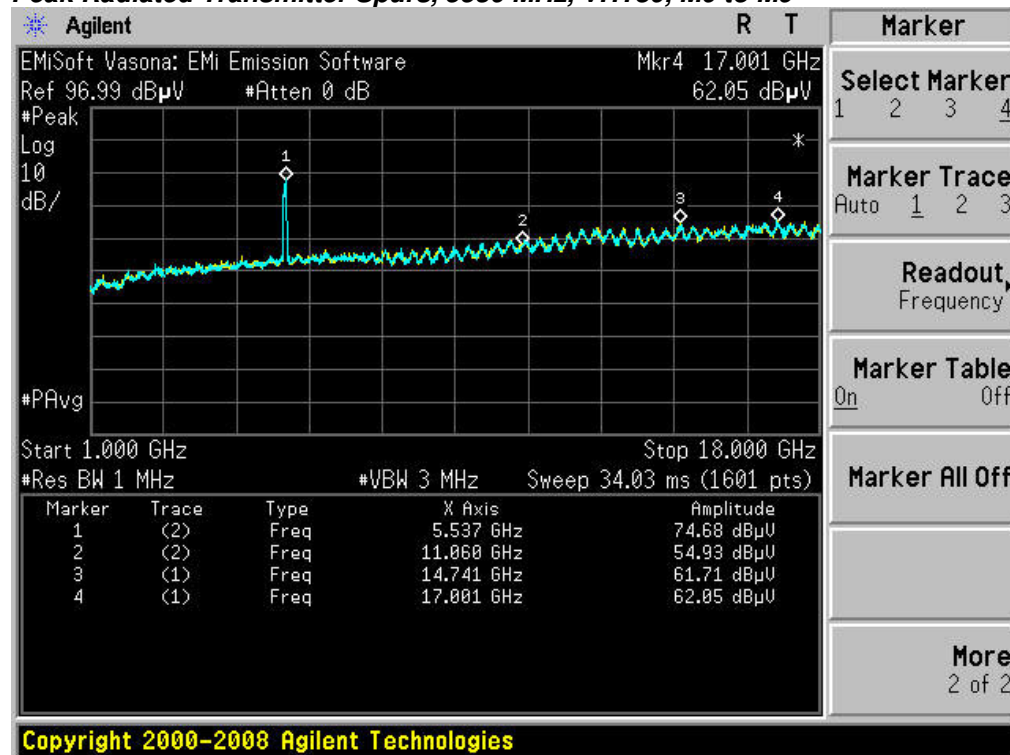

**Peak Radiated Transmitter Spurs, 5550 MHz, HT/VHT40, M0 to M23**

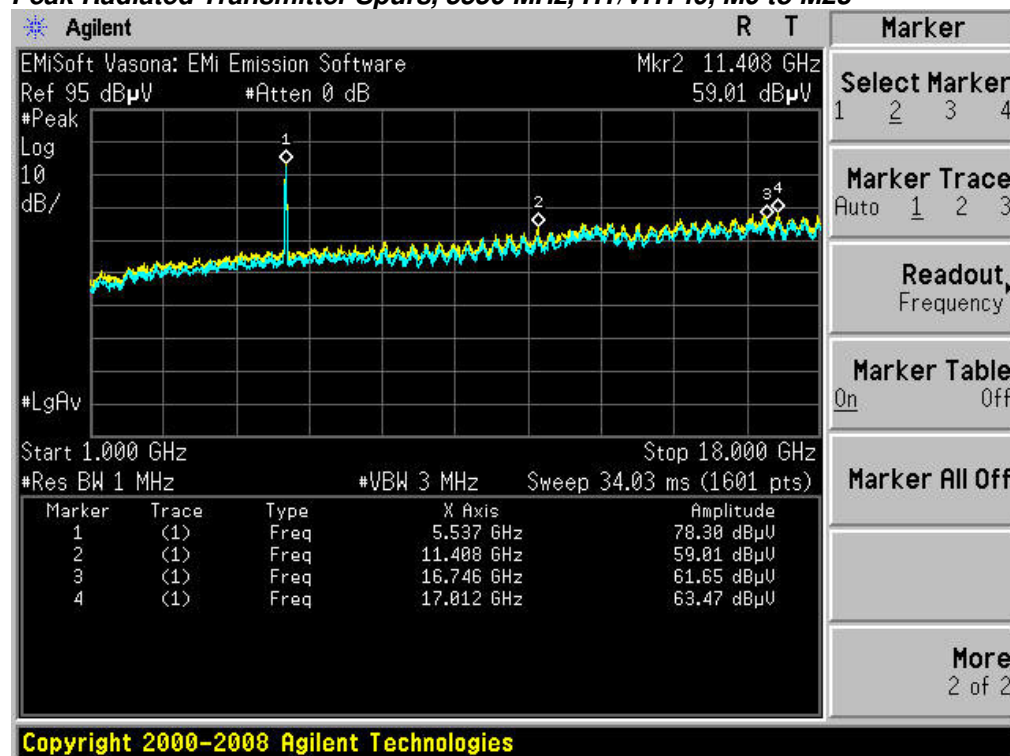

**Peak Radiated Transmitter Spurs, 5560 MHz, HT/VHT20, M0 to M23**

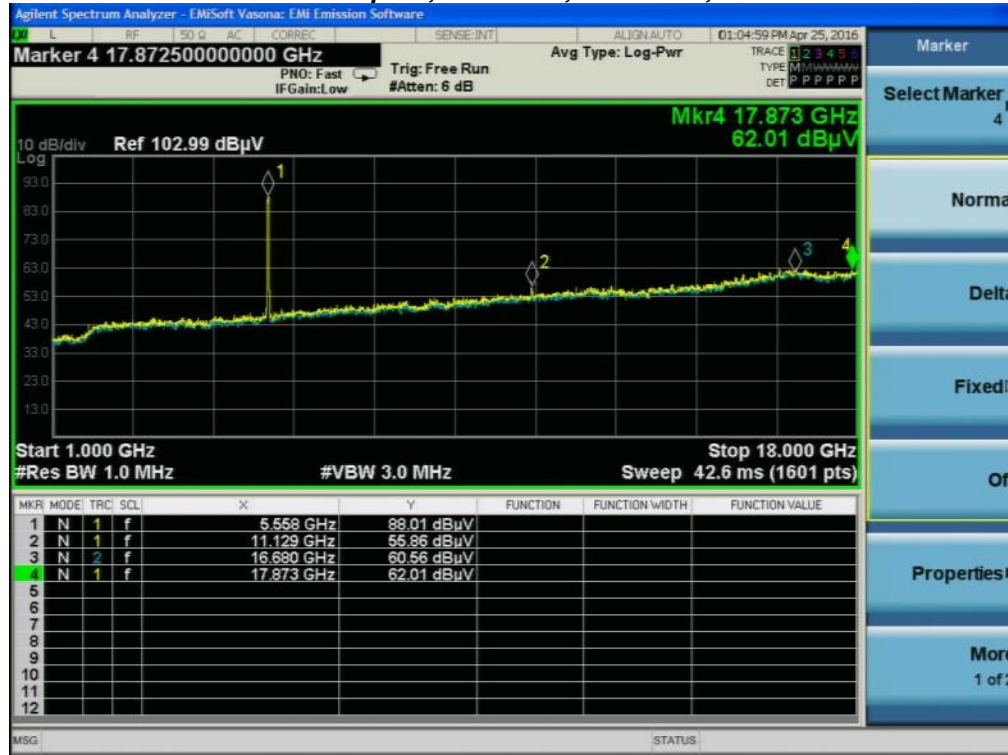

**Peak Radiated Transmitter Spurs, 5610 MHz, VHT80, M0 to M9**

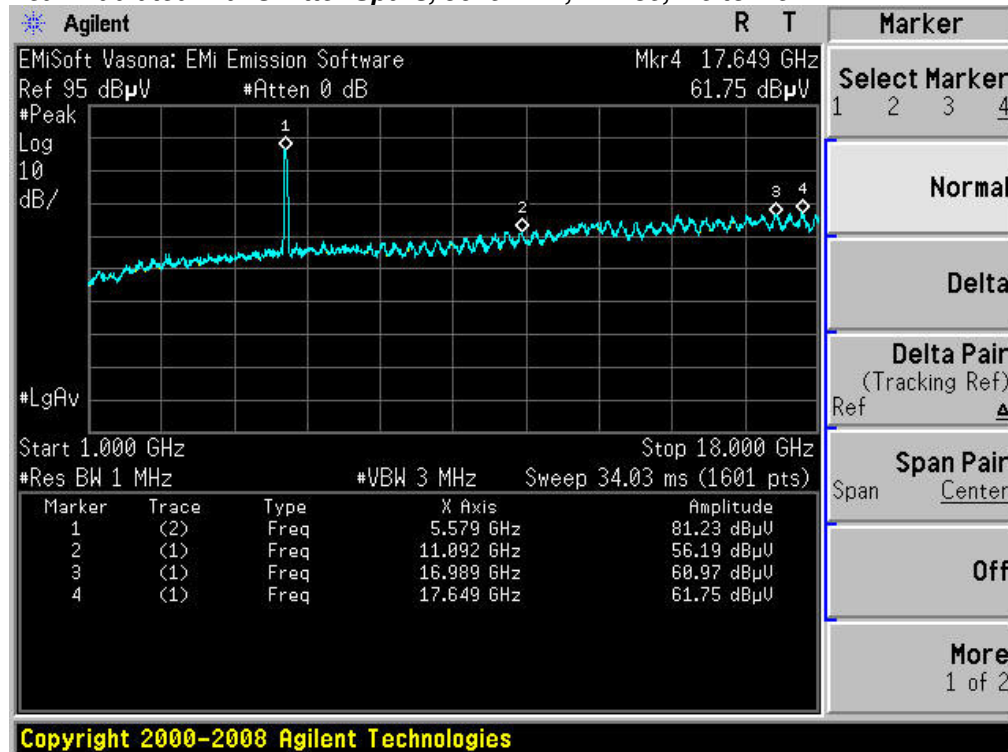

Copyright 2000-2008 Agilent Technologies

**Peak Radiated Transmitter Spurs, 5670 MHz, HT/VHT40, M0 to M23**

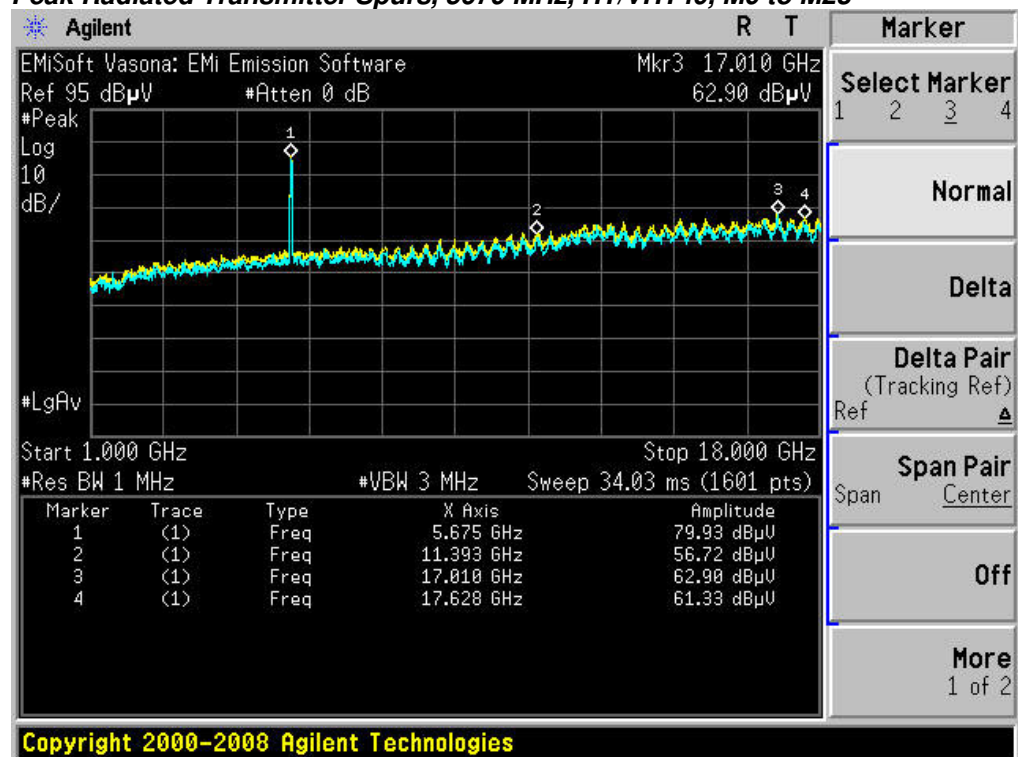

**Peak Radiated Transmitter Spurs, 5690 MHz, VHT80, M0 to M9**

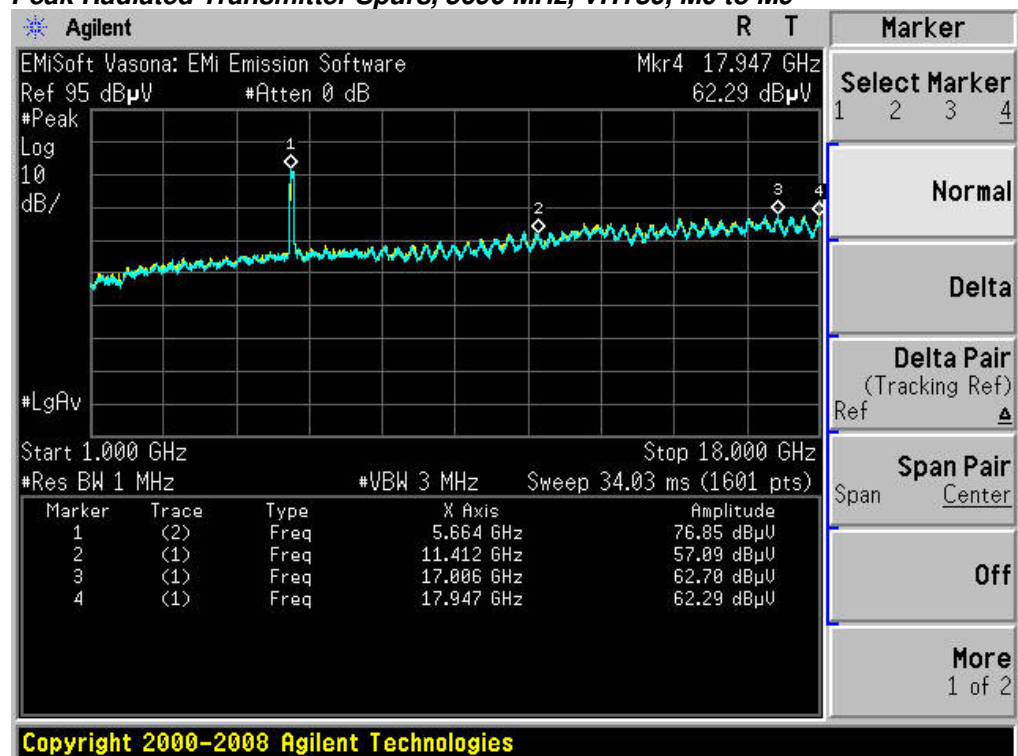

**Peak Radiated Transmitter Spurs, 5700 MHz, HT/VHT20, M0 to M23**

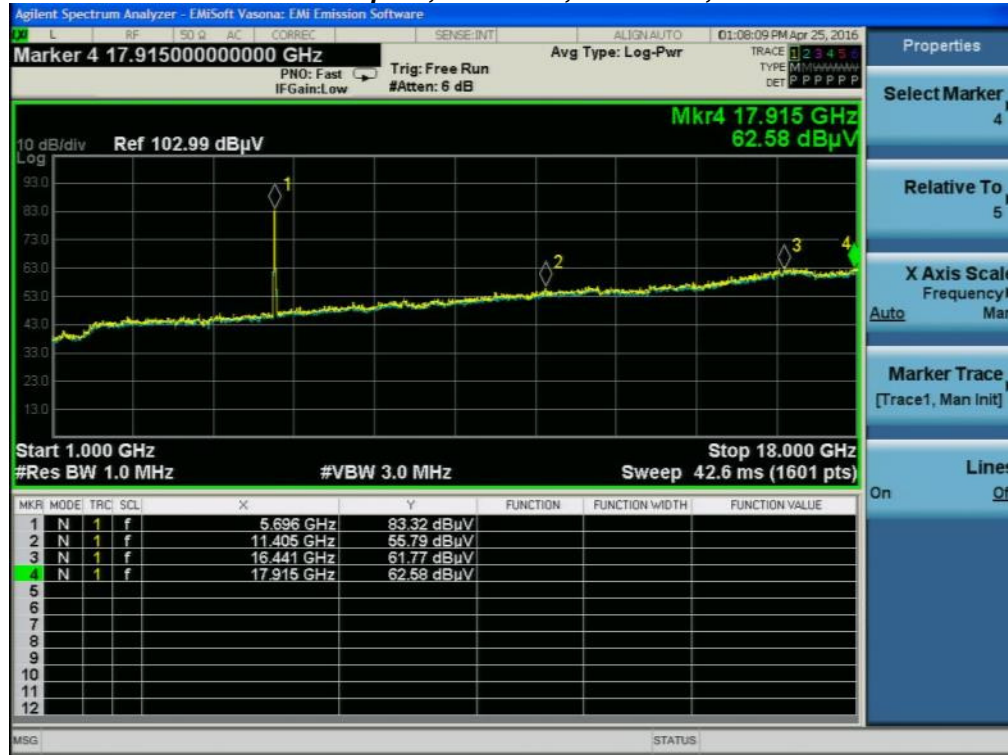

**Peak Radiated Transmitter Spurs, 5710 MHz, HT/VHT40, M0 to M23**

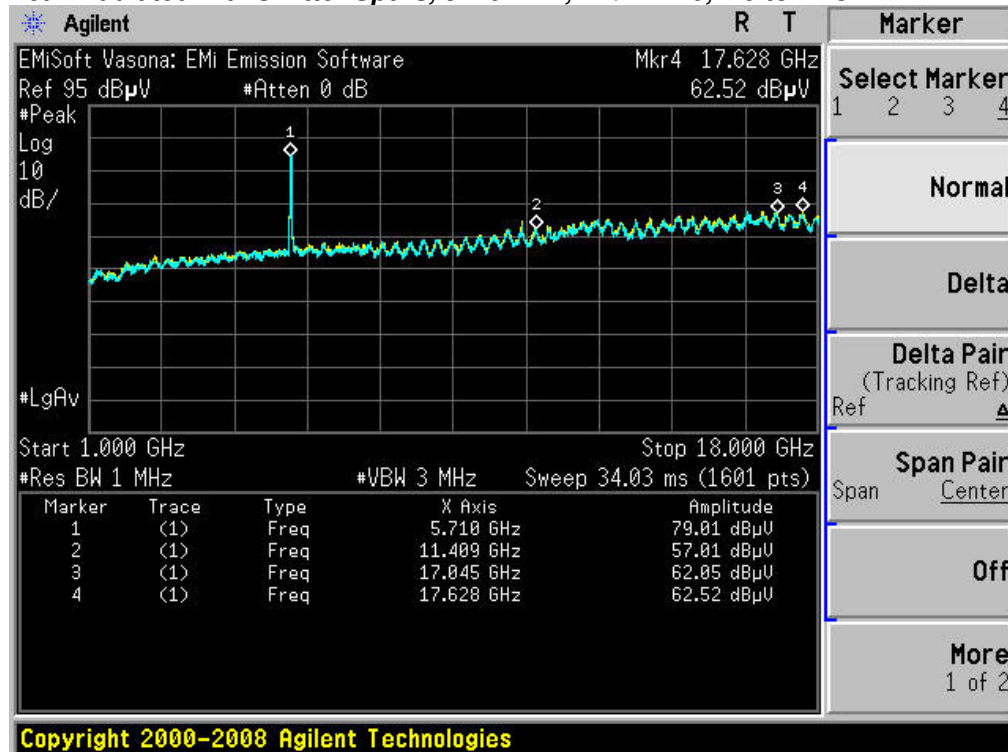



**Peak Radiated Transmitter Spurs, 5720 MHz, HT/VHT20, M0 to M23**



**Peak Radiated Transmitter Spurs, All modes, All rates, 18-26GHz**

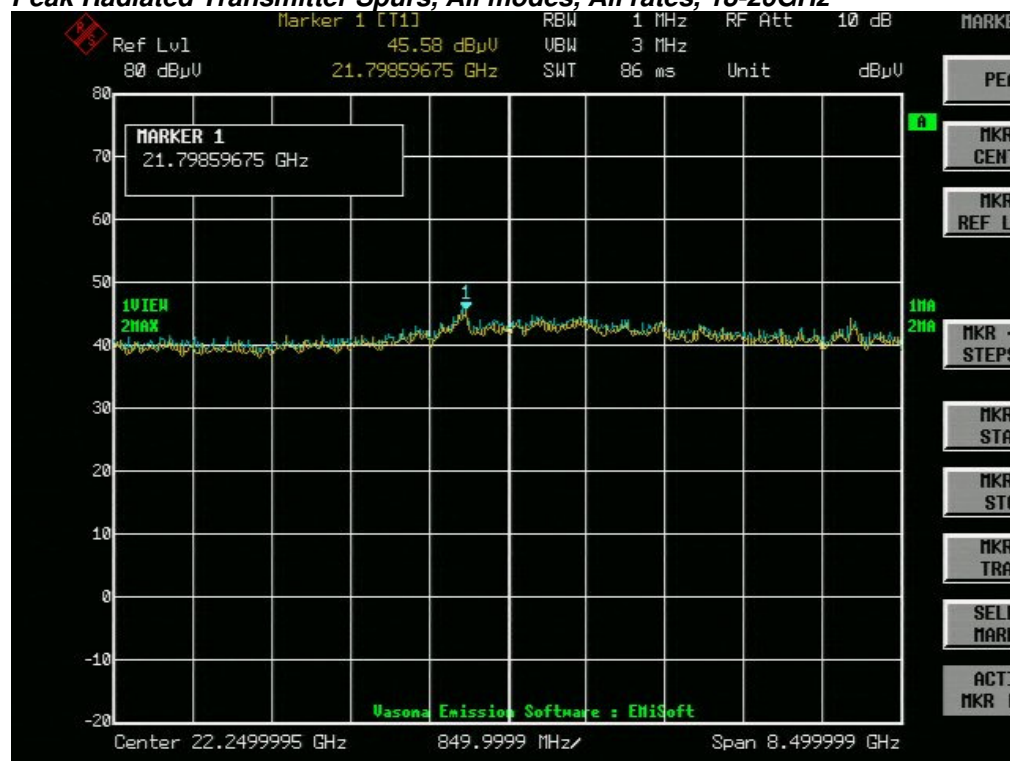

**Peak Radiated Transmitter Spurs, All modes, All rates, 26-40GHz**

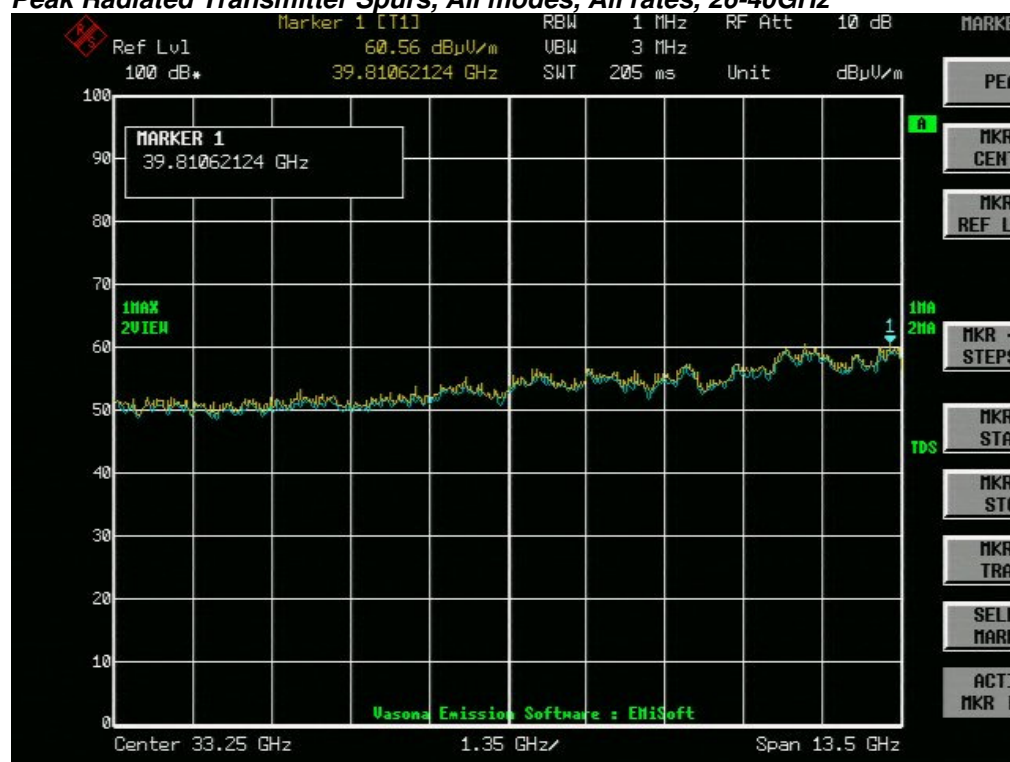



## B.2 Radiated Emissions 30MHz to 1GHz

**FCC 15.205 / 15.209**

- (7) The provisions of 15.205 apply to intentional radiators operating under this section.
- (6) Unwanted emissions below 1 GHz must comply with the general field strength limits set forth in 15.209.

**Ref. ANSI C63.10: 2013 section 6.5**

Using Vasona, configure the spectrum analyzer as shown below (be sure to enter all losses between the transmitter output and the spectrum analyzer). Place the radio in continuous transmit mode.

Span:	30MHz – 1GHz
Reference Level:	80 dBuV
Attenuation:	10 dB
Sweep Time:	Coupled
Resolution Bandwidth:	100kHz
Video Bandwidth:	300kHz
Detector:	Peak for Pre-scan, Quasi-Peak

Compliance shall be determined using CISPR quasi-peak detection; however, peak detection is permitted as an alternative to quasi-peak detection.

Terminate the access Point RF ports with 50 ohm loads.

Maximize Turntable (find worst case table angle), Maximize Antenna (find worst case height)

This report represents the worst case data for all supported operating modes and antennas.

System Number	Description	Samples	System under test	Support equipment
1	EUT	S01	<input checked="" type="checkbox"/>	<input type="checkbox"/>
	Support	S02	<input type="checkbox"/>	<input checked="" type="checkbox"/>

<b>Tested By :</b> Jose Aguirre	<b>Date of testing:</b> 20-April-16 - 08-Aug-16
<b>Test Result : PASS</b>	

See Appendix C for list of test equipment

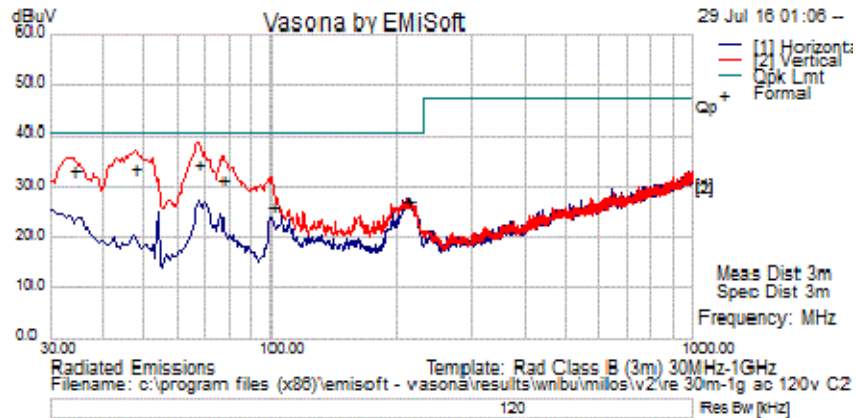

Test Results Table

Frequency (MHz)	Raw (dBuV)	Cable Loss	AF (dB)	Level (dBuV/m)	Measurement Type	Poi	Hgt (cm)	Azt (Deg)	Limit (dBuV/m)	Margin (dB)	Pass/Fail	Comments
34.24375	14.29	0.69	17.95	32.93	Quasi Max	H	105	12	40.50	-7.57	Pass	
47.58125	24.03	0.80	8.83	33.66	Quasi Max	H	113	36	40.50	-6.84	Pass	
212.48125	14.97	1.77	10.50	27.24	Quasi Max	V	117	182	40.50	-13.26	Pass	
100.325	14.43	1.20	10.39	26.02	Quasi Max	H	233	244	40.50	-14.48	Pass	
66.98125	25.03	1.00	8.26	34.29	Quasi Max	H	113	292	40.50	-6.21	Pass	
76.68125	22.45	1.06	8.19	31.70	Quasi Max	H	128	344	40.50	-8.80	Pass	

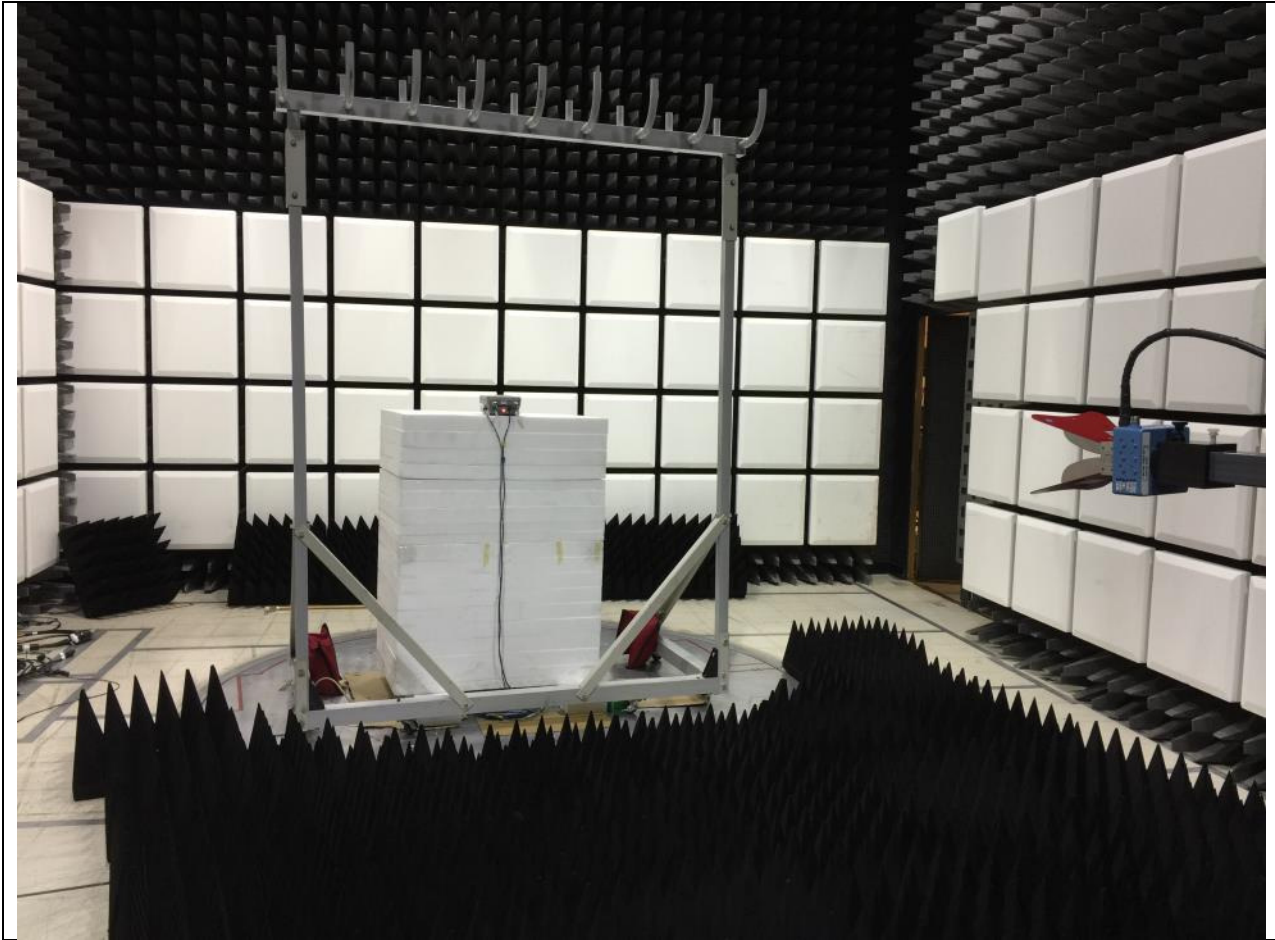

**Title:** Radiated Emissions Configuration Photograph



### B.3 AC Conducted Emissions

**FCC 15.207 (a) & RSS-Gen 8.8 / LP0002:2.3** Except when the requirements applicable to a given device state otherwise, for any radio apparatus equipped to operate from the public utility AC power supply, either directly or indirectly (such as with a battery charger), the radio frequency voltage of emissions conducted back onto the AC power lines in the frequency range of 0.15 MHz to 30 MHz shall not exceed the limits shown in the table in these sections. The more stringent limit applies at the frequency range boundaries.

Measurement Procedure  
 Accordance with ANSI C63.10:2013 section 6.2

Using Vasona, configure the spectrum analyzer as shown below (be sure to enter all losses between the transmitter output and the spectrum analyzer). Place the radio in continuous transmit mode.

Span: 150 KHz – 30 MHz  
 Attenuation: 10 dB  
 Sweep Time: Coupled  
 Resolution Bandwidth: 9 KHz  
 Video Bandwidth: 30 KHz  
 Detector: Quasi-Peak / Average

System Number	Description	Samples	System under test	Support equipment
2	EUT	S03	<input checked="" type="checkbox"/>	<input type="checkbox"/>
	Support	S04	<input type="checkbox"/>	<input checked="" type="checkbox"/>

<b>Tested By :</b> Jose Aguirre	<b>Date of testing:</b> 20-April-16 - 08-Aug-16
<b>Test Result : PASS</b>	

See separate EMC test report for test data.

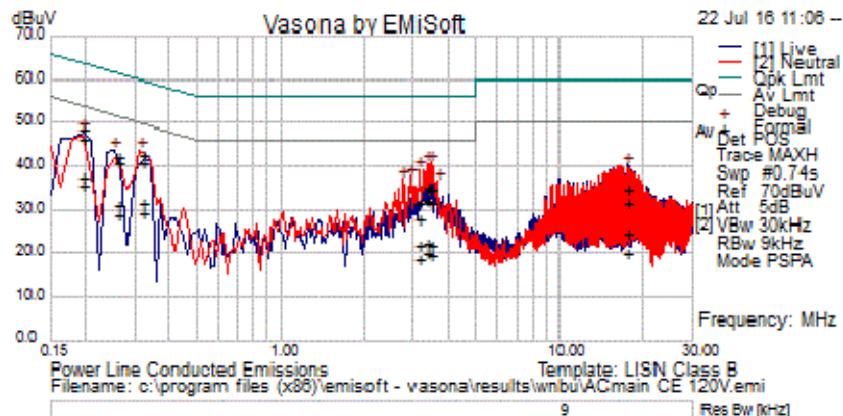

Test Results Table

Frequency (MHz)	Raw (dBuV)	Cable Loss	Factors (dB)	Level (dBuV/m)	Measurement Type	Line	Limit (dBuV/m)	Margin (dB)	Pass/Fail	Comments
.318	22.63	20.28	0.04	42.96	Quasi Peak	Live	59.76	-16.80	Pass	
3.446	14.92	19.99	0.05	34.95	Quasi Peak	Live	56.00	-21.05	Pass	
3.135	11.83	19.98	0.06	31.86	Quasi Peak	Live	56.00	-24.14	Pass	
.195	27.83	20.78	0.05	48.66	Quasi Peak	Live	63.82	-15.16	Pass	
17.358	14.25	20.33	0.19	34.77	Quasi Peak	Live	60.00	-25.23	Pass	
3.350	15.24	19.98	0.05	35.27	Quasi Peak	Live	56.00	-20.73	Pass	
.261	21.84	20.48	0.04	42.36	Quasi Peak	Live	61.40	-19.04	Pass	
3.446	11.71	19.99	0.05	31.75	Quasi Peak	Neutral	56.00	-24.25	Pass	
.195	25.78	20.78	0.05	46.61	Quasi Peak	Neutral	63.82	-17.21	Pass	
3.350	11.97	19.98	0.05	32.01	Quasi Peak	Neutral	56.00	-23.99	Pass	
3.135	8.12	19.98	0.06	28.16	Quasi Peak	Neutral	56.00	-27.84	Pass	
.261	20.21	20.48	0.04	40.73	Quasi Peak	Neutral	61.40	-20.67	Pass	
17.358	4.23	20.33	0.19	24.75	Quasi Peak	Neutral	60.00	-35.25	Pass	
.318	20.63	20.28	0.04	40.95	Quasi Peak	Neutral	59.76	-18.81	Pass	
.318	11.54	20.28	0.04	31.87	Average	Live	49.76	-17.89	Pass	
3.446	1.77	19.99	0.05	21.81	Average	Live	46.00	-24.19	Pass	
3.135	1.82	19.98	0.06	21.86	Average	Live	46.00	-24.14	Pass	
.195	17.05	20.78	0.05	37.87	Average	Live	53.82	-15.95	Pass	
17.358	11.08	20.33	0.19	31.59	Average	Live	50.00	-18.41	Pass	
3.350	2.45	19.98	0.05	22.49	Average	Live	46.00	-23.51	Pass	
.261	10.69	20.48	0.04	31.21	Average	Live	51.40	-20.19	Pass	
3.446	-0.15	19.99	0.05	19.89	Average	Neutral	46.00	-26.11	Pass	
.195	14.85	20.78	0.05	35.68	Average	Neutral	53.82	-18.14	Pass	
3.350	0.12	19.98	0.05	20.16	Average	Neutral	46.00	-25.84	Pass	
3.135	-1.39	19.98	0.06	18.64	Average	Neutral	46.00	-27.36	Pass	
.261	8.30	20.48	0.04	28.82	Average	Neutral	51.40	-22.58	Pass	



Frequency (MHz)	Raw (dBuV)	Cable Loss	Factors (dB)	Level (dBuV/m)	Measurement Type	Line	Limit (dBuV/m)	Margin (dB)	Pass/Fail	Comments
17.358	-0.50	20.33	0.19	20.02	Average	Neutral	50.00	-29.98	Pass	
.318	9.08	20.28	0.04	29.41	Average	Neutral	49.76	-20.35	Pass	





**Title:** Conducted Emissions Configuration Photograph

## Appendix C: List of Test Equipment Used to perform the test

Test Equipment used for Radiated Emissions					
Equip#	Manufacturer/ Model	Description	Last Cal	Next Cal	Test Item
CIS051796	TTA1800-30-HG Miteq	SMA 18 GHz Pre-Amplifier	29-Sep-15	29-Sep-16	B.1, B.2
CIS035285	3117 ETS-Lindgren	Double Ridged Waveguide Horn Antenna	30-Sep-15	30-Sep-16	B.1, B.2
CIS008447	NSA 10m Chamber Cisco	NSA 10m Chamber	14-Oct-15	14-Oct-16	B.3
CIS045096	TH0118 Cisco	Mast Mount Preamplifier Array, 1-18GHz	4-Nov-15	4-Nov-16	B.1, B.2
CIS030652	JB1 Sunol Sciences	Combination Antenna, 30MHz-2GHz	4-Dec-15	4-Dec-16	B.3
CIS041929	iBTHP-5-DB9 Newport	5 inch Temp/RH/Press Sensor w/20ft cable	22-Dec-15	22-Dec-16	B.1, B.2, B.3
CIS043124	Above 1GHz Site Cal Cisco	Above 1GHz Cispr Site Verification	14-Jan-16	14-Jan-17	B.1, B.2
CIS047300	N9038A Agilent Technologies	MXE EMI Receiver 20Hz to 26.5 Ghz	28-Jan-16	28-Jan-17	B.1, B.2, B.3
CIS051642	Sucoflex 106PA Huber+Suhner	RF N Type Cable 8.5m	11-Feb-16	11-Feb-17	B.1, B.2, B.3
CIS030559	UFB311A-1-0950-504504 Micro-Coax	RF Coaxial Cable, to 18GHz, 95 in	15-Feb-16	15-Feb-17	B.1, B.2, B.3
CIS020975	UFB311A-0-1344-520520 Micro-Coax	RF Coaxial Cable, to 18GHz, 134.4 in	17-Feb-16	17-Feb-17	B.1, B.2, B.3
CIS051708	UFB293C-2-0840-300504 Micro-Coax	RF Coaxial SMA-N Type Cable	28-Jun-16	28-Jun-17	B.1, B.2, B.3
CIS044940	ESU40 Rohde & Schwarz	EMI Test Receiver, 20Hz-40GHz	2-Nov-15	2-Nov-16	B.1, B.2
CIS034075	RSG 2000 Schaffner	Reference Spectrum Generator, 1-18GHz	Cal Not Required		
CIS041979	1840 Cisco	18-40GHz EMI Test Head/ Verification Fixture	13-Jul-15	13-Jul-16	B.1, B.2
CIS044940	ESU40 Rohde & Schwarz	EMI Test Receiver, 20Hz-40GHz	2-Nov-15	2-Nov-16	B.1, B.2,
CIS030652	JB1 Sunol Sciences	Combination Antenna, 30MHz-2GHz	4-Dec-15	4-Dec-16	B.3
CIS003003	83731B HP	Synthesized Signal Generator	29-Jan-16	29-Jan-17	B.1, B.2
CIS037236	50CB-015 JFW	GPIB Control Box			B.1, B.2



Test Equipment used for AC Mains Conducted Emissions					
Equip#	Manufacturer/ Model	Description	Last Cal	Next Cal	Test Item
8510	Fischer Custom Communications FCC-450B-2.4-N	Instrumentation Limiter	5/16/16	5/16/17	B.4
23802	Fischer Custom Communications FCC-801-M2-50A	CDN, 2-LINE 50A	1/12/16	1/12/17	B.4
45995	Fischer Custom Communications F-090527-1009-2	Lisn Adapter	6/17/16	6/17/17	B.4
49468	Coleman RG223	BNC 25 ft Cable	3/9/16	3/9/17	B.4
31918	Midwest Microwave TRM-2048-MC-BNC-10	50 Ohm, 5W Terminator, Type BNC	11/9/15	11/9/16	B.4
49531	TTE H785-150K-50-21378	High Pass Filter	5/3/16	5/3/17	B.4
45994	Fischer Custom Communications F-090527-1009-1	Line Impedance Stabilization Network	6/17/16	6/17/17	B.4
18963	York CNE V	Comparison Noise Emitter, 30 - 1000MHz	Cal Not Required	Cal Not Required	B.4
45050	Rohde & Schwarz ESCI	EMI Test Receiver	11/3/15	11/3/16	B.4
51721	Teseq CDN ST08A	Coupling Decoupling Network	6/7/16	6/7/17	B.4
54231	Newport iBTHP-5-DB9	5 inch Temp/RH/Press Sensor w/20ft cable	2/10/16	2/10/17	B.4

Test Equipment used for RF Conducted Tests					
Equip#	Manufacturer/ Model	Description	Last Cal	Next Cal	Test Item
CIS054666	RA08-S1S1-18 MegaPhase	SMA 18" Cable	25-Sep-15	25-Sep-16	A1 thru A7
CIS054667	RA08-S1S1-18 MegaPhase	SMA 18" Cable	25-Sep-15	25-Sep-16	A1 thru A7
CIS054668	RA08-S1S1-18 MegaPhase	SMA 18" Cable	25-Sep-15	25-Sep-16	A1 thru A7
CIS054669	RA08-S1S1-18 MegaPhase	SMA 18" Cable	25-Sep-15	25-Sep-16	A1 thru A7
CIS054686	NI PXI-2796 National Instruments	Plug-in switch module	6-Oct-15	6-Oct-16	A1 thru A7
CIS055166	RFLT4WDC40GK RF Lambda	4 Way Power Divider 40GHz	23-Nov-15	23-Nov-16	A1 thru A7
CIS054662	RFLT4WDC40GK RF Lambda	SMA 36" cable	24-Sep-15	24-Sep-16	A1 thru A7
CIS054656	BRC50705-02 Micro-Tronics	Band Reject Filter	24-Sep-15	24-Sep-16	A1 thru A7
CIS054655	BRC50704-02 Micro-Tronics	Notch Filter, SB:5.470-5.725GHz, to 12GHz	24-Sep-15	24-Sep-16	A1 thru A7
CIS054654	BRC50703-02	Notch Filter,	24-Sep-15	24-Sep-16	A1 thru A7

	Micro-Tronics	SB:5.150-5.350GHz, to 11GHz			
CIS054653	BRM50702-02 Micro-Tronics	Notch Filter, SB:2.400-2.500GHz, to 18GHz	24-Sep-15	24-Sep-16	A1 thru A7
CIS054678	RA08-S1S1-12 MegaPhase	SMA 12" Cable	25-Sep-15	25-Sep-16	A1 thru A7
CIS054677	RA08-S1S1-12 MegaPhase	SMA 12" Cable	25-Sep-15	25-Sep-16	A1 thru A7
CIS054676	RA08-S1S1-12 MegaPhase	SMA 12" Cable	25-Sep-15	25-Sep-16	A1 thru A7
CIS054675	RA08-S1S1-12 MegaPhase	SMA 12" Cable	25-Sep-15	25-Sep-16	A1 thru A7
CIS054674	RA08-S1S1-12 MegaPhase	SMA 12" Cable	25-Sep-15	25-Sep-16	A1 thru A7
CIS054673	RA08-S1S1-12 MegaPhase	SMA 12" Cable	25-Sep-15	25-Sep-16	A1 thru A7
CIS054672	RA08-S1S1-12 MegaPhase	SMA 12" Cable	25-Sep-15	25-Sep-16	A1 thru A7
CIS054671	RA08-S1S1-12 MegaPhase	SMA 12" Cable	25-Sep-15	25-Sep-16	A1 thru A7
CIS054670	RA08-S1S1-12 MegaPhase	SMA 12" Cable	25-Sep-15	25-Sep-16	A1 thru A7
CIS054664	GC12-8181-16 MegaPhase	SMA 16" Cable	25-Sep-15	25-Sep-16	A1 thru A7
CIS054663	F120-S1S1-48 MegaPhase	SMA 48" Cable	25-Sep-15	25-Sep-16	A1 thru A7
CIS054686	NI PXI-2796 National Instruments	Plug-in switch module	6-Oct-15	6-Oct-16	A1 thru A7
CIS042005	BWS30W2+ Mini-Circuits	SMA 30dB Attenuator	16-Oct-15	16-Oct-16	A1 thru A7
CIS041995	BW-S6W2 Mini-Circuits	6dB Attenuator	16-Oct-15	16-Oct-16	A1 thru A7
CIS054695	D3C2060 Ditom	Circulator	20-Oct-15	20-Oct-16	A1 thru A7
CIS055146	RA08-S1S1-12 Megaphase	12" SMA Cable	17-Nov-15	17-Nov-16	A1 thru A7
CIS050721	N9030A Keysight	PXA Signal Analyzer	30-Mar-16	30-Mar-17	A1 thru A7
CIS054303	N5182B Keysight	MXG X-Series RF Vector Signal Generator	6-Apr-16	6-Apr-17	A1 thru A7
CIS055358	ZFSC-2-10G Mini-Circuits	Splitter	11-Apr-16	11-Apr-17	A1 thru A7
CIS055099	SMART2200RM2U Tripp-Lite	Power Supply	Cal Not Required		A1 thru A7
CIS055094	PXI-1042 National Instruments	Chassis	Cal Not Required		A1 thru A7

## Appendix E: Abbreviation Key and Definitions

The following table defines abbreviations used within this test report.

Abbreviation	Description	Abbreviation	Description
EMC	Electro Magnetic Compatibility	°F	Degrees Fahrenheit
EMI	Electro Magnetic Interference	°C	Degrees Celsius
EUT	Equipment Under Test	Temp	Temperature
ITE	Information Technology Equipment	S/N	Serial Number
TAP	Test Assessment Schedule	Qty	Quantity
ESD	Electro Static Discharge	emf	Electromotive force
EFT	Electric Fast Transient	RMS	Root mean square
EDCS	Engineering Document Control System	Qp	Quasi Peak
Config	Configuration	Av	Average
CIS#	Cisco Number (unique identification number for Cisco test equipment)	Pk	Peak
Cal	Calibration	kHz	Kilohertz ( $1 \times 10^3$ )
EN	European Norm	MHz	MegaHertz ( $1 \times 10^6$ )
IEC	International Electro technical Commission	GHz	Gigahertz ( $1 \times 10^9$ )
CISPR	International Special Committee on Radio Interference	H	Horizontal
CDN	Coupling/Decoupling Network	V	Vertical
LISN	Line Impedance Stabilization Network	dB	decibel
PE	Protective Earth	V	Volt
GND	Ground	kV	Kilovolt ( $1 \times 10^3$ )
L1	Line 1	$\mu$ V	Microvolt ( $1 \times 10^{-6}$ )
L2	Line2	A	Amp
L3	Line 3	$\mu$ A	Micro Amp ( $1 \times 10^{-6}$ )
DC	Direct Current	mS	Milli Second ( $1 \times 10^{-3}$ )
RAW	Uncorrected measurement value, as indicated by the measuring device	$\mu$ S	Micro Second ( $1 \times 10^{-6}$ )
RF	Radio Frequency	$\mu$ S	Micro Second ( $1 \times 10^{-6}$ )
SLCE	Signal Line Conducted Emissions	m	Meter
Meas dist	Measurement distance	Spec dist	Specification distance
N/A or NA	Not Applicable	SL	Signal Line (or Telecom Line)
P	Power Line	L	Live Line
N	Neutral Line	R	Return
S	Supply	AC	Alternating Current

**End**