

Test Report
AIR-AP1562I-B-K9
AIR-AP1562D-B-K9

Cisco Aironet 802.11ac Dual Band Outdoor Access Points

FCC ID: LDK102104

5150-5250 MHz

Against the following Specifications:

CFR47 Part 15.407

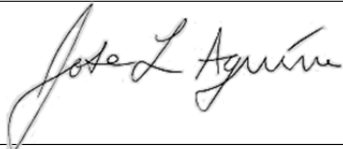

Cisco Systems
170 West Tasman Drive
San Jose, CA 95134

| | |
|---|--|
|  |  |
| Author: Jose Aguirre Tested By: | Approved By: Jim Nicholson Title: Technical Leader, Engineering Revision: 1 |

This report replaces any previously entered test report under EDCS – **11346270**. This test report has been electronically authorized and archived using the CISCO Engineering Document Control system.

This test report has been electronically authorized and archived using the CISCO Engineering Document Control system.

| | |
|--|-----------|
| SECTION 1: OVERVIEW | 3 |
| SECTION 2: ASSESSMENT INFORMATION | 4 |
| 2.1 GENERAL | 4 |
| 2.2 DATE OF TESTING..... | 6 |
| 2.3 REPORT ISSUE DATE | 6 |
| 2.4 TESTING FACILITIES | 6 |
| 2.5 EQUIPMENT ASSESSED (EUT)..... | 6 |
| 2.6 EUT DESCRIPTION..... | 7 |
| SECTION 3: RESULT SUMMARY | 9 |
| 3.1 RESULTS SUMMARY TABLE | 9 |
| SECTION 4: SAMPLE DETAILS..... | 11 |
| 4.1 SAMPLE DETAILS | 11 |
| 4.2 SYSTEM DETAILS | 11 |
| 4.3 MODE OF OPERATION DETAILS..... | 11 |
| APPENDIX A: EMISSION TEST RESULTS | 12 |
| CONDUCTED TEST SETUP DIAGRAM..... | 12 |
| TARGET MAXIMUM CHANNEL POWER | 12 |
| Antenna Gain: 4 dBi | 12 |
| Antenna Gain: 10 dBi | 13 |
| A.1 99% AND 26DB BANDWIDTH..... | 14 |
| A.2 MAXIMUM CONDUCTED OUTPUT POWER/ POWER SPECTRAL DENSITY..... | 22 |
| Antenna Gain: 4 dBi | 24 |
| Antenna Gain: 10 dBi | 28 |
| Antenna Gain: 4 dBi | 32 |
| Antenna Gain: 10 dBi | 36 |
| Antenna Gain: 4 (2) dBi..... | 40 |
| Antenna Gain: 10 (5) dBi..... | 43 |
| A.3 CONDUCTED SPURIOUS EMISSIONS..... | 46 |
| A.4 CONDUCTED BAND EDGE | 56 |
| Antenna Gain: 4 dBi | 57 |
| Antenna Gain: 10 dBi | 60 |
| Antenna Gain: 4 dBi | 63 |
| Antenna Gain: 10 dBi | 66 |
| APPENDIX B: EMISSION TEST RESULTS | 70 |
| RADIATED EMISSION SETUP DIAGRAM-BELOW 1G..... | 70 |
| B.1 RADIATED SPURIOUS EMISSIONS | 71 |
| B.2 RADIATED EMISSIONS 30MHZ TO 1GHZ | 82 |
| B.3 AC CONDUCTED EMISSIONS | 85 |
| APPENDIX C: LIST OF TEST EQUIPMENT USED TO PERFORM THE TEST | 89 |
| APPENDIX E: ABBREVIATION KEY AND DEFINITIONS | 92 |

Section 1: Overview

The samples were assessed against the tests detailed in section 3 under the requirements of the following specifications:

| |
|------------------------|
| Specifications: |
| CFR47 Part 15.407 |

Measurements were made in accordance with

- ANSI C63.10:2013
- KDB 789033 D02 General UNII Test Procedures New Rules v01r03
- KDB 662911 D01 Multiple Transmitter Output v02r01

Section 2: Assessment Information

2.1 General

This report contains an assessment of an apparatus against Electromagnetic Compatibility Standards based upon tests carried out on the samples submitted. The testing was performed by and for the use of Cisco systems Inc:

With regard to this assessment, the following points should be noted:

- a) The results contained in this report relate only to the items tested and were obtained in the period between the date of the initial assessment and the date of issue of the report. Manufactured products will not necessarily give identical results due to production and measurement tolerances.
- b) The apparatus was set up and exercised using the configuration and modes of operation defined in this report only.
- c) Where relevant, the apparatus was only assessed using the susceptibility criteria defined in this report and the Test Assessment Plan (TAP).
- d) All testing was performed under the following environmental conditions:

| | |
|----------------------|--------------------------------------|
| Temperature | 15°C to 35°C (54°F to 95°F) |
| Atmospheric Pressure | 860mbar to 1060mbar (25.4" to 31.3") |
| Humidity | 10% to 75*% |
- e) All AC testing was performed at one or more of the following supply voltages:
110V 60 Hz (+/-20%)

Units of Measurement

The units of measurements defined in the appendices are reported in specific terms, which are test dependent. Where radiated measurements are concerned these are defined at a particular distance. Basic voltage measurements are defined in units of [dBuV]

As an example, the basic calculation for all measurements is as follows:

$$\text{Emission level [dBuV]} = \text{Indicated voltage level [dBuV]} + \text{Cable Loss [dB]} + \text{Other correction factors [dB]}$$

The combinations of correction factors are dependent upon the exact test configurations [see test equipment lists for further details] and may include:-

Antenna Factors, Pre Amplifier Gain, LISN Loss, Pulse Limiter Loss and Filter Insertion Loss..

Note: to convert the results from dBuV/m to uV/m use the following formula:-

$$\text{Level in uV/m} = \text{Common Antilogarithm} [(X \text{ dBuV/m})/20] = Y \text{ uV/m}$$

Measurement Uncertainty Values

| | |
|-----------------------------------|------------------------|
| voltage and power measurements | ± 2 dB |
| conducted EIRP measurements | ± 1.4 dB |
| radiated measurements | ± 3.2 dB |
| frequency measurements | ± 2.4 10 ⁻⁷ |
| temperature measurements | ± 0.54° |
| humidity measurements | ± 2.3% |
| DC and low frequency measurements | ± 2.5% |

Where relevant measurement uncertainty levels have been estimated for tests performed on the apparatus. This uncertainty represents an expanded uncertainty expressed at approximately the 95% confidence level using a coverage factor of k=2.

Radiated emissions (expanded uncertainty, confidence interval 95%)

| | |
|--------------------|------------|
| 30 MHz - 300 MHz | +/- 3.8 dB |
| 300 MHz - 1000 MHz | +/- 4.3 dB |
| 1 GHz - 10 GHz | +/- 4.0 dB |
| 10 GHz - 18GHz | +/- 8.2 dB |
| 18GHz - 26.5GHz | +/- 4.1 dB |
| 26.5GHz - 40GHz | +/- 3.9 dB |

Conducted emissions (expanded uncertainty, confidence interval 95%)

| | |
|----------------|-------------|
| 30 MHz – 40GHz | +/- 0.38 dB |
|----------------|-------------|

A product is considered to comply with a requirement if the nominal measured value is below the limit line. The product is considered to not be in compliance in case the nominal measured value is above the limit line.

This report must not be reproduced except in full, without written approval of Cisco Systems.

2.2 Date of testing

20-April-16 - 08-Aug-16

2.3 Report Issue Date

07-September-2016

Cisco uses an electronic system to issue, store and control the revision of test reports. This system is called the Engineering Document Control System (EDCS). The actual report issue date is embedded into the original file on EDCS. Any copies of this report, either electronic or paper, that are not on EDCS must be considered uncontrolled.

2.4 Testing facilities

This assessment was performed by:

Testing Laboratory

Cisco Systems, Inc.,
125 West Tasman Drive
San Jose, CA 95134, USA

Registration Numbers for Industry Canada

| Cisco System Site | Address | Site Identifier |
|--------------------------|---|------------------------|
| Building P, 10m Chamber | 125 West Tasman Dr San Jose, CA 95134 | Company #: 2461N-2 |
| Building P, 5m Chamber | 125 West Tasman Dr San Jose, CA 95134 | Company #: 2461N-1 |
| Building I, 5m Chamber | 285 W. Tasman Drive San Jose, California 95134 | Company #: 2461M-1 |

Test Engineers

Jose Aguirre

2.5 Equipment Assessed (EUT)

AIR-AP1562I-B-K9

2.6 EUT Description

The Cisco Aironet 802.11ac Radio supports the following modes of operation. The modes are further defined in the radio Theory of Operation. The modes included in this report represent the worst case data for all modes.

- 802.11n/ac - Non HT20, One Antenna, 6 to 54 Mbps
- 802.11n/ac - Non HT20, Two Antennas, 6 to 54 Mbps
- 802.11n/ac - Non HT20, Three Antennas, 6 to 54 Mbps

- 802.11n/ac - Non HT20 Beam Forming, Two Antennas, 6 to 54 Mbps
- 802.11n/ac - Non HT20 Beam Forming, Three Antennas, 6 to 54 Mbps

- 802.11n/ac - HT/VHT20, One Antenna, M0 to M7
- 802.11n/ac - HT/VHT20, Two Antennas, M0 to M7
- 802.11n/ac - HT/VHT20, Two Antennas, M8 to M15
- 802.11n/ac - HT/VHT20, Three Antennas, M0 to M7
- 802.11n/ac - HT/VHT20, Three Antennas, M8 to M15

- 802.11n/ac - HT/VHT20 Beam Forming, Two Antennas, M0 to M7
- 802.11n/ac - HT/VHT20 Beam Forming, Two Antennas, M8 to M15
- 802.11n/ac - HT/VHT20 Beam Forming, Three Antennas, M0 to M7
- 802.11n/ac - HT/VHT20 Beam Forming, Three Antennas, M8 to M15

- 802.11n/ac - HT/VHT20 STBC, Two Antennas, M0 to M7
- 802.11n/ac - HT/VHT20 STBC, Three Antennas, M0 to M7

- 802.11n/ac - Non HT40 Duplicate, One Antenna, 6 to 54 Mbps
- 802.11n/ac - Non HT40 Duplicate, Two Antennas, 6 to 54 Mbps
- 802.11n/ac - Non HT40 Duplicate, Three Antennas, 6 to 54 Mbps

- 802.11n/ac - HT/VHT40, One Antenna, M0 to M7
- 802.11n/ac - HT/VHT40, Two Antennas, M0 to M7
- 802.11n/ac - HT/VHT40, Two Antennas, M8 to M15
- 802.11n/ac - HT/VHT40, Three Antennas, M0 to M7
- 802.11n/ac - HT/VHT40, Three Antennas, M8 to M15

- 802.11n/ac - HT/VHT40 Beam Forming, Two Antennas, M0 to M7
- 802.11n/ac - HT/VHT40 Beam Forming, Two Antennas, M8 to M15
- 802.11n/ac - HT/VHT40 Beam Forming, Three Antennas, M0 to M7
- 802.11n/ac - HT/VHT40 Beam Forming, Three Antennas, M8 to M15

- 802.11n/ac - HT/VHT40 STBC, Two Antennas, M0 to M7
- 802.11n/ac - HT/VHT40 STBC, Three Antennas, M0 to M7

- 802.11n/ac - Non HT80 Duplicate, One Antenna, 6 to 54 Mbps
- 802.11n/ac - Non HT80 Duplicate, Two Antennas, 6 to 54 Mbps
- 802.11n/ac - Non HT80 Duplicate, Three Antennas, 6 to 54 Mbps

- 802.11ac - VHT80, One Antenna, M0 to M9 1ss
- 802.11ac - VHT80, Two Antennas, M0 to M9 1ss
- 802.11ac - VHT80, Two Antennas, M0 to M9 2ss
- 802.11ac - VHT80, Three Antennas, M0 to M9 1ss
- 802.11ac - VHT80, Three Antennas, M0 to M9 2ss

- 802.11ac - VHT80 Beam Forming, Two Antennas, M0 to M9 1ss
- 802.11ac - VHT80 Beam Forming, Two Antennas, M0 to M9 2ss
- 802.11ac - VHT80 Beam Forming, Three Antennas, M0 to M9 1ss
- 802.11ac - VHT80 Beam Forming, Three Antennas, M0 to M9 2ss

- 802.11ac - VHT80 STBC, Two Antennas, M0 to M9 1ss



802.11ac - VHT80 STBC, Three Antennas, M0 to M9 1ss

The following antennas are supported by this product series.
The data included in this report represent the worst case data for all antennas.

| Frequency | Part Number | Antenna Type | Antenna Gain (dBi) | >30 degree 5 GHz Antenna Gain (dBi) |
|--------------|---------------|-------------------------------|-----------------------|--|
| 5 GHz | Internal (*) | Omni | 4 | 2 |
| | Internal (**) | Directional (Cross Polarized) | 10 | 5 |

(*) Internal antenna for AIR-AP1562I-x-K9

(**) Internal antenna for AIR-AP1562D-x-K9

Section 3: Result Summary

3.1 Results Summary Table

Conducted emissions

| Basic Standard | Technical Requirements / Details | Result |
|--|--|--------|
| FCC 15.407 | <p>99% & 26 dB Bandwidth: The 99% occupied bandwidth is the frequency bandwidth such that, below its lower and above its upper frequency limits, the mean powers are each equal to 0.5% of the total mean power of the given emission. There is no limit for 99% OBW.</p> <p>The 26 dB emission is the width of the emission that is constrained by the frequencies associated with the two outermost amplitude points (upper and lower frequencies) that are attenuated by 26 dB relative to the maximum level measured in the fundamental emission.</p> | Pass |
| FCC 15.407 | <p>Output Power: 15.407: (i) For an outdoor access point operating in the band 5.15-5.25 GHz, the maximum conducted output power over the frequency band of operation shall not exceed 1 W provided the maximum antenna gain does not exceed 6 dBi. If transmitting antennas of directional gain greater than 6 dBi are used, the maximum conducted output power shall be reduced by the amount in dB that the directional gain of the antenna exceeds 6 dBi. The maximum e.i.r.p. at any elevation angle above 30 degrees as measured from the horizon must not exceed 125 mW (21 dBm).</p> <p>(ii) For an indoor access point operating in the band 5.15-5.25 GHz, the maximum conducted output power over the frequency band of operation shall not exceed 1 W provided the maximum antenna gain does not exceed 6 dBi. If transmitting antennas of directional gain greater than 6 dBi are used, the maximum conducted output power shall be reduced by the amount in dB that the directional gain of the antenna exceeds 6 dBi.</p> | Pass |
| FCC 15.407 | <p>Power Spectral Density: 15.407 The maximum power spectral density shall not exceed 17 dBm in any 1 megahertz band. If transmitting antennas of directional gain greater than 6 dBi are used, both the maximum conducted output power and the maximum power spectral density shall be reduced by the amount in dB that the directional gain of the antenna exceeds 6 dBi.</p> | Pass |
| FCC 15.407 | <p>Conducted Spurious Emissions / Band-Edge: For transmitters operating in the 5.15-5.25 GHz band: all emissions outside of the 5.15-5.25 GHz band shall not exceed an EIRP of -27dBm/MHz.</p> | Pass |
| FCC 15.407 FCC 15.209 FCC 15.205 | <p>Restricted band: Unwanted emissions falling within the restricted bands, as defined in FCC 15.205 (a) must also comply with the radiated emission limits specified in FCC 15.209 (a).</p> | Pass |

Radiated Emissions (General requirements)

| Basic Standard | Technical Requirements / Details | Result |
|--------------------------|--|---------------|
| FCC 15.209 FCC 15.205 | TX Spurious Emissions: Except as provided elsewhere in this subpart, the emissions from an intentional radiator shall not exceed the field strength levels specified in the filed strength limits table in this section. | Pass |
| FCC 15.207 | AC conducted Emissions: Except when the requirements applicable to a given device state otherwise, for any radio apparatus equipped to operate from the public utility AC power supply, either directly or indirectly (such as with a battery charger), the radio frequency voltage of emissions conducted back onto the AC power lines in the frequency range of 0.15 MHz to 30 MHz shall not exceed the limits shown in the table in these sections. The more stringent limit applies at the frequency range boundaries. | Pass |

* MPE calculation is recorded in a separate report

Section 4: Sample Details

Note: Each sample was evaluated to ensure that its condition was suitable to be used as a test sample prior to the commencement of testing.

4.1 Sample Details

| Sample No. | Equipment Details | Manufacturer | Hardware Rev. | Firmware Rev. | Software Rev. | Serial Number |
|------------|-------------------|---------------|---------------|---------------|---------------|---------------|
| S01 | AIR-AP1562I-B-K9 | Cisco Systems | P2 | 9.1.8.1 | 9.0.5.5-W8964 | RFDP2BML009 |
| S02* | AIR-PWRADPT-RGD1 | Meanwell | A0 | NA | NA | EB3F71752 |

(*) S02 is support equipment Power supply for EUT S01

4.2 System Details

| System # | Description | Samples |
|----------|------------------|---------|
| 1 | AIR-AP1562I-B-K9 | S01 |
| 2 | AIR-PWRADPT-RGD1 | S02 |

4.3 Mode of Operation Details

| Mode# | Description | Comments |
|-------|-------------------------|--|
| 1 | Continuous Transmitting | Continuous Transmitting $\geq 98\%$ duty cycle |

All measurements were made in accordance with

- ANSI C63.10:2013
- KDB 789033 D02 General UNII Test Procedures New Rules v01r03
- KDB 662911 D01 Multiple Transmitter Output v02r01

Appendix A: Emission Test Results

Conducted Test Setup Diagram

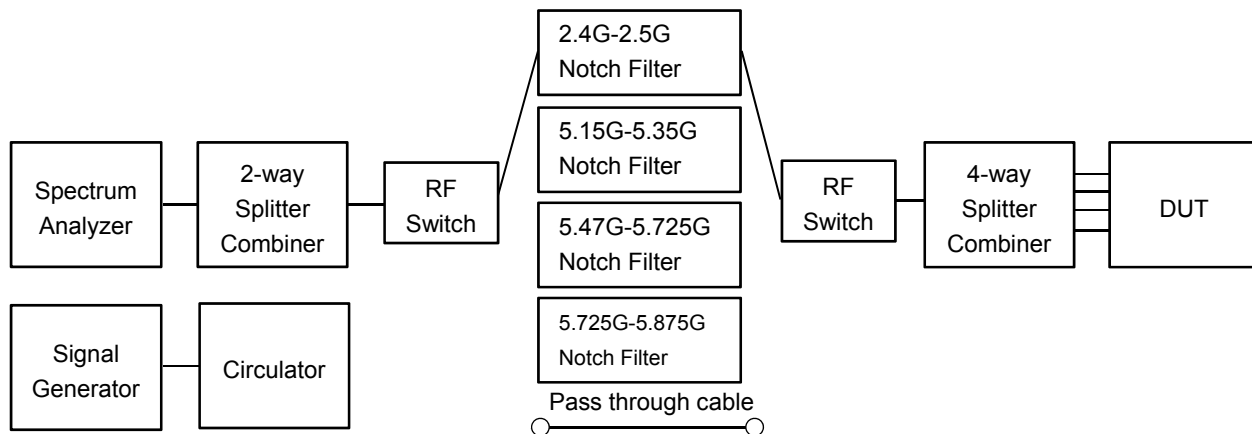

Target Maximum Channel Power

The following table details the maximum supported Total Channel Power for all operating modes.

Antenna Gain: 4 dBi

| Operating Mode | Maximum Channel Power (dBm) | | |
|--|-----------------------------|------|------|
| | Frequency (MHz) | | |
| | 5180 | 5220 | 5240 |
| Non HT20, 6 to 54 Mbps | 18 | 18 | 19 |
| Non HT20 Beam Forming, 6 to 54 Mbps | 16 | 15 | 15 |
| HT/VHT20, M0 to M15 | 19 | 18 | 19 |
| HT/VHT20 Beam Forming, M0 to M15 | 18 | 18 | 19 |
| HT/VHT20 STBC, M0 to M7 | 19 | 18 | 19 |
| | 5190 | 5230 | |
| Non HT40, 6 to 54 Mbps | 15 | 19 | |
| HT/VHT40, M0 to M15 | 16 | 19 | |
| HT/VHT40 Beam Forming, M0 to M15 | 16 | 19 | |
| HT/VHT40 STBC, M0 to M7 | 16 | 19 | |
| | 5210 | | |
| Non HT80, 6 to 54 Mbps | 14 | | |
| VHT80, M0 to M9, M0 to M9 1-1ss | 16 | | |
| VHT80 Beam Forming, M0 to M9, M0 to M9 1-1ss | 15 | | |
| VHT80 STBC, M0 to M9 1ss | 16 | | |

Antenna Gain: 10 dBi

| Operating Mode | Maximum Channel Power (dBm) | | |
|--|-----------------------------|-------------|------|
| | Frequency (MHz) | | |
| | 5180 | 5220 | 5240 |
| Non HT20, 6 to 54 Mbps | 16 | 15 | 16 |
| Non HT20 Beam Forming, 6 to 54 Mbps | 13 | 12 | 13 |
| HT/VHT20, M0 to M15 | 16 | 15 | 16 |
| HT/VHT20 Beam Forming, M0 to M15 | 16 | 15 | 15 |
| HT/VHT20 STBC, M0 to M7 | 16 | 15 | 15 |
| | 5190 | 5230 | |
| Non HT40, 6 to 54 Mbps | 13 | 16 | |
| HT/VHT40, M0 to M15 | 14 | 16 | |
| HT/VHT40 Beam Forming, M0 to M15 | 14 | 15 | |
| HT/VHT40 STBC, M0 to M7 | 14 | 15 | |
| | 5210 | | |
| Non HT80, 6 to 54 Mbps | 11 | | |
| VHT80, M0 to M9, M0 to M9 1-1ss | 13 | | |
| VHT80 Beam Forming, M0 to M9, M0 to M9 1-1ss | 13 | | |
| VHT80 STBC, M0 to M9 1ss | 13 | | |

A.1 99% and 26dB Bandwidth

FCC 15.407 The 99% occupied bandwidth is the frequency bandwidth such that, below its lower and above its upper frequency limits, the mean powers are each equal to 0.5% of the total mean power of the given emission. There is no limit for 99% OBW.

The 26 dB emission is the width of the emission that is constrained by the frequencies associated with the two outermost amplitude points (upper and lower frequencies) that are attenuated by 26 dB relative to the maximum level measured in the fundamental emission.

Test Procedure

Ref. ANSI C63.10: 2013 Section 6.9.3

99% BW and EBW (-26dB)

Test Procedure

1. Set the radio in the continuous transmitting mode.
2. Allow the trace to stabilize.
3. Setting the x-dB bandwidth mode to -26dB and OBW power function to 99% within the measurement set up function.
4. Select the automatic OBW measurement function of an instrument to perform bandwidth measurement.
5. Capture graphs and record pertinent measurement data.

Ref. ANSI C63.10: 2013 Section 6.9.3

99% BW and EBW (-26dB)

Test parameters

Span = 1.5 x to 5.0 times OBW
 RBW = approx. 1% to 5% of the OBW
 VBW ≥ 3 x RBW
 Detector = Peak or where practical sample shall be used
 Trace = Max. Hold

| System Number | Description | Samples | System under test | Support equipment |
|---------------|-------------|---------|-------------------------------------|-------------------------------------|
| 1 | EUT | S01 | <input checked="" type="checkbox"/> | <input type="checkbox"/> |
| | Support | S02 | <input type="checkbox"/> | <input checked="" type="checkbox"/> |

Tested By :

Jose Aguirre

Date of testing:

20-April-16 - 08-Aug-16

Test Result : PASS

See Appendix C for list of test equipment

| Frequency (MHz) | Mode | Data Rate (Mbps) | 26dB BW (MHz) | 99% BW (MHz) |
|-----------------|---------------------------------|------------------|---------------|--------------|
| 5180 | Non HT20, 6 to 54 Mbps | 6 | 23.7 | 18.020 |
| | HT/VHT20, M0 to M15 | m0 | 23.1 | 18.356 |
| 5190 | Non HT40, 6 to 54 Mbps | 6 | 50.6 | 37.023 |
| | HT/VHT40, M0 to M15 | m0 | 43.9 | 36.701 |
| 5210 | Non HT80, 6 to 54 Mbps | 6 | 83.9 | 76.440 |
| | VHT80, M0 to M9, M0 to M9 1-1ss | m0x1 | 83.0 | 76.611 |
| 5220 | Non HT20, 6 to 54 Mbps | 6 | 22.6 | 17.976 |
| | HT/VHT20, M0 to M15 | m0 | 22.8 | 18.316 |
| 5230 | Non HT40, 6 to 54 Mbps | 6 | 46.5 | 36.901 |
| | HT/VHT40, M0 to M15 | m0 | 44.1 | 36.642 |
| 5240 | Non HT20, 6 to 54 Mbps | 6 | 22.2 | 17.956 |
| | HT/VHT20, M0 to M15 | m0 | 22.7 | 18.280 |

26dB / 99% Bandwidth, 5180 MHz, Non HT20, 6 to 54 Mbps

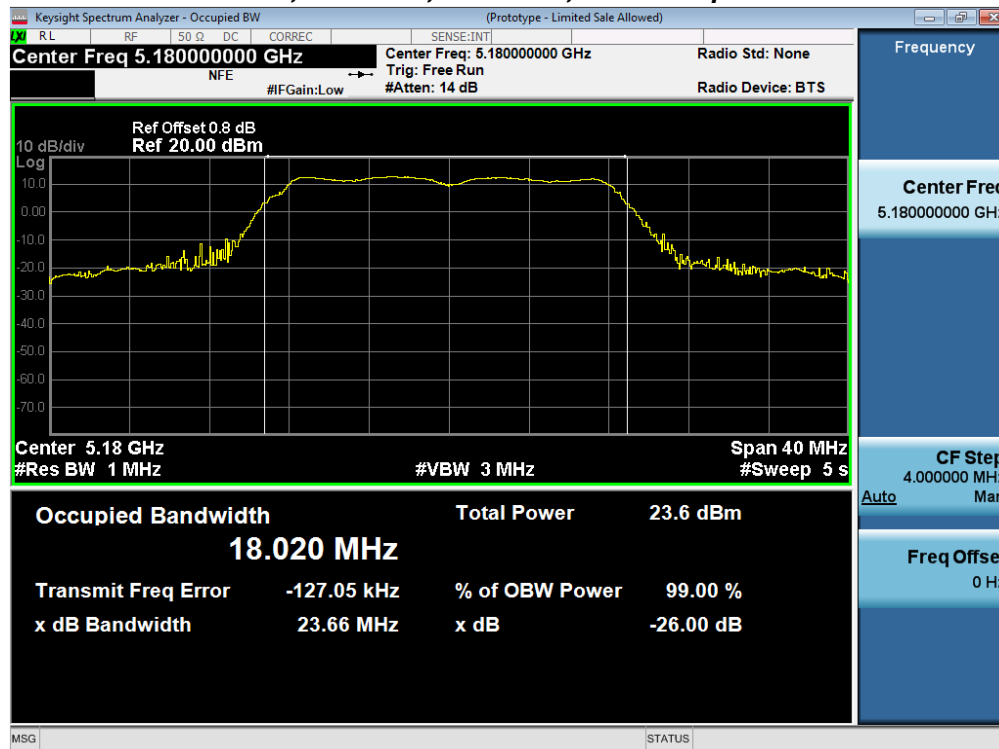

26dB / 99% Bandwidth, 5180 MHz, HT/VHT20, M0 to M15

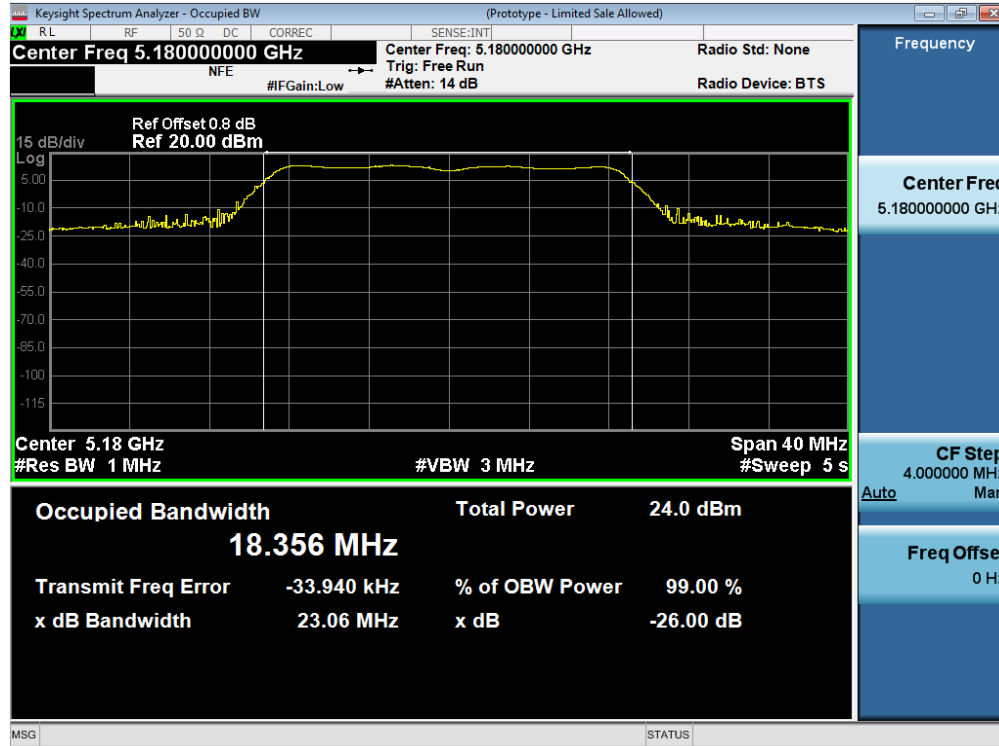



26dB / 99% Bandwidth, 5190 MHz, Non HT40, 6 to 54 Mbps

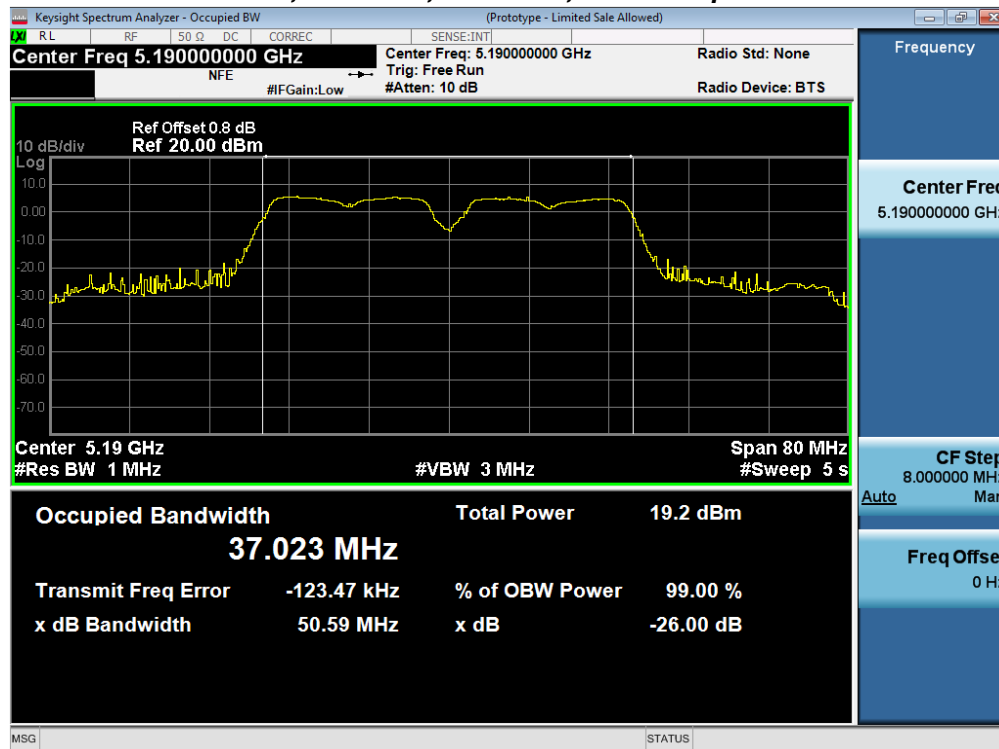

26dB / 99% Bandwidth, 5190 MHz, HT/VHT40, M0 to M15

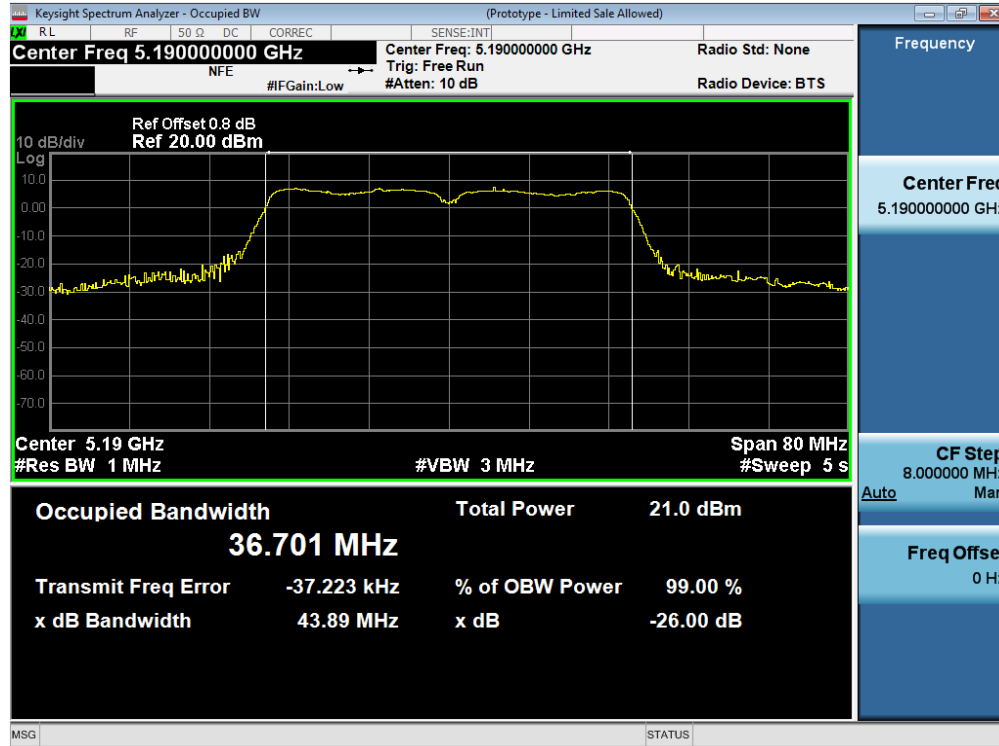

26dB / 99% Bandwidth, 5210 MHz, Non HT80, 6 to 54 Mbps



26dB / 99% Bandwidth, 5210 MHz, VHT80, M0 to M9, M0 to M9 1-1ss

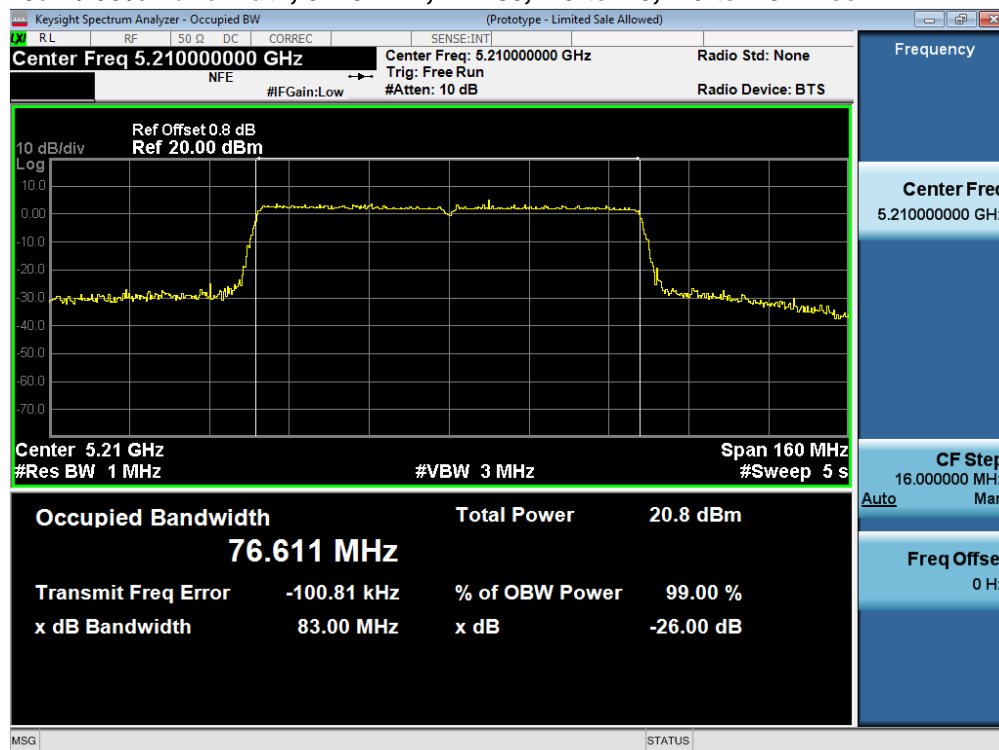



26dB / 99% Bandwidth, 5220 MHz, Non HT20, 6 to 54 Mbps

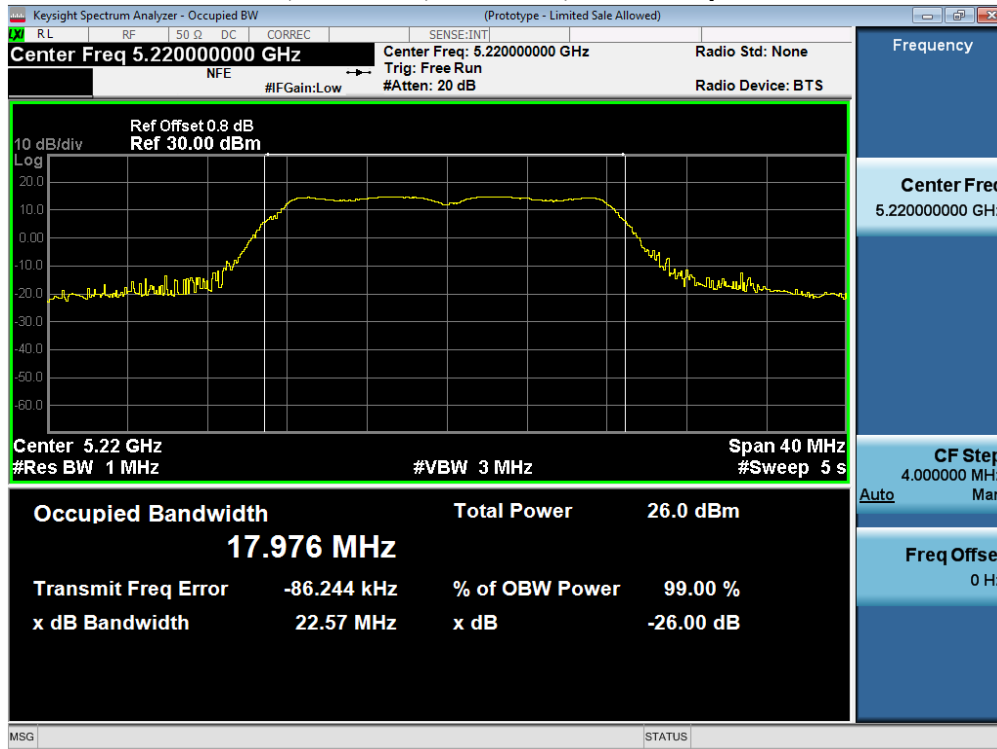

26dB / 99% Bandwidth, 5220 MHz, HT/VHT20, M0 to M15

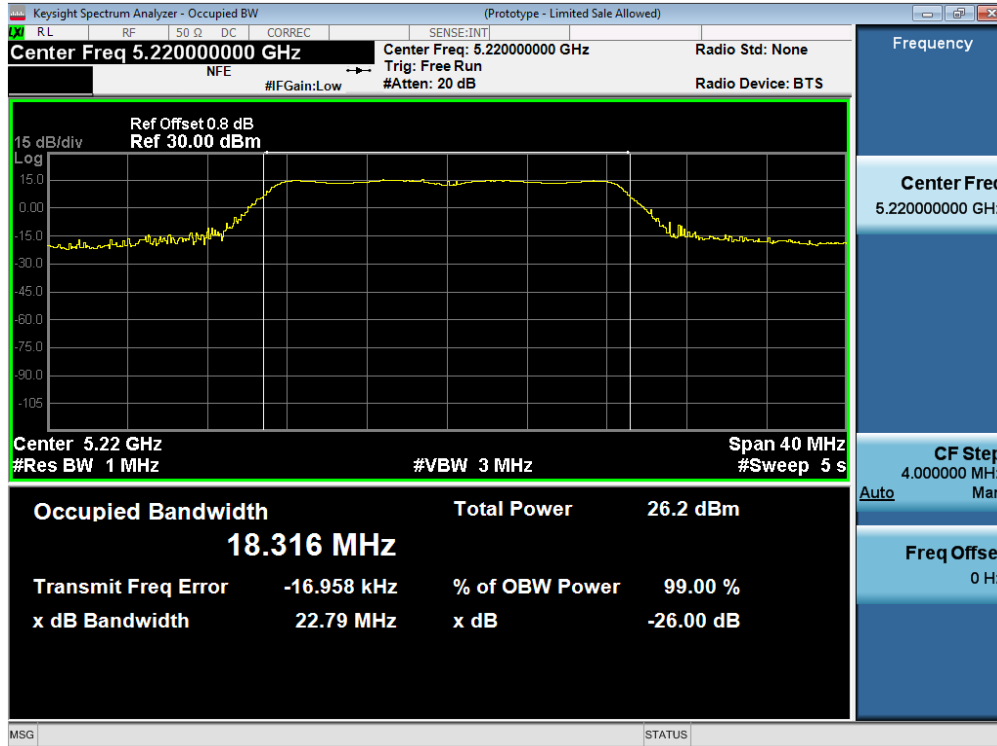

26dB / 99% Bandwidth, 5230 MHz, Non HT40, 6 to 54 Mbps

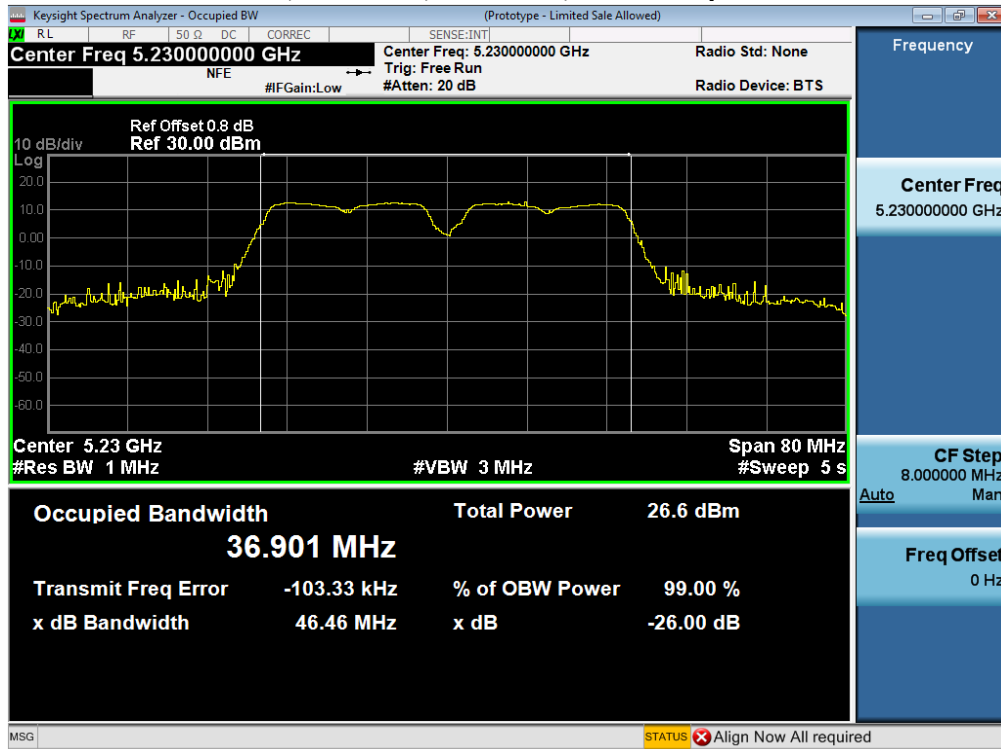

26dB / 99% Bandwidth, 5230 MHz, HT/VHT40, M0 to M15

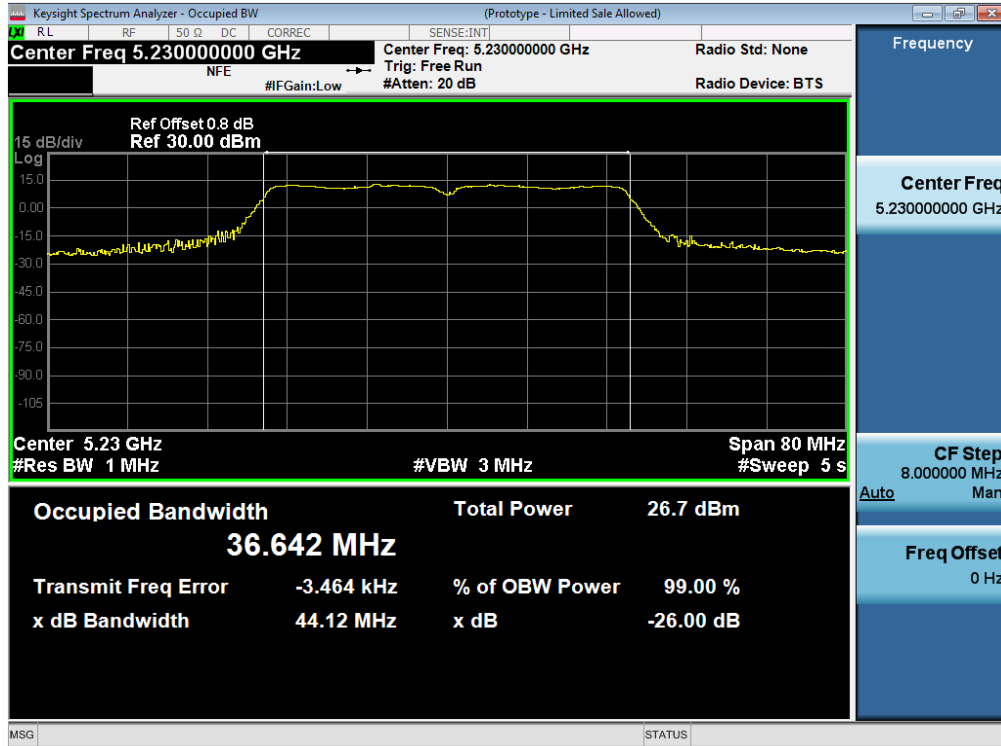



26dB / 99% Bandwidth, 5240 MHz, Non HT20, 6 to 54 Mbps

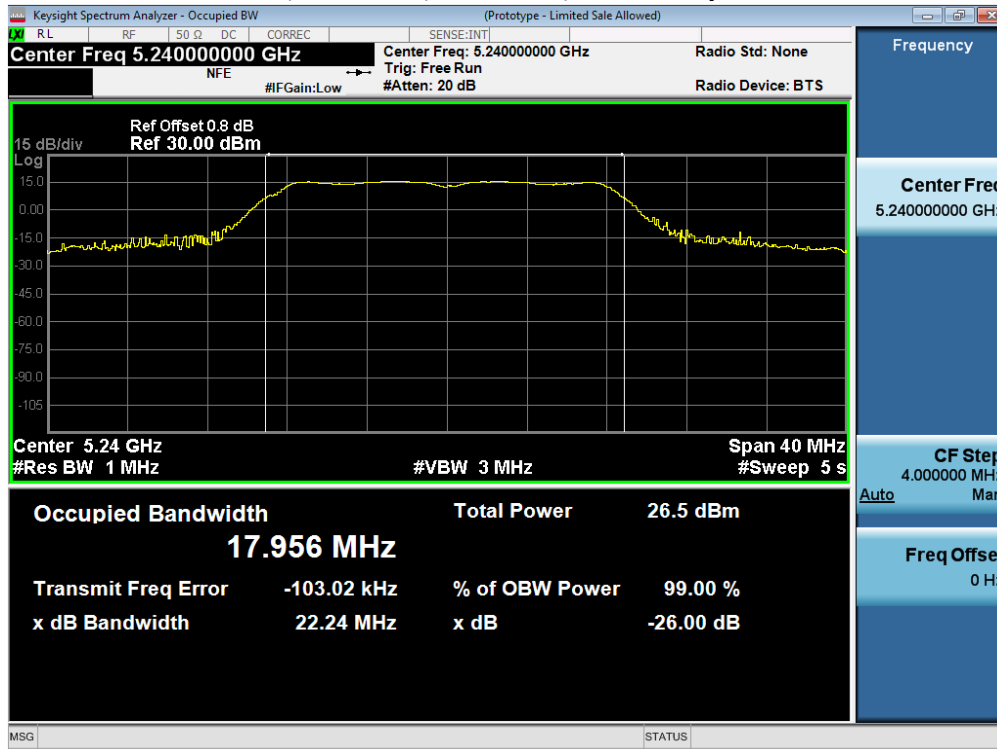

26dB / 99% Bandwidth, 5240 MHz, HT/VHT20, M0 to M15

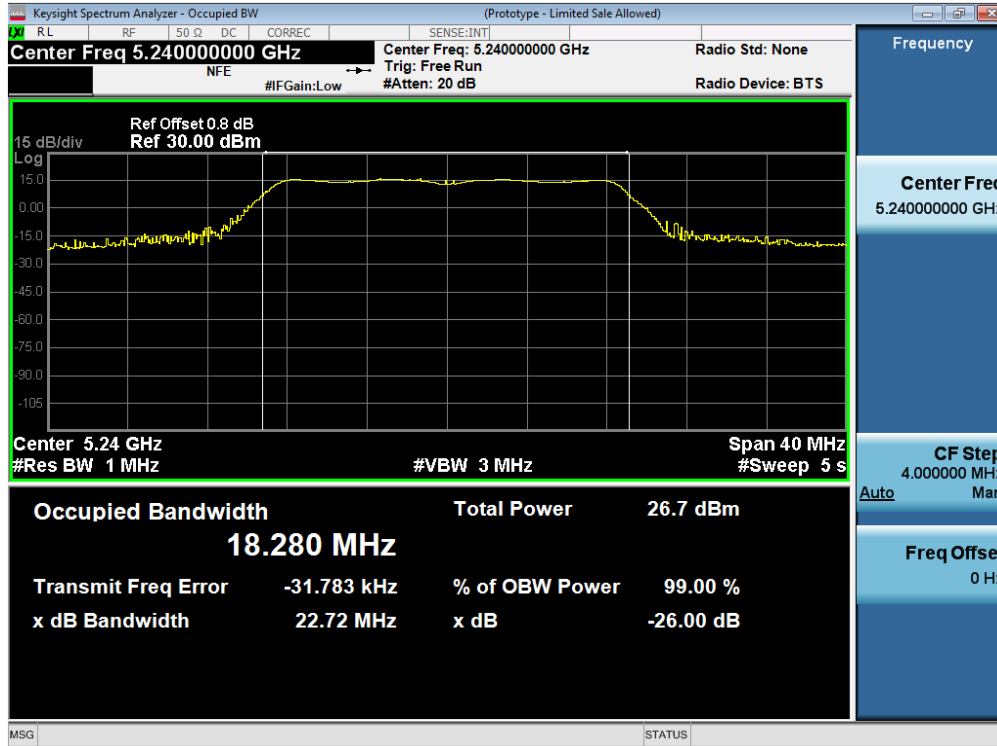

A.2 Maximum Conducted Output Power/ Power Spectral Density

15.407 (i) For an outdoor access point operating in the band 5.15-5.25 GHz, the maximum conducted output power over the frequency band of operation shall not exceed 1 W provided the maximum antenna gain does not exceed 6 dBi. In addition, the maximum power spectral density shall not exceed 17 dBm in any 1 megahertz band. If transmitting antennas of directional gain greater than 6 dBi are used, both the maximum conducted output power and the maximum power spectral density shall be reduced by the amount in dB that the directional gain of the antenna exceeds 6 dBi. The maximum e.i.r.p. at any elevation angle above 30 degrees as measured from the horizon must not exceed 125 mW (21 dBm).

(ii) For an indoor access point operating in the band 5.15-5.25 GHz, the maximum conducted output power over the frequency band of operation shall not exceed 1 W provided the maximum antenna gain does not exceed 6 dBi. In addition, the maximum power spectral density shall not exceed 17 dBm in any 1 megahertz band. If transmitting antennas of directional gain greater than 6 dBi are used, both the maximum conducted output power and the maximum power spectral density shall be reduced by the amount in dB that the directional gain of the antenna exceeds 6 dBi.

Test Procedure

Ref. KDB 789033 D02 General UNII Test Procedures New Rules v01r03
ANSI C63.10: 2013

| |
|---|
| Output Power Test Procedure |
| <ol style="list-style-type: none"> 1. Set the radio in the continuous transmitting mode at full power 2. Compute power by integrating the spectrum across the EBW (or alternatively entire 99% OBW) of the signal using the instrument's band power measurement function. The integration shall be performed using the spectrum analyzer band-power measurement function with band limits set equal to the EBW or the OBW band edges. 3. Capture graphs and record pertinent measurement data. |

Ref. KDB 789033 D02 General UNII Test Procedures New Rules v01r03
ANSI C63.10: 2013 section 12.3.2.2 Method SA-1

| |
|---|
| Output Power Test parameters |
| Span = >1.5 times the OBW RBW = 1MHz VBW ≥ 3 x RBW Sweep = Auto couple Detector = sample Trace = Trace Average 100 |

The "measure-and-sum technique" is used for measuring in-band transmit power of a device. In the measure-and-sum approach, the conducted emission level is measured at each antenna port. The measured results at the various antenna ports are then summed mathematically to determine the total emission level from the device. Summing is performed in linear power units. (See ANSI C63.10 section 14.3.2.2)

| System Number | Description | Samples | System under test | Support equipment |
|---------------|-------------|---------|-------------------------------------|-------------------------------------|
| 1 | EUT | S01 | <input checked="" type="checkbox"/> | <input type="checkbox"/> |
| | Support | S02 | <input type="checkbox"/> | <input checked="" type="checkbox"/> |



| | |
|------------------------------------|--|
| Tested By : Jose Aguirre | Date of testing: 20-April-16 - 08-Aug-16 |
| Test Result : PASS | |

See Appendix C for list of test equipment

Antenna Gain: 4 dBi

| Frequency (MHz) | Mode | Tx Paths | Correlated Antenna Gain (dBi) | Tx 1 Max Power (dBm) | Tx 2 Max Power (dBm) | Tx 3 Max Power (dBm) | Total Tx Channel Power (dBm) | Limit (dBm) | Margin (dB) |
|-----------------|-------------------------------------|----------|-------------------------------|----------------------|----------------------|----------------------|------------------------------|-------------|-------------|
| 5180 | Non HT20, 6 to 54 Mbps | 1 | 4 | 15.7 | | | 15.7 | 30.0 | 14.3 |
| | Non HT20, 6 to 54 Mbps | 2 | 4 | 14.7 | 14.7 | | 17.7 | 30.0 | 12.3 |
| | Non HT20, 6 to 54 Mbps | 3 | 4 | 13.8 | 13.8 | 13.5 | 18.5 | 30.0 | 11.5 |
| | Non HT20 Beam Forming, 6 to 54 Mbps | 2 | 7 | 12.8 | 12.4 | | 15.6 | 29.0 | 13.4 |
| | Non HT20 Beam Forming, 6 to 54 Mbps | 3 | 9 | 8.8 | 8.9 | 8.6 | 13.5 | 27.0 | 13.5 |
| | HT/VHT20, M0 to M7 | 1 | 4 | 15.9 | | | 15.9 | 30.0 | 14.1 |
| | HT/VHT20, M0 to M7 | 2 | 4 | 14.8 | 14.9 | | 17.9 | 30.0 | 12.1 |
| | HT/VHT20, M8 to M15 | 2 | 4 | 14.8 | 14.9 | | 17.9 | 30.0 | 12.1 |
| | HT/VHT20, M0 to M7 | 3 | 4 | 14.0 | 14.0 | 13.7 | 18.7 | 30.0 | 11.3 |
| | HT/VHT20, M8 to M15 | 3 | 4 | 14.0 | 14.0 | 13.7 | 18.7 | 30.0 | 11.3 |
| | HT/VHT20 Beam Forming, M0 to M7 | 2 | 7 | 13.1 | 12.6 | | 15.9 | 29.0 | 13.1 |
| | HT/VHT20 Beam Forming, M8 to M15 | 2 | 4 | 14.8 | 14.9 | | 17.9 | 30.0 | 12.1 |
| | HT/VHT20 Beam Forming, M0 to M7 | 3 | 9 | 8.9 | 8.9 | 8.8 | 13.6 | 27.0 | 13.4 |
| | HT/VHT20 Beam Forming, M8 to M15 | 3 | 6 | 12.0 | 11.7 | 11.4 | 16.5 | 30.0 | 13.5 |
| | HT/VHT20 STBC, M0 to M7 | 2 | 4 | 14.8 | 14.9 | | 17.9 | 30.0 | 12.1 |
| | HT/VHT20 STBC, M0 to M7 | 3 | 4 | 14.0 | 14.0 | 13.7 | 18.7 | 30.0 | 11.3 |
| 5190 | Non HT40, 6 to 54 Mbps | 1 | 4 | 11.2 | | | 11.2 | 30.0 | 18.8 |
| | Non HT40, 6 to 54 Mbps | 2 | 4 | 10.2 | 10.2 | | 13.2 | 30.0 | 16.8 |
| | Non HT40, 6 to 54 Mbps | 3 | 4 | 10.2 | 10.2 | 9.7 | 14.8 | 30.0 | 15.2 |
| | HT/VHT40, M0 to M7 | 1 | 4 | 12.9 | | | 12.9 | 30.0 | 17.1 |
| | HT/VHT40, M0 to M7 | 2 | 4 | 12.0 | 11.8 | | 14.9 | 30.0 | 15.1 |
| | HT/VHT40, M8 to M15 | 2 | 4 | 12.0 | 11.8 | | 14.9 | 30.0 | 15.1 |
| | HT/VHT40, M0 to M7 | 3 | 4 | 11.1 | 10.9 | 10.5 | 15.6 | 30.0 | 14.4 |
| | HT/VHT40, M8 to M15 | 3 | 4 | 11.1 | 10.9 | 10.5 | 15.6 | 30.0 | 14.4 |
| | HT/VHT40 Beam Forming, M0 to M7 | 2 | 7 | 11.1 | 10.9 | | 14.0 | 29.0 | 15.0 |
| | HT/VHT40 Beam Forming, M8 to M15 | 2 | 4 | 12.0 | 11.8 | | 14.9 | 30.0 | 15.1 |
| | HT/VHT40 Beam Forming, M0 to M7 | 3 | 9 | 9.2 | 9.1 | 8.6 | 13.7 | 27.0 | 13.3 |
| | HT/VHT40 Beam Forming, M8 to M15 | 3 | 6 | 11.1 | 10.9 | 10.5 | 15.6 | 30.0 | 14.4 |
| | HT/VHT40 STBC, M0 to M7 | 2 | 4 | 12.0 | 11.8 | | 14.9 | 30.0 | 15.1 |
| | HT/VHT40 STBC, M0 to M7 | 3 | 4 | 11.1 | 10.9 | 10.5 | 15.6 | 30.0 | 14.4 |

| | | | | | | | | | |
|------|-------------------------------------|---|---|------|------|------|------|------|------|
| 5210 | Non HT80, 6 to 54 Mbps | 1 | 4 | 10.9 | | | 10.9 | 30.0 | 19.1 |
| | Non HT80, 6 to 54 Mbps | 2 | 4 | 10.9 | 10.5 | | 13.7 | 30.0 | 16.3 |
| | Non HT80, 6 to 54 Mbps | 3 | 4 | 10.0 | 9.6 | 9.5 | 14.5 | 30.0 | 15.5 |
| | VHT80, M0 to M9 1ss | 1 | 4 | 12.2 | | | 12.2 | 30.0 | 17.8 |
| | VHT80, M0 to M9 1ss | 2 | 4 | 11.3 | 10.9 | | 14.1 | 30.0 | 15.9 |
| | VHT80, M0 to M9 2ss | 2 | 4 | 11.3 | 10.9 | | 14.1 | 30.0 | 15.9 |
| | VHT80, M0 to M9 1ss | 3 | 4 | 11.3 | 10.9 | 10.9 | 15.8 | 30.0 | 14.2 |
| | VHT80, M0 to M9 2ss | 3 | 4 | 11.3 | 10.9 | 10.9 | 15.8 | 30.0 | 14.2 |
| | VHT80 Beam Forming, M0 to M9 1ss | 2 | 7 | 10.5 | 10.0 | | 13.3 | 29.0 | 15.7 |
| | VHT80 Beam Forming, M0 to M9 2ss | 2 | 4 | 11.3 | 10.9 | | 14.1 | 30.0 | 15.9 |
| | VHT80 Beam Forming, M0 to M9 1ss | 3 | 9 | 8.6 | 8.2 | 8.1 | 13.1 | 27.0 | 13.9 |
| | VHT80 Beam Forming, M0 to M9 2ss | 3 | 6 | 10.5 | 10.0 | 10.0 | 14.9 | 30.0 | 15.1 |
| | VHT80 STBC, M0 to M9 1ss | 2 | 4 | 11.3 | 10.9 | | 14.1 | 30.0 | 15.9 |
| | VHT80 STBC, M0 to M9 1ss | 3 | 4 | 11.3 | 10.9 | 10.9 | 15.8 | 30.0 | 14.2 |
| 5220 | Non HT20, 6 to 54 Mbps | 1 | 4 | 18.0 | | | 18.0 | 30.0 | 12.0 |
| | Non HT20, 6 to 54 Mbps | 2 | 4 | 15.3 | 15.3 | | 18.3 | 30.0 | 11.7 |
| | Non HT20, 6 to 54 Mbps | 3 | 4 | 13.2 | 13.0 | 13.2 | 17.9 | 30.0 | 12.1 |
| | Non HT20 Beam Forming, 6 to 54 Mbps | 2 | 7 | 12.3 | 12.1 | | 15.2 | 29.0 | 13.8 |
| | Non HT20 Beam Forming, 6 to 54 Mbps | 3 | 9 | 8.4 | 8.4 | 8.6 | 13.2 | 27.0 | 13.8 |
| | HT/VHT20, M0 to M7 | 1 | 4 | 18.2 | | | 18.2 | 30.0 | 11.8 |
| | HT/VHT20, M0 to M7 | 2 | 4 | 15.4 | 15.5 | | 18.5 | 30.0 | 11.5 |
| | HT/VHT20, M8 to M15 | 2 | 4 | 15.4 | 15.5 | | 18.5 | 30.0 | 11.5 |
| | HT/VHT20, M0 to M7 | 3 | 4 | 13.3 | 13.2 | 13.4 | 18.1 | 30.0 | 11.9 |
| | HT/VHT20, M8 to M15 | 3 | 4 | 13.3 | 13.2 | 13.4 | 18.1 | 30.0 | 11.9 |
| | HT/VHT20 Beam Forming, M0 to M7 | 2 | 7 | 12.4 | 12.2 | | 15.3 | 29.0 | 13.7 |
| | HT/VHT20 Beam Forming, M8 to M15 | 2 | 4 | 15.4 | 15.5 | | 18.5 | 30.0 | 11.5 |
| | HT/VHT20 Beam Forming, M0 to M7 | 3 | 9 | 8.6 | 8.5 | 8.7 | 13.4 | 27.0 | 13.6 |
| | HT/VHT20 Beam Forming, M8 to M15 | 3 | 6 | 11.5 | 11.4 | 11.5 | 16.2 | 30.0 | 13.8 |
| | HT/VHT20 STBC, M0 to M7 | 2 | 4 | 15.4 | 15.5 | | 18.5 | 30.0 | 11.5 |
| | HT/VHT20 STBC, M0 to M7 | 3 | 4 | 13.3 | 13.2 | 13.4 | 18.1 | 30.0 | 11.9 |
| 5230 | Non HT40, 6 to 54 Mbps | 1 | 4 | 18.6 | | | 18.6 | 30.0 | 11.4 |
| | Non HT40, 6 to 54 Mbps | 2 | 4 | 15.6 | 15.6 | | 18.6 | 30.0 | 11.4 |
| | Non HT40, 6 to 54 Mbps | 3 | 4 | 13.8 | 13.6 | 13.5 | 18.4 | 30.0 | 11.6 |
| | HT/VHT40, M0 to M7 | 1 | 4 | 18.5 | | | 18.5 | 30.0 | 11.5 |
| | HT/VHT40, M0 to M7 | 2 | 4 | 15.7 | 15.3 | | 18.5 | 30.0 | 11.5 |
| | HT/VHT40, M8 to M15 | 2 | 4 | 15.7 | 15.3 | | 18.5 | 30.0 | 11.5 |
| | HT/VHT40, M0 to M7 | 3 | 4 | 13.5 | 13.1 | 13.4 | 18.1 | 30.0 | 11.9 |
| | HT/VHT40, M8 to M15 | 3 | 4 | 13.5 | 13.1 | 13.4 | 18.1 | 30.0 | 11.9 |
| | HT/VHT40 Beam Forming, M0 to M7 | 2 | 7 | 12.6 | 12.2 | | 15.4 | 29.0 | 13.6 |
| | HT/VHT40 Beam Forming, M8 to M15 | 2 | 4 | 15.7 | 15.3 | | 18.5 | 30.0 | 11.5 |
| | HT/VHT40 Beam Forming, M0 to M7 | 3 | 9 | 8.9 | 8.5 | 8.8 | 13.5 | 27.0 | 13.5 |

| | | | | | | | | | |
|------|-------------------------------------|---|---|------|------|------|------|------|------|
| | HT/VHT40 Beam Forming, M8 to M15 | 3 | 6 | 11.7 | 11.2 | 11.5 | 16.2 | 30.0 | 13.8 |
| | HT/VHT40 STBC, M0 to M7 | 2 | 4 | 15.7 | 15.3 | | 18.5 | 30.0 | 11.5 |
| | HT/VHT40 STBC, M0 to M7 | 3 | 4 | 13.5 | 13.1 | 13.4 | 18.1 | 30.0 | 11.9 |
| | | | | | | | | | |
| 5240 | Non HT20, 6 to 54 Mbps | 1 | 4 | 18.6 | | | 18.6 | 30.0 | 11.4 |
| | Non HT20, 6 to 54 Mbps | 2 | 4 | 15.7 | 15.2 | | 18.5 | 30.0 | 11.5 |
| | Non HT20, 6 to 54 Mbps | 3 | 4 | 13.5 | 13.0 | 13.6 | 18.1 | 30.0 | 11.9 |
| | Non HT20 Beam Forming, 6 to 54 Mbps | 2 | 7 | 12.6 | 12.0 | | 15.3 | 29.0 | 13.7 |
| | Non HT20 Beam Forming, 6 to 54 Mbps | 3 | 9 | 9.0 | 8.4 | 8.9 | 13.5 | 27.0 | 13.5 |
| | HT/VHT20, M0 to M7 | 1 | 4 | 18.6 | | | 18.6 | 30.0 | 11.4 |
| | HT/VHT20, M0 to M7 | 2 | 4 | 15.8 | 15.4 | | 18.6 | 30.0 | 11.4 |
| | HT/VHT20, M8 to M15 | 2 | 4 | 15.8 | 15.4 | | 18.6 | 30.0 | 11.4 |
| | HT/VHT20, M0 to M7 | 3 | 4 | 13.6 | 13.1 | 13.8 | 18.3 | 30.0 | 11.7 |
| | HT/VHT20, M8 to M15 | 3 | 4 | 13.6 | 13.1 | 13.8 | 18.3 | 30.0 | 11.7 |
| | HT/VHT20 Beam Forming, M0 to M7 | 2 | 7 | 12.7 | 12.2 | | 15.5 | 29.0 | 13.5 |
| | HT/VHT20 Beam Forming, M8 to M15 | 2 | 4 | 15.8 | 15.4 | | 18.6 | 30.0 | 11.4 |
| | HT/VHT20 Beam Forming, M0 to M7 | 3 | 9 | 9.1 | 8.5 | 9.0 | 13.6 | 27.0 | 13.4 |
| | HT/VHT20 Beam Forming, M8 to M15 | 3 | 6 | 11.8 | 11.2 | 11.8 | 16.4 | 30.0 | 13.6 |
| | HT/VHT20 STBC, M0 to M7 | 2 | 4 | 15.8 | 15.4 | | 18.6 | 30.0 | 11.4 |
| | HT/VHT20 STBC, M0 to M7 | 3 | 4 | 13.6 | 13.1 | 13.8 | 18.3 | 30.0 | 11.7 |

Peak Output Power, 5180 MHz, HT/VHT20, M0 to M7



Antenna A

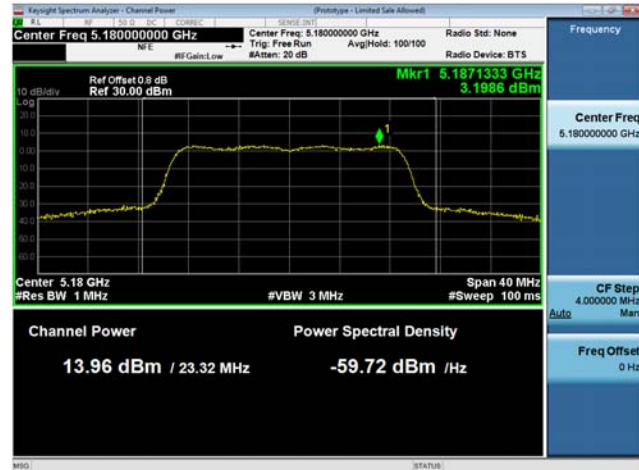

Antenna B

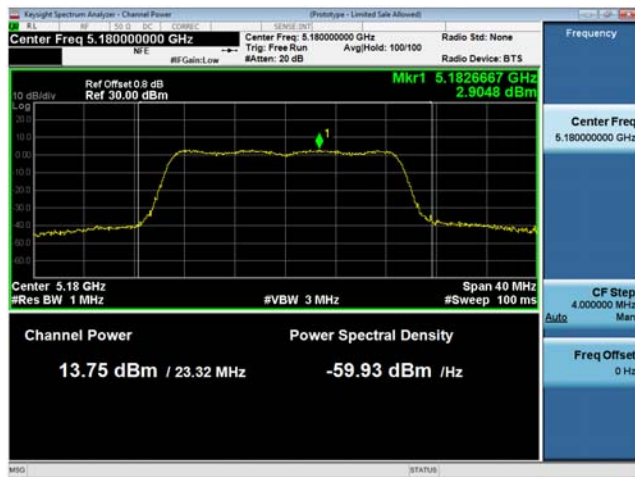

Antenna C

Antenna Gain: 10 dBi

| Frequency (MHz) | Mode | Tx Paths | Correlated Antenna Gain (dBi) | Tx 1 Max Power (dBm) | Tx 2 Max Power (dBm) | Tx 3 Max Power (dBm) | Total Tx Channel Power (dBm) | Limit (dBm) | Margin (dB) |
|-----------------|-------------------------------------|----------|-------------------------------|----------------------|----------------------|----------------------|------------------------------|-------------|-------------|
| 5180 | Non HT20, 6 to 54 Mbps | 1 | 10 | 12.8 | | | 12.8 | 26.0 | 13.2 |
| | Non HT20, 6 to 54 Mbps | 2 | 10 | 12.8 | 12.4 | | 15.6 | 26.0 | 10.4 |
| | Non HT20, 6 to 54 Mbps | 3 | 10 | 10.8 | 10.7 | 10.4 | 15.4 | 26.0 | 10.6 |
| | Non HT20 Beam Forming, 6 to 54 Mbps | 2 | 10 | 9.8 | 9.8 | | 12.8 | 26.0 | 13.2 |
| | Non HT20 Beam Forming, 6 to 54 Mbps | 3 | 13 | 5.6 | 6.0 | 5.6 | 10.5 | 23.0 | 12.5 |
| | HT/VHT20, M0 to M7 | 1 | 10 | 13.1 | | | 13.1 | 26.0 | 12.9 |
| | HT/VHT20, M0 to M7 | 2 | 10 | 13.1 | 12.6 | | 15.9 | 26.0 | 10.1 |
| | HT/VHT20, M8 to M15 | 2 | 10 | 13.1 | 12.6 | | 15.9 | 26.0 | 10.1 |
| | HT/VHT20, M0 to M7 | 3 | 10 | 11.0 | 10.8 | 10.5 | 15.5 | 26.0 | 10.5 |
| | HT/VHT20, M8 to M15 | 3 | 10 | 11.0 | 10.8 | 10.5 | 15.5 | 26.0 | 10.5 |
| | HT/VHT20 Beam Forming, M0 to M7 | 2 | 10 | 10.0 | 9.9 | | 13.0 | 26.0 | 13.0 |
| | HT/VHT20 Beam Forming, M8 to M15 | 2 | 10 | 13.1 | 12.6 | | 15.9 | 26.0 | 10.1 |
| | HT/VHT20 Beam Forming, M0 to M7 | 3 | 13 | 5.9 | 6.2 | 5.8 | 10.7 | 23.0 | 12.3 |
| | HT/VHT20 Beam Forming, M8 to M15 | 3 | 10 | 8.9 | 8.9 | 8.8 | 13.6 | 26.0 | 12.4 |
| | HT/VHT20 STBC, M0 to M7 | 2 | 10 | 13.1 | 12.6 | | 15.9 | 26.0 | 10.1 |
| | HT/VHT20 STBC, M0 to M7 | 3 | 10 | 11.0 | 10.8 | 10.5 | 15.5 | 26.0 | 10.5 |
| 5190 | Non HT40, 6 to 54 Mbps | 1 | 10 | 9.4 | | | 9.4 | 26.0 | 16.6 |
| | Non HT40, 6 to 54 Mbps | 2 | 10 | 8.4 | 8.1 | | 11.3 | 26.0 | 14.7 |
| | Non HT40, 6 to 54 Mbps | 3 | 10 | 8.4 | 8.1 | 7.9 | 12.9 | 26.0 | 13.1 |
| | HT/VHT40, M0 to M7 | 1 | 10 | 11.1 | | | 11.1 | 26.0 | 14.9 |
| | HT/VHT40, M0 to M7 | 2 | 10 | 10.1 | 10.0 | | 13.1 | 26.0 | 12.9 |
| | HT/VHT40, M8 to M15 | 2 | 10 | 10.1 | 10.0 | | 13.1 | 26.0 | 12.9 |
| | HT/VHT40, M0 to M7 | 3 | 10 | 9.2 | 9.1 | 8.6 | 13.7 | 26.0 | 12.3 |
| | HT/VHT40, M8 to M15 | 3 | 10 | 9.2 | 9.1 | 8.6 | 13.7 | 26.0 | 12.3 |
| | HT/VHT40 Beam Forming, M0 to M7 | 2 | 10 | 9.2 | 9.1 | | 12.2 | 26.0 | 13.8 |
| | HT/VHT40 Beam Forming, M8 to M15 | 2 | 10 | 10.1 | 10.0 | | 13.1 | 26.0 | 12.9 |
| | HT/VHT40 Beam Forming, M0 to M7 | 3 | 13 | 6.2 | 6.1 | 5.7 | 10.8 | 23.0 | 12.2 |
| | HT/VHT40 Beam Forming, M8 to M15 | 3 | 10 | 9.2 | 9.1 | 8.6 | 13.7 | 26.0 | 12.3 |
| | HT/VHT40 STBC, M0 to M7 | 2 | 10 | 10.1 | 10.0 | | 13.1 | 26.0 | 12.9 |
| | HT/VHT40 STBC, M0 to M7 | 3 | 10 | 9.2 | 9.1 | 8.6 | 13.7 | 26.0 | 12.3 |

| | | | | | | | | | |
|------|-------------------------------------|---|----|------|------|------|------|------|------|
| 5210 | Non HT80, 6 to 54 Mbps | 1 | 10 | 9.1 | | | 9.1 | 26.0 | 16.9 |
| | Non HT80, 6 to 54 Mbps | 2 | 10 | 8.0 | 7.8 | | 10.9 | 26.0 | 15.1 |
| | Non HT80, 6 to 54 Mbps | 3 | 10 | 7.0 | 6.6 | 6.5 | 11.5 | 26.0 | 14.5 |
| | VHT80, M0 to M9 1ss | 1 | 10 | 10.5 | | | 10.5 | 26.0 | 15.5 |
| | VHT80, M0 to M9 1ss | 2 | 10 | 9.6 | 9.1 | | 12.4 | 26.0 | 13.6 |
| | VHT80, M0 to M9 2ss | 2 | 10 | 9.6 | 9.1 | | 12.4 | 26.0 | 13.6 |
| | VHT80, M0 to M9 1ss | 3 | 10 | 8.6 | 8.2 | 8.1 | 13.1 | 26.0 | 12.9 |
| | VHT80, M0 to M9 2ss | 3 | 10 | 8.6 | 8.2 | 8.1 | 13.1 | 26.0 | 12.9 |
| | VHT80 Beam Forming, M0 to M9 1ss | 2 | 10 | 9.6 | 9.1 | | 12.4 | 26.0 | 13.6 |
| | VHT80 Beam Forming, M0 to M9 2ss | 2 | 10 | 9.6 | 9.1 | | 12.4 | 26.0 | 13.6 |
| | VHT80 Beam Forming, M0 to M9 1ss | 3 | 13 | 5.5 | 5.3 | 5.1 | 10.1 | 23.0 | 12.9 |
| | VHT80 Beam Forming, M0 to M9 2ss | 3 | 10 | 8.6 | 8.2 | 8.1 | 13.1 | 26.0 | 12.9 |
| | VHT80 STBC, M0 to M9 1ss | 2 | 10 | 9.6 | 9.1 | | 12.4 | 26.0 | 13.6 |
| | VHT80 STBC, M0 to M9 1ss | 3 | 10 | 8.6 | 8.2 | 8.1 | 13.1 | 26.0 | 12.9 |
| 5220 | Non HT20, 6 to 54 Mbps | 1 | 10 | 15.3 | | | 15.3 | 26.0 | 10.7 |
| | Non HT20, 6 to 54 Mbps | 2 | 10 | 12.3 | 12.1 | | 15.2 | 26.0 | 10.8 |
| | Non HT20, 6 to 54 Mbps | 3 | 10 | 10.4 | 10.2 | 10.4 | 15.1 | 26.0 | 10.9 |
| | Non HT20 Beam Forming, 6 to 54 Mbps | 2 | 10 | 9.5 | 9.3 | | 12.4 | 26.0 | 13.6 |
| | Non HT20 Beam Forming, 6 to 54 Mbps | 3 | 13 | 5.4 | 5.4 | 5.6 | 10.2 | 23.0 | 12.8 |
| | HT/VHT20, M0 to M7 | 1 | 10 | 15.4 | | | 15.4 | 26.0 | 10.6 |
| | HT/VHT20, M0 to M7 | 2 | 10 | 12.4 | 12.2 | | 15.3 | 26.0 | 10.7 |
| | HT/VHT20, M8 to M15 | 2 | 10 | 12.4 | 12.2 | | 15.3 | 26.0 | 10.7 |
| | HT/VHT20, M0 to M7 | 3 | 10 | 10.5 | 10.4 | 10.6 | 15.3 | 26.0 | 10.7 |
| | HT/VHT20, M8 to M15 | 3 | 10 | 10.5 | 10.4 | 10.6 | 15.3 | 26.0 | 10.7 |
| | HT/VHT20 Beam Forming, M0 to M7 | 2 | 10 | 9.7 | 9.5 | | 12.6 | 26.0 | 13.4 |
| | HT/VHT20 Beam Forming, M8 to M15 | 2 | 10 | 12.4 | 12.2 | | 15.3 | 26.0 | 10.7 |
| | HT/VHT20 Beam Forming, M0 to M7 | 3 | 13 | 5.6 | 5.5 | 5.7 | 10.4 | 23.0 | 12.6 |
| | HT/VHT20 Beam Forming, M8 to M15 | 3 | 10 | 8.6 | 8.5 | 8.7 | 13.4 | 26.0 | 12.6 |
| | HT/VHT20 STBC, M0 to M7 | 2 | 10 | 12.4 | 12.2 | | 15.3 | 26.0 | 10.7 |
| | HT/VHT20 STBC, M0 to M7 | 3 | 10 | 10.5 | 10.4 | 10.6 | 15.3 | 26.0 | 10.7 |
| 5230 | Non HT40, 6 to 54 Mbps | 1 | 10 | 15.6 | | | 15.6 | 26.0 | 10.4 |
| | Non HT40, 6 to 54 Mbps | 2 | 10 | 12.8 | 12.6 | | 15.7 | 26.0 | 10.3 |
| | Non HT40, 6 to 54 Mbps | 3 | 10 | 10.8 | 10.5 | 10.7 | 15.4 | 26.0 | 10.6 |
| | HT/VHT40, M0 to M7 | 1 | 10 | 15.7 | | | 15.7 | 26.0 | 10.3 |
| | HT/VHT40, M0 to M7 | 2 | 10 | 12.6 | 12.2 | | 15.4 | 26.0 | 10.6 |
| | HT/VHT40, M8 to M15 | 2 | 10 | 12.6 | 12.2 | | 15.4 | 26.0 | 10.6 |
| | HT/VHT40, M0 to M7 | 3 | 10 | 10.8 | 10.3 | 10.6 | 15.3 | 26.0 | 10.7 |
| | HT/VHT40, M8 to M15 | 3 | 10 | 10.8 | 10.3 | 10.6 | 15.3 | 26.0 | 10.7 |
| | HT/VHT40 Beam Forming, M0 to M7 | 2 | 10 | 9.8 | 9.4 | | 12.6 | 26.0 | 13.4 |
| | HT/VHT40 Beam Forming, M8 to M15 | 2 | 10 | 12.6 | 12.2 | | 15.4 | 26.0 | 10.6 |
| | HT/VHT40 Beam Forming, M0 to M7 | 3 | 13 | 5.9 | 5.3 | 5.7 | 10.4 | 23.0 | 12.6 |



| | | | | | | | | | |
|------|-------------------------------------|---|----|------|------|------|------|------|------|
| | HT/VHT40 Beam Forming, M8 to M15 | 3 | 10 | 8.9 | 8.5 | 8.8 | 13.5 | 26.0 | 12.5 |
| | HT/VHT40 STBC, M0 to M7 | 2 | 10 | 12.6 | 12.2 | | 15.4 | 26.0 | 10.6 |
| | HT/VHT40 STBC, M0 to M7 | 3 | 10 | 10.8 | 10.3 | 10.6 | 15.3 | 26.0 | 10.7 |
| | | | | | | | | | |
| 5240 | Non HT20, 6 to 54 Mbps | 1 | 10 | 15.7 | | | 15.7 | 26.0 | 10.3 |
| | Non HT20, 6 to 54 Mbps | 2 | 10 | 12.6 | 12.0 | | 15.3 | 26.0 | 10.7 |
| | Non HT20, 6 to 54 Mbps | 3 | 10 | 10.8 | 10.2 | 10.7 | 15.3 | 26.0 | 10.7 |
| | Non HT20 Beam Forming, 6 to 54 Mbps | 2 | 10 | 9.8 | 9.3 | | 12.6 | 26.0 | 13.4 |
| | Non HT20 Beam Forming, 6 to 54 Mbps | 3 | 13 | 5.8 | 5.3 | 5.8 | 10.4 | 23.0 | 12.6 |
| | HT/VHT20, M0 to M7 | 1 | 10 | 15.8 | | | 15.8 | 26.0 | 10.2 |
| | HT/VHT20, M0 to M7 | 2 | 10 | 12.7 | 12.2 | | 15.5 | 26.0 | 10.5 |
| | HT/VHT20, M8 to M15 | 2 | 10 | 12.7 | 12.2 | | 15.5 | 26.0 | 10.5 |
| | HT/VHT20, M0 to M7 | 3 | 10 | 10.9 | 10.3 | 10.8 | 15.4 | 26.0 | 10.6 |
| | HT/VHT20, M8 to M15 | 3 | 10 | 10.9 | 10.3 | 10.8 | 15.4 | 26.0 | 10.6 |
| | HT/VHT20 Beam Forming, M0 to M7 | 2 | 10 | 9.9 | 9.4 | | 12.7 | 26.0 | 13.3 |
| | HT/VHT20 Beam Forming, M8 to M15 | 2 | 10 | 12.7 | 12.2 | | 15.5 | 26.0 | 10.5 |
| | HT/VHT20 Beam Forming, M0 to M7 | 3 | 13 | 5.9 | 5.4 | 5.9 | 10.5 | 23.0 | 12.5 |
| | HT/VHT20 Beam Forming, M8 to M15 | 3 | 10 | 9.1 | 8.5 | 9.0 | 13.6 | 26.0 | 12.4 |
| | HT/VHT20 STBC, M0 to M7 | 2 | 10 | 12.7 | 12.2 | | 15.5 | 26.0 | 10.5 |
| | HT/VHT20 STBC, M0 to M7 | 3 | 10 | 10.9 | 10.3 | 10.8 | 15.4 | 26.0 | 10.6 |

Peak Output Power, 5180 MHz, HT/VHT20, M0 to M7



Antenna A



Antenna B

Antenna Gain: 4 dBi

| Frequency (MHz) | Mode | Tx Paths | Correlated Antenna Gain (dBi) | Tx 1 PSD (dBm/MHz) | Tx 2 PSD (dBm/MHz) | Tx 3 PSD (dBm/MHz) | Total PSD (dBm/MHz) | Limit (dBm/MHz) | Margin (dB) |
|-------------------------|-------------------------------------|----------|-------------------------------|--------------------|--------------------|--------------------|---------------------|-----------------|-------------|
| 5180 | Non HT20, 6 to 54 Mbps | 1 | 4 | 5.2 | | | 5.2 | 17.0 | 11.8 |
| | Non HT20, 6 to 54 Mbps | 2 | 7 | 4.0 | 4.4 | | 7.2 | 16.0 | 8.8 |
| | Non HT20, 6 to 54 Mbps | 3 | 9 | 3.0 | 3.1 | 2.9 | 7.8 | 14.0 | 6.2 |
| | Non HT20 Beam Forming, 6 to 54 Mbps | 2 | 7 | 2.3 | 2.1 | | 5.2 | 16.0 | 10.8 |
| | Non HT20 Beam Forming, 6 to 54 Mbps | 3 | 9 | -1.7 | -1.8 | -2.0 | 2.9 | 14.0 | 11.1 |
| | HT/VHT20, M0 to M7 | 1 | 4 | 5.4 | | | 5.4 | 17.0 | 11.6 |
| | HT/VHT20, M0 to M7 | 2 | 7 | 4.2 | 4.3 | | 7.3 | 16.0 | 8.7 |
| | HT/VHT20, M8 to M15 | 2 | 4 | 4.2 | 4.3 | | 7.3 | 17.0 | 9.7 |
| | HT/VHT20, M0 to M7 | 3 | 9 | 3.3 | 3.2 | 2.9 | 7.9 | 14.0 | 6.1 |
| | HT/VHT20, M8 to M15 | 3 | 6 | 3.3 | 3.2 | 2.9 | 7.9 | 17.0 | 9.1 |
| | HT/VHT20 Beam Forming, M0 to M7 | 2 | 7 | 2.8 | 1.9 | | 5.4 | 16.0 | 10.6 |
| | HT/VHT20 Beam Forming, M8 to M15 | 2 | 4 | 4.2 | 4.3 | | 7.3 | 17.0 | 9.7 |
| | HT/VHT20 Beam Forming, M0 to M7 | 3 | 9 | -1.6 | -1.9 | -2.0 | 2.9 | 14.0 | 11.1 |
| | HT/VHT20 Beam Forming, M8 to M15 | 3 | 6 | 1.0 | 0.8 | 0.6 | 5.6 | 17.0 | 11.4 |
| | HT/VHT20 STBC, M0 to M7 | 2 | 4 | 4.2 | 4.3 | | 7.3 | 17.0 | 9.7 |
| HT/VHT20 STBC, M0 to M7 | 3 | 6 | 3.3 | 3.2 | 2.9 | 7.9 | 17.0 | 9.1 | |
| 5190 | Non HT40, 6 to 54 Mbps | 1 | 4 | -2.1 | | | -2.1 | 17.0 | 19.1 |
| | Non HT40, 6 to 54 Mbps | 2 | 7 | -3.1 | -3.4 | | -0.2 | 16.0 | 16.2 |
| | Non HT40, 6 to 54 Mbps | 3 | 9 | -3.1 | -3.4 | -3.6 | 1.4 | 14.0 | 12.6 |
| | HT/VHT40, M0 to M7 | 1 | 4 | -0.8 | | | -0.8 | 17.0 | 17.8 |
| | HT/VHT40, M0 to M7 | 2 | 7 | -1.5 | -2.0 | | 1.3 | 16.0 | 14.7 |
| | HT/VHT40, M8 to M15 | 2 | 4 | -1.5 | -2.0 | | 1.3 | 17.0 | 15.7 |
| | HT/VHT40, M0 to M7 | 3 | 9 | -2.6 | -3.1 | -3.4 | 1.8 | 14.0 | 12.2 |
| | HT/VHT40, M8 to M15 | 3 | 6 | -2.6 | -3.1 | -3.4 | 1.8 | 17.0 | 15.2 |
| | HT/VHT40 Beam Forming, M0 to M7 | 2 | 7 | -2.6 | -3.1 | | 0.2 | 16.0 | 15.8 |
| | HT/VHT40 Beam Forming, M8 to M15 | 2 | 4 | -1.5 | -2.0 | | 1.3 | 17.0 | 15.7 |
| | HT/VHT40 Beam Forming, M0 to M7 | 3 | 9 | -4.4 | -4.6 | -5.1 | 0.1 | 14.0 | 13.9 |
| | HT/VHT40 Beam Forming, M8 to M15 | 3 | 6 | -2.6 | -3.1 | -3.4 | 1.8 | 17.0 | 15.2 |
| | HT/VHT40 STBC, M0 to M7 | 2 | 4 | -1.5 | -2.0 | | 1.3 | 17.0 | 15.7 |
| | HT/VHT40 STBC, M0 to M7 | 3 | 6 | -2.6 | -3.1 | -3.4 | 1.8 | 17.0 | 15.2 |

| | | | | | | | | | |
|------|-------------------------------------|---|---|------|------|------|------|------|------|
| 5210 | Non HT80, 6 to 54 Mbps | 1 | 4 | -5.8 | | | -5.8 | 17.0 | 22.8 |
| | Non HT80, 6 to 54 Mbps | 2 | 7 | -5.8 | -6.3 | | -3.0 | 16.0 | 19.0 |
| | Non HT80, 6 to 54 Mbps | 3 | 9 | -6.8 | -7.4 | -7.2 | -2.4 | 14.0 | 16.4 |
| | VHT80, M0 to M9 1ss | 1 | 4 | -5.0 | | | -5.0 | 17.0 | 22.0 |
| | VHT80, M0 to M9 1ss | 2 | 7 | -6.0 | -6.4 | | -3.2 | 16.0 | 19.2 |
| | VHT80, M0 to M9 2ss | 2 | 4 | -6.0 | -6.4 | | -3.2 | 17.0 | 20.2 |
| | VHT80, M0 to M9 1ss | 3 | 9 | -6.0 | -6.4 | -5.9 | -1.3 | 14.0 | 15.3 |
| | VHT80, M0 to M9 2ss | 3 | 6 | -6.0 | -6.4 | -5.9 | -1.3 | 17.0 | 18.3 |
| | VHT80 Beam Forming, M0 to M9 1ss | 2 | 7 | -6.6 | -7.3 | | -3.9 | 16.0 | 19.9 |
| | VHT80 Beam Forming, M0 to M9 2ss | 2 | 4 | -6.0 | -6.4 | | -3.2 | 17.0 | 20.2 |
| | VHT80 Beam Forming, M0 to M9 1ss | 3 | 9 | -8.9 | -9.4 | -9.0 | -4.3 | 14.0 | 18.3 |
| | VHT80 Beam Forming, M0 to M9 2ss | 3 | 6 | -6.6 | -7.3 | -7.0 | -2.2 | 17.0 | 19.2 |
| | VHT80 STBC, M0 to M9 1ss | 2 | 4 | -6.0 | -6.4 | | -3.2 | 17.0 | 20.2 |
| | VHT80 STBC, M0 to M9 1ss | 3 | 4 | -6.0 | -6.4 | -5.9 | -1.3 | 17.0 | 18.3 |
| 5220 | Non HT20, 6 to 54 Mbps | 1 | 4 | 7.4 | | | 7.4 | 17.0 | 9.6 |
| | Non HT20, 6 to 54 Mbps | 2 | 7 | 4.5 | 4.7 | | 7.6 | 16.0 | 8.4 |
| | Non HT20, 6 to 54 Mbps | 3 | 9 | 2.5 | 2.6 | 2.6 | 7.3 | 14.0 | 6.7 |
| | Non HT20 Beam Forming, 6 to 54 Mbps | 2 | 7 | 1.7 | 1.6 | | 4.7 | 16.0 | 11.3 |
| | Non HT20 Beam Forming, 6 to 54 Mbps | 3 | 9 | -2.3 | -2.1 | -1.7 | 2.7 | 14.0 | 11.3 |
| | HT/VHT20, M0 to M7 | 1 | 4 | 7.5 | | | 7.5 | 17.0 | 9.5 |
| | HT/VHT20, M0 to M7 | 2 | 7 | 4.6 | 4.6 | | 7.6 | 16.0 | 8.4 |
| | HT/VHT20, M8 to M15 | 2 | 4 | 4.6 | 4.6 | | 7.6 | 17.0 | 9.4 |
| | HT/VHT20, M0 to M7 | 3 | 9 | 2.5 | 2.4 | 2.6 | 7.3 | 14.0 | 6.7 |
| | HT/VHT20, M8 to M15 | 3 | 6 | 2.5 | 2.4 | 2.6 | 7.3 | 17.0 | 9.7 |
| | HT/VHT20 Beam Forming, M0 to M7 | 2 | 7 | 1.5 | 1.5 | | 4.5 | 16.0 | 11.5 |
| | HT/VHT20 Beam Forming, M8 to M15 | 2 | 4 | 4.6 | 4.6 | | 7.6 | 17.0 | 9.4 |
| | HT/VHT20 Beam Forming, M0 to M7 | 3 | 9 | -2.1 | -2.4 | -2.2 | 2.5 | 14.0 | 11.5 |
| | HT/VHT20 Beam Forming, M8 to M15 | 3 | 6 | 0.6 | 0.4 | 0.8 | 5.4 | 17.0 | 11.6 |
| | HT/VHT20 STBC, M0 to M7 | 2 | 4 | 4.6 | 4.6 | | 7.6 | 17.0 | 9.4 |
| | HT/VHT20 STBC, M0 to M7 | 3 | 6 | 2.5 | 2.4 | 2.6 | 7.3 | 17.0 | 9.7 |
| 5230 | Non HT40, 6 to 54 Mbps | 1 | 4 | 5.1 | | | 5.1 | 17.0 | 11.9 |
| | Non HT40, 6 to 54 Mbps | 2 | 7 | 2.1 | 2.1 | | 5.1 | 16.0 | 10.9 |
| | Non HT40, 6 to 54 Mbps | 3 | 9 | 0.2 | 0.3 | 0.0 | 4.9 | 14.0 | 9.1 |
| | HT/VHT40, M0 to M7 | 1 | 4 | 4.9 | | | 4.9 | 17.0 | 12.1 |
| | HT/VHT40, M0 to M7 | 2 | 7 | 1.9 | 1.7 | | 4.8 | 16.0 | 11.2 |
| | HT/VHT40, M8 to M15 | 2 | 4 | 1.9 | 1.7 | | 4.8 | 17.0 | 12.2 |
| | HT/VHT40, M0 to M7 | 3 | 9 | -0.2 | -0.9 | -0.4 | 4.3 | 14.0 | 9.7 |
| | HT/VHT40, M8 to M15 | 3 | 6 | -0.2 | -0.9 | -0.4 | 4.3 | 17.0 | 12.7 |
| | HT/VHT40 Beam Forming, M0 to M7 | 2 | 7 | -1.4 | -1.6 | | 1.5 | 16.0 | 14.5 |
| | HT/VHT40 Beam Forming, M8 to M15 | 2 | 4 | 1.9 | 1.7 | | 4.8 | 17.0 | 12.2 |
| | HT/VHT40 Beam Forming, M0 to M7 | 3 | 9 | -5.0 | -5.1 | -5.0 | -0.3 | 14.0 | 14.3 |



| | | | | | | | | | |
|------|-------------------------------------|---|---|------|------|------|-----|------|------|
| | HT/VHT40 Beam Forming, M8 to M15 | 3 | 6 | -2.2 | -2.5 | -2.4 | 2.4 | 17.0 | 14.6 |
| | HT/VHT40 STBC, M0 to M7 | 2 | 4 | 1.9 | 1.7 | | 4.8 | 17.0 | 12.2 |
| | HT/VHT40 STBC, M0 to M7 | 3 | 6 | -0.2 | -0.9 | -0.4 | 4.3 | 17.0 | 12.7 |
| | | | | | | | | | |
| 5240 | Non HT20, 6 to 54 Mbps | 1 | 4 | 8.2 | | | 8.2 | 17.0 | 8.8 |
| | Non HT20, 6 to 54 Mbps | 2 | 7 | 5.3 | 4.6 | | 8.0 | 16.0 | 8.0 |
| | Non HT20, 6 to 54 Mbps | 3 | 9 | 2.8 | 2.5 | 3.3 | 7.7 | 14.0 | 6.3 |
| | Non HT20 Beam Forming, 6 to 54 Mbps | 2 | 7 | 2.2 | 1.5 | | 4.9 | 16.0 | 11.1 |
| | Non HT20 Beam Forming, 6 to 54 Mbps | 3 | 9 | -1.7 | -2.1 | -1.6 | 3.0 | 14.0 | 11.0 |
| | HT/VHT20, M0 to M7 | 1 | 4 | 7.8 | | | 7.8 | 17.0 | 9.2 |
| | HT/VHT20, M0 to M7 | 2 | 7 | 5.1 | 4.7 | | 7.9 | 16.0 | 8.1 |
| | HT/VHT20, M8 to M15 | 2 | 4 | 5.1 | 4.7 | | 7.9 | 17.0 | 9.1 |
| | HT/VHT20, M0 to M7 | 3 | 9 | 2.8 | 2.4 | 2.9 | 7.5 | 14.0 | 6.5 |
| | HT/VHT20, M8 to M15 | 3 | 6 | 2.8 | 2.4 | 2.9 | 7.5 | 17.0 | 9.5 |
| | HT/VHT20 Beam Forming, M0 to M7 | 2 | 7 | 2.0 | 1.8 | | 4.9 | 16.0 | 11.1 |
| | HT/VHT20 Beam Forming, M8 to M15 | 2 | 4 | 5.1 | 4.7 | | 7.9 | 17.0 | 9.1 |
| | HT/VHT20 Beam Forming, M0 to M7 | 3 | 9 | -1.7 | -2.1 | -1.5 | 3.0 | 14.0 | 11.0 |
| | HT/VHT20 Beam Forming, M8 to M15 | 3 | 6 | 1.2 | 0.6 | 1.1 | 5.7 | 17.0 | 11.3 |
| | HT/VHT20 STBC, M0 to M7 | 2 | 4 | 5.1 | 4.7 | | 7.9 | 17.0 | 9.1 |
| | HT/VHT20 STBC, M0 to M7 | 3 | 6 | 2.8 | 2.4 | 2.9 | 7.5 | 17.0 | 9.5 |

Power Spectral Density, 5180 MHz, HT/VHT20, M0 to M7



Antenna A



Antenna B

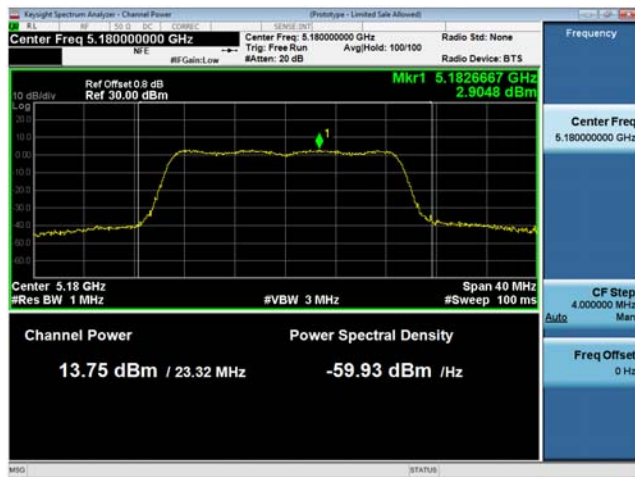

Antenna C

Antenna Gain: 10 dBi

| Frequency (MHz) | Mode | Tx Paths | Correlated Antenna Gain (dBi) | Tx 1 PSD (dBm/MHz) | Tx 2 PSD (dBm/MHz) | Tx 3 PSD (dBm/MHz) | Total PSD (dBm/MHz) | Limit (dBm/MHz) | Margin (dB) |
|-------------------------|-------------------------------------|----------|-------------------------------|--------------------|--------------------|--------------------|---------------------|-----------------|-------------|
| 5180 | Non HT20, 6 to 54 Mbps | 1 | 10 | 2.3 | | | 2.3 | 13.0 | 10.7 |
| | Non HT20, 6 to 54 Mbps | 2 | 10 | 2.3 | 2.1 | | 5.2 | 13.0 | 7.8 |
| | Non HT20, 6 to 54 Mbps | 3 | 10 | 0.5 | 0.3 | -0.1 | 5.0 | 13.0 | 8.0 |
| | Non HT20 Beam Forming, 6 to 54 Mbps | 2 | 10 | -0.5 | -0.7 | | 2.4 | 13.0 | 10.6 |
| | Non HT20 Beam Forming, 6 to 54 Mbps | 3 | 13 | -4.7 | -4.6 | -5.1 | 0.0 | 10.0 | 10.0 |
| | HT/VHT20, M0 to M7 | 1 | 10 | 2.8 | | | 2.8 | 13.0 | 10.2 |
| | HT/VHT20, M0 to M7 | 2 | 10 | 2.8 | 1.9 | | 5.4 | 13.0 | 7.6 |
| | HT/VHT20, M8 to M15 | 2 | 10 | 2.8 | 1.9 | | 5.4 | 13.0 | 7.6 |
| | HT/VHT20, M0 to M7 | 3 | 10 | 0.4 | -0.2 | -0.3 | 4.7 | 13.0 | 8.3 |
| | HT/VHT20, M8 to M15 | 3 | 10 | 0.4 | -0.2 | -0.3 | 4.7 | 13.0 | 8.3 |
| | HT/VHT20 Beam Forming, M0 to M7 | 2 | 10 | -0.7 | -1.0 | | 2.2 | 13.0 | 10.8 |
| | HT/VHT20 Beam Forming, M8 to M15 | 2 | 10 | 2.8 | 1.9 | | 5.4 | 13.0 | 7.6 |
| | HT/VHT20 Beam Forming, M0 to M7 | 3 | 13 | -4.6 | -4.8 | -5.1 | -0.1 | 10.0 | 10.1 |
| | HT/VHT20 Beam Forming, M8 to M15 | 3 | 10 | -1.6 | -1.9 | -2.0 | 2.9 | 13.0 | 10.1 |
| | HT/VHT20 STBC, M0 to M7 | 2 | 10 | 2.8 | 1.9 | | 5.4 | 13.0 | 7.6 |
| HT/VHT20 STBC, M0 to M7 | 3 | 10 | 0.4 | -0.2 | -0.3 | 4.7 | 13.0 | 8.3 | |
| 5190 | Non HT40, 6 to 54 Mbps | 1 | 10 | -3.6 | | | -3.6 | 13.0 | 16.6 |
| | Non HT40, 6 to 54 Mbps | 2 | 10 | -4.9 | -5.4 | | -2.1 | 13.0 | 15.1 |
| | Non HT40, 6 to 54 Mbps | 3 | 10 | -4.9 | -5.4 | -5.5 | -0.5 | 13.0 | 13.5 |
| | HT/VHT40, M0 to M7 | 1 | 10 | -2.6 | | | -2.6 | 13.0 | 15.6 |
| | HT/VHT40, M0 to M7 | 2 | 10 | -3.1 | -3.7 | | -0.4 | 13.0 | 13.4 |
| | HT/VHT40, M8 to M15 | 2 | 10 | -3.1 | -3.7 | | -0.4 | 13.0 | 13.4 |
| | HT/VHT40, M0 to M7 | 3 | 10 | -4.4 | -4.6 | -5.1 | 0.1 | 13.0 | 12.9 |
| | HT/VHT40, M8 to M15 | 3 | 10 | -4.4 | -4.6 | -5.1 | 0.1 | 13.0 | 12.9 |
| | HT/VHT40 Beam Forming, M0 to M7 | 2 | 10 | -4.4 | -4.6 | | -1.5 | 13.0 | 14.5 |
| | HT/VHT40 Beam Forming, M8 to M15 | 2 | 10 | -3.1 | -3.7 | | -0.4 | 13.0 | 13.4 |
| | HT/VHT40 Beam Forming, M0 to M7 | 3 | 13 | -7.1 | -7.8 | -7.8 | -2.8 | 10.0 | 12.8 |
| | HT/VHT40 Beam Forming, M8 to M15 | 3 | 10 | -4.4 | -4.6 | -5.1 | 0.1 | 13.0 | 12.9 |
| | HT/VHT40 STBC, M0 to M7 | 2 | 10 | -3.1 | -3.7 | | -0.4 | 13.0 | 13.4 |
| | HT/VHT40 STBC, M0 to M7 | 3 | 10 | -4.4 | -4.6 | -5.1 | 0.1 | 13.0 | 12.9 |

| | | | | | | | | | |
|------|-------------------------------------|---|----|-------|-------|-------|------|------|------|
| 5210 | Non HT80, 6 to 54 Mbps | 1 | 10 | -7.7 | | | -7.7 | 13.0 | 20.7 |
| | Non HT80, 6 to 54 Mbps | 2 | 10 | -9.0 | -9.1 | | -6.0 | 13.0 | 19.0 |
| | Non HT80, 6 to 54 Mbps | 3 | 10 | -10.0 | -10.0 | -9.9 | -5.2 | 13.0 | 18.2 |
| | VHT80, M0 to M9 1ss | 1 | 10 | -6.6 | | | -6.6 | 13.0 | 19.6 |
| | VHT80, M0 to M9 1ss | 2 | 10 | -7.9 | -8.4 | | -5.1 | 13.0 | 18.1 |
| | VHT80, M0 to M9 2ss | 2 | 10 | -7.9 | -8.4 | | -5.1 | 13.0 | 18.1 |
| | VHT80, M0 to M9 1ss | 3 | 10 | -8.9 | -9.4 | -9.0 | -4.3 | 13.0 | 17.3 |
| | VHT80, M0 to M9 2ss | 3 | 10 | -8.9 | -9.4 | -9.0 | -4.3 | 13.0 | 17.3 |
| | VHT80 Beam Forming, M0 to M9 1ss | 2 | 10 | -7.9 | -8.4 | | -5.1 | 13.0 | 18.1 |
| | VHT80 Beam Forming, M0 to M9 2ss | 2 | 10 | -7.9 | -8.4 | | -5.1 | 13.0 | 18.1 |
| | VHT80 Beam Forming, M0 to M9 1ss | 3 | 13 | -11.9 | -12.1 | -11.9 | -7.2 | 10.0 | 17.2 |
| | VHT80 Beam Forming, M0 to M9 2ss | 3 | 10 | -8.9 | -9.4 | -9.0 | -4.3 | 13.0 | 17.3 |
| | VHT80 STBC, M0 to M9 1ss | 2 | 10 | -7.9 | -8.4 | | -5.1 | 13.0 | 18.1 |
| | VHT80 STBC, M0 to M9 1ss | 3 | 10 | -8.9 | -9.4 | -9.0 | -4.3 | 13.0 | 17.3 |
| 5220 | Non HT20, 6 to 54 Mbps | 1 | 10 | 4.5 | | | 4.5 | 13.0 | 8.5 |
| | Non HT20, 6 to 54 Mbps | 2 | 10 | 1.7 | 1.6 | | 4.7 | 13.0 | 8.3 |
| | Non HT20, 6 to 54 Mbps | 3 | 10 | -0.3 | -0.5 | 0.0 | 4.5 | 13.0 | 8.5 |
| | Non HT20 Beam Forming, 6 to 54 Mbps | 2 | 10 | -1.0 | -0.9 | | 2.1 | 13.0 | 10.9 |
| | Non HT20 Beam Forming, 6 to 54 Mbps | 3 | 13 | -5.1 | -5.3 | -5.2 | -0.4 | 10.0 | 10.4 |
| | HT/VHT20, M0 to M7 | 1 | 10 | 4.6 | | | 4.6 | 13.0 | 8.4 |
| | HT/VHT20, M0 to M7 | 2 | 10 | 1.5 | 1.5 | | 4.5 | 13.0 | 8.5 |
| | HT/VHT20, M8 to M15 | 2 | 10 | 1.5 | 1.5 | | 4.5 | 13.0 | 8.5 |
| | HT/VHT20, M0 to M7 | 3 | 10 | -0.3 | -0.3 | -0.2 | 4.5 | 13.0 | 8.5 |
| | HT/VHT20, M8 to M15 | 3 | 10 | -0.3 | -0.3 | -0.2 | 4.5 | 13.0 | 8.5 |
| | HT/VHT20 Beam Forming, M0 to M7 | 2 | 10 | -1.2 | -1.4 | | 1.7 | 13.0 | 11.3 |
| | HT/VHT20 Beam Forming, M8 to M15 | 2 | 10 | 1.5 | 1.5 | | 4.5 | 13.0 | 8.5 |
| | HT/VHT20 Beam Forming, M0 to M7 | 3 | 13 | -5.3 | -5.4 | -4.6 | -0.3 | 10.0 | 10.3 |
| | HT/VHT20 Beam Forming, M8 to M15 | 3 | 10 | -2.1 | -2.4 | -2.2 | 2.5 | 13.0 | 10.5 |
| | HT/VHT20 STBC, M0 to M7 | 2 | 10 | 1.5 | 1.5 | | 4.5 | 13.0 | 8.5 |
| | HT/VHT20 STBC, M0 to M7 | 3 | 10 | -0.3 | -0.3 | -0.2 | 4.5 | 13.0 | 8.5 |
| 5230 | Non HT40, 6 to 54 Mbps | 1 | 10 | 2.1 | | | 2.1 | 13.0 | 10.9 |
| | Non HT40, 6 to 54 Mbps | 2 | 10 | -0.8 | -1.0 | | 2.1 | 13.0 | 10.9 |
| | Non HT40, 6 to 54 Mbps | 3 | 10 | -2.5 | -2.9 | -2.6 | 2.1 | 13.0 | 10.9 |
| | HT/VHT40, M0 to M7 | 1 | 10 | 1.9 | | | 1.9 | 13.0 | 11.1 |
| | HT/VHT40, M0 to M7 | 2 | 10 | -1.4 | -1.6 | | 1.5 | 13.0 | 11.5 |
| | HT/VHT40, M8 to M15 | 2 | 10 | -1.4 | -1.6 | | 1.5 | 13.0 | 11.5 |
| | HT/VHT40, M0 to M7 | 3 | 10 | -3.0 | -3.4 | -3.2 | 1.6 | 13.0 | 11.4 |
| | HT/VHT40, M8 to M15 | 3 | 10 | -3.0 | -3.4 | -3.2 | 1.6 | 13.0 | 11.4 |
| | HT/VHT40 Beam Forming, M0 to M7 | 2 | 10 | -4.0 | -4.1 | | -1.0 | 13.0 | 14.0 |
| | HT/VHT40 Beam Forming, M8 to M15 | 2 | 10 | -1.4 | -1.6 | | 1.5 | 13.0 | 11.5 |
| | HT/VHT40 Beam Forming, M0 to M7 | 3 | 13 | -7.7 | -8.5 | -7.9 | -3.2 | 10.0 | 13.2 |

| | | | | | | | | | |
|------|-------------------------------------|---|----|------|------|------|------|------|------|
| | HT/VHT40 Beam Forming, M8 to M15 | 3 | 10 | -5.0 | -5.1 | -5.0 | -0.3 | 13.0 | 13.3 |
| | HT/VHT40 STBC, M0 to M7 | 2 | 10 | -1.4 | -1.6 | | 1.5 | 13.0 | 11.5 |
| | HT/VHT40 STBC, M0 to M7 | 3 | 10 | -3.0 | -3.4 | -3.2 | 1.6 | 13.0 | 11.4 |
| | | | | | | | | | |
| 5240 | Non HT20, 6 to 54 Mbps | 1 | 10 | 5.3 | | | 5.3 | 13.0 | 7.7 |
| | Non HT20, 6 to 54 Mbps | 2 | 10 | 2.2 | 1.5 | | 4.9 | 13.0 | 8.1 |
| | Non HT20, 6 to 54 Mbps | 3 | 10 | 0.2 | 0.0 | 0.3 | 4.9 | 13.0 | 8.1 |
| | Non HT20 Beam Forming, 6 to 54 Mbps | 2 | 10 | -0.8 | -1.2 | | 2.0 | 13.0 | 11.0 |
| | Non HT20 Beam Forming, 6 to 54 Mbps | 3 | 13 | -4.9 | -5.1 | -4.8 | -0.2 | 10.0 | 10.2 |
| | HT/VHT20, M0 to M7 | 1 | 10 | 5.1 | | | 5.1 | 13.0 | 7.9 |
| | HT/VHT20, M0 to M7 | 2 | 10 | 2.0 | 1.8 | | 4.9 | 13.0 | 8.1 |
| | HT/VHT20, M8 to M15 | 2 | 10 | 2.0 | 1.8 | | 4.9 | 13.0 | 8.1 |
| | HT/VHT20, M0 to M7 | 3 | 10 | 0.3 | -0.5 | 0.2 | 4.8 | 13.0 | 8.2 |
| | HT/VHT20, M8 to M15 | 3 | 10 | 0.3 | -0.5 | 0.2 | 4.8 | 13.0 | 8.2 |
| | HT/VHT20 Beam Forming, M0 to M7 | 2 | 10 | -1.0 | -1.0 | | 2.0 | 13.0 | 11.0 |
| | HT/VHT20 Beam Forming, M8 to M15 | 2 | 10 | 2.0 | 1.8 | | 4.9 | 13.0 | 8.1 |
| | HT/VHT20 Beam Forming, M0 to M7 | 3 | 13 | -4.7 | -5.5 | -4.9 | -0.2 | 10.0 | 10.2 |
| | HT/VHT20 Beam Forming, M8 to M15 | 3 | 10 | -1.7 | -2.1 | -1.5 | 3.0 | 13.0 | 10.0 |
| | HT/VHT20 STBC, M0 to M7 | 2 | 10 | 2.0 | 1.8 | | 4.9 | 13.0 | 8.1 |
| | HT/VHT20 STBC, M0 to M7 | 3 | 10 | 0.3 | -0.5 | 0.2 | 4.8 | 13.0 | 8.2 |

Power Spectral Density, 5180 MHz, HT/VHT20, M0 to M7



Antenna A



Antenna B

15.407 (i) The maximum e.i.r.p. at any elevation angle above 30 degrees as measured from the horizon must not exceed 125 mW (21 dBm).

Antenna Gain: 4 (2) dBi

| Frequency (MHz) | Mode | Tx Paths | Correlated Antenna Gain (dBi) | Tx 1 Max Power (dBm) | Tx 2 Max Power (dBm) | Tx 3 Max Power (dBm) | Total Radiated Channel Power (dBm) | Limit (dBm) | Margin (dB) |
|-----------------|--|----------|-------------------------------|----------------------|----------------------|----------------------|------------------------------------|-------------|-------------|
| 5180 | Non HT20, 6 to 54 Mbps | 1 | 2 | 15.7 | | | 17.7 | 21.0 | 3.3 |
| | Non HT20, 6 to 54 Mbps | 2 | 2 | 14.7 | 14.7 | | 19.7 | 21.0 | 1.3 |
| | Non HT20, 6 to 54 Mbps | 3 | 2 | 13.8 | 13.8 | 13.5 | 20.5 | 21.0 | 0.5 |
| | Non HT20 Beam Forming, 6 to 54 Mbps | 2 | 5 | 12.8 | 12.4 | | 20.6 | 21.0 | 0.4 |
| | Non HT20 Beam Forming, 6 to 54 Mbps | 3 | 7 | 8.8 | 8.9 | 8.6 | 20.5 | 21.0 | 0.5 |
| | HT/VHT20, M0 to M7 | 1 | 2 | 15.9 | | | 17.9 | 21.0 | 3.1 |
| | HT/VHT20, M0 to M7 | 2 | 2 | 14.8 | 14.9 | | 19.9 | 21.0 | 1.1 |
| | HT/VHT20, M8 to M15 | 2 | 2 | 14.8 | 14.9 | | 19.9 | 21.0 | 1.1 |
| | HT/VHT20, M0 to M7 | 3 | 2 | 14.0 | 14.0 | 13.7 | 20.7 | 21.0 | 0.3 |
| | HT/VHT20, M8 to M15 | 3 | 2 | 14.0 | 14.0 | 13.7 | 20.7 | 21.0 | 0.3 |
| | HT/VHT20 Beam Forming, M0 to M7 | 2 | 5 | 13.1 | 12.6 | | 20.9 | 21.0 | 0.1 |
| | HT/VHT20 Beam Forming, M8 to M15 | 2 | 2 | 14.8 | 14.9 | | 19.9 | 21.0 | 1.1 |
| | HT/VHT20 Beam Forming, M0 to M7 | 3 | 7 | 8.9 | 8.9 | 8.8 | 20.6 | 21.0 | 0.4 |
| | HT/VHT20 Beam Forming, M8 to M15 | 3 | 4 | 12.0 | 11.7 | 11.4 | 20.5 | 21.0 | 0.5 |
| | HT/VHT20 STBC, M0 to M7 | 2 | 2 | 14.8 | 14.9 | | 19.9 | 21.0 | 1.1 |
| | HT/VHT20 STBC, M0 to M7 | 3 | 2 | 14.0 | 14.0 | 13.7 | 20.7 | 21.0 | 0.3 |
| 5190 | Non HT40, 6 to 54 Mbps | 1 | 2 | 11.2 | | | 13.2 | 21.0 | 7.8 |
| | Non HT40, 6 to 54 Mbps | 2 | 2 | 10.2 | 10.2 | | 15.2 | 21.0 | 5.8 |
| | Non HT40, 6 to 54 Mbps | 3 | 2 | 10.2 | 10.2 | 9.7 | 16.8 | 21.0 | 4.2 |
| | HT/VHT40, M0 to M7 | 1 | 2 | 12.9 | | | 14.9 | 21.0 | 6.1 |
| | HT/VHT40, M0 to M7 | 2 | 2 | 12.0 | 11.8 | | 16.9 | 21.0 | 4.1 |
| | HT/VHT40, M8 to M15 | 2 | 2 | 12.0 | 11.8 | | 16.9 | 21.0 | 4.1 |
| | HT/VHT40, M0 to M7 | 3 | 2 | 11.1 | 10.9 | 10.5 | 17.6 | 21.0 | 3.4 |
| | HT/VHT40, M8 to M15 | 3 | 2 | 11.1 | 10.9 | 10.5 | 17.6 | 21.0 | 3.4 |
| | HT/VHT40 Beam Forming, M0 to M7 | 2 | 5 | 11.1 | 10.9 | | 19.0 | 21.0 | 2.0 |
| | HT/VHT40 Beam Forming, M8 to M15 | 2 | 2 | 12.0 | 11.8 | | 16.9 | 21.0 | 4.1 |
| | HT/VHT40 Beam Forming, M0 to M7 | 3 | 7 | 9.2 | 9.1 | 8.6 | 20.7 | 21.0 | 0.3 |
| | HT/VHT40 Beam Forming, M8 to M15 | 3 | 4 | 11.1 | 10.9 | 10.5 | 19.6 | 21.0 | 1.4 |
| | HT/VHT40 STBC, M0 to M7 | 2 | 2 | 12.0 | 11.8 | | 16.9 | 21.0 | 4.1 |
| | HT/VHT40 STBC, M0 to M7 | 3 | 2 | 11.1 | 10.9 | 10.5 | 17.6 | 21.0 | 3.4 |

| | | | | | | | | | |
|-------------------------|-------------------------------------|---|------|------|------|------|------|------|-----|
| 5210 | Non HT80, 6 to 54 Mbps | 1 | 2 | 10.9 | | | 12.9 | 21.0 | 8.1 |
| | Non HT80, 6 to 54 Mbps | 2 | 2 | 10.9 | 10.5 | | 15.7 | 21.0 | 5.3 |
| | Non HT80, 6 to 54 Mbps | 3 | 2 | 10.0 | 9.6 | 9.5 | 16.5 | 21.0 | 4.5 |
| | VHT80, M0 to M9 1ss | 1 | 2 | 12.2 | | | 14.2 | 21.0 | 6.8 |
| | VHT80, M0 to M9 1ss | 2 | 2 | 11.3 | 10.9 | | 16.1 | 21.0 | 4.9 |
| | VHT80, M0 to M9 2ss | 2 | 2 | 11.3 | 10.9 | | 16.1 | 21.0 | 4.9 |
| | VHT80, M0 to M9 1ss | 3 | 2 | 11.3 | 10.9 | 10.9 | 17.8 | 21.0 | 3.2 |
| | VHT80, M0 to M9 2ss | 3 | 2 | 11.3 | 10.9 | 10.9 | 17.8 | 21.0 | 3.2 |
| | VHT80 Beam Forming, M0 to M9 1ss | 2 | 5 | 10.5 | 10.0 | | 18.3 | 21.0 | 2.7 |
| | VHT80 Beam Forming, M0 to M9 2ss | 2 | 2 | 11.3 | 10.9 | | 16.1 | 21.0 | 4.9 |
| | VHT80 Beam Forming, M0 to M9 1ss | 3 | 7 | 8.6 | 8.2 | 8.1 | 20.1 | 21.0 | 0.9 |
| | VHT80 Beam Forming, M0 to M9 2ss | 3 | 4 | 10.5 | 10.0 | 10.0 | 18.9 | 21.0 | 2.1 |
| | VHT80 STBC, M0 to M9 1ss | 2 | 2 | 11.3 | 10.9 | | 16.1 | 21.0 | 4.9 |
| | VHT80 STBC, M0 to M9 1ss | 3 | 2 | 11.3 | 10.9 | 10.9 | 17.8 | 21.0 | 3.2 |
| 5220 | Non HT20, 6 to 54 Mbps | 1 | 2 | 18.0 | | | 20.0 | 21.0 | 1.0 |
| | Non HT20, 6 to 54 Mbps | 2 | 2 | 15.3 | 15.3 | | 20.3 | 21.0 | 0.7 |
| | Non HT20, 6 to 54 Mbps | 3 | 2 | 13.2 | 13.0 | 13.2 | 19.9 | 21.0 | 1.1 |
| | Non HT20 Beam Forming, 6 to 54 Mbps | 2 | 5 | 12.3 | 12.1 | | 20.2 | 21.0 | 0.8 |
| | Non HT20 Beam Forming, 6 to 54 Mbps | 3 | 7 | 8.4 | 8.4 | 8.6 | 20.2 | 21.0 | 0.8 |
| | HT/VHT20, M0 to M7 | 1 | 2 | 18.2 | | | 20.2 | 21.0 | 0.8 |
| | HT/VHT20, M0 to M7 | 2 | 2 | 15.4 | 15.5 | | 20.5 | 21.0 | 0.5 |
| | HT/VHT20, M8 to M15 | 2 | 2 | 15.4 | 15.5 | | 20.5 | 21.0 | 0.5 |
| | HT/VHT20, M0 to M7 | 3 | 2 | 13.3 | 13.2 | 13.4 | 20.1 | 21.0 | 0.9 |
| | HT/VHT20, M8 to M15 | 3 | 2 | 13.3 | 13.2 | 13.4 | 20.1 | 21.0 | 0.9 |
| | HT/VHT20 Beam Forming, M0 to M7 | 2 | 5 | 12.4 | 12.2 | | 20.3 | 21.0 | 0.7 |
| | HT/VHT20 Beam Forming, M8 to M15 | 2 | 2 | 15.4 | 15.5 | | 20.5 | 21.0 | 0.5 |
| | HT/VHT20 Beam Forming, M0 to M7 | 3 | 7 | 8.6 | 8.5 | 8.7 | 20.4 | 21.0 | 0.6 |
| | HT/VHT20 Beam Forming, M8 to M15 | 3 | 4 | 11.5 | 11.4 | 11.5 | 20.2 | 21.0 | 0.8 |
| | HT/VHT20 STBC, M0 to M7 | 2 | 2 | 15.4 | 15.5 | | 20.5 | 21.0 | 0.5 |
| HT/VHT20 STBC, M0 to M7 | 3 | 2 | 13.3 | 13.2 | 13.4 | 20.1 | 21.0 | 0.9 | |
| 5230 | Non HT40, 6 to 54 Mbps | 1 | 2 | 18.6 | | | 20.6 | 21.0 | 0.4 |
| | Non HT40, 6 to 54 Mbps | 2 | 2 | 15.6 | 15.6 | | 20.6 | 21.0 | 0.4 |
| | Non HT40, 6 to 54 Mbps | 3 | 2 | 13.8 | 13.6 | 13.5 | 20.4 | 21.0 | 0.6 |
| | HT/VHT40, M0 to M7 | 1 | 2 | 18.5 | | | 20.5 | 21.0 | 0.5 |
| | HT/VHT40, M0 to M7 | 2 | 2 | 15.7 | 15.3 | | 20.5 | 21.0 | 0.5 |
| | HT/VHT40, M8 to M15 | 2 | 2 | 15.7 | 15.3 | | 20.5 | 21.0 | 0.5 |
| | HT/VHT40, M0 to M7 | 3 | 2 | 13.5 | 13.1 | 13.4 | 20.1 | 21.0 | 0.9 |
| | HT/VHT40, M8 to M15 | 3 | 2 | 13.5 | 13.1 | 13.4 | 20.1 | 21.0 | 0.9 |

| | | | | | | | | | |
|-------------------------|-------------------------------------|---|------|------|------|------|------|------|-----|
| | HT/VHT40 Beam Forming, M0 to M7 | 2 | 5 | 12.6 | 12.2 | | 20.4 | 21.0 | 0.6 |
| | HT/VHT40 Beam Forming, M8 to M15 | 2 | 2 | 15.7 | 15.3 | | 20.5 | 21.0 | 0.5 |
| | HT/VHT40 Beam Forming, M0 to M7 | 3 | 7 | 8.9 | 8.5 | 8.8 | 20.5 | 21.0 | 0.5 |
| | HT/VHT40 Beam Forming, M8 to M15 | 3 | 4 | 11.7 | 11.2 | 11.5 | 20.2 | 21.0 | 0.8 |
| | HT/VHT40 STBC, M0 to M7 | 2 | 2 | 15.7 | 15.3 | | 20.5 | 21.0 | 0.5 |
| | HT/VHT40 STBC, M0 to M7 | 3 | 2 | 13.5 | 13.1 | 13.4 | 20.1 | 21.0 | 0.9 |
| | | | | | | | | | |
| 5240 | Non HT20, 6 to 54 Mbps | 1 | 2 | 18.6 | | | 20.6 | 21.0 | 0.4 |
| | Non HT20, 6 to 54 Mbps | 2 | 2 | 15.7 | 15.2 | | 20.5 | 21.0 | 0.5 |
| | Non HT20, 6 to 54 Mbps | 3 | 2 | 13.5 | 13.0 | 13.6 | 20.1 | 21.0 | 0.9 |
| | Non HT20 Beam Forming, 6 to 54 Mbps | 2 | 5 | 12.6 | 12.0 | | 20.3 | 21.0 | 0.7 |
| | Non HT20 Beam Forming, 6 to 54 Mbps | 3 | 7 | 9.0 | 8.4 | 8.9 | 20.5 | 21.0 | 0.5 |
| | HT/VHT20, M0 to M7 | 1 | 2 | 18.6 | | | 20.6 | 21.0 | 0.4 |
| | HT/VHT20, M0 to M7 | 2 | 2 | 15.8 | 15.4 | | 20.6 | 21.0 | 0.4 |
| | HT/VHT20, M8 to M15 | 2 | 2 | 15.8 | 15.4 | | 20.6 | 21.0 | 0.4 |
| | HT/VHT20, M0 to M7 | 3 | 2 | 13.6 | 13.1 | 13.8 | 20.3 | 21.0 | 0.7 |
| | HT/VHT20, M8 to M15 | 3 | 2 | 13.6 | 13.1 | 13.8 | 20.3 | 21.0 | 0.7 |
| | HT/VHT20 Beam Forming, M0 to M7 | 2 | 5 | 12.7 | 12.2 | | 20.5 | 21.0 | 0.5 |
| | HT/VHT20 Beam Forming, M8 to M15 | 2 | 2 | 15.8 | 15.4 | | 20.6 | 21.0 | 0.4 |
| | HT/VHT20 Beam Forming, M0 to M7 | 3 | 7 | 9.1 | 8.5 | 9.0 | 20.6 | 21.0 | 0.4 |
| | HT/VHT20 Beam Forming, M8 to M15 | 3 | 4 | 11.8 | 11.2 | 11.8 | 20.4 | 21.0 | 0.6 |
| | HT/VHT20 STBC, M0 to M7 | 2 | 2 | 15.8 | 15.4 | | 20.6 | 21.0 | 0.4 |
| HT/VHT20 STBC, M0 to M7 | 3 | 2 | 13.6 | 13.1 | 13.8 | 20.3 | 21.0 | 0.7 | |

Antenna Gain: 10 (5) dBi

| Frequency (MHz) | Mode | Tx Paths | Correlated Antenna Gain (dBi) | Tx 1 Max Power (dBm) | Tx 2 Max Power (dBm) | Tx 3 Max Power (dBm) | Total Radiated Channel Power (dBm) | Limit (dBm) | Margin (dB) |
|-------------------------|--|----------|-------------------------------|----------------------|----------------------|----------------------|------------------------------------|-------------|-------------|
| 5180 | Non HT20, 6 to 54 Mbps | 1 | 5 | 12.8 | | | 17.8 | 21.0 | 3.2 |
| | Non HT20, 6 to 54 Mbps | 2 | 5 | 12.8 | 12.4 | | 20.6 | 21.0 | 0.4 |
| | Non HT20, 6 to 54 Mbps | 3 | 5 | 10.8 | 10.7 | 10.4 | 20.4 | 21.0 | 0.6 |
| | Non HT20 Beam Forming, 6 to 54 Mbps | 2 | 8 | 9.8 | 9.8 | | 20.8 | 21.0 | 0.2 |
| | Non HT20 Beam Forming, 6 to 54 Mbps | 3 | 10 | 5.6 | 6.0 | 5.6 | 20.5 | 21.0 | 0.5 |
| | HT/VHT20, M0 to M7 | 1 | 5 | 13.1 | | | 18.1 | 21.0 | 2.9 |
| | HT/VHT20, M0 to M7 | 2 | 5 | 13.1 | 12.6 | | 20.9 | 21.0 | 0.1 |
| | HT/VHT20, M8 to M15 | 2 | 5 | 13.1 | 12.6 | | 20.9 | 21.0 | 0.1 |
| | HT/VHT20, M0 to M7 | 3 | 5 | 11.0 | 10.8 | 10.5 | 20.5 | 21.0 | 0.5 |
| | HT/VHT20, M8 to M15 | 3 | 5 | 11.0 | 10.8 | 10.5 | 20.5 | 21.0 | 0.5 |
| | HT/VHT20 Beam Forming, M0 to M7 | 2 | 8 | 10.0 | 9.9 | | 21.0 | 21.0 | 0.0 |
| | HT/VHT20 Beam Forming, M8 to M15 | 2 | 5 | 13.1 | 12.6 | | 20.9 | 21.0 | 0.1 |
| | HT/VHT20 Beam Forming, M0 to M7 | 3 | 10 | 5.9 | 6.2 | 5.8 | 20.7 | 21.0 | 0.3 |
| | HT/VHT20 Beam Forming, M8 to M15 | 3 | 7 | 8.9 | 8.9 | 8.8 | 20.6 | 21.0 | 0.4 |
| | HT/VHT20 STBC, M0 to M7 | 2 | 5 | 13.1 | 12.6 | | 20.9 | 21.0 | 0.1 |
| HT/VHT20 STBC, M0 to M7 | 3 | 5 | 11.0 | 10.8 | 10.5 | 20.5 | 21.0 | 0.5 | |
| 5190 | Non HT40, 6 to 54 Mbps | 1 | 5 | 9.4 | | | 14.4 | 21.0 | 6.6 |
| | Non HT40, 6 to 54 Mbps | 2 | 5 | 8.4 | 8.1 | | 16.3 | 21.0 | 4.7 |
| | Non HT40, 6 to 54 Mbps | 3 | 5 | 8.4 | 8.1 | 7.9 | 17.9 | 21.0 | 3.1 |
| | HT/VHT40, M0 to M7 | 1 | 5 | 11.1 | | | 16.1 | 21.0 | 4.9 |
| | HT/VHT40, M0 to M7 | 2 | 5 | 10.1 | 10.0 | | 18.1 | 21.0 | 2.9 |
| | HT/VHT40, M8 to M15 | 2 | 5 | 10.1 | 10.0 | | 18.1 | 21.0 | 2.9 |
| | HT/VHT40, M0 to M7 | 3 | 5 | 9.2 | 9.1 | 8.6 | 18.7 | 21.0 | 2.3 |
| | HT/VHT40, M8 to M15 | 3 | 5 | 9.2 | 9.1 | 8.6 | 18.7 | 21.0 | 2.3 |
| | HT/VHT40 Beam Forming, M0 to M7 | 2 | 8 | 9.2 | 9.1 | | 20.2 | 21.0 | 0.8 |
| | HT/VHT40 Beam Forming, M8 to M15 | 2 | 5 | 10.1 | 10.0 | | 18.1 | 21.0 | 2.9 |
| | HT/VHT40 Beam Forming, M0 to M7 | 3 | 10 | 6.2 | 6.1 | 5.7 | 20.8 | 21.0 | 0.2 |
| | HT/VHT40 Beam Forming, M8 to M15 | 3 | 7 | 9.2 | 9.1 | 8.6 | 20.7 | 21.0 | 0.3 |
| | HT/VHT40 STBC, M0 to M7 | 2 | 5 | 10.1 | 10.0 | | 18.1 | 21.0 | 2.9 |
| | HT/VHT40 STBC, M0 to M7 | 3 | 5 | 9.2 | 9.1 | 8.6 | 18.7 | 21.0 | 2.3 |

| | | | | | | | | | |
|------|-------------------------------------|---|----|------|------|------|------|------|-----|
| 5210 | Non HT80, 6 to 54 Mbps | 1 | 5 | 9.1 | | | 14.1 | 21.0 | 6.9 |
| | Non HT80, 6 to 54 Mbps | 2 | 5 | 8.0 | 7.8 | | 15.9 | 21.0 | 5.1 |
| | Non HT80, 6 to 54 Mbps | 3 | 5 | 7.0 | 6.6 | 6.5 | 16.5 | 21.0 | 4.5 |
| | VHT80, M0 to M9 1ss | 1 | 5 | 10.5 | | | 15.5 | 21.0 | 5.5 |
| | VHT80, M0 to M9 1ss | 2 | 5 | 9.6 | 9.1 | | 17.4 | 21.0 | 3.6 |
| | VHT80, M0 to M9 2ss | 2 | 5 | 9.6 | 9.1 | | 17.4 | 21.0 | 3.6 |
| | VHT80, M0 to M9 1ss | 3 | 5 | 8.6 | 8.2 | 8.1 | 18.1 | 21.0 | 2.9 |
| | VHT80, M0 to M9 2ss | 3 | 5 | 8.6 | 8.2 | 8.1 | 18.1 | 21.0 | 2.9 |
| | VHT80 Beam Forming, M0 to M9 1ss | 2 | 8 | 9.6 | 9.1 | | 20.4 | 21.0 | 0.6 |
| | VHT80 Beam Forming, M0 to M9 2ss | 2 | 5 | 9.6 | 9.1 | | 17.4 | 21.0 | 3.6 |
| | VHT80 Beam Forming, M0 to M9 1ss | 3 | 10 | 5.5 | 5.3 | 5.1 | 20.1 | 21.0 | 0.9 |
| | VHT80 Beam Forming, M0 to M9 2ss | 3 | 7 | 8.6 | 8.2 | 8.1 | 20.1 | 21.0 | 0.9 |
| | VHT80 STBC, M0 to M9 1ss | 2 | 5 | 9.6 | 9.1 | | 17.4 | 21.0 | 3.6 |
| | VHT80 STBC, M0 to M9 1ss | 3 | 5 | 8.6 | 8.2 | 8.1 | 18.1 | 21.0 | 2.9 |
| 5220 | Non HT20, 6 to 54 Mbps | 1 | 5 | 15.3 | | | 20.3 | 21.0 | 0.7 |
| | Non HT20, 6 to 54 Mbps | 2 | 5 | 12.3 | 12.1 | | 20.2 | 21.0 | 0.8 |
| | Non HT20, 6 to 54 Mbps | 3 | 5 | 10.4 | 10.2 | 10.4 | 20.1 | 21.0 | 0.9 |
| | Non HT20 Beam Forming, 6 to 54 Mbps | 2 | 8 | 9.5 | 9.3 | | 20.4 | 21.0 | 0.6 |
| | Non HT20 Beam Forming, 6 to 54 Mbps | 3 | 10 | 5.4 | 5.4 | 5.6 | 20.2 | 21.0 | 0.8 |
| | HT/VHT20, M0 to M7 | 1 | 5 | 15.4 | | | 20.4 | 21.0 | 0.6 |
| | HT/VHT20, M0 to M7 | 2 | 5 | 12.4 | 12.2 | | 20.3 | 21.0 | 0.7 |
| | HT/VHT20, M8 to M15 | 2 | 5 | 12.4 | 12.2 | | 20.3 | 21.0 | 0.7 |
| | HT/VHT20, M0 to M7 | 3 | 5 | 10.5 | 10.4 | 10.6 | 20.3 | 21.0 | 0.7 |
| | HT/VHT20, M8 to M15 | 3 | 5 | 10.5 | 10.4 | 10.6 | 20.3 | 21.0 | 0.7 |
| | HT/VHT20 Beam Forming, M0 to M7 | 2 | 8 | 9.7 | 9.5 | | 20.6 | 21.0 | 0.4 |
| | HT/VHT20 Beam Forming, M8 to M15 | 2 | 5 | 12.4 | 12.2 | | 20.3 | 21.0 | 0.7 |
| | HT/VHT20 Beam Forming, M0 to M7 | 3 | 10 | 5.6 | 5.5 | 5.7 | 20.4 | 21.0 | 0.6 |
| | HT/VHT20 Beam Forming, M8 to M15 | 3 | 7 | 8.6 | 8.5 | 8.7 | 20.4 | 21.0 | 0.6 |
| | HT/VHT20 STBC, M0 to M7 | 2 | 5 | 12.4 | 12.2 | | 20.3 | 21.0 | 0.7 |
| | HT/VHT20 STBC, M0 to M7 | 3 | 5 | 10.5 | 10.4 | 10.6 | 20.3 | 21.0 | 0.7 |
| 5230 | Non HT40, 6 to 54 Mbps | 1 | 5 | 15.6 | | | 20.6 | 21.0 | 0.4 |
| | Non HT40, 6 to 54 Mbps | 2 | 5 | 12.8 | 12.6 | | 20.7 | 21.0 | 0.3 |
| | Non HT40, 6 to 54 Mbps | 3 | 5 | 10.8 | 10.5 | 10.7 | 20.4 | 21.0 | 0.6 |
| | HT/VHT40, M0 to M7 | 1 | 5 | 15.7 | | | 20.7 | 21.0 | 0.3 |
| | HT/VHT40, M0 to M7 | 2 | 5 | 12.6 | 12.2 | | 20.4 | 21.0 | 0.6 |
| | HT/VHT40, M8 to M15 | 2 | 5 | 12.6 | 12.2 | | 20.4 | 21.0 | 0.6 |
| | HT/VHT40, M0 to M7 | 3 | 5 | 10.8 | 10.3 | 10.6 | 20.3 | 21.0 | 0.7 |
| | HT/VHT40, M8 to M15 | 3 | 5 | 10.8 | 10.3 | 10.6 | 20.3 | 21.0 | 0.7 |
| | HT/VHT40 Beam Forming, M0 to M7 | 2 | 8 | 9.8 | 9.4 | | 20.6 | 21.0 | 0.4 |
| | HT/VHT40 Beam Forming, M8 to M15 | 2 | 5 | 12.6 | 12.2 | | 20.4 | 21.0 | 0.6 |
| | HT/VHT40 Beam Forming, M0 to M7 | 3 | 10 | 5.9 | 5.3 | 5.7 | 20.4 | 21.0 | 0.6 |



| | | | | | | | | | |
|------|-------------------------------------|---|----|------|------|------|------|------|-----|
| | HT/VHT40 Beam Forming, M8 to M15 | 3 | 7 | 8.9 | 8.5 | 8.8 | 20.5 | 21.0 | 0.5 |
| | HT/VHT40 STBC, M0 to M7 | 2 | 5 | 12.6 | 12.2 | | 20.4 | 21.0 | 0.6 |
| | HT/VHT40 STBC, M0 to M7 | 3 | 5 | 10.8 | 10.3 | 10.6 | 20.3 | 21.0 | 0.7 |
| | | | | | | | | | |
| 5240 | Non HT20, 6 to 54 Mbps | 1 | 5 | 15.7 | | | 20.7 | 21.0 | 0.3 |
| | Non HT20, 6 to 54 Mbps | 2 | 5 | 12.6 | 12.0 | | 20.3 | 21.0 | 0.7 |
| | Non HT20, 6 to 54 Mbps | 3 | 5 | 10.8 | 10.2 | 10.7 | 20.3 | 21.0 | 0.7 |
| | Non HT20 Beam Forming, 6 to 54 Mbps | 2 | 8 | 9.8 | 9.3 | | 20.6 | 21.0 | 0.4 |
| | Non HT20 Beam Forming, 6 to 54 Mbps | 3 | 10 | 5.8 | 5.3 | 5.8 | 20.4 | 21.0 | 0.6 |
| | HT/VHT20, M0 to M7 | 1 | 5 | 15.8 | | | 20.8 | 21.0 | 0.2 |
| | HT/VHT20, M0 to M7 | 2 | 5 | 12.7 | 12.2 | | 20.5 | 21.0 | 0.5 |
| | HT/VHT20, M8 to M15 | 2 | 5 | 12.7 | 12.2 | | 20.5 | 21.0 | 0.5 |
| | HT/VHT20, M0 to M7 | 3 | 5 | 10.9 | 10.3 | 10.8 | 20.4 | 21.0 | 0.6 |
| | HT/VHT20, M8 to M15 | 3 | 5 | 10.9 | 10.3 | 10.8 | 20.4 | 21.0 | 0.6 |
| | HT/VHT20 Beam Forming, M0 to M7 | 2 | 8 | 9.9 | 9.4 | | 20.7 | 21.0 | 0.3 |
| | HT/VHT20 Beam Forming, M8 to M15 | 2 | 5 | 12.7 | 12.2 | | 20.5 | 21.0 | 0.5 |
| | HT/VHT20 Beam Forming, M0 to M7 | 3 | 10 | 5.9 | 5.4 | 5.9 | 20.5 | 21.0 | 0.5 |
| | HT/VHT20 Beam Forming, M8 to M15 | 3 | 7 | 9.1 | 8.5 | 9.0 | 20.6 | 21.0 | 0.4 |
| | HT/VHT20 STBC, M0 to M7 | 2 | 5 | 12.7 | 12.2 | | 20.5 | 21.0 | 0.5 |
| | HT/VHT20 STBC, M0 to M7 | 3 | 5 | 10.9 | 10.3 | 10.8 | 20.4 | 21.0 | 0.6 |

A.3 Conducted Spurious Emissions

15.407 (b) Undesirable emission limits. Except as shown in paragraph (b) (7) of this section, the maximum emissions outside of the frequency bands of operation shall be attenuated in accordance with the following limits:

(1) For transmitters operating in the 5.15-5.25 GHz band: All emissions outside of the 5.15-5.35 GHz band shall not exceed an e.i.r.p. of -27 dBm/MHz.

Radiated emissions which fall in the restricted bands, as defined in Section 15.205(a), must also comply with the radiated emission limits specified in Section 15.209(a) (see Section 15.205(c)).

Test Procedure

Ref. KDB 789033 D02 General UNII Test Procedures New Rules v01r03
ANSI C63.10: 2013

| Conducted Spurious Emissions |
|--|
| Test Procedure |
| <ol style="list-style-type: none"> 1. Connect the antenna port(s) to the spectrum analyzer input. 2. Place the radio in continuous transmit mode. Use the procedures in KDB 789033 D02 General UNII Test Procedures New Rules v01r03 to substitute conducted measurements in place of radiated measurements. 3. Configure Spectrum analyzer as per test parameters below (be sure to enter all losses between the transmitter output and the spectrum analyzer). 4. Record the marker waveform peak to spur difference. Also measure any emissions in the restricted bands. 5. The "measure-and-sum technique" is used for measuring in-band transmit power of a device. In the measure-and-sum approach, the conducted emission level is measured at each antenna port. The measured results at the various antenna ports are then summed mathematically to determine the total emission level from the device. Summing is performed in linear power units. The worst case output is recorded. 6. Capture graphs and record pertinent measurement data. |

Ref. KDB 789033 D02 General UNII Test Procedures New Rules v01r03
ANSI C63.10: 2013 section 12.7.7.3 (average) & 12.7.6 (peak)

| Conducted Spurious Emissions |
|--|
| Test parameters |
| Span = 30MHz to 18GHz / 18GHz to 40GHz RBW = 1 MHz VBW ≥ 3 x RBW for Peak, 1kHz for Average Sweep = Auto couple Detector = Peak Trace = Max Hold. |

| System Number | Description | Samples | System under test | Support equipment |
|---------------|-------------|---------|-------------------------------------|-------------------------------------|
| 1 | EUT | S01 | <input checked="" type="checkbox"/> | <input type="checkbox"/> |
| | Support | S02 | <input type="checkbox"/> | <input checked="" type="checkbox"/> |

| | |
|------------------------------------|--|
| Tested By : Jose Aguirre | Date of testing: 08-Aug-16 - 08-Aug-16 |
| Test Result : PASS | |

See Appendix C for list of test equipment

Conducted Spurs Average Upper, All Antennas

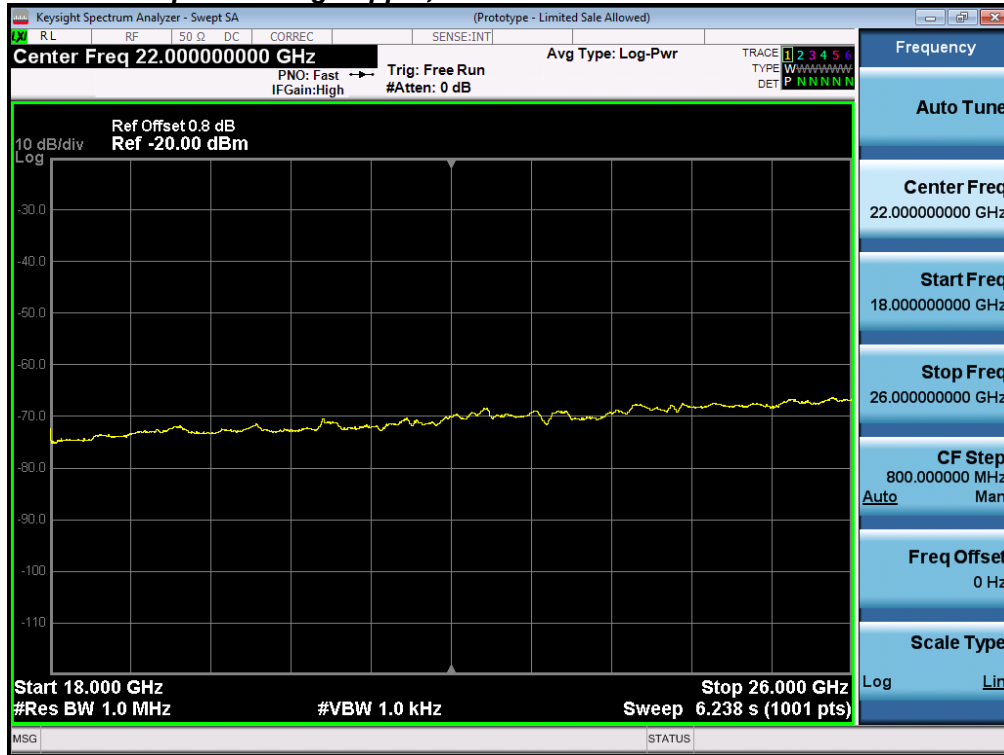

Conducted Spurs Peak Upper, All Antennas

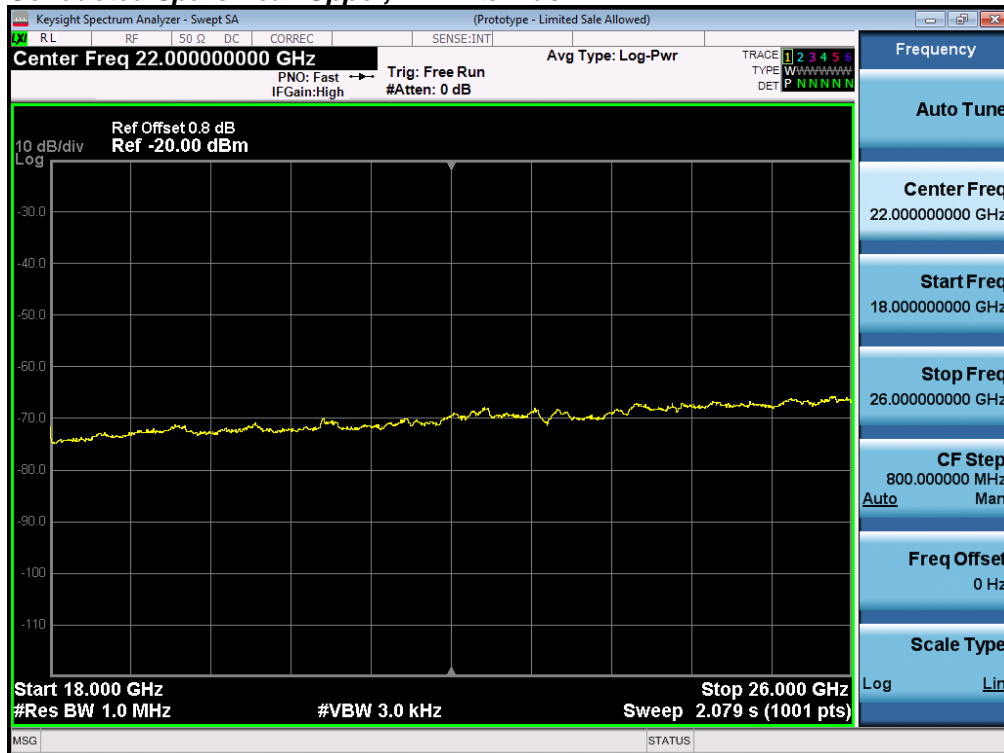

Conducted Spurious Emission results below represent the worst case for all antenna gain

| Frequency (MHz) | Mode | Tx Paths | Correlated Antenna Gain (dBi) | Tx 1 Spur Power (dBm) | Tx 2 Spur Power (dBm) | Tx 3 Spur Power (dBm) | Total Conducted Spur (dBm) | Limit (dBm) | Margin (dB) |
|-----------------|-------------------------------------|----------|-------------------------------|-----------------------|-----------------------|-----------------------|----------------------------|-------------|-------------|
| 5180 | Non HT20, 6 to 54 Mbps | 1 | 10 | -73.2 | | | -63.2 | -41.25 | 22.0 |
| | Non HT20, 6 to 54 Mbps | 2 | 10 | -73.2 | -73.3 | | -60.2 | -41.25 | 19.0 |
| | Non HT20, 6 to 54 Mbps | 3 | 10 | -73.0 | -73.2 | -72.9 | -58.3 | -41.25 | 17.0 |
| | Non HT20 Beam Forming, 6 to 54 Mbps | 2 | 10 | -73.1 | -72.9 | | -60.0 | -41.25 | 18.7 |
| | Non HT20 Beam Forming, 6 to 54 Mbps | 3 | 13 | -73.5 | -73.2 | -72.9 | -55.4 | -41.25 | 14.2 |
| | HT/VHT20, M0 to M7 | 1 | 10 | -73.3 | | | -63.3 | -41.25 | 22.1 |
| | HT/VHT20, M0 to M7 | 2 | 10 | -73.3 | -71.8 | | -59.5 | -41.25 | 18.2 |
| | HT/VHT20, M8 to M15 | 2 | 10 | -73.3 | -71.8 | | -59.5 | -41.25 | 18.2 |
| | HT/VHT20, M0 to M7 | 3 | 10 | -71.4 | -72.8 | -73.3 | -57.7 | -41.25 | 16.4 |
| | HT/VHT20, M8 to M15 | 3 | 10 | -71.4 | -72.8 | -73.3 | -57.7 | -41.25 | 16.4 |
| | HT/VHT20 Beam Forming, M0 to M7 | 2 | 10 | -73.3 | -73.3 | | -60.3 | -41.25 | 19.0 |
| | HT/VHT20 Beam Forming, M8 to M15 | 2 | 10 | -73.3 | -71.8 | | -59.5 | -41.25 | 18.2 |
| | HT/VHT20 Beam Forming, M0 to M7 | 3 | 13 | -71.6 | -73.3 | -73.4 | -54.9 | -41.25 | 13.7 |
| | HT/VHT20 Beam Forming, M8 to M15 | 3 | 10 | -72.9 | -73.2 | -72.9 | -58.2 | -41.25 | 17.0 |
| | HT/VHT20 STBC, M0 to M7 | 2 | 10 | -73.3 | -71.8 | | -59.5 | -41.25 | 18.2 |
| | HT/VHT20 STBC, M0 to M7 | 3 | 10 | -71.4 | -72.8 | -73.3 | -57.7 | -41.25 | 16.4 |
| 5190 | Non HT40, 6 to 54 Mbps | 1 | 10 | -73.2 | | | -63.2 | -41.25 | 22.0 |
| | Non HT40, 6 to 54 Mbps | 2 | 10 | -73.3 | -73.5 | | -60.4 | -41.25 | 19.1 |
| | Non HT40, 6 to 54 Mbps | 3 | 10 | -73.3 | -73.5 | -73.0 | -58.5 | -41.25 | 17.2 |
| | HT/VHT40, M0 to M7 | 1 | 10 | -73.3 | | | -63.3 | -41.25 | 22.1 |
| | HT/VHT40, M0 to M7 | 2 | 10 | -73.3 | -73.5 | | -60.4 | -41.25 | 19.1 |
| | HT/VHT40, M8 to M15 | 2 | 10 | -73.3 | -73.5 | | -60.4 | -41.25 | 19.1 |
| | HT/VHT40, M0 to M7 | 3 | 10 | -72.9 | -72.9 | -73.1 | -58.2 | -41.25 | 16.9 |
| | HT/VHT40, M8 to M15 | 3 | 10 | -72.9 | -72.9 | -73.1 | -58.2 | -41.25 | 16.9 |
| | HT/VHT40 Beam Forming, M0 to M7 | 2 | 10 | -72.9 | -72.9 | | -59.9 | -41.25 | 18.6 |
| | HT/VHT40 Beam Forming, M8 to M15 | 2 | 10 | -73.3 | -73.5 | | -60.4 | -41.25 | 19.1 |
| | HT/VHT40 Beam Forming, M0 to M7 | 3 | 13 | -72.9 | -73.2 | -72.5 | -55.1 | -41.25 | 13.8 |
| | HT/VHT40 Beam Forming, M8 to M15 | 3 | 10 | -72.9 | -72.9 | -73.1 | -58.2 | -41.25 | 16.9 |
| | HT/VHT40 STBC, M0 to M7 | 2 | 10 | -73.3 | -73.5 | | -60.4 | -41.25 | 19.1 |
| | HT/VHT40 STBC, M0 to M7 | 3 | 10 | -72.9 | -72.9 | -73.1 | -58.2 | -41.25 | 16.9 |

| | | | | | | | | | |
|-------------------------|--|----------|-----------|--------------|--------------|--------------|--------------|---------------|------------|
| 5210 | Non HT80, 6 to 54 Mbps | 1 | 10 | -58.4 | | | -48.4 | -41.25 | 7.2 |
| | Non HT80, 6 to 54 Mbps | 2 | 10 | -73.3 | -72.8 | | -60.0 | -41.25 | 18.8 |
| | Non HT80, 6 to 54 Mbps | 3 | 10 | -73.5 | -73.3 | -73.7 | -58.7 | -41.25 | 17.5 |
| | VHT80, M0 to M9 1ss | 1 | 10 | -73.5 | | | -63.5 | -41.25 | 22.3 |
| | VHT80, M0 to M9 1ss | 2 | 10 | -73.4 | -73.5 | | -60.4 | -41.25 | 19.2 |
| | VHT80, M0 to M9 2ss | 2 | 10 | -73.4 | -73.5 | | -60.4 | -41.25 | 19.2 |
| | VHT80, M0 to M9 1ss | 3 | 10 | -73.3 | -73.4 | -72.7 | -58.4 | -41.25 | 17.1 |
| | VHT80, M0 to M9 2ss | 3 | 10 | -73.3 | -73.4 | -72.7 | -58.4 | -41.25 | 17.1 |
| | VHT80 Beam Forming, M0 to M9 1ss | 2 | 10 | -73.4 | -73.5 | | -60.4 | -41.25 | 19.2 |
| | VHT80 Beam Forming, M0 to M9 2ss | 2 | 10 | -73.4 | -73.5 | | -60.4 | -41.25 | 19.2 |
| | VHT80 Beam Forming, M0 to M9 1ss | 3 | 13 | -72.8 | -73.2 | -73.7 | -55.4 | -41.25 | 14.2 |
| | VHT80 Beam Forming, M0 to M9 2ss | 3 | 10 | -73.3 | -73.4 | -72.7 | -58.4 | -41.25 | 17.1 |
| | VHT80 STBC, M0 to M9 1ss | 2 | 10 | -73.4 | -73.5 | | -60.4 | -41.25 | 19.2 |
| | VHT80 STBC, M0 to M9 1ss | 3 | 10 | -73.3 | -73.4 | -72.7 | -58.4 | -41.25 | 17.1 |
| 5220 | Non HT20, 6 to 54 Mbps | 1 | 10 | -58.9 | | | -48.9 | -41.25 | 7.7 |
| | Non HT20, 6 to 54 Mbps | 2 | 10 | -74.2 | -71.4 | | -59.6 | -41.25 | 18.3 |
| | Non HT20, 6 to 54 Mbps | 3 | 10 | -74.3 | -74.7 | -73.8 | -59.5 | -41.25 | 18.2 |
| | Non HT20 Beam Forming, 6 to 54 Mbps | 2 | 10 | -59.9 | -74.3 | | -49.7 | -41.25 | 8.5 |
| | Non HT20 Beam Forming, 6 to 54 Mbps | 3 | 13 | -59.8 | -74.1 | -74.4 | -46.5 | -41.25 | 5.2 |
| | HT/VHT20, M0 to M7 | 1 | 10 | -58.6 | | | -48.6 | -41.25 | 7.4 |
| | HT/VHT20, M0 to M7 | 2 | 10 | -74.1 | -73.1 | | -60.6 | -41.25 | 19.3 |
| | HT/VHT20, M8 to M15 | 2 | 10 | -74.1 | -73.1 | | -60.6 | -41.25 | 19.3 |
| | HT/VHT20, M0 to M7 | 3 | 10 | -71.2 | -73.4 | -74.7 | -58.1 | -41.25 | 16.8 |
| | HT/VHT20, M8 to M15 | 3 | 10 | -71.2 | -73.4 | -74.7 | -58.1 | -41.25 | 16.8 |
| | HT/VHT20 Beam Forming, M0 to M7 | 2 | 10 | -74.0 | -74.4 | | -61.2 | -41.25 | 19.9 |
| | HT/VHT20 Beam Forming, M8 to M15 | 2 | 10 | -74.1 | -73.1 | | -60.6 | -41.25 | 19.3 |
| | HT/VHT20 Beam Forming, M0 to M7 | 3 | 13 | -59.8 | -73.7 | -74.5 | -46.5 | -41.25 | 5.2 |
| | HT/VHT20 Beam Forming, M8 to M15 | 3 | 10 | -73.9 | -73.6 | -74.3 | -59.2 | -41.25 | 17.9 |
| | HT/VHT20 STBC, M0 to M7 | 2 | 10 | -74.1 | -73.1 | | -60.6 | -41.25 | 19.3 |
| HT/VHT20 STBC, M0 to M7 | 3 | 10 | -71.2 | -73.4 | -74.7 | -58.1 | -41.25 | 16.8 | |
| 5230 | Non HT40, 6 to 54 Mbps | 1 | 10 | -58.2 | | | -48.2 | -41.25 | 7.0 |
| | Non HT40, 6 to 54 Mbps | 2 | 10 | -58.3 | -74.4 | | -48.2 | -41.25 | 6.9 |
| | Non HT40, 6 to 54 Mbps | 3 | 10 | -74.2 | -73.4 | -73.8 | -59.0 | -41.25 | 17.8 |
| | HT/VHT40, M0 to M7 | 1 | 10 | -59.0 | | | -49.0 | -41.25 | 7.8 |
| | HT/VHT40, M0 to M7 | 2 | 10 | -73.4 | -74.3 | | -60.8 | -41.25 | 19.6 |
| | HT/VHT40, M8 to M15 | 2 | 10 | -73.4 | -74.3 | | -60.8 | -41.25 | 19.6 |
| | HT/VHT40, M0 to M7 | 3 | 10 | -74.1 | -74.0 | -71.9 | -58.4 | -41.25 | 17.2 |
| | HT/VHT40, M8 to M15 | 3 | 10 | -74.1 | -74.0 | -71.9 | -58.4 | -41.25 | 17.2 |
| | HT/VHT40 Beam Forming, M0 to M7 | 2 | 10 | -74.6 | -73.9 | | -61.2 | -41.25 | 20.0 |
| | HT/VHT40 Beam Forming, M8 to M15 | 2 | 10 | -73.4 | -74.3 | | -60.8 | -41.25 | 19.6 |
| | HT/VHT40 Beam Forming, M0 to M7 | 3 | 13 | -73.6 | -74.0 | -74.3 | -56.2 | -41.25 | 14.9 |



| | | | | | | | | | |
|------|-------------------------------------|---|----|-------|-------|-------|-------|--------|------|
| | HT/VHT40 Beam Forming, M8 to M15 | 3 | 10 | -73.3 | -74.1 | -73.4 | -58.8 | -41.25 | 17.6 |
| | HT/VHT40 STBC, M0 to M7 | 2 | 10 | -73.4 | -74.3 | | -60.8 | -41.25 | 19.6 |
| | HT/VHT40 STBC, M0 to M7 | 3 | 10 | -74.1 | -74.0 | -71.9 | -58.4 | -41.25 | 17.2 |
| 5240 | Non HT20, 6 to 54 Mbps | 1 | 10 | -58.5 | | | -48.5 | -41.25 | 7.3 |
| | Non HT20, 6 to 54 Mbps | 2 | 10 | -74.5 | -73.6 | | -61.0 | -41.25 | 19.8 |
| | Non HT20, 6 to 54 Mbps | 3 | 10 | -74.0 | -74.2 | -73.4 | -59.1 | -41.25 | 17.8 |
| | Non HT20 Beam Forming, 6 to 54 Mbps | 2 | 10 | -73.5 | -73.8 | | -60.6 | -41.25 | 19.4 |
| | Non HT20 Beam Forming, 6 to 54 Mbps | 3 | 13 | -73.8 | -74.3 | -74.3 | -56.4 | -41.25 | 15.1 |
| | HT/VHT20, M0 to M7 | 1 | 10 | -59.0 | | | -49.0 | -41.25 | 7.8 |
| | HT/VHT20, M0 to M7 | 2 | 10 | -73.0 | -73.8 | | -60.4 | -41.25 | 19.1 |
| | HT/VHT20, M8 to M15 | 2 | 10 | -73.0 | -73.8 | | -60.4 | -41.25 | 19.1 |
| | HT/VHT20, M0 to M7 | 3 | 10 | -73.3 | -73.7 | -73.7 | -58.8 | -41.25 | 17.5 |
| | HT/VHT20, M8 to M15 | 3 | 10 | -73.3 | -73.7 | -73.7 | -58.8 | -41.25 | 17.5 |
| | HT/VHT20 Beam Forming, M0 to M7 | 2 | 10 | -73.9 | -74.0 | | -60.9 | -41.25 | 19.7 |
| | HT/VHT20 Beam Forming, M8 to M15 | 2 | 10 | -73.0 | -73.8 | | -60.4 | -41.25 | 19.1 |
| | HT/VHT20 Beam Forming, M0 to M7 | 3 | 13 | -59.8 | -74.2 | -74.1 | -46.5 | -41.25 | 5.2 |
| | HT/VHT20 Beam Forming, M8 to M15 | 3 | 10 | -73.2 | -71.4 | -73.9 | -57.9 | -41.25 | 16.7 |
| | HT/VHT20 STBC, M0 to M7 | 2 | 10 | -73.0 | -73.8 | | -60.4 | -41.25 | 19.1 |
| | HT/VHT20 STBC, M0 to M7 | 3 | 10 | -73.3 | -73.7 | -73.7 | -58.8 | -41.25 | 17.5 |



Conducted Spurs Average, 5220 MHz, HT/VHT20 Beam Forming, M0 to M7



Antenna A



Antenna B



Antenna C

| Frequency (MHz) | Mode | Tx Paths | Correlated Antenna Gain (dBi) | Tx 1 Spur Power (dBm) | Tx 2 Spur Power (dBm) | Tx 3 Spur Power (dBm) | Total Conducted Spur (dBm) | Limit (dBm) | Margin (dB) |
|-------------------------|-------------------------------------|----------|-------------------------------|-----------------------|-----------------------|-----------------------|----------------------------|-------------|-------------|
| 5180 | Non HT20, 6 to 54 Mbps | 1 | 10 | -57.1 | | | -47.1 | -21.25 | 25.9 |
| | Non HT20, 6 to 54 Mbps | 2 | 10 | -57.1 | -56.3 | | -43.7 | -21.25 | 22.4 |
| | Non HT20, 6 to 54 Mbps | 3 | 10 | -54.0 | -57.5 | -58.0 | -41.3 | -21.25 | 20.1 |
| | Non HT20 Beam Forming, 6 to 54 Mbps | 2 | 10 | -58.8 | -53.8 | | -42.6 | -21.25 | 21.4 |
| | Non HT20 Beam Forming, 6 to 54 Mbps | 3 | 13 | -57.4 | -52.4 | -57.6 | -37.3 | -21.25 | 16.1 |
| | HT/VHT20, M0 to M7 | 1 | 10 | -58.4 | | | -48.4 | -21.25 | 27.2 |
| | HT/VHT20, M0 to M7 | 2 | 10 | -58.4 | -54.4 | | -42.9 | -21.25 | 21.7 |
| | HT/VHT20, M8 to M15 | 2 | 10 | -58.4 | -54.4 | | -42.9 | -21.25 | 21.7 |
| | HT/VHT20, M0 to M7 | 3 | 10 | -57.9 | -58.1 | -57.5 | -43.1 | -21.25 | 21.8 |
| | HT/VHT20, M8 to M15 | 3 | 10 | -57.9 | -58.1 | -57.5 | -43.1 | -21.25 | 21.8 |
| | HT/VHT20 Beam Forming, M0 to M7 | 2 | 10 | -57.4 | -58.0 | | -44.7 | -21.25 | 23.4 |
| | HT/VHT20 Beam Forming, M8 to M15 | 2 | 10 | -58.4 | -54.4 | | -42.9 | -21.25 | 21.7 |
| | HT/VHT20 Beam Forming, M0 to M7 | 3 | 13 | -56.5 | -56.4 | -59.0 | -39.4 | -21.25 | 18.1 |
| | HT/VHT20 Beam Forming, M8 to M15 | 3 | 10 | -57.5 | -57.0 | -53.0 | -40.6 | -21.25 | 19.3 |
| | HT/VHT20 STBC, M0 to M7 | 2 | 10 | -58.4 | -54.4 | | -42.9 | -21.25 | 21.7 |
| HT/VHT20 STBC, M0 to M7 | 3 | 10 | -57.9 | -58.1 | -57.5 | -43.1 | -21.25 | 21.8 | |
| 5190 | Non HT40, 6 to 54 Mbps | 1 | 10 | -58.1 | | | -48.1 | -21.25 | 26.9 |
| | Non HT40, 6 to 54 Mbps | 2 | 10 | -58.3 | -58.4 | | -45.3 | -21.25 | 24.1 |
| | Non HT40, 6 to 54 Mbps | 3 | 10 | -58.3 | -58.4 | -58.2 | -43.5 | -21.25 | 22.3 |
| | HT/VHT40, M0 to M7 | 1 | 10 | -57.0 | | | -47.0 | -21.25 | 25.8 |
| | HT/VHT40, M0 to M7 | 2 | 10 | -53.6 | -59.1 | | -42.5 | -21.25 | 21.3 |
| | HT/VHT40, M8 to M15 | 2 | 10 | -53.6 | -59.1 | | -42.5 | -21.25 | 21.3 |
| | HT/VHT40, M0 to M7 | 3 | 10 | -57.9 | -57.0 | -59.0 | -43.1 | -21.25 | 21.9 |
| | HT/VHT40, M8 to M15 | 3 | 10 | -57.9 | -57.0 | -59.0 | -43.1 | -21.25 | 21.9 |
| | HT/VHT40 Beam Forming, M0 to M7 | 2 | 10 | -57.9 | -57.0 | | -44.4 | -21.25 | 23.2 |
| | HT/VHT40 Beam Forming, M8 to M15 | 2 | 10 | -53.6 | -59.1 | | -42.5 | -21.25 | 21.3 |
| | HT/VHT40 Beam Forming, M0 to M7 | 3 | 13 | -56.8 | -53.6 | -58.1 | -38.0 | -21.25 | 16.7 |
| | HT/VHT40 Beam Forming, M8 to M15 | 3 | 10 | -57.9 | -57.0 | -59.0 | -43.1 | -21.25 | 21.9 |
| | HT/VHT40 STBC, M0 to M7 | 2 | 10 | -53.6 | -59.1 | | -42.5 | -21.25 | 21.3 |
| | HT/VHT40 STBC, M0 to M7 | 3 | 10 | -57.9 | -57.0 | -59.0 | -43.1 | -21.25 | 21.9 |

| | | | | | | | | | |
|------|--|----------|-----------|--------------|--------------|--------------|--------------|---------------|-------------|
| 5210 | Non HT80, 6 to 54 Mbps | 1 | 10 | -57.5 | | | -47.5 | -21.25 | 26.3 |
| | Non HT80, 6 to 54 Mbps | 2 | 10 | -57.0 | -57.8 | | -44.4 | -21.25 | 23.1 |
| | Non HT80, 6 to 54 Mbps | 3 | 10 | -57.4 | -57.8 | -56.8 | -42.5 | -21.25 | 21.3 |
| | VHT80, M0 to M9 1ss | 1 | 10 | -57.0 | | | -47.0 | -21.25 | 25.8 |
| | VHT80, M0 to M9 1ss | 2 | 10 | -58.7 | -57.1 | | -44.8 | -21.25 | 23.6 |
| | VHT80, M0 to M9 2ss | 2 | 10 | -58.7 | -57.1 | | -44.8 | -21.25 | 23.6 |
| | VHT80, M0 to M9 1ss | 3 | 10 | -59.5 | -57.5 | -57.0 | -43.1 | -21.25 | 21.9 |
| | VHT80, M0 to M9 2ss | 3 | 10 | -59.5 | -57.5 | -57.0 | -43.1 | -21.25 | 21.9 |
| | VHT80 Beam Forming, M0 to M9 1ss | 2 | 10 | -58.7 | -57.1 | | -44.8 | -21.25 | 23.6 |
| | VHT80 Beam Forming, M0 to M9 2ss | 2 | 10 | -58.7 | -57.1 | | -44.8 | -21.25 | 23.6 |
| | VHT80 Beam Forming, M0 to M9 1ss | 3 | 13 | -56.8 | -56.2 | -57.6 | -39.1 | -21.25 | 17.8 |
| | VHT80 Beam Forming, M0 to M9 2ss | 3 | 10 | -59.5 | -57.5 | -57.0 | -43.1 | -21.25 | 21.9 |
| | VHT80 STBC, M0 to M9 1ss | 2 | 10 | -58.7 | -57.1 | | -44.8 | -21.25 | 23.6 |
| | VHT80 STBC, M0 to M9 1ss | 3 | 10 | -59.5 | -57.5 | -57.0 | -43.1 | -21.25 | 21.9 |
| 5220 | Non HT20, 6 to 54 Mbps | 1 | 10 | -59.5 | | | -49.5 | -21.25 | 28.3 |
| | Non HT20, 6 to 54 Mbps | 2 | 10 | -59.3 | -58.9 | | -46.1 | -21.25 | 24.8 |
| | Non HT20, 6 to 54 Mbps | 3 | 10 | -58.4 | -59.1 | -58.0 | -43.7 | -21.25 | 22.5 |
| | Non HT20 Beam Forming, 6 to 54 Mbps | 2 | 10 | -53.5 | -59.3 | | -42.5 | -21.25 | 21.2 |
| | Non HT20 Beam Forming, 6 to 54 Mbps | 3 | 13 | -59.3 | -58.1 | -53.9 | -38.7 | -21.25 | 17.4 |
| | HT/VHT20, M0 to M7 | 1 | 10 | -59.9 | | | -49.9 | -21.25 | 28.7 |
| | HT/VHT20, M0 to M7 | 2 | 10 | -58.0 | -57.6 | | -44.8 | -21.25 | 23.5 |
| | HT/VHT20, M8 to M15 | 2 | 10 | -58.0 | -57.6 | | -44.8 | -21.25 | 23.5 |
| | HT/VHT20, M0 to M7 | 3 | 10 | -58.9 | -59.2 | -60.0 | -44.6 | -21.25 | 23.3 |
| | HT/VHT20, M8 to M15 | 3 | 10 | -58.9 | -59.2 | -60.0 | -44.6 | -21.25 | 23.3 |
| | HT/VHT20 Beam Forming, M0 to M7 | 2 | 10 | -57.5 | -58.8 | | -45.1 | -21.25 | 23.8 |
| | HT/VHT20 Beam Forming, M8 to M15 | 2 | 10 | -58.0 | -57.6 | | -44.8 | -21.25 | 23.5 |
| | HT/VHT20 Beam Forming, M0 to M7 | 3 | 13 | -58.6 | -58.4 | -58.6 | -40.8 | -21.25 | 19.5 |
| | HT/VHT20 Beam Forming, M8 to M15 | 3 | 10 | -58.8 | -57.6 | -58.2 | -43.4 | -21.25 | 22.2 |
| | HT/VHT20 STBC, M0 to M7 | 2 | 10 | -58.0 | -57.6 | | -44.8 | -21.25 | 23.5 |
| | HT/VHT20 STBC, M0 to M7 | 3 | 10 | -58.9 | -59.2 | -60.0 | -44.6 | -21.25 | 23.3 |
| 5230 | Non HT40, 6 to 54 Mbps | 1 | 10 | -58.1 | | | -48.1 | -21.25 | 26.9 |
| | Non HT40, 6 to 54 Mbps | 2 | 10 | -58.2 | -59.1 | | -45.6 | -21.25 | 24.4 |
| | Non HT40, 6 to 54 Mbps | 3 | 10 | -55.9 | -57.2 | -59.8 | -42.6 | -21.25 | 21.3 |
| | HT/VHT40, M0 to M7 | 1 | 10 | -58.9 | | | -48.9 | -21.25 | 27.7 |
| | HT/VHT40, M0 to M7 | 2 | 10 | -60.5 | -60.8 | | -47.6 | -21.25 | 26.4 |
| | HT/VHT40, M8 to M15 | 2 | 10 | -60.5 | -60.8 | | -47.6 | -21.25 | 26.4 |
| | HT/VHT40, M0 to M7 | 3 | 10 | -57.8 | -60.1 | -58.1 | -43.8 | -21.25 | 22.5 |
| | HT/VHT40, M8 to M15 | 3 | 10 | -57.8 | -60.1 | -58.1 | -43.8 | -21.25 | 22.5 |
| | HT/VHT40 Beam Forming, M0 to M7 | 2 | 10 | -53.3 | -59.1 | | -42.3 | -21.25 | 21.0 |
| | HT/VHT40 Beam Forming, M8 to M15 | 2 | 10 | -60.5 | -60.8 | | -47.6 | -21.25 | 26.4 |
| | HT/VHT40 Beam Forming, M0 to M7 | 3 | 13 | -53.9 | -53.8 | -59.2 | -37.2 | -21.25 | 16.0 |



| | | | | | | | | | |
|------|-------------------------------------|---|----|-------|-------|-------|-------|--------|------|
| | HT/VHT40 Beam Forming, M8 to M15 | 3 | 10 | -59.1 | -53.8 | -59.1 | -41.8 | -21.25 | 20.5 |
| | HT/VHT40 STBC, M0 to M7 | 2 | 10 | -60.5 | -60.8 | | -47.6 | -21.25 | 26.4 |
| | HT/VHT40 STBC, M0 to M7 | 3 | 10 | -57.8 | -60.1 | -58.1 | -43.8 | -21.25 | 22.5 |
| | | | | | | | | | |
| 5240 | Non HT20, 6 to 54 Mbps | 1 | 10 | -61.6 | | | -51.6 | -21.25 | 30.4 |
| | Non HT20, 6 to 54 Mbps | 2 | 10 | -57.9 | -57.3 | | -44.6 | -21.25 | 23.3 |
| | Non HT20, 6 to 54 Mbps | 3 | 10 | -58.0 | -60.7 | -60.1 | -44.7 | -21.25 | 23.4 |
| | Non HT20 Beam Forming, 6 to 54 Mbps | 2 | 10 | -57.7 | -58.9 | | -45.2 | -21.25 | 24.0 |
| | Non HT20 Beam Forming, 6 to 54 Mbps | 3 | 13 | -59.0 | -53.9 | -57.4 | -38.5 | -21.25 | 17.2 |
| | HT/VHT20, M0 to M7 | 1 | 10 | -58.2 | | | -48.2 | -21.25 | 27.0 |
| | HT/VHT20, M0 to M7 | 2 | 10 | -59.3 | -59.8 | | -46.5 | -21.25 | 25.3 |
| | HT/VHT20, M8 to M15 | 2 | 10 | -59.3 | -59.8 | | -46.5 | -21.25 | 25.3 |
| | HT/VHT20, M0 to M7 | 3 | 10 | -60.2 | -60.9 | -58.4 | -44.9 | -21.25 | 23.7 |
| | HT/VHT20, M8 to M15 | 3 | 10 | -60.2 | -60.9 | -58.4 | -44.9 | -21.25 | 23.7 |
| | HT/VHT20 Beam Forming, M0 to M7 | 2 | 10 | -53.6 | -58.9 | | -42.5 | -21.25 | 21.2 |
| | HT/VHT20 Beam Forming, M8 to M15 | 2 | 10 | -59.3 | -59.8 | | -46.5 | -21.25 | 25.3 |
| | HT/VHT20 Beam Forming, M0 to M7 | 3 | 13 | -60.8 | -59.3 | -57.7 | -41.3 | -21.25 | 20.1 |
| | HT/VHT20 Beam Forming, M8 to M15 | 3 | 10 | -56.5 | -53.9 | -59.5 | -41.3 | -21.25 | 20.0 |
| | HT/VHT20 STBC, M0 to M7 | 2 | 10 | -59.3 | -59.8 | | -46.5 | -21.25 | 25.3 |
| | HT/VHT20 STBC, M0 to M7 | 3 | 10 | -60.2 | -60.9 | -58.4 | -44.9 | -21.25 | 23.7 |



Conducted Spurs Peak, 5230 MHz, HT/VHT40 Beam Forming, M0 to M7

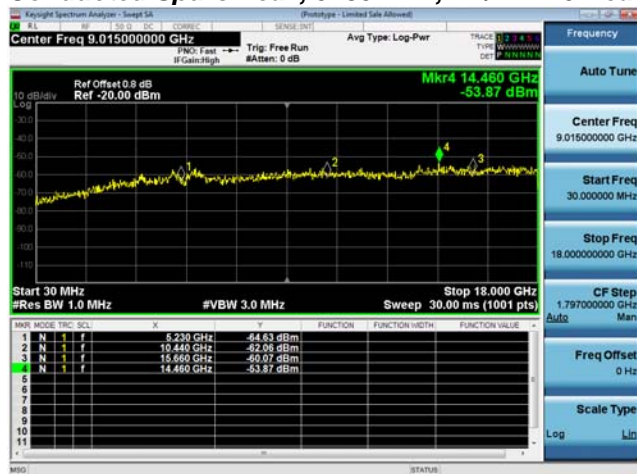

Antenna A

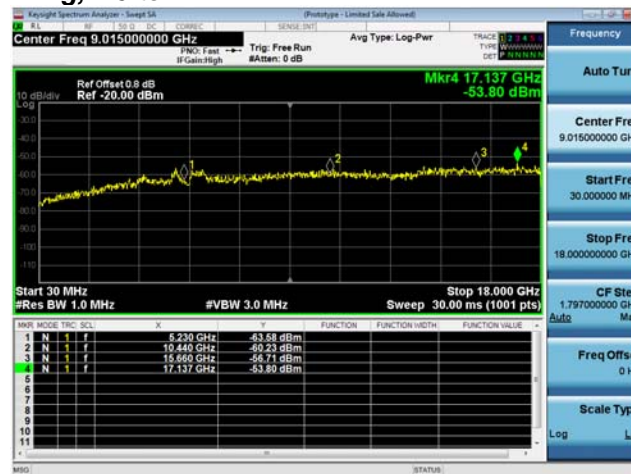

Antenna B

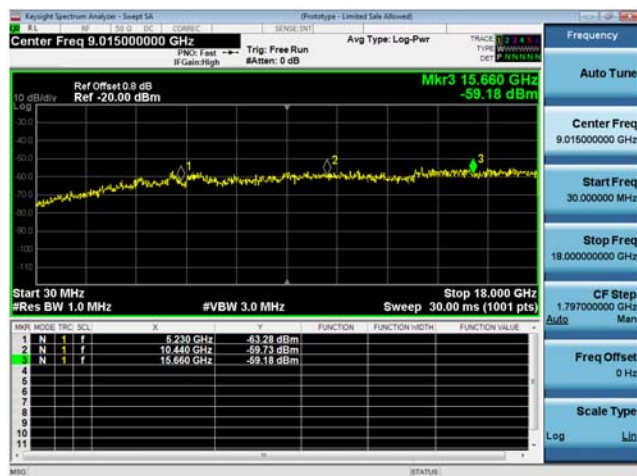

Antenna C

A.4 Conducted Band Edge

15.205 / 15.209 - Radiated emissions which fall in the restricted bands, as defined in Section 15.205(a), must also comply with the radiated emission limits specified in Section 15.209(a) (see Section 15.205(c)).
Use formula below to substitute conducted measurements in place of radiated measurements

$$E[\text{dB}\mu\text{V}/\text{m}] = \text{EIRP}[\text{dBm}] - 20 \log(d[\text{meters}]) + 104.77, \text{ where } E = \text{field strength and } d = 3 \text{ meter}$$

- 1) Average Plot, Limit= -41.25 dBm eirp
- 2) Peak plot, Limit = -21.25 dBm eirp

Test Procedure

Ref. ANSI C63.10: 2013

| Conducted Bandedge |
|--|
| Test Procedure |
| <ol style="list-style-type: none"> 1. Connect the antenna port(s) to the spectrum analyzer input. 2. Place the radio in continuous transmit mode. Use the procedures in ANSI C63.10: 2013 to substitute conducted measurements in place of radiated measurements. 3. Configure Spectrum analyzer as per test parameters below (be sure to enter all losses between the transmitter output and the spectrum analyzer). 4. Place a marker at the end of the restricted band closest to the transmit frequency to show compliance. Also measure any emissions in the restricted bands. 5. The "measure-and-sum technique" is used for measuring in-band transmit power of a device. In the measure-and-sum approach, the conducted emission level is measured at each antenna port. The measured results at the various antenna ports are then summed mathematically to determine the total emission level from the device. Summing is performed in linear power units. The worst case output is recorded. 6. Place a marker at the end of the restricted band closest to the transmit frequency to show compliance. Also measure any emissions in the restricted bands 7. Capture graphs and record pertinent measurement data. |

Ref. ANSI C63.10: 2013 section 12.7.6 (peak) & 12.7.7.3 (average, Method VB-A (Alternative))

| Conducted Bandedge |
|---|
| Test parameters restricted Band |
| RBW = 1 MHz VBW ≥ 3 x RBW for Peak, 100Hz for Average Sweep = Auto couple Detector = Peak Trace = Max Hold. |

| System Number | Description | Samples | System under test | Support equipment |
|---------------|-------------|---------|-------------------------------------|-------------------------------------|
| 1 | EUT | S01 | <input checked="" type="checkbox"/> | <input type="checkbox"/> |
| | Support | S02 | <input type="checkbox"/> | <input checked="" type="checkbox"/> |

| | |
|------------------------------------|--|
| Tested By : Jose Aguirre | Date of testing: 08-Aug-16 - 08-Aug-16 |
| Test Result : PASS | |

See Appendix C for list of test equipment

Antenna Gain: 4 dBi

| Frequency (MHz) | Mode | Tx Paths | Correlated Antenna Gain (dBi) | Tx 1 Bandedge Level (dBm) | Tx 2 Bandedge Level (dBm) | Tx 3 Bandedge Level (dBm) | Total Tx Bandedge Level (dBm) | Limit (dBm) | Margin (dB) |
|-----------------|-------------------------------------|----------|-------------------------------|---------------------------|---------------------------|---------------------------|-------------------------------|---------------|-------------|
| 5180 | Non HT20, 6 to 54 Mbps | 1 | 4 | -46.0 | | | -42.0 | -41.25 | 0.8 |
| | Non HT20, 6 to 54 Mbps | 2 | 4 | -48.3 | -53.2 | | -43.1 | -41.25 | 1.8 |
| | Non HT20, 6 to 54 Mbps | 3 | 4 | -50.7 | -55.4 | -54.2 | -44.2 | -41.25 | 2.9 |
| | Non HT20 Beam Forming, 6 to 54 Mbps | 2 | 7 | -53.2 | -60.1 | | -45.4 | -41.25 | 4.1 |
| | Non HT20 Beam Forming, 6 to 54 Mbps | 3 | 9 | -63.3 | -61.6 | -62.4 | -48.6 | -41.25 | 7.4 |
| | HT/VHT20, M0 to M7 | 1 | 4 | -45.3 | | | -41.3 | -41.25 | 0.0 |
| | HT/VHT20, M0 to M7 | 2 | 4 | -47.8 | -52.6 | | -42.6 | -41.25 | 1.3 |
| | HT/VHT20, M8 to M15 | 2 | 4 | -47.8 | -52.6 | | -42.6 | -41.25 | 1.3 |
| | HT/VHT20, M0 to M7 | 3 | 4 | -49.7 | -54.9 | -53.2 | -43.3 | -41.25 | 2.0 |
| | HT/VHT20, M8 to M15 | 3 | 4 | -49.7 | -54.9 | -53.2 | -43.3 | -41.25 | 2.0 |
| | HT/VHT20 Beam Forming, M0 to M7 | 2 | 7 | -52.2 | -59.7 | | -44.5 | -41.25 | 3.2 |
| | HT/VHT20 Beam Forming, M8 to M15 | 2 | 4 | -47.8 | -52.6 | | -42.6 | -41.25 | 1.3 |
| | HT/VHT20 Beam Forming, M0 to M7 | 3 | 9 | -63.2 | -61.5 | -62.6 | -48.6 | -41.25 | 7.4 |
| | HT/VHT20 Beam Forming, M8 to M15 | 3 | 6 | -54.5 | -60.3 | -59.8 | -46.6 | -41.25 | 5.3 |
| | HT/VHT20 STBC, M0 to M7 | 2 | 4 | -47.8 | -52.6 | | -42.6 | -41.25 | 1.3 |
| | HT/VHT20 STBC, M0 to M7 | 3 | 4 | -49.7 | -54.9 | -53.2 | -43.3 | -41.25 | 2.0 |
| 5190 | Non HT40, 6 to 54 Mbps | 1 | 4 | -46.8 | | | -42.8 | -41.25 | 1.6 |
| | Non HT40, 6 to 54 Mbps | 2 | 4 | -49.1 | -51.8 | | -43.2 | -41.25 | 2.0 |
| | Non HT40, 6 to 54 Mbps | 3 | 4 | -49.1 | -51.8 | -57.4 | -42.8 | -41.25 | 1.6 |
| | HT/VHT40, M0 to M7 | 1 | 4 | -45.5 | | | -41.5 | -41.25 | 0.3 |
| | HT/VHT40, M0 to M7 | 2 | 4 | -48.4 | -48.8 | | -41.6 | -41.25 | 0.3 |
| | HT/VHT40, M8 to M15 | 2 | 4 | -48.4 | -48.8 | | -41.6 | -41.25 | 0.3 |
| | HT/VHT40, M0 to M7 | 3 | 4 | -51.8 | -51.5 | -55.7 | -43.9 | -41.25 | 2.6 |
| | HT/VHT40, M8 to M15 | 3 | 4 | -51.8 | -51.5 | -55.7 | -43.9 | -41.25 | 2.6 |
| | HT/VHT40 Beam Forming, M0 to M7 | 2 | 7 | -51.8 | -51.5 | | -41.6 | -41.25 | 0.4 |
| | HT/VHT40 Beam Forming, M8 to M15 | 2 | 4 | -48.4 | -48.8 | | -41.6 | -41.25 | 0.3 |
| | HT/VHT40 Beam Forming, M0 to M7 | 3 | 9 | -58.3 | -57.0 | -58.9 | -44.2 | -41.25 | 3.0 |
| | HT/VHT40 Beam Forming, M8 to M15 | 3 | 6 | -51.8 | -51.5 | -55.7 | -41.9 | -41.25 | 0.6 |
| | HT/VHT40 STBC, M0 to M7 | 2 | 4 | -48.4 | -48.8 | | -41.6 | -41.25 | 0.3 |
| | HT/VHT40 STBC, M0 to M7 | 3 | 4 | -51.8 | -51.5 | -55.7 | -43.9 | -41.25 | 2.6 |

| | | | | | | | | | |
|------|----------------------------------|---|---|-------|-------|-------|-------|--------|-----|
| 5210 | Non HT80, 6 to 54 Mbps | 1 | 4 | -47.0 | | | -43.0 | -41.25 | 1.8 |
| | Non HT80, 6 to 54 Mbps | 2 | 4 | -47.0 | -51.0 | | -41.5 | -41.25 | 0.3 |
| | Non HT80, 6 to 54 Mbps | 3 | 4 | -49.2 | -53.1 | -52.9 | -42.6 | -41.25 | 1.3 |
| | VHT80, M0 to M9 1ss | 1 | 4 | -45.7 | | | -41.7 | -41.25 | 0.5 |
| | VHT80, M0 to M9 1ss | 2 | 4 | -48.8 | -49.7 | | -42.2 | -41.25 | 1.0 |
| | VHT80, M0 to M9 2ss | 2 | 4 | -48.8 | -49.7 | | -42.2 | -41.25 | 1.0 |
| | VHT80, M0 to M9 1ss | 3 | 4 | -48.8 | -49.7 | -53.5 | -41.5 | -41.25 | 0.2 |
| | VHT80, M0 to M9 2ss | 3 | 4 | -48.8 | -49.7 | -53.5 | -41.5 | -41.25 | 0.2 |
| | VHT80 Beam Forming, M0 to M9 1ss | 2 | 7 | -52.2 | -52.7 | | -42.4 | -41.25 | 1.2 |
| | VHT80 Beam Forming, M0 to M9 2ss | 2 | 4 | -48.8 | -49.7 | | -42.2 | -41.25 | 1.0 |
| | VHT80 Beam Forming, M0 to M9 1ss | 3 | 9 | -57.9 | -57.0 | -57.6 | -43.7 | -41.25 | 2.5 |
| | VHT80 Beam Forming, M0 to M9 2ss | 3 | 6 | -52.2 | -52.7 | -54.7 | -42.3 | -41.25 | 1.1 |
| | VHT80 STBC, M0 to M9 1ss | 2 | 4 | -48.8 | -49.7 | | -42.2 | -41.25 | 1.0 |
| | VHT80 STBC, M0 to M9 1ss | 3 | 4 | -48.8 | -49.7 | -53.5 | -41.5 | -41.25 | 0.2 |

Conducted Bandedge Average, 5180 MHz, HT/VHT20, M0 to M7



Antenna A

Antenna Gain: 10 dBi

| Frequency (MHz) | Mode | Tx Paths | Correlated Antenna Gain (dBi) | Tx 1 Bandedge Level (dBm) | Tx 2 Bandedge Level (dBm) | Tx 3 Bandedge Level (dBm) | Total Tx Bandedge Level (dBm) | Limit (dBm) | Margin (dB) |
|-------------------------|-------------------------------------|----------|-------------------------------|---------------------------|---------------------------|---------------------------|-------------------------------|---------------|-------------|
| 5180 | Non HT20, 6 to 54 Mbps | 1 | 10 | -53.2 | | | -43.2 | -41.25 | 2.0 |
| | Non HT20, 6 to 54 Mbps | 2 | 10 | -53.2 | -60.1 | | -42.4 | -41.25 | 1.1 |
| | Non HT20, 6 to 54 Mbps | 3 | 10 | -57.5 | -60.8 | -61.5 | -44.8 | -41.25 | 3.5 |
| | Non HT20 Beam Forming, 6 to 54 Mbps | 2 | 10 | -59.5 | -61.2 | | -47.3 | -41.25 | 6.0 |
| | Non HT20 Beam Forming, 6 to 54 Mbps | 3 | 13 | -64.7 | -64.0 | -65.2 | -46.8 | -41.25 | 5.6 |
| | HT/VHT20, M0 to M7 | 1 | 10 | -52.2 | | | -42.2 | -41.25 | 1.0 |
| | HT/VHT20, M0 to M7 | 2 | 10 | -52.2 | -59.7 | | -41.5 | -41.25 | 0.2 |
| | HT/VHT20, M8 to M15 | 2 | 10 | -52.2 | -59.7 | | -41.5 | -41.25 | 0.2 |
| | HT/VHT20, M0 to M7 | 3 | 10 | -56.9 | -60.9 | -61.3 | -44.4 | -41.25 | 3.2 |
| | HT/VHT20, M8 to M15 | 3 | 10 | -56.9 | -60.9 | -61.3 | -44.4 | -41.25 | 3.2 |
| | HT/VHT20 Beam Forming, M0 to M7 | 2 | 10 | -59.0 | -61.2 | | -47.0 | -41.25 | 5.7 |
| | HT/VHT20 Beam Forming, M8 to M15 | 2 | 10 | -52.2 | -59.7 | | -41.5 | -41.25 | 0.2 |
| | HT/VHT20 Beam Forming, M0 to M7 | 3 | 13 | -64.6 | -64.1 | -64.9 | -46.7 | -41.25 | 5.5 |
| | HT/VHT20 Beam Forming, M8 to M15 | 3 | 10 | -63.2 | -61.5 | -62.6 | -47.6 | -41.25 | 6.4 |
| | HT/VHT20 STBC, M0 to M7 | 2 | 10 | -52.2 | -59.7 | | -41.5 | -41.25 | 0.2 |
| HT/VHT20 STBC, M0 to M7 | 3 | 10 | -56.9 | -60.9 | -61.3 | -44.4 | -41.25 | 3.2 | |
| 5190 | Non HT40, 6 to 54 Mbps | 1 | 10 | -51.9 | | | -41.9 | -41.25 | 0.7 |
| | Non HT40, 6 to 54 Mbps | 2 | 10 | -55.3 | -57.4 | | -43.2 | -41.25 | 2.0 |
| | Non HT40, 6 to 54 Mbps | 3 | 10 | -55.3 | -57.4 | -60.2 | -42.4 | -41.25 | 1.2 |
| | HT/VHT40, M0 to M7 | 1 | 10 | -51.8 | | | -41.8 | -41.25 | 0.5 |
| | HT/VHT40, M0 to M7 | 2 | 10 | -55.3 | -54.6 | | -41.9 | -41.25 | 0.7 |
| | HT/VHT40, M8 to M15 | 2 | 10 | -55.3 | -54.6 | | -41.9 | -41.25 | 0.7 |
| | HT/VHT40, M0 to M7 | 3 | 10 | -58.3 | -57.0 | -58.9 | -43.2 | -41.25 | 2.0 |
| | HT/VHT40, M8 to M15 | 3 | 10 | -58.3 | -57.0 | -58.9 | -43.2 | -41.25 | 2.0 |
| | HT/VHT40 Beam Forming, M0 to M7 | 2 | 10 | -58.3 | -57.0 | | -44.6 | -41.25 | 3.3 |
| | HT/VHT40 Beam Forming, M8 to M15 | 2 | 10 | -55.3 | -54.6 | | -41.9 | -41.25 | 0.7 |
| | HT/VHT40 Beam Forming, M0 to M7 | 3 | 13 | -63.9 | -63.9 | -64.4 | -46.3 | -41.25 | 5.0 |
| | HT/VHT40 Beam Forming, M8 to M15 | 3 | 10 | -58.3 | -57.0 | -58.9 | -43.2 | -41.25 | 2.0 |
| | HT/VHT40 STBC, M0 to M7 | 2 | 10 | -55.3 | -54.6 | | -41.9 | -41.25 | 0.7 |
| | HT/VHT40 STBC, M0 to M7 | 3 | 10 | -58.3 | -57.0 | -58.9 | -43.2 | -41.25 | 2.0 |



| | | | | | | | | | |
|------|----------------------------------|---|----|-------|-------|-------|-------|--------|-----|
| 5210 | Non HT80, 6 to 54 Mbps | 1 | 10 | -51.5 | | | -41.5 | -41.25 | 0.3 |
| | Non HT80, 6 to 54 Mbps | 2 | 10 | -55.1 | -55.8 | | -42.4 | -41.25 | 1.2 |
| | Non HT80, 6 to 54 Mbps | 3 | 10 | -57.3 | -59.3 | -58.5 | -43.5 | -41.25 | 2.3 |
| | VHT80, M0 to M9 1ss | 1 | 10 | -52.2 | | | -42.2 | -41.25 | 1.0 |
| | VHT80, M0 to M9 1ss | 2 | 10 | -55.1 | -55.0 | | -42.0 | -41.25 | 0.8 |
| | VHT80, M0 to M9 2ss | 2 | 10 | -55.1 | -55.0 | | -42.0 | -41.25 | 0.8 |
| | VHT80, M0 to M9 1ss | 3 | 10 | -57.9 | -57.0 | -57.6 | -42.7 | -41.25 | 1.5 |
| | VHT80, M0 to M9 2ss | 3 | 10 | -57.9 | -57.0 | -57.6 | -42.7 | -41.25 | 1.5 |
| | VHT80 Beam Forming, M0 to M9 1ss | 2 | 10 | -55.1 | -55.0 | | -42.0 | -41.25 | 0.8 |
| | VHT80 Beam Forming, M0 to M9 2ss | 2 | 10 | -55.1 | -55.0 | | -42.0 | -41.25 | 0.8 |
| | VHT80 Beam Forming, M0 to M9 1ss | 3 | 13 | -61.5 | -61.6 | -62.0 | -43.9 | -41.25 | 2.7 |
| | VHT80 Beam Forming, M0 to M9 2ss | 3 | 10 | -57.9 | -57.0 | -57.6 | -42.7 | -41.25 | 1.5 |
| | VHT80 STBC, M0 to M9 1ss | 2 | 10 | -55.1 | -55.0 | | -42.0 | -41.25 | 0.8 |
| | VHT80 STBC, M0 to M9 1ss | 3 | 10 | -57.9 | -57.0 | -57.6 | -42.7 | -41.25 | 1.5 |



Conducted Bandedge Average, 5180 MHz, HT/VHT20, M0 to M7



Antenna A



Antenna B

Antenna Gain: 4 dBi

| Frequency (MHz) | Mode | Tx Paths | Correlated Antenna Gain (dBi) | Tx 1 Bandedge Level (dBm) | Tx 2 Bandedge Level (dBm) | Tx 3 Bandedge Level (dBm) | Total Tx Bandedge Level (dBm) | Limit (dBm) | Margin (dB) |
|-----------------|-------------------------------------|----------|-------------------------------|---------------------------|---------------------------|---------------------------|-------------------------------|---------------|-------------|
| 5180 | Non HT20, 6 to 54 Mbps | 1 | 4 | -36.7 | | | -32.7 | -21.25 | 11.5 |
| | Non HT20, 6 to 54 Mbps | 2 | 4 | -39.1 | -41.8 | | -33.2 | -21.25 | 12.0 |
| | Non HT20, 6 to 54 Mbps | 3 | 4 | -40.1 | -43.2 | -39.5 | -31.9 | -21.25 | 10.6 |
| | Non HT20 Beam Forming, 6 to 54 Mbps | 2 | 7 | -43.3 | -46.1 | | -34.5 | -21.25 | 13.2 |
| | Non HT20 Beam Forming, 6 to 54 Mbps | 3 | 9 | -50.7 | -47.6 | -50.4 | -35.6 | -21.25 | 14.3 |
| | HT/VHT20, M0 to M7 | 1 | 4 | -33.8 | | | -29.8 | -21.25 | 8.6 |
| | HT/VHT20, M0 to M7 | 2 | 4 | -33.9 | -33.9 | | -26.9 | -21.25 | 5.6 |
| | HT/VHT20, M8 to M15 | 2 | 4 | -33.9 | -33.9 | | -26.9 | -21.25 | 5.6 |
| | HT/VHT20, M0 to M7 | 3 | 4 | -35.8 | -36.6 | -42.8 | -28.7 | -21.25 | 7.5 |
| | HT/VHT20, M8 to M15 | 3 | 4 | -35.8 | -36.6 | -42.8 | -28.7 | -21.25 | 7.5 |
| | HT/VHT20 Beam Forming, M0 to M7 | 2 | 7 | -35.8 | -46.8 | | -28.5 | -21.25 | 7.2 |
| | HT/VHT20 Beam Forming, M8 to M15 | 2 | 4 | -33.9 | -33.9 | | -26.9 | -21.25 | 5.6 |
| | HT/VHT20 Beam Forming, M0 to M7 | 3 | 9 | -46.6 | -47.4 | -50.7 | -34.1 | -21.25 | 12.9 |
| | HT/VHT20 Beam Forming, M8 to M15 | 3 | 6 | -39.6 | -47.1 | -40.4 | -30.6 | -21.25 | 9.3 |
| | HT/VHT20 STBC, M0 to M7 | 2 | 4 | -33.9 | -33.9 | | -26.9 | -21.25 | 5.6 |
| | HT/VHT20 STBC, M0 to M7 | 3 | 4 | -35.8 | -36.6 | -42.8 | -28.7 | -21.25 | 7.5 |
| 5190 | Non HT40, 6 to 54 Mbps | 1 | 4 | -35.5 | | | -31.5 | -21.25 | 10.3 |
| | Non HT40, 6 to 54 Mbps | 2 | 4 | -38.0 | -38.4 | | -31.2 | -21.25 | 9.9 |
| | Non HT40, 6 to 54 Mbps | 3 | 4 | -38.0 | -38.4 | -39.3 | -29.8 | -21.25 | 8.5 |
| | HT/VHT40, M0 to M7 | 1 | 4 | -36.3 | | | -32.3 | -21.25 | 11.1 |
| | HT/VHT40, M0 to M7 | 2 | 4 | -35.0 | -41.1 | | -30.0 | -21.25 | 8.8 |
| | HT/VHT40, M8 to M15 | 2 | 4 | -35.0 | -41.1 | | -30.0 | -21.25 | 8.8 |
| | HT/VHT40, M0 to M7 | 3 | 4 | -40.1 | -40.4 | -45.2 | -32.6 | -21.25 | 11.3 |
| | HT/VHT40, M8 to M15 | 3 | 4 | -40.1 | -40.4 | -45.2 | -32.6 | -21.25 | 11.3 |
| | HT/VHT40 Beam Forming, M0 to M7 | 2 | 7 | -40.1 | -40.4 | | -30.2 | -21.25 | 9.0 |
| | HT/VHT40 Beam Forming, M8 to M15 | 2 | 4 | -35.0 | -41.1 | | -30.0 | -21.25 | 8.8 |
| | HT/VHT40 Beam Forming, M0 to M7 | 3 | 9 | -43.2 | -44.4 | -47.9 | -31.0 | -21.25 | 9.7 |
| | HT/VHT40 Beam Forming, M8 to M15 | 3 | 6 | -40.1 | -40.4 | -45.2 | -30.6 | -21.25 | 9.3 |
| | HT/VHT40 STBC, M0 to M7 | 2 | 4 | -35.0 | -41.1 | | -30.0 | -21.25 | 8.8 |
| | HT/VHT40 STBC, M0 to M7 | 3 | 4 | -40.1 | -40.4 | -45.2 | -32.6 | -21.25 | 11.3 |



| | | | | | | | | | |
|------|----------------------------------|---|---|-------|-------|-------|-------|--------|------|
| 5210 | Non HT80, 6 to 54 Mbps | 1 | 4 | -33.8 | | | -29.8 | -21.25 | 8.6 |
| | Non HT80, 6 to 54 Mbps | 2 | 4 | -33.8 | -38.7 | | -28.6 | -21.25 | 7.3 |
| | Non HT80, 6 to 54 Mbps | 3 | 4 | -34.6 | -40.7 | -45.7 | -29.4 | -21.25 | 8.1 |
| | VHT80, M0 to M9 1ss | 1 | 4 | -30.9 | | | -26.9 | -21.25 | 5.7 |
| | VHT80, M0 to M9 1ss | 2 | 4 | -35.5 | -39.9 | | -30.2 | -21.25 | 8.9 |
| | VHT80, M0 to M9 2ss | 2 | 4 | -35.5 | -39.9 | | -30.2 | -21.25 | 8.9 |
| | VHT80, M0 to M9 1ss | 3 | 4 | -35.5 | -39.9 | -43.7 | -29.7 | -21.25 | 8.4 |
| | VHT80, M0 to M9 2ss | 3 | 4 | -35.5 | -39.9 | -43.7 | -29.7 | -21.25 | 8.4 |
| | VHT80 Beam Forming, M0 to M9 1ss | 2 | 7 | -42.1 | -38.2 | | -29.7 | -21.25 | 8.5 |
| | VHT80 Beam Forming, M0 to M9 2ss | 2 | 4 | -35.5 | -39.9 | | -30.2 | -21.25 | 8.9 |
| | VHT80 Beam Forming, M0 to M9 1ss | 3 | 9 | -44.0 | -47.0 | -47.5 | -32.1 | -21.25 | 10.9 |
| | VHT80 Beam Forming, M0 to M9 2ss | 3 | 6 | -42.1 | -38.2 | -43.3 | -29.9 | -21.25 | 8.6 |
| | VHT80 STBC, M0 to M9 1ss | 2 | 4 | -35.5 | -39.9 | | -30.2 | -21.25 | 8.9 |
| | VHT80 STBC, M0 to M9 1ss | 3 | 4 | -35.5 | -39.9 | -43.7 | -29.7 | -21.25 | 8.4 |

Conducted Bandedge Peak, 5180 MHz, HT/VHT20, M0 to M7

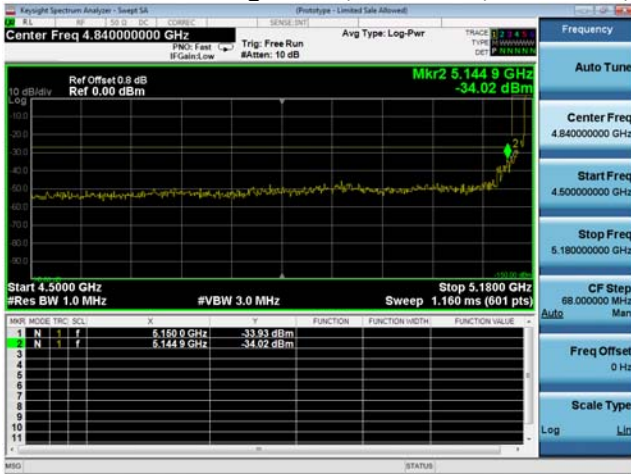

Antenna A

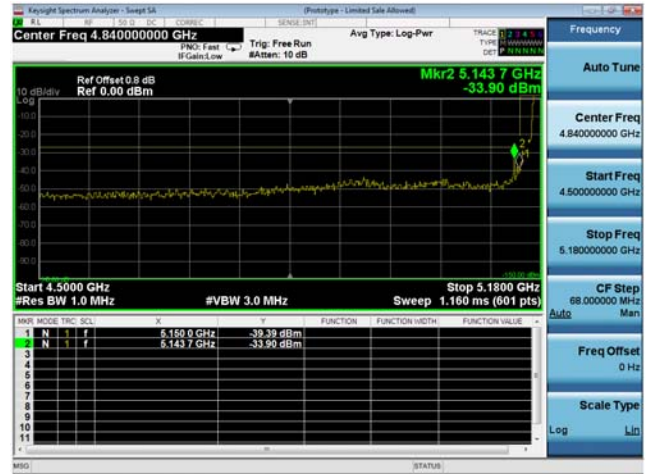

Antenna B

Antenna Gain: 10 dBi

| Frequency (MHz) | Mode | Tx Paths | Correlated Antenna Gain (dBi) | Tx 1 Bandedge Level (dBm) | Tx 2 Bandedge Level (dBm) | Tx 3 Bandedge Level (dBm) | Total Tx Bandedge Level (dBm) | Limit (dBm) | Margin (dB) |
|-----------------|-------------------------------------|----------|-------------------------------|---------------------------|---------------------------|---------------------------|-------------------------------|---------------|-------------|
| 5180 | Non HT20, 6 to 54 Mbps | 1 | 10 | -43.3 | | | -33.3 | -21.25 | 12.1 |
| | Non HT20, 6 to 54 Mbps | 2 | 10 | -43.3 | -46.1 | | -31.5 | -21.25 | 10.2 |
| | Non HT20, 6 to 54 Mbps | 3 | 10 | -44.6 | -47.3 | -49.6 | -31.9 | -21.25 | 10.7 |
| | Non HT20 Beam Forming, 6 to 54 Mbps | 2 | 10 | -48.2 | -47.2 | | -34.7 | -21.25 | 13.4 |
| | Non HT20 Beam Forming, 6 to 54 Mbps | 3 | 13 | -52.4 | -51.2 | -47.5 | -32.1 | -21.25 | 10.8 |
| | HT/VHT20, M0 to M7 | 1 | 10 | -35.8 | | | -25.8 | -21.25 | 4.6 |
| | HT/VHT20, M0 to M7 | 2 | 10 | -35.8 | -46.8 | | -25.5 | -21.25 | 4.2 |
| | HT/VHT20, M8 to M15 | 2 | 10 | -35.8 | -46.8 | | -25.5 | -21.25 | 4.2 |
| | HT/VHT20, M0 to M7 | 3 | 10 | -45.4 | -49.9 | -50.2 | -33.1 | -21.25 | 11.9 |
| | HT/VHT20, M8 to M15 | 3 | 10 | -45.4 | -49.9 | -50.2 | -33.1 | -21.25 | 11.9 |
| | HT/VHT20 Beam Forming, M0 to M7 | 2 | 10 | -47.0 | -46.2 | | -33.6 | -21.25 | 12.3 |
| | HT/VHT20 Beam Forming, M8 to M15 | 2 | 10 | -35.8 | -46.8 | | -25.5 | -21.25 | 4.2 |
| | HT/VHT20 Beam Forming, M0 to M7 | 3 | 13 | -50.3 | -48.9 | -47.3 | -30.9 | -21.25 | 9.6 |
| | HT/VHT20 Beam Forming, M8 to M15 | 3 | 10 | -46.6 | -47.4 | -50.7 | -33.1 | -21.25 | 11.9 |
| | HT/VHT20 STBC, M0 to M7 | 2 | 10 | -35.8 | -46.8 | | -25.5 | -21.25 | 4.2 |
| | HT/VHT20 STBC, M0 to M7 | 3 | 10 | -45.4 | -49.9 | -50.2 | -33.1 | -21.25 | 11.9 |
| 5190 | Non HT40, 6 to 54 Mbps | 1 | 10 | -36.5 | | | -26.5 | -21.25 | 5.3 |
| | Non HT40, 6 to 54 Mbps | 2 | 10 | -42.9 | -47.3 | | -31.6 | -21.25 | 10.3 |
| | Non HT40, 6 to 54 Mbps | 3 | 10 | -42.9 | -47.3 | -43.6 | -29.4 | -21.25 | 8.2 |
| | HT/VHT40, M0 to M7 | 1 | 10 | -40.1 | | | -30.1 | -21.25 | 8.9 |
| | HT/VHT40, M0 to M7 | 2 | 10 | -42.5 | -45.8 | | -30.8 | -21.25 | 9.6 |
| | HT/VHT40, M8 to M15 | 2 | 10 | -42.5 | -45.8 | | -30.8 | -21.25 | 9.6 |
| | HT/VHT40, M0 to M7 | 3 | 10 | -43.2 | -44.4 | -47.9 | -30.0 | -21.25 | 8.7 |
| | HT/VHT40, M8 to M15 | 3 | 10 | -43.2 | -44.4 | -47.9 | -30.0 | -21.25 | 8.7 |
| | HT/VHT40 Beam Forming, M0 to M7 | 2 | 10 | -43.2 | -44.4 | | -30.7 | -21.25 | 9.5 |
| | HT/VHT40 Beam Forming, M8 to M15 | 2 | 10 | -42.5 | -45.8 | | -30.8 | -21.25 | 9.6 |
| | HT/VHT40 Beam Forming, M0 to M7 | 3 | 13 | -47.6 | -48.6 | -45.3 | -29.2 | -21.25 | 7.9 |
| | HT/VHT40 Beam Forming, M8 to M15 | 3 | 10 | -43.2 | -44.4 | -47.9 | -30.0 | -21.25 | 8.7 |
| | HT/VHT40 STBC, M0 to M7 | 2 | 10 | -42.5 | -45.8 | | -30.8 | -21.25 | 9.6 |
| | HT/VHT40 STBC, M0 to M7 | 3 | 10 | -43.2 | -44.4 | -47.9 | -30.0 | -21.25 | 8.7 |

| | | | | | | | | | |
|------|----------------------------------|---|----|-------|-------|-------|-------|--------|------|
| 5210 | Non HT80, 6 to 54 Mbps | 1 | 10 | -36.3 | | | -26.3 | -21.25 | 5.1 |
| | Non HT80, 6 to 54 Mbps | 2 | 10 | -42.5 | -42.6 | | -29.5 | -21.25 | 8.3 |
| | Non HT80, 6 to 54 Mbps | 3 | 10 | -41.9 | -47.0 | -46.4 | -29.7 | -21.25 | 8.4 |
| | VHT80, M0 to M9 1ss | 1 | 10 | -42.1 | | | -32.1 | -21.25 | 10.9 |
| | VHT80, M0 to M9 1ss | 2 | 10 | -40.4 | -46.5 | | -29.4 | -21.25 | 8.2 |
| | VHT80, M0 to M9 2ss | 2 | 10 | -40.4 | -46.5 | | -29.4 | -21.25 | 8.2 |
| | VHT80, M0 to M9 1ss | 3 | 10 | -44.0 | -47.0 | -47.5 | -31.1 | -21.25 | 9.9 |
| | VHT80, M0 to M9 2ss | 3 | 10 | -44.0 | -47.0 | -47.5 | -31.1 | -21.25 | 9.9 |
| | VHT80 Beam Forming, M0 to M9 1ss | 2 | 10 | -40.4 | -46.5 | | -29.4 | -21.25 | 8.2 |
| | VHT80 Beam Forming, M0 to M9 2ss | 2 | 10 | -40.4 | -46.5 | | -29.4 | -21.25 | 8.2 |
| | VHT80 Beam Forming, M0 to M9 1ss | 3 | 13 | -47.4 | -48.2 | -49.4 | -30.5 | -21.25 | 9.2 |
| | VHT80 Beam Forming, M0 to M9 2ss | 3 | 10 | -44.0 | -47.0 | -47.5 | -31.1 | -21.25 | 9.9 |
| | VHT80 STBC, M0 to M9 1ss | 2 | 10 | -40.4 | -46.5 | | -29.4 | -21.25 | 8.2 |
| | VHT80 STBC, M0 to M9 1ss | 3 | 10 | -44.0 | -47.0 | -47.5 | -31.1 | -21.25 | 9.9 |

Conducted Bandedge Peak, 5180 MHz, HT/VHT20, M0 to M7

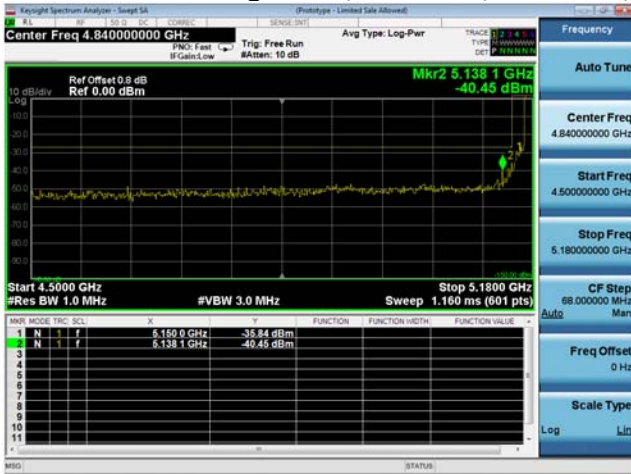

Antenna A

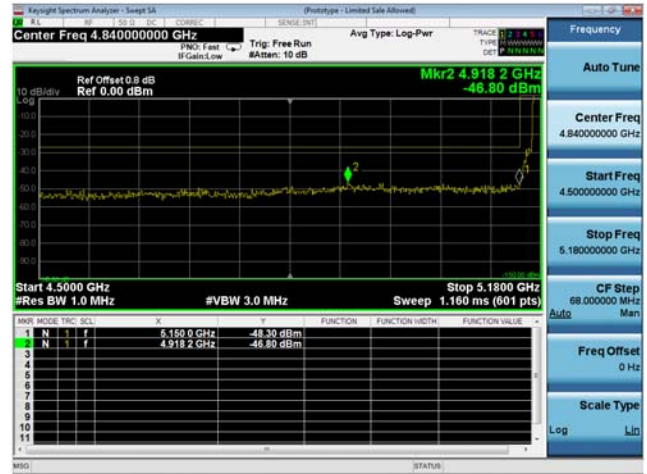

Antenna B



Title: Physical Test Arrangement Photograph

This is a dual band 2.4GHz / 5GHz device. All ports in this test set up photo are connected as all testing is automated. Section 2.6 of this test report given an overview of the different Tx antenna combinations used by this device.

Appendix B: Emission Test Results

Testing Laboratory: Cisco Systems, Inc., 125 West Tasman Drive, San Jose, CA 95134, USA

Radiated Emission Setup Diagram-Below 1G

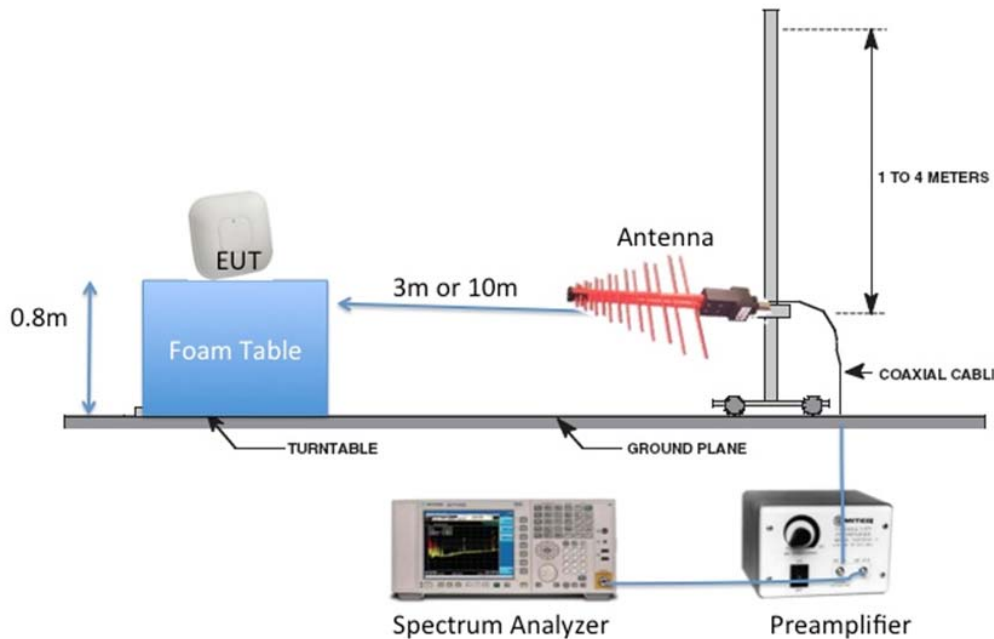

Radiated Emission Setup Diagram-Above 1G

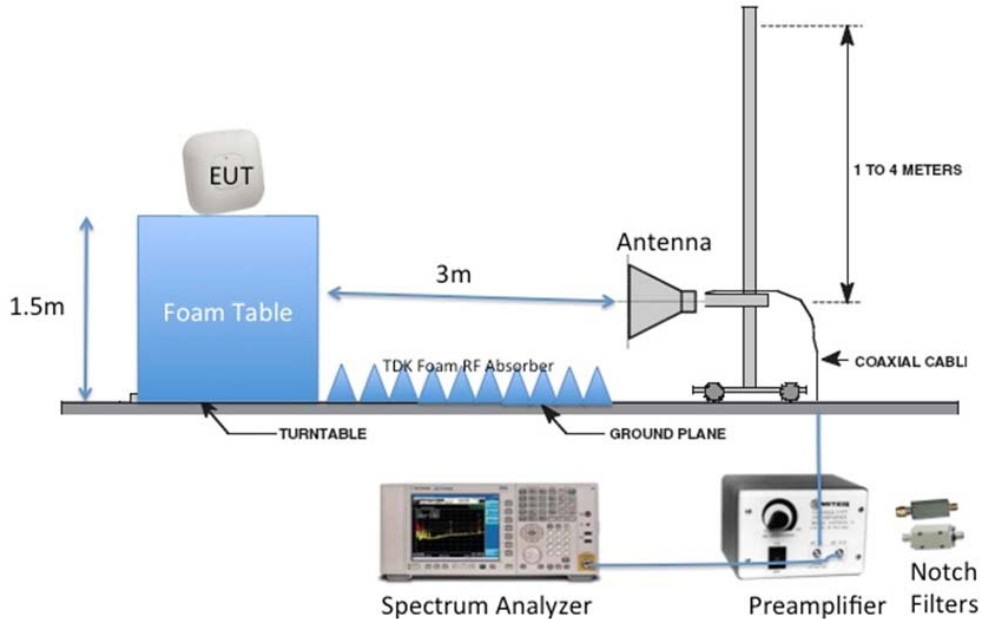

B.1 Radiated Spurious Emissions

FCC 15.205 / 15.407 Radiated emissions which fall in the restricted bands, as defined in Section 15.205(a), must also comply with the radiated emission limits specified in Section 15.209(a) (see Section 15.205(c)).

Ref. ANSI C63.10: 2013 section 12.7.6 (peak) & 12.7.7.3 (average)

Using Vasona, configure the spectrum analyzer as shown below (be sure to enter all losses between the transmitter output and the spectrum analyzer). Place the radio in continuous transmit mode.

| | |
|-----------------------|-------------------------------------|
| Span: | 1GHz – 18 GHz/18GHz-26G/26GHz-40GHz |
| Reference Level: | 80 dBuV |
| Attenuation: | 10 dB |
| Sweep Time: | Coupled |
| Resolution Bandwidth: | 1MHz |
| Video Bandwidth: | 3 MHz for peak, 1 KHz for average |
| Detector: | Peak |

Terminate the access Point RF ports with 50 ohm loads.

Maximize Turntable (find worst case table angle), Maximize Antenna (find worst case height)

Save 2 plots: 1) Average plot (Vertical and Horizontal), Limit= 54dBuV/m @3m
 2) Peak plot (Vertical and Horizontal), Limit = 74dBuV/m @3m

Place a marker at the end of the restricted band closest to the transmit frequency to show compliance.
 Also measure any emissions in the restricted bands.

This report represents the worst case data for all supported operating modes and antennas. There are no measurable emissions above 18 GHz.

| System Number | Description | Samples | System under test | Support equipment |
|---------------|-------------|---------|-------------------------------------|-------------------------------------|
| 2 | EUT | S03 | <input checked="" type="checkbox"/> | <input type="checkbox"/> |
| | Support | S04 | <input type="checkbox"/> | <input checked="" type="checkbox"/> |

| | |
|------------------------------------|--|
| Tested By : Jose Aguirre | Date of testing: 20-April-16 - 08-Aug-16 |
| Test Result : PASS | |

See Appendix C for list of test equipment

B.1.A Transmitter Radiated Spurious Emissions-Average Worst Case

| Frequency (MHz) | Mode | Data Rate (Mbps) | Spurious Emission Level (dBuV/m) | Limit (dBuV/m) | Margin (MHz) |
|-----------------|------------------------|------------------|----------------------------------|----------------|--------------|
| 5180Mhz | Non HT20, 6 to 54 Mbps | 6 | 50.4 | 54.0 | 3.6 |
| 5190Mhz | HT/VHT40, M0 to M23 | m0 | 50.3 | 54.0 | 3.7 |
| 5200Mhz | Non HT20, 6 to 54 Mbps | 6 | 50.3 | 54.0 | 3.7 |
| 5210Mhz | VHT80, M0 to M9 | m0x1 | 50.3 | 54.0 | 3.7 |
| 5230Mhz | HT/VHT40, M0 to M23 | m0 | 50.4 | 54.0 | 3.6 |
| 5240Mhz | Non HT20, 6 to 54 Mbps | 6 | 50.5 | 54.0 | 3.5 |



Average Radiated Transmitter Spurs, 5180MHz MHz, Non HT20, 6 to 54 Mbps



Average Radiated Transmitter Spurs, 5190MHz MHz, HT/VHT40, M0 to M23





Average Radiated Transmitter Spurs, 5200MHz MHz, Non HT20, 6 to 54 Mbps



Average Radiated Transmitter Spurs, 5210MHz MHz, VHT80, M0 to M9



Average Radiated Transmitter Spurs, 5230MHz MHz, HT/VHT40, M0 to M23

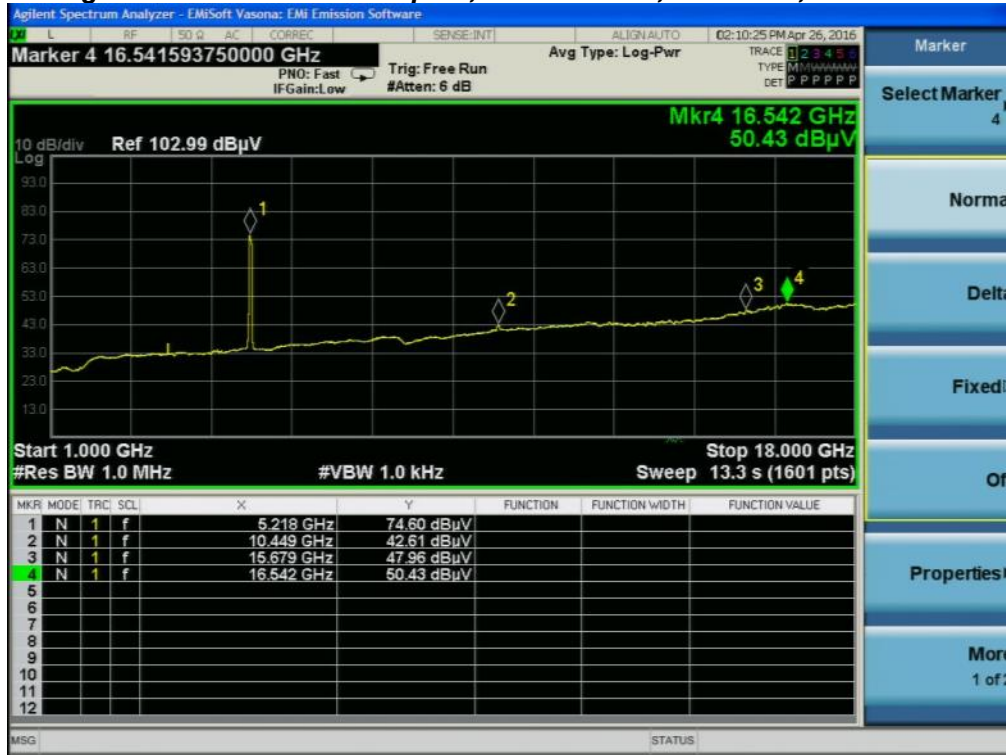

Average Radiated Transmitter Spurs, 5240MHz MHz, Non HT20, 6 to 54 Mbps

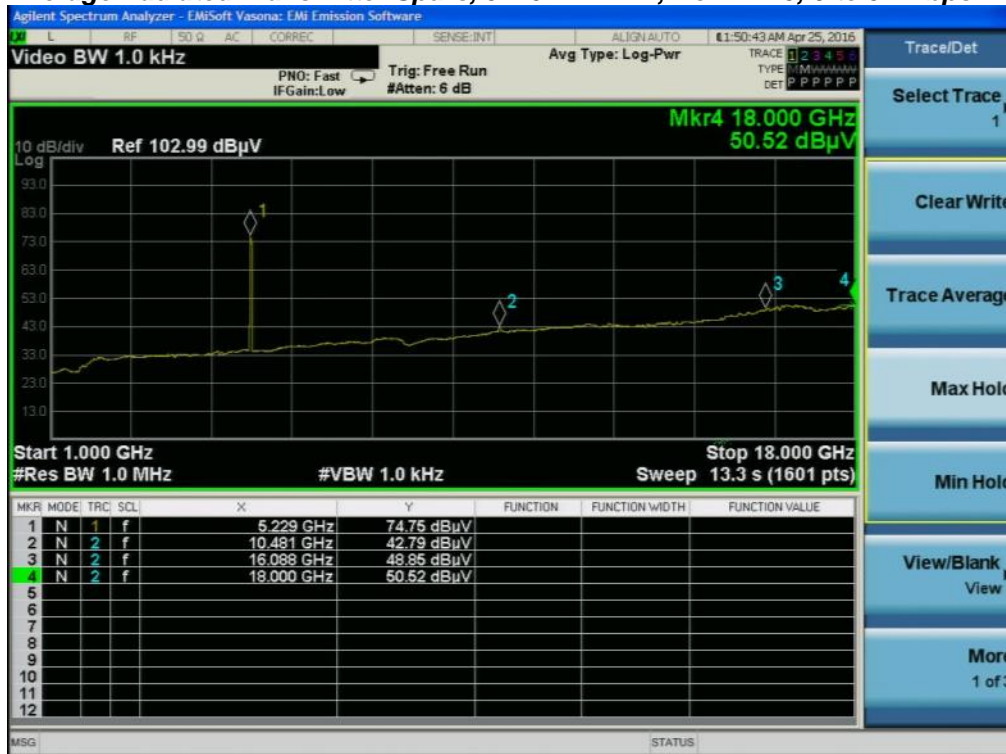



Average Radiated Transmitter Spurs, All modes, All rates, 18-26GHz

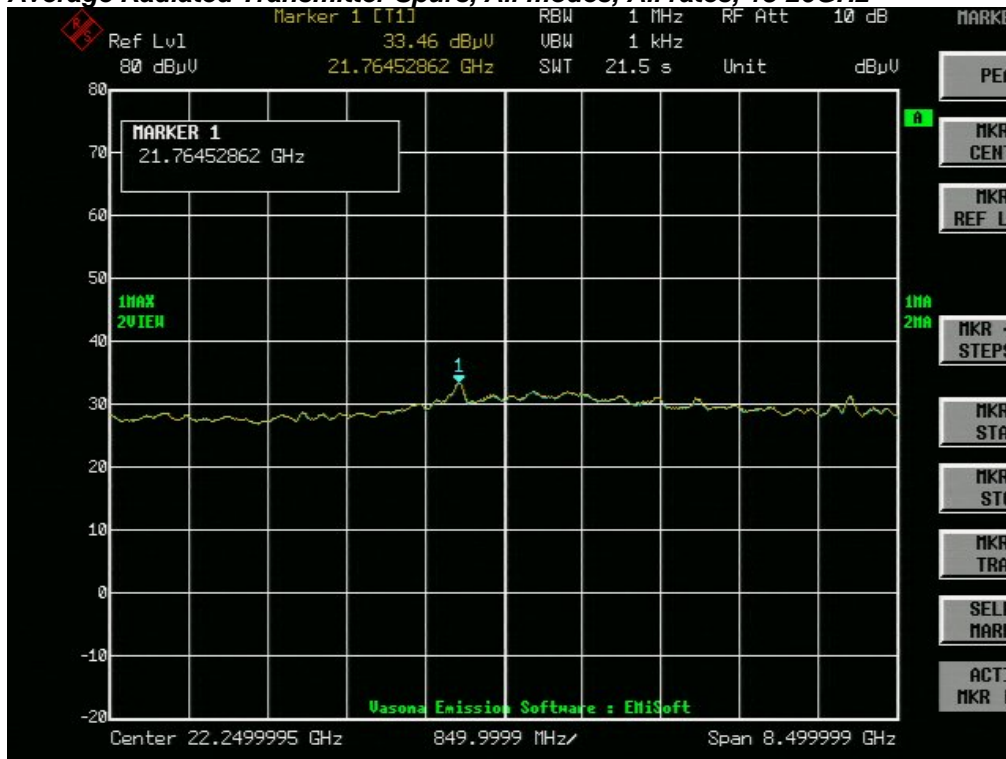

Average Radiated Transmitter Spurs, All modes, All rates, 26-40GHz

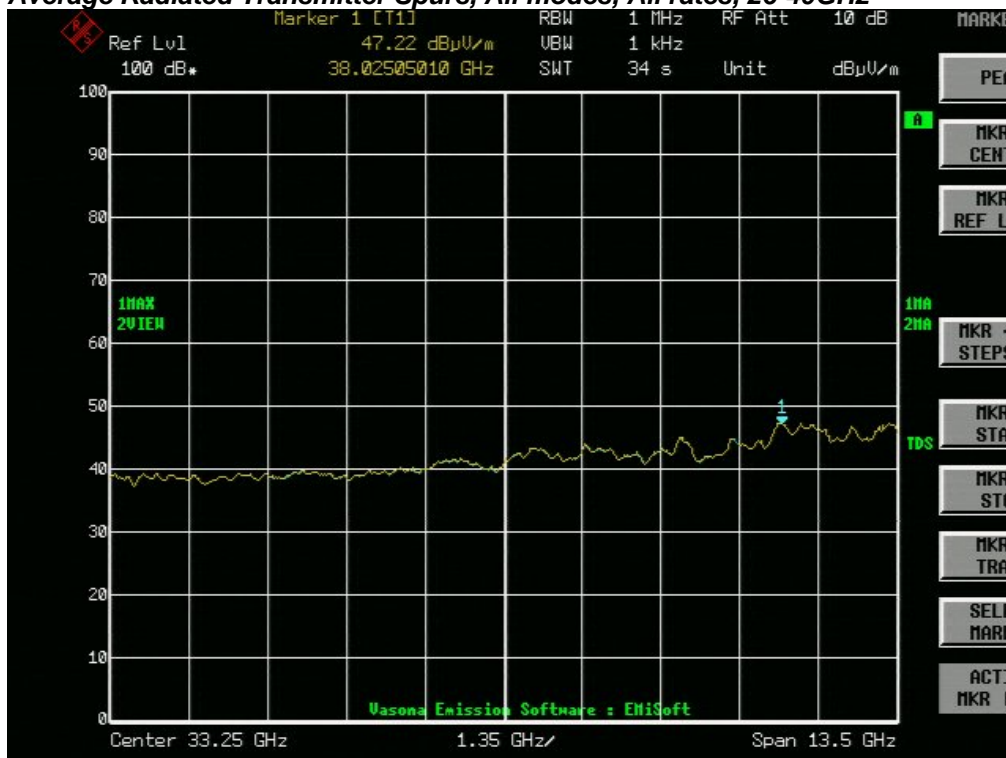

B.1.P Transmitter Radiated Spurious Emissions-Peak Worst Case

| Frequency (MHz) | Mode | Data Rate (Mbps) | Spurious Emission Level (dBuV/m) | Limit (dBuV/m) | Margin (MHz) |
|-----------------|------------------------|------------------|----------------------------------|----------------|--------------|
| 5180Mhz | Non HT20, 6 to 54 Mbps | 6 | 63.6 | 74.0 | 10.4 |
| 5190Mhz | HT/VHT40, M0 to M23 | m0 | 61.9 | 74.0 | 12.1 |
| 5200Mhz | Non HT20, 6 to 54 Mbps | 6 | 63.2 | 74.0 | 10.8 |
| 5210Mhz | VHT80, M0 to M9 | m0x1 | 62.1 | 74.0 | 11.9 |
| 5230Mhz | HT/VHT40, M0 to M23 | m0 | 62.9 | 74.0 | 11.1 |
| 5240Mhz | Non HT20, 6 to 54 Mbps | 6 | 63.7 | 74.0 | 10.3 |

Peak Radiated Transmitter Spurs, 5180MHz MHz, Non HT20, 6 to 54 Mbps

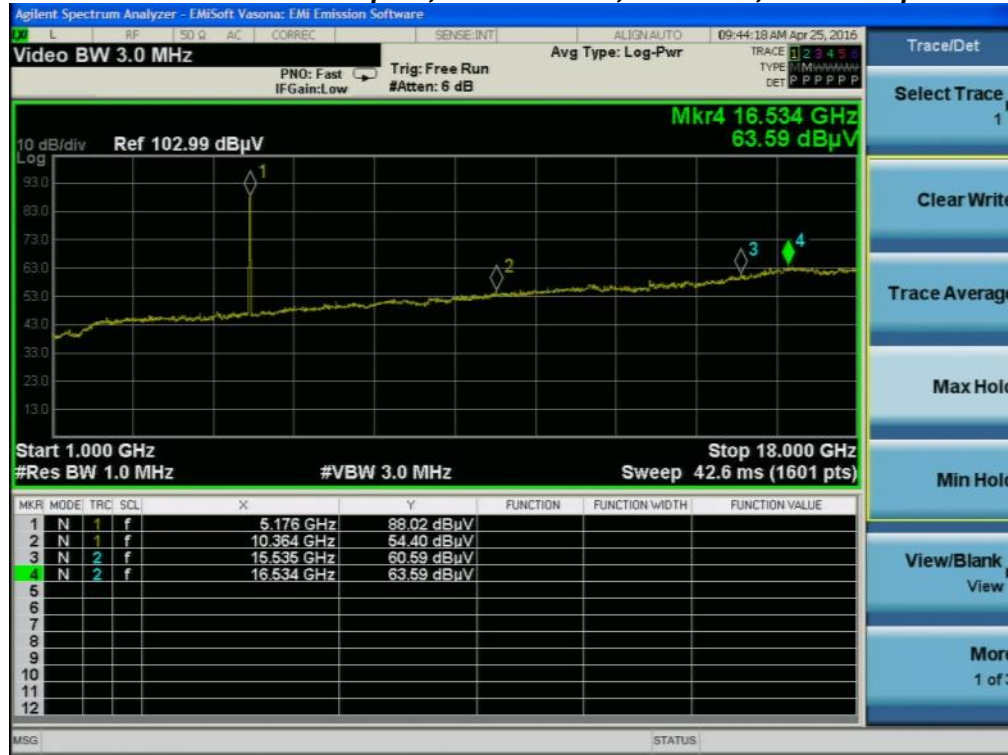

Peak Radiated Transmitter Spurs, 5190MHz MHz, HT/VHT40, M0 to M23



Peak Radiated Transmitter Spurs, 5200MHz MHz, Non HT20, 6 to 54 Mbps



Peak Radiated Transmitter Spurs, 5210MHz MHz, VHT80, M0 to M9



Peak Radiated Transmitter Spurs, 5230MHz MHz, HT/VHT40, M0 to M23



Peak Radiated Transmitter Spurs, 5240MHz MHz, Non HT20, 6 to 54 Mbps

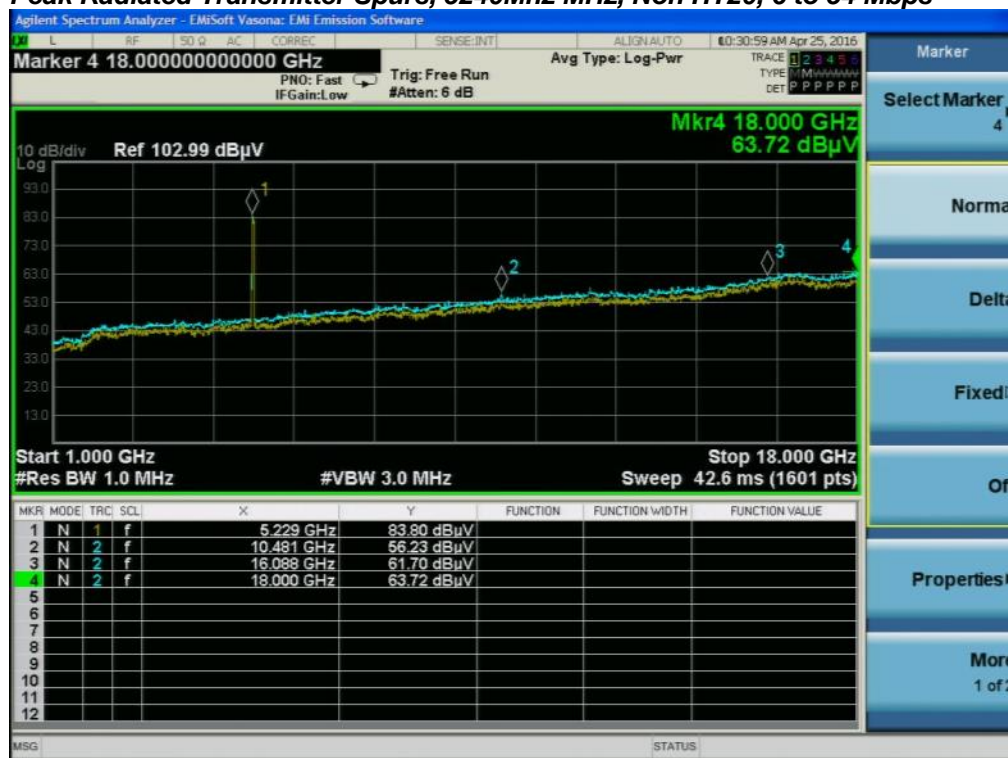

Peak Radiated Transmitter Spurs, All modes, All rates, 18-26GHz

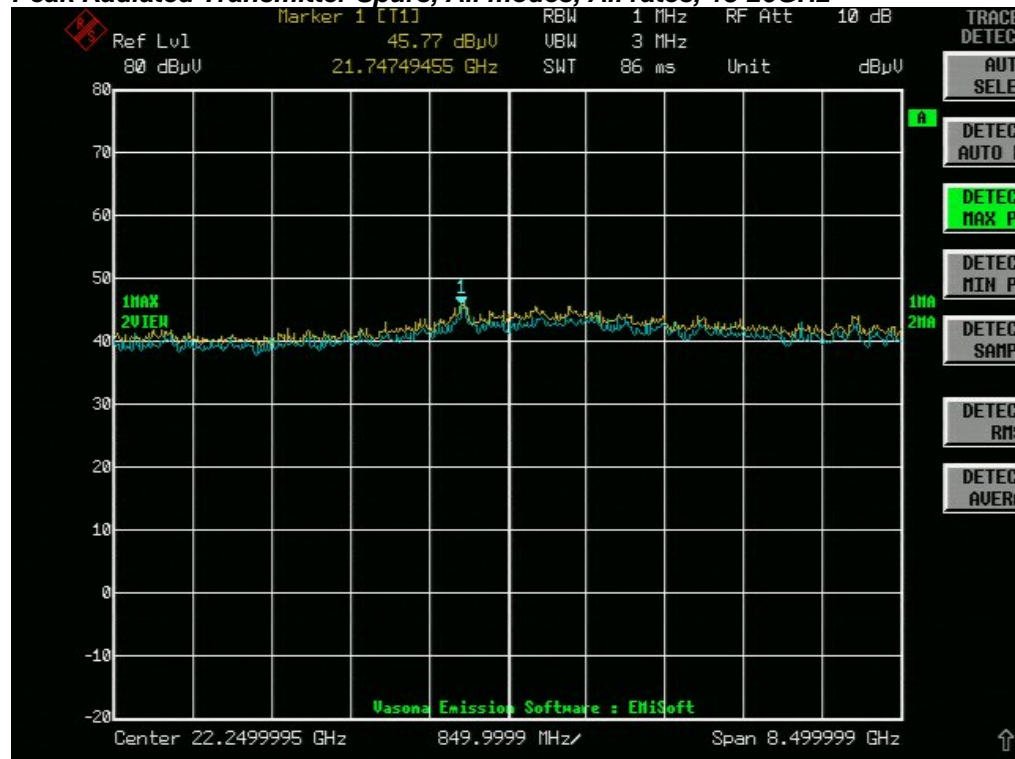

Peak Radiated Transmitter Spurs, All modes, All rates, 26-40GHz

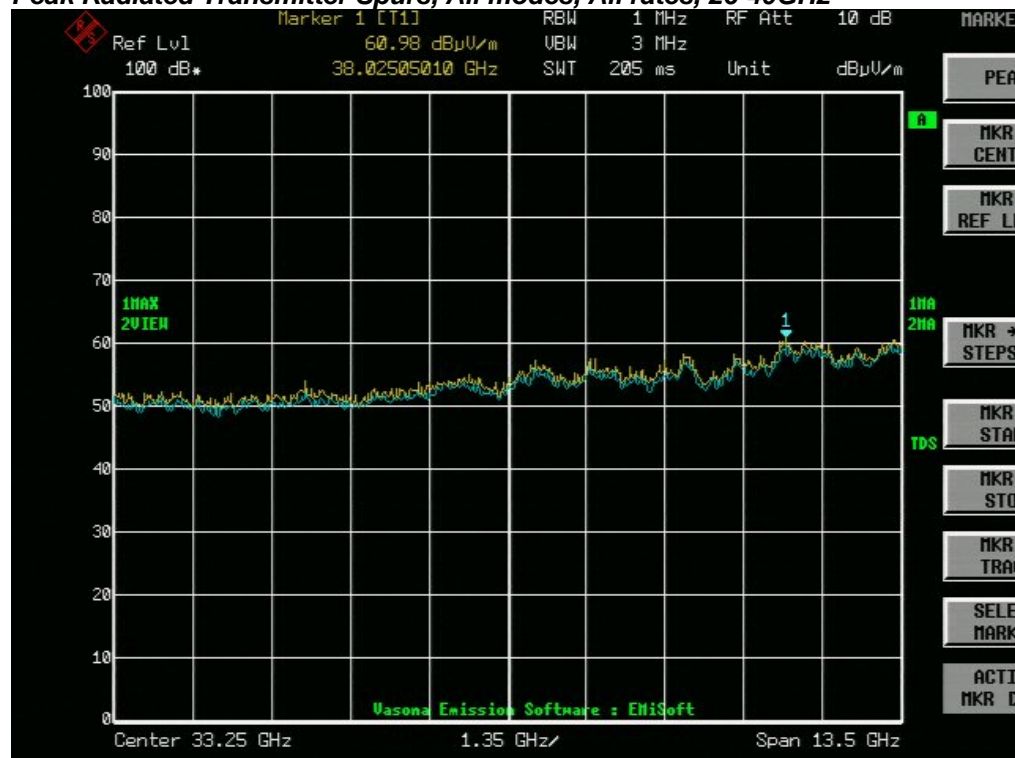

B.2 Radiated Emissions 30MHz to 1GHz

FCC 15.209 / 15.205 / 15.407 Radiated emissions which fall in the restricted bands, as defined in Section 15.205(a), must also comply with the radiated emission limits specified in Section 15.209(a) (see Section 15.205(c)).

Ref. ANSI C63.10: 2013 section 6.5

Using Vasona, configure the spectrum analyzer as shown below (be sure to enter all losses between the transmitter output and the spectrum analyzer). Place the radio in continuous transmit mode.

| | |
|-----------------------|-------------------------------|
| Span: | 30MHz – 1GHz |
| Reference Level: | 80 dBuV |
| Attenuation: | 10 dB |
| Sweep Time: | Coupled |
| Resolution Bandwidth: | 100kHz |
| Video Bandwidth: | 300kHz |
| Detector: | Peak for Pre-scan, Quasi-Peak |

Compliance shall be determined using CISPR quasi-peak detection; however, peak detection is permitted as an alternative to quasi-peak detection.

Terminate the access Point RF ports with 50 ohm loads.

Maximize Turntable (find worst case table angle), Maximize Antenna (find worst case height)

This report represents the worst case data for all supported operating modes and antennas.

| System Number | Description | Samples | System under test | Support equipment |
|---------------|-------------|---------|-------------------------------------|-------------------------------------|
| 2 | EUT | S03 | <input checked="" type="checkbox"/> | <input type="checkbox"/> |
| | Support | S04 | <input type="checkbox"/> | <input checked="" type="checkbox"/> |

| | |
|------------------------------------|--|
| Tested By : Jose Aguirre | Date of testing: 20-April-16 - 08-Aug-16 |
| Test Result : PASS | |

See Appendix C for list of test equipment

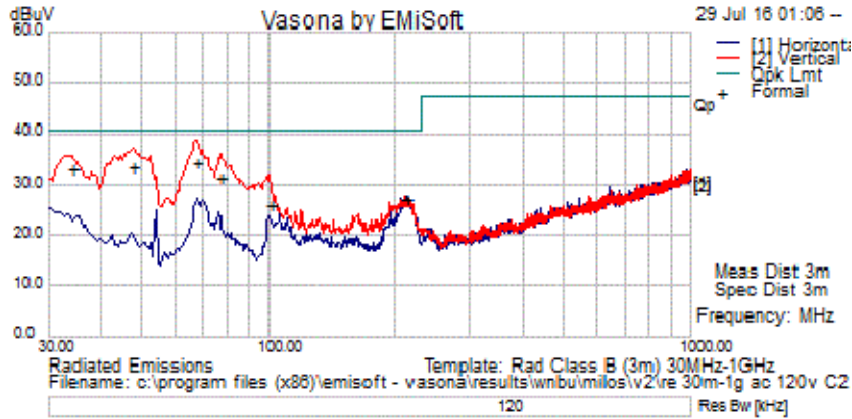

Test Results Table

| Frequency (MHz) | Raw (dBuV) | Cable Loss | AF (dB) | Level (dBuV/m) | Measurement Type | Poi | Hgt (cm) | Azt (Deg) | Limit (dBuV/m) | Margin (dB) | Pass/Fail | Comments |
|-----------------|------------|------------|---------|----------------|------------------|-----|----------|-----------|----------------|-------------|-----------|----------|
| 34.24375 | 14.29 | 0.69 | 17.95 | 32.93 | Quasi Max | H | 105 | 12 | 40.50 | -7.57 | Pass | |
| 47.58125 | 24.03 | 0.80 | 8.83 | 33.66 | Quasi Max | H | 113 | 36 | 40.50 | -6.84 | Pass | |
| 212.48125 | 14.97 | 1.77 | 10.50 | 27.24 | Quasi Max | V | 117 | 182 | 40.50 | -13.26 | Pass | |
| 100.325 | 14.43 | 1.20 | 10.39 | 26.02 | Quasi Max | H | 233 | 244 | 40.50 | -14.48 | Pass | |
| 66.98125 | 25.03 | 1.00 | 8.26 | 34.29 | Quasi Max | H | 113 | 292 | 40.50 | -6.21 | Pass | |
| 76.68125 | 22.45 | 1.06 | 8.19 | 31.70 | Quasi Max | H | 128 | 344 | 40.50 | -8.80 | Pass | |

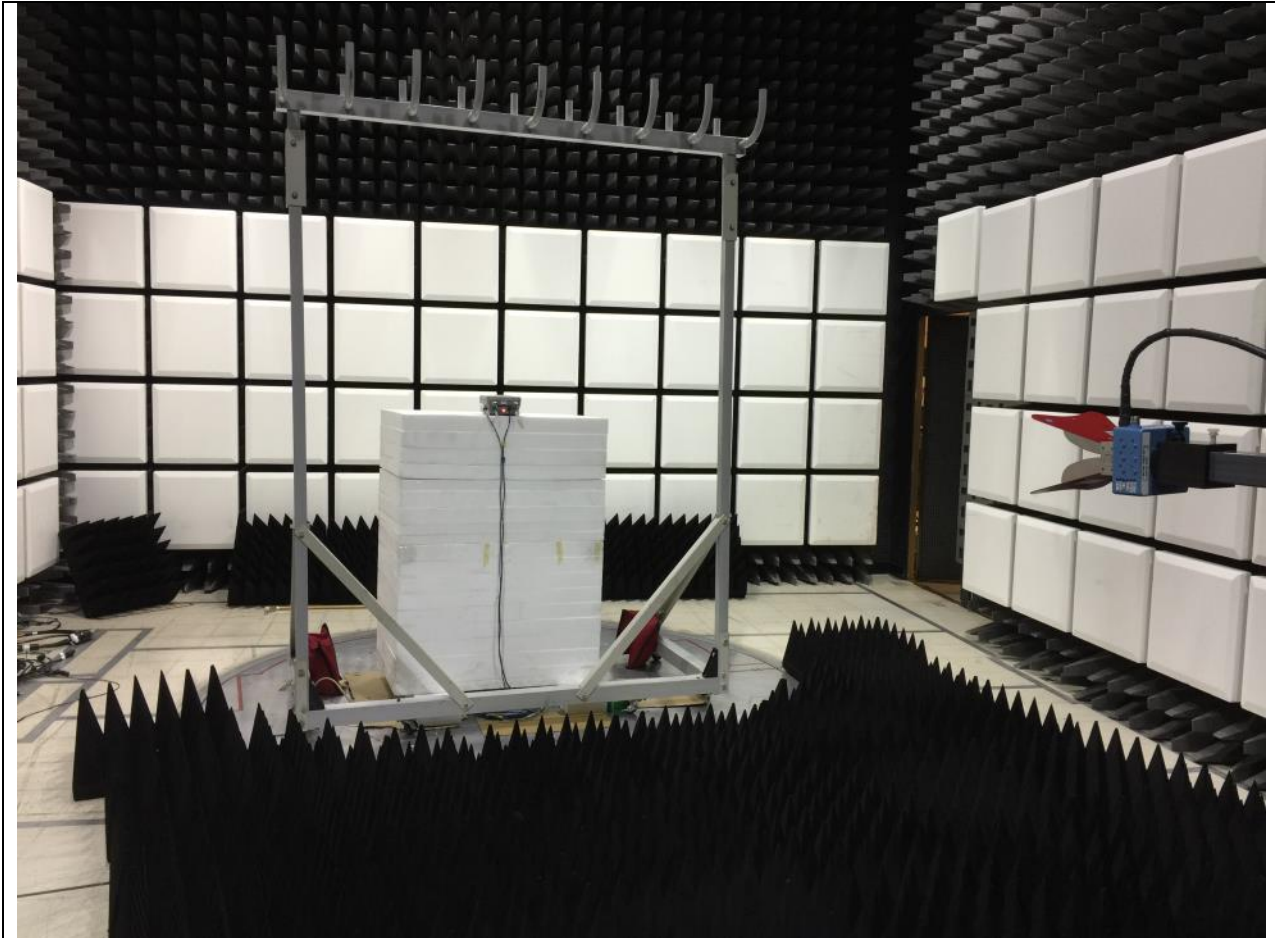

Title: Radiated Emissions Configuration Photograph

B.3 AC Conducted Emissions

FCC 15.207 Except when the requirements applicable to a given device state otherwise, for any radio apparatus equipped to operate from the public utility AC power supply, either directly or indirectly (such as with a battery charger), the radio frequency voltage of emissions conducted back onto the AC power lines in the frequency range of 0.15 MHz to 30 MHz shall not exceed the limits shown in the table in these sections. The more stringent limit applies at the frequency range boundaries.

Measurement Procedure
Accordance with ANSI C63.10:2013 section 6.2

Using Vasona, configure the spectrum analyzer as shown below (be sure to enter all losses between the transmitter output and the spectrum analyzer). Place the radio in continuous transmit mode.

| | |
|-----------------------|----------------------|
| Span: | 150 KHz – 30 MHz |
| Attenuation: | 10 dB |
| Sweep Time: | Coupled |
| Resolution Bandwidth: | 9 KHz |
| Video Bandwidth: | 30 KHz |
| Detector: | Quasi-Peak / Average |

| System Number | Description | Samples | System under test | Support equipment |
|---------------|-------------|---------|-------------------------------------|-------------------------------------|
| 2 | EUT | S03 | <input checked="" type="checkbox"/> | <input type="checkbox"/> |
| | Support | S04 | <input type="checkbox"/> | <input checked="" type="checkbox"/> |

| | |
|------------------------------------|--|
| Tested By : Jose Aguirre | Date of testing: 20-April-16 - 08-Aug-16 |
| Test Result : PASS | |

See Appendix C for list of test equipment

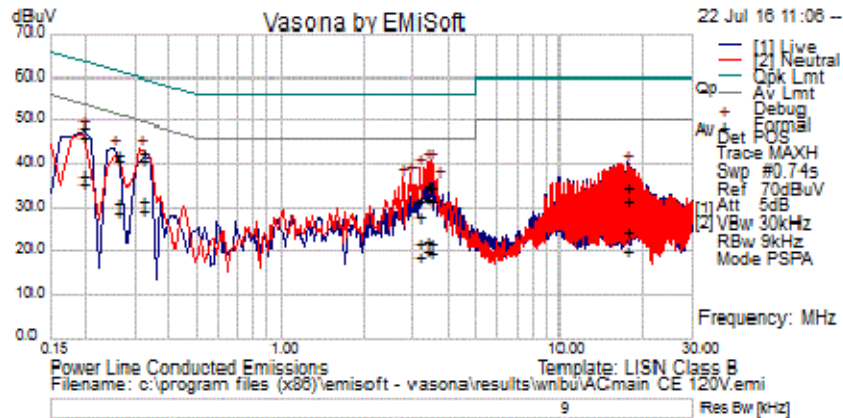

Test Results Table

| Frequency (MHz) | Raw (dBuV) | Cable Loss | Factors (dB) | Level (dBuV/m) | Measurement Type | Line | Limit (dBuV/m) | Margin (dB) | Pass/Fail | Comments |
|-----------------|------------|------------|--------------|----------------|------------------|---------|----------------|-------------|-----------|----------|
| .318 | 22.63 | 20.28 | 0.04 | 42.96 | Quasi Peak | Live | 59.76 | -16.80 | Pass | |
| 3.446 | 14.92 | 19.99 | 0.05 | 34.95 | Quasi Peak | Live | 56.00 | -21.05 | Pass | |
| 3.135 | 11.83 | 19.98 | 0.06 | 31.86 | Quasi Peak | Live | 56.00 | -24.14 | Pass | |
| .195 | 27.83 | 20.78 | 0.05 | 48.66 | Quasi Peak | Live | 63.82 | -15.16 | Pass | |
| 17.358 | 14.25 | 20.33 | 0.19 | 34.77 | Quasi Peak | Live | 60.00 | -25.23 | Pass | |
| 3.350 | 15.24 | 19.98 | 0.05 | 35.27 | Quasi Peak | Live | 56.00 | -20.73 | Pass | |
| .261 | 21.84 | 20.48 | 0.04 | 42.36 | Quasi Peak | Live | 61.40 | -19.04 | Pass | |
| 3.446 | 11.71 | 19.99 | 0.05 | 31.75 | Quasi Peak | Neutral | 56.00 | -24.25 | Pass | |
| .195 | 25.78 | 20.78 | 0.05 | 46.61 | Quasi Peak | Neutral | 63.82 | -17.21 | Pass | |
| 3.350 | 11.97 | 19.98 | 0.05 | 32.01 | Quasi Peak | Neutral | 56.00 | -23.99 | Pass | |
| 3.135 | 8.12 | 19.98 | 0.06 | 28.16 | Quasi Peak | Neutral | 56.00 | -27.84 | Pass | |
| .261 | 20.21 | 20.48 | 0.04 | 40.73 | Quasi Peak | Neutral | 61.40 | -20.67 | Pass | |
| 17.358 | 4.23 | 20.33 | 0.19 | 24.75 | Quasi Peak | Neutral | 60.00 | -35.25 | Pass | |
| .318 | 20.63 | 20.28 | 0.04 | 40.95 | Quasi Peak | Neutral | 59.76 | -18.81 | Pass | |
| .318 | 11.54 | 20.28 | 0.04 | 31.87 | Average | Live | 49.76 | -17.89 | Pass | |
| 3.446 | 1.77 | 19.99 | 0.05 | 21.81 | Average | Live | 46.00 | -24.19 | Pass | |
| 3.135 | 1.82 | 19.98 | 0.06 | 21.86 | Average | Live | 46.00 | -24.14 | Pass | |
| .195 | 17.05 | 20.78 | 0.05 | 37.87 | Average | Live | 53.82 | -15.95 | Pass | |
| 17.358 | 11.08 | 20.33 | 0.19 | 31.59 | Average | Live | 50.00 | -18.41 | Pass | |
| 3.350 | 2.45 | 19.98 | 0.05 | 22.49 | Average | Live | 46.00 | -23.51 | Pass | |
| .261 | 10.69 | 20.48 | 0.04 | 31.21 | Average | Live | 51.40 | -20.19 | Pass | |
| 3.446 | -0.15 | 19.99 | 0.05 | 19.89 | Average | Neutral | 46.00 | -26.11 | Pass | |
| .195 | 14.85 | 20.78 | 0.05 | 35.68 | Average | Neutral | 53.82 | -18.14 | Pass | |
| 3.350 | 0.12 | 19.98 | 0.05 | 20.16 | Average | Neutral | 46.00 | -25.84 | Pass | |
| 3.135 | -1.39 | 19.98 | 0.06 | 18.64 | Average | Neutral | 46.00 | -27.36 | Pass | |
| .261 | 8.30 | 20.48 | 0.04 | 28.82 | Average | Neutral | 51.40 | -22.58 | Pass | |



| Frequency (MHz) | Raw (dBuV) | Cable Loss | Factors (dB) | Level (dBuV/m) | Measurement Type | Line | Limit (dBuV/m) | Margin (dB) | Pass/Fail | Comments |
|-----------------|------------|------------|--------------|----------------|------------------|---------|----------------|-------------|-----------|----------|
| 17.358 | -0.50 | 20.33 | 0.19 | 20.02 | Average | Neutral | 50.00 | -29.98 | Pass | |
| .318 | 9.08 | 20.28 | 0.04 | 29.41 | Average | Neutral | 49.76 | -20.35 | Pass | |



Title: Conducted Emissions Configuration Photograph

This is a dual band 2.4GHz / 5GHz device. All ports in this test set up photo are connected as all testing is automated. Section 2.6 of this test report given an overview of the different Tx antenna combinations used by this device.

Appendix C: List of Test Equipment Used to perform the test

| Test Equipment used for Radiated Emissions | | | | | |
|--|-------------------------------------|---|------------------|-----------|---------------|
| Equip# | Manufacturer/ Model | Description | Last Cal | Next Cal | Test Item |
| CIS051796 | TTA1800-30-HG Miteq | SMA 18 GHz Pre-Amplifier | 29-Sep-15 | 29-Sep-16 | B.1, B.2 |
| CIS035285 | 3117 ETS-Lindgren | Double Ridged Waveguide Horn Antenna | 30-Sep-15 | 30-Sep-16 | B.1, B.2 |
| CIS008447 | NSA 10m Chamber Cisco | NSA 10m Chamber | 14-Oct-15 | 14-Oct-16 | B.3 |
| CIS045096 | TH0118 Cisco | Mast Mount Preamplifier Array, 1-18GHz | 4-Nov-15 | 4-Nov-16 | B.1, B.2 |
| CIS030652 | JB1 Sunol Sciences | Combination Antenna, 30MHz-2GHz | 4-Dec-15 | 4-Dec-16 | B.3 |
| CIS041929 | iBTHP-5-DB9 Newport | 5 inch Temp/RH/Press Sensor w/20ft cable | 22-Dec-15 | 22-Dec-16 | B.1, B.2, B.3 |
| CIS043124 | Above 1GHz Site Cal Cisco | Above 1GHz Cispr Site Verification | 14-Jan-16 | 14-Jan-17 | B.1, B.2 |
| CIS047300 | N9038A Agilent Technologies | MXE EMI Receiver 20Hz to 26.5 Ghz | 28-Jan-16 | 28-Jan-17 | B.1, B.2, B.3 |
| CIS051642 | Sucoflex 106PA Huber+Suhner | RF N Type Cable 8.5m | 11-Feb-16 | 11-Feb-17 | B.1, B.2, B.3 |
| CIS030559 | UFB311A-1-0950-504504 Micro-Coax | RF Coaxial Cable, to 18GHz, 95 in | 15-Feb-16 | 15-Feb-17 | B.1, B.2, B.3 |
| CIS020975 | UFB311A-0-1344-520520 Micro-Coax | RF Coaxial Cable, to 18GHz, 134.4 in | 17-Feb-16 | 17-Feb-17 | B.1, B.2, B.3 |
| CIS051708 | UFB293C-2-0840-300504 Micro-Coax | RF Coaxial SMA-N Type Cable | 28-Jun-16 | 28-Jun-17 | B.1, B.2, B.3 |
| CIS044940 | ESU40 Rohde & Schwarz | EMI Test Receiver, 20Hz-40GHz | 2-Nov-15 | 2-Nov-16 | B.1, B.2 |
| CIS034075 | RSG 2000 Schaffner | Reference Spectrum Generator, 1-18GHz | Cal Not Required | | |
| CIS041979 | 1840 Cisco | 18-40GHz EMI Test Head/ Verification Fixture | 13-Jul-15 | 13-Jul-16 | B.1, B.2 |
| CIS044940 | ESU40 Rohde & Schwarz | EMI Test Receiver, 20Hz-40GHz | 2-Nov-15 | 2-Nov-16 | B.1, B.2, |
| CIS030652 | JB1 Sunol Sciences | Combination Antenna, 30MHz-2GHz | 4-Dec-15 | 4-Dec-16 | B.3 |
| CIS003003 | 83731B HP | Synthesized Signal Generator | 29-Jan-16 | 29-Jan-17 | B.1, B.2 |
| CIS037236 | 50CB-015 JFW | GPIB Control Box | | | B.1, B.2 |

| Test Equipment used for AC Mains Conducted Emissions | | | | | |
|--|--|---|---------------------|---------------------|-----------|
| Equip# | Manufacturer/ Model | Description | Last Cal | Next Cal | Test Item |
| 8510 | Fischer Custom Communications FCC-450B-2.4-N | Instrumentation Limiter | 5/16/16 | 5/16/17 | B.4 |
| 23802 | Fischer Custom Communications FCC-801-M2-50A | CDN, 2-LINE 50A | 1/12/16 | 1/12/17 | B.4 |
| 45995 | Fischer Custom Communications F-090527-1009-2 | Lisn Adapter | 6/17/16 | 6/17/17 | B.4 |
| 49468 | Coleman RG223 | BNC 25 ft Cable | 3/9/16 | 3/9/17 | B.4 |
| 31918 | Midwest Microwave TRM-2048-MC-BNC-10 | 50 Ohm, 5W Terminator, Type BNC | 11/9/15 | 11/9/16 | B.4 |
| 49531 | TTE H785-150K-50-21378 | High Pass Filter | 5/3/16 | 5/3/17 | B.4 |
| 45994 | Fischer Custom Communications F-090527-1009-1 | Line Impedance Stabilization Network | 6/17/16 | 6/17/17 | B.4 |
| 18963 | York CNE V | Comparison Noise Emitter, 30 - 1000MHz | Cal Not Required | Cal Not Required | B.4 |
| 45050 | Rohde & Schwarz ESCI | EMI Test Receiver | 11/3/15 | 11/3/16 | B.4 |
| 51721 | Teseq CDN ST08A | Coupling Decoupling Network | 6/7/16 | 6/7/17 | B.4 |
| 54231 | Newport iBTHP-5-DB9 | 5 inch Temp/RH/Press Sensor w/20ft cable | 2/10/16 | 2/10/17 | B.4 |

| Test Equipment used for RF Conducted Tests | | | | | |
|--|-------------------------------------|--|-----------|-----------|------------|
| Equip# | Manufacturer/ Model | Description | Last Cal | Next Cal | Test Item |
| CIS054666 | RA08-S1S1-18 MegaPhase | SMA 18" Cable | 25-Sep-15 | 25-Sep-16 | A1 thru A7 |
| CIS054667 | RA08-S1S1-18 MegaPhase | SMA 18" Cable | 25-Sep-15 | 25-Sep-16 | A1 thru A7 |
| CIS054668 | RA08-S1S1-18 MegaPhase | SMA 18" Cable | 25-Sep-15 | 25-Sep-16 | A1 thru A7 |
| CIS054669 | RA08-S1S1-18 MegaPhase | SMA 18" Cable | 25-Sep-15 | 25-Sep-16 | A1 thru A7 |
| CIS054686 | NI PXI-2796 National Instruments | Plug-in switch module | 6-Oct-15 | 6-Oct-16 | A1 thru A7 |
| CIS055166 | RFLT4WDC40GK RF Lambda | 4 Way Power Divider 40GHz | 23-Nov-15 | 23-Nov-16 | A1 thru A7 |
| CIS054662 | RFLT4WDC40GK RF Lambda | SMA 36" cable | 24-Sep-15 | 24-Sep-16 | A1 thru A7 |
| CIS054656 | BRC50705-02 Micro-Tronics | Band Reject Filter | 24-Sep-15 | 24-Sep-16 | A1 thru A7 |
| CIS054655 | BRC50704-02 Micro-Tronics | Notch Filter, SB:5.470-5.725GHz, to 12GHz | 24-Sep-15 | 24-Sep-16 | A1 thru A7 |
| CIS054654 | BRC50703-02 | Notch Filter, | 24-Sep-15 | 24-Sep-16 | A1 thru A7 |

| | | | | | |
|-----------|-------------------------------------|--|------------------|-----------|------------|
| | Micro-Tronics | SB:5.150-5.350GHz, to 11GHz | | | |
| CIS054653 | BRM50702-02 Micro-Tronics | Notch Filter, SB:2.400-2.500GHz, to 18GHz | 24-Sep-15 | 24-Sep-16 | A1 thru A7 |
| CIS054678 | RA08-S1S1-12 MegaPhase | SMA 12" Cable | 25-Sep-15 | 25-Sep-16 | A1 thru A7 |
| CIS054677 | RA08-S1S1-12 MegaPhase | SMA 12" Cable | 25-Sep-15 | 25-Sep-16 | A1 thru A7 |
| CIS054676 | RA08-S1S1-12 MegaPhase | SMA 12" Cable | 25-Sep-15 | 25-Sep-16 | A1 thru A7 |
| CIS054675 | RA08-S1S1-12 MegaPhase | SMA 12" Cable | 25-Sep-15 | 25-Sep-16 | A1 thru A7 |
| CIS054674 | RA08-S1S1-12 MegaPhase | SMA 12" Cable | 25-Sep-15 | 25-Sep-16 | A1 thru A7 |
| CIS054673 | RA08-S1S1-12 MegaPhase | SMA 12" Cable | 25-Sep-15 | 25-Sep-16 | A1 thru A7 |
| CIS054672 | RA08-S1S1-12 MegaPhase | SMA 12" Cable | 25-Sep-15 | 25-Sep-16 | A1 thru A7 |
| CIS054671 | RA08-S1S1-12 MegaPhase | SMA 12" Cable | 25-Sep-15 | 25-Sep-16 | A1 thru A7 |
| CIS054670 | RA08-S1S1-12 MegaPhase | SMA 12" Cable | 25-Sep-15 | 25-Sep-16 | A1 thru A7 |
| CIS054664 | GC12-8181-16 MegaPhase | SMA 16" Cable | 25-Sep-15 | 25-Sep-16 | A1 thru A7 |
| CIS054663 | F120-S1S1-48 MegaPhase | SMA 48" Cable | 25-Sep-15 | 25-Sep-16 | A1 thru A7 |
| CIS054686 | NI PXI-2796 National Instruments | Plug-in switch module | 6-Oct-15 | 6-Oct-16 | A1 thru A7 |
| CIS042005 | BWS30W2+ Mini-Circuits | SMA 30dB Attenuator | 16-Oct-15 | 16-Oct-16 | A1 thru A7 |
| CIS041995 | BW-S6W2 Mini-Circuits | 6dB Attenuator | 16-Oct-15 | 16-Oct-16 | A1 thru A7 |
| CIS054695 | D3C2060 Ditom | Circulator | 20-Oct-15 | 20-Oct-16 | A1 thru A7 |
| CIS055146 | RA08-S1S1-12 Megaphase | 12" SMA Cable | 17-Nov-15 | 17-Nov-16 | A1 thru A7 |
| CIS050721 | N9030A Keysight | PXA Signal Analyzer | 30-Mar-16 | 30-Mar-17 | A1 thru A7 |
| CIS054303 | N5182B Keysight | MXG X-Series RF Vector Signal Generator | 6-Apr-16 | 6-Apr-17 | A1 thru A7 |
| CIS055358 | ZFSC-2-10G Mini-Circuits | Splitter | 11-Apr-16 | 11-Apr-17 | A1 thru A7 |
| CIS055099 | SMART2200RM2U Tripp-Lite | Power Supply | Cal Not Required | | A1 thru A7 |
| CIS055094 | PXI-1042 National Instruments | Chassis | Cal Not Required | | A1 thru A7 |

Appendix E: Abbreviation Key and Definitions

The following table defines abbreviations used within this test report.

| Abbreviation | Description | Abbreviation | Description |
|--------------|--|--------------|-------------------------------------|
| EMC | Electro Magnetic Compatibility | °F | Degrees Fahrenheit |
| EMI | Electro Magnetic Interference | °C | Degrees Celsius |
| EUT | Equipment Under Test | Temp | Temperature |
| ITE | Information Technology Equipment | S/N | Serial Number |
| TAP | Test Assessment Schedule | Qty | Quantity |
| ESD | Electro Static Discharge | emf | Electromotive force |
| EFT | Electric Fast Transient | RMS | Root mean square |
| EDCS | Engineering Document Control System | Qp | Quasi Peak |
| Config | Configuration | Av | Average |
| CIS# | Cisco Number (unique identification number for Cisco test equipment) | Pk | Peak |
| Cal | Calibration | kHz | Kilohertz (1×10^3) |
| EN | European Norm | MHz | MegaHertz (1×10^6) |
| IEC | International Electro technical Commission | GHz | Gigahertz (1×10^9) |
| CISPR | International Special Committee on Radio Interference | H | Horizontal |
| CDN | Coupling/Decoupling Network | V | Vertical |
| LISN | Line Impedance Stabilization Network | dB | decibel |
| PE | Protective Earth | V | Volt |
| GND | Ground | kV | Kilovolt (1×10^3) |
| L1 | Line 1 | μ V | Microvolt (1×10^{-6}) |
| L2 | Line2 | A | Amp |
| L3 | Line 3 | μ A | Micro Amp (1×10^{-6}) |
| DC | Direct Current | mS | Milli Second (1×10^{-3}) |
| RAW | Uncorrected measurement value, as indicated by the measuring device | μ S | Micro Second (1×10^{-6}) |
| RF | Radio Frequency | μ S | Micro Second (1×10^{-6}) |
| SLCE | Signal Line Conducted Emissions | m | Meter |
| Meas dist | Measurement distance | Spec dist | Specification distance |
| N/A or NA | Not Applicable | SL | Signal Line (or Telecom Line) |
| P | Power Line | L | Live Line |
| N | Neutral Line | R | Return |
| S | Supply | AC | Alternating Current |

End