

Test Report

AIR-AP1562E-x-K9 (x=A,B,D,N,T,Z)

Cisco Aironet 802.11ac Dual Band Outdoor Access Points

FCC ID: LDK102103
IC: 2461B-102103

2400-2483.5 MHz

Against the following Specifications:

- CFR47 Part 15.247
- RSS-247
- RSS-Gen
- AS/NZS 4268
- LP0002
- G.S.R 45 (E)

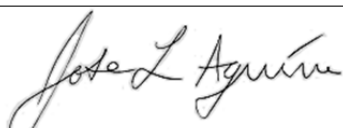
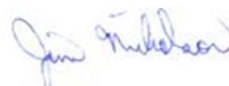

Cisco Systems
170 West Tasman Drive
San Jose, CA 95134

	
Author: Jose Aguirre Tested By:	Approved By: Jim Nicholson Title: Technical Leader, Engineering Revision: 3

This report replaces any previously entered test report under EDCS – 11346264. This test report has been electronically authorized and archived using the CISCO Engineering Document Control system.



This test report has been electronically authorized and archived using the CISCO Engineering Document Control system.

SECTION 1: OVERVIEW4

SECTION 2: ASSESSMENT INFORMATION5

 2.1 GENERAL5

 2.2 DATE OF TESTING7

 2.3 REPORT ISSUE DATE7

 2.4 TESTING FACILITIES7

 2.5 EQUIPMENT ASSESSED (EUT)7

 2.6 EUT DESCRIPTION8

SECTION 3: RESULT SUMMARY10

 3.1 RESULTS SUMMARY TABLE10

SECTION 4: SAMPLE DETAILS12

 4.1 SAMPLE DETAILS12

 4.2 SYSTEM DETAILS12

 4.3 MODE OF OPERATION DETAILS12

APPENDIX A: EMISSION TEST RESULTS13

 CONDUCTED TEST SETUP DIAGRAM13

 TARGET MAXIMUM CHANNEL POWER13

 Antenna Gain: 4 dBi13

 Antenna Gain: 5 dBi14

 Antenna Gain: 6 dBi14

 Antenna Gain: 8 dBi15

 Antenna Gain: 13 dBi15

 A.1 6dB BANDWIDTH16

 A.2 99% AND 26dB BANDWIDTH26

 A.3 MAXIMUM CONDUCTED OUTPUT POWER36

 Antenna Gain: 4 dBi37

 Antenna Gain: 5 dBi40

 Antenna Gain: 6 dBi43

 Antenna Gain: 8 dBi46

 Antenna Gain: 13 dBi49

 A.4 POWER SPECTRAL DENSITY52

 A.5 CONDUCTED SPURIOUS EMISSIONS62

 Antenna Gain: 13 dBi65

 Antenna Gain: 13 dBi68

 A.6 CONDUCTED BANDEDGE (NON-RESTRICTED BAND)72

 Antenna Gain: 4 dBi74

 Antenna Gain: 5 dBi77

 Antenna Gain: 6 dBi80

 Antenna Gain: 8 dBi83

 Antenna Gain: 13 dBi86

 Antenna Gain: 4 dBi89

 Antenna Gain: 5 dBi92



Antenna Gain: 6 dBi95
Antenna Gain: 8 dBi98
Antenna Gain: 13 dBi101
A.7 CONDUCTED BANDEDGE (RESTRICTED BAND)104
APPENDIX B: EMISSION TEST RESULTS110
RADIATED EMISSION SETUP DIAGRAM-BELOW 1G.....110
B.1 RADIATED SPURIOUS EMISSIONS111
B.2 RECEIVER SPURIOUS EMISSIONS132
B.3 RADIATED EMISSIONS 30MHZ TO 1GHZ135
B.4 AC CONDUCTED EMISSIONS138
APPENDIX C: LIST OF TEST EQUIPMENT USED TO PERFORM THE TEST142
APPENDIX E: ABBREVIATION KEY AND DEFINITIONS145

Section 1: Overview

The samples were assessed against the tests under the requirements of the following specifications:

Emission
CFR47 Part 15.247 RSS247 Issue 1: May 2015 RSS-Gen Issue 4: Nov 2014

Measurements were made in accordance with

- ANSI C63.10:2013
- FCC KDB 662911 D01 v02r01
- KDB 558074 D01 Meas Guidance v03r05

Section 2: Assessment Information

2.1 General

This report contains an assessment of an apparatus against Electromagnetic Compatibility Standards based upon tests carried out on the samples submitted. The testing was performed by and for the use of Cisco systems Inc:

With regard to this assessment, the following points should be noted:

- a) The results contained in this report relate only to the items tested and were obtained in the period between the date of the initial assessment and the date of issue of the report. Manufactured products will not necessarily give identical results due to production and measurement tolerances.
- b) The apparatus was set up and exercised using the configuration and modes of operation defined in this report only.
- c) Where relevant, the apparatus was only assessed using the susceptibility criteria defined in this report and the Test Assessment Plan (TAP).
- d) All testing was performed under the following environmental conditions:

Temperature	15°C to 35°C (54°F to 95°F)
Atmospheric Pressure	860mbar to 1060mbar (25.4" to 31.3")
Humidity	10% to 75*%

*[Where applicable] For ESD testing the humidity limits used were 30% to 60% and for EFT/B tests the humidity limits used were 25% to 75%.
- e) All AC testing was performed at one or more of the following supply voltages:
110V 60 Hz (+/-20%)

Units of Measurement

The units of measurements defined in the appendices are reported in specific terms, which are test dependent. Where radiated measurements are concerned these are defined at a particular distance. Basic voltage measurements are defined in units of [dBuV]

As an example, the basic calculation for all measurements is as follows:

$$\text{Emission level [dBuV]} = \text{Indicated voltage level [dBuV]} + \text{Cable Loss [dB]} + \text{Other correction factors [dB]}$$

The combinations of correction factors are dependent upon the exact test configurations [see test equipment lists for further details] and may include:-

Antenna Factors, Pre Amplifier Gain, LISN Loss, Pulse Limiter Loss and Filter Insertion Loss..

Note: to convert the results from dBuV/m to uV/m use the following formula:-

$$\text{Level in uV/m} = \text{Common Antilogarithm} [(X \text{ dBuV/m})/20] = Y \text{ uV/m}$$

Measurement Uncertainty Values

voltage and power measurements	± 2 dB
conducted EIRP measurements	± 1.4 dB
radiated measurements	± 3.2 dB
frequency measurements	± 2.4 10 ⁻⁷
temperature measurements	± 0.54°
humidity measurements	± 2.3%
DC and low frequency measurements	± 2.5%

Where relevant measurement uncertainty levels have been estimated for tests performed on the apparatus. This uncertainty represents an expanded uncertainty expressed at approximately the 95% confidence level using a coverage factor of k=2.

Radiated emissions (expanded uncertainty, confidence interval 95%)

30 MHz - 300 MHz	+/- 3.8 dB
300 MHz - 1000 MHz	+/- 4.3 dB
1 GHz - 10 GHz	+/- 4.0 dB
10 GHz - 18GHz	+/- 8.2 dB
18GHz - 26.5GHz	+/- 4.1 dB
26.5GHz - 40GHz	+/- 3.9 dB

Conducted emissions (expanded uncertainty, confidence interval 95%)

30 MHz – 40GHz	+/- 0.38 dB
----------------	-------------

A product is considered to comply with a requirement if the nominal measured value is below the limit line. The product is considered to not be in compliance in case the nominal measured value is above the limit line.

This report must not be reproduced except in full, without written approval of Cisco Systems.

2.2 Date of testing

20-April-16 - 08-Aug-16

2.3 Report Issue Date

23-August-2016

Cisco uses an electronic system to issue, store and control the revision of test reports. This system is called the Engineering Document Control System (EDCS). The actual report issue date is embedded into the original file on EDCS. Any copies of this report, either electronic or paper, that are not on EDCS must be considered uncontrolled.

2.4 Testing facilities

This assessment was performed by:

Testing Laboratory

Cisco Systems, Inc.,
125 West Tasman Drive
San Jose, CA 95134, USA

Registration Numbers for Industry Canada

Cisco System Site	Address	Site Identifier
Building P, 10m Chamber	125 West Tasman Dr San Jose, CA 95134	Company #: 2461N-2
Building P, 5m Chamber	125 West Tasman Dr San Jose, CA 95134	Company #: 2461N-1
Building I, 5m Chamber	285 W. Tasman Drive San Jose, California 95134	Company #: 2461M-1

Test Engineers

Jose Aguirre

2.5 Equipment Assessed (EUT)

AIR-AP1562E-A-K9

2.6 EUT Description

The Cisco Aironet 802.11ac Dual Band Access Points support the following modes of operation. The modes are further defined in the radio Theory of Operation. The modes included in this report represent the worst case data for all modes. Data is recorded at the lowest supported data rate for each mode. This report covers operation on channel 1-11.

802.11n/ac - Legacy CCK, One Antenna, 1 to 11 Mbps

802.11n/ac - Legacy CCK, Two Antennas, 1 to 11 Mbps

802.11n/ac-Non HT20 Beam Forming, Two Antenna, 6-54 Mbps

802.11n/ac - Non HT20, One Antenna, 6 to 54 Mbps

802.11n/ac - Non HT20, Two Antennas, 6 to 54 Mbps

802.11n/ac - HT/VHT20, One Antenna, M0 to M7

802.11n/ac - HT/VHT20, Two Antennas, M0 to M7

802.11n/ac - HT/VHT20, Two Antennas, M8 to M15

802.11n/ac - HT/VHT20 Beam Forming, Two Antennas, M0 to M7

802.11n/ac - HT/VHT20 Beam Forming, Two Antennas, M8 to M15

802.11n/ac - HT/VHT20 STBC, Two Antennas, M0 to M7

802.11n/ac - Non HT40 Duplicate, One Antenna, 6 to 54 Mbps

802.11n/ac - Non HT40 Duplicate, Two Antennas, 6 to 54 Mbps

802.11n/ac - HT/VHT40, One Antenna, M0 to M7

802.11n/ac - HT/VHT40, Two Antennas, M0 to M7

802.11n/ac - HT/VHT40, Two Antennas, M8 to M15

802.11n/ac - HT/VHT40 Beam Forming, Two Antennas, M0 to M7

802.11n/ac - HT/VHT40 Beam Forming, Two Antennas, M8 to M15

802.11n/ac - HT/VHT40 STBC, Two Antennas, M0 to M7

The following antennas are supported by this product series.
The data included in this report represent the worst case data for all antennas.

Frequency	Part Number	Antenna Type	Antenna Gain (dBi)
2.4 GHz	AIR-ANT2450V-N	Single Band Omni	5
	AIR-ANT2480V-N	Single Band Omni	8
	AIR-ANT2450HG-N	Horizontal Polarized Omni	5
	AIR-ANT2450VG-N	Vertical Polarized Omni	5
	AIR-ANT2413P2M-N	Single Band, Dual Polarized Directional Patch	13
2.4 GHz	AIR-ANT2547V-N=	Dual-band Omni	4
	AIR-ANT2547VG-N=	Dual-band Omni, Gray	4
	AIR-ANT2568VG-N	Dual-band Omni	6
	AIR-ANT2588P3M-N=	Dual-band/Dual Polarized Directional, Patch	8
	AIR-ANT2513P4M-N	Dual-band Polarization Diverse Patch Array	13

Section 3: Result Summary

3.1 Results Summary Table

Conducted emissions

Basic Standard	Technical Requirements / Details	Result
FCC 15.247 RSS-247 LP0002:3.10.1(6.2.1)	6dB Bandwidth: Systems using digital modulation techniques may operate in the 2400-2483.5MHz band. The minimum 6dB bandwidth shall be at least 500 kHz.	Pass
FCC 15.247 RSS-247	99% & 26 dB Bandwidth: The 99% occupied bandwidth is the frequency bandwidth such that, below its lower and above its upper frequency limits, the mean powers are each equal to 0.5% of the total mean power of the given emission. There is no limit for 99% OBW. The 26 dB emission is the width of the emission that is constrained by the frequencies associated with the two outermost amplitude points (upper and lower frequencies) that are attenuated by 26 dB relative to the maximum level measured in the fundamental emission.	Pass
FCC 15.247 RSS-247 LP0002:3.10.1(2.3)	Output Power: 15.247 The maximum conducted output power of the intentional radiator for systems using digital modulation in the 2400-2483.5 MHz band shall not exceed 1 Watt (30dBm). If transmitting antennas of directional gain greater than 6 dBi are used, the maximum conducted output power shall be reduced by the amount in dB that the directional gain of the antenna exceeds 6 dBi. RSS-247 For DTSs employing digital modulation techniques operating in the band 2400-2483.5 MHz, the maximum peak conducted output power shall not exceed 1W. Except as provided in Section 5.4(5), the e.i.r.p. shall not exceed 4 W.	Pass
FCC 15.247 RSS-247 LP0002:3.10.1(6.2.2)	Power Spectral Density: For digitally modulated systems, the power spectral density conducted from the intentional radiator to the antenna shall not be greater than 8 dBm in any 3 kHz band during any time interval of continuous transmission.	Pass
FCC 15.247 RSS-247 LP0002:3.10.1(5)/2.8	Conducted Spurious Emissions / Band-Edge: In any 100 kHz bandwidth outside the frequency band in which the spread spectrum or digitally modulated intentional radiator is operating, the radio frequency power that is produced by the intentional radiator shall be at least 20 dB below that in the 100 kHz bandwidth within the band that contains the highest level of the desired power, based on either an RF conducted or a radiated measurement, provided the transmitter demonstrates compliance with the peak conducted power limits. If the transmitter complies with the conducted power limits based on the use of RMS averaging over a time interval, as permitted under paragraph (b)(3) of this section, the attenuation required under this paragraph shall be 30 dB instead of 20 dB. Attenuation below the general limits specified in §15.209(a) is not required	Pass
FCC 15.247 RSS-247 FCC 15.205 RSS-Gen	Restricted band: Unwanted emissions falling within the restricted bands, as defined in FCC 15.205 (a) and RSS-Gen 8.10 must also comply with the radiated emission limits specified in FCC 15.209 (a) and RSS-Gen 8.9.	Pass



Radiated Emissions (General requirements)

Basic Standard	Technical Requirements / Details	Result
FCC 15.209 RSS-Gen LP0002:3.10.1(5)/2.8	<p>TX Spurious Emissions: Except as provided elsewhere in this subpart, the emissions from an intentional radiator shall not exceed the field strength levels specified in the filed strength limits table in this section. Unwanted emissions falling within the restricted bands, as defined in FCC 15.205 (a) and RSS-Gen 8.10 must also comply with the radiated emission limits specified in FCC 15.209 (a) and RSS-Gen 8.9.</p>	Pass
RSS-Gen LP0002:3.10.1(5)2.8	<p>RX Spurious Emissions: RSS-Gen 8.9 Except when the requirements applicable to a given device state otherwise, emissions from licence-exempt transmitters shall comply with the field strength limits shown in Table 4 and Table 5 below. Additionally, the level of any transmitter emission shall not exceed the level of the transmitter's fundamental emission. RSS-Gen 8.10 Unwanted emissions that fall into restricted bands of Table 6 shall comply with the limits specified in RSS-Gen; and (c) Unwanted emissions that do not fall within the restricted frequency bands of Table 6 shall comply either with the limits specified in the applicable RSS or with those specified in this RSS-Gen.</p>	Pass
FCC 15.207 RSS-Gen LP0002:2.3	<p>AC conducted Emissions: Except when the requirements applicable to a given device state otherwise, for any radio apparatus equipped to operate from the public utility AC power supply, either directly or indirectly (such as with a battery charger), the radio frequency voltage of emissions conducted back onto the AC power lines in the frequency range of 0.15 MHz to 30 MHz shall not exceed the limits shown in the table in these sections. The more stringent limit applies at the frequency range boundaries.</p>	Pass

* MPE calculation is recorded in a separate report

Section 4: Sample Details

Note: Each sample was evaluated to ensure that its condition was suitable to be used as a test sample prior to the commencement of testing.

4.1 Sample Details

Sample No.	Equipment Details	Manufacturer	Hardware Rev.	Firmware Rev.	Software Rev.	Serial Number
S01	AIR-AP1562E-A-K9	Cisco Systems	P2	9.1.8.1	9.0.5.5-W8964	RFDP2BML083
S02*	AIR-PWRADPT-RGD1	Meanwell	A0	NA	NA	EB3F71752

(*) S02 is support equipment Power supply for EUT S01

4.2 System Details

System #	Description	Samples
1	AIR-AP1562E-A-K9	S01
2	AIR-PWRADPT-RGD1	S02

4.3 Mode of Operation Details

Mode#	Description	Comments
1	Continuous Transmitting	Continuous Transmitting $\geq 98\%$ duty cycle

Measurements were made in accordance with

- ANSI C63.10:2013
- FCC KDB 662911 D01 v02r01
- KDB 558074 D01 Meas Guidance v03r05

Appendix A: Emission Test Results

Conducted Test Setup Diagram

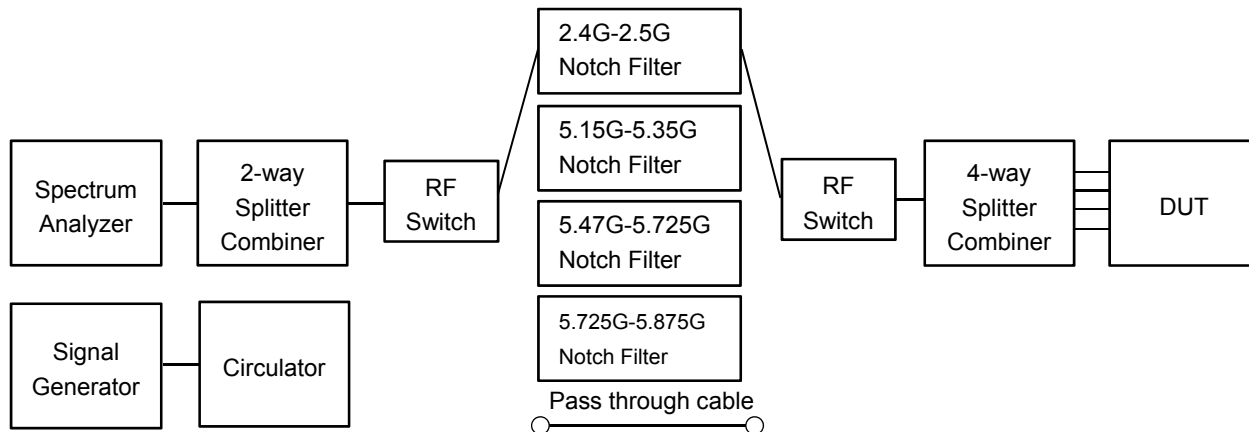

Target Maximum Channel Power

The following table details the maximum supported Total Channel Power for all operating modes.

Antenna Gain: 4 dBi

Operating Mode	Maximum Channel Power (dBm EIRP)		
	Frequency (MHz)		
	2412	2437	2462
Legacy CCK, 1 to 11 Mbps	30	31	30
Non HT20, 6 to 54 Mbps	28	31	26
Non HT20 Beam Forming, 6 to 54 Mbps	30	34	24
HT/VHT20, M0 to M15	28	31	25
HT/VHT20 Beam Forming, M0 to M15	30	34	25
HT/VHT20 STBC, M0 to M7	28	31	25
	2422	2437	2452
Non HT40, 6 to 54 Mbps	24	32	32
HT/VHT40, M0 to M15	26	31	31
HT/VHT40 Beam Forming, M0 to M15	26	34	34
HT/VHT40 STBC, M0 to M7	26	31	31

Antenna Gain: 5 dBi

Operating Mode	Maximum Channel Power (dBm EIRP)		
	Frequency (MHz)		
	2412	2437	2462
Legacy CCK, 1 to 11 Mbps	31	32	31
Non HT20, 6 to 54 Mbps	29	32	25
Non HT20 Beam Forming, 6 to 54 Mbps	31	35	24
HT/VHT20, M0 to M15	29	32	26
HT/VHT20 Beam Forming, M0 to M15	29	35	26
HT/VHT20 STBC, M0 to M7	29	32	26
	2422	2437	2452
Non HT40, 6 to 54 Mbps	23	33	33
HT/VHT40, M0 to M15	26	32	32
HT/VHT40 Beam Forming, M0 to M15	27	35	35
HT/VHT40 STBC, M0 to M7	25	32	32

Antenna Gain: 6 dBi

Operating Mode	Maximum Channel Power (dBm EIRP)		
	Frequency (MHz)		
	2412	2437	2462
Legacy CCK, 1 to 11 Mbps	32	33	32
Non HT20, 6 to 54 Mbps	29	33	25
Non HT20 Beam Forming, 6 to 54 Mbps	29	35	25
HT/VHT20, M0 to M15	30	33	26
HT/VHT20 Beam Forming, M0 to M15	30	35	25
HT/VHT20 STBC, M0 to M7	30	33	24
	2422	2437	2452
Non HT40, 6 to 54 Mbps	23	34	34
HT/VHT40, M0 to M15	25	33	33
HT/VHT40 Beam Forming, M0 to M15	28	36	36
HT/VHT40 STBC, M0 to M7	25	33	33

Antenna Gain: 8 dBi

Operating Mode	Maximum Channel Power (dBm EIRP)		
	Frequency (MHz)		
	2412	2437	2462
Legacy CCK, 1 to 11 Mbps	34	35	34
Non HT20, 6 to 54 Mbps	31	35	25
Non HT20 Beam Forming, 6 to 54 Mbps	29	36	24
HT/VHT20, M0 to M15	29	35	26
HT/VHT20 Beam Forming, M0 to M15	29	36	26
HT/VHT20 STBC, M0 to M7	29	35	26
	2422	2437	2452
Non HT40, 6 to 54 Mbps	24	36	36
HT/VHT40, M0 to M15	27	35	35
HT/VHT40 Beam Forming, M0 to M15	27	36	36
HT/VHT40 STBC, M0 to M7	27	35	35

Antenna Gain: 13 dBi

Operating Mode	Maximum Channel Power (dBm EIRP)		
	Frequency (MHz)		
	2412	2437	2462
Legacy CCK, 1 to 11 Mbps	36	35	36
Non HT20, 6 to 54 Mbps	31	35	26
Non HT20 Beam Forming, 6 to 54 Mbps	31	35	25
HT/VHT20, M0 to M15	31	35	27
HT/VHT20 Beam Forming, M0 to M15	31	35	27
HT/VHT20 STBC, M0 to M7	31	35	27
	2422	2437	2452
Non HT40, 6 to 54 Mbps	26	36	35
HT/VHT40, M0 to M15	27	36	36
HT/VHT40 Beam Forming, M0 to M15	25	36	36
HT/VHT40 STBC, M0 to M7	25	36	36



A.1 6dB Bandwidth

15.247 / RSS-247 / LP0002:3.10.1(6.2.1) Systems using digital modulation techniques may operate in the 2400-2483.5MHz band. The minimum 6dB bandwidth shall be at least 500 kHz.

Test Procedure

Ref. KDB 558074 D01 DTS Meas Guidance v03r05
ANSI C63.10: 2013

6 BW Test Procedure
<ol style="list-style-type: none"> 1. Set the radio in the continuous transmitting mode. 2. Allow the trace to stabilize. 3. Setting the x-dB bandwidth mode to -6dB within the measurement set up function. 4. Select the automatic OBW measurement function of an instrument to perform bandwidth measurement. 5. Capture graphs and record pertinent measurement data.

Ref. KDB 558074 D01 DTS Meas Guidance v03r05
ANSI C63.10: 2013 section 11.8.2 Option 2

6 BW Test parameters
X dB BW = 6dB (using the OBW function of the spectrum analyzer) Span = Large enough to capture the entire EBW RBW = 100 KHz VBW ≥ 3 x RBW Sweep = Auto couple Detector = Peak or where practical sample shall be used Trace = Max. Hold

System Number	Description	Samples	System under test	Support equipment
1	EUT	S01	<input checked="" type="checkbox"/>	<input type="checkbox"/>
	Support	S02	<input type="checkbox"/>	<input checked="" type="checkbox"/>

Tested By : Jose Aguirre	Date of testing: 20-April-16 - 08-Aug-16
Test Result : PASS	

See Appendix C for list of test equipment



Frequency (MHz)	Mode	Data Rate (Mbps)	6dB BW (MHz)	Limit (kHz)	Margin (MHz)
2412	CCK, 1 to 11 Mbps	11	10.5	>500	10.0
	Non HT20, 6 to 54 Mbps	6	16.1	>500	15.6
	HT/VHT20, M0 to M15	m0	17.6	>500	17.1
2422	Non HT40, 6 to 54 Mbps	6	36.0	>500	35.5
	HT/VHT40, M0 to M15	m0	35.5	>500	35.0
2437	Non HT40, 6 to 54 Mbps	6	35.5	>500	35.0
	HT/VHT40, M0 to M15	m0	35.4	>500	34.9
	CCK, 1 to 11 Mbps	11	9.6	>500	9.1
	Non HT20, 6 to 54 Mbps	6	16.4	>500	15.9
	HT/VHT20, M0 to M15	m0	17.4	>500	16.9
2452	Non HT40, 6 to 54 Mbps	6	35.8	>500	35.3
	HT/VHT40, M0 to M15	m0	35.7	>500	35.2
2462	CCK, 1 to 11 Mbps	11	10.1	>500	9.6
	Non HT20, 6 to 54 Mbps	6	16.4	>500	15.9
	HT/VHT20, M0 to M15	m0	17.3	>500	16.8

6dB Bandwidth, 2412 MHz, CCK, 1 to 11 Mbps

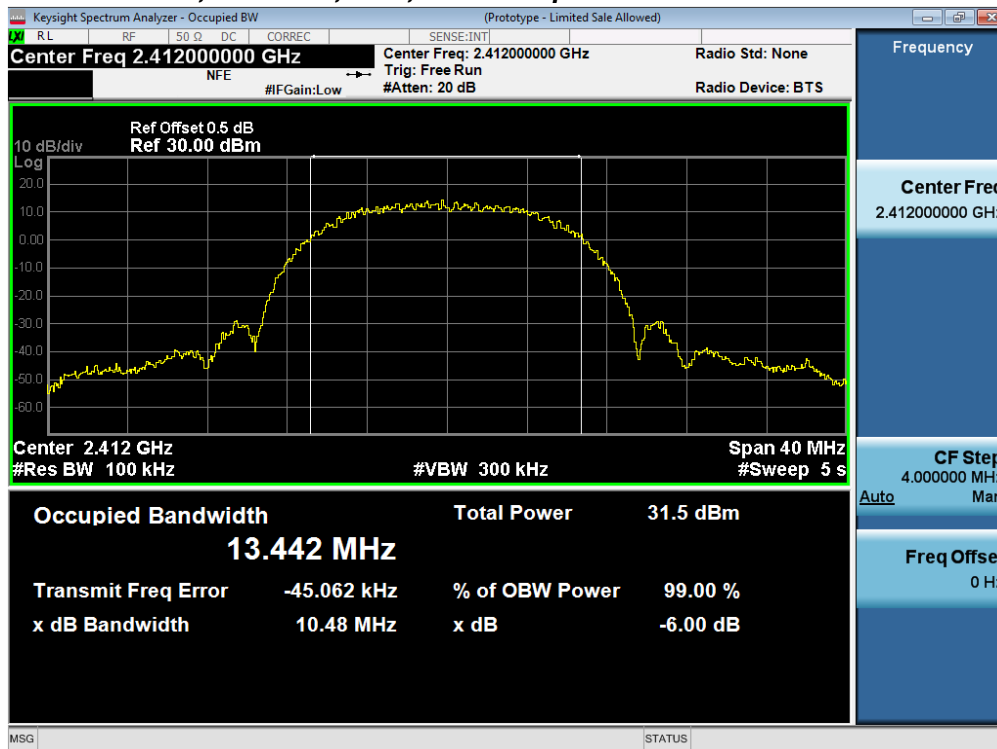

6dB Bandwidth, 2412 MHz, Non HT20, 6 to 54 Mbps

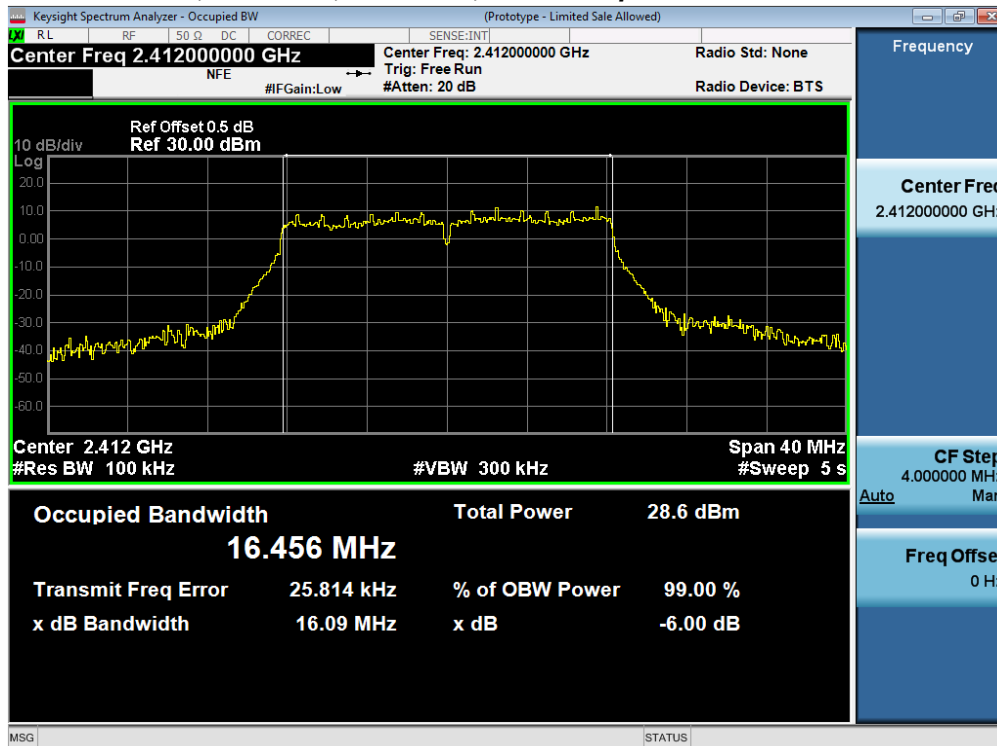

6dB Bandwidth, 2412 MHz, HT/VHT20, M0 to M15

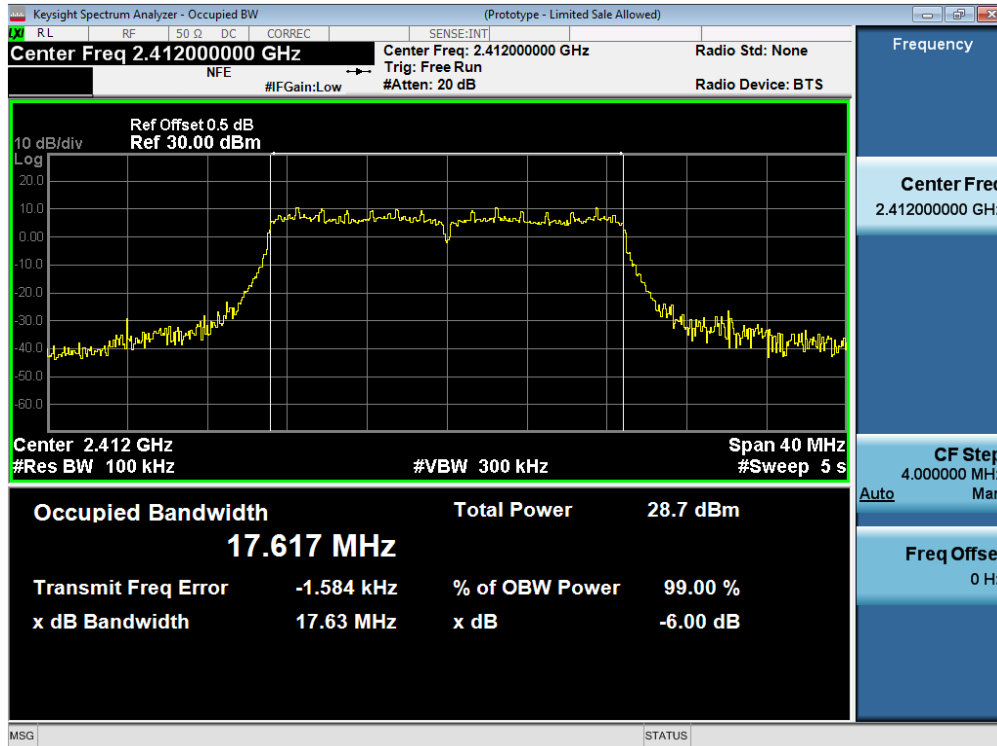

6dB Bandwidth, 2422 MHz, Non HT40, 6 to 54 Mbps

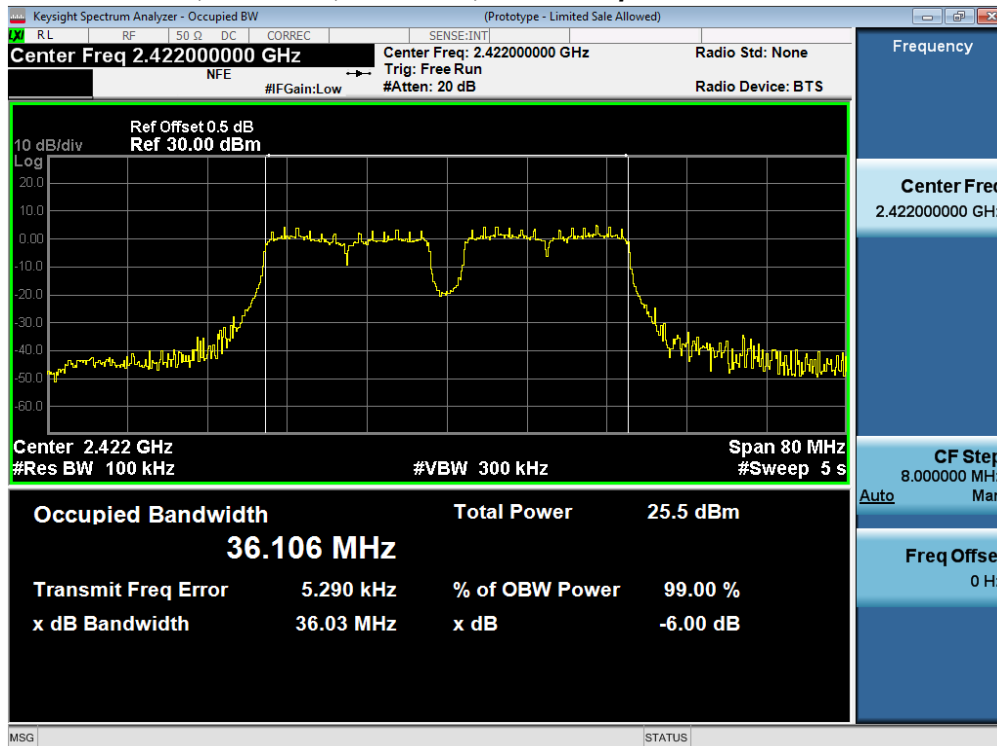

6dB Bandwidth, 2422 MHz, HT/VHT40, M0 to M15

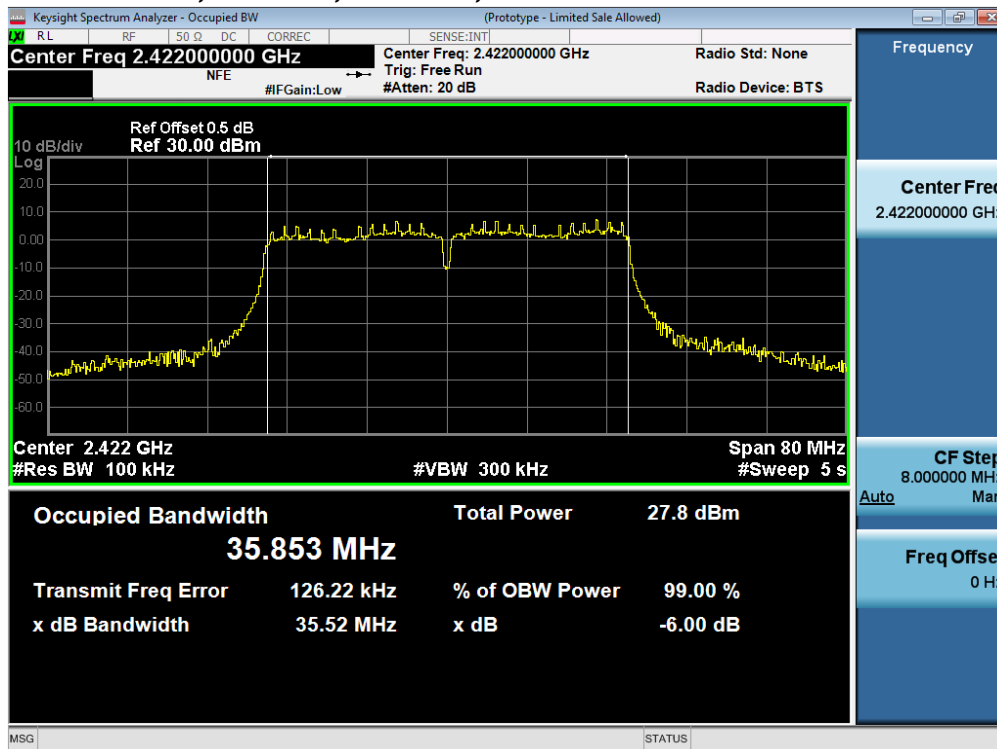

6dB Bandwidth, 2437 MHz, Non HT40, 6 to 54 Mbps

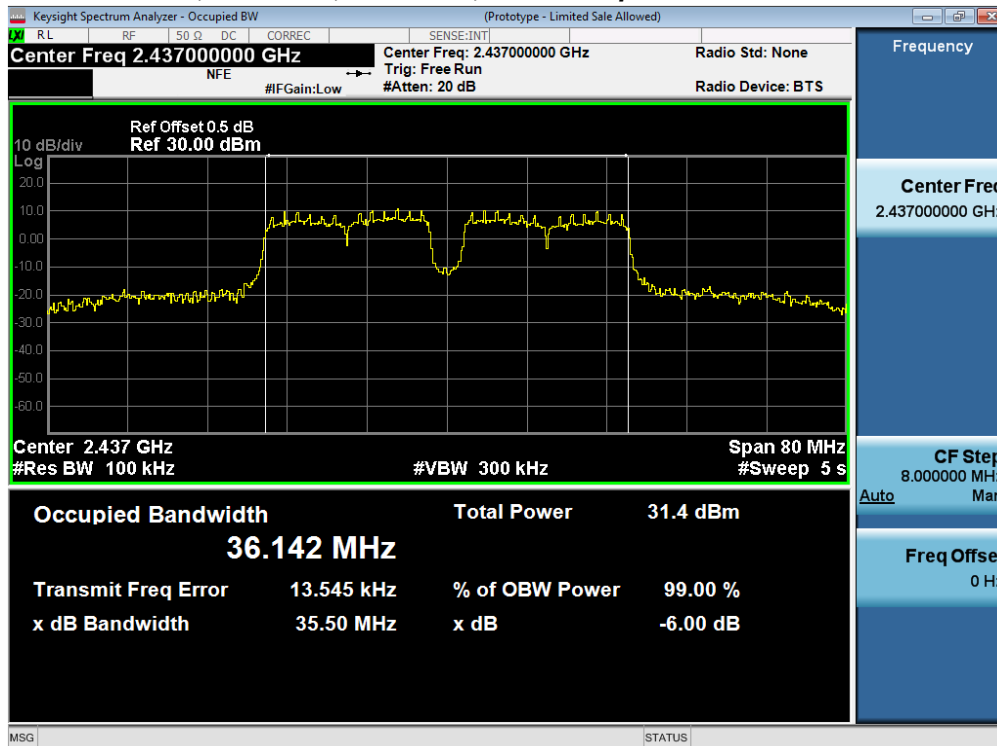

6dB Bandwidth, 2437 MHz, HT/VHT40, M0 to M15

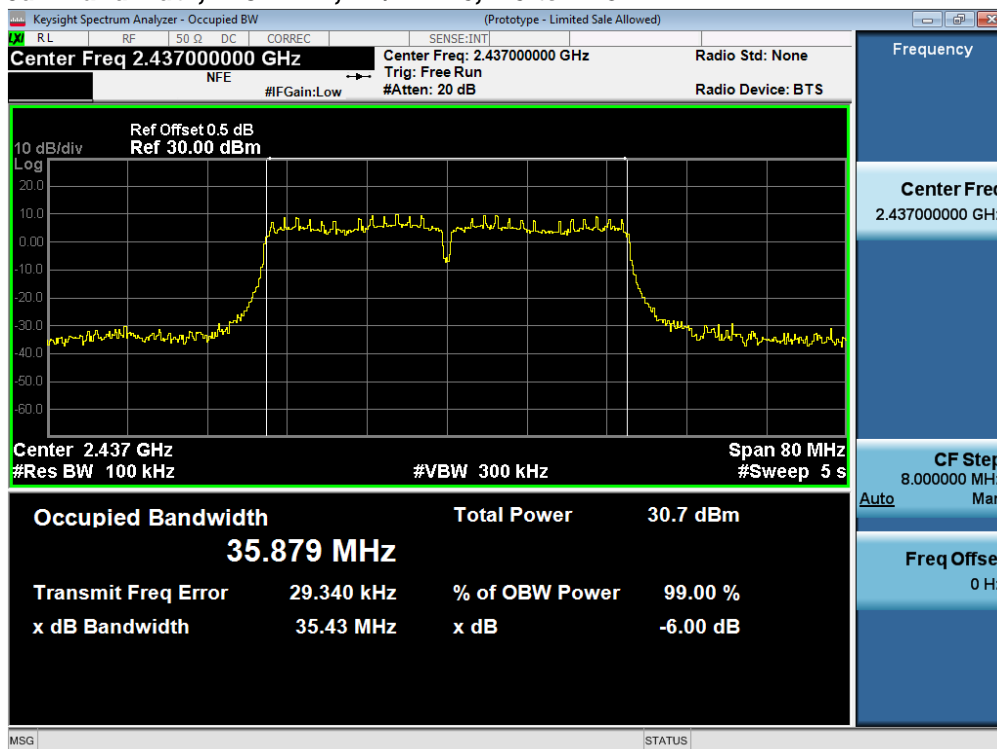

6dB Bandwidth, 2437 MHz, CCK, 1 to 11 Mbps

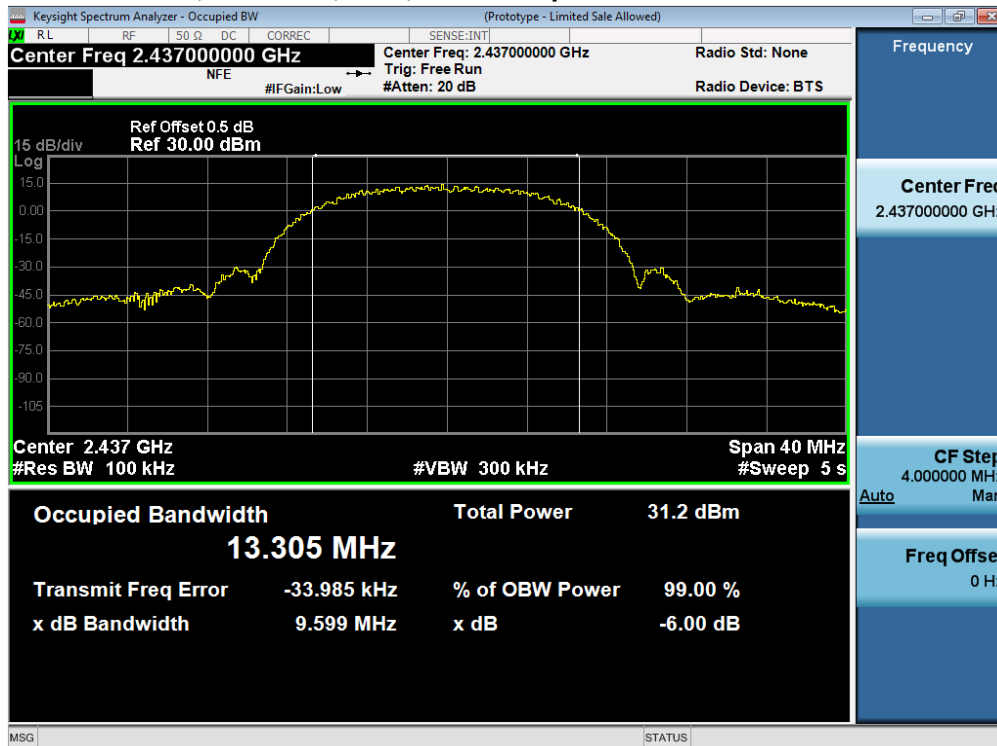

6dB Bandwidth, 2437 MHz, Non HT20, 6 to 54 Mbps

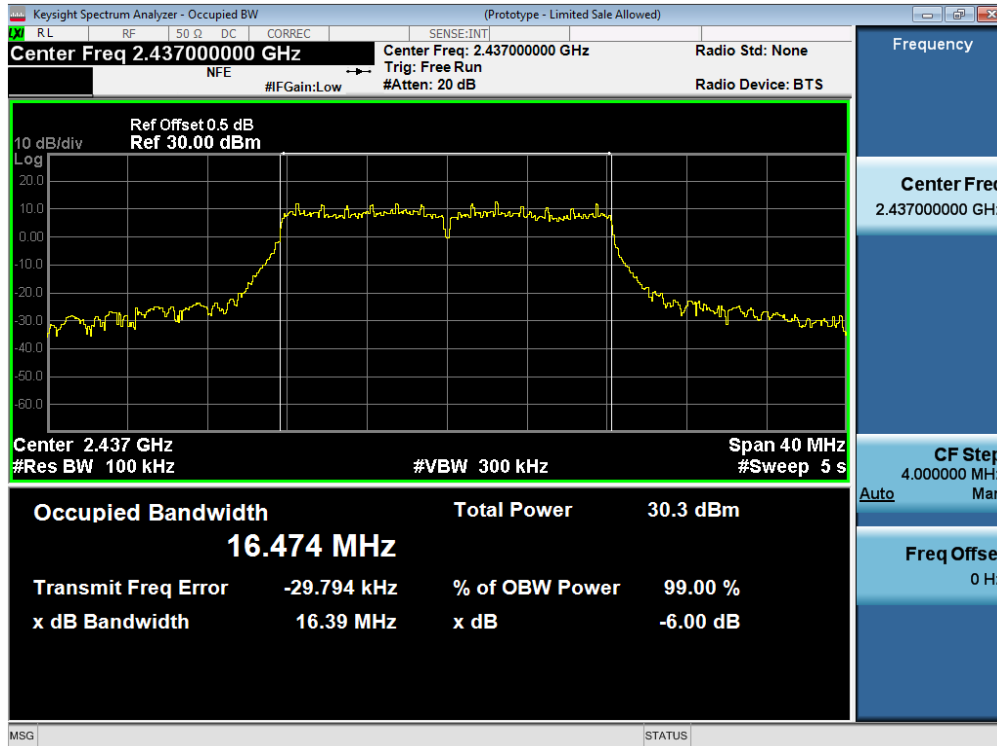

6dB Bandwidth, 2437 MHz, HT/VHT20, M0 to M15

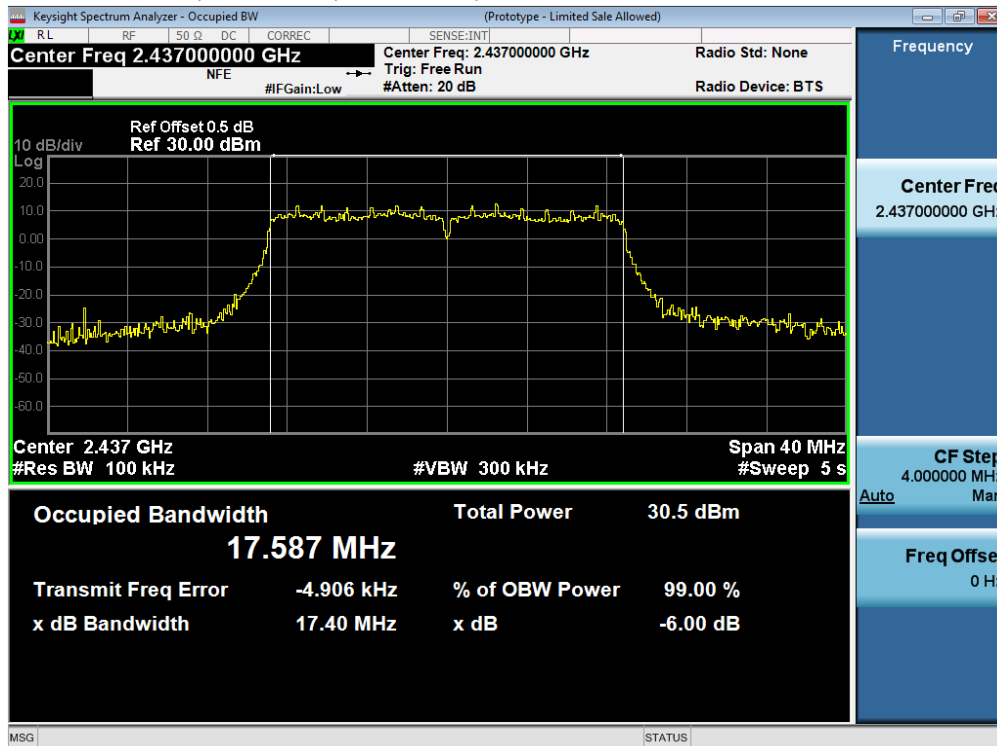

6dB Bandwidth, 2452 MHz, Non HT40, 6 to 54 Mbps

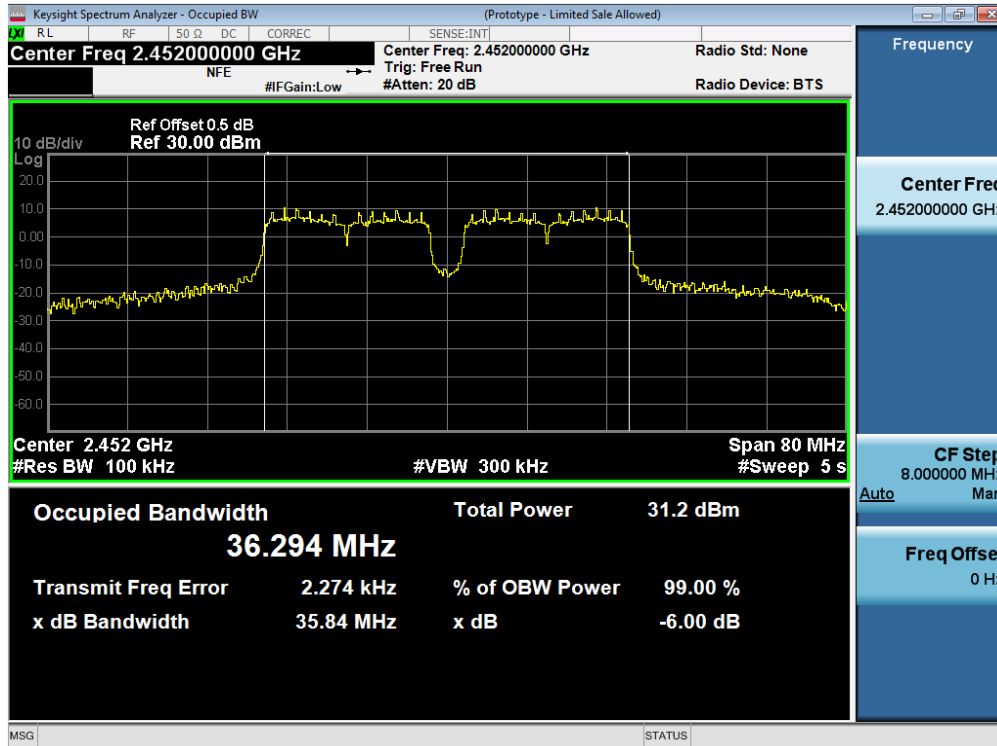

6dB Bandwidth, 2452 MHz, HT/VHT40, M0 to M15

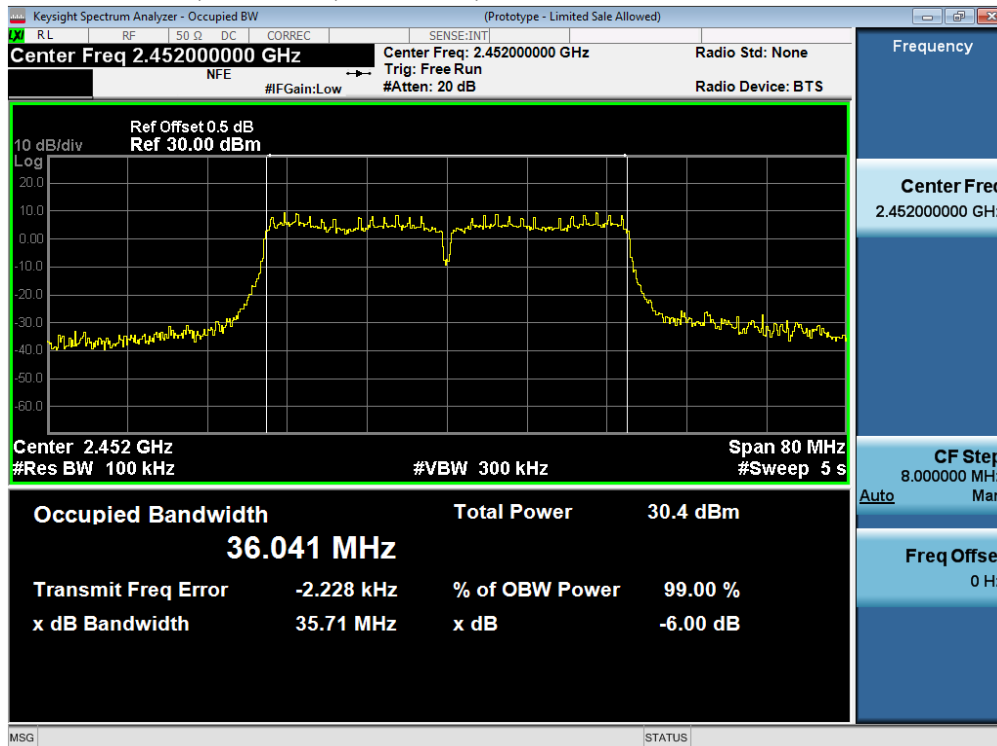

6dB Bandwidth, 2462 MHz, CCK, 1 to 11 Mbps

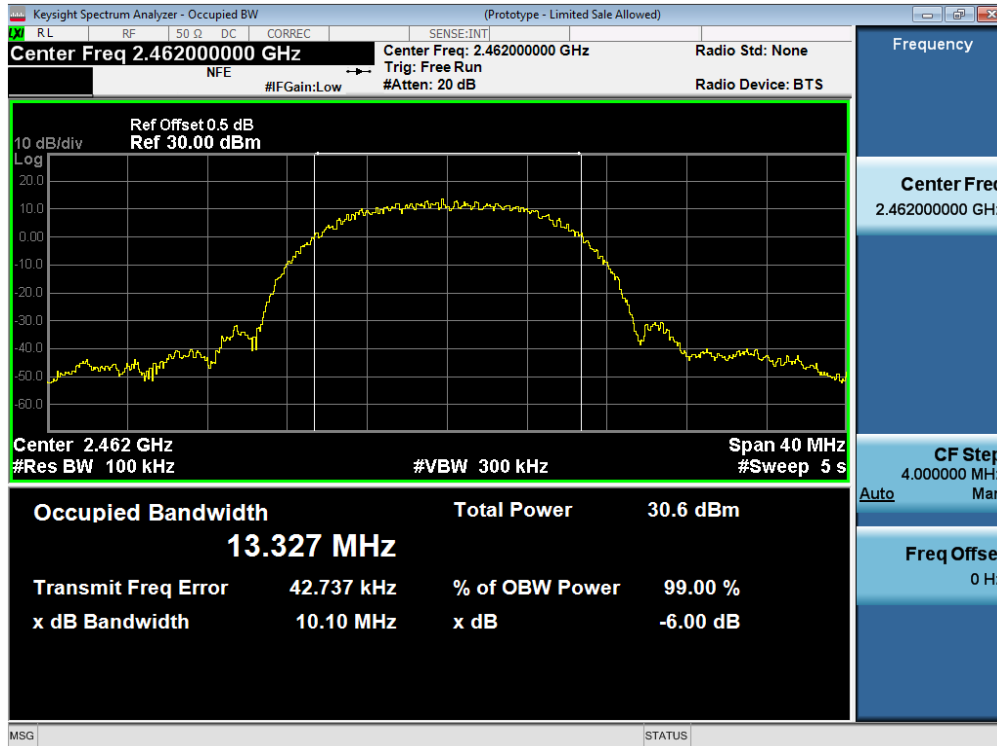

6dB Bandwidth, 2462 MHz, Non HT20, 6 to 54 Mbps

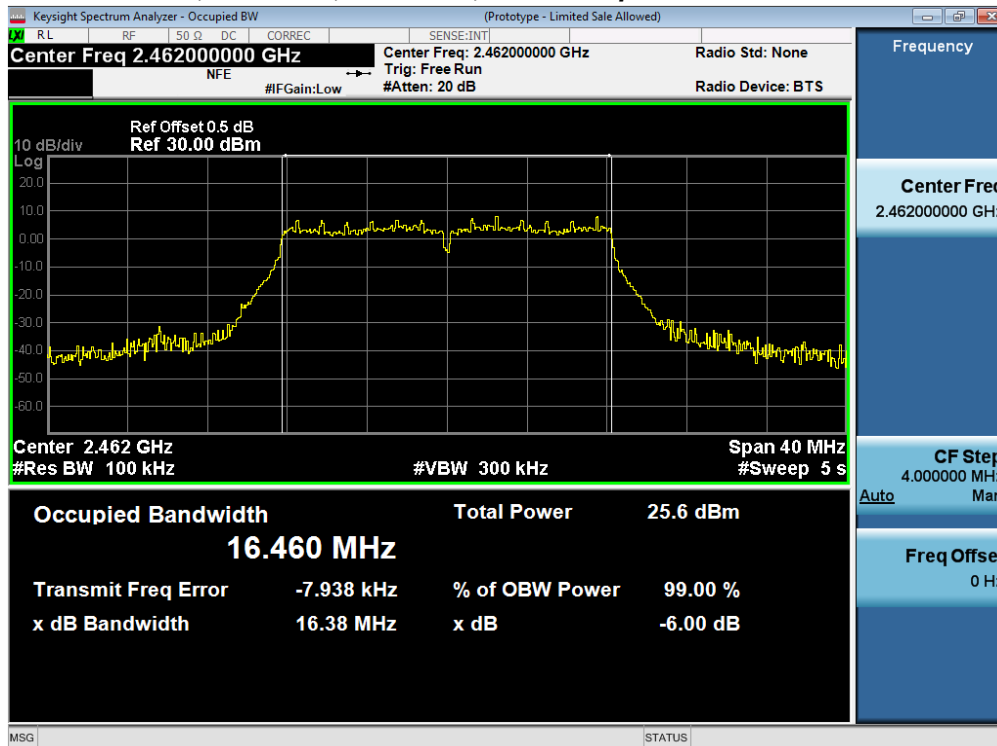

6dB Bandwidth, 2462 MHz, HT/VHT20, M0 to M15

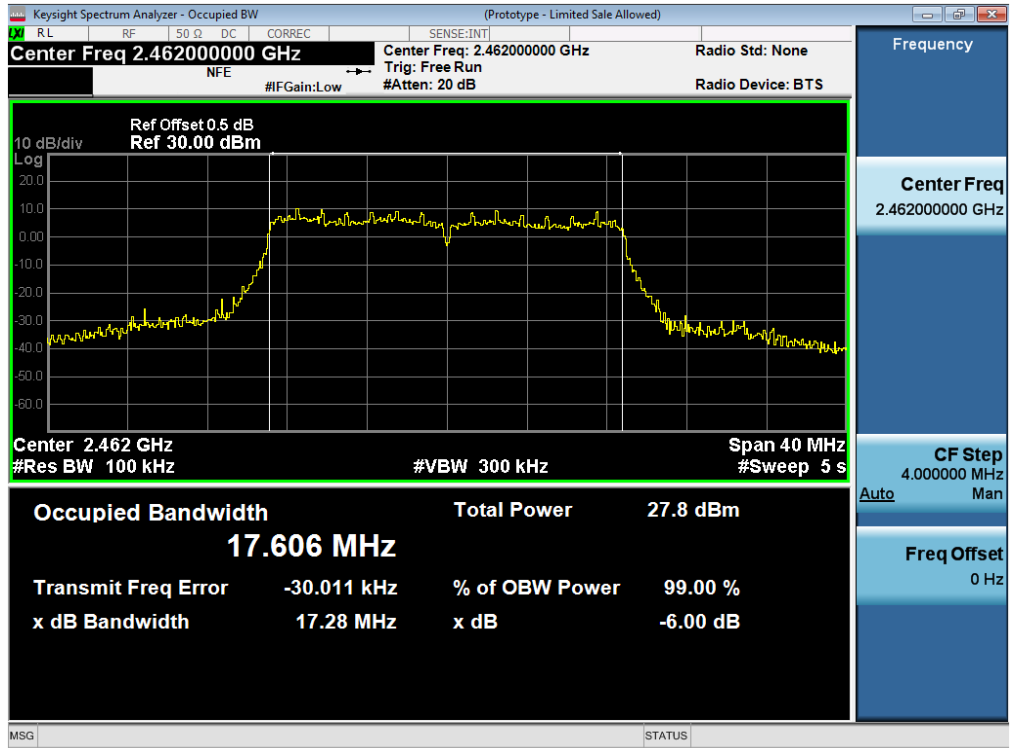

A.2 99% and 26dB Bandwidth

The 99% occupied bandwidth is the frequency bandwidth such that, below its lower and above its upper frequency limits, the mean powers are each equal to 0.5% of the total mean power of the given emission. There is no limit for 99% OBW.

The 26 dB emission is the width of the emission that is constrained by the frequencies associated with the two outermost amplitude points (upper and lower frequencies) that are attenuated by 26 dB relative to the maximum level measured in the fundamental emission.

Test Procedure

Ref. ANSI C63.10: 2013

26 BW & 99% BW Test Procedure
1. Set the radio in the continuous transmitting mode. 2. Allow the trace to stabilize. 3. Setting the x-dB bandwidth mode to -26dB & OBW to 99% within the measurement set up function. 4. Select the automatic OBW measurement function of an instrument to perform bandwidth measurement. 5. Capture graphs and record pertinent measurement data.

Ref. ANSI C63.10: 2013 section 6.9.3

26 BW & 99% BW Test parameters
X dB BW = -26dB (using the OBW function of the spectrum analyzer) OBW = 99% Span = 1.5 to 5 times the OBW RBW = 1% to 5% of the OBW VBW ≥ 3 x RBW Sweep = Auto couple Detector = Peak or where practical sample shall be used Trace = Max. Hold

System Number	Description	Samples	System under test	Support equipment
1	EUT	S01	<input checked="" type="checkbox"/>	<input type="checkbox"/>
	Support	S02	<input type="checkbox"/>	<input checked="" type="checkbox"/>

Tested By : Jose Aguirre	Date of testing: 20-April-16 - 08-Aug-16
Test Result : PASS	

See Appendix C for list of test equipment

Frequency (MHz)	Mode	Data Rate (Mbps)	26dB BW (MHz)	99% BW (MHz)
2412	CCK, 1 to 11 Mbps	11	17.2	13.770
	Non HT20, 6 to 54 Mbps	6	22.2	17.905
	HT/VHT20, M0 to M15	m0	22.7	18.368
2422	Non HT40, 6 to 54 Mbps	6	45.5	36.865
	HT/VHT40, M0 to M15	m0	42.8	36.491
2437	Non HT40, 6 to 54 Mbps	6	75.8	37.887
	HT/VHT40, M0 to M15	m0	43.6	36.530
	CCK, 1 to 11 Mbps	11	17.1	13.633
	Non HT20, 6 to 54 Mbps	6	22.2	17.955
	HT/VHT20, M0 to M15	m0	22.6	18.221
2452	Non HT40, 6 to 54 Mbps	6	74.3	38.956
	HT/VHT40, M0 to M15	m0	44.5	36.763
2462	CCK, 1 to 11 Mbps	11	17.1	13.652
	Non HT20, 6 to 54 Mbps	6	22.4	17.922
	HT/VHT20, M0 to M15	m0	22.7	18.382

26dB / 99% Bandwidth, 2412 MHz, CCK, 1 to 11 Mbps

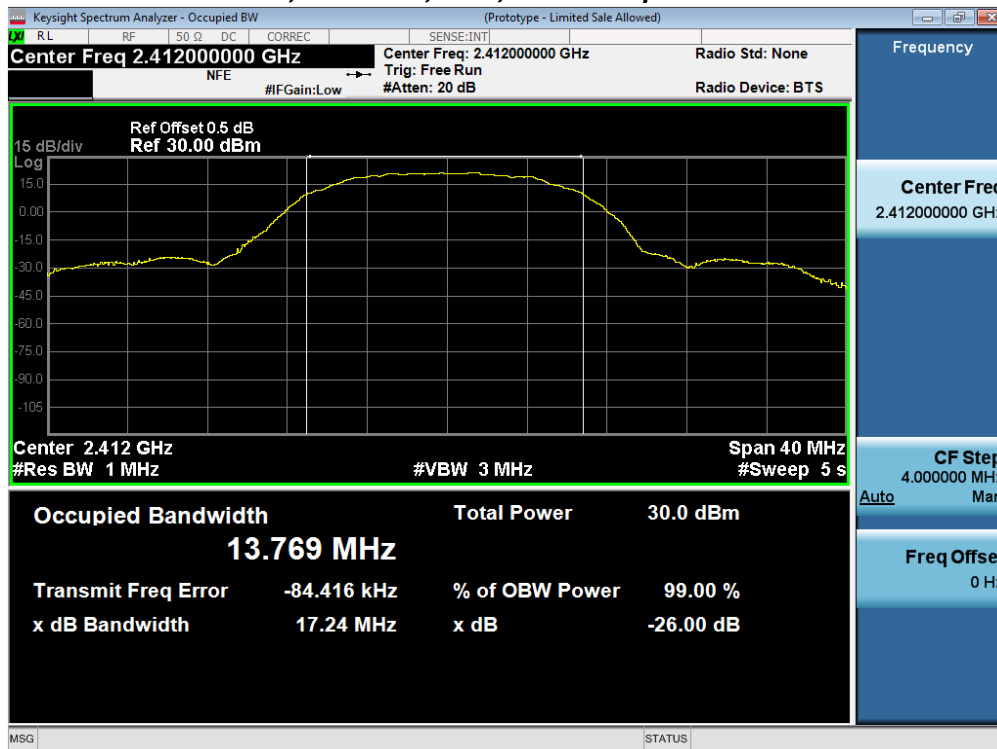

26dB / 99% Bandwidth, 2412 MHz, Non HT20, 6 to 54 Mbps

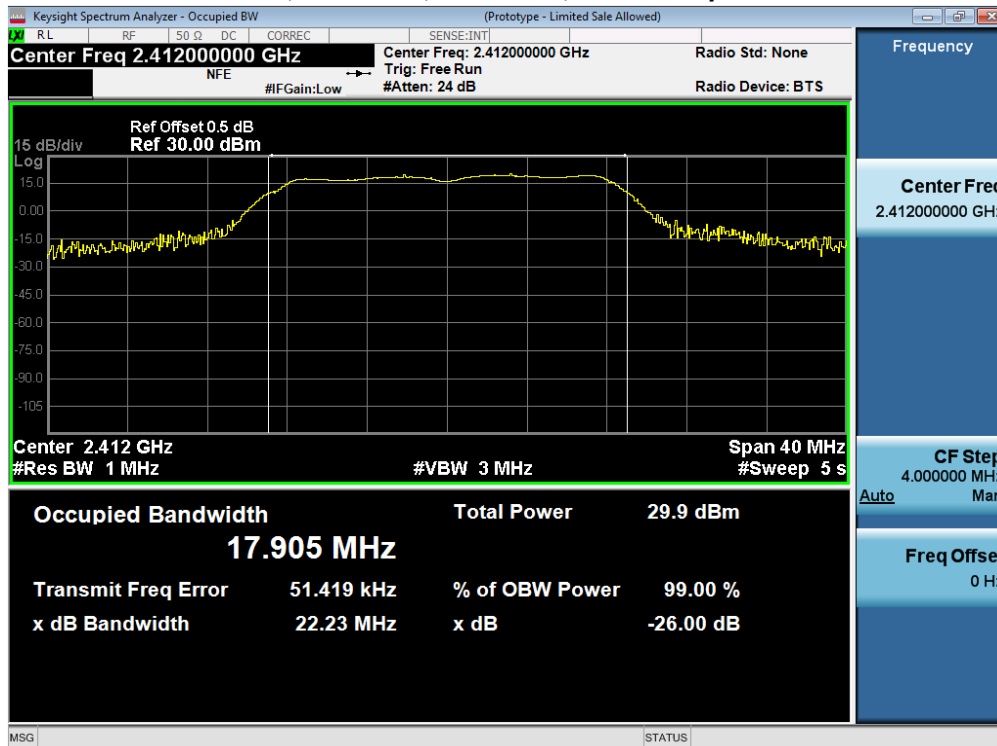

26dB / 99% Bandwidth, 2412 MHz, HT/VHT20, M0 to M15

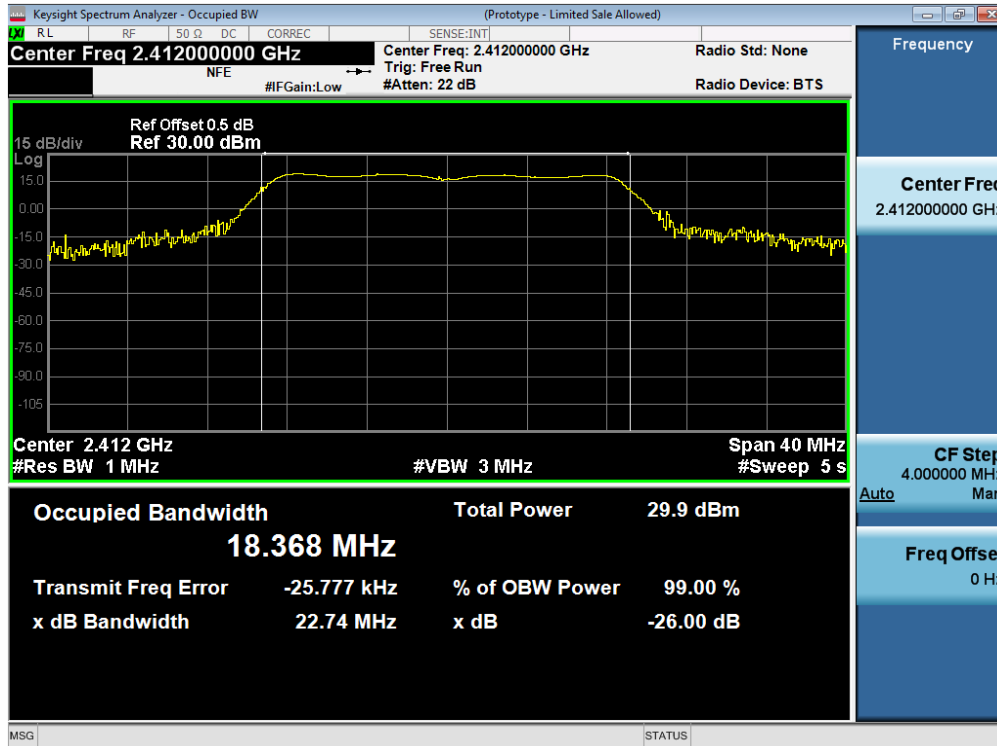

26dB / 99% Bandwidth, 2422 MHz, Non HT40, 6 to 54 Mbps

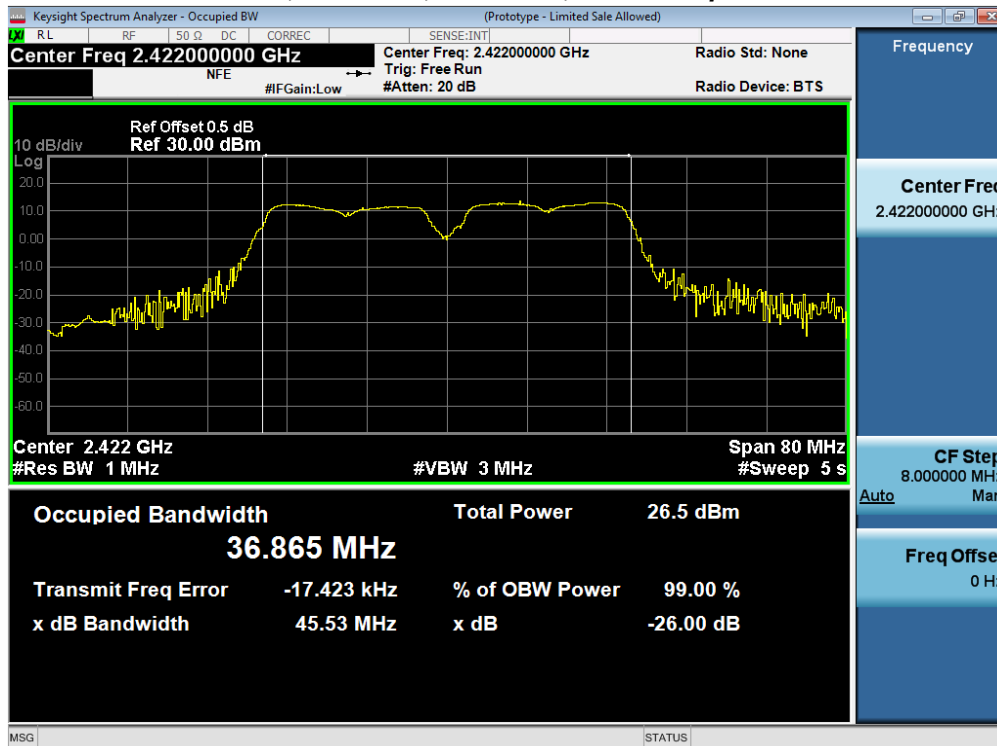

26dB / 99% Bandwidth, 2422 MHz, HT/VHT40, M0 to M15

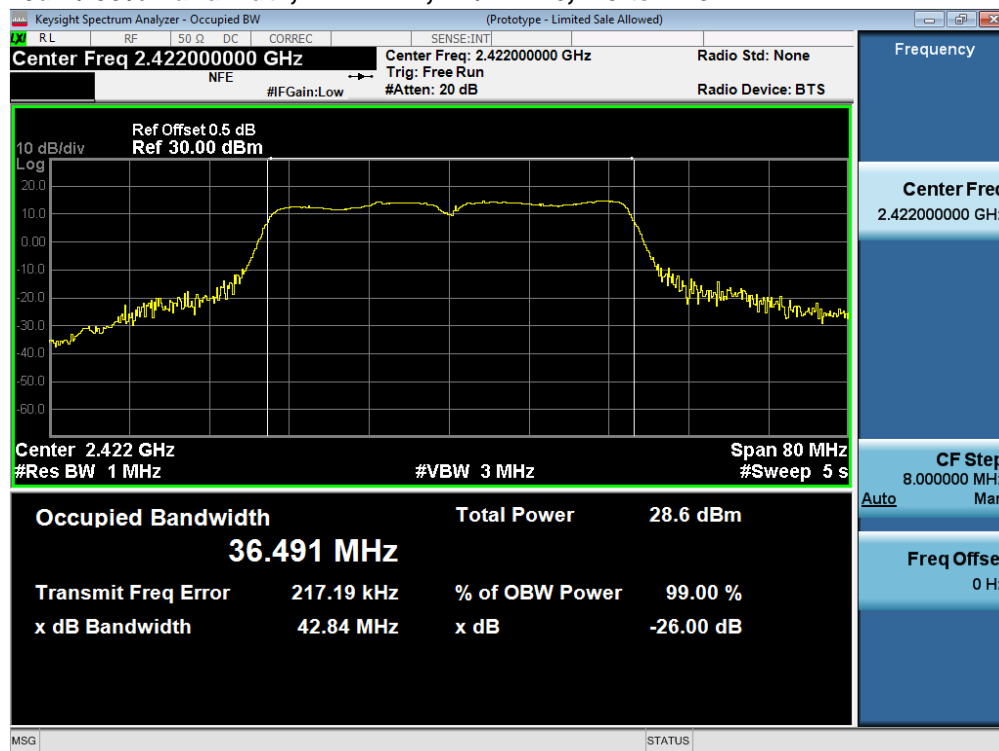

26dB / 99% Bandwidth, 2437 MHz, Non HT40, 6 to 54 Mbps

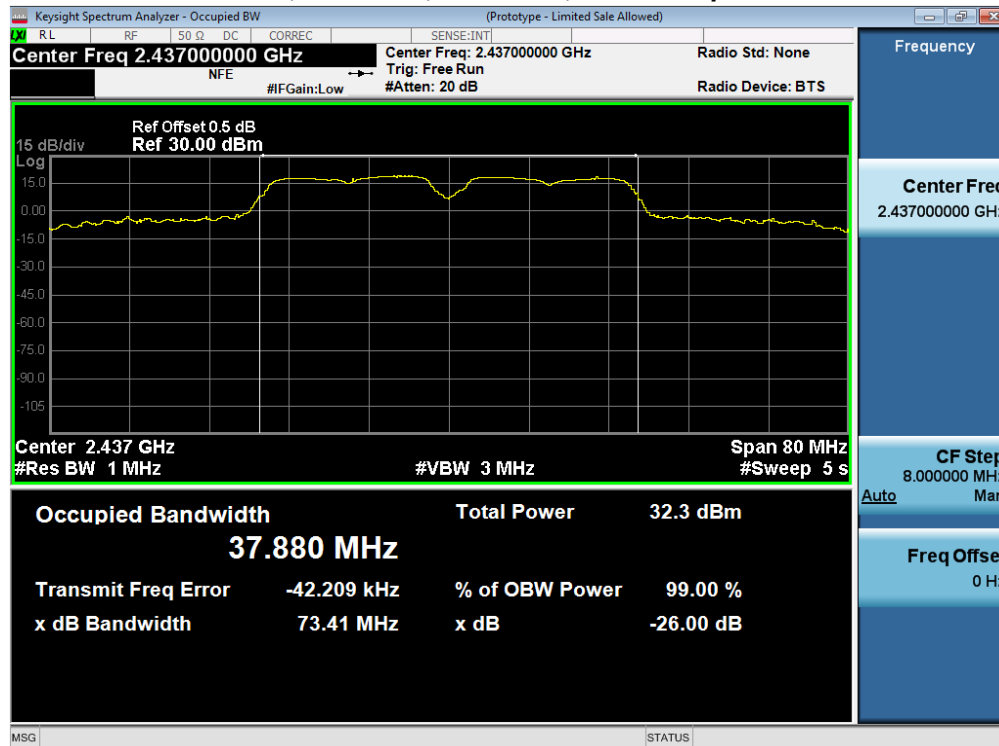

26dB / 99% Bandwidth, 2437 MHz, HT/VHT40, M0 to M15

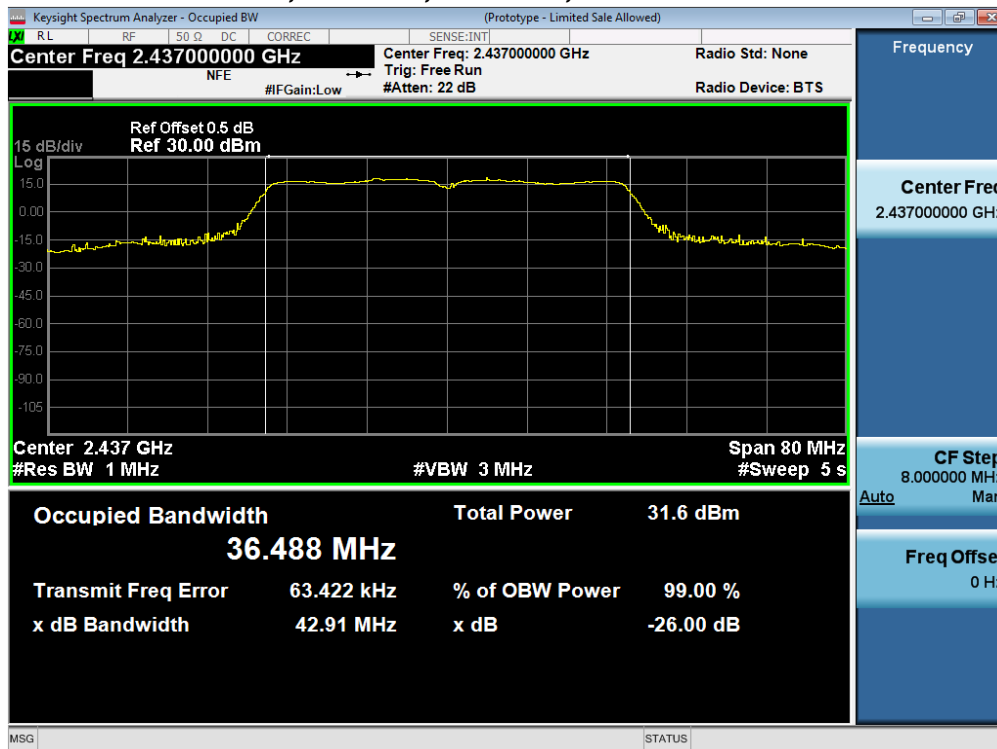

26dB / 99% Bandwidth, 2437 MHz, CCK, 1 to 11 Mbps

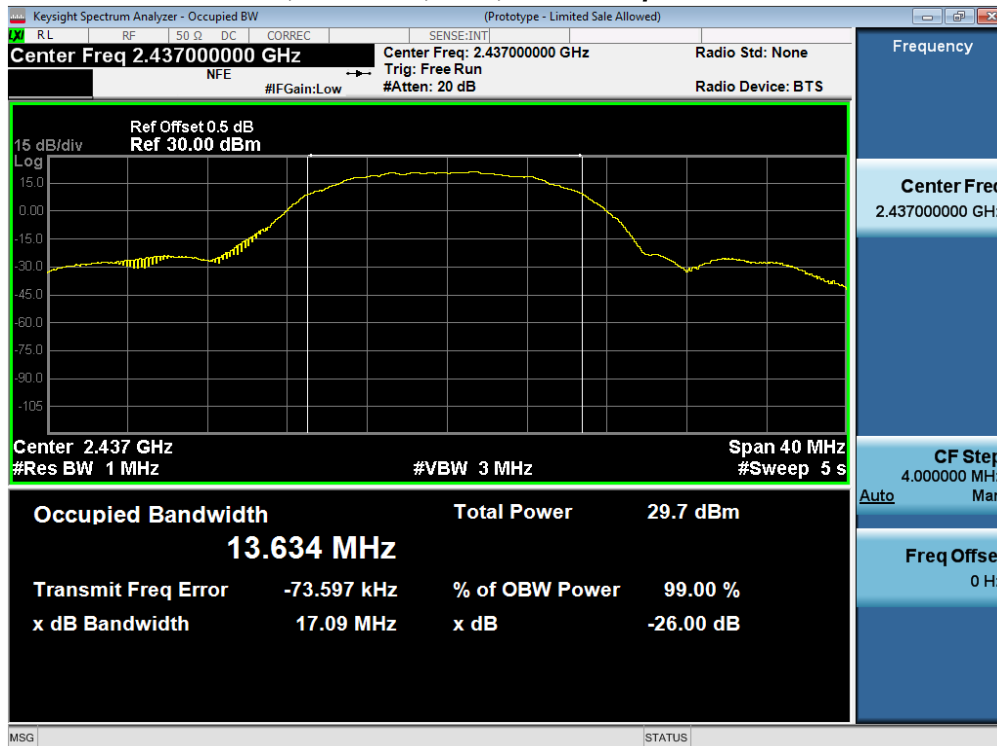

26dB / 99% Bandwidth, 2437 MHz, Non HT20, 6 to 54 Mbps

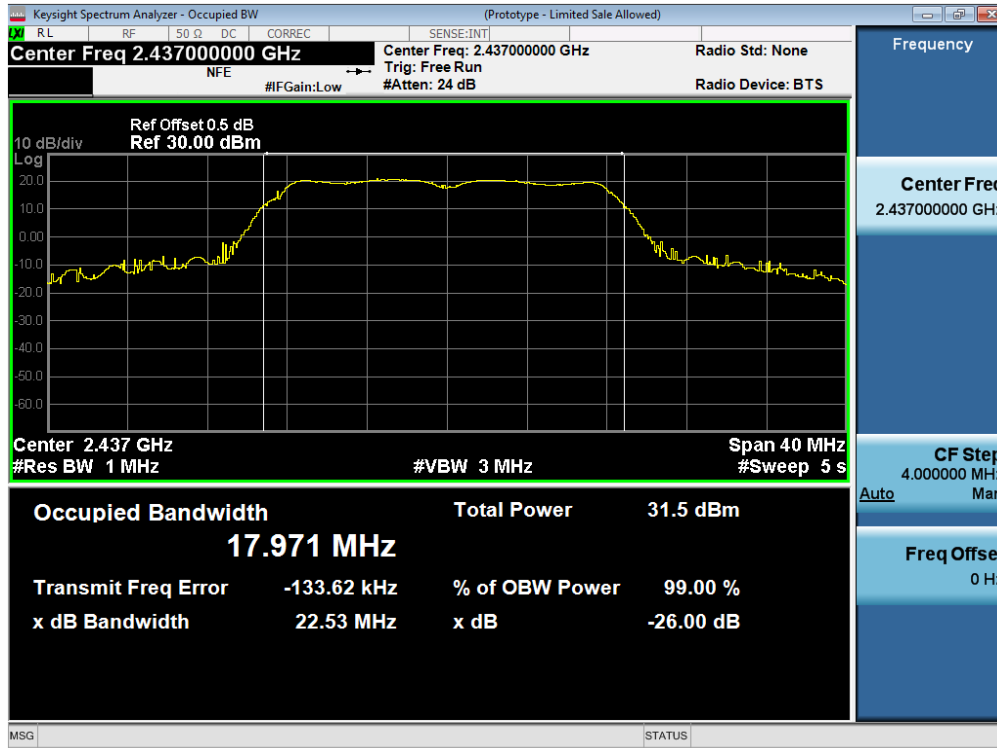

26dB / 99% Bandwidth, 2437 MHz, HT/VHT20, M0 to M15

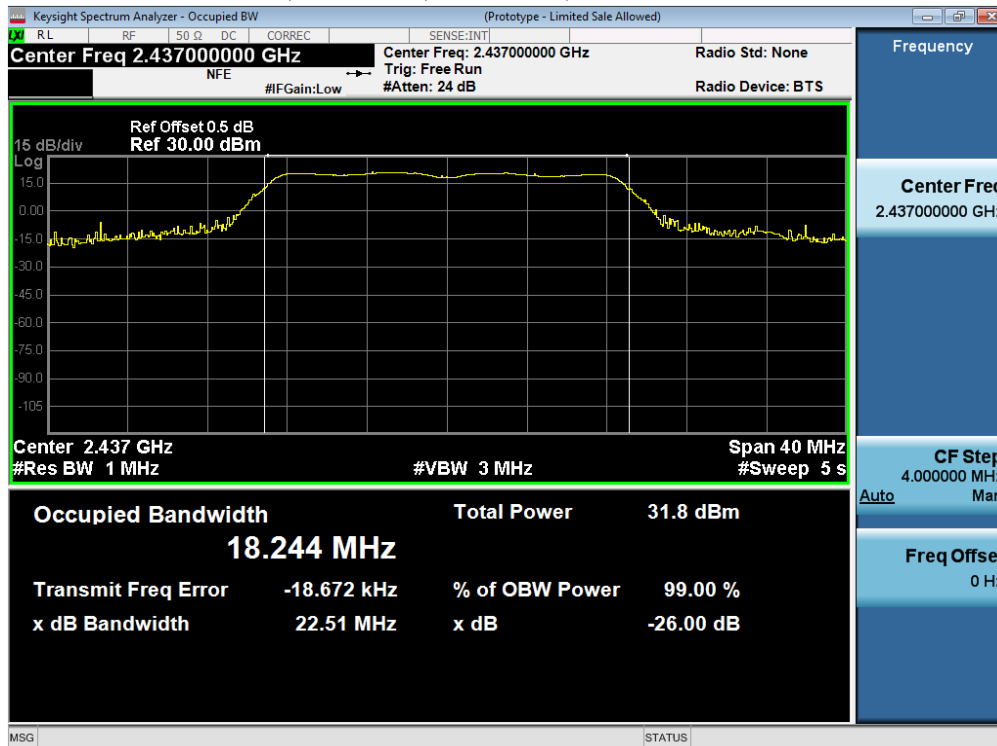



26dB / 99% Bandwidth, 2452 MHz, Non HT40, 6 to 54 Mbps

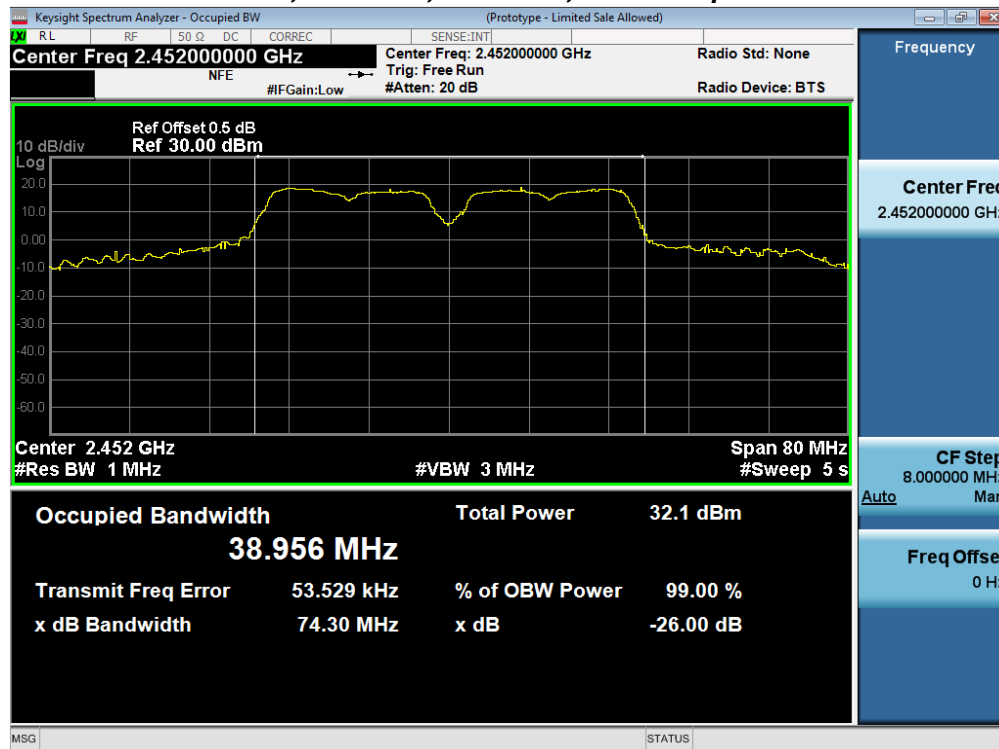

26dB / 99% Bandwidth, 2452 MHz, HT/VHT40, M0 to M15

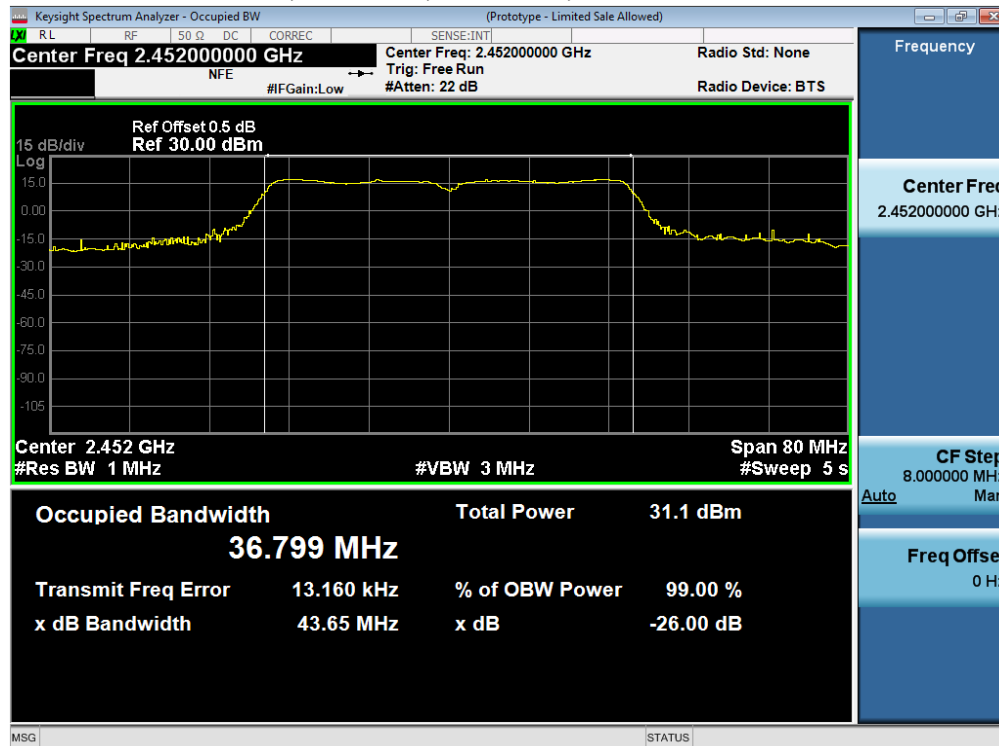

26dB / 99% Bandwidth, 2462 MHz, CCK, 1 to 11 Mbps

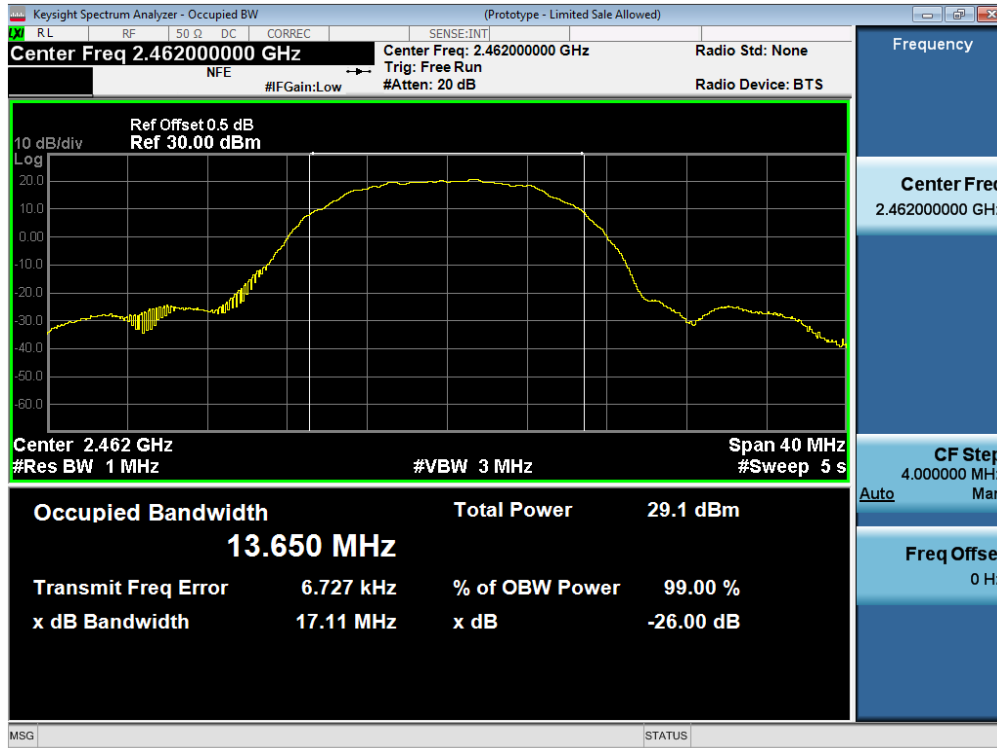

26dB / 99% Bandwidth, 2462 MHz, Non HT20, 6 to 54 Mbps

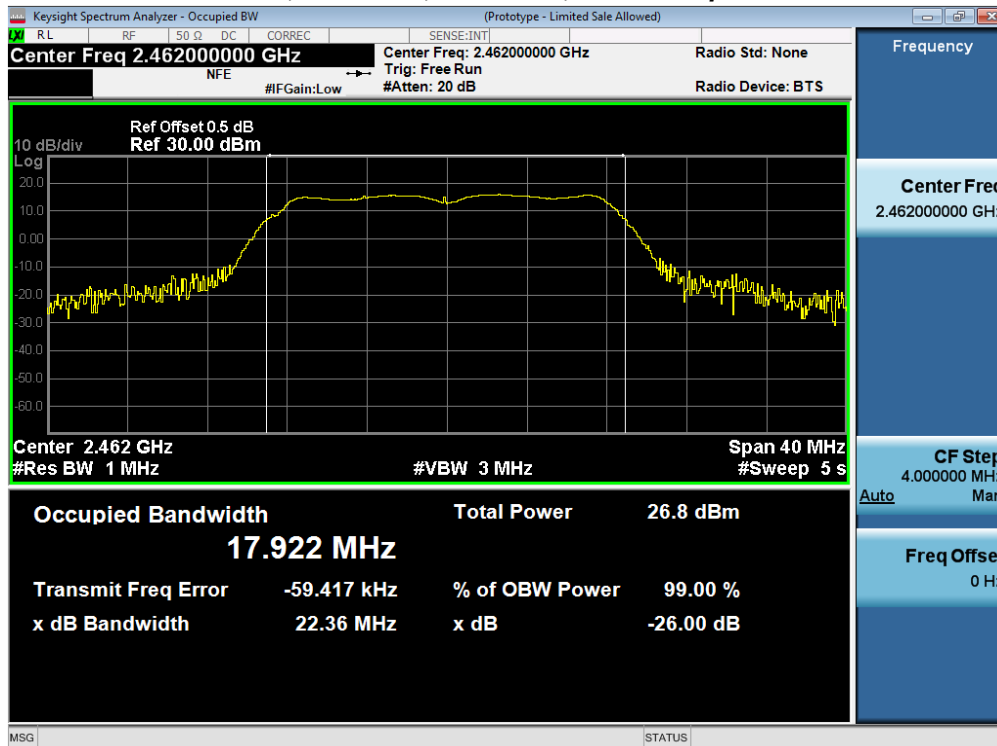

26dB / 99% Bandwidth, 2462 MHz, HT/VHT20, M0 to M15

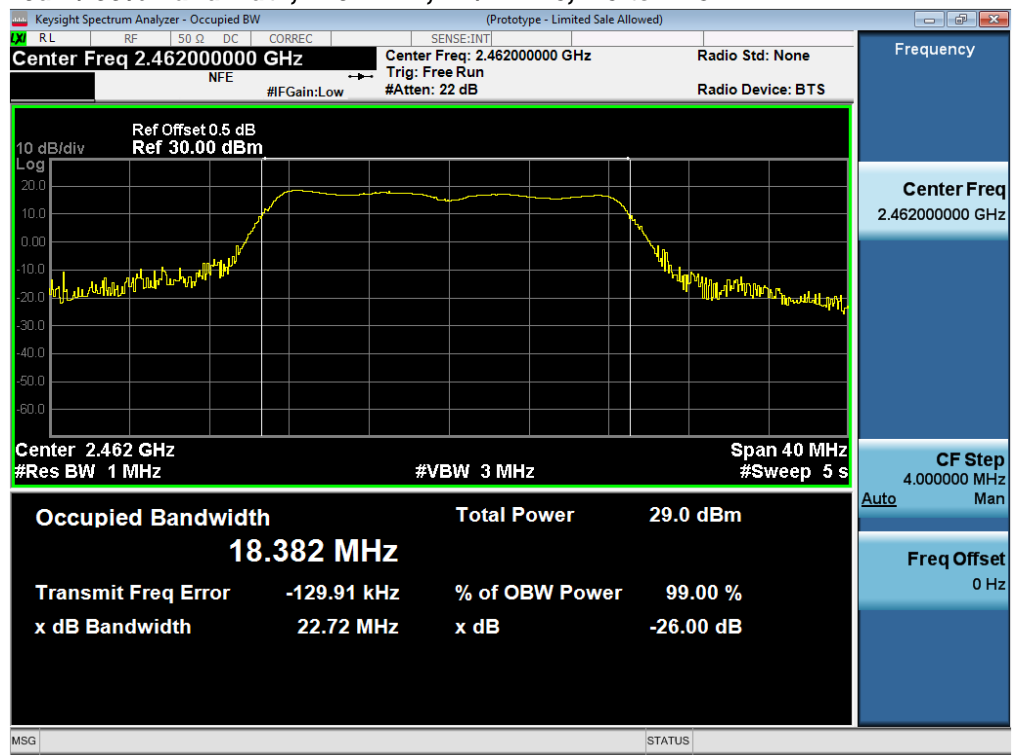



A.3 Maximum Conducted Output Power

15.247 / RSS-247 section 5.4 / LP0002:3.10.1(2.3) The maximum conducted output power of the intentional radiator for systems using digital modulation in the 2400-2483.5 MHz band shall not exceed 1 Watt (30dBm). If transmitting antennas of directional gain greater than 6 dBi are used, the maximum conducted output power shall be reduced by the amount in dB that the directional gain of the antenna exceeds 6 dBi.

As an alternative to a peak power measurement, compliance can be based on a measurement of the maximum conducted output power. The maximum conducted output power is the total transmit power delivered to all antennas and antenna elements, averaged across all symbols in the signaling alphabet when the transmitter is operating at its maximum power control level. Power must be summed across all antennas and antenna elements. The average must not include any time intervals during which the transmitter is off or transmitting at a reduced power level. If multiple modes of operation are implemented, the maximum conducted output power is the highest total transmit power occurring in any mode.

The maximum supported antenna gain is 13 dBi

Test Procedure

Ref. KDB 558074 D01 DTS Meas Guidance v03r05
ANSI C63.10: 2013

<p>Maximum Conducted Output power Test Procedure</p> <ol style="list-style-type: none"> 1. Set the radio in the continuous transmitting mode at full power 2. Compute power by integrating the spectrum across the EBW (or alternatively entire 99% OBW) of the signal using the instrument's band power measurement function. The integration shall be performed using the spectrum analyzer band-power measurement function with band limits set equal to the EBW or the OBW band edges. 3. Capture graphs and record pertinent measurement data.

Ref. 558074 D01 DTS Meas Guidance v03r05 section 9.2 Method AVGSA-1
ANSI C63.10: 2013 section 11.9.2 Method AVGSA-1

<p>Maximum Conducted Output power Test parameters</p> <p>Span = >1.5 times the OBW RBW = 1MHz VBW ≥ 3 x RBW Sweep = Auto couple Detector = Sample, (RMS or where practical sample shall be used) Trace = Trace Average 100</p>

The "measure-and-sum technique" is used for measuring in-band transmit power of a device. In the measure-and-sum approach, the conducted emission level is measured at each antenna port. The measured results at the various antenna ports are then summed mathematically to determine the total emission level from the device. Summing is performed in linear power units. (See ANSI C63.10 section 14.3 for Guidance)

System Number	Description	Samples	System under test	Support equipment
1	EUT	S01	<input checked="" type="checkbox"/>	<input type="checkbox"/>
	Support	S02	<input type="checkbox"/>	<input checked="" type="checkbox"/>

<p>Tested By : Jose Aguirre</p>	<p>Date of testing: 20-April-16 - 08-Aug-16</p>
<p>Test Result : PASS</p>	

See Appendix C for list of test equipment



Antenna Gain: 4 dBi

Frequency (MHz)	Mode	Tx Paths	Correlated Antenna Gain (dBi)	Tx 1 Max Power (dBm)	Tx 2 Max Power (dBm)	Total Tx Channel Power (dBm)	Total Tx Channel Power (dBm) EIRP	Limit (dBm) EIRP	Margin (dB)
2412	CCK, 1 to 11 Mbps	1	4	23.8		23.8	27.8	34	6.2
	CCK, 1 to 11 Mbps	2	4	23.8	22.9	26.4	30.4	34	3.6
	Non HT20, 6 to 54 Mbps	1	4	22		22	26	34	8
	Non HT20, 6 to 54 Mbps	2	4	21.7	20.9	24.3	28.3	34	5.7
	Non HT20 Beam Forming, 6 to 54 Mbps	2	7	19.8	19.4	22.6	29.6	36	6.4
	HT/VHT20, M0 to M7	1	4	21.9		21.9	25.9	34	8.1
	HT/VHT20, M0 to M7	2	4	20.6	21	23.8	27.8	34	6.2
	HT/VHT20, M8 to M15	2	4	20.6	21	23.8	27.8	34	6.2
	HT/VHT20 Beam Forming, M0 to M7	2	7	19.9	19.4	22.7	29.7	36	6.3
	HT/VHT20 Beam Forming, M8 to M15	2	4	20.6	21	23.8	27.8	34	6.2
	HT/VHT20 STBC, M0 to M7	2	4	20.6	21	23.8	27.8	34	6.2
2422	Non HT40, 6 to 54 Mbps	1	4	18.6		18.6	22.6	34	11.4
	Non HT40, 6 to 54 Mbps	2	4	16.5	17	19.8	23.8	34	10.2
	HT/VHT40, M0 to M7	1	4	20.6		20.6	24.6	34	9.4
	HT/VHT40, M0 to M7	2	4	18.7	18.4	21.6	25.6	34	8.4
	HT/VHT40, M8 to M15	2	4	18.7	18.4	21.6	25.6	34	8.4
	HT/VHT40 Beam Forming, M0 to M7	2	7	16.9	15.9	19.4	26.4	36	9.6
	HT/VHT40 Beam Forming, M8 to M15	2	4	18.7	18.4	21.6	25.6	34	8.4
	HT/VHT40 STBC, M0 to M7	2	4	18.7	18.4	21.6	25.6	34	8.4
2437	Non HT40, 6 to 54 Mbps	1	4	24.4		24.4	28.4	34	5.6
	Non HT40, 6 to 54 Mbps	2	4	24.4	25	27.7	31.7	34	2.3
	HT/VHT40, M0 to M7	1	4	23.6		23.6	27.6	34	6.4
	HT/VHT40, M0 to M7	2	4	23.6	24.3	27	31	34	3
	HT/VHT40, M8 to M15	2	4	23.6	24.3	27	31	34	3
	HT/VHT40 Beam Forming, M0 to M7	2	7	23.6	24.3	27	34	36	2
	HT/VHT40 Beam Forming, M8 to M15	2	4	23.6	24.3	27	31	34	3
	HT/VHT40 STBC, M0 to M7	2	4	23.6	24.3	27	31	34	3



	CCK, 1 to 11 Mbps	1	4	23.6		23.6	27.6	34	6.4
	CCK, 1 to 11 Mbps	2	4	23.6	24.4	27	31	34	3
	Non HT20, 6 to 54 Mbps	1	4	23.7		23.7	27.7	34	6.3
	Non HT20, 6 to 54 Mbps	2	4	23.7	24.5	27.1	31.1	34	2.9
	Non HT20 Beam Forming, 6 to 54 Mbps	2	7	23.7	24.5	27.1	34.1	36	1.9
	HT/VHT20, M0 to M7	1	4	23.9		23.9	27.9	34	6.1
	HT/VHT20, M0 to M7	2	4	23.9	24.6	27.3	31.3	34	2.7
	HT/VHT20, M8 to M15	2	4	23.9	24.6	27.3	31.3	34	2.7
	HT/VHT20 Beam Forming, M0 to M7	2	7	23.9	24.6	27.3	34.3	36	1.7
	HT/VHT20 Beam Forming, M8 to M15	2	4	23.9	24.6	27.3	31.3	34	2.7
	HT/VHT20 STBC, M0 to M7	2	4	23.9	24.6	27.3	31.3	34	2.7
2452	Non HT40, 6 to 54 Mbps	1	4	24.1		24.1	28.1	34	5.9
	Non HT40, 6 to 54 Mbps	2	4	24.1	25.4	27.8	31.8	34	2.2
	HT/VHT40, M0 to M7	1	4	23.1		23.1	27.1	34	6.9
	HT/VHT40, M0 to M7	2	4	23.1	24.6	26.9	30.9	34	3.1
	HT/VHT40, M8 to M15	2	4	23.1	24.6	26.9	30.9	34	3.1
	HT/VHT40 Beam Forming, M0 to M7	2	7	23.1	24.6	26.9	33.9	36	2.1
	HT/VHT40 Beam Forming, M8 to M15	2	4	23.1	24.6	26.9	30.9	34	3.1
	HT/VHT40 STBC, M0 to M7	2	4	23.1	24.6	26.9	30.9	34	3.1
2462	CCK, 1 to 11 Mbps	1	4	22.9		22.9	26.9	34	7.1
	CCK, 1 to 11 Mbps	2	4	22.9	23.8	26.4	30.4	34	3.6
	Non HT20, 6 to 54 Mbps	1	4	19		19	23	34	11
	Non HT20, 6 to 54 Mbps	2	4	19.3	19	22.2	26.2	34	7.8
	Non HT20 Beam Forming, 6 to 54 Mbps	2	7	13.2	14.1	16.7	23.7	36	12.3
	HT/VHT20, M0 to M7	1	4	21.1		21.1	25.1	34	8.9
	HT/VHT20, M0 to M7	2	4	17.3	18.4	20.9	24.9	34	9.1
	HT/VHT20, M8 to M15	2	4	17.3	18.4	20.9	24.9	34	9.1
	HT/VHT20 Beam Forming, M0 to M7	2	7	15.2	15	18.1	25.1	36	10.9
	HT/VHT20 Beam Forming, M8 to M15	2	4	17.3	18.4	20.9	24.9	34	9.1
	HT/VHT20 STBC, M0 to M7	2	4	17.3	18.4	20.9	24.9	34	9.1

Peak Output Power, 2437 MHz, HT/VHT20 Beam Forming, M0 to M7



Antenna A



Antenna B



Antenna Gain: 5 dBi

Frequency (MHz)	Mode	Tx Paths	Correlated Antenna Gain (dBi)	Tx 1 Max Power (dBm)	Tx 2 Max Power (dBm)	Total Tx Channel Power (dBm)	Total Tx Channel Power (dBm) EIRP	Limit (dBm) EIRP	Margin (dB)
2412	CCK, 1 to 11 Mbps	1	5	23.8		23.8	28.8	35	6.2
	CCK, 1 to 11 Mbps	2	5	23.8	22.9	26.4	31.4	35	3.6
	Non HT20, 6 to 54 Mbps	1	5	22		22	27	35	8
	Non HT20, 6 to 54 Mbps	2	5	21.7	20.9	24.3	29.3	35	5.7
	Non HT20 Beam Forming, 6 to 54 Mbps	2	8	19.8	19.4	22.6	30.6	36	5.4
	HT/VHT20, M0 to M7	1	5	21.9		21.9	26.9	35	8.1
	HT/VHT20, M0 to M7	2	5	20.6	21	23.8	28.8	35	6.2
	HT/VHT20, M8 to M15	2	5	20.6	21	23.8	28.8	35	6.2
	HT/VHT20 Beam Forming, M0 to M7	2	8	17.8	17.4	20.6	28.6	36	7.4
	HT/VHT20 Beam Forming, M8 to M15	2	5	20.6	21	23.8	28.8	35	6.2
	HT/VHT20 STBC, M0 to M7	2	5	20.6	21	23.8	28.8	35	6.2
2422	Non HT40, 6 to 54 Mbps	1	5	18.1		18.1	23.1	35	11.9
	Non HT40, 6 to 54 Mbps	2	5	14.9	15	18	23	35	12
	HT/VHT40, M0 to M7	1	5	20.6		20.6	25.6	35	9.4
	HT/VHT40, M0 to M7	2	5	16.9	16.8	19.9	24.9	35	10.1
	HT/VHT40, M8 to M15	2	5	16.9	16.8	19.9	24.9	35	10.1
	HT/VHT40 Beam Forming, M0 to M7	2	8	16.9	15.9	19.4	27.4	36	8.6
	HT/VHT40 Beam Forming, M8 to M15	2	5	16.9	16.8	19.9	24.9	35	10.1
	HT/VHT40 STBC, M0 to M7	2	5	16.9	16.8	19.9	24.9	35	10.1
2437	Non HT40, 6 to 54 Mbps	1	5	24.4		24.4	29.4	35	5.6
	Non HT40, 6 to 54 Mbps	2	5	24.4	25	27.7	32.7	35	2.3
	HT/VHT40, M0 to M7	1	5	23.6		23.6	28.6	35	6.4
	HT/VHT40, M0 to M7	2	5	23.6	24.3	27	32	35	3
	HT/VHT40, M8 to M15	2	5	23.6	24.3	27	32	35	3
	HT/VHT40 Beam Forming, M0 to M7	2	8	23.6	24.3	27	35	36	1
	HT/VHT40 Beam Forming, M8 to M15	2	5	23.6	24.3	27	32	35	3
	HT/VHT40 STBC, M0 to M7	2	5	23.6	24.3	27	32	35	3



	CCK, 1 to 11 Mbps	1	5	23.6		23.6	28.6	35	6.4
	CCK, 1 to 11 Mbps	2	5	23.6	24.4	27	32	35	3
	Non HT20, 6 to 54 Mbps	1	5	23.7		23.7	28.7	35	6.3
	Non HT20, 6 to 54 Mbps	2	5	23.7	24.5	27.1	32.1	35	2.9
	Non HT20 Beam Forming, 6 to 54 Mbps	2	8	23.7	24.5	27.1	35.1	36	0.9
	HT/VHT20, M0 to M7	1	5	23.9		23.9	28.9	35	6.1
	HT/VHT20, M0 to M7	2	5	23.9	24.6	27.3	32.3	35	2.7
	HT/VHT20, M8 to M15	2	5	23.9	24.6	27.3	32.3	35	2.7
	HT/VHT20 Beam Forming, M0 to M7	2	8	23.9	24.6	27.3	35.3	36	0.7
	HT/VHT20 Beam Forming, M8 to M15	2	5	23.9	24.6	27.3	32.3	35	2.7
	HT/VHT20 STBC, M0 to M7	2	5	23.9	24.6	27.3	32.3	35	2.7
2452	Non HT40, 6 to 54 Mbps	1	5	24.1		24.1	29.1	35	5.9
	Non HT40, 6 to 54 Mbps	2	5	24.1	25.4	27.8	32.8	35	2.2
	HT/VHT40, M0 to M7	1	5	23.1		23.1	28.1	35	6.9
	HT/VHT40, M0 to M7	2	5	23.1	24.6	26.9	31.9	35	3.1
	HT/VHT40, M8 to M15	2	5	23.1	24.6	26.9	31.9	35	3.1
	HT/VHT40 Beam Forming, M0 to M7	2	8	23.1	24.6	26.9	34.9	36	1.1
	HT/VHT40 Beam Forming, M8 to M15	2	5	23.1	24.6	26.9	31.9	35	3.1
	HT/VHT40 STBC, M0 to M7	2	5	23.1	24.6	26.9	31.9	35	3.1
2462	CCK, 1 to 11 Mbps	1	5	22.9		22.9	27.9	35	7.1
	CCK, 1 to 11 Mbps	2	5	22.9	23.8	26.4	31.4	35	3.6
	Non HT20, 6 to 54 Mbps	1	5	19		19	24	35	11
	Non HT20, 6 to 54 Mbps	2	5	17.1	16.8	20	25	35	10
	Non HT20 Beam Forming, 6 to 54 Mbps	2	8	13.8	12.1	16	24	36	12
	HT/VHT20, M0 to M7	1	5	19.5		19.5	24.5	35	10.5
	HT/VHT20, M0 to M7	2	5	17.3	18.4	20.9	25.9	35	9.1
	HT/VHT20, M8 to M15	2	5	17.3	18.4	20.9	25.9	35	9.1
	HT/VHT20 Beam Forming, M0 to M7	2	8	15.2	15	18.1	26.1	36	9.9
	HT/VHT20 Beam Forming, M8 to M15	2	5	17.3	18.4	20.9	25.9	35	9.1
	HT/VHT20 STBC, M0 to M7	2	5	17.3	18.4	20.9	25.9	35	9.1

Peak Output Power, 2437 MHz, HT/VHT20 Beam Forming, M0 to M7



Antenna A



Antenna B



Antenna Gain: 6 dBi

Frequency (MHz)	Mode	Tx Paths	Correlated Antenna Gain (dBi)	Tx 1 Max Power (dBm)	Tx 2 Max Power (dBm)	Total Tx Channel Power (dBm)	Total Tx Channel Power (dBm) EIRP	Limit (dBm) EIRP	Margin (dB)
2412	CCK, 1 to 11 Mbps	1	6	23.8		23.8	29.8	36	6.2
	CCK, 1 to 11 Mbps	2	6	23.8	22.9	26.4	32.4	36	3.6
	Non HT20, 6 to 54 Mbps	1	6	22		22	28	36	8
	Non HT20, 6 to 54 Mbps	2	6	19.8	19.4	22.6	28.6	36	7.4
	Non HT20 Beam Forming, 6 to 54 Mbps	2	9	17.6	17.2	20.4	29.4	36	6.6
	HT/VHT20, M0 to M7	1	6	21.9		21.9	27.9	36	8.1
	HT/VHT20, M0 to M7	2	6	20.6	21	23.8	29.8	36	6.2
	HT/VHT20, M8 to M15	2	6	20.6	21	23.8	29.8	36	6.2
	HT/VHT20 Beam Forming, M0 to M7	2	9	17.8	17.4	20.6	29.6	36	6.4
	HT/VHT20 Beam Forming, M8 to M15	2	6	20.6	21	23.8	29.8	36	6.2
	HT/VHT20 STBC, M0 to M7	2	6	20.6	21	23.8	29.8	36	6.2
2422	Non HT40, 6 to 54 Mbps	1	6	16.5		16.5	22.5	36	13.5
	Non HT40, 6 to 54 Mbps	2	6	14.1	12.9	16.6	22.6	36	13.4
	HT/VHT40, M0 to M7	1	6	18.7		18.7	24.7	36	11.3
	HT/VHT40, M0 to M7	2	6	16.9	15.9	19.4	25.4	36	10.6
	HT/VHT40, M8 to M15	2	6	16.9	15.9	19.4	25.4	36	10.6
	HT/VHT40 Beam Forming, M0 to M7	2	9	16.9	15.9	19.4	28.4	36	7.6
	HT/VHT40 Beam Forming, M8 to M15	2	6	16.9	15.9	19.4	25.4	36	10.6
	HT/VHT40 STBC, M0 to M7	2	6	16.9	15.9	19.4	25.4	36	10.6
2437	Non HT40, 6 to 54 Mbps	1	6	24.4		24.4	30.4	36	5.6
	Non HT40, 6 to 54 Mbps	2	6	24.4	25	27.7	33.7	36	2.3
	HT/VHT40, M0 to M7	1	6	23.6		23.6	29.6	36	6.4
	HT/VHT40, M0 to M7	2	6	23.6	24.3	27	33	36	3
	HT/VHT40, M8 to M15	2	6	23.6	24.3	27	33	36	3
	HT/VHT40 Beam Forming, M0 to M7	2	9	23.6	24.3	27	36	36	0
	HT/VHT40 Beam Forming, M8 to M15	2	6	23.6	24.3	27	33	36	3
	HT/VHT40 STBC, M0 to M7	2	6	23.6	24.3	27	33	36	3
	CCK, 1 to 11 Mbps	1	6	23.6		23.6	29.6	36	6.4



	CCK, 1 to 11 Mbps	2	6	23.6	24.4	27	33	36	3
	Non HT20, 6 to 54 Mbps	1	6	23.7		23.7	29.7	36	6.3
	Non HT20, 6 to 54 Mbps	2	6	23.7	24.5	27.1	33.1	36	2.9
	Non HT20 Beam Forming, 6 to 54 Mbps	2	9	23.2	22.5	25.9	34.9	36	1.1
	HT/VHT20, M0 to M7	1	6	23.9		23.9	29.9	36	6.1
	HT/VHT20, M0 to M7	2	6	23.9	24.6	27.3	33.3	36	2.7
	HT/VHT20, M8 to M15	2	6	23.9	24.6	27.3	33.3	36	2.7
	HT/VHT20 Beam Forming, M0 to M7	2	9	23.3	22.6	26	35	36	1
	HT/VHT20 Beam Forming, M8 to M15	2	6	23.9	24.6	27.3	33.3	36	2.7
	HT/VHT20 STBC, M0 to M7	2	6	23.9	24.6	27.3	33.3	36	2.7
2452	Non HT40, 6 to 54 Mbps	1	6	24.1		24.1	30.1	36	5.9
	Non HT40, 6 to 54 Mbps	2	6	24.1	25.4	27.8	33.8	36	2.2
	HT/VHT40, M0 to M7	1	6	23.1		23.1	29.1	36	6.9
	HT/VHT40, M0 to M7	2	6	23.1	24.6	26.9	32.9	36	3.1
	HT/VHT40, M8 to M15	2	6	23.1	24.6	26.9	32.9	36	3.1
	HT/VHT40 Beam Forming, M0 to M7	2	9	23.1	24.6	26.9	35.9	36	0.1
	HT/VHT40 Beam Forming, M8 to M15	2	6	23.1	24.6	26.9	32.9	36	3.1
	HT/VHT40 STBC, M0 to M7	2	6	23.1	24.6	26.9	32.9	36	3.1
2462	CCK, 1 to 11 Mbps	1	6	22.9		22.9	28.9	36	7.1
	CCK, 1 to 11 Mbps	2	6	22.9	23.8	26.4	32.4	36	3.6
	Non HT20, 6 to 54 Mbps	1	6	19.3		19.3	25.3	36	10.7
	Non HT20, 6 to 54 Mbps	2	6	15.2	16.1	18.7	24.7	36	11.3
	Non HT20 Beam Forming, 6 to 54 Mbps	2	9	13.1	12.9	16	25	36	11
	HT/VHT20, M0 to M7	1	6	19.5		19.5	25.5	36	10.5
	HT/VHT20, M0 to M7	2	6	15.2	15	18.1	24.1	36	11.9
	HT/VHT20, M8 to M15	2	6	15.2	15	18.1	24.1	36	11.9
	HT/VHT20 Beam Forming, M0 to M7	2	9	14	12.3	16.2	25.2	36	10.8
	HT/VHT20 Beam Forming, M8 to M15	2	6	15.2	15	18.1	24.1	36	11.9
	HT/VHT20 STBC, M0 to M7	2	6	15.2	15	18.1	24.1	36	11.9

Peak Output Power, 2437 MHz, HT/VHT40 Beam Forming, M0 to M7



Antenna A



Antenna B



Antenna Gain: 8 dBi

Frequency (MHz)	Mode	Tx Paths	Correlated Antenna Gain (dBi)	Tx 1 Max Power (dBm)	Tx 2 Max Power (dBm)	Total Tx Channel Power (dBm)	Total Tx Channel Power (dBm) EIRP	Limit (dBm) EIRP	Margin (dB)
2412	CCK, 1 to 11 Mbps	1	8	23.8		23.8	31.8	36	4.2
	CCK, 1 to 11 Mbps	2	8	23.8	22.9	26.4	34.4	36	1.6
	Non HT20, 6 to 54 Mbps	1	8	21.7		21.7	29.7	36	6.3
	Non HT20, 6 to 54 Mbps	2	8	19.8	19.4	22.6	30.6	36	5.4
	Non HT20 Beam Forming, 6 to 54 Mbps	2	11	14.5	15	17.8	28.8	36	7.2
	HT/VHT20, M0 to M7	1	8	20.6		20.6	28.6	36	7.4
	HT/VHT20, M0 to M7	2	8	17.8	17.4	20.6	28.6	36	7.4
	HT/VHT20, M8 to M15	2	8	17.8	17.4	20.6	28.6	36	7.4
	HT/VHT20 Beam Forming, M0 to M7	2	11	14.6	15.1	17.9	28.9	36	7.1
	HT/VHT20 Beam Forming, M8 to M15	2	8	17.8	17.4	20.6	28.6	36	7.4
	HT/VHT20 STBC, M0 to M7	2	8	17.8	17.4	20.6	28.6	36	7.4
2422	Non HT40, 6 to 54 Mbps	1	8	16.5		16.5	24.5	36	11.5
	Non HT40, 6 to 54 Mbps	2	8	13	13.1	16.1	24.1	36	11.9
	HT/VHT40, M0 to M7	1	8	19		19	27	36	9
	HT/VHT40, M0 to M7	2	8	16.9	15.9	19.4	27.4	36	8.6
	HT/VHT40, M8 to M15	2	8	16.9	15.9	19.4	27.4	36	8.6
	HT/VHT40 Beam Forming, M0 to M7	2	11	10.9	10.9	13.9	24.9	36	11.1
	HT/VHT40 Beam Forming, M8 to M15	2	8	16.9	15.9	19.4	27.4	36	8.6
	HT/VHT40 STBC, M0 to M7	2	8	16.9	15.9	19.4	27.4	36	8.6
2437	Non HT40, 6 to 54 Mbps	1	8	24.4		24.4	32.4	36	3.6
	Non HT40, 6 to 54 Mbps	2	8	24.4	25	27.7	35.7	36	0.3
	HT/VHT40, M0 to M7	1	8	23.6		23.6	31.6	36	4.4
	HT/VHT40, M0 to M7	2	8	23.6	24.3	27	35	36	1
	HT/VHT40, M8 to M15	2	8	23.6	24.3	27	35	36	1
	HT/VHT40 Beam Forming, M0 to M7	2	11	21.5	22.1	24.8	35.8	36	0.2
	HT/VHT40 Beam Forming, M8 to M15	2	8	23.6	24.3	27	35	36	1
	HT/VHT40 STBC, M0 to M7	2	8	23.6	24.3	27	35	36	1
	CCK, 1 to 11 Mbps	1	8	23.6		23.6	31.6	36	4.4



	CCK, 1 to 11 Mbps	2	8	23.6	24.4	27	35	36	1
	Non HT20, 6 to 54 Mbps	1	8	23.7		23.7	31.7	36	4.3
	Non HT20, 6 to 54 Mbps	2	8	23.7	24.5	27.1	35.1	36	0.9
	Non HT20 Beam Forming, 6 to 54 Mbps	2	11	21.5	22.2	24.9	35.9	36	0.1
	HT/VHT20, M0 to M7	1	8	23.9		23.9	31.9	36	4.1
	HT/VHT20, M0 to M7	2	8	23.9	24.6	27.3	35.3	36	0.7
	HT/VHT20, M8 to M15	2	8	23.9	24.6	27.3	35.3	36	0.7
	HT/VHT20 Beam Forming, M0 to M7	2	11	21.6	22.3	25	36	36	0
	HT/VHT20 Beam Forming, M8 to M15	2	8	23.9	24.6	27.3	35.3	36	0.7
	HT/VHT20 STBC, M0 to M7	2	8	23.9	24.6	27.3	35.3	36	0.7
2452	Non HT40, 6 to 54 Mbps	1	8	24.1		24.1	32.1	36	3.9
	Non HT40, 6 to 54 Mbps	2	8	24.1	25.4	27.8	35.8	36	0.2
	HT/VHT40, M0 to M7	1	8	23.1		23.1	31.1	36	4.9
	HT/VHT40, M0 to M7	2	8	23.1	24.6	26.9	34.9	36	1.1
	HT/VHT40, M8 to M15	2	8	23.1	24.6	26.9	34.9	36	1.1
	HT/VHT40 Beam Forming, M0 to M7	2	11	20.9	22.4	24.7	35.7	36	0.3
	HT/VHT40 Beam Forming, M8 to M15	2	8	23.1	24.6	26.9	34.9	36	1.1
	HT/VHT40 STBC, M0 to M7	2	8	23.1	24.6	26.9	34.9	36	1.1
2462	CCK, 1 to 11 Mbps	1	8	22.9		22.9	30.9	36	5.1
	CCK, 1 to 11 Mbps	2	8	22.8	22.4	25.6	33.6	36	2.4
	Non HT20, 6 to 54 Mbps	1	8	17.2		17.2	25.2	36	10.8
	Non HT20, 6 to 54 Mbps	2	8	13.8	12.1	16	24	36	12
	Non HT20 Beam Forming, 6 to 54 Mbps	2	11	9.2	10.1	12.7	23.7	36	12.3
	HT/VHT20, M0 to M7	1	8	17.3		17.3	25.3	36	10.7
	HT/VHT20, M0 to M7	2	8	15.2	15	18.1	26.1	36	9.9
	HT/VHT20, M8 to M15	2	8	15.2	15	18.1	26.1	36	9.9
	HT/VHT20 Beam Forming, M0 to M7	2	11	11.3	12.3	14.8	25.8	36	10.2
	HT/VHT20 Beam Forming, M8 to M15	2	8	15.2	15	18.1	26.1	36	9.9
	HT/VHT20 STBC, M0 to M7	2	8	15.2	15	18.1	26.1	36	9.9

Peak Output Power, 2437 MHz, HT/VHT20 Beam Forming, M0 to M7



Antenna A

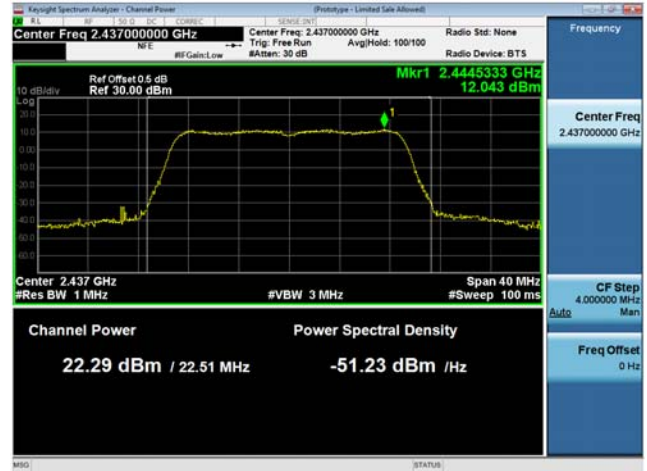

Antenna B



Antenna Gain: 13 dBi

Frequency (MHz)	Mode	Tx Paths	Correlated Antenna Gain (dBi)	Tx 1 Max Power (dBm)	Tx 2 Max Power (dBm)	Total Tx Channel Power (dBm)	Total Tx Channel Power (dBm) EIRP	Limit (dBm) EIRP	Margin (dB)
2412	CCK, 1 to 11 Mbps	1	13	22.5		22.5	35.5	36	0.5
	CCK, 1 to 11 Mbps	2	13	20.1	19.7	22.9	35.9	36	0.1
	Non HT20, 6 to 54 Mbps	1	13	17.6		17.6	30.6	36	5.4
	Non HT20, 6 to 54 Mbps	2	13	14.5	15	17.8	30.8	36	5.2
	Non HT20 Beam Forming, 6 to 54 Mbps	2	13	14.5	15	17.8	30.8	36	5.2
	HT/VHT20, M0 to M7	1	13	16.8		16.8	29.8	36	6.2
	HT/VHT20, M0 to M7	2	13	14.6	15.1	17.9	30.9	36	5.1
	HT/VHT20, M8 to M15	2	13	14.6	15.1	17.9	30.9	36	5.1
	HT/VHT20 Beam Forming, M0 to M7	2	13	14.6	15.1	17.9	30.9	36	5.1
	HT/VHT20 Beam Forming, M8 to M15	2	13	14.6	15.1	17.9	30.9	36	5.1
	HT/VHT20 STBC, M0 to M7	2	13	14.6	15.1	17.9	30.9	36	5.1
2422	Non HT40, 6 to 54 Mbps	1	13	10		10	23	36	13
	Non HT40, 6 to 54 Mbps	2	13	10	10	13	26	36	10
	HT/VHT40, M0 to M7	1	13	13.8		13.8	26.8	36	9.2
	HT/VHT40, M0 to M7	2	13	8.9	8.8	11.9	24.9	36	11.1
	HT/VHT40, M8 to M15	2	13	8.9	8.8	11.9	24.9	36	11.1
	HT/VHT40 Beam Forming, M0 to M7	2	13	8.9	8.8	11.9	24.9	36	11.1
	HT/VHT40 Beam Forming, M8 to M15	2	13	8.9	8.8	11.9	24.9	36	11.1
	HT/VHT40 STBC, M0 to M7	2	13	8.9	8.8	11.9	24.9	36	11.1
2437	Non HT40, 6 to 54 Mbps	1	13	22.4		22.4	35.4	36	0.6
	Non HT40, 6 to 54 Mbps	2	13	20.2	19.4	22.8	35.8	36	0.2
	HT/VHT40, M0 to M7	1	13	21.5		21.5	34.5	36	1.5
	HT/VHT40, M0 to M7	2	13	19.5	20.4	23	36	36	0
	HT/VHT40, M8 to M15	2	13	19.5	20.4	23	36	36	0
	HT/VHT40 Beam Forming, M0 to M7	2	13	19.5	20.4	23	36	36	0
	HT/VHT40 Beam Forming, M8 to M15	2	13	19.5	20.4	23	36	36	0
	HT/VHT40 STBC, M0 to M7	2	13	19.5	20.4	23	36	36	0



	CCK, 1 to 11 Mbps	1	13	21.5		21.5	34.5	36	1.5
	CCK, 1 to 11 Mbps	2	13	19.4	18.7	22.1	35.1	36	0.9
	Non HT20, 6 to 54 Mbps	1	13	21.5		21.5	34.5	36	1.5
	Non HT20, 6 to 54 Mbps	2	13	19.1	18.5	21.8	34.8	36	1.2
	Non HT20 Beam Forming, 6 to 54 Mbps	2	13	19.1	18.5	21.8	34.8	36	1.2
	HT/VHT20, M0 to M7	1	13	21.6		21.6	34.6	36	1.4
	HT/VHT20, M0 to M7	2	13	19.3	18.6	22	35	36	1
	HT/VHT20, M8 to M15	2	13	19.3	18.6	22	35	36	1
	HT/VHT20 Beam Forming, M0 to M7	2	13	19.3	18.6	22	35	36	1
	HT/VHT20 Beam Forming, M8 to M15	2	13	19.3	18.6	22	35	36	1
	HT/VHT20 STBC, M0 to M7	2	13	19.3	18.6	22	35	36	1
2452	Non HT40, 6 to 54 Mbps	1	13	22.1		22.1	35.1	36	0.9
	Non HT40, 6 to 54 Mbps	2	13	18	19.4	21.8	34.8	36	1.2
	HT/VHT40, M0 to M7	1	13	20.9		20.9	33.9	36	2.1
	HT/VHT40, M0 to M7	2	13	19	20.4	22.8	35.8	36	0.2
	HT/VHT40, M8 to M15	2	13	19	20.4	22.8	35.8	36	0.2
	HT/VHT40 Beam Forming, M0 to M7	2	13	19	20.4	22.8	35.8	36	0.2
	HT/VHT40 Beam Forming, M8 to M15	2	13	19	20.4	22.8	35.8	36	0.2
	HT/VHT40 STBC, M0 to M7	2	13	19	20.4	22.8	35.8	36	0.2
2462	CCK, 1 to 11 Mbps	1	13	20.9		20.9	33.9	36	2.1
	CCK, 1 to 11 Mbps	2	13	19	20.1	22.6	35.6	36	0.4
	Non HT20, 6 to 54 Mbps	1	13	13.1		13.1	26.1	36	9.9
	Non HT20, 6 to 54 Mbps	2	13	9.9	8.2	12.1	25.1	36	10.9
	Non HT20 Beam Forming, 6 to 54 Mbps	2	13	9.9	8.2	12.1	25.1	36	10.9
	HT/VHT20, M0 to M7	1	13	11.3		11.3	24.3	36	11.7
	HT/VHT20, M0 to M7	2	13	11.4	10.9	14.2	27.2	36	8.8
	HT/VHT20, M8 to M15	2	13	11.4	10.9	14.2	27.2	36	8.8
	HT/VHT20 Beam Forming, M0 to M7	2	13	11.4	10.9	14.2	27.2	36	8.8
	HT/VHT20 Beam Forming, M8 to M15	2	13	11.4	10.9	14.2	27.2	36	8.8
	HT/VHT20 STBC, M0 to M7	2	13	11.4	10.9	14.2	27.2	36	8.8

Peak Output Power, 2437 MHz, HT/VHT40, M0 to M7

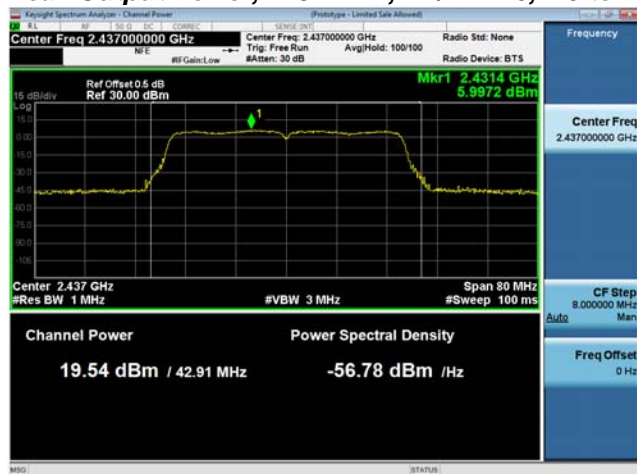

Antenna A

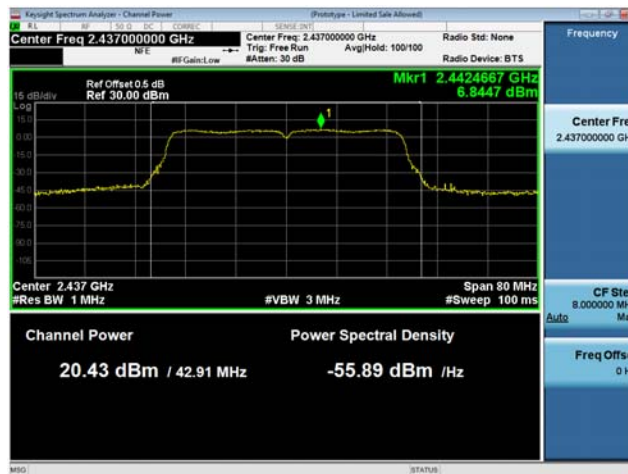

Antenna B



A.4 Power Spectral Density

15.247 / RSS-247 / LP0002:3.10.1(6.2.2) For digitally modulated systems, the peak power spectral density conducted from the intentional radiator to the antenna shall not be greater than 8 dBm in any 3 kHz band during any time interval of continuous transmission.

Test Procedure

Ref. KDB 558074 D01 DTS Meas Guidance v03r05
ANSI C63.10: 2013

Power Spectral Density Test Procedure
1. Set the radio in the continuous transmitting mode at full power 2. Configure Spectrum analyzer as per test parameters below and Peak search marker 3. Capture graphs and record pertinent measurement data.

Ref. 558074 D01 DTS Meas Guidance v03r05 section 10.2 Peak PSD
ANSI C63.10: 2013 section 11.10.2 Peak PSD

Power Spectral Density Test parameters
Span = >1.5 times the OBW RBW = 3 kHz ≤ RBW ≤ 100 kHz. VBW ≥ 3 x RBW Sweep = Auto couple Detector = Peak Trace = Trace Average 100

The "Measure and add 10 log(N) dB technique", where N is the number of outputs, is used for measuring in-band Power Spectral Density. . (See ANSI C63.10 section 14.3.2.3)

System Number	Description	Samples	System under test	Support equipment
1	EUT	S01	<input checked="" type="checkbox"/>	<input type="checkbox"/>
	Support	S02	<input type="checkbox"/>	<input checked="" type="checkbox"/>

Tested By : Jose Aguirre	Date of testing: 20-April-16 - 08-Aug-16
Test Result : PASS	

See Appendix C for list of test equipment

Frequency (MHz)	Mode	Data Rate (Mbps)	PSD / Antenna (dBm/3kHz)	Total PSD (dBm/3kHz)	Limit (dBm/3kHz)	Margin (dB)
2412	CCK, 1 to 11 Mbps	11	0.1	3.1	8	4.9
	Non HT20, 6 to 54 Mbps	6	-4.5	-1.5	8	9.5
	HT/VHT20, M0 to M15	m0	-4.7	-1.7	8	9.7
2422	Non HT40, 6 to 54 Mbps	6	-11.0	-8.0	8	16.0
	HT/VHT40, M0 to M15	m0	-10.2	-7.2	8	15.2
2437	Non HT40, 6 to 54 Mbps	6	-6.8	-3.8	8	11.8
	HT/VHT40, M0 to M15	m0	-5.8	-2.8	8	10.8
	CCK, 1 to 11 Mbps	11	0.1	3.1	8	4.9
	Non HT20, 6 to 54 Mbps	6	-4.3	-1.3	8	9.3
	HT/VHT20, M0 to M15	m0	-3.8	-0.8	8	8.8
2452	Non HT40, 6 to 54 Mbps	6	-5.4	-2.4	8	10.4
	HT/VHT40, M0 to M15	m0	-6.1	-3.1	8	11.1
2462	CCK, 1 to 11 Mbps	11	-0.7	2.3	8	5.7
	Non HT20, 6 to 54 Mbps	6	-9.5	-6.5	8	14.5
	HT/VHT20, M0 to M15	m0	-7.3	-4.3	8	12.3

Power Spectral Density, 2412 MHz, CCK, 1 to 11 Mbps

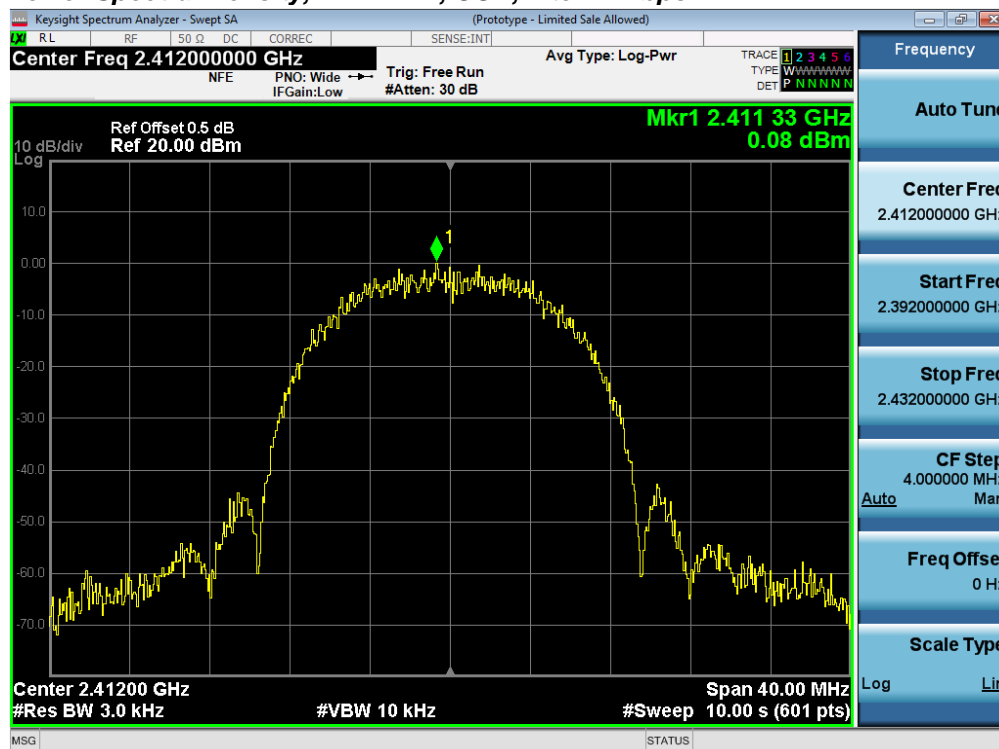

Power Spectral Density, 2412 MHz, Non HT20, 6 to 54 Mbps



Power Spectral Density, 2412 MHz, HT/VHT20, M0 to M15

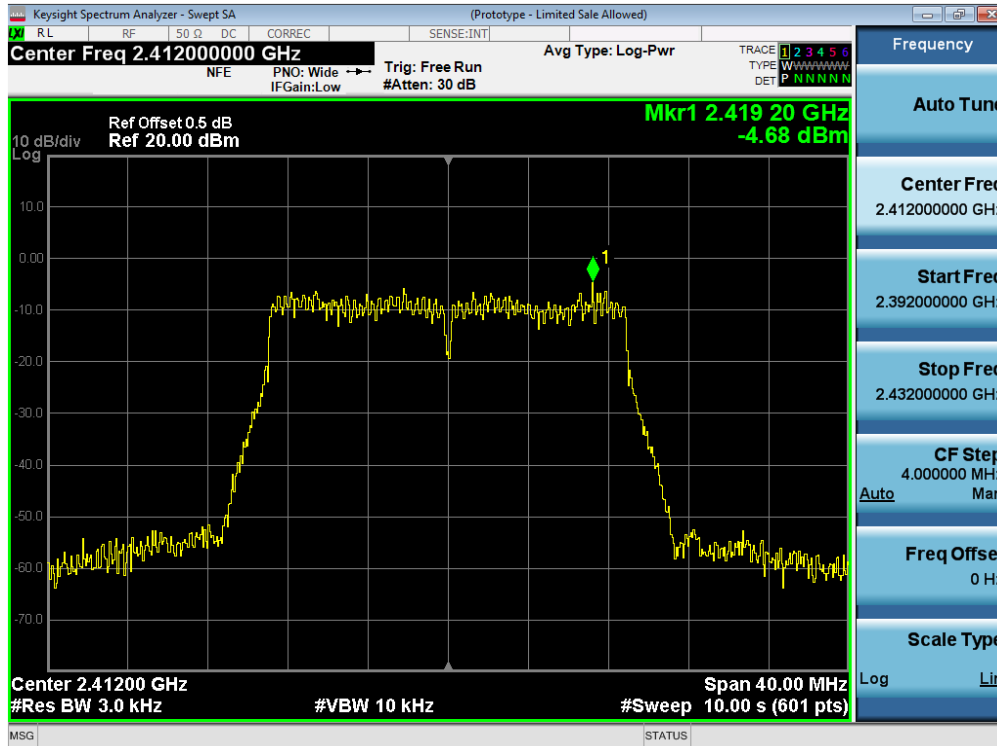

Power Spectral Density, 2422 MHz, Non HT40, 6 to 54 Mbps

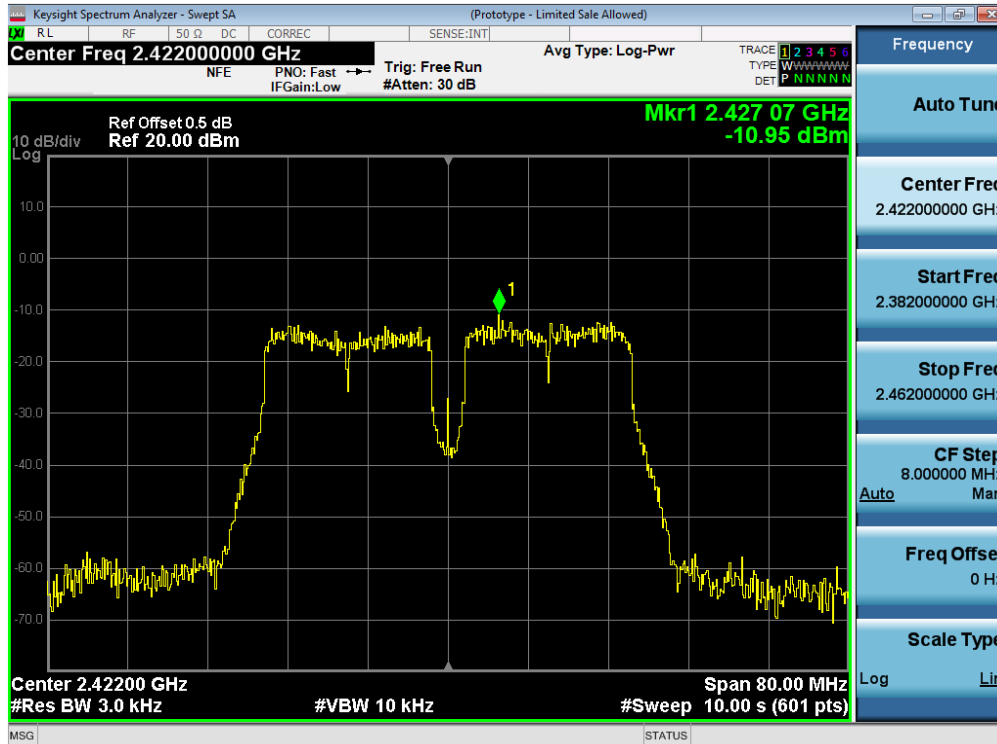

Power Spectral Density, 2422 MHz, HT/VHT40, M0 to M15

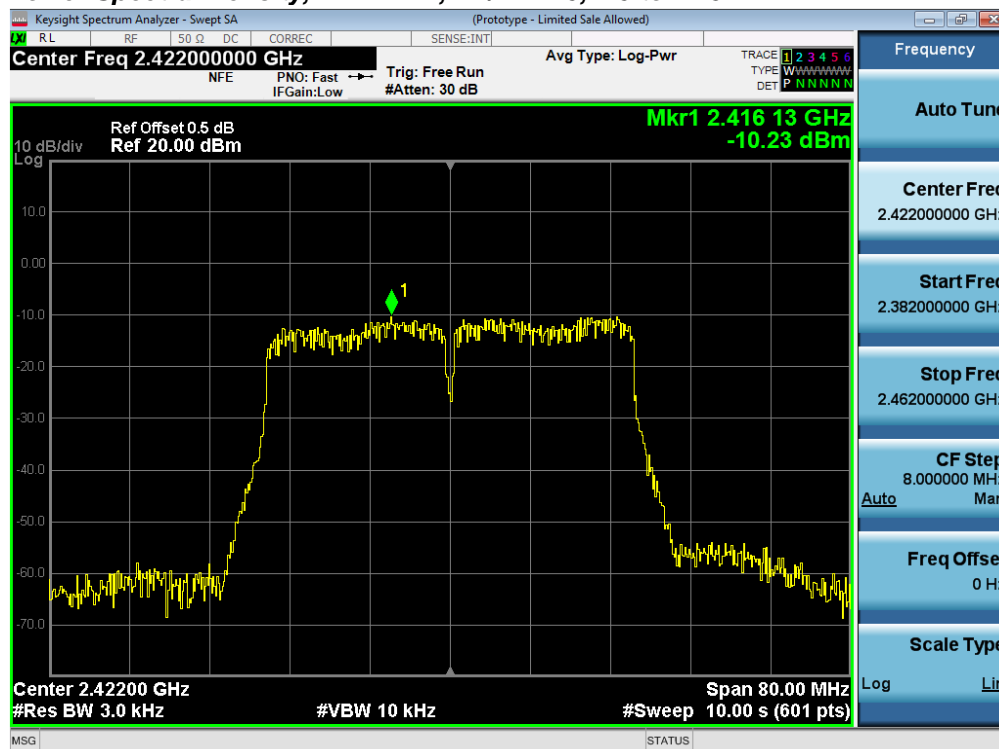

Power Spectral Density, 2437 MHz, Non HT40, 6 to 54 Mbps

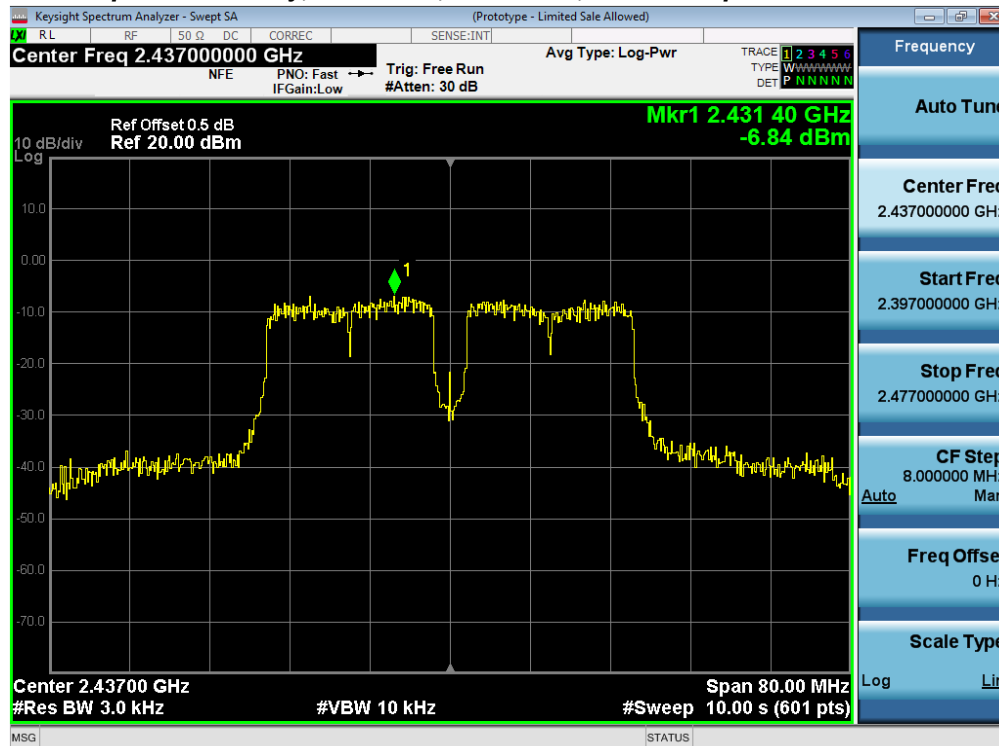

Power Spectral Density, 2437 MHz, HT/VHT40, M0 to M15



Power Spectral Density, 2437 MHz, CCK, 1 to 11 Mbps

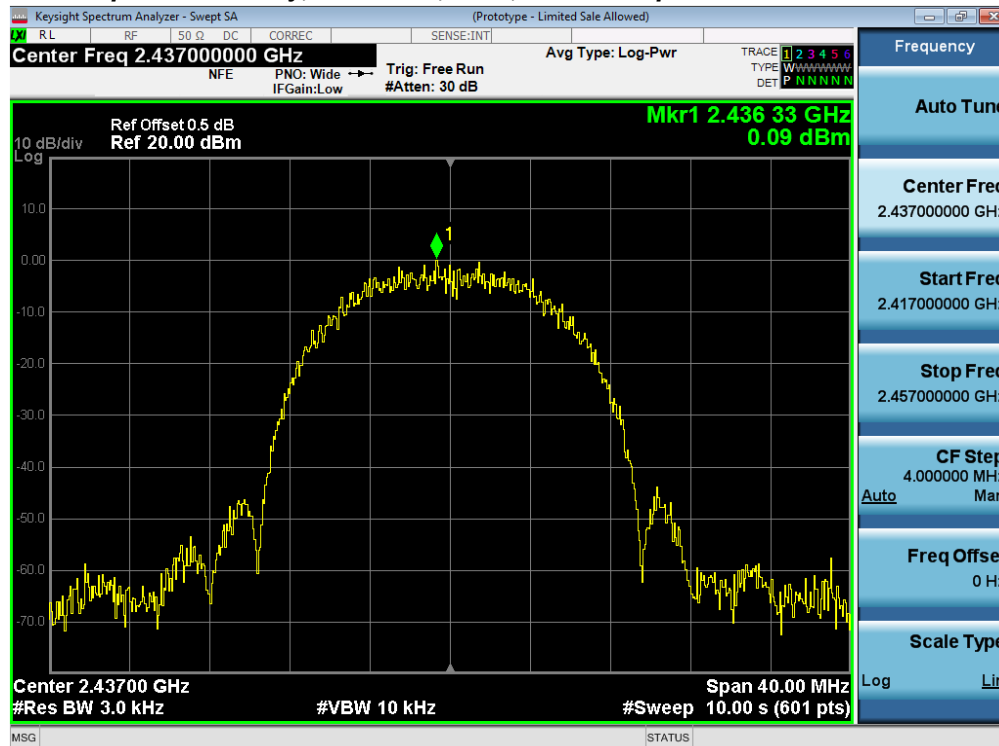

Power Spectral Density, 2437 MHz, Non HT20, 6 to 54 Mbps

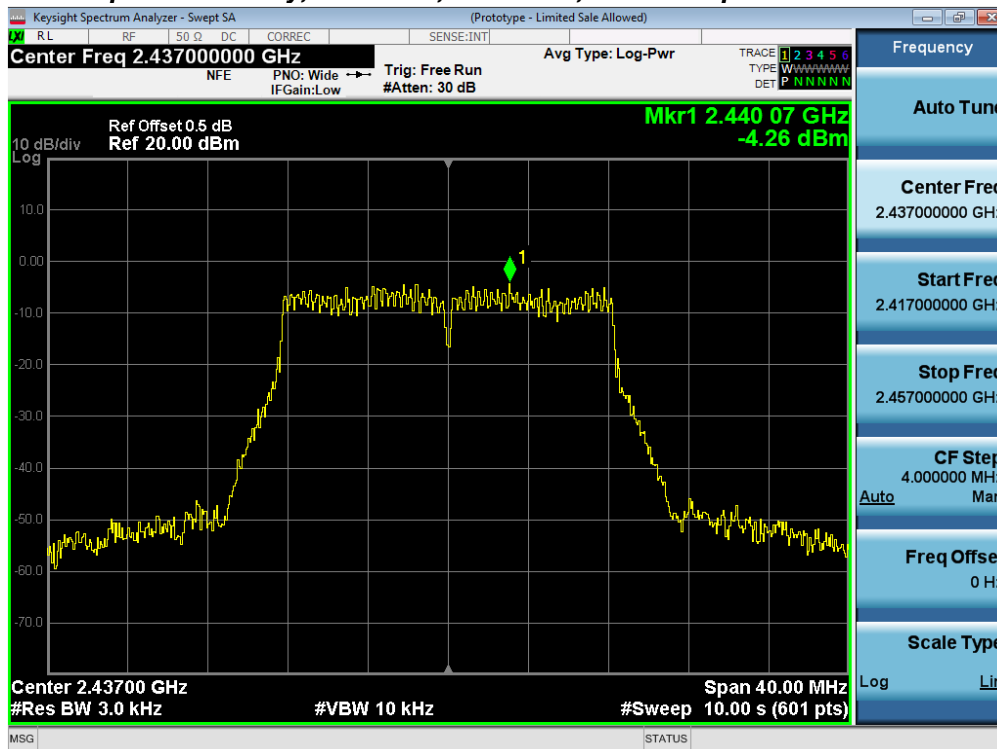

Power Spectral Density, 2437 MHz, HT/VHT20, M0 to M15

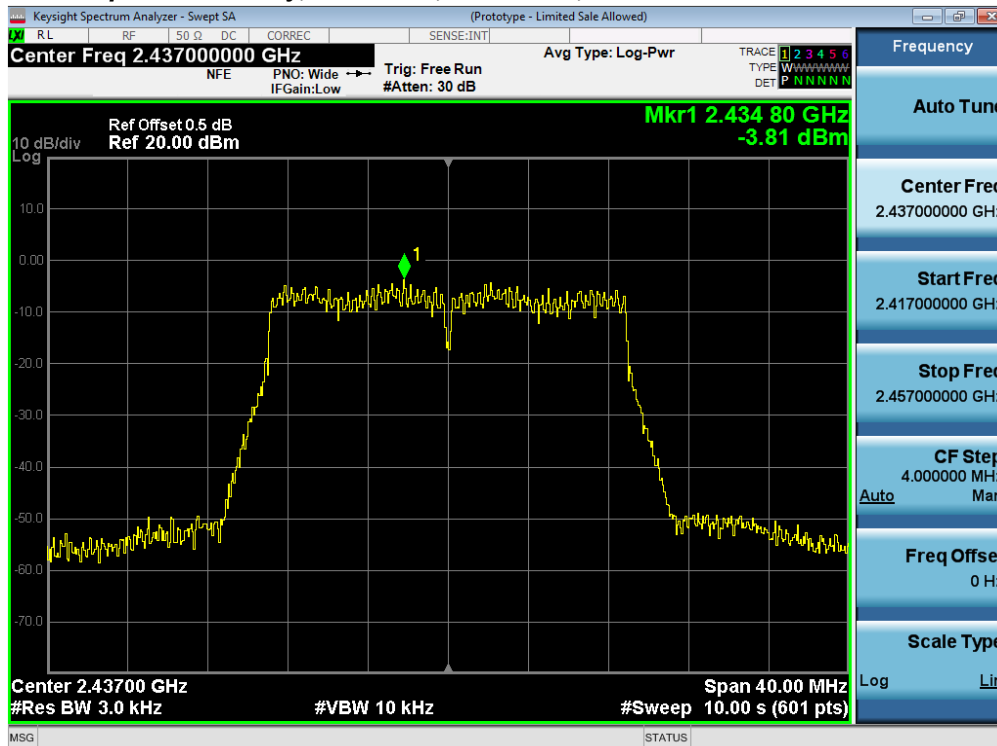

Power Spectral Density, 2452 MHz, Non HT40, 6 to 54 Mbps

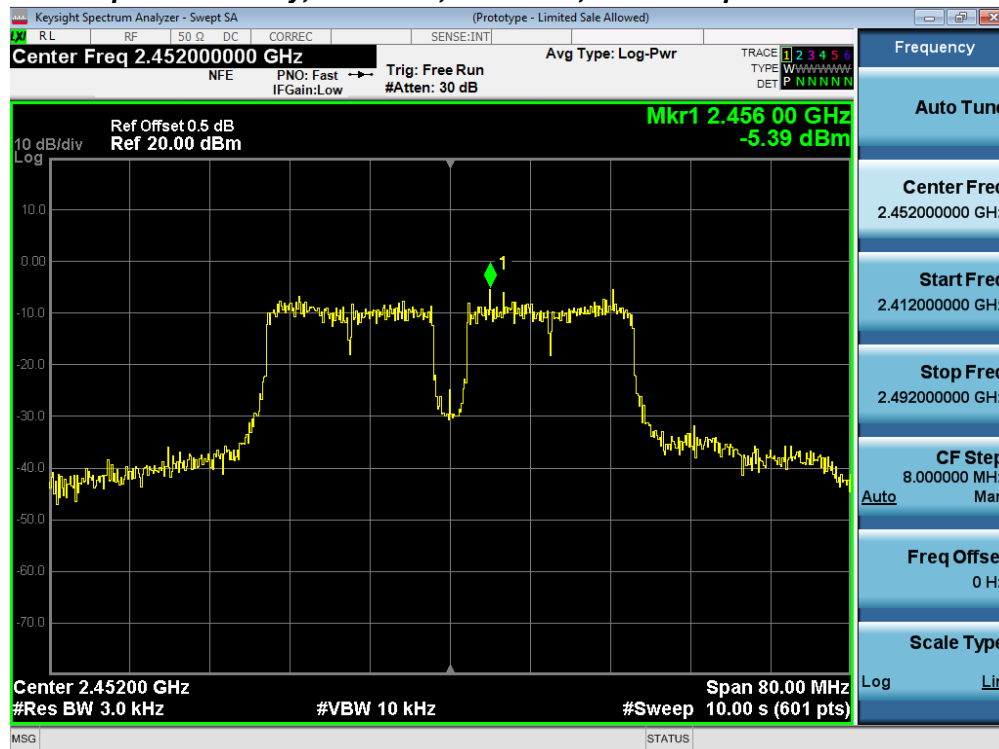

Power Spectral Density, 2452 MHz, HT/VHT40, M0 to M15

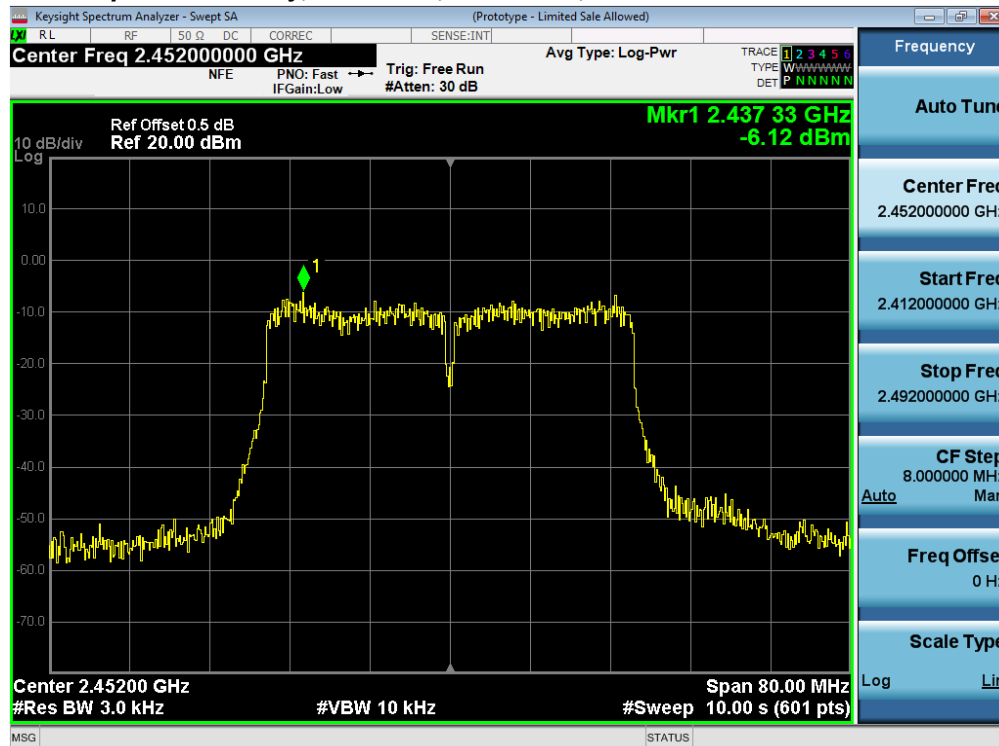

Power Spectral Density, 2462 MHz, CCK, 1 to 11 Mbps

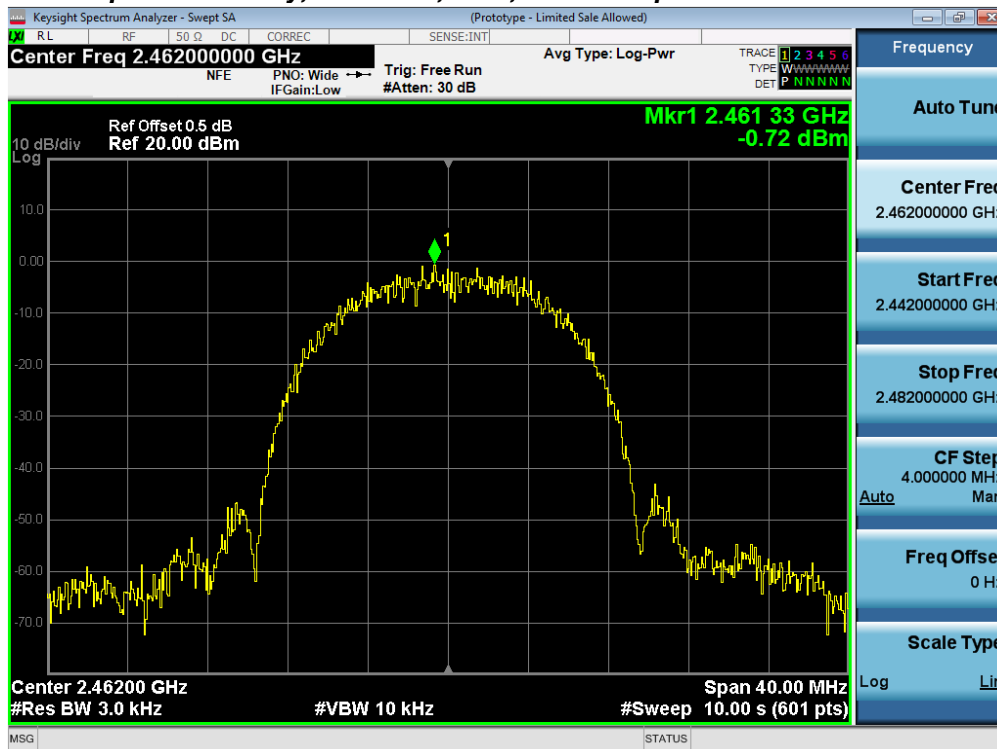

Power Spectral Density, 2462 MHz, Non HT20, 6 to 54 Mbps

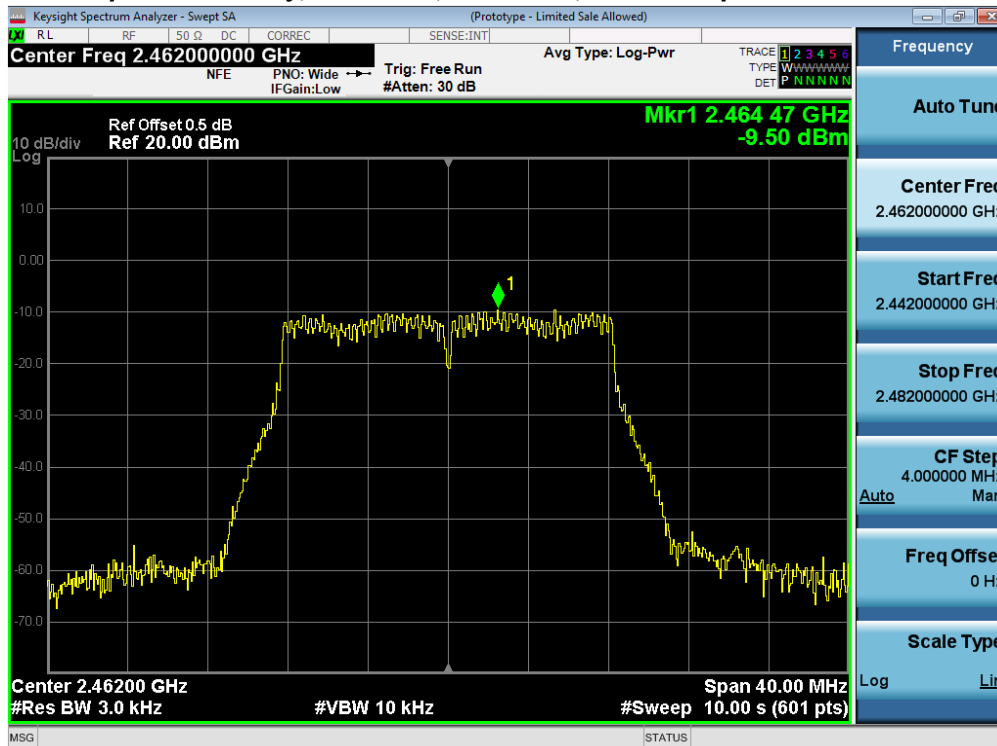

Power Spectral Density, 2462 MHz, HT/VHT20, M0 to M15





A.5 Conducted Spurious Emissions

15.205 / 15.209 / LP0002 - Radiated emissions which fall in the restricted bands, as defined in Section 15.205(a), must also comply with the radiated emission limits specified in Section 15.209(a) (see Section 15.205(c)).

RSS-Gen 8.9: Except when the requirements applicable to a given device state otherwise, emissions from licence-exempt transmitters shall comply with the field strength limits shown in Table 4 and Table 5 below. Additionally, the level of any transmitter emission shall not exceed the level of the transmitter’s fundamental emission.

RSS-Gen 8.10 (b) Unwanted emissions that fall into restricted bands of Table 6 shall comply with the limits specified in RSS-Gen; and **(c)** Unwanted emissions that do not fall within the restricted frequency bands of Table 6 shall comply either with the limits specified in the applicable RSS or with those specified in this RSS-Gen.

Use formula below to substitute conducted measurements in place of radiated measurements

$$E[\text{dB}\mu\text{V}/\text{m}] = \text{EIRP}[\text{dBm}] - 20 \log(d[\text{meters}]) + 104.77, \text{ where } E = \text{field strength and } d = 3 \text{ meter}$$

- 1) Average Plot, Limit= -41.25 dBm eirp
- 2) Peak plot, Limit = -21.25 dBm eirp

Test Procedure

Ref. KDB 558074 D01 DTS Meas Guidance v03r05
ANSI C63.10: 2013

<p>Conducted Spurious Emissions Test Procedure</p>
<ol style="list-style-type: none"> 1. Connect the antenna port(s) to the spectrum analyzer input. 2. Place the radio in continuous transmit mode 3. Configure Spectrum analyzer as per test parameters below (be sure to enter all losses between the transmitter output and the spectrum analyzer). 4. Use the peak marker function to determine the maximum spurs amplitude level. 5. The “measure-and-sum technique” is used for measuring in-band transmit power of a device. In the measure-and-sum approach, the conducted emission level is measured at each antenna port. The measured results at the various antenna ports are then summed mathematically to determine the total emission level from the device. Summing is performed in linear power units. The worst case output is recorded. (see ANSI C63.10 2013 section 14.3.2.2) 6. Capture graphs and record pertinent measurement data.

Ref. 558074 D01 DTS Meas Guidance v03r05 section 11.1b, 11.2-3, 12.2.4 & 12.2.5.3
ANSI C63.10: 2013 section 11.10.3 & 11.12.2.4 & 11.12.2.5.3

<p>Conducted Spurious Emissions Test parameters</p>
<p>Span = 30 MHz-26 GHz RBW = 100 kHz. VBW ≥ 3 x RBW Sweep = Auto couple Detector = Peak Trace = Max Hold</p>

KDB: 558074 D01 DTS Meas Guidance v03r05 section 12.2.2 © add the max antenna gain + ground reflection factor (4.7 dB for frequencies between 30 MHz and 1000 MHz, and 0 dB for frequencies > 1000 MHz).



System Number	Description	Samples	System under test	Support equipment
1	EUT	S01	<input checked="" type="checkbox"/>	<input type="checkbox"/>
	Support	S02	<input type="checkbox"/>	<input checked="" type="checkbox"/>

Tested By : Jose Aguirre	Date of testing: 20-April-16 - 08-Aug-16
Test Result : PASS	

See Appendix C for list of test equipment

Note: Radiated measurements have demonstrated that spurious emissions at the band edges are not correlated and therefore no array gain factor is used.

Conducted Spurs Average Upper, All Antennas

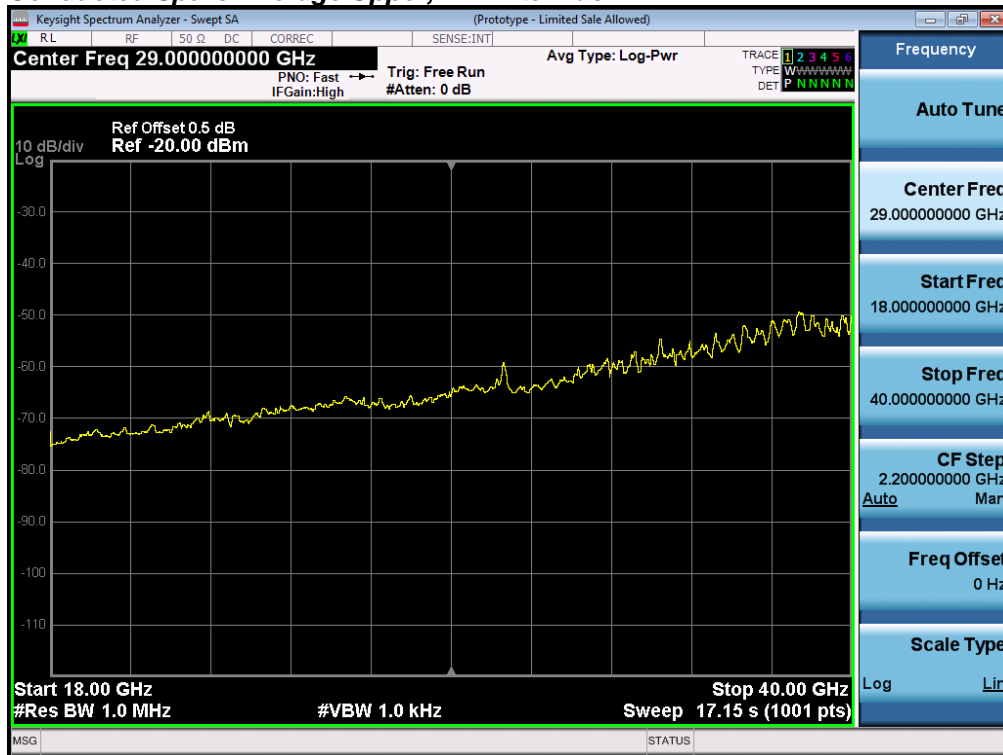

Conducted Spurs Peak Upper, All Antennas

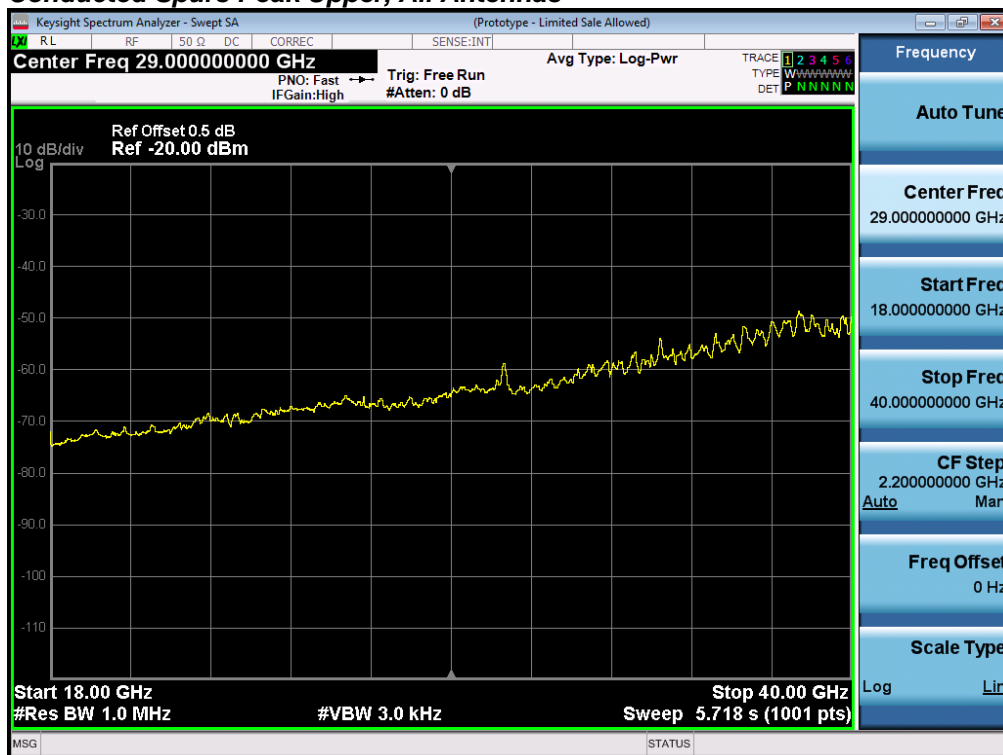



Conducted Spurious Emission results below represent the worst case for all antenna gain

Antenna Gain: 13 dBi

Frequency (MHz)	Mode	Tx Paths	Correlated Antenna Gain (dBi)	Tx 1 Spur Power (dBm)	Tx 2 Spur Power (dBm)	Total Conducted Spur (dBm)	Limit (dBm)	Margin (dB)
2412	CCK, 1 to 11 Mbps	1	13	-73.1		-60.1	-41.25	18.9
	CCK, 1 to 11 Mbps	2	13	-73.3	-73.2	-57.2	-41.25	16.0
	Non HT20, 6 to 54 Mbps	1	13	-73.5		-60.5	-41.25	19.3
	Non HT20, 6 to 54 Mbps	2	13	-71.7	-73.7	-56.6	-41.25	15.3
	Non HT20 Beam Forming, 6 to 54 Mbps	2	13	-71.7	-73.7	-56.6	-41.25	15.3
	HT/VHT20, M0 to M7	1	13	-73.4		-60.4	-41.25	19.2
	HT/VHT20, M0 to M7	2	13	-73.4	-73.4	-57.4	-41.25	16.1
	HT/VHT20, M8 to M15	2	13	-73.4	-73.4	-57.4	-41.25	16.1
	HT/VHT20 Beam Forming, M0 to M7	2	13	-73.4	-73.4	-57.4	-41.25	16.1
	HT/VHT20 Beam Forming, M8 to M15	2	13	-73.4	-73.4	-57.4	-41.25	16.1
	HT/VHT20 STBC, M0 to M7	2	13	-73.4	-73.4	-57.4	-41.25	16.1
2422	Non HT40, 6 to 54 Mbps	1	13	-73.8		-60.8	-41.25	19.6
	Non HT40, 6 to 54 Mbps	2	13	-73.8	-73.3	-57.5	-41.25	16.3
	HT/VHT40, M0 to M7	1	13	-73.5		-60.5	-41.25	19.3
	HT/VHT40, M0 to M7	2	13	-73.6	-73.4	-57.5	-41.25	16.2
	HT/VHT40, M8 to M15	2	13	-73.6	-73.4	-57.5	-41.25	16.2
	HT/VHT40 Beam Forming, M0 to M7	2	13	-73.6	-73.4	-57.5	-41.25	16.2
	HT/VHT40 Beam Forming, M8 to M15	2	13	-73.6	-73.4	-57.5	-41.25	16.2
	HT/VHT40 STBC, M0 to M7	2	13	-73.6	-73.4	-57.5	-41.25	16.2
2437	Non HT40, 6 to 54 Mbps	1	13	-73.4		-60.4	-41.25	19.2
	Non HT40, 6 to 54 Mbps	2	13	-73.6	-73.6	-57.6	-41.25	16.3
	HT/VHT40, M0 to M7	1	13	-73.6		-60.6	-41.25	19.4
	HT/VHT40, M0 to M7	2	13	-73.4	-73.6	-57.5	-41.25	16.2
	HT/VHT40, M8 to M15	2	13	-73.4	-73.6	-57.5	-41.25	16.2
	HT/VHT40 Beam Forming, M0 to M7	2	13	-73.4	-73.6	-57.5	-41.25	16.2
	HT/VHT40 Beam Forming, M8 to M15	2	13	-73.4	-73.6	-57.5	-41.25	16.2
	HT/VHT40 STBC, M0 to M7	2	13	-73.4	-73.6	-57.5	-41.25	16.2
	CCK, 1 to 11 Mbps	1	13	-76.2		-63.2	-41.25	22.0
	CCK, 1 to 11 Mbps	2	13	-73.6	-73.6	-57.6	-41.25	16.3
	Non HT20, 6 to 54 Mbps	1	13	-76.4		-63.4	-41.25	22.2
	Non HT20, 6 to 54 Mbps	2	13	-73.7	-73.5	-57.6	-41.25	16.3



	Non HT20 Beam Forming, 6 to 54 Mbps	2	13	-73.7	-73.5	-57.6	-41.25	16.3
	HT/VHT20, M0 to M7	1	13	-73.2		-60.2	-41.25	19.0
	HT/VHT20, M0 to M7	2	13	-73.5	-73.6	-57.5	-41.25	16.3
	HT/VHT20, M8 to M15	2	13	-73.5	-73.6	-57.5	-41.25	16.3
	HT/VHT20 Beam Forming, M0 to M7	2	13	-73.5	-73.6	-57.5	-41.25	16.3
	HT/VHT20 Beam Forming, M8 to M15	2	13	-73.5	-73.6	-57.5	-41.25	16.3
	HT/VHT20 STBC, M0 to M7	2	13	-73.5	-73.6	-57.5	-41.25	16.3
2452	Non HT40, 6 to 54 Mbps	1	13	-70.3		-57.3	-41.25	16.1
	Non HT40, 6 to 54 Mbps	2	13	-72.4	-73.3	-56.8	-41.25	15.6
	HT/VHT40, M0 to M7	1	13	-71.0		-58.0	-41.25	16.8
	HT/VHT40, M0 to M7	2	13	-71.5	-73.3	-56.3	-41.25	15.0
	HT/VHT40, M8 to M15	2	13	-71.5	-73.3	-56.3	-41.25	15.0
	HT/VHT40 Beam Forming, M0 to M7	2	13	-71.5	-73.3	-56.3	-41.25	15.0
	HT/VHT40 Beam Forming, M8 to M15	2	13	-71.5	-73.3	-56.3	-41.25	15.0
	HT/VHT40 STBC, M0 to M7	2	13	-71.5	-73.3	-56.3	-41.25	15.0
2462	CCK, 1 to 11 Mbps	1	13	-71.5		-58.5	-41.25	17.3
	CCK, 1 to 11 Mbps	2	13	-71.5	-73.4	-56.3	-41.25	15.1
	Non HT20, 6 to 54 Mbps	1	13	-71.7		-58.7	-41.25	17.5
	Non HT20, 6 to 54 Mbps	2	13	-73.3	-71.5	-56.3	-41.25	15.0
	Non HT20 Beam Forming, 6 to 54 Mbps	2	13	-73.3	-71.5	-56.3	-41.25	15.0
	HT/VHT20, M0 to M7	1	13	-73.7		-60.7	-41.25	19.5
	HT/VHT20, M0 to M7	2	13	-77.7	-73.8	-59.3	-41.25	18.1
	HT/VHT20, M8 to M15	2	13	-77.7	-73.8	-59.3	-41.25	18.1
	HT/VHT20 Beam Forming, M0 to M7	2	13	-77.7	-73.8	-59.3	-41.25	18.1
	HT/VHT20 Beam Forming, M8 to M15	2	13	-77.7	-73.8	-59.3	-41.25	18.1
HT/VHT20 STBC, M0 to M7	2	13	-77.7	-73.8	-59.3	-41.25	18.1	

Conducted Spurs Average, 2452 MHz, HT/VHT40, M0 to M7

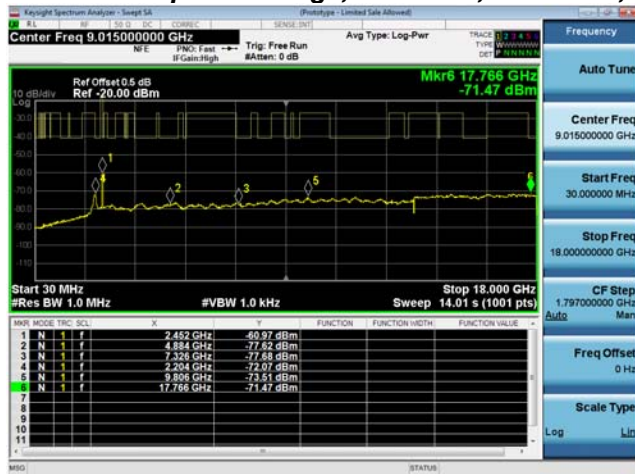

Antenna A

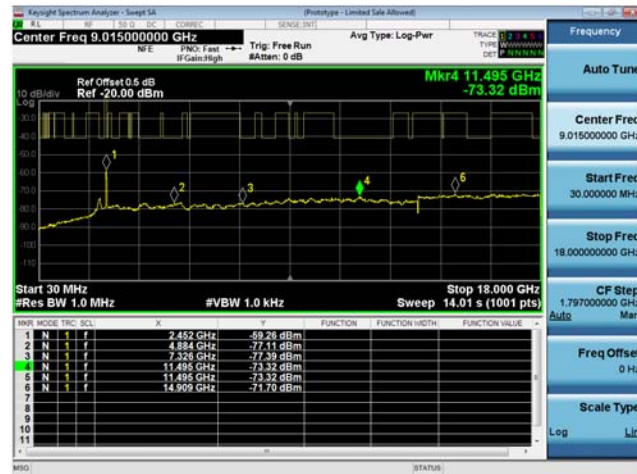

Antenna B



Antenna Gain: 13 dBi

Frequency (MHz)	Mode	Tx Paths	Correlated Antenna Gain (dBi)	Tx 1 Spur Power (dBm)	Tx 2 Spur Power (dBm)	Total Conducted Spur (dBm)	Limit (dBm)	Margin (dB)
2412	CCK, 1 to 11 Mbps	1	13	-58.8		-45.8	-21.25	24.6
	CCK, 1 to 11 Mbps	2	13	-61.8	-62.2	-46.0	-21.25	24.7
	Non HT20, 6 to 54 Mbps	1	13	-60.4		-47.4	-21.25	26.2
	Non HT20, 6 to 54 Mbps	2	13	-61.6	-61.4	-45.5	-21.25	24.2
	Non HT20 Beam Forming, 6 to 54 Mbps	2	13	-61.6	-61.4	-45.5	-21.25	24.2
	HT/VHT20, M0 to M7	1	13	-61.4		-48.4	-21.25	27.2
	HT/VHT20, M0 to M7	2	13	-61.3	-61.6	-45.4	-21.25	24.2
	HT/VHT20, M8 to M15	2	13	-61.3	-61.6	-45.4	-21.25	24.2
	HT/VHT20 Beam Forming, M0 to M7	2	13	-61.3	-61.6	-45.4	-21.25	24.2
	HT/VHT20 Beam Forming, M8 to M15	2	13	-61.3	-61.6	-45.4	-21.25	24.2
HT/VHT20 STBC, M0 to M7	2	13	-61.3	-61.6	-45.4	-21.25	24.2	
2422	Non HT40, 6 to 54 Mbps	1	13	-53.1		-40.1	-21.25	18.9
	Non HT40, 6 to 54 Mbps	2	13	-53.1	-62.3	-39.6	-21.25	18.4
	HT/VHT40, M0 to M7	1	13	-62.0		-49.0	-21.25	27.8
	HT/VHT40, M0 to M7	2	13	-62.5	-53.7	-40.2	-21.25	18.9
	HT/VHT40, M8 to M15	2	13	-62.5	-53.7	-40.2	-21.25	18.9
	HT/VHT40 Beam Forming, M0 to M7	2	13	-62.5	-53.7	-40.2	-21.25	18.9
	HT/VHT40 Beam Forming, M8 to M15	2	13	-62.5	-53.7	-40.2	-21.25	18.9
	HT/VHT40 STBC, M0 to M7	2	13	-62.5	-53.7	-40.2	-21.25	18.9
2437	Non HT40, 6 to 54 Mbps	1	13	-63.6		-50.6	-21.25	29.4
	Non HT40, 6 to 54 Mbps	2	13	-61.0	-63.1	-45.9	-21.25	24.7
	HT/VHT40, M0 to M7	1	13	-61.5		-48.5	-21.25	27.3
	HT/VHT40, M0 to M7	2	13	-62.4	-62.9	-46.6	-21.25	25.4
	HT/VHT40, M8 to M15	2	13	-62.4	-62.9	-46.6	-21.25	25.4
	HT/VHT40 Beam Forming, M0 to M7	2	13	-62.4	-62.9	-46.6	-21.25	25.4
	HT/VHT40 Beam Forming, M8 to M15	2	13	-62.4	-62.9	-46.6	-21.25	25.4
	HT/VHT40 STBC, M0 to M7	2	13	-62.4	-62.9	-46.6	-21.25	25.4
	CCK, 1 to 11 Mbps	1	13	-61.2		-48.2	-21.25	27.0
	CCK, 1 to 11 Mbps	2	13	-60.7	-62.1	-45.3	-21.25	24.1
	Non HT20, 6 to 54 Mbps	1	13	-61.5		-48.5	-21.25	27.3
	Non HT20, 6 to 54 Mbps	2	13	-61.3	-53.3	-39.7	-21.25	18.4
	Non HT20 Beam Forming, 6 to 54 Mbps	2	13	-61.3	-53.3	-39.7	-21.25	18.4
	HT/VHT20, M0 to M7	1	13	-61.3		-48.3	-21.25	27.1



	HT/VHT20, M0 to M7	2	13	-60.7	-61.2	-44.9	-21.25	23.7
	HT/VHT20, M8 to M15	2	13	-60.7	-61.2	-44.9	-21.25	23.7
	HT/VHT20 Beam Forming, M0 to M7	2	13	-60.7	-61.2	-44.9	-21.25	23.7
	HT/VHT20 Beam Forming, M8 to M15	2	13	-60.7	-61.2	-44.9	-21.25	23.7
	HT/VHT20 STBC, M0 to M7	2	13	-60.7	-61.2	-44.9	-21.25	23.7
2452	Non HT40, 6 to 54 Mbps	1	13	-60.5		-47.5	-21.25	26.3
	Non HT40, 6 to 54 Mbps	2	13	-53.5	-62.3	-40.0	-21.25	18.7
	HT/VHT40, M0 to M7	1	13	-63.9		-50.9	-21.25	29.7
	HT/VHT40, M0 to M7	2	13	-61.6	-63.5	-46.4	-21.25	25.2
	HT/VHT40, M8 to M15	2	13	-61.6	-63.5	-46.4	-21.25	25.2
	HT/VHT40 Beam Forming, M0 to M7	2	13	-61.6	-63.5	-46.4	-21.25	25.2
	HT/VHT40 Beam Forming, M8 to M15	2	13	-61.6	-63.5	-46.4	-21.25	25.2
	HT/VHT40 STBC, M0 to M7	2	13	-61.6	-63.5	-46.4	-21.25	25.2
2462	CCK, 1 to 11 Mbps	1	13	-62.6		-49.6	-21.25	28.4
	CCK, 1 to 11 Mbps	2	13	-62.0	-61.7	-45.8	-21.25	24.6
	Non HT20, 6 to 54 Mbps	1	13	-62.7		-49.7	-21.25	28.5
	Non HT20, 6 to 54 Mbps	2	13	-53.6	-61.5	-39.9	-21.25	18.7
	Non HT20 Beam Forming, 6 to 54 Mbps	2	13	-53.6	-61.5	-39.9	-21.25	18.7
	HT/VHT20, M0 to M7	1	13	-61.4		-48.4	-21.25	27.2
	HT/VHT20, M0 to M7	2	13	-61.2	-62.7	-45.9	-21.25	24.6
	HT/VHT20, M8 to M15	2	13	-61.2	-62.7	-45.9	-21.25	24.6
	HT/VHT20 Beam Forming, M0 to M7	2	13	-61.2	-62.7	-45.9	-21.25	24.6
	HT/VHT20 Beam Forming, M8 to M15	2	13	-61.2	-62.7	-45.9	-21.25	24.6
	HT/VHT20 STBC, M0 to M7	2	13	-61.2	-62.7	-45.9	-21.25	24.6

Conducted Spurs Peak, 2422 MHz, Non HT40, 6 to 54 Mbps

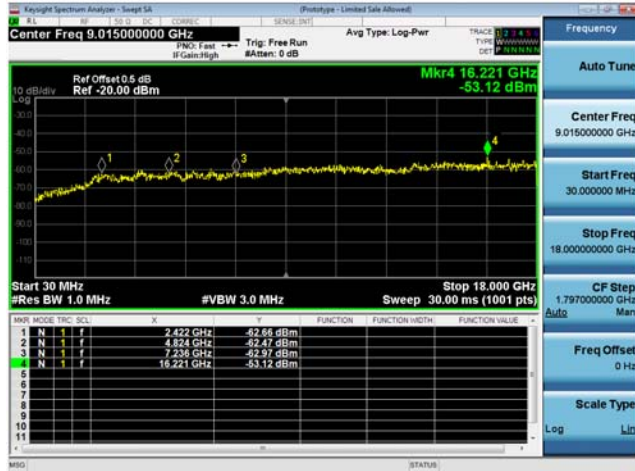

Antenna A

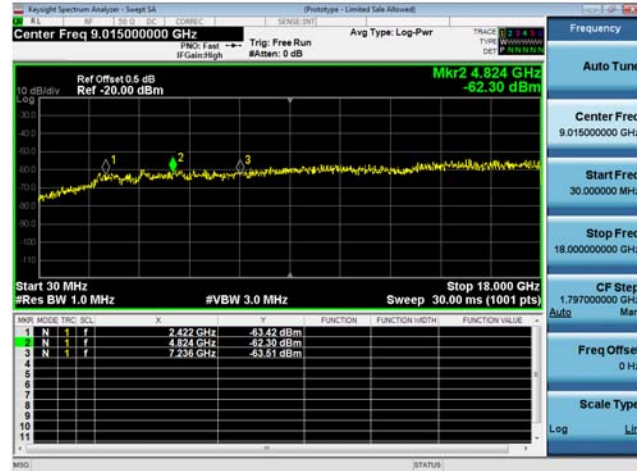

Antenna B

All transmitters at full power, all transmit paths, to demonstrate that there are no intermod products created.

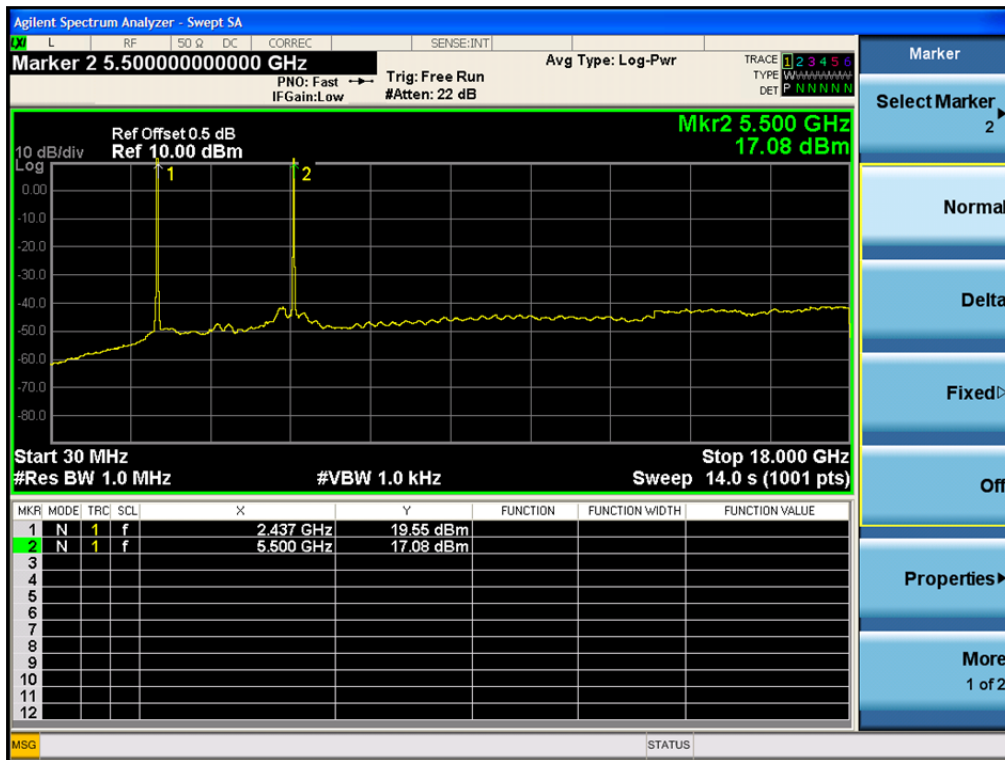



A.6 Conducted Bandedge (Restricted Band)

15.205 / 15.209 / LP0002 - Radiated emissions which fall in the restricted bands, as defined in Section 15.205(a), must also comply with the radiated emission limits specified in Section 15.209(a) (see Section 15.205(c)).

RSS-Gen 8.9: Except when the requirements applicable to a given device state otherwise, emissions from licence-exempt transmitters shall comply with the field strength limits shown in Table 4 and Table 5 below. Additionally, the level of any transmitter emission shall not exceed the level of the transmitter’s fundamental emission.

RSS-Gen 8.10 (b) Unwanted emissions that fall into restricted bands of Table 6 shall comply with the limits specified in RSS-Gen; and **(c)** Unwanted emissions that do not fall within the restricted frequency bands of Table 6 shall comply either with the limits specified in the applicable RSS or with those specified in this RSS-Gen.

Use formula below to substitute conducted measurements in place of radiated measurements

$$E[\text{dB}\mu\text{V/m}] = \text{EIRP}[\text{dBm}] - 20 \log(d[\text{meters}]) + 104.77, \text{ where } E = \text{field strength and } d = 3 \text{ meter}$$

- 1) Average Plot, Limit= -41.25 dBm eirp
- 2) Peak plot, Limit = -21.25 dBm eirp

Test Procedure

Ref. KDB 558074 D01 DTS Meas Guidance v03r05
ANSI C63.10: 2013

<p>Conducted Band edge Test Procedure</p> <ol style="list-style-type: none"> 1. Connect the antenna port(s) to the spectrum analyzer input. 2. Place the radio in continuous transmit mode. Use the procedures in KDB 558074 D01 DTS Meas Guidance v03r05 to substitute conducted measurements in place of radiated measurements. 3. Configure Spectrum analyzer as per test parameters below below (be sure to enter all losses between the transmitter output and the spectrum analyzer). 4. Place a marker at the end of the restricted band closest to the transmit frequency to show compliance. Also measure any emissions in the restricted bands.. 5. The “measure-and-sum technique” is used for measuring in-band transmit power of a device. In the measure-and-sum approach, the conducted emission level is measured at each antenna port. The measured results at the various antenna ports are then summed mathematically to determine the total emission level from the device. Summing is performed in linear power units. The worst case output is recorded. 6. Place a marker at the end of the restricted band closest to the transmit frequency to show compliance. Also measure any emissions in the restricted bands 7. Capture graphs and record pertinent measurement data.
--

<p>Conducted Bandedge Test parameters non-restricted Band KDB 558074 D01 v03r05 section 11.1b, 11.2-3, also see ANSI C63.10: 2013 section 11.10.3</p> <p>RBW = 100 kHz VBW ≥ 3 x RBW Sweep = Auto couple Detector = Peak Trace = Max Hold.</p>	<p>Conducted Bandedge Test parameters restricted Band KDB 558074 D01 v03r05 section 12.2.4 & 12.2.5.3 also see ANSI C63.10: 2013 section 11.12.4 & 11.12.5.3</p> <p>RBW = 1 MHz VBW ≥ 3 x RBW for Peak, 100Hz for Average Sweep = Auto couple Detector = Peak Trace = Max Hold.</p>
---	--



System Number	Description	Samples	System under test	Support equipment
1	EUT	S01	<input checked="" type="checkbox"/>	<input type="checkbox"/>
	Support	S02	<input type="checkbox"/>	<input checked="" type="checkbox"/>

Tested By : Jose Aguirre	Date of testing: 20-April-16 - 08-Aug-16
Test Result : PASS	

See Appendix C for list of test equipment

Note: Radiated measurements have demonstrated that spurious emissions at the band edges are not correlated and therefore no array gain factor is used.



Antenna Gain: 4 dBi

Frequency (MHz)	Mode	Tx Paths	Correlated Antenna Gain (dBi)	Tx 1 Bandedge Level (dBm)	Tx 2 Bandedge Level (dBm)	Total Tx Bandedge Level (dBm)	Limit (dBm)	Margin (dB)
2412	CCK, 1 to 11 Mbps	1	4	-55.2		-51.2	-41.25	10.0
	CCK, 1 to 11 Mbps	2	4	-55.2	-55.1	-48.1	-41.25	6.9
	Non HT20, 6 to 54 Mbps	1	4	-49.2		-45.2	-41.25	4.0
	Non HT20, 6 to 54 Mbps	2	4	-49.8	-50.7	-43.2	-41.25	2.0
	Non HT20 Beam Forming, 6 to 54 Mbps	2	7	-51.7	-53.8	-42.6	-41.25	1.4
	HT/VHT20, M0 to M7	1	4	-48.2		-44.2	-41.25	3.0
	HT/VHT20, M0 to M7	2	4	-50.7	-49.9	-43.3	-41.25	2.0
	HT/VHT20, M8 to M15	2	4	-50.7	-49.9	-43.3	-41.25	2.0
	HT/VHT20 Beam Forming, M0 to M7	2	7	-51.8	-51.4	-41.6	-41.25	0.3
	HT/VHT20 Beam Forming, M8 to M15	2	4	-50.7	-49.9	-43.3	-41.25	2.0
	HT/VHT20 STBC, M0 to M7	2	4	-50.7	-49.9	-43.3	-41.25	2.0
2422	Non HT40, 6 to 54 Mbps	1	4	-46.0		-42.0	-41.25	0.8
	Non HT40, 6 to 54 Mbps	2	4	-53.8	-49.6	-44.2	-41.25	3.0
	HT/VHT40, M0 to M7	1	4	-46.9		-42.9	-41.25	1.6
	HT/VHT40, M0 to M7	2	4	-49.6	-53.8	-44.2	-41.25	3.0
	HT/VHT40, M8 to M15	2	4	-49.6	-53.8	-44.2	-41.25	3.0
	HT/VHT40 Beam Forming, M0 to M7	2	7	-55.0	-55.8	-45.4	-41.25	4.1
	HT/VHT40 Beam Forming, M8 to M15	2	4	-49.6	-53.8	-44.2	-41.25	3.0
	HT/VHT40 STBC, M0 to M7	2	4	-49.6	-53.8	-44.2	-41.25	3.0
2462	CCK, 1 to 11 Mbps	1	4	-53.4		-49.4	-41.25	8.2
	CCK, 1 to 11 Mbps	2	4	-53.4	-50.3	-44.6	-41.25	3.3
	Non HT20, 6 to 54 Mbps	1	4	-49.2		-45.2	-41.25	4.0
	Non HT20, 6 to 54 Mbps	2	4	-50.9	-46.9	-41.4	-41.25	0.2
	Non HT20 Beam Forming, 6 to 54 Mbps	2	7	-57.6	-57.5	-47.5	-41.25	6.3
	HT/VHT20, M0 to M7	1	4	-46.0		-42.0	-41.25	0.8
	HT/VHT20, M0 to M7	2	4	-51.5	-51.6	-44.5	-41.25	3.3
	HT/VHT20, M8 to M15	2	4	-51.5	-51.6	-44.5	-41.25	3.3
	HT/VHT20 Beam Forming, M0 to M7	2	7	-55.9	-51.6	-43.2	-41.25	2.0
	HT/VHT20 Beam Forming, M8 to M15	2	4	-51.5	-51.6	-44.5	-41.25	3.3
	HT/VHT20 STBC, M0 to M7	2	4	-51.5	-51.6	-44.5	-41.25	3.3

Conducted Bandedge Average, 2412 MHz, HT/VHT20 Beam Forming, M0 to M7

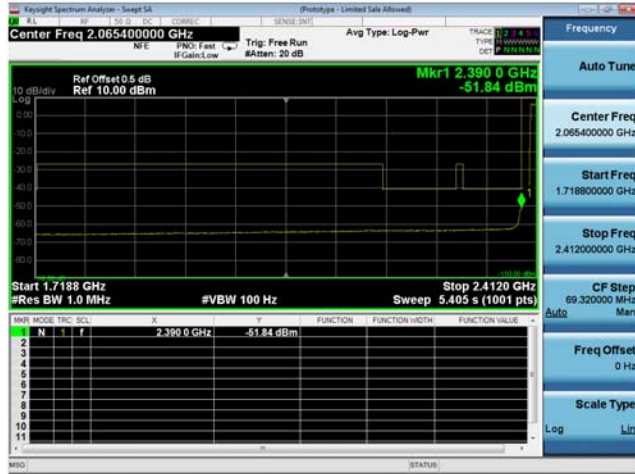

Antenna A

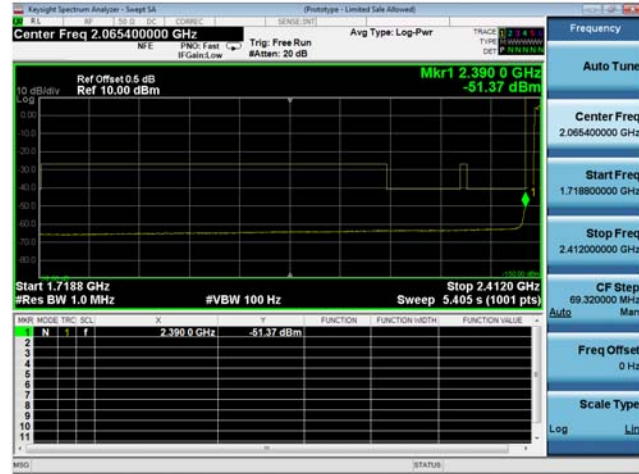

Antenna B

Conducted Bandedge Average, 2462 MHz, Non HT20, 6 to 54 Mbps

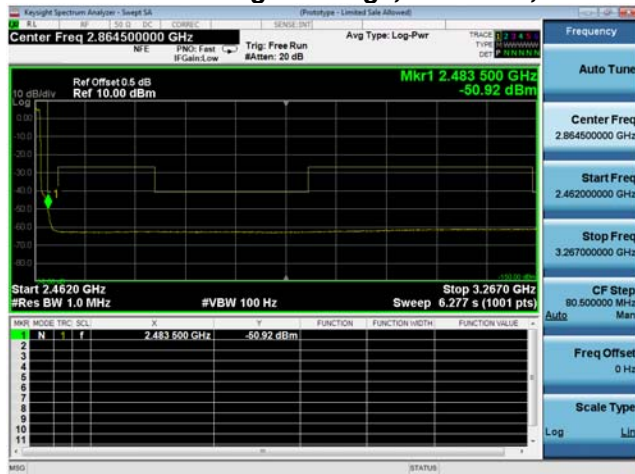

Antenna A

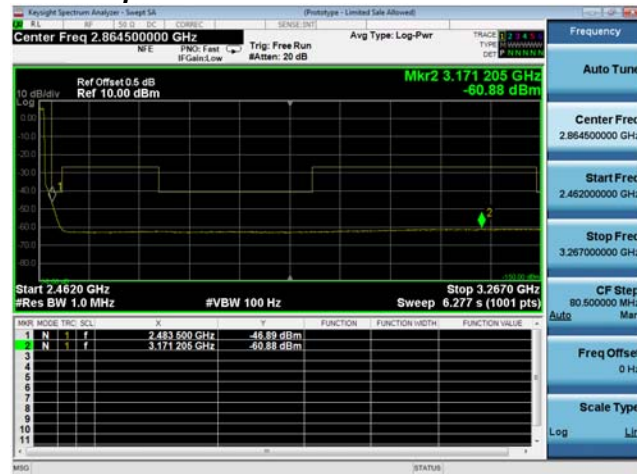

Antenna B



Antenna Gain: 5 dBi

Frequency (MHz)	Mode	Tx Paths	Correlated Antenna Gain (dBi)	Tx 1 Bandedge Level (dBm)	Tx 2 Bandedge Level (dBm)	Total Tx Bandedge Level (dBm)	Limit (dBm)	Margin (dB)
2412	CCK, 1 to 11 Mbps	1	5	-55.2		-50.2	-41.25	9.0
	CCK, 1 to 11 Mbps	2	5	-55.2	-55.1	-47.1	-41.25	5.9
	Non HT20, 6 to 54 Mbps	1	5	-49.2		-44.2	-41.25	3.0
	Non HT20, 6 to 54 Mbps	2	5	-49.8	-50.7	-42.2	-41.25	1.0
	Non HT20 Beam Forming, 6 to 54 Mbps	2	8	-51.7	-53.8	-41.6	-41.25	0.4
	HT/VHT20, M0 to M7	1	5	-48.2		-43.2	-41.25	2.0
	HT/VHT20, M0 to M7	2	5	-50.7	-49.9	-42.3	-41.25	1.0
	HT/VHT20, M8 to M15	2	5	-50.7	-49.9	-42.3	-41.25	1.0
	HT/VHT20 Beam Forming, M0 to M7	2	8	-54.9	-54.3	-43.6	-41.25	2.3
	HT/VHT20 Beam Forming, M8 to M15	2	5	-50.7	-49.9	-42.3	-41.25	1.0
	HT/VHT20 STBC, M0 to M7	2	5	-50.7	-49.9	-42.3	-41.25	1.0
2422	Non HT40, 6 to 54 Mbps	1	5	-47.1		-42.1	-41.25	0.9
	Non HT40, 6 to 54 Mbps	2	5	-59.5	-54.6	-48.4	-41.25	7.1
	HT/VHT40, M0 to M7	1	5	-46.9		-41.9	-41.25	0.6
	HT/VHT40, M0 to M7	2	5	-53.2	-59.7	-47.3	-41.25	6.1
	HT/VHT40, M8 to M15	2	5	-53.2	-59.7	-47.3	-41.25	6.1
	HT/VHT40 Beam Forming, M0 to M7	2	8	-55.0	-55.8	-44.4	-41.25	3.1
	HT/VHT40 Beam Forming, M8 to M15	2	5	-53.2	-59.7	-47.3	-41.25	6.1
	HT/VHT40 STBC, M0 to M7	2	5	-53.2	-59.7	-47.3	-41.25	6.1
2462	CCK, 1 to 11 Mbps	1	5	-53.4		-48.4	-41.25	7.2
	CCK, 1 to 11 Mbps	2	5	-53.4	-50.3	-43.6	-41.25	2.3
	Non HT20, 6 to 54 Mbps	1	5	-49.2		-44.2	-41.25	3.0
	Non HT20, 6 to 54 Mbps	2	5	-54.8	-50.3	-44.0	-41.25	2.7
	Non HT20 Beam Forming, 6 to 54 Mbps	2	8	-54.7	-61.3	-45.8	-41.25	4.6
	HT/VHT20, M0 to M7	1	5	-49.4		-44.4	-41.25	3.2
	HT/VHT20, M0 to M7	2	5	-51.5	-51.6	-43.5	-41.25	2.3
	HT/VHT20, M8 to M15	2	5	-51.5	-51.6	-43.5	-41.25	2.3
	HT/VHT20 Beam Forming, M0 to M7	2	8	-55.9	-51.6	-42.2	-41.25	1.0
	HT/VHT20 Beam Forming, M8 to M15	2	5	-51.5	-51.6	-43.5	-41.25	2.3
	HT/VHT20 STBC, M0 to M7	2	5	-51.5	-51.6	-43.5	-41.25	2.3



Conducted Bandedge Average, 2412 MHz, Non HT20 Beam Forming, 6 to 54 Mbps

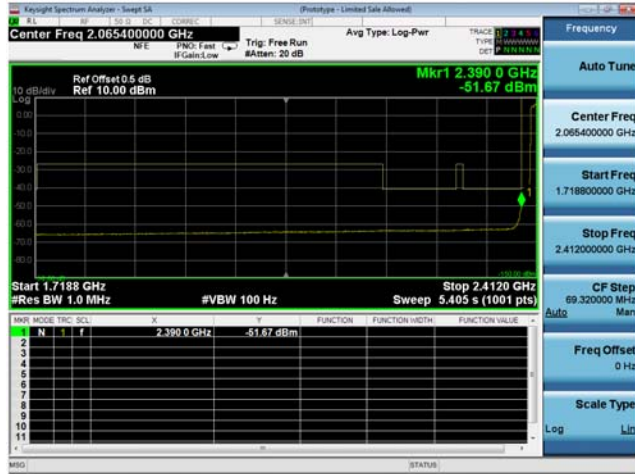

Antenna A

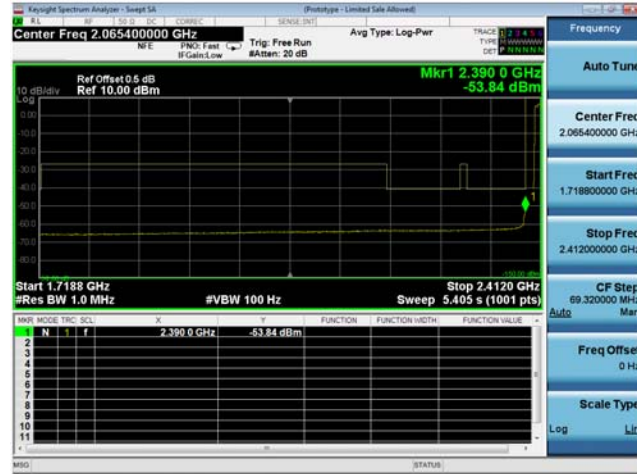

Antenna B

Conducted Bandedge Average, 2462 MHz, HT/VHT20 Beam Forming, M0 to M7

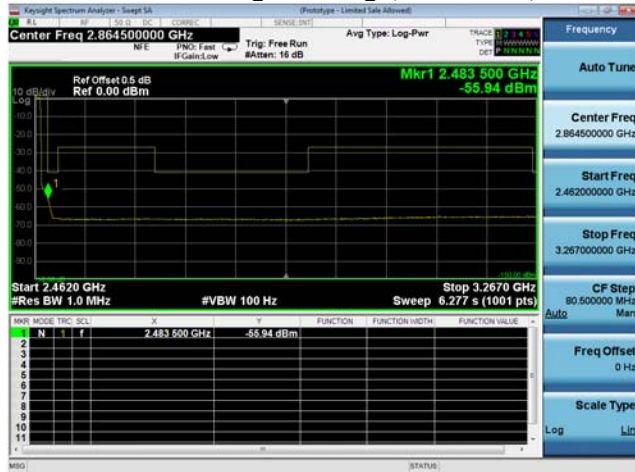

Antenna A

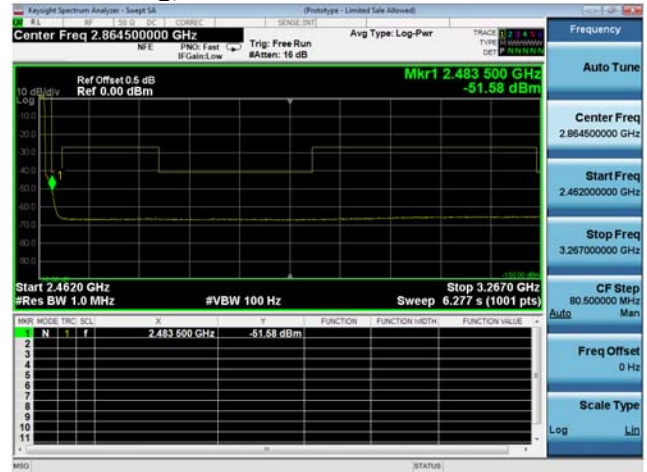

Antenna B



Antenna Gain: 6 dBi

Frequency (MHz)	Mode	Tx Paths	Correlated Antenna Gain (dBi)	Tx 1 Bandedge Level (dBm)	Tx 2 Bandedge Level (dBm)	Total Tx Bandedge Level (dBm)	Limit (dBm)	Margin (dB)
2412	CCK, 1 to 11 Mbps	1	6	-55.2		-49.2	-41.25	8.0
	CCK, 1 to 11 Mbps	2	6	-55.2	-55.1	-46.1	-41.25	4.9
	Non HT20, 6 to 54 Mbps	1	6	-49.2		-43.2	-41.25	2.0
	Non HT20, 6 to 54 Mbps	2	6	-51.7	-53.8	-43.6	-41.25	2.4
	Non HT20 Beam Forming, 6 to 54 Mbps	2	9	-55.1	-56.0	-43.5	-41.25	2.3
	HT/VHT20, M0 to M7	1	6	-48.2		-42.2	-41.25	1.0
	HT/VHT20, M0 to M7	2	6	-50.7	-49.9	-41.3	-41.25	0.0
	HT/VHT20, M8 to M15	2	6	-50.7	-49.9	-41.3	-41.25	0.0
	HT/VHT20 Beam Forming, M0 to M7	2	9	-54.9	-54.3	-42.6	-41.25	1.3
	HT/VHT20 Beam Forming, M8 to M15	2	6	-50.7	-49.9	-41.3	-41.25	0.0
	HT/VHT20 STBC, M0 to M7	2	6	-50.7	-49.9	-41.3	-41.25	0.0
2422	Non HT40, 6 to 54 Mbps	1	6	-53.8		-47.8	-41.25	6.6
	Non HT40, 6 to 54 Mbps	2	6	-56.5	-57.4	-47.9	-41.25	6.7
	HT/VHT40, M0 to M7	1	6	-49.6		-43.6	-41.25	2.4
	HT/VHT40, M0 to M7	2	6	-55.0	-55.8	-46.4	-41.25	5.1
	HT/VHT40, M8 to M15	2	6	-55.0	-55.8	-46.4	-41.25	5.1
	HT/VHT40 Beam Forming, M0 to M7	2	9	-55.0	-55.8	-43.4	-41.25	2.1
	HT/VHT40 Beam Forming, M8 to M15	2	6	-55.0	-55.8	-46.4	-41.25	5.1
	HT/VHT40 STBC, M0 to M7	2	6	-55.0	-55.8	-46.4	-41.25	5.1
2462	CCK, 1 to 11 Mbps	1	6	-53.4		-47.4	-41.25	6.2
	CCK, 1 to 11 Mbps	2	6	-53.4	-50.3	-42.6	-41.25	1.3
	Non HT20, 6 to 54 Mbps	1	6	-50.9		-44.9	-41.25	3.7
	Non HT20, 6 to 54 Mbps	2	6	-56.0	-56.3	-47.1	-41.25	5.9
	Non HT20 Beam Forming, 6 to 54 Mbps	2	9	-60.9	-58.2	-47.3	-41.25	6.1
	HT/VHT20, M0 to M7	1	6	-49.4		-43.4	-41.25	2.2
	HT/VHT20, M0 to M7	2	6	-55.9	-51.6	-44.2	-41.25	3.0
	HT/VHT20, M8 to M15	2	6	-55.9	-51.6	-44.2	-41.25	3.0
	HT/VHT20 Beam Forming, M0 to M7	2	9	-53.1	-60.0	-43.3	-41.25	2.0
	HT/VHT20 Beam Forming, M8 to M15	2	6	-55.9	-51.6	-44.2	-41.25	3.0
	HT/VHT20 STBC, M0 to M7	2	6	-55.9	-51.6	-44.2	-41.25	3.0

Conducted Bandedge Average, 2412 MHz, HT/VHT20, M0 to M7

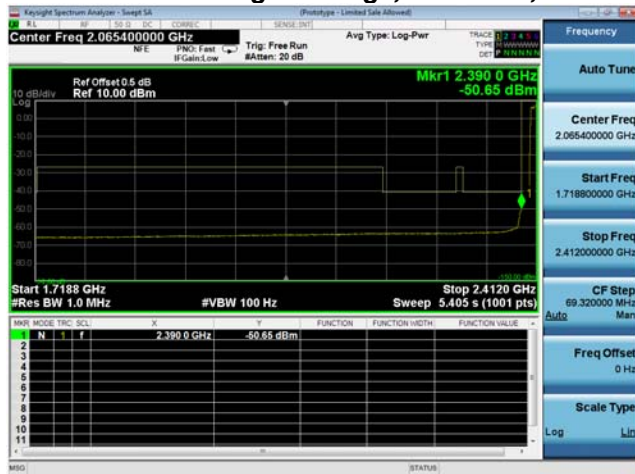

Antenna A

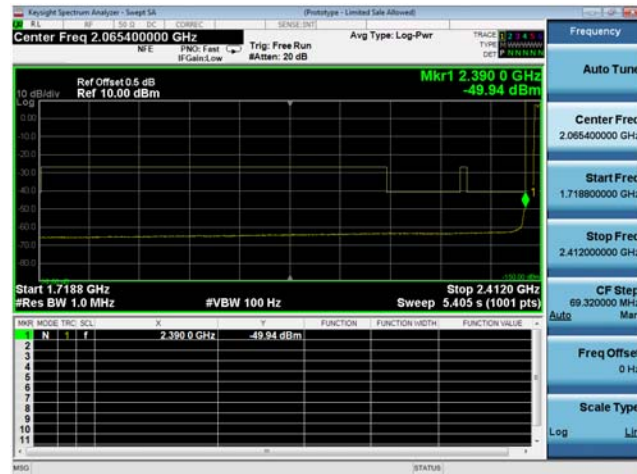

Antenna B

Conducted Bandedge Average, 2462 MHz, CCK, 1 to 11 Mbps

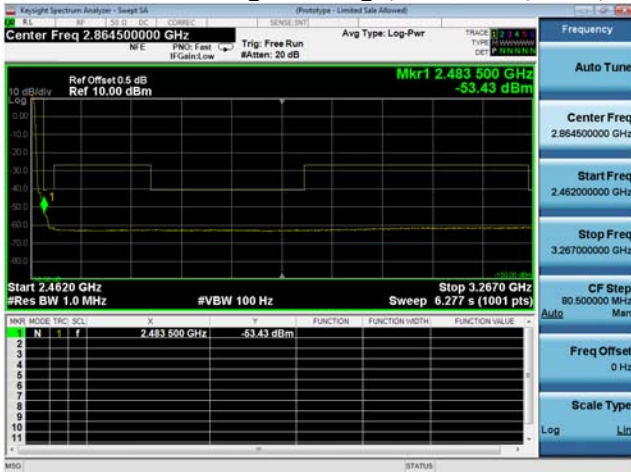

Antenna A

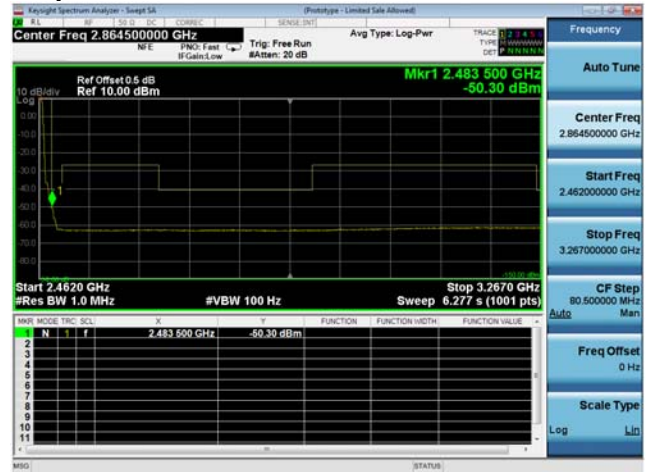

Antenna B



Antenna Gain: 8 dBi

Frequency (MHz)	Mode	Tx Paths	Correlated Antenna Gain (dBi)	Tx 1 Bandedge Level (dBm)	Tx 2 Bandedge Level (dBm)	Total Tx Bandedge Level (dBm)	Limit (dBm)	Margin (dB)
2412	CCK, 1 to 11 Mbps	1	8	-55.2		-47.2	-41.25	6.0
	CCK, 1 to 11 Mbps	2	8	-55.2	-55.1	-44.1	-41.25	2.9
	Non HT20, 6 to 54 Mbps	1	8	-49.8		-41.8	-41.25	0.6
	Non HT20, 6 to 54 Mbps	2	8	-51.7	-53.8	-41.6	-41.25	0.4
	Non HT20 Beam Forming, 6 to 54 Mbps	2	11	-61.5	-60.8	-47.1	-41.25	5.9
	HT/VHT20, M0 to M7	1	8	-50.7		-42.7	-41.25	1.5
	HT/VHT20, M0 to M7	2	8	-54.9	-54.3	-43.6	-41.25	2.3
	HT/VHT20, M8 to M15	2	8	-54.9	-54.3	-43.6	-41.25	2.3
	HT/VHT20 Beam Forming, M0 to M7	2	11	-60.8	-60.5	-46.6	-41.25	5.4
	HT/VHT20 Beam Forming, M8 to M15	2	8	-54.9	-54.3	-43.6	-41.25	2.3
	HT/VHT20 STBC, M0 to M7	2	8	-54.9	-54.3	-43.6	-41.25	2.3
2422	Non HT40, 6 to 54 Mbps	1	8	-53.8		-45.8	-41.25	4.6
	Non HT40, 6 to 54 Mbps	2	8	-61.6	-57.7	-48.2	-41.25	7.0
	HT/VHT40, M0 to M7	1	8	-50.6		-42.6	-41.25	1.4
	HT/VHT40, M0 to M7	2	8	-55.0	-55.8	-44.4	-41.25	3.1
	HT/VHT40, M8 to M15	2	8	-55.0	-55.8	-44.4	-41.25	3.1
	HT/VHT40 Beam Forming, M0 to M7	2	11	-64.5	-65.9	-51.1	-41.25	9.9
	HT/VHT40 Beam Forming, M8 to M15	2	8	-55.0	-55.8	-44.4	-41.25	3.1
	HT/VHT40 STBC, M0 to M7	2	8	-55.0	-55.8	-44.4	-41.25	3.1
2462	CCK, 1 to 11 Mbps	1	8	-53.4		-45.4	-41.25	4.2
	CCK, 1 to 11 Mbps	2	8	-53.5	-51.6	-41.4	-41.25	0.2
	Non HT20, 6 to 54 Mbps	1	8	-53.1		-45.1	-41.25	3.9
	Non HT20, 6 to 54 Mbps	2	8	-54.7	-61.3	-45.8	-41.25	4.6
	Non HT20 Beam Forming, 6 to 54 Mbps	2	11	-63.4	-63.3	-49.3	-41.25	8.1
	HT/VHT20, M0 to M7	1	8	-51.5		-43.5	-41.25	2.3
	HT/VHT20, M0 to M7	2	8	-55.9	-51.6	-42.2	-41.25	1.0
	HT/VHT20, M8 to M15	2	8	-55.9	-51.6	-42.2	-41.25	1.0
	HT/VHT20 Beam Forming, M0 to M7	2	11	-61.2	-61.1	-47.1	-41.25	5.9
	HT/VHT20 Beam Forming, M8 to M15	2	8	-55.9	-51.6	-42.2	-41.25	1.0
	HT/VHT20 STBC, M0 to M7	2	8	-55.9	-51.6	-42.2	-41.25	1.0



Conducted Bandedge Average, 2412 MHz, Non HT20, 6 to 54 Mbps

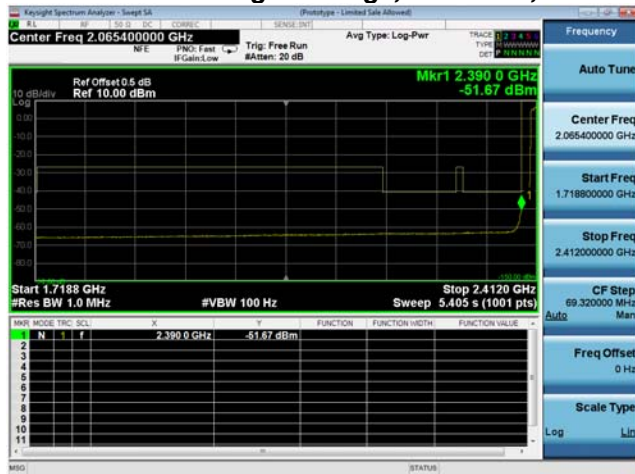

Antenna A

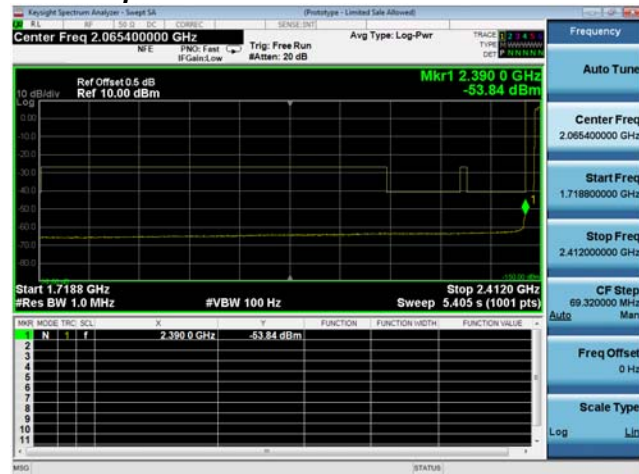

Antenna B

Conducted Bandedge Average, 2462 MHz, CCK, 1 to 11 Mbps

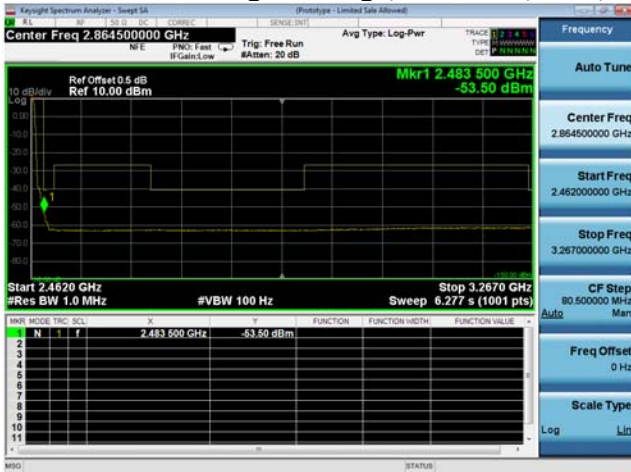

Antenna A

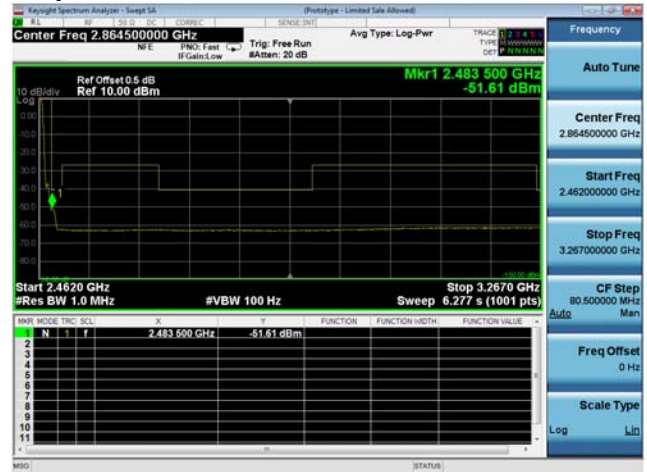

Antenna B



Antenna Gain: 13 dBi

Frequency (MHz)	Mode	Tx Paths	Correlated Antenna Gain (dBi)	Tx 1 Bandedge Level (dBm)	Tx 2 Bandedge Level (dBm)	Total Tx Bandedge Level (dBm)	Limit (dBm)	Margin (dB)
2412	CCK, 1 to 11 Mbps	1	13	-57.1		-44.1	-41.25	2.9
	CCK, 1 to 11 Mbps	2	13	-58.4	-59.6	-42.9	-41.25	1.7
	Non HT20, 6 to 54 Mbps	1	13	-55.1		-42.1	-41.25	0.9
	Non HT20, 6 to 54 Mbps	2	13	-61.5	-60.8	-45.1	-41.25	3.9
	Non HT20 Beam Forming, 6 to 54 Mbps	2	13	-61.5	-60.8	-45.1	-41.25	3.9
	HT/VHT20, M0 to M7	1	13	-57.1		-44.1	-41.25	2.9
	HT/VHT20, M0 to M7	2	13	-60.8	-60.5	-44.6	-41.25	3.4
	HT/VHT20, M8 to M15	2	13	-60.8	-60.5	-44.6	-41.25	3.4
	HT/VHT20 Beam Forming, M0 to M7	2	13	-60.8	-60.5	-44.6	-41.25	3.4
	HT/VHT20 Beam Forming, M8 to M15	2	13	-60.8	-60.5	-44.6	-41.25	3.4
	HT/VHT20 STBC, M0 to M7	2	13	-60.8	-60.5	-44.6	-41.25	3.4
2422	Non HT40, 6 to 54 Mbps	1	13	-63.9		-50.9	-41.25	9.7
	Non HT40, 6 to 54 Mbps	2	13	-63.9	-65.7	-48.7	-41.25	7.4
	HT/VHT40, M0 to M7	1	13	-61.8		-48.8	-41.25	7.6
	HT/VHT40, M0 to M7	2	13	-66.5	-66.8	-50.6	-41.25	9.4
	HT/VHT40, M8 to M15	2	13	-66.5	-66.8	-50.6	-41.25	9.4
	HT/VHT40 Beam Forming, M0 to M7	2	13	-66.5	-66.8	-50.6	-41.25	9.4
	HT/VHT40 Beam Forming, M8 to M15	2	13	-66.5	-66.8	-50.6	-41.25	9.4
	HT/VHT40 STBC, M0 to M7	2	13	-66.5	-66.8	-50.6	-41.25	9.4
2462	CCK, 1 to 11 Mbps	1	13	-54.9		-41.9	-41.25	0.7
	CCK, 1 to 11 Mbps	2	13	-58.3	-57.4	-41.8	-41.25	0.6
	Non HT20, 6 to 54 Mbps	1	13	-60.9		-47.9	-41.25	6.7
	Non HT20, 6 to 54 Mbps	2	13	-62.4	-63.7	-47.0	-41.25	5.7
	Non HT20 Beam Forming, 6 to 54 Mbps	2	13	-62.4	-63.7	-47.0	-41.25	5.7
	HT/VHT20, M0 to M7	1	13	-61.2		-48.2	-41.25	7.0
	HT/VHT20, M0 to M7	2	13	-62.0	-59.9	-44.8	-41.25	3.6
	HT/VHT20, M8 to M15	2	13	-62.0	-59.9	-44.8	-41.25	3.6
	HT/VHT20 Beam Forming, M0 to M7	2	13	-62.0	-59.9	-44.8	-41.25	3.6
	HT/VHT20 Beam Forming, M8 to M15	2	13	-62.0	-59.9	-44.8	-41.25	3.6
	HT/VHT20 STBC, M0 to M7	2	13	-62.0	-59.9	-44.8	-41.25	3.6

Conducted Bandedge Average, 2412 MHz, Non HT20, 6 to 54 Mbps

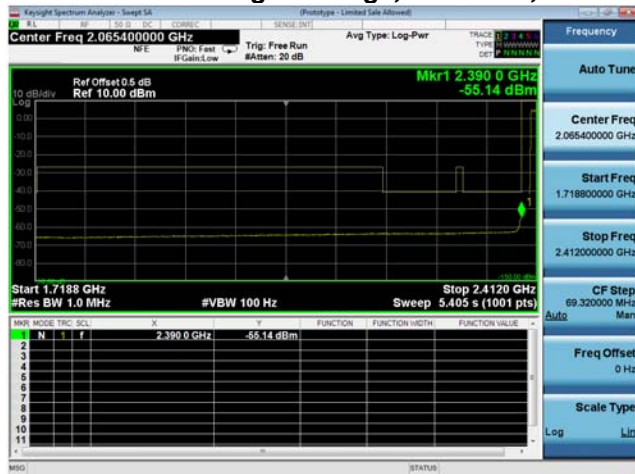

Antenna A

Conducted Bandedge Average, 2462 MHz, CCK, 1 to 11 Mbps

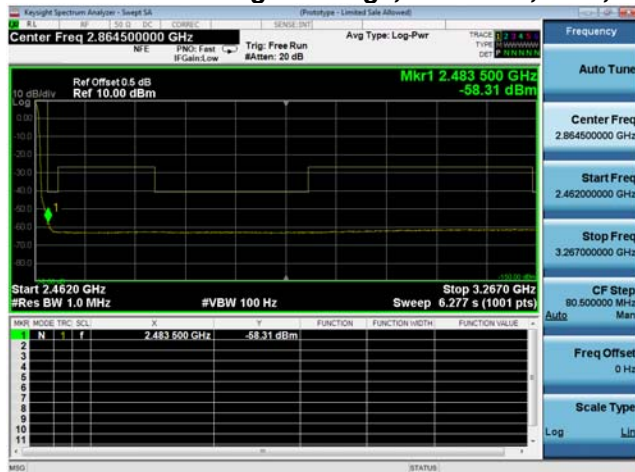

Antenna A

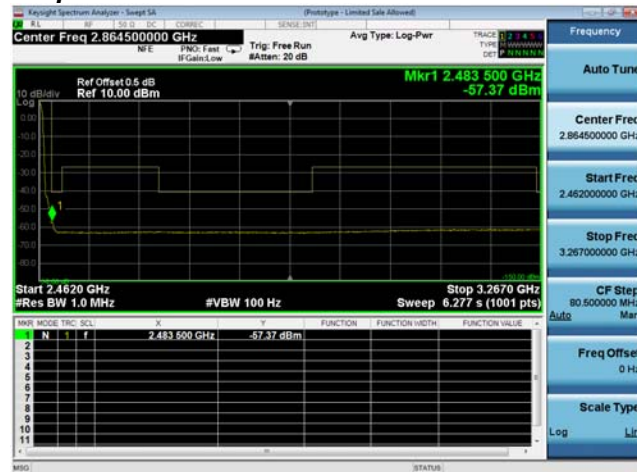

Antenna B



Antenna Gain: 4 dBi

Frequency (MHz)	Mode	Tx Paths	Correlated Antenna Gain (dBi)	Tx 1 Bandedge Level (dBm)	Tx 2 Bandedge Level (dBm)	Total Tx Bandedge Level (dBm)	Limit (dBm)	Margin (dB)
2412	CCK, 1 to 11 Mbps	1	4	-37.0		-33.0	-21.25	11.8
	CCK, 1 to 11 Mbps	2	4	-37.0	-39.6	-31.1	-21.25	9.8
	Non HT20, 6 to 54 Mbps	1	4	-28.2		-24.2	-21.25	3.0
	Non HT20, 6 to 54 Mbps	2	4	-32.1	-33.2	-25.6	-21.25	4.4
	Non HT20 Beam Forming, 6 to 54 Mbps	2	7	-31.0	-36.1	-22.8	-21.25	1.6
	HT/VHT20, M0 to M7	1	4	-29.5		-25.5	-21.25	4.3
	HT/VHT20, M0 to M7	2	4	-32.6	-29.7	-23.9	-21.25	2.7
	HT/VHT20, M8 to M15	2	4	-32.6	-29.7	-23.9	-21.25	2.7
	HT/VHT20 Beam Forming, M0 to M7	2	7	-34.4	-36.5	-25.3	-21.25	4.1
	HT/VHT20 Beam Forming, M8 to M15	2	4	-32.6	-29.7	-23.9	-21.25	2.7
	HT/VHT20 STBC, M0 to M7	2	4	-32.6	-29.7	-23.9	-21.25	2.7
2422	Non HT40, 6 to 54 Mbps	1	4	-27.8		-23.8	-21.25	2.6
	Non HT40, 6 to 54 Mbps	2	4	-29.4	-27.4	-21.3	-21.25	0.0
	HT/VHT40, M0 to M7	1	4	-33.6		-29.6	-21.25	8.4
	HT/VHT40, M0 to M7	2	4	-28.9	-27.9	-21.4	-21.25	0.1
	HT/VHT40, M8 to M15	2	4	-28.9	-27.9	-21.4	-21.25	0.1
	HT/VHT40 Beam Forming, M0 to M7	2	7	-34.2	-36.1	-25.0	-21.25	3.8
	HT/VHT40 Beam Forming, M8 to M15	2	4	-28.9	-27.9	-21.4	-21.25	0.1
	HT/VHT40 STBC, M0 to M7	2	4	-28.9	-27.9	-21.4	-21.25	0.1
2462	CCK, 1 to 11 Mbps	1	4	-37.7		-33.7	-21.25	12.5
	CCK, 1 to 11 Mbps	2	4	-37.7	-39.6	-31.5	-21.25	10.3
	Non HT20, 6 to 54 Mbps	1	4	-26.8		-22.8	-21.25	1.6
	Non HT20, 6 to 54 Mbps	2	4	-28.9	-31.1	-22.9	-21.25	1.6
	Non HT20 Beam Forming, 6 to 54 Mbps	2	7	-33.6	-30.6	-21.8	-21.25	0.6
	HT/VHT20, M0 to M7	1	4	-25.8		-21.8	-21.25	0.6
	HT/VHT20, M0 to M7	2	4	-30.6	-28.7	-22.5	-21.25	1.3
	HT/VHT20, M8 to M15	2	4	-30.6	-28.7	-22.5	-21.25	1.3
	HT/VHT20 Beam Forming, M0 to M7	2	7	-30.8	-34.6	-22.3	-21.25	1.0
	HT/VHT20 Beam Forming, M8 to M15	2	4	-30.6	-28.7	-22.5	-21.25	1.3
	HT/VHT20 STBC, M0 to M7	2	4	-30.6	-28.7	-22.5	-21.25	1.3

Conducted Bandedge Peak, 2422 MHz, Non HT40, 6 to 54 Mbps



Antenna A



Antenna B

Conducted Bandedge Peak, 2462 MHz, HT/VHT20, M0 to M7



Antenna A



Antenna Gain: 5 dBi

Frequency (MHz)	Mode	Tx Paths	Correlated Antenna Gain (dBi)	Tx 1 Bandedge Level (dBm)	Tx 2 Bandedge Level (dBm)	Total Tx Bandedge Level (dBm)	Limit (dBm)	Margin (dB)
2412	CCK, 1 to 11 Mbps	1	5	-37.0		-32.0	-21.25	10.8
	CCK, 1 to 11 Mbps	2	5	-37.0	-39.6	-30.1	-21.25	8.8
	Non HT20, 6 to 54 Mbps	1	5	-28.2		-23.2	-21.25	2.0
	Non HT20, 6 to 54 Mbps	2	5	-32.1	-33.2	-24.6	-21.25	3.4
	Non HT20 Beam Forming, 6 to 54 Mbps	2	8	-31.0	-36.1	-21.8	-21.25	0.6
	HT/VHT20, M0 to M7	1	5	-29.5		-24.5	-21.25	3.3
	HT/VHT20, M0 to M7	2	5	-32.6	-29.7	-22.9	-21.25	1.7
	HT/VHT20, M8 to M15	2	5	-32.6	-29.7	-22.9	-21.25	1.7
	HT/VHT20 Beam Forming, M0 to M7	2	8	-32.5	-35.3	-22.7	-21.25	1.4
	HT/VHT20 Beam Forming, M8 to M15	2	5	-32.6	-29.7	-22.9	-21.25	1.7
	HT/VHT20 STBC, M0 to M7	2	5	-32.6	-29.7	-22.9	-21.25	1.7
2422	Non HT40, 6 to 54 Mbps	1	5	-33.1		-28.1	-21.25	6.9
	Non HT40, 6 to 54 Mbps	2	5	-33.8	-27.4	-21.5	-21.25	0.3
	HT/VHT40, M0 to M7	1	5	-33.6		-28.6	-21.25	7.4
	HT/VHT40, M0 to M7	2	5	-30.1	-28.7	-21.3	-21.25	0.1
	HT/VHT40, M8 to M15	2	5	-30.1	-28.7	-21.3	-21.25	0.1
	HT/VHT40 Beam Forming, M0 to M7	2	8	-34.2	-36.1	-24.0	-21.25	2.8
	HT/VHT40 Beam Forming, M8 to M15	2	5	-30.1	-28.7	-21.3	-21.25	0.1
	HT/VHT40 STBC, M0 to M7	2	5	-30.1	-28.7	-21.3	-21.25	0.1
2462	CCK, 1 to 11 Mbps	1	5	-37.7		-32.7	-21.25	11.5
	CCK, 1 to 11 Mbps	2	5	-37.7	-39.6	-30.5	-21.25	9.3
	Non HT20, 6 to 54 Mbps	1	5	-26.8		-21.8	-21.25	0.6
	Non HT20, 6 to 54 Mbps	2	5	-29.5	-29.5	-21.5	-21.25	0.2
	Non HT20 Beam Forming, 6 to 54 Mbps	2	8	-33.2	-31.8	-21.4	-21.25	0.2
	HT/VHT20, M0 to M7	1	5	-28.9		-23.9	-21.25	2.7
	HT/VHT20, M0 to M7	2	5	-30.6	-28.7	-21.5	-21.25	0.3
	HT/VHT20, M8 to M15	2	5	-30.6	-28.7	-21.5	-21.25	0.3
	HT/VHT20 Beam Forming, M0 to M7	2	8	-30.8	-34.6	-21.3	-21.25	0.0
	HT/VHT20 Beam Forming, M8 to M15	2	5	-30.6	-28.7	-21.5	-21.25	0.3
	HT/VHT20 STBC, M0 to M7	2	5	-30.6	-28.7	-21.5	-21.25	0.3

Conducted Bandedge Peak, 2422 MHz, HT/VHT40, M0 to M7



Antenna A



Antenna B

Conducted Bandedge Peak, 2462 MHz, HT/VHT20 Beam Forming, M0 to M7



Antenna A



Antenna B



Antenna Gain: 6 dBi

Frequency (MHz)	Mode	Tx Paths	Correlated Antenna Gain (dBi)	Tx 1 Bandedge Level (dBm)	Tx 2 Bandedge Level (dBm)	Total Tx Bandedge Level (dBm)	Limit (dBm)	Margin (dB)
2412	CCK, 1 to 11 Mbps	1	6	-37.0		-31.0	-21.25	9.8
	CCK, 1 to 11 Mbps	2	6	-37.0	-39.6	-29.1	-21.25	7.8
	Non HT20, 6 to 54 Mbps	1	6	-28.2		-22.2	-21.25	1.0
	Non HT20, 6 to 54 Mbps	2	6	-31.0	-36.1	-23.8	-21.25	2.6
	Non HT20 Beam Forming, 6 to 54 Mbps	2	9	-36.1	-33.2	-22.4	-21.25	1.2
	HT/VHT20, M0 to M7	1	6	-29.5		-23.5	-21.25	2.3
	HT/VHT20, M0 to M7	2	6	-32.6	-29.7	-21.9	-21.25	0.7
	HT/VHT20, M8 to M15	2	6	-32.6	-29.7	-21.9	-21.25	0.7
	HT/VHT20 Beam Forming, M0 to M7	2	9	-32.5	-35.3	-21.7	-21.25	0.4
	HT/VHT20 Beam Forming, M8 to M15	2	6	-32.6	-29.7	-21.9	-21.25	0.7
	HT/VHT20 STBC, M0 to M7	2	6	-32.6	-29.7	-21.9	-21.25	0.7
2422	Non HT40, 6 to 54 Mbps	1	6	-29.4		-23.4	-21.25	2.2
	Non HT40, 6 to 54 Mbps	2	6	-29.9	-34.8	-22.7	-21.25	1.4
	HT/VHT40, M0 to M7	1	6	-28.9		-22.9	-21.25	1.7
	HT/VHT40, M0 to M7	2	6	-34.2	-36.1	-26.0	-21.25	4.8
	HT/VHT40, M8 to M15	2	6	-34.2	-36.1	-26.0	-21.25	4.8
	HT/VHT40 Beam Forming, M0 to M7	2	9	-34.2	-36.1	-23.0	-21.25	1.8
	HT/VHT40 Beam Forming, M8 to M15	2	6	-34.2	-36.1	-26.0	-21.25	4.8
	HT/VHT40 STBC, M0 to M7	2	6	-34.2	-36.1	-26.0	-21.25	4.8
2462	CCK, 1 to 11 Mbps	1	6	-37.7		-31.7	-21.25	10.5
	CCK, 1 to 11 Mbps	2	6	-37.7	-39.6	-29.5	-21.25	8.3
	Non HT20, 6 to 54 Mbps	1	6	-28.9		-22.9	-21.25	1.7
	Non HT20, 6 to 54 Mbps	2	6	-31.2	-30.5	-21.8	-21.25	0.6
	Non HT20 Beam Forming, 6 to 54 Mbps	2	9	-35.7	-33.0	-22.1	-21.25	0.9
	HT/VHT20, M0 to M7	1	6	-28.9		-22.9	-21.25	1.7
	HT/VHT20, M0 to M7	2	6	-30.8	-34.6	-23.3	-21.25	2.0
	HT/VHT20, M8 to M15	2	6	-30.8	-34.6	-23.3	-21.25	2.0
	HT/VHT20 Beam Forming, M0 to M7	2	9	-34.0	-36.5	-23.1	-21.25	1.8
	HT/VHT20 Beam Forming, M8 to M15	2	6	-30.8	-34.6	-23.3	-21.25	2.0
	HT/VHT20 STBC, M0 to M7	2	6	-30.8	-34.6	-23.3	-21.25	2.0

Conducted Bandedge Peak, 2412 MHz, HT/VHT20 Beam Forming, M0 to M7



Antenna A

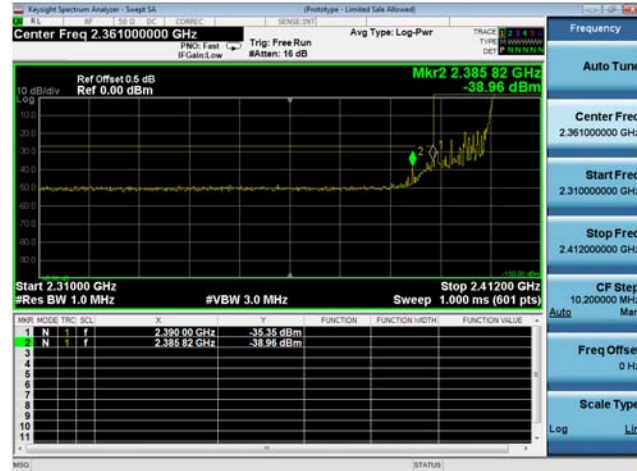

Antenna B

Conducted Bandedge Peak, 2462 MHz, Non HT20, 6 to 54 Mbps



Antenna A

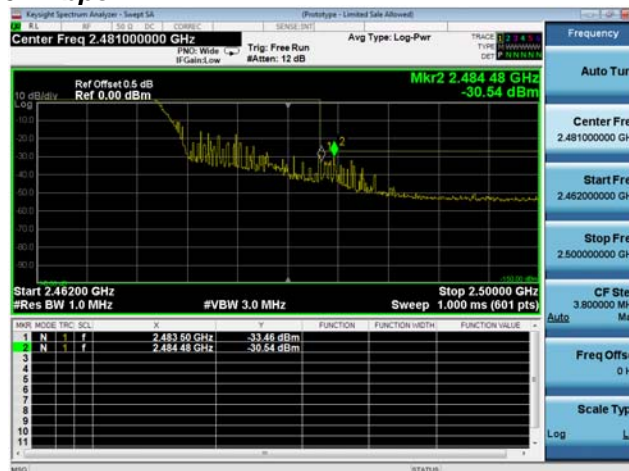

Antenna B



Antenna Gain: 8 dBi

Frequency (MHz)	Mode	Tx Paths	Correlated Antenna Gain (dBi)	Tx 1 Bandedge Level (dBm)	Tx 2 Bandedge Level (dBm)	Total Tx Bandedge Level (dBm)	Limit (dBm)	Margin (dB)
2412	CCK, 1 to 11 Mbps	1	8	-37.0		-29.0	-21.25	7.8
	CCK, 1 to 11 Mbps	2	8	-37.0	-39.6	-27.1	-21.25	5.8
	Non HT20, 6 to 54 Mbps	1	8	-32.1		-24.1	-21.25	2.9
	Non HT20, 6 to 54 Mbps	2	8	-31.0	-36.1	-21.8	-21.25	0.6
	Non HT20 Beam Forming, 6 to 54 Mbps	2	11	-39.2	-36.2	-23.4	-21.25	2.2
	HT/VHT20, M0 to M7	1	8	-32.6		-24.6	-21.25	3.4
	HT/VHT20, M0 to M7	2	8	-32.5	-35.3	-22.7	-21.25	1.4
	HT/VHT20, M8 to M15	2	8	-32.5	-35.3	-22.7	-21.25	1.4
	HT/VHT20 Beam Forming, M0 to M7	2	11	-37.8	-38.1	-23.9	-21.25	2.7
	HT/VHT20 Beam Forming, M8 to M15	2	8	-32.5	-35.3	-22.7	-21.25	1.4
	HT/VHT20 STBC, M0 to M7	2	8	-32.5	-35.3	-22.7	-21.25	1.4
2422	Non HT40, 6 to 54 Mbps	1	8	-29.4		-21.4	-21.25	0.1
	Non HT40, 6 to 54 Mbps	2	8	-32.5	-32.6	-21.5	-21.25	0.3
	HT/VHT40, M0 to M7	1	8	-29.8		-21.8	-21.25	0.6
	HT/VHT40, M0 to M7	2	8	-34.2	-36.1	-24.0	-21.25	2.8
	HT/VHT40, M8 to M15	2	8	-34.2	-36.1	-24.0	-21.25	2.8
	HT/VHT40 Beam Forming, M0 to M7	2	11	-38.0	-36.0	-22.9	-21.25	1.6
	HT/VHT40 Beam Forming, M8 to M15	2	8	-34.2	-36.1	-24.0	-21.25	2.8
	HT/VHT40 STBC, M0 to M7	2	8	-34.2	-36.1	-24.0	-21.25	2.8
2462	CCK, 1 to 11 Mbps	1	8	-37.7		-29.7	-21.25	8.5
	CCK, 1 to 11 Mbps	2	8	-42.6	-40.8	-30.6	-21.25	9.3
	Non HT20, 6 to 54 Mbps	1	8	-30.6		-22.6	-21.25	1.4
	Non HT20, 6 to 54 Mbps	2	8	-33.2	-31.8	-21.4	-21.25	0.2
	Non HT20 Beam Forming, 6 to 54 Mbps	2	11	-35.1	-38.2	-22.4	-21.25	1.1
	HT/VHT20, M0 to M7	1	8	-30.6		-22.6	-21.25	1.4
	HT/VHT20, M0 to M7	2	8	-30.8	-34.6	-21.3	-21.25	0.0
	HT/VHT20, M8 to M15	2	8	-30.8	-34.6	-21.3	-21.25	0.0
	HT/VHT20 Beam Forming, M0 to M7	2	11	-35.2	-37.1	-22.0	-21.25	0.8
	HT/VHT20 Beam Forming, M8 to M15	2	8	-30.8	-34.6	-21.3	-21.25	0.0
	HT/VHT20 STBC, M0 to M7	2	8	-30.8	-34.6	-21.3	-21.25	0.0

Conducted Bandedge Peak, 2422 MHz, Non HT40, 6 to 54 Mbps



Antenna A

Conducted Bandedge Peak, 2462 MHz, HT/VHT20, M0 to M7



Antenna A



Antenna B