

Test Report
AIR-AP1562E-B-K9

FCC ID: LDK102103

AIR-AP1562E-A-K9
IC: 2461B-102103

Cisco Aironet 802.11ac Dual Band Outdoor Access Points

5725-5850 MHz

Against the following Specifications:

CFR47 Part 15.407

RSS-247



Cisco Systems

170 West Tasman Drive

San Jose, CA 95134

	
Author: Jose Aguirre Tested By:	Approved By: Jim Nicholson Title: Technical Leader, Engineering Revision: 1

This report replaces any previously entered test report under EDCS – **11346268**. This test report has been electronically authorized and archived using the CISCO Engineering Document Control system.

This test report has been electronically authorized and archived using the CISCO Engineering Document Control system.

SECTION 1: OVERVIEW	4
SECTION 2: ASSESSMENT INFORMATION	5
2.1 GENERAL	5
2.2 DATE OF TESTING.....	7
2.3 REPORT ISSUE DATE	7
2.4 TESTING FACILITIES	7
2.5 EQUIPMENT ASSESSED (EUT).....	7
2.6 EUT DESCRIPTION.....	8
SECTION 3: RESULT SUMMARY	10
3.1 RESULTS SUMMARY TABLE	10
SECTION 4: SAMPLE DETAILS.....	11
4.1 SAMPLE DETAILS	11
4.2 SYSTEM DETAILS	11
4.3 MODE OF OPERATION DETAILS.....	11
APPENDIX A: EMISSION TEST RESULTS	12
CONDUCTED TEST SETUP DIAGRAM.....	12
TARGET MAXIMUM CHANNEL POWER	12
Antenna Gain: 5 dBi	12
Antenna Gain: 7 dBi	13
Antenna Gain: 8 dBi	14
Antenna Gain: 13 dBi	15
Antenna Gain: 14 dBi	16
A.1 6dB BANDWIDTH.....	17
A.2 99% AND 26DB BANDWIDTH.....	25
A.3 MAXIMUM CONDUCTED OUTPUT POWER	33
Antenna Gain: 5 dBi	34
Antenna Gain: 7 dBi	37
Antenna Gain: 8 dBi	40
Antenna Gain: 13 dBi	43
Antenna Gain: 14 dBi	46
A.4 POWER SPECTRAL DENSITY	49
Antenna Gain: 5 dBi	50
Antenna Gain: 7 dBi	53
Antenna Gain: 8 dBi	56
Antenna Gain: 13 dBi	59
Antenna Gain: 14 (dBi	62
A.5 CONDUCTED SPURIOUS EMISSIONS	65
A.6 CONDUCTED BANDEDGE.....	74
APPENDIX B: EMISSION TEST RESULTS	82
RADIATED EMISSION SETUP DIAGRAM-BELOW 1G.....	82
B.1 RADIATED SPURIOUS EMISSIONS	83
B.2 RECEIVER SPURIOUS EMISSIONS	94



B.3 RADIATED EMISSIONS 30MHZ TO 1GHZ97
B.4 AC CONDUCTED EMISSIONS100
APPENDIX C: LIST OF TEST EQUIPMENT USED TO PERFORM THE TEST104
APPENDIX E: ABBREVIATION KEY AND DEFINITIONS107



Section 1: Overview

The samples were assessed against the tests detailed in section 3 under the requirements of the following specifications:

Specifications:
CFR47 Part 15.407 RSS-247

Measurements were made in accordance with

- ANSI C63.10:2013
- KDB 789033 D02 General UNII Test Procedures New Rules v01r03
- KDB 662911 D01 Multiple Transmitter Output v02r01

Section 2: Assessment Information

2.1 General

This report contains an assessment of an apparatus against Electromagnetic Compatibility Standards based upon tests carried out on the samples submitted. The testing was performed by and for the use of Cisco systems Inc:

With regard to this assessment, the following points should be noted:

- a) The results contained in this report relate only to the items tested and were obtained in the period between the date of the initial assessment and the date of issue of the report. Manufactured products will not necessarily give identical results due to production and measurement tolerances.
- b) The apparatus was set up and exercised using the configuration and modes of operation defined in this report only.
- c) Where relevant, the apparatus was only assessed using the susceptibility criteria defined in this report and the Test Assessment Plan (TAP).
- d) All testing was performed under the following environmental conditions:

Temperature	15°C to 35°C (54°F to 95°F)
Atmospheric Pressure	860mbar to 1060mbar (25.4" to 31.3")
Humidity	10% to 75*%
- e) All AC testing was performed at one or more of the following supply voltages:
110V 60 Hz (+/-20%)

Units of Measurement

The units of measurements defined in the appendices are reported in specific terms, which are test dependent. Where radiated measurements are concerned these are defined at a particular distance. Basic voltage measurements are defined in units of [dBuV]

As an example, the basic calculation for all measurements is as follows:

$$\text{Emission level [dBuV]} = \text{Indicated voltage level [dBuV]} + \text{Cable Loss [dB]} + \text{Other correction factors [dB]}$$

The combinations of correction factors are dependent upon the exact test configurations [see test equipment lists for further details] and may include:-

Antenna Factors, Pre Amplifier Gain, LISN Loss, Pulse Limiter Loss and Filter Insertion Loss

Note: to convert the results from dBuV/m to uV/m use the following formula:-

$$\text{Level in uV/m} = \text{Common Antilogarithm} [(X \text{ dBuV/m})/20] = Y \text{ uV/m}$$

Measurement Uncertainty Values

voltage and power measurements	± 2 dB
conducted EIRP measurements	± 1.4 dB
radiated measurements	± 3.2 dB
frequency measurements	± 2.4 10 ⁻⁷
temperature measurements	± 0.54°
humidity measurements	± 2.3%
DC and low frequency measurements	± 2.5%

Where relevant measurement uncertainty levels have been estimated for tests performed on the apparatus. This uncertainty represents an expanded uncertainty expressed at approximately the 95% confidence level using a coverage factor of k=2.

Radiated emissions (expanded uncertainty, confidence interval 95%)

30 MHz - 300 MHz	+/- 3.8 dB
300 MHz - 1000 MHz	+/- 4.3 dB
1 GHz - 10 GHz	+/- 4.0 dB
10 GHz - 18GHz	+/- 8.2 dB
18GHz - 26.5GHz	+/- 4.1 dB
26.5GHz - 40GHz	+/- 3.9 dB

Conducted emissions (expanded uncertainty, confidence interval 95%)

30 MHz – 40GHz	+/- 0.38 dB
----------------	-------------

A product is considered to comply with a requirement if the nominal measured value is below the limit line. The product is considered to not be in compliance in case the nominal measured value is above the limit line.

This report must not be reproduced except in full, without written approval of Cisco Systems.

2.2 Date of testing

20-April-16 - 08-Aug-16

2.3 Report Issue Date

30-August-2016

Cisco uses an electronic system to issue, store and control the revision of test reports. This system is called the Engineering Document Control System (EDCS). The actual report issue date is embedded into the original file on EDCS. Any copies of this report, either electronic or paper, that are not on EDCS must be considered uncontrolled.

2.4 Testing facilities

This assessment was performed by:

Testing Laboratory

Cisco Systems, Inc.,
125 West Tasman Drive
San Jose, CA 95134, USA

Registration Numbers for Industry Canada

Cisco System Site	Address	Site Identifier
Building P, 10m Chamber	125 West Tasman Dr San Jose, CA 95134	Company #: 2461N-2
Building P, 5m Chamber	125 West Tasman Dr San Jose, CA 95134	Company #: 2461N-1
Building I, 5m Chamber	285 W. Tasman Drive San Jose, California 95134	Company #: 2461M-1

Test Engineers

Jose Aguirre

2.5 Equipment Assessed (EUT)

AIR-AP1562E-B-K9

2.6 EUT Description

The Cisco Aironet 802.11ac Radio supports the following modes of operation. The modes are further defined in the radio Theory of Operation. The modes included in this report represent the worst case data for all modes.

802.11n/ac - Non HT20, One Antenna, 6 to 54 Mbps
802.11n/ac - Non HT20, Two Antennas, 6 to 54 Mbps

802.11n/ac-Non HT20 Beam Forming, Two Antenna, 6-54 Mbps

802.11n/ac - HT/VHT20, One Antenna, M0 to M7
802.11n/ac - HT/VHT20, Two Antennas, M0 to M7
802.11n/ac - HT/VHT20, Two Antennas, M8 to M15

802.11n/ac - HT/VHT20 Beam Forming, Two Antennas, M0 to M7
802.11n/ac - HT/VHT20 Beam Forming, Two Antennas, M8 to M15

802.11n/ac - HT/VHT20 STBC, Two Antennas, M0 to M7

802.11n/ac - Non HT40 Duplicate, One Antenna, 6 to 54 Mbps
802.11n/ac - Non HT40 Duplicate, Two Antennas, 6 to 54 Mbps

802.11n/ac - HT/VHT40, One Antenna, M0 to M7
802.11n/ac - HT/VHT40, Two Antennas, M0 to M7
802.11n/ac - HT/VHT40, Two Antennas, M8 to M15

802.11n/ac - HT/VHT40 Beam Forming, Two Antennas, M0 to M7
802.11n/ac - HT/VHT40 Beam Forming, Two Antennas, M8 to M15

802.11n/ac - HT/VHT40 STBC, Two Antennas, M0 to M7

802.11n/ac - Non HT80 Duplicate, One Antenna, 6 to 54 Mbps
802.11n/ac - Non HT80 Duplicate, Two Antennas, 6 to 54 Mbps

802.11ac - VHT80, One Antenna, M0 to M9 1ss
802.11ac - VHT80, Two Antennas, M0 to M9 1ss
802.11ac - VHT80, Two Antennas, M0 to M9 2ss

802.11ac - VHT80 Beam Forming, Two Antennas, M0 to M9 1ss
802.11ac - VHT80 Beam Forming, Two Antennas, M0 to M9 2ss

802.11ac - VHT80 STBC, Two Antennas, M0 to M9 1ss

The following antennas are supported by this product series.
The data included in this report represent the worst case data for all antennas.

Frequency	Part Number	Antenna Type	Antenna Gain (dBi)
5 GHz	AIR-ANT5180V-N	Single Band Omni	8
	AIR-ANT5150HG-N	Horizontal Polarized Omni	5
	AIR-ANT5150VG-N	Vertical Polarized Omni	5
	AIR-ANT5114P2M-N	Single Band, Cross Polarized Directional Patch	14
5 GHz	AIR-ANT2547V-N=	Dual-band Omni	7
	AIR-ANT2547VG-N=	Dual-band Omni, Gray	7
	AIR-ANT2568VG-N	Dual-band Omni	8
	AIR-ANT2588P3M-N=	Dual-band/Dual Polarized Directional, Patch	8
	AIR-ANT2513P4M-N	Dual-band Cross Polarization Patch Array	13

Section 3: Result Summary

3.1 Results Summary Table

Conducted emissions

Basic Standard	Technical Requirements / Details	Result
FCC 15.407 RSS-247	6dB Bandwidth: Systems using digital modulation techniques may operate in the 2400-2483.5MHz band. The minimum 6dB bandwidth shall be at least 500 kHz.	Pass
FCC 15.407 RSS-GEN	99% & 26 dB Bandwidth: The 99% occupied bandwidth is the frequency bandwidth such that, below its lower and above its upper frequency limits, the mean powers are each equal to 0.5% of the total mean power of the given emission. There is no limit for 99% OBW. The 26 dB emission is the width of the emission that is constrained by the frequencies associated with the two outermost amplitude points (upper and lower frequencies) that are attenuated by 26 dB relative to the maximum level measured in the fundamental emission.	Pass
FCC 15.407 RSS-247	Output Power: For the band 5.725-5.85 GHz, the maximum conducted output power over the frequency band of operation shall not exceed 1 W.	Pass
FCC 15.407 RSS-247	Power Spectral Density: 15.407 The maximum power spectral density shall not exceed 30 dBm in any 500-kHz band.	Pass
FCC 15.407 RSS-247	Conducted Spurious Emissions / Band-Edge: For transmitters operating in the 5.725-5.85 GHz band: All emissions within the frequency range from the band edge to 10 MHz above or below the band edge shall not exceed an e.i.r.p. of -17 dBm/MHz; for frequencies 10 MHz or greater above or below the band edge, emissions shall not exceed an e.i.r.p. of -27 dBm/MHz.	Pass
FCC 15.209 FCC 152.05 RSS-GEN	Restricted band: Unwanted emissions falling within the restricted bands, as defined in FCC 15.205 (a) must also comply with the radiated emission limits specified in FCC 15.209 (a).	Pass

Radiated Emissions (General requirements)

Basic Standard	Technical Requirements / Details	Result
FCC 15.209 FCC 15.205 RSS-GEN	TX Spurious Emissions: Except as provided elsewhere in this subpart, the emissions from an intentional radiator shall not exceed the field strength levels specified in the filed strength limits table in this section.	Pass
FCC 15.207 RSS-GEN	AC conducted Emissions: Except when the requirements applicable to a given device state otherwise, for any radio apparatus equipped to operate from the public utility AC power supply, either directly or indirectly (such as with a battery charger), the radio frequency voltage of emissions conducted back onto the AC power lines in the frequency range of 0.15 MHz to 30 MHz shall not exceed the limits shown in the table in these sections. The more stringent limit applies at the frequency range boundaries.	Pass

* MPE calculation is recorded in a separate report

Section 4: Sample Details

Note: Each sample was evaluated to ensure that its condition was suitable to be used as a test sample prior to the commencement of testing.

4.1 Sample Details

Sample No.	Equipment Details	Manufacturer	Hardware Rev.	Firmware Rev.	Software Rev.	Serial Number
S01	AIR-AP1562E-B-K9	Cisco Systems	P2	9.1.8.1	9.0.5.5-W8964	RFDP2BML083
S02*	AIR-PWRADPT-RGD1	Meanwell	A0	NA	NA	EB3F71752

(*) S02 is support equipment Power supply for EUT S01

4.2 System Details

System #	Description	Samples
1	AIR-AP1562E-B-K9	S01
2	AIR-PWRADPT-RGD1	S02

4.3 Mode of Operation Details

Mode#	Description	Comments
1	Continuous Transmitting	Continuous Transmitting $\geq 98\%$ duty cycle

All measurements were made in accordance with

- ANSI C63.10:2013
- KDB 789033 D02 General UNII Test Procedures New Rules v01r03
- KDB 662911 D01 Multiple Transmitter Output v02r01

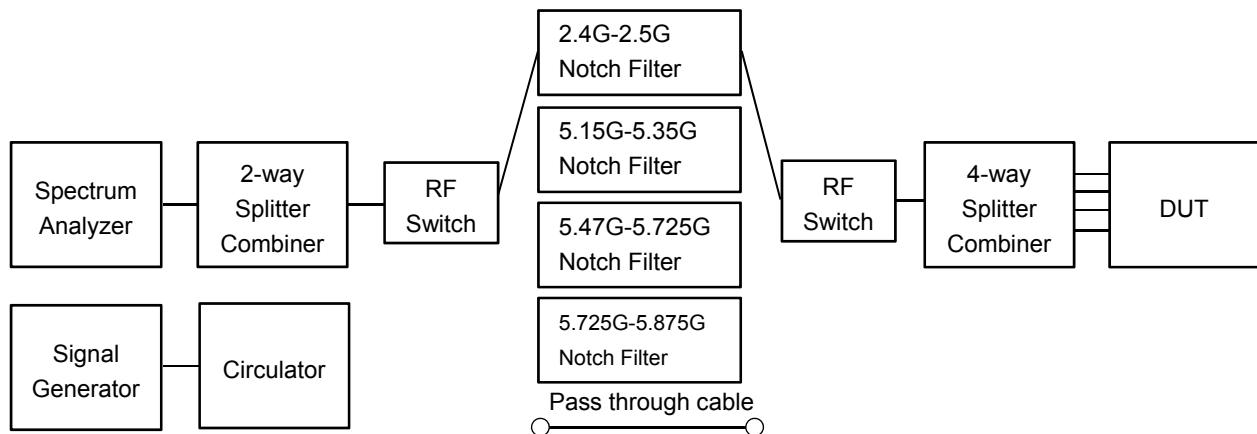
Appendix A: Emission Test Results**Conducted Test Setup Diagram****Target Maximum Channel Power**

The following table details the maximum supported Total Channel Power for all operating modes.

Antenna Gain: 5 dBi

Operating Mode	Maximum Channel Power (dBm)		
	Frequency (MHz)		
	5745	5785	5825
Non HT20, 6 to 54 Mbps	27	26	23
Non HT20 Beam Forming, 6 to 54 Mbps	27	19	18
HT/VHT20, M0 to M15	24	22	23
HT/VHT20 Beam Forming, M0 to M15	23	21	22
HT/VHT20 STBC, M0 to M7	23	21	22
	5755	5795	
Non HT40, 6 to 54 Mbps	26	23	
HT/VHT40, M0 to M15	24	23	
HT/VHT40 Beam Forming, M0 to M15	23	21	
HT/VHT40 STBC, M0 to M7	23	21	
	5775		
Non HT80, 6 to 54 Mbps	22		
VHT80, M0 to M9, M0 to M9 1-1ss	27		
VHT80 Beam Forming, M0 to M9, M0 to M9 1-1ss	27		
VHT80 STBC, M0 to M9 1ss	27		

Antenna Gain: 7 dBi

Operating Mode	Maximum Channel Power (dBm)		
	Frequency (MHz)		
	5745	5785	5825
Non HT20, 6 to 54 Mbps	27	24	23
Non HT20 Beam Forming, 6 to 54 Mbps	26	15	15
HT/VHT20, M0 to M15	24	20	23
HT/VHT20 Beam Forming, M0 to M15	21	20	18
HT/VHT20 STBC, M0 to M7	21	20	18
	5755	5795	
Non HT40, 6 to 54 Mbps	23	23	
HT/VHT40, M0 to M15	24	23	
HT/VHT40 Beam Forming, M0 to M15	23	19	
HT/VHT40 STBC, M0 to M7	23	19	
	5775		
Non HT80, 6 to 54 Mbps	21		
VHT80, M0 to M9, M0 to M9 1-1ss	24		
VHT80 Beam Forming, M0 to M9, M0 to M9 1-1ss	21		
VHT80 STBC, M0 to M9 1ss	21		

Antenna Gain: 8 dBi

Operating Mode	Maximum Channel Power (dBm)		
	Frequency (MHz)		
	5745	5785	5825
Non HT20, 6 to 54 Mbps	27	24	23
Non HT20 Beam Forming, 6 to 54 Mbps	25	15	14
HT/VHT20, M0 to M15	24	19	23
HT/VHT20 Beam Forming, M0 to M15	21	19	18
HT/VHT20 STBC, M0 to M7	21	19	18
	5755	5795	
Non HT40, 6 to 54 Mbps	23	18	
HT/VHT40, M0 to M15	24	23	
HT/VHT40 Beam Forming, M0 to M15	21	19	
HT/VHT40 STBC, M0 to M7	21	19	
	5775		
Non HT80, 6 to 54 Mbps	21		
VHT80, M0 to M9, M0 to M9 1-1ss	24		
VHT80 Beam Forming, M0 to M9, M0 to M9 1-1ss	21		
VHT80 STBC, M0 to M9 1ss	21		

Antenna Gain: 13 dBi

Operating Mode	Maximum Channel Power (dBm)		
	Frequency (MHz)		
	5745	5785	5825
Non HT20, 6 to 54 Mbps	27	13	13
Non HT20 Beam Forming, 6 to 54 Mbps	27	13	13
HT/VHT20, M0 to M15	22	14	13
HT/VHT20 Beam Forming, M0 to M15	15	14	13
HT/VHT20 STBC, M0 to M7	15	14	13
	5755	5795	
Non HT40, 6 to 54 Mbps	21	13	
HT/VHT40, M0 to M15	22	14	
HT/VHT40 Beam Forming, M0 to M15	17	13	
HT/VHT40 STBC, M0 to M7	17	13	
	5775		
Non HT80, 6 to 54 Mbps	18		
VHT80, M0 to M9, M0 to M9 1-1ss	22		
VHT80 Beam Forming, M0 to M9, M0 to M9 1-1ss	16		
VHT80 STBC, M0 to M9 1ss	16		

Antenna Gain: 14 dBi

Operating Mode	Maximum Channel Power (dBm)		
	Frequency (MHz)		
	5745	5785	5825
Non HT20, 6 to 54 Mbps	27	13	12
Non HT20 Beam Forming, 6 to 54 Mbps	27	13	12
HT/VHT20, M0 to M15	22	13	12
HT/VHT20 Beam Forming, M0 to M15	15	13	12
HT/VHT20 STBC, M0 to M7	15	13	12
	5755	5795	
Non HT40, 6 to 54 Mbps	21	11	
HT/VHT40, M0 to M15	22	12	
HT/VHT40 Beam Forming, M0 to M15	15	12	
HT/VHT40 STBC, M0 to M7	15	12	
	5775		
Non HT80, 6 to 54 Mbps	18		
VHT80, M0 to M9, M0 to M9 1-1ss	22		
VHT80 Beam Forming, M0 to M9, M0 to M9 1-1ss	15		
VHT80 STBC, M0 to M9 1ss	15		

A.1 6dB Bandwidth

15.407 / RSS-247 Within the 5.725-5.85 GHz band, the minimum 6 dB bandwidth of U-NII devices shall be at least 500 kHz.

Test Procedure

Ref. KDB 789033 D02 General UNII Test Procedures New Rules v01r03
ANSI C63.10: 2013

6 BW

Test Procedure

1. Set the radio in the continuous transmitting mode.
2. Allow the trace to stabilize.
3. Setting the x-dB bandwidth mode to -6dB within the measurement set up function.
4. Select the automatic OBW measurement function of an instrument to perform bandwidth measurement.
5. Capture graphs and record pertinent measurement data.

Ref. KDB 789033 D02 General UNII Test Procedures New Rules v01r03
ANSI C63.10: 2013 section 11.8.2 Option 2

6 BW

Test parameters

X dB BW = 6dB (using the OBW function of the spectrum analyzer)
Span = Large enough to capture the entire EBW
RBW = 100 KHz
VBW \geq 3 x RBW
Sweep = Auto couple
Detector = Peak or where practical sample shall be used
Trace = Max. Hold

System Number	Description	Samples	System under test	Support equipment
1	EUT	S01	<input checked="" type="checkbox"/>	<input type="checkbox"/>
	Support	S02	<input type="checkbox"/>	<input checked="" type="checkbox"/>

Tested By :

Jose Aguirre

Date of testing:

20-April-16 - 08-Aug-16

Test Result : **PASS**

See Appendix C for list of test equipment

Frequency (MHz)	Mode	Data Rate (Mbps)	6dB BW (MHz)	Limit (kHz)	Margin (MHz)
5745	Non HT20, 6 to 54 Mbps	6	16.4	>500	15.9
	HT/VHT20, M0 to M15	m0	17.6	>500	17.1
5755	Non HT40, 6 to 54 Mbps	6	35.5	>500	35.0
	HT/VHT40, M0 to M15	m0	35.5	>500	35.0
5775	Non HT80, 6 to 54 Mbps	6	76.5	>500	76.0
	VHT80, M0 to M9, M0 to M9 1-1ss	m0x1	76.3	>500	75.8
5785	Non HT20, 6 to 54 Mbps	6	16.4	>500	15.9
	HT/VHT20, M0 to M15	m0	17.6	>500	17.1
5795	Non HT40, 6 to 54 Mbps	6	35.7	>500	35.2
	HT/VHT40, M0 to M15	m0	35.5	>500	35.0
5825	Non HT20, 6 to 54 Mbps	6	16.4	>500	15.9
	HT/VHT20, M0 to M15	m0	17.4	>500	16.9



6dB Bandwidth, 5745 MHz, Non HT20, 6 to 54 Mbps

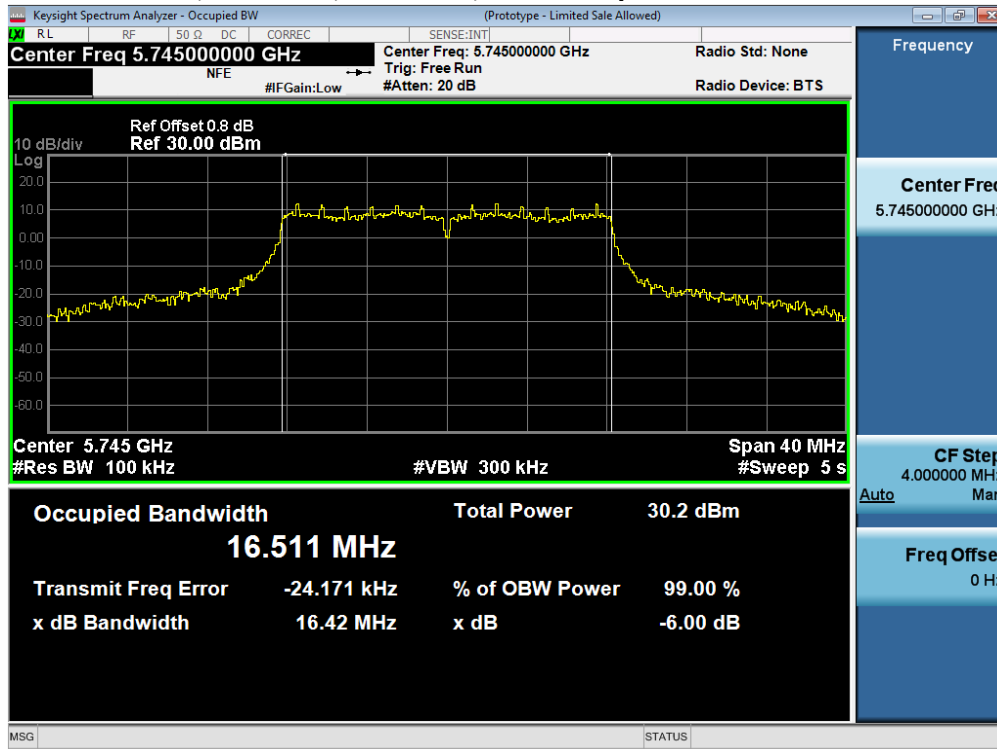

6dB Bandwidth, 5745 MHz, HT/VHT20, M0 to M15

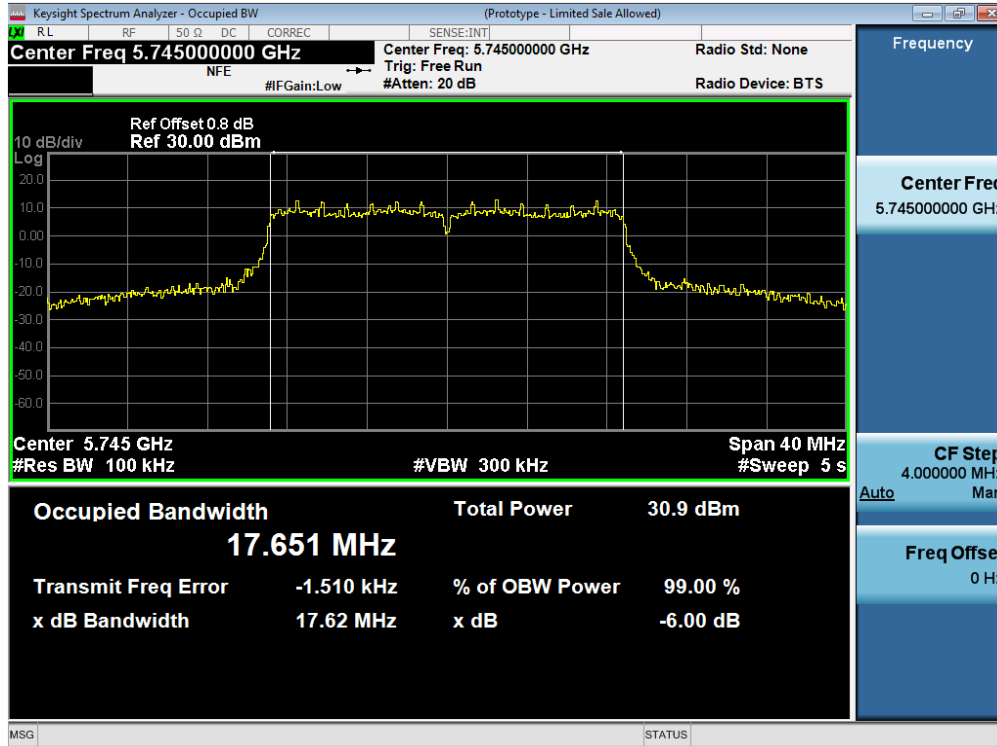

6dB Bandwidth, 5755 MHz, Non HT40, 6 to 54 Mbps

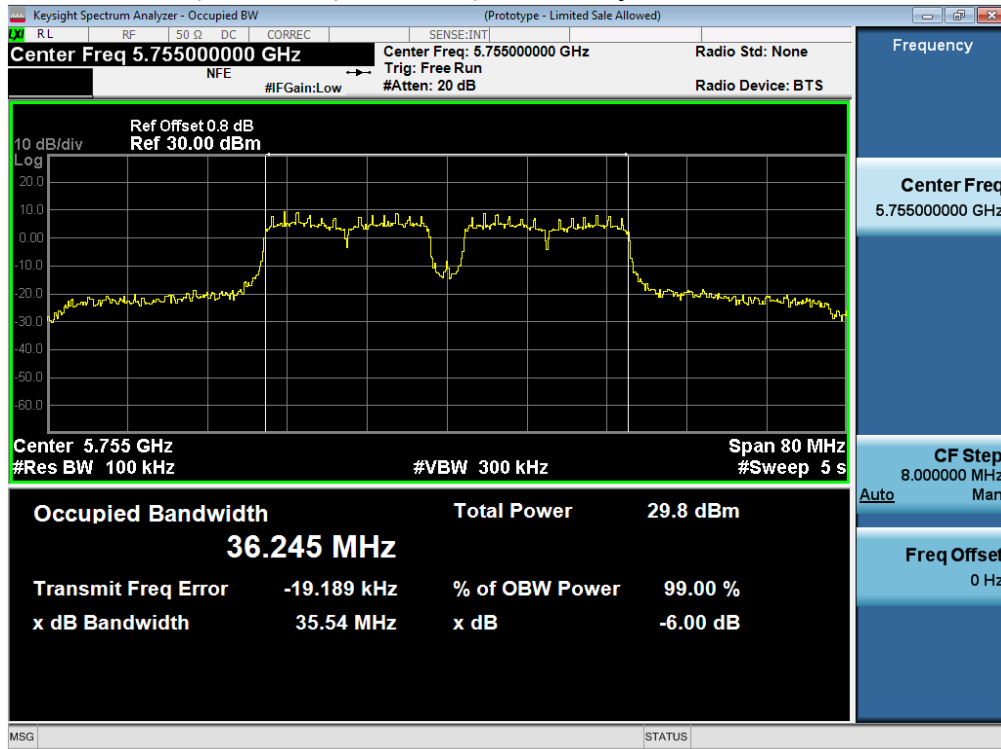

6dB Bandwidth, 5755 MHz, HT/VHT40, M0 to M15

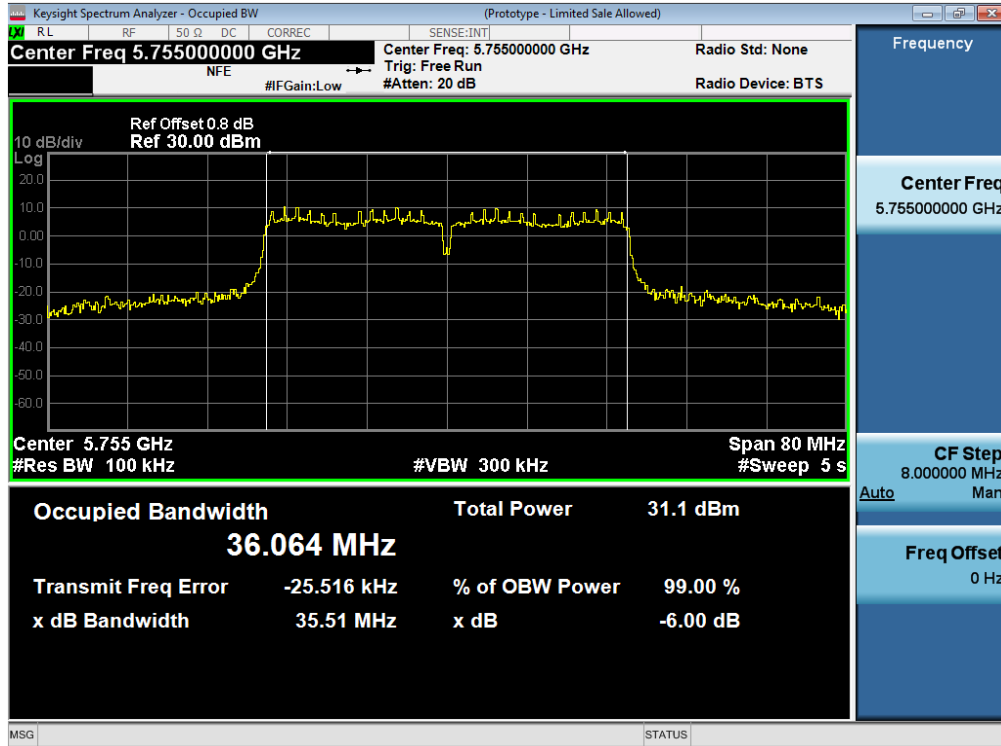



6dB Bandwidth, 5775 MHz, Non HT80, 6 to 54 Mbps

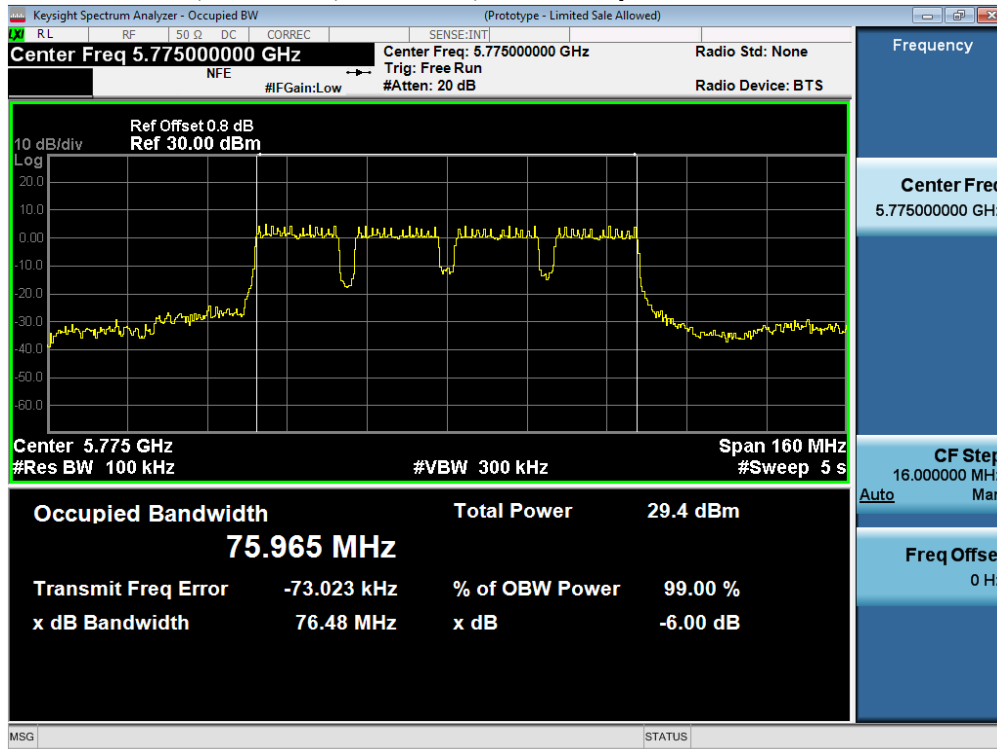

6dB Bandwidth, 5775 MHz, VHT80, M0 to M9, M0 to M9 1-1ss

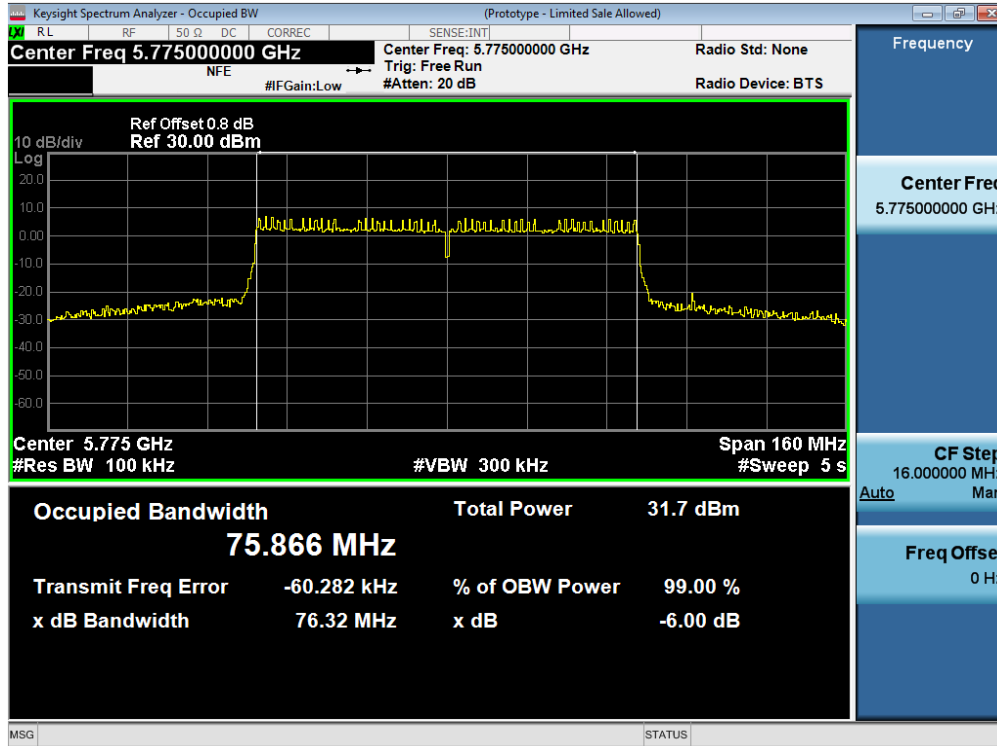

6dB Bandwidth, 5785 MHz, Non HT20, 6 to 54 Mbps

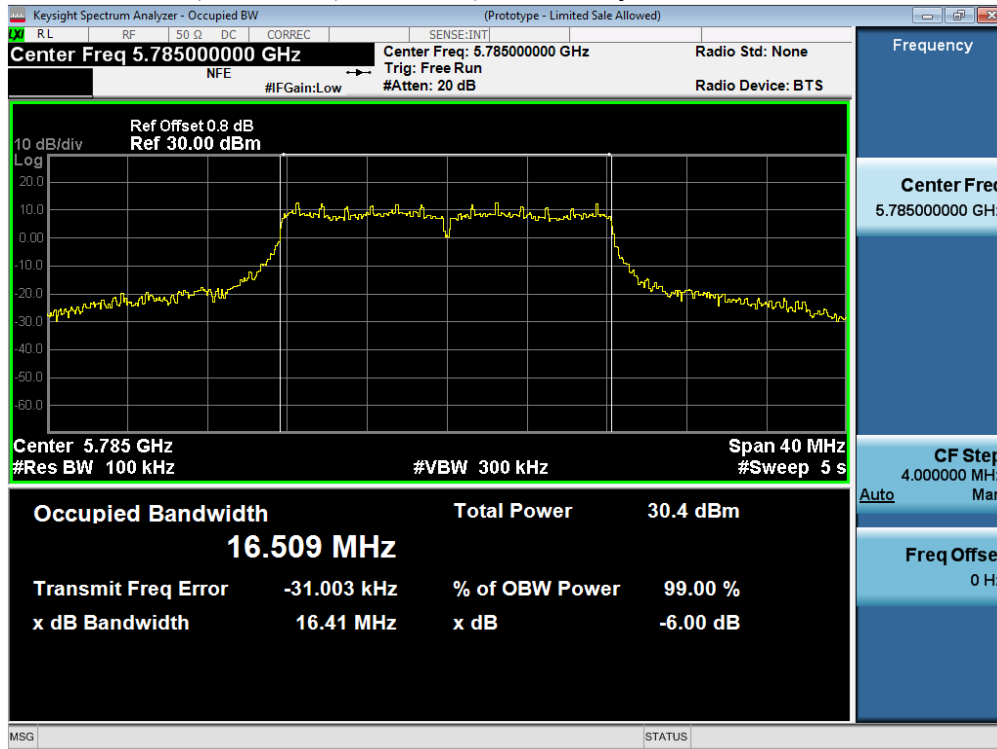

6dB Bandwidth, 5785 MHz, HT/VHT20, M0 to M15

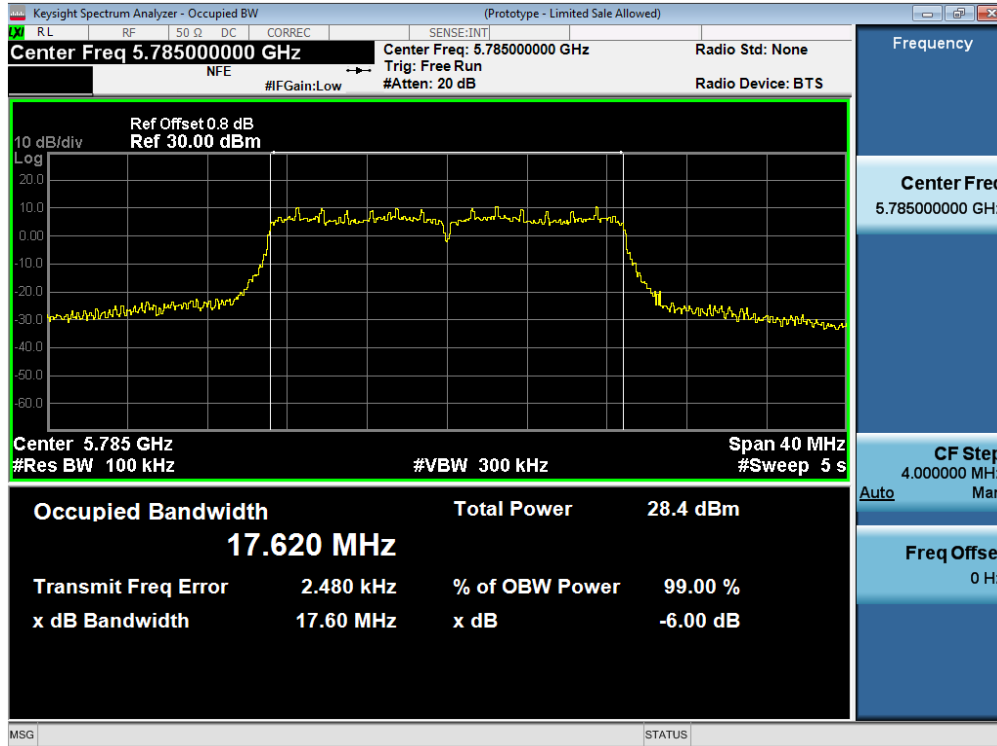



6dB Bandwidth, 5795 MHz, Non HT40, 6 to 54 Mbps

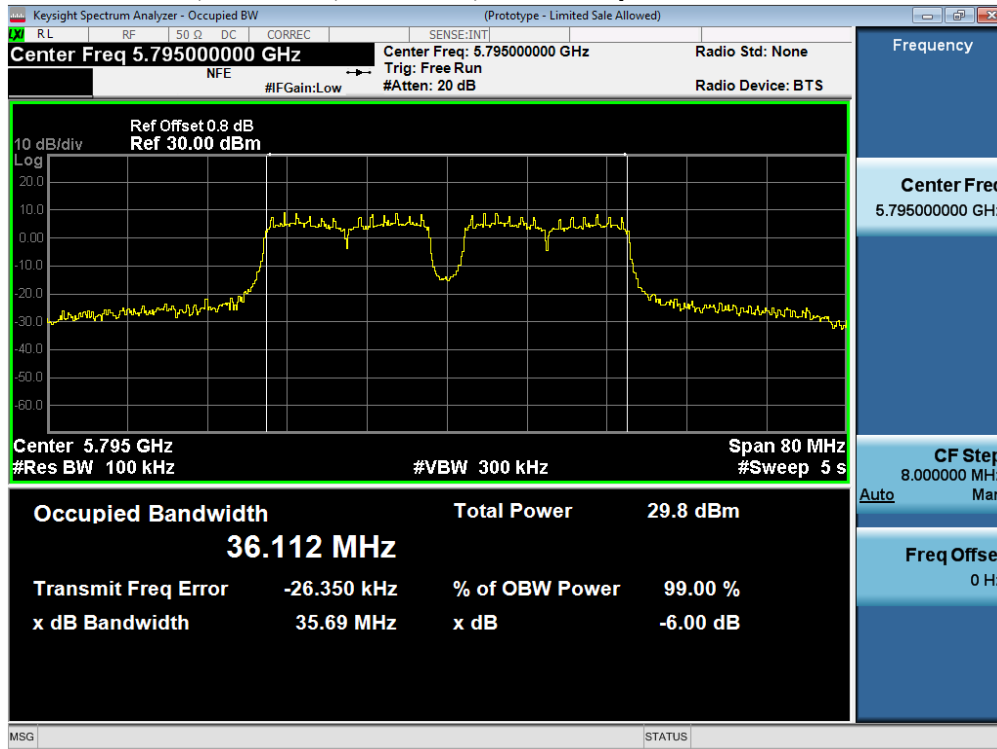

6dB Bandwidth, 5795 MHz, HT/VHT40, M0 to M15

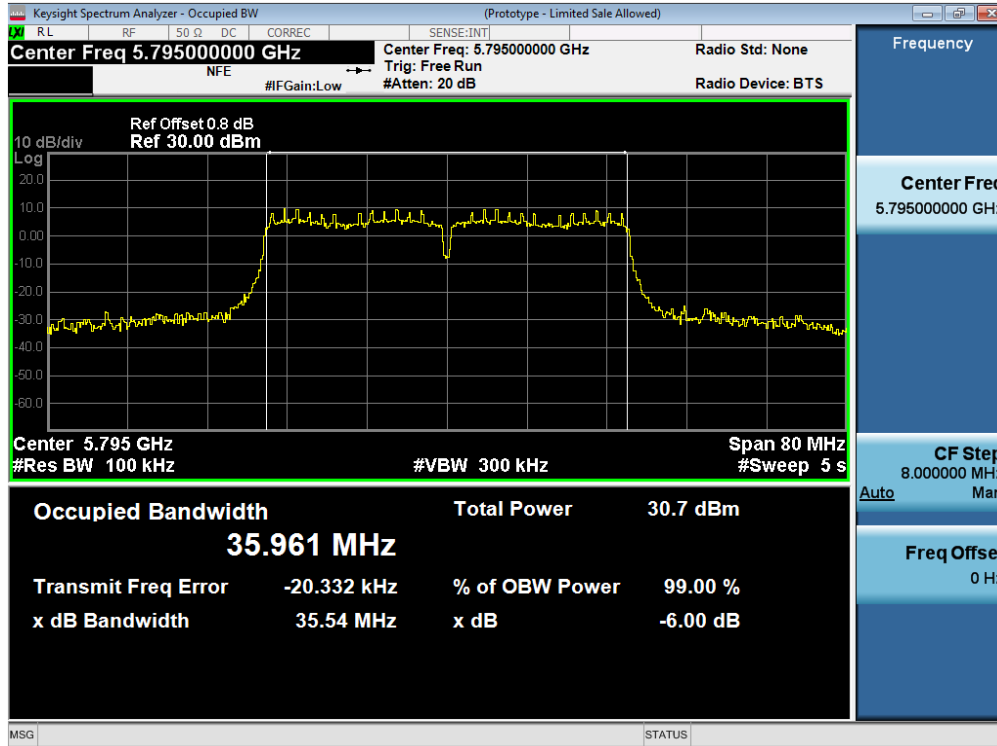



6dB Bandwidth, 5825 MHz, Non HT20, 6 to 54 Mbps



6dB Bandwidth, 5825 MHz, HT/VHT20, M0 to M15

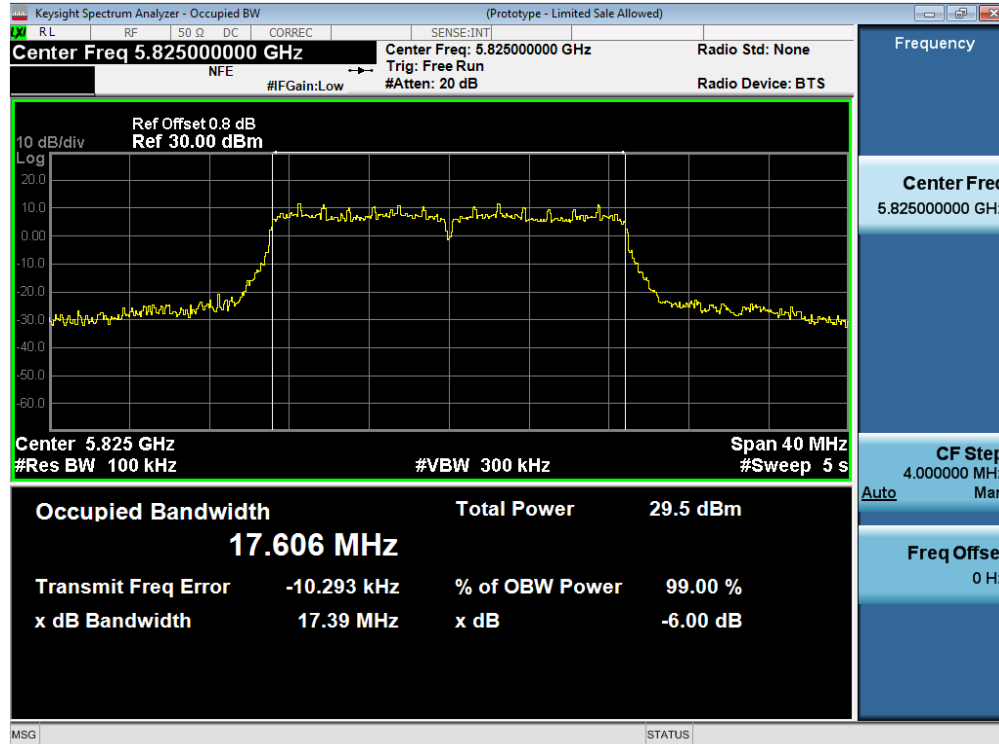

A.2 99% and 26dB Bandwidth

FCC 15.407 / RSS-GEN The 99% occupied bandwidth is the frequency bandwidth such that, below its lower and above its upper frequency limits, the mean powers are each equal to 0.5% of the total mean power of the given emission. There is no limit for 99% OBW.

The 26 dB emission is the width of the emission that is constrained by the frequencies associated with the two outermost amplitude points (upper and lower frequencies) that are attenuated by 26 dB relative to the maximum level measured in the fundamental emission.

Test Procedure

Ref. ANSI C63.10: 2013 Section 6.9.3

99% BW and EBW (-26dB)

Test Procedure

1. Set the radio in the continuous transmitting mode.
2. Allow the trace to stabilize.
3. Setting the x-dB bandwidth mode to -26dB and OBW power function to 99% within the measurement set up function.
4. Select the automatic OBW measurement function of an instrument to perform bandwidth measurement.
5. Capture graphs and record pertinent measurement data.

Ref. ANSI C63.10: 2013 Section 6.9.3

99% BW and EBW (-26dB)

Test parameters

Span = 1.5 x to 5.0 times OBW
 RBW = approx. 1% to 5% of the OBW
 VBW ≥ 3 x RBW
 Detector = Peak or where practical sample shall be used
 Trace = Max. Hold

System Number	Description	Samples	System under test	Support equipment
1	EUT	S01	<input checked="" type="checkbox"/>	<input type="checkbox"/>
	Support	S02	<input type="checkbox"/>	<input checked="" type="checkbox"/>

Tested By :

Jose Aguirre

Date of testing:

20-April-16 - 08-Aug-16

Test Result : PASS

See Appendix C for list of test equipment

Frequency (MHz)	Mode	Data Rate (Mbps)	26dB BW (MHz)	99% BW (MHz)
5745	Non HT20, 6 to 54 Mbps	6	28.9	18.159
	HT/VHT20, M0 to M15	m0	36.5	18.739
5755	Non HT40, 6 to 54 Mbps	6	73.6	37.924
	HT/VHT40, M0 to M15	m0	57.3	36.960
5775	Non HT80, 6 to 54 Mbps	6	93.2	76.637
	VHT80, M0 to M9, M0 to M9 1-1ss	m0x1	105.9	76.828
5785	Non HT20, 6 to 54 Mbps	6	25.7	18.109
	HT/VHT20, M0 to M15	m0	24.0	18.349
5795	Non HT40, 6 to 54 Mbps	6	50.6	37.189
	HT/VHT40, M0 to M15	m0	42.9	36.615
5825	Non HT20, 6 to 54 Mbps	6	26.9	18.076
	HT/VHT20, M0 to M15	m0	23.7	18.415



26dB / 99% Bandwidth, 5745 MHz, Non HT20, 6 to 54 Mbps

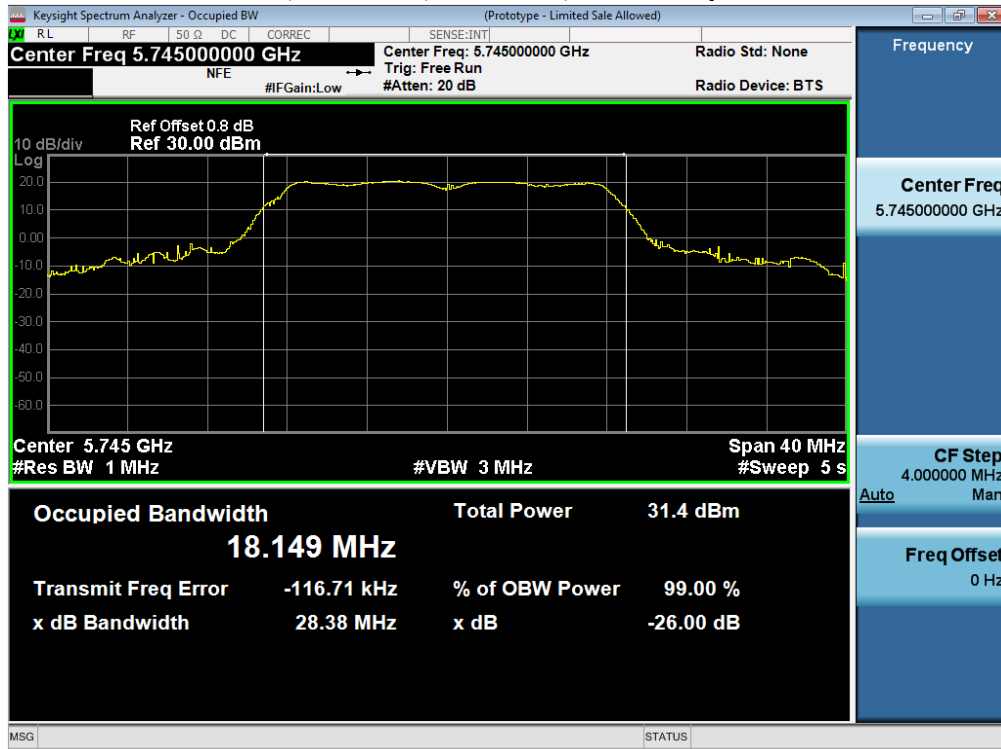

26dB / 99% Bandwidth, 5745 MHz, HT/VHT20, M0 to M15

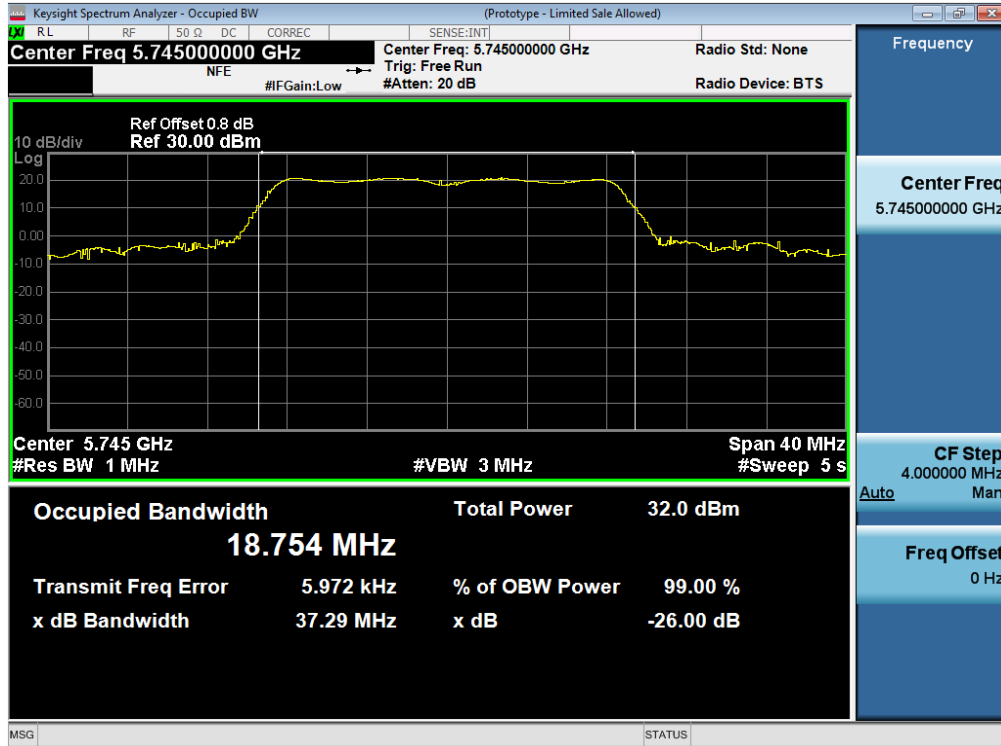



26dB / 99% Bandwidth, 5755 MHz, Non HT40, 6 to 54 Mbps

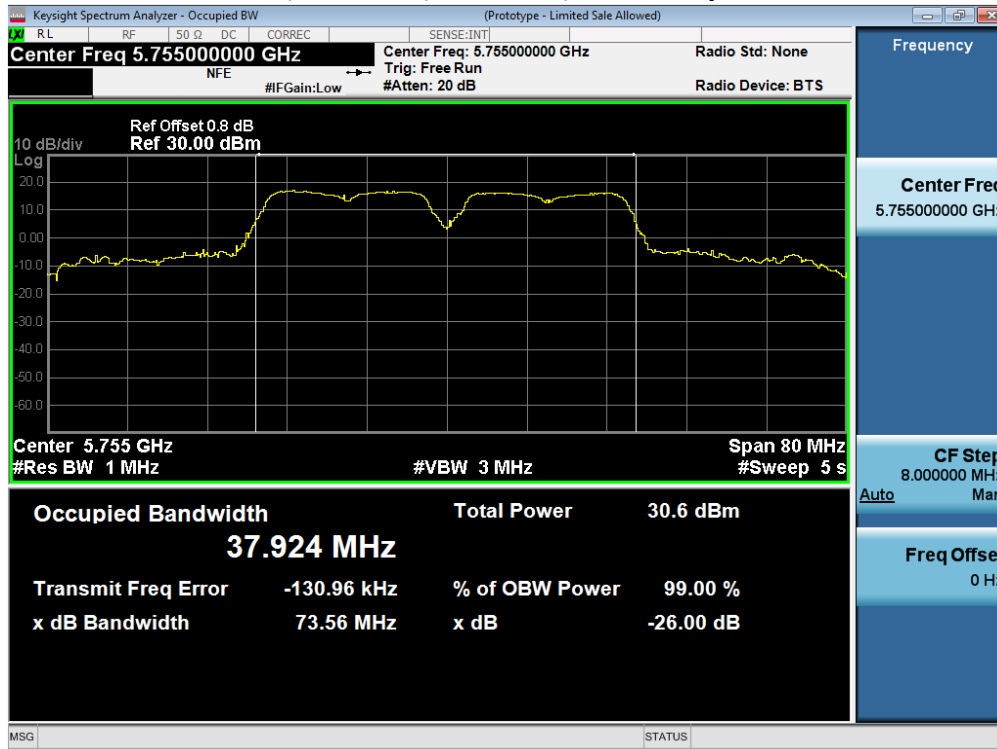

26dB / 99% Bandwidth, 5755 MHz, HT/VHT40, M0 to M15

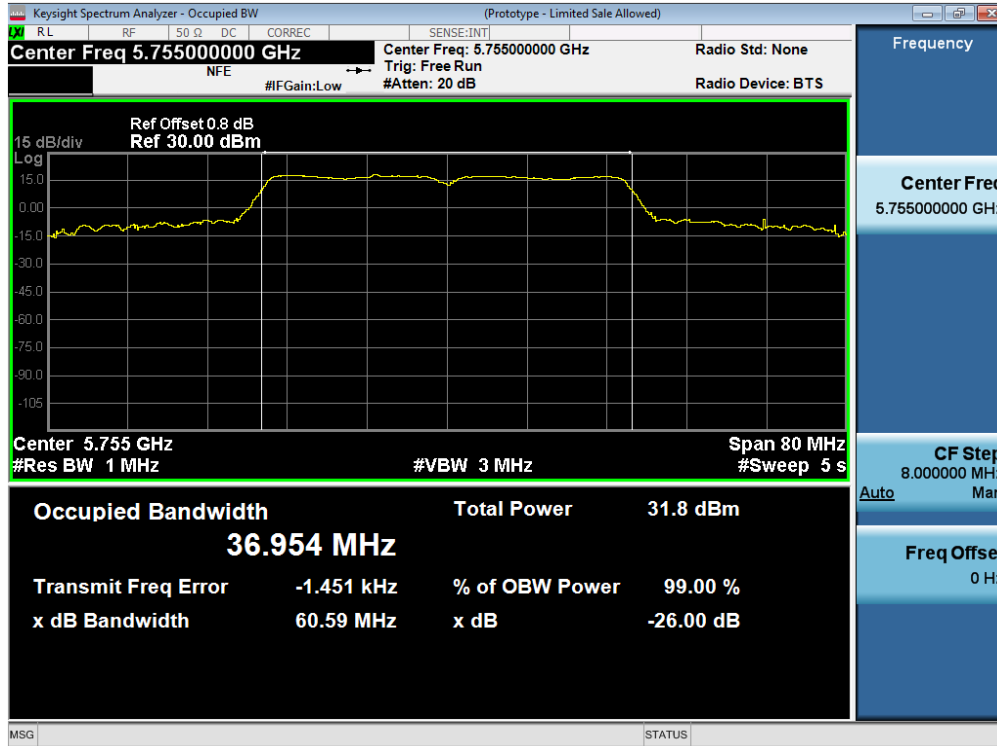



26dB / 99% Bandwidth, 5775 MHz, Non HT80, 6 to 54 Mbps

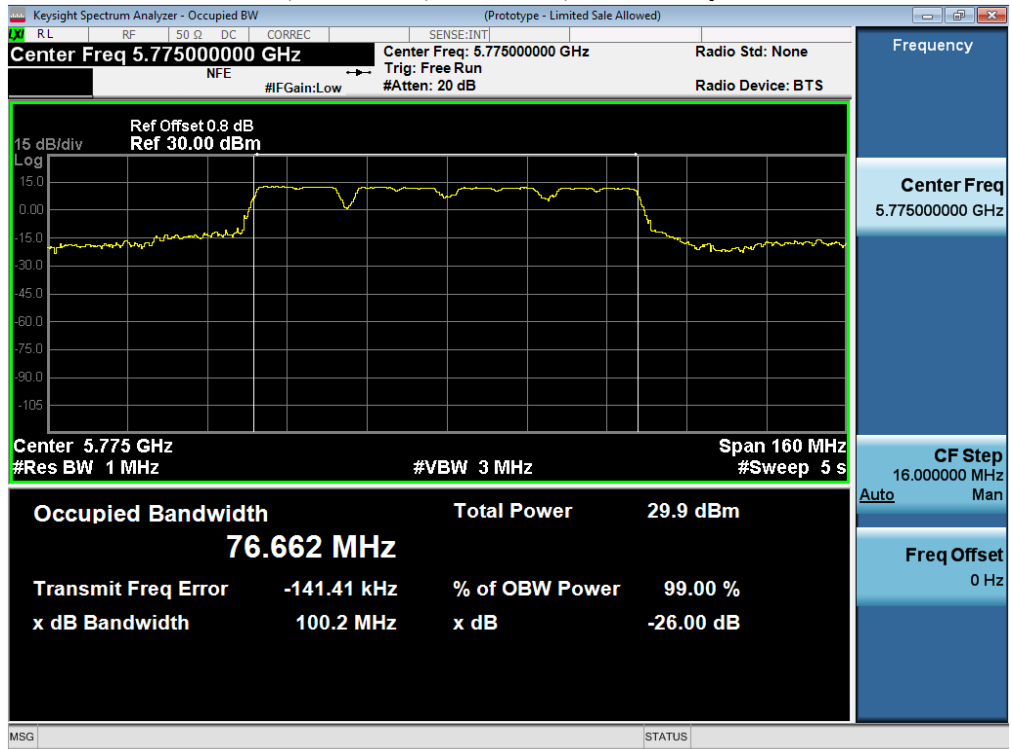

26dB / 99% Bandwidth, 5775 MHz, VHT80, M0 to M9, M0 to M9 1-1ss

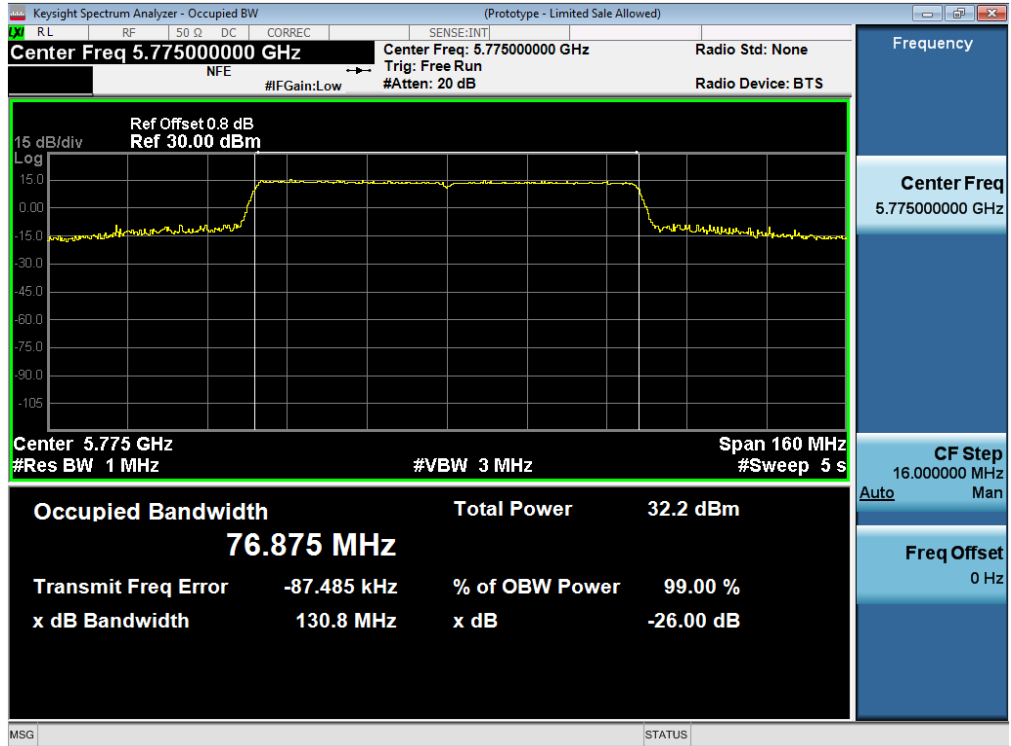



26dB / 99% Bandwidth, 5785 MHz, Non HT20, 6 to 54 Mbps

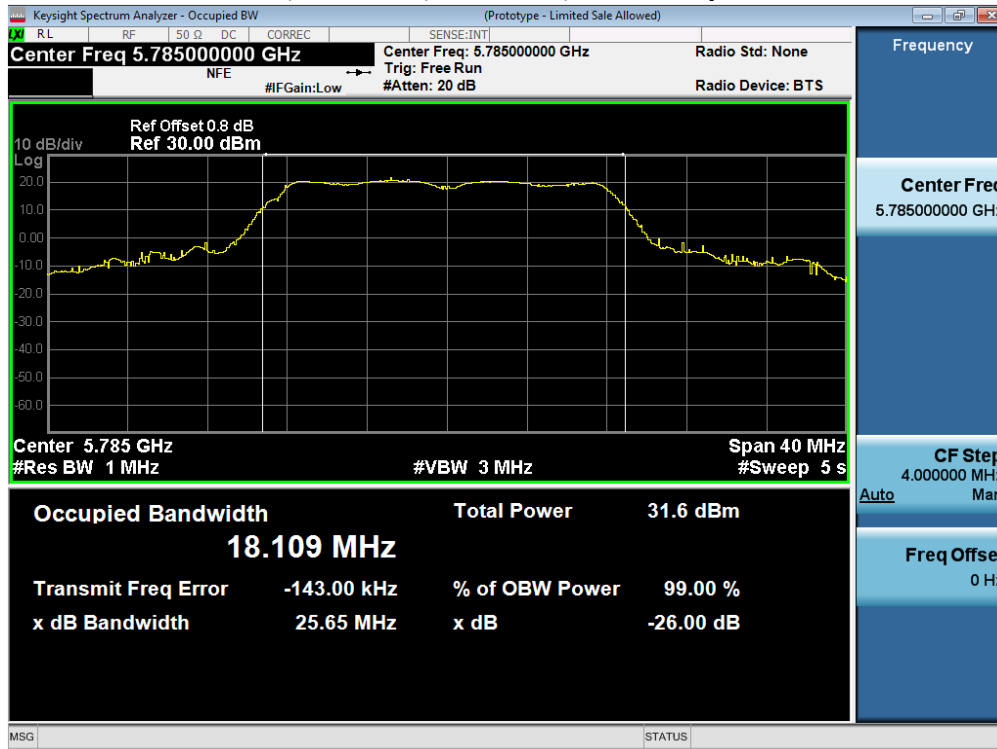

26dB / 99% Bandwidth, 5785 MHz, HT/VHT20, M0 to M15

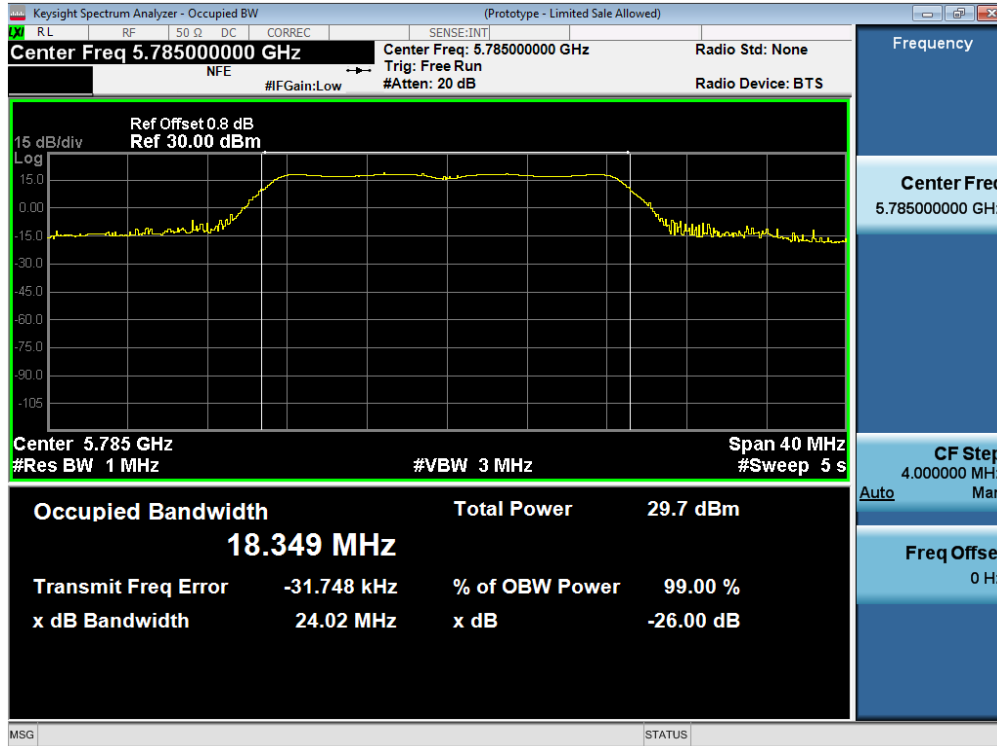



26dB / 99% Bandwidth, 5795 MHz, Non HT40, 6 to 54 Mbps

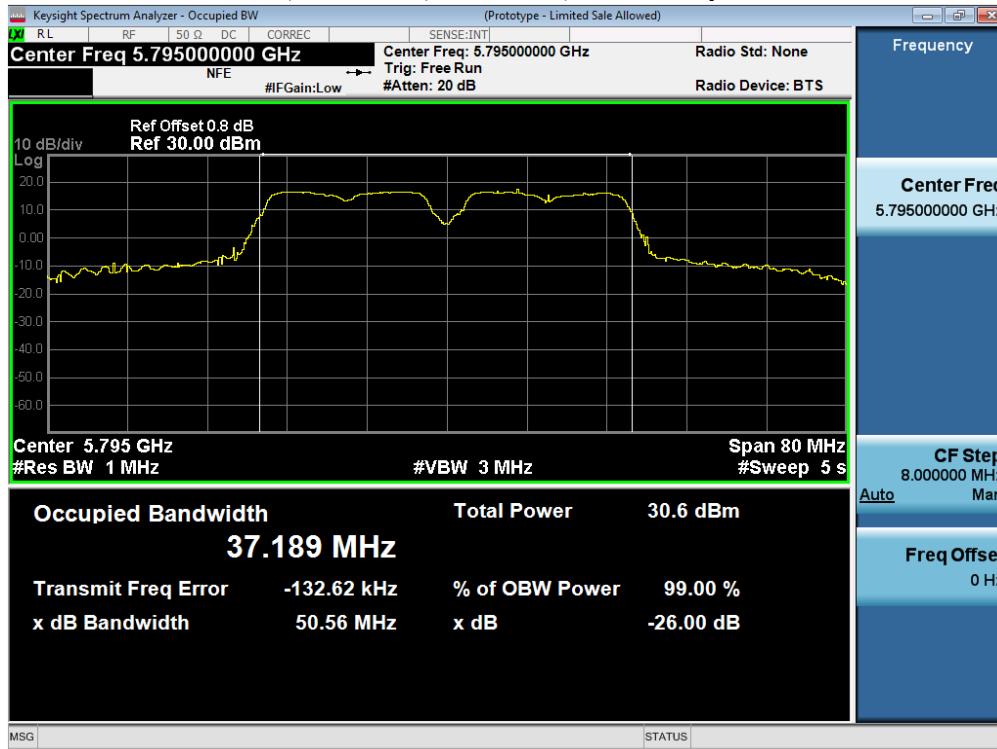

26dB / 99% Bandwidth, 5795 MHz, HT/VHT40, M0 to M15

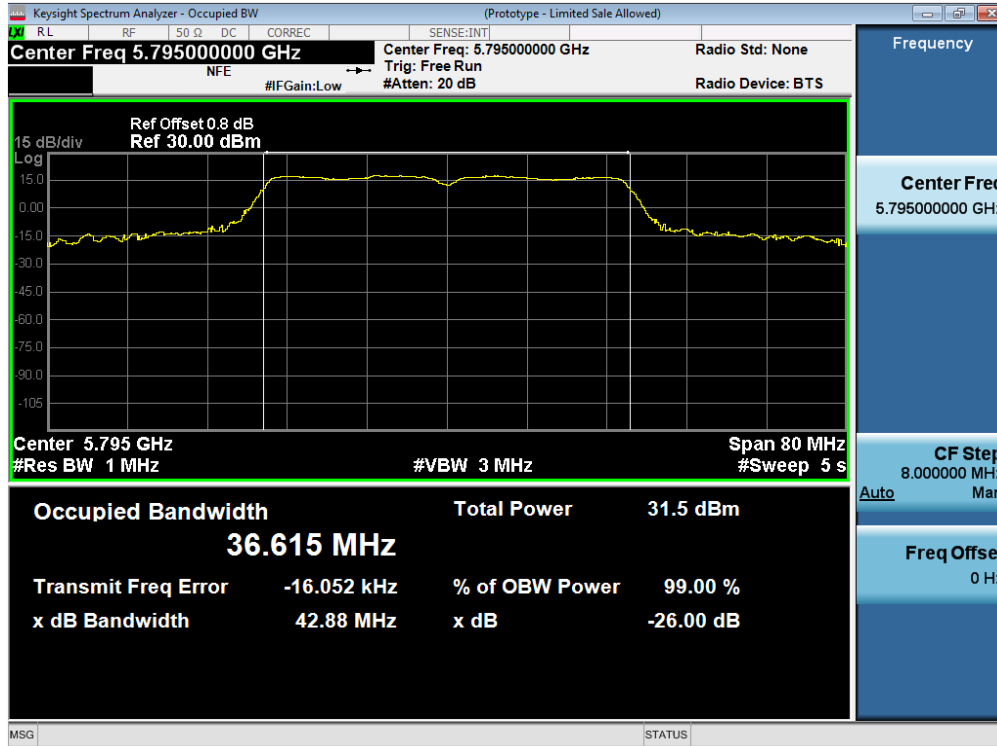

26dB / 99% Bandwidth, 5825 MHz, Non HT20, 6 to 54 Mbps

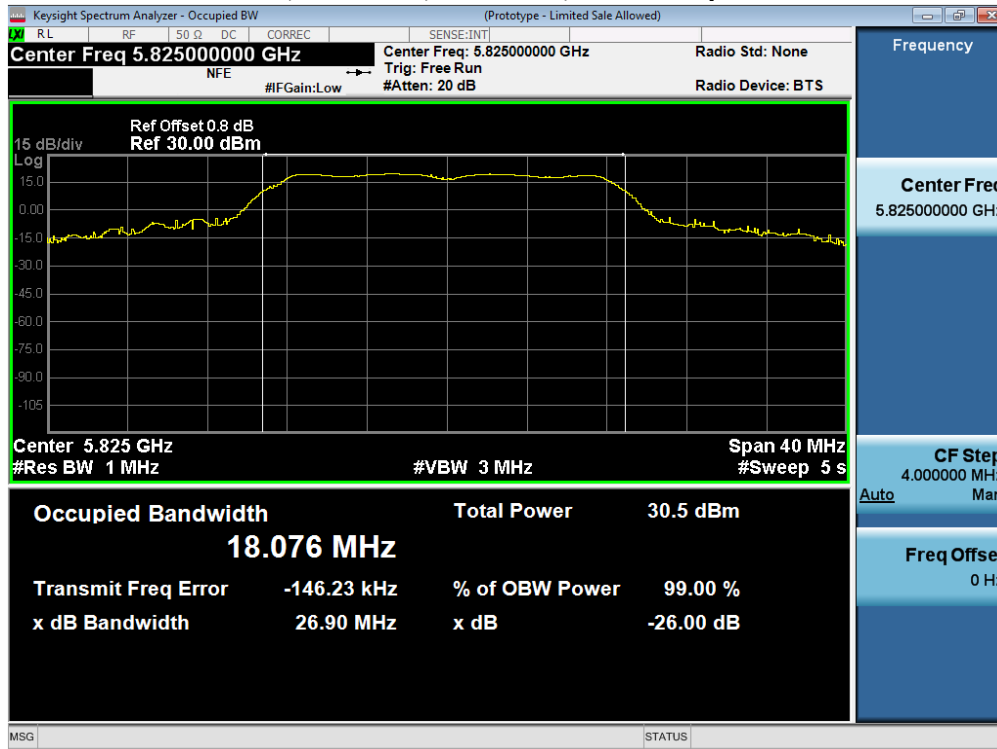

26dB / 99% Bandwidth, 5825 MHz, HT/VHT20, M0 to M15

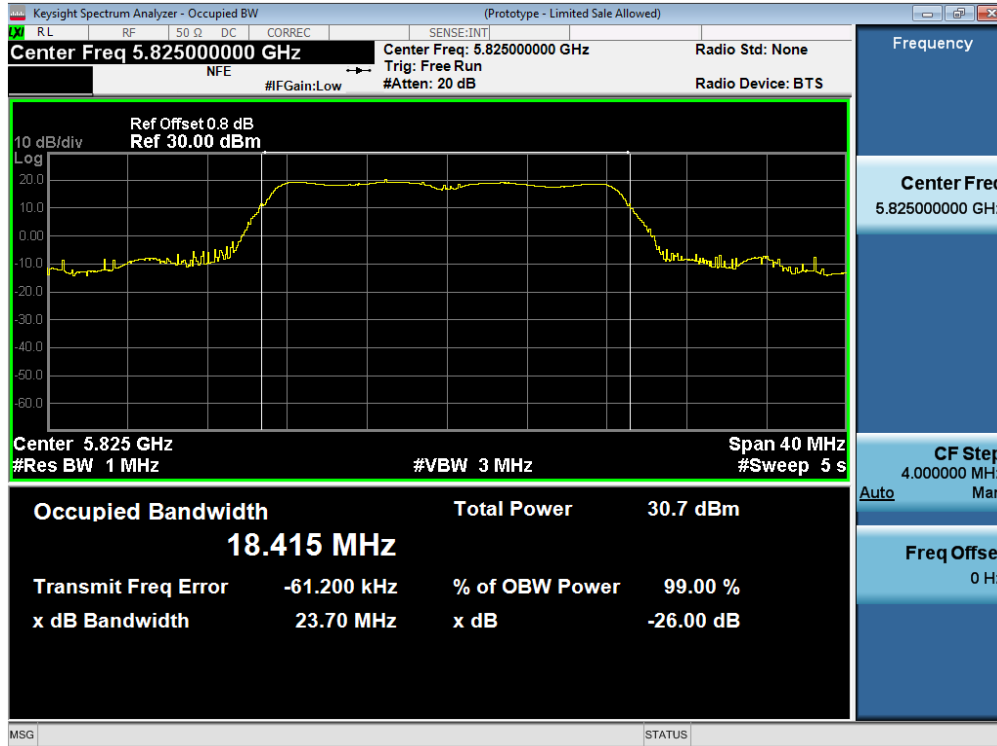

A.3 Maximum Conducted Output Power

15.407 / RSS-247 For the band 5.725-5.85 GHz, the maximum conducted output power over the frequency band of operation shall not exceed 1 W. If transmitting antennas of directional gain greater than 6 dBi are used, both the maximum conducted output power and the maximum power spectral density shall be reduced by the amount in dB that the directional gain of the antenna exceeds 6 dBi. However, fixed point-to-point U-NII devices operating in this band may employ transmitting antennas with directional gain greater than 6 dBi without any corresponding reduction in transmitter conducted power. Fixed, point-to-point operations exclude the use of point-to-multipoint systems, omnidirectional applications, and multiple collocated transmitters transmitting the same information. The operator of the U-NII device, or if the equipment is professionally installed, the installer, is responsible for ensuring that systems employing high gain directional antennas are used exclusively for fixed, point-to-point operations.

The peak correlated gain for each mode is listed in the table below. See the Theory of Operation for details on the correlated gain for each mode.

Test Procedure

Ref. KDB 789033 D02 General UNII Test Procedures New Rules v01r03
ANSI C63.10: 2013

Output Power Test Procedure
<ol style="list-style-type: none"> 1. Set the radio in the continuous transmitting mode at full power 2. Compute power by integrating the spectrum across the EBW (or alternatively entire 99% OBW) of the signal using the instrument's band power measurement function. The integration shall be performed using the spectrum analyzer band-power measurement function with band limits set equal to the EBW or the OBW band edges. 3. Capture graphs and record pertinent measurement data.

Ref. KDB 789033 D02 General UNII Test Procedures New Rules v01r03
ANSI C63.10: 2013 section 12.3.2.2 Method SA-1

Output Power Test parameters
Span = >1.5 times the OBW RBW = 1MHz VBW ≥ 3 x RBW Sweep = Auto couple Detector = sample Trace = Trace Average 100

The "measure-and-sum technique" is used for measuring in-band transmit power of a device. In the measure-and-sum approach, the conducted emission level is measured at each antenna port. The measured results at the various antenna ports are then summed mathematically to determine the total emission level from the device. Summing is performed in linear power units. (See ANSI C63.10 section 14.3.2.2)

System Number	Description	Samples	System under test	Support equipment
1	EUT	S01	<input checked="" type="checkbox"/>	<input type="checkbox"/>
	Support	S02	<input type="checkbox"/>	<input checked="" type="checkbox"/>

Tested By : Jose Aguirre	Date of testing: 20-April-16 - 08-Aug-16
Test Result : PASS	

See Appendix C for list of test equipment

Antenna Gain: 5 dBi

Frequency (MHz)	Mode	Tx Paths	Correlated Antenna Gain (dBi)	Tx 1 Max Power (dBm)	Tx 2 Max Power (dBm)	Total Tx Channel Power (dBm)	Limit (dBm)	Margin (dB)
5745	Non HT20, 6 to 54 Mbps	1	5	23.5		23.5	30.0	6.5
	Non HT20, 6 to 54 Mbps	2	5	23.5	24.1	26.8	30.0	3.2
	Non HT20 Beam Forming, 6 to 54 Mbps	2	8	23.5	24.1	26.8	28.0	1.2
	HT/VHT20, M0 to M7	1	5	24.1		24.1	30.0	5.9
	HT/VHT20, M0 to M7	2	5	19.8	20.4	23.1	30.0	6.9
	HT/VHT20, M8 to M15	2	5	19.8	20.4	23.1	30.0	6.9
	HT/VHT20 Beam Forming, M0 to M7	2	8	18.2	18.4	21.3	28.0	6.7
	HT/VHT20 Beam Forming, M8 to M15	2	5	19.8	20.4	23.1	30.0	6.9
	HT/VHT20 STBC, M0 to M7	2	5	19.8	20.4	23.1	30.0	6.9
5755	Non HT40, 6 to 54 Mbps	1	5	22.7		22.7	30.0	7.3
	Non HT40, 6 to 54 Mbps	2	5	22.7	23.1	25.9	30.0	4.1
	HT/VHT40, M0 to M7	1	5	23.7		23.7	30.0	6.3
	HT/VHT40, M0 to M7	2	5	19.8	20.2	23.0	30.0	7.0
	HT/VHT40, M8 to M15	2	5	19.8	20.2	23.0	30.0	7.0
	HT/VHT40 Beam Forming, M0 to M7	2	8	18.0	18.3	21.2	28.0	6.8
	HT/VHT40 Beam Forming, M8 to M15	2	5	19.8	20.2	23.0	30.0	7.0
	HT/VHT40 STBC, M0 to M7	2	5	19.8	20.2	23.0	30.0	7.0
5775	Non HT80, 6 to 54 Mbps	1	5	21.9		21.9	30.0	8.1
	Non HT80, 6 to 54 Mbps	2	5	14.1	15.0	17.6	30.0	12.4
	VHT80, M0 to M9 1ss	1	5	23.6		23.6	30.0	6.4
	VHT80, M0 to M9 1ss	2	5	23.6	24.1	26.9	30.0	3.1
	VHT80, M0 to M9 2ss	2	5	23.6	24.1	26.9	30.0	3.1
	VHT80 Beam Forming, M0 to M9 1ss	2	8	17.9	18.2	21.1	28.0	6.9
	VHT80 Beam Forming, M0 to M9 2ss	2	5	23.6	24.1	26.9	30.0	3.1
	VHT80 STBC, M0 to M9 1ss	2	5	23.6	24.1	26.9	30.0	3.1
5785	Non HT20, 6 to 54 Mbps	1	5	23.7		23.7	30.0	6.3
	Non HT20, 6 to 54 Mbps	2	5	23.7	22.4	26.1	30.0	3.9
	Non HT20 Beam Forming, 6 to 54 Mbps	2	8	16.6	14.8	18.8	28.0	9.2
	HT/VHT20, M0 to M7	1	5	21.7		21.7	30.0	8.3
	HT/VHT20, M0 to M7	2	5	18.0	18.8	21.4	30.0	8.6
	HT/VHT20, M8 to M15	2	5	18.0	18.8	21.4	30.0	8.6
	HT/VHT20 Beam Forming, M0 to M7	2	8	16.7	15.0	18.9	28.0	9.1

	HT/VHT20 Beam Forming, M8 to M15	2	5	18.0	18.8	21.4	30.0	8.6
	HT/VHT20 STBC, M0 to M7	2	5	18.0	18.8	21.4	30.0	8.6
5795	Non HT40, 6 to 54 Mbps	1	5	22.7		22.7	30.0	7.3
	Non HT40, 6 to 54 Mbps	2	5	18.3	17.3	20.8	30.0	9.2
	HT/VHT40, M0 to M7	1	5	23.4		23.4	30.0	6.6
	HT/VHT40, M0 to M7	2	5	18.0	18.5	21.3	30.0	8.7
	HT/VHT40, M8 to M15	2	5	18.0	18.5	21.3	30.0	8.7
	HT/VHT40 Beam Forming, M0 to M7	2	8	16.2	15.1	18.7	28.0	9.3
	HT/VHT40 Beam Forming, M8 to M15	2	5	18.0	18.5	21.3	30.0	8.7
	HT/VHT40 STBC, M0 to M7	2	5	18.0	18.5	21.3	30.0	8.7
5825	Non HT20, 6 to 54 Mbps	1	5	22.6		22.6	30.0	7.4
	Non HT20, 6 to 54 Mbps	2	5	18.8	18.3	21.6	30.0	8.4
	Non HT20 Beam Forming, 6 to 54 Mbps	2	8	15.9	14.9	18.4	28.0	9.6
	HT/VHT20, M0 to M7	1	5	22.6		22.6	30.0	7.4
	HT/VHT20, M0 to M7	2	5	18.9	18.4	21.7	30.0	8.3
	HT/VHT20, M8 to M15	2	5	18.9	18.4	21.7	30.0	8.3
	HT/VHT20 Beam Forming, M0 to M7	2	8	15.9	14.9	18.4	28.0	9.6
	HT/VHT20 Beam Forming, M8 to M15	2	5	18.9	18.4	21.7	30.0	8.3
	HT/VHT20 STBC, M0 to M7	2	5	18.9	18.4	21.7	30.0	8.3

Peak Output Power, 5745 MHz, Non HT20 Beam Forming, 6 to 54 Mbps



Antenna A



Antenna B

Antenna Gain: 7 dBi

Frequency (MHz)	Mode	Tx Paths	Correlated Antenna Gain (dBi)	Tx 1 Max Power (dBm)	Tx 2 Max Power (dBm)	Total Tx Channel Power (dBm)	Limit (dBm)	Margin (dB)
5745	Non HT20, 6 to 54 Mbps	1	7	23.5		23.5	29.0	5.5
	Non HT20, 6 to 54 Mbps	2	7	23.5	24.1	26.8	29.0	2.2
	Non HT20 Beam Forming, 6 to 54 Mbps	2	10	24.0	21.6	26.0	26.0	0.0
	HT/VHT20, M0 to M7	1	7	24.1		24.1	29.0	4.9
	HT/VHT20, M0 to M7	2	7	18.2	18.4	21.3	29.0	7.7
	HT/VHT20, M8 to M15	2	7	18.2	18.4	21.3	29.0	7.7
	HT/VHT20 Beam Forming, M0 to M7	2	10	15.2	15.7	18.5	26.0	7.5
	HT/VHT20 Beam Forming, M8 to M15	2	7	18.2	18.4	21.3	29.0	7.7
	HT/VHT20 STBC, M0 to M7	2	7	18.2	18.4	21.3	29.0	7.7
5755	Non HT40, 6 to 54 Mbps	1	7	22.7		22.7	29.0	6.3
	Non HT40, 6 to 54 Mbps	2	7	17.9	19.4	21.7	29.0	7.3
	HT/VHT40, M0 to M7	1	7	23.7		23.7	29.0	5.3
	HT/VHT40, M0 to M7	2	7	19.8	20.2	23.0	29.0	6.0
	HT/VHT40, M8 to M15	2	7	19.8	20.2	23.0	29.0	6.0
	HT/VHT40 Beam Forming, M0 to M7	2	10	15.2	15.5	18.4	26.0	7.6
	HT/VHT40 Beam Forming, M8 to M15	2	7	19.8	20.2	23.0	29.0	6.0
	HT/VHT40 STBC, M0 to M7	2	7	19.8	20.2	23.0	29.0	6.0
5775	Non HT80, 6 to 54 Mbps	1	7	21.2		21.2	29.0	7.8
	Non HT80, 6 to 54 Mbps	2	7	14.1	15.0	17.6	29.0	11.4
	VHT80, M0 to M9 1ss	1	7	23.6		23.6	29.0	5.4
	VHT80, M0 to M9 1ss	2	7	17.9	18.2	21.1	29.0	7.9
	VHT80, M0 to M9 2ss	2	7	17.9	18.2	21.1	29.0	7.9
	VHT80 Beam Forming, M0 to M9 1ss	2	10	16.8	15.9	19.4	26.0	6.6
	VHT80 Beam Forming, M0 to M9 2ss	2	7	17.9	18.2	21.1	29.0	7.9
	VHT80 STBC, M0 to M9 1ss	2	7	17.9	18.2	21.1	29.0	7.9
5785	Non HT20, 6 to 54 Mbps	1	7	23.7		23.7	29.0	5.3
	Non HT20, 6 to 54 Mbps	2	7	15.8	17.1	19.5	29.0	9.5
	Non HT20 Beam Forming, 6 to 54 Mbps	2	10	13.0	11.9	15.5	26.0	10.5
	HT/VHT20, M0 to M7	1	7	19.8		19.8	29.0	9.2
	HT/VHT20, M0 to M7	2	7	16.0	17.3	19.7	29.0	9.3
	HT/VHT20, M8 to M15	2	7	16.0	17.3	19.7	29.0	9.3
	HT/VHT20 Beam Forming, M0 to M7	2	10	13.2	12.0	15.7	26.0	10.3



	HT/VHT20 Beam Forming, M8 to M15	2	7	16.0	17.3	19.7	29.0	9.3
	HT/VHT20 STBC, M0 to M7	2	7	16.0	17.3	19.7	29.0	9.3
5795	Non HT40, 6 to 54 Mbps	1	7	22.7		22.7	29.0	6.3
	Non HT40, 6 to 54 Mbps	2	7	15.4	14.5	18.0	29.0	11.0
	HT/VHT40, M0 to M7	1	7	23.4		23.4	29.0	5.6
	HT/VHT40, M0 to M7	2	7	16.0	15.9	19.0	29.0	10.0
	HT/VHT40, M8 to M15	2	7	16.0	15.9	19.0	29.0	10.0
	HT/VHT40 Beam Forming, M0 to M7	2	10	12.6	11.9	15.3	26.0	10.7
	HT/VHT40 Beam Forming, M8 to M15	2	7	16.0	15.9	19.0	29.0	10.0
	HT/VHT40 STBC, M0 to M7	2	7	16.0	15.9	19.0	29.0	10.0
5825	Non HT20, 6 to 54 Mbps	1	7	22.6		22.6	29.0	6.4
	Non HT20, 6 to 54 Mbps	2	7	15.9	14.9	18.4	29.0	10.6
	Non HT20 Beam Forming, 6 to 54 Mbps	2	10	12.4	12.0	15.2	26.0	10.8
	HT/VHT20, M0 to M7	1	7	22.6		22.6	29.0	6.4
	HT/VHT20, M0 to M7	2	7	15.9	14.9	18.4	29.0	10.6
	HT/VHT20, M8 to M15	2	7	15.9	14.9	18.4	29.0	10.6
	HT/VHT20 Beam Forming, M0 to M7	2	10	12.5	12.1	15.3	26.0	10.7
	HT/VHT20 Beam Forming, M8 to M15	2	7	15.9	14.9	18.4	29.0	10.6
	HT/VHT20 STBC, M0 to M7	2	7	15.9	14.9	18.4	29.0	10.6

Peak Output Power, 5745 MHz, Non HT20 Beam Forming, 6 to 54 Mbps



Antenna A



Antenna B

Antenna Gain: 8 dBi

Frequency (MHz)	Mode	Tx Paths	Correlated Antenna Gain (dBi)	Tx 1 Max Power (dBm)	Tx 2 Max Power (dBm)	Total Tx Channel Power (dBm)	Limit (dBm)	Margin (dB)
5745	Non HT20, 6 to 54 Mbps	1	8	23.5		23.5	28.0	4.5
	Non HT20, 6 to 54 Mbps	2	8	23.5	24.1	26.8	28.0	1.2
	Non HT20 Beam Forming, 6 to 54 Mbps	2	11	21.2	21.9	24.6	25.0	0.4
	HT/VHT20, M0 to M7	1	8	24.1		24.1	28.0	3.9
	HT/VHT20, M0 to M7	2	8	18.2	18.4	21.3	28.0	6.7
	HT/VHT20, M8 to M15	2	8	18.2	18.4	21.3	28.0	6.7
	HT/VHT20 Beam Forming, M0 to M7	2	11	16.2	16.9	19.6	25.0	5.4
	HT/VHT20 Beam Forming, M8 to M15	2	8	18.2	18.4	21.3	28.0	6.7
	HT/VHT20 STBC, M0 to M7	2	8	18.2	18.4	21.3	28.0	6.7
5755	Non HT40, 6 to 54 Mbps	1	8	22.7		22.7	28.0	5.3
	Non HT40, 6 to 54 Mbps	2	8	16.0	16.8	19.4	28.0	8.6
	HT/VHT40, M0 to M7	1	8	23.7		23.7	28.0	4.3
	HT/VHT40, M0 to M7	2	8	18.0	18.3	21.2	28.0	6.8
	HT/VHT40, M8 to M15	2	8	18.0	18.3	21.2	28.0	6.8
	HT/VHT40 Beam Forming, M0 to M7	2	11	14.2	14.3	17.3	25.0	7.7
	HT/VHT40 Beam Forming, M8 to M15	2	8	18.0	18.3	21.2	28.0	6.8
	HT/VHT40 STBC, M0 to M7	2	8	18.0	18.3	21.2	28.0	6.8
5775	Non HT80, 6 to 54 Mbps	1	8	21.2		21.2	28.0	6.8
	Non HT80, 6 to 54 Mbps	2	8	14.1	15.0	17.6	28.0	10.4
	VHT80, M0 to M9 1ss	1	8	23.6		23.6	28.0	4.4
	VHT80, M0 to M9 1ss	2	8	17.9	18.2	21.1	28.0	6.9
	VHT80, M0 to M9 2ss	2	8	17.9	18.2	21.1	28.0	6.9
	VHT80 Beam Forming, M0 to M9 1ss	2	11	15.8	14.9	18.4	25.0	6.6
	VHT80 Beam Forming, M0 to M9 2ss	2	8	17.9	18.2	21.1	28.0	6.9
	VHT80 STBC, M0 to M9 1ss	2	8	17.9	18.2	21.1	28.0	6.9
5785	Non HT20, 6 to 54 Mbps	1	8	23.7		23.7	28.0	4.3
	Non HT20, 6 to 54 Mbps	2	8	16.6	14.8	18.8	28.0	9.2
	Non HT20 Beam Forming, 6 to 54 Mbps	2	11	11.9	12.8	15.4	25.0	9.6
	HT/VHT20, M0 to M7	1	8	18.0		18.0	28.0	10.0
	HT/VHT20, M0 to M7	2	8	16.7	15.0	18.9	28.0	9.1
	HT/VHT20, M8 to M15	2	8	16.7	15.0	18.9	28.0	9.1
	HT/VHT20 Beam Forming, M0 to M7	2	11	12.0	12.9	15.5	25.0	9.5

	HT/VHT20 Beam Forming, M8 to M15	2	8	16.7	15.0	18.9	28.0	9.1
	HT/VHT20 STBC, M0 to M7	2	8	16.7	15.0	18.9	28.0	9.1
5795	Non HT40, 6 to 54 Mbps	1	8	17.9		17.9	28.0	10.1
	Non HT40, 6 to 54 Mbps	2	8	14.7	14.2	17.5	28.0	10.5
	HT/VHT40, M0 to M7	1	8	23.4		23.4	28.0	4.6
	HT/VHT40, M0 to M7	2	8	16.2	15.1	18.7	28.0	9.3
	HT/VHT40, M8 to M15	2	8	16.2	15.1	18.7	28.0	9.3
	HT/VHT40 Beam Forming, M0 to M7	2	11	11.9	12.7	15.3	25.0	9.7
	HT/VHT40 Beam Forming, M8 to M15	2	8	16.2	15.1	18.7	28.0	9.3
	HT/VHT40 STBC, M0 to M7	2	8	16.2	15.1	18.7	28.0	9.3
5825	Non HT20, 6 to 54 Mbps	1	8	22.6		22.6	28.0	5.4
	Non HT20, 6 to 54 Mbps	2	8	15.9	14.9	18.4	28.0	9.6
	Non HT20 Beam Forming, 6 to 54 Mbps	2	11	11.5	10.9	14.2	25.0	10.8
	HT/VHT20, M0 to M7	1	8	22.6		22.6	28.0	5.4
	HT/VHT20, M0 to M7	2	8	15.9	14.9	18.4	28.0	9.6
	HT/VHT20, M8 to M15	2	8	15.9	14.9	18.4	28.0	9.6
	HT/VHT20 Beam Forming, M0 to M7	2	11	11.6	11.0	14.3	25.0	10.7
	HT/VHT20 Beam Forming, M8 to M15	2	8	15.9	14.9	18.4	28.0	9.6
	HT/VHT20 STBC, M0 to M7	2	8	15.9	14.9	18.4	28.0	9.6

Peak Output Power, 5745 MHz, Non HT20 Beam Forming, 6 to 54 Mbps



Antenna A



Antenna B

Antenna Gain: 13 dBi

Frequency (MHz)	Mode	Tx Paths	Correlated Antenna Gain (dBi)	Tx 1 Max Power (dBm)	Tx 2 Max Power (dBm)	Total Tx Channel Power (dBm)	Limit (dBm)	Margin (dB)
5745	Non HT20, 6 to 54 Mbps	1	13	23.5		23.5	30.0	6.5
	Non HT20, 6 to 54 Mbps	2	13	23.5	24.1	26.8	30.0	3.2
	Non HT20 Beam Forming, 6 to 54 Mbps	2	13	23.5	24.1	26.8	30.0	3.2
	HT/VHT20, M0 to M7	1	13	21.8		21.8	30.0	8.2
	HT/VHT20, M0 to M7	2	13	12.3	12.4	15.4	30.0	14.6
	HT/VHT20, M8 to M15	2	13	12.3	12.4	15.4	30.0	14.6
	HT/VHT20 Beam Forming, M0 to M7	2	13	12.3	12.4	15.4	30.0	14.6
	HT/VHT20 Beam Forming, M8 to M15	2	13	12.3	12.4	15.4	30.0	14.6
	HT/VHT20 STBC, M0 to M7	2	13	12.3	12.4	15.4	30.0	14.6
5755	Non HT40, 6 to 54 Mbps	1	13	20.8		20.8	30.0	9.2
	Non HT40, 6 to 54 Mbps	2	13	16.0	16.8	19.4	30.0	10.6
	HT/VHT40, M0 to M7	1	13	21.6		21.6	30.0	8.4
	HT/VHT40, M0 to M7	2	13	13.2	13.9	16.6	30.0	13.4
	HT/VHT40, M8 to M15	2	13	13.2	13.9	16.6	30.0	13.4
	HT/VHT40 Beam Forming, M0 to M7	2	13	13.2	13.9	16.6	30.0	13.4
	HT/VHT40 Beam Forming, M8 to M15	2	13	13.2	13.9	16.6	30.0	13.4
	HT/VHT40 STBC, M0 to M7	2	13	13.2	13.9	16.6	30.0	13.4
5775	Non HT80, 6 to 54 Mbps	1	13	14.1		14.1	30.0	15.9
	Non HT80, 6 to 54 Mbps	2	13	14.1	15.0	17.6	30.0	12.4
	VHT80, M0 to M9 1ss	1	13	21.5		21.5	30.0	8.5
	VHT80, M0 to M9 1ss	2	13	13.2	13.0	16.1	30.0	13.9
	VHT80, M0 to M9 2ss	2	13	13.2	13.0	16.1	30.0	13.9
	VHT80 Beam Forming, M0 to M9 1ss	2	13	13.2	13.0	16.1	30.0	13.9
	VHT80 Beam Forming, M0 to M9 2ss	2	13	13.2	13.0	16.1	30.0	13.9
	VHT80 STBC, M0 to M9 1ss	2	13	13.2	13.0	16.1	30.0	13.9
5785	Non HT20, 6 to 54 Mbps	1	13	11.9		11.9	30.0	18.1
	Non HT20, 6 to 54 Mbps	2	13	10.0	10.8	13.4	30.0	16.6
	Non HT20 Beam Forming, 6 to 54 Mbps	2	13	10.0	10.8	13.4	30.0	16.6
	HT/VHT20, M0 to M7	1	13	12.0		12.0	30.0	18.0
	HT/VHT20, M0 to M7	2	13	10.1	10.9	13.5	30.0	16.5
	HT/VHT20, M8 to M15	2	13	10.1	10.9	13.5	30.0	16.5
	HT/VHT20 Beam Forming, M0 to M7	2	13	10.1	10.9	13.5	30.0	16.5

	HT/VHT20 Beam Forming, M8 to M15	2	13	10.1	10.9	13.5	30.0	16.5
	HT/VHT20 STBC, M0 to M7	2	13	10.1	10.9	13.5	30.0	16.5
5795	Non HT40, 6 to 54 Mbps	1	13	12.8		12.8	30.0	17.2
	Non HT40, 6 to 54 Mbps	2	13	8.9	7.9	11.4	30.0	18.6
	HT/VHT40, M0 to M7	1	13	13.7		13.7	30.0	16.3
	HT/VHT40, M0 to M7	2	13	10.0	10.6	13.3	30.0	16.7
	HT/VHT40, M8 to M15	2	13	10.0	10.6	13.3	30.0	16.7
	HT/VHT40 Beam Forming, M0 to M7	2	13	10.0	10.6	13.3	30.0	16.7
	HT/VHT40 Beam Forming, M8 to M15	2	13	10.0	10.6	13.3	30.0	16.7
	HT/VHT40 STBC, M0 to M7	2	13	10.0	10.6	13.3	30.0	16.7
5825	Non HT20, 6 to 54 Mbps	1	13	13.3		13.3	30.0	16.7
	Non HT20, 6 to 54 Mbps	2	13	10.0	10.1	13.1	30.0	16.9
	Non HT20 Beam Forming, 6 to 54 Mbps	2	13	10.0	10.1	13.1	30.0	16.9
	HT/VHT20, M0 to M7	1	13	13.4		13.4	30.0	16.6
	HT/VHT20, M0 to M7	2	13	10.1	10.2	13.2	30.0	16.8
	HT/VHT20, M8 to M15	2	13	10.1	10.2	13.2	30.0	16.8
	HT/VHT20 Beam Forming, M0 to M7	2	13	10.1	10.2	13.2	30.0	16.8
	HT/VHT20 Beam Forming, M8 to M15	2	13	10.1	10.2	13.2	30.0	16.8
	HT/VHT20 STBC, M0 to M7	2	13	10.1	10.2	13.2	30.0	16.8

Peak Output Power, 5745 MHz, Non HT20, 6 to 54 Mbps



Antenna A



Antenna B

Antenna Gain: 14 dBi

Frequency (MHz)	Mode	Tx Paths	Correlated Antenna Gain (dBi)	Tx 1 Max Power (dBm)	Tx 2 Max Power (dBm)	Total Tx Channel Power (dBm)	Limit (dBm)	Margin (dB)
5745	Non HT20, 6 to 54 Mbps	1	14	23.5		23.5	30.0	6.5
	Non HT20, 6 to 54 Mbps	2	14	23.5	24.1	26.8	30.0	3.2
	Non HT20 Beam Forming, 6 to 54 Mbps	2	14	23.5	24.1	26.8	30.0	3.2
	HT/VHT20, M0 to M7	1	14	21.8		21.8	30.0	8.2
	HT/VHT20, M0 to M7	2	14	12.3	12.4	15.4	30.0	14.6
	HT/VHT20, M8 to M15	2	14	12.3	12.4	15.4	30.0	14.6
	HT/VHT20 Beam Forming, M0 to M7	2	14	12.3	12.4	15.4	30.0	14.6
	HT/VHT20 Beam Forming, M8 to M15	2	14	12.3	12.4	15.4	30.0	14.6
	HT/VHT20 STBC, M0 to M7	2	14	12.3	12.4	15.4	30.0	14.6
5755	Non HT40, 6 to 54 Mbps	1	14	20.8		20.8	30.0	9.2
	Non HT40, 6 to 54 Mbps	2	14	16.0	16.8	19.4	30.0	10.6
	HT/VHT40, M0 to M7	1	14	21.6		21.6	30.0	8.4
	HT/VHT40, M0 to M7	2	14	12.0	12.3	15.2	30.0	14.8
	HT/VHT40, M8 to M15	2	14	12.0	12.3	15.2	30.0	14.8
	HT/VHT40 Beam Forming, M0 to M7	2	14	12.0	12.3	15.2	30.0	14.8
	HT/VHT40 Beam Forming, M8 to M15	2	14	12.0	12.3	15.2	30.0	14.8
	HT/VHT40 STBC, M0 to M7	2	14	12.0	12.3	15.2	30.0	14.8
5775	Non HT80, 6 to 54 Mbps	1	14	14.1		14.1	30.0	15.9
	Non HT80, 6 to 54 Mbps	2	14	14.1	15.0	17.6	30.0	12.4
	VHT80, M0 to M9 1ss	1	14	21.5		21.5	30.0	8.5
	VHT80, M0 to M9 1ss	2	14	11.8	12.3	15.1	30.0	14.9
	VHT80, M0 to M9 2ss	2	14	11.8	12.3	15.1	30.0	14.9
	VHT80 Beam Forming, M0 to M9 1ss	2	14	11.8	12.3	15.1	30.0	14.9
	VHT80 Beam Forming, M0 to M9 2ss	2	14	11.8	12.3	15.1	30.0	14.9
	VHT80 STBC, M0 to M9 1ss	2	14	11.8	12.3	15.1	30.0	14.9
5785	Non HT20, 6 to 54 Mbps	1	14	11.9		11.9	30.0	18.1
	Non HT20, 6 to 54 Mbps	2	14	10.0	10.8	13.4	30.0	16.6
	Non HT20 Beam Forming, 6 to 54 Mbps	2	14	10.0	10.8	13.4	30.0	16.6
	HT/VHT20, M0 to M7	1	14	12.0		12.0	30.0	18.0
	HT/VHT20, M0 to M7	2	14	10.3	9.2	12.8	30.0	17.2
	HT/VHT20, M8 to M15	2	14	10.3	9.2	12.8	30.0	17.2
	HT/VHT20 Beam Forming, M0 to M7	2	14	10.3	9.2	12.8	30.0	17.2



	HT/VHT20 Beam Forming, M8 to M15	2	14	10.3	9.2	12.8	30.0	17.2
	HT/VHT20 STBC, M0 to M7	2	14	10.3	9.2	12.8	30.0	17.2
5795	Non HT40, 6 to 54 Mbps	1	14	9.4		9.4	30.0	20.6
	Non HT40, 6 to 54 Mbps	2	14	8.9	7.9	11.4	30.0	18.6
	HT/VHT40, M0 to M7	1	14	11.9		11.9	30.0	18.1
	HT/VHT40, M0 to M7	2	14	9.7	8.8	12.3	30.0	17.7
	HT/VHT40, M8 to M15	2	14	9.7	8.8	12.3	30.0	17.7
	HT/VHT40 Beam Forming, M0 to M7	2	14	9.7	8.8	12.3	30.0	17.7
	HT/VHT40 Beam Forming, M8 to M15	2	14	9.7	8.8	12.3	30.0	17.7
	HT/VHT40 STBC, M0 to M7	2	14	9.7	8.8	12.3	30.0	17.7
5825	Non HT20, 6 to 54 Mbps	1	14	11.5		11.5	30.0	18.5
	Non HT20, 6 to 54 Mbps	2	14	9.5	9.1	12.3	30.0	17.7
	Non HT20 Beam Forming, 6 to 54 Mbps	2	14	9.5	9.1	12.3	30.0	17.7
	HT/VHT20, M0 to M7	1	14	11.6		11.6	30.0	18.4
	HT/VHT20, M0 to M7	2	14	9.5	9.1	12.3	30.0	17.7
	HT/VHT20, M8 to M15	2	14	9.5	9.1	12.3	30.0	17.7
	HT/VHT20 Beam Forming, M0 to M7	2	14	9.5	9.1	12.3	30.0	17.7
	HT/VHT20 Beam Forming, M8 to M15	2	14	9.5	9.1	12.3	30.0	17.7
	HT/VHT20 STBC, M0 to M7	2	14	9.5	9.1	12.3	30.0	17.7

Peak Output Power, 5745 MHz, Non HT20, 6 to 54 Mbps



Antenna A



Antenna B

A.4 Power Spectral Density

15.407 / RSS-247 The power spectral density shall not exceed 30 dBm in any 500 kHz band. If transmitting antennas of directional gain greater than 6 dBi are used, both the maximum conducted output power and the power spectral density shall be reduced by the amount in dB that the directional gain of the antenna exceeds 6 dBi.

Test Procedure

Ref. KDB 789033 D02 General UNII Test Procedures New Rules v01r03

Power Spectral Density Test Procedure
<ol style="list-style-type: none"> 1. Connect the antenna port(s) to the spectrum analyzer input. 2. Set the radio in the continuous transmitting mode at full power 3. Configure Spectrum analyzer as per test parameters below and Peak search marker 4. Capture graphs and record pertinent measurement data.

Ref. KDB 789033 D02 v01r03 section F.5

Power Spectral Density Test parameters
Span = >1.5 times the OBW RBW = 500 kHz. VBW ≥ 3 x RBW Sweep = 10s Detector = Peak Trace = Single Sweep Marker = Peak Search

The "Measure and add 10 log(N) dB technique", where N is the number of outputs, is used for measuring in-band Power Spectral Density. With this technique, spectrum measurements are performed at each output of the device, and the quantity 10 log(4) (or 6dB) is added to the worst case spectrum value before comparing to the emission limit. (ANSI C63.10 2013 section 14.3.2.3)

System Number	Description	Samples	System under test	Support equipment
1	EUT	S01	<input checked="" type="checkbox"/>	<input type="checkbox"/>
	Support	S02	<input type="checkbox"/>	<input checked="" type="checkbox"/>

Tested By : Jose Aguirre	Date of testing: 20-April-16 - 08-Aug-16
Test Result : PASS	

See Appendix C for list of test equipment



Antenna Gain: 5 dBi

Frequency (MHz)	Mode	Tx Paths	Correlated Antenna Gain (dBi)	Tx 1 PSD (dBm/MHz)	Tx 2 PSD (dBm/MHz)	Total PSD (dBm/500MHz)	Limit (dBm/500MHz)	Margin (dB)
5745	Non HT20, 6 to 54 Mbps	1	5	10.1		10.1	30.0	19.9
	Non HT20, 6 to 54 Mbps	2	8	10.1	10.3	13.2	28.0	14.8
	Non HT20 Beam Forming, 6 to 54 Mbps	2	8	10.1	10.3	13.2	28.0	14.8
	HT/VHT20, M0 to M7	1	5	10.6		10.6	30.0	19.4
	HT/VHT20, M0 to M7	2	8	5.9	6.8	9.4	28.0	18.6
	HT/VHT20, M8 to M15	2	5	5.9	6.8	9.4	30.0	20.6
	HT/VHT20 Beam Forming, M0 to M7	2	8	4.8	4.5	7.7	28.0	20.3
	HT/VHT20 Beam Forming, M8 to M15	2	5	5.9	6.8	9.4	30.0	20.6
	HT/VHT20 STBC, M0 to M7	2	5	5.9	6.8	9.4	30.0	20.6
5755	Non HT40, 6 to 54 Mbps	1	5	6.5		6.5	30.0	23.5
	Non HT40, 6 to 54 Mbps	2	8	6.5	6.6	9.6	28.0	18.4
	HT/VHT40, M0 to M7	1	5	7.2		7.2	30.0	22.8
	HT/VHT40, M0 to M7	2	8	3.2	3.2	6.2	28.0	21.8
	HT/VHT40, M8 to M15	2	5	3.2	3.2	6.2	30.0	23.8
	HT/VHT40 Beam Forming, M0 to M7	2	8	1.7	1.6	4.7	28.0	23.3
	HT/VHT40 Beam Forming, M8 to M15	2	5	3.2	3.2	6.2	30.0	23.8
	HT/VHT40 STBC, M0 to M7	2	5	3.2	3.2	6.2	30.0	23.8
5775	Non HT80, 6 to 54 Mbps	1	5	2.4		2.4	30.0	27.6
	Non HT80, 6 to 54 Mbps	2	8	-5.1	-4.9	-2.0	28.0	30.0
	VHT80, M0 to M9 1ss	1	5	3.5		3.5	30.0	26.5
	VHT80, M0 to M9 1ss	2	8	3.5	3.6	6.6	28.0	21.4
	VHT80, M0 to M9 2ss	2	5	3.5	3.6	6.6	30.0	23.4
	VHT80 Beam Forming, M0 to M9 1ss	2	8	-2.3	-2.1	0.8	28.0	27.2
	VHT80 Beam Forming, M0 to M9 2ss	2	5	3.5	3.6	6.6	30.0	23.4
	VHT80 STBC, M0 to M9 1ss	2	5	3.5	3.6	6.6	30.0	23.4
5785	Non HT20, 6 to 54 Mbps	1	5	10.4		10.4	30.0	19.6
	Non HT20, 6 to 54 Mbps	2	8	10.4	9.3	12.9	28.0	15.1
	Non HT20 Beam Forming, 6 to 54 Mbps	2	8	3.1	1.3	5.3	28.0	22.7
	HT/VHT20, M0 to M7	1	5	8.1		8.1	30.0	21.9
	HT/VHT20, M0 to M7	2	8	4.3	5.1	7.7	28.0	20.3
	HT/VHT20, M8 to M15	2	5	4.3	5.1	7.7	30.0	22.3
	HT/VHT20 Beam Forming, M0 to M7	2	8	3.3	1.3	5.4	28.0	22.6



	HT/VHT20 Beam Forming, M8 to M15	2	5	4.3	5.1	7.7	30.0	22.3
	HT/VHT20 STBC, M0 to M7	2	5	4.3	5.1	7.7	30.0	22.3
5795	Non HT40, 6 to 54 Mbps	1	5	6.8		6.8	30.0	23.2
	Non HT40, 6 to 54 Mbps	2	8	1.8	1.5	4.7	28.0	23.3
	HT/VHT40, M0 to M7	1	5	6.8		6.8	30.0	23.2
	HT/VHT40, M0 to M7	2	8	1.5	1.9	4.7	28.0	23.3
	HT/VHT40, M8 to M15	2	5	1.5	1.9	4.7	30.0	25.3
	HT/VHT40 Beam Forming, M0 to M7	2	8	-0.4	-1.5	2.1	28.0	25.9
	HT/VHT40 Beam Forming, M8 to M15	2	5	1.5	1.9	4.7	30.0	25.3
	HT/VHT40 STBC, M0 to M7	2	5	1.5	1.9	4.7	30.0	25.3
5825	Non HT20, 6 to 54 Mbps	1	5	9.1		9.1	30.0	20.9
	Non HT20, 6 to 54 Mbps	2	8	5.3	5.0	8.2	28.0	19.8
	Non HT20 Beam Forming, 6 to 54 Mbps	2	8	2.6	1.5	5.1	28.0	22.9
	HT/VHT20, M0 to M7	1	5	9.3		9.3	30.0	20.7
	HT/VHT20, M0 to M7	2	8	5.3	4.7	8.0	28.0	20.0
	HT/VHT20, M8 to M15	2	5	5.3	4.7	8.0	30.0	22.0
	HT/VHT20 Beam Forming, M0 to M7	2	8	2.4	1.6	5.0	28.0	23.0
	HT/VHT20 Beam Forming, M8 to M15	2	5	5.3	4.7	8.0	30.0	22.0
	HT/VHT20 STBC, M0 to M7	2	5	5.3	4.7	8.0	30.0	22.0

Power Spectral Density, 5745 MHz, Non HT20, 6 to 54 Mbps

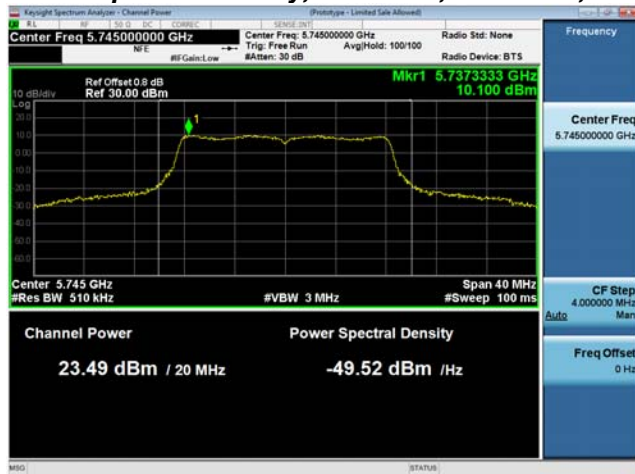

Antenna A



Antenna B



Antenna Gain: 7 dBi

Frequency (MHz)	Mode	Tx Paths	Correlated Antenna Gain (dBi)	Tx 1 PSD (dBm/MHz)	Tx 2 PSD (dBm/MHz)	Total PSD (dBm/500MHz)	Limit (dBm/500MHz)	Margin (dB)
5745	Non HT20, 6 to 54 Mbps	1	7	10.1		10.1	29.0	18.9
	Non HT20, 6 to 54 Mbps	2	10	10.1	10.3	13.2	26.0	12.8
	Non HT20 Beam Forming, 6 to 54 Mbps	2	10	10.7	8.2	12.6	26.0	13.4
	HT/VHT20, M0 to M7	1	7	10.6		10.6	29.0	18.4
	HT/VHT20, M0 to M7	2	10	4.8	4.5	7.7	26.0	18.3
	HT/VHT20, M8 to M15	2	7	4.8	4.5	7.7	29.0	21.3
	HT/VHT20 Beam Forming, M0 to M7	2	10	1.5	1.8	4.7	26.0	21.3
	HT/VHT20 Beam Forming, M8 to M15	2	7	4.8	4.5	7.7	29.0	21.3
	HT/VHT20 STBC, M0 to M7	2	7	4.8	4.5	7.7	29.0	21.3
5755	Non HT40, 6 to 54 Mbps	1	7	6.5		6.5	29.0	22.5
	Non HT40, 6 to 54 Mbps	2	10	1.7	2.8	5.3	26.0	20.7
	HT/VHT40, M0 to M7	1	7	7.2		7.2	29.0	21.8
	HT/VHT40, M0 to M7	2	10	3.2	3.2	6.2	26.0	19.8
	HT/VHT40, M8 to M15	2	7	3.2	3.2	6.2	29.0	22.8
	HT/VHT40 Beam Forming, M0 to M7	2	10	-1.0	-1.3	1.9	26.0	24.1
	HT/VHT40 Beam Forming, M8 to M15	2	7	3.2	3.2	6.2	29.0	22.8
	HT/VHT40 STBC, M0 to M7	2	7	3.2	3.2	6.2	29.0	22.8
5775	Non HT80, 6 to 54 Mbps	1	7	1.6		1.6	29.0	27.4
	Non HT80, 6 to 54 Mbps	2	10	-5.1	-4.9	-2.0	26.0	28.0
	VHT80, M0 to M9 1ss	1	7	3.5		3.5	29.0	25.5
	VHT80, M0 to M9 1ss	2	10	-2.3	-2.1	0.8	26.0	25.2
	VHT80, M0 to M9 2ss	2	7	-2.3	-2.1	0.8	29.0	28.2
	VHT80 Beam Forming, M0 to M9 1ss	2	10	-3.0	-3.9	-0.4	26.0	26.4
	VHT80 Beam Forming, M0 to M9 2ss	2	7	-2.3	-2.1	0.8	29.0	28.2
	VHT80 STBC, M0 to M9 1ss	2	7	-2.3	-2.1	0.8	29.0	28.2
5785	Non HT20, 6 to 54 Mbps	1	7	10.4		10.4	29.0	18.6
	Non HT20, 6 to 54 Mbps	2	10	2.2	3.6	6.0	26.0	20.0
	Non HT20 Beam Forming, 6 to 54 Mbps	2	10	-0.3	-1.8	2.0	26.0	24.0
	HT/VHT20, M0 to M7	1	7	6.2		6.2	29.0	22.8
	HT/VHT20, M0 to M7	2	10	2.1	3.7	6.0	26.0	20.0
	HT/VHT20, M8 to M15	2	7	2.1	3.7	6.0	29.0	23.0
	HT/VHT20 Beam Forming, M0 to M7	2	10	-0.2	-1.7	2.1	26.0	23.9



	HT/VHT20 Beam Forming, M8 to M15	2	7	2.1	3.7	6.0	29.0	23.0
	HT/VHT20 STBC, M0 to M7	2	7	2.1	3.7	6.0	29.0	23.0
5795	Non HT40, 6 to 54 Mbps	1	7	6.8		6.8	29.0	22.2
	Non HT40, 6 to 54 Mbps	2	10	-1.0	-2.0	1.5	26.0	24.5
	HT/VHT40, M0 to M7	1	7	6.8		6.8	29.0	22.2
	HT/VHT40, M0 to M7	2	10	-0.7	-1.0	2.2	26.0	23.8
	HT/VHT40, M8 to M15	2	7	-0.7	-1.0	2.2	29.0	26.8
	HT/VHT40 Beam Forming, M0 to M7	2	10	-3.6	-4.9	-1.2	26.0	27.2
	HT/VHT40 Beam Forming, M8 to M15	2	7	-0.7	-1.0	2.2	29.0	26.8
	HT/VHT40 STBC, M0 to M7	2	7	-0.7	-1.0	2.2	29.0	26.8
5825	Non HT20, 6 to 54 Mbps	1	7	9.1		9.1	29.0	19.9
	Non HT20, 6 to 54 Mbps	2	10	2.6	1.5	5.1	26.0	20.9
	Non HT20 Beam Forming, 6 to 54 Mbps	2	10	-1.1	-1.5	1.7	26.0	24.3
	HT/VHT20, M0 to M7	1	7	9.3		9.3	29.0	19.7
	HT/VHT20, M0 to M7	2	10	2.4	1.6	5.0	26.0	21.0
	HT/VHT20, M8 to M15	2	7	2.4	1.6	5.0	29.0	24.0
	HT/VHT20 Beam Forming, M0 to M7	2	10	-1.2	-1.5	1.7	26.0	24.3
	HT/VHT20 Beam Forming, M8 to M15	2	7	2.4	1.6	5.0	29.0	24.0
	HT/VHT20 STBC, M0 to M7	2	7	2.4	1.6	5.0	29.0	24.0

Power Spectral Density, 5745 MHz, Non HT20, 6 to 54 Mbps



Antenna A



Antenna B

Antenna Gain: 8 dBi

Frequency (MHz)	Mode	Tx Paths	Correlated Antenna Gain (dBi)	Tx 1 PSD (dBm/MHz)	Tx 2 PSD (dBm/MHz)	Total PSD (dBm/500MHz)	Limit (dBm/500MHz)	Margin (dB)
5745	Non HT20, 6 to 54 Mbps	1	8	10.1		10.1	28.0	17.9
	Non HT20, 6 to 54 Mbps	2	11	10.1	10.3	13.2	25.0	11.8
	Non HT20 Beam Forming, 6 to 54 Mbps	2	11	7.6	8.8	11.3	25.0	13.7
	HT/VHT20, M0 to M7	1	8	10.6		10.6	28.0	17.4
	HT/VHT20, M0 to M7	2	11	4.8	4.5	7.7	25.0	17.3
	HT/VHT20, M8 to M15	2	8	4.8	4.5	7.7	28.0	20.3
	HT/VHT20 Beam Forming, M0 to M7	2	11	2.7	3.5	6.1	25.0	18.9
	HT/VHT20 Beam Forming, M8 to M15	2	8	4.8	4.5	7.7	28.0	20.3
	HT/VHT20 STBC, M0 to M7	2	8	4.8	4.5	7.7	28.0	20.3
5755	Non HT40, 6 to 54 Mbps	1	8	6.5		6.5	28.0	21.5
	Non HT40, 6 to 54 Mbps	2	11	-0.1	0.6	3.3	25.0	21.7
	HT/VHT40, M0 to M7	1	8	7.2		7.2	28.0	20.8
	HT/VHT40, M0 to M7	2	11	1.7	1.6	4.7	25.0	20.3
	HT/VHT40, M8 to M15	2	8	1.7	1.6	4.7	28.0	23.3
	HT/VHT40 Beam Forming, M0 to M7	2	11	-2.0	-2.5	0.8	25.0	24.2
	HT/VHT40 Beam Forming, M8 to M15	2	8	1.7	1.6	4.7	28.0	23.3
	HT/VHT40 STBC, M0 to M7	2	8	1.7	1.6	4.7	28.0	23.3
5775	Non HT80, 6 to 54 Mbps	1	8	1.6		1.6	28.0	26.4
	Non HT80, 6 to 54 Mbps	2	11	-5.1	-4.9	-2.0	25.0	27.0
	VHT80, M0 to M9 1ss	1	8	3.5		3.5	28.0	24.5
	VHT80, M0 to M9 1ss	2	11	-2.3	-2.1	0.8	25.0	24.2
	VHT80, M0 to M9 2ss	2	8	-2.3	-2.1	0.8	28.0	27.2
	VHT80 Beam Forming, M0 to M9 1ss	2	11	-3.9	-5.0	-1.4	25.0	26.4
	VHT80 Beam Forming, M0 to M9 2ss	2	8	-2.3	-2.1	0.8	28.0	27.2
	VHT80 STBC, M0 to M9 1ss	2	8	-2.3	-2.1	0.8	28.0	27.2
5785	Non HT20, 6 to 54 Mbps	1	8	10.4		10.4	28.0	17.6
	Non HT20, 6 to 54 Mbps	2	11	3.1	1.3	5.3	25.0	19.7
	Non HT20 Beam Forming, 6 to 54 Mbps	2	11	-1.8	-0.6	1.9	25.0	23.1
	HT/VHT20, M0 to M7	1	8	4.3		4.3	28.0	23.7
	HT/VHT20, M0 to M7	2	11	3.3	1.3	5.4	25.0	19.6
	HT/VHT20, M8 to M15	2	8	3.3	1.3	5.4	28.0	22.6
	HT/VHT20 Beam Forming, M0 to M7	2	11	-1.7	-1.0	1.7	25.0	23.3

	HT/VHT20 Beam Forming, M8 to M15	2	8	3.3	1.3	5.4	28.0	22.6
	HT/VHT20 STBC, M0 to M7	2	8	3.3	1.3	5.4	28.0	22.6
5795	Non HT40, 6 to 54 Mbps	1	8	1.7		1.7	28.0	26.3
	Non HT40, 6 to 54 Mbps	2	11	-1.0	-2.2	1.5	25.0	23.5
	HT/VHT40, M0 to M7	1	8	6.8		6.8	28.0	21.2
	HT/VHT40, M0 to M7	2	11	-0.4	-1.5	2.1	25.0	22.9
	HT/VHT40, M8 to M15	2	8	-0.4	-1.5	2.1	28.0	25.9
	HT/VHT40 Beam Forming, M0 to M7	2	11	-4.9	-4.0	-1.4	25.0	26.4
	HT/VHT40 Beam Forming, M8 to M15	2	8	-0.4	-1.5	2.1	28.0	25.9
	HT/VHT40 STBC, M0 to M7	2	8	-0.4	-1.5	2.1	28.0	25.9
5825	Non HT20, 6 to 54 Mbps	1	8	9.1		9.1	28.0	18.9
	Non HT20, 6 to 54 Mbps	2	11	2.6	1.5	5.1	25.0	19.9
	Non HT20 Beam Forming, 6 to 54 Mbps	2	11	-1.8	-2.6	0.8	25.0	24.2
	HT/VHT20, M0 to M7	1	8	9.3		9.3	28.0	18.7
	HT/VHT20, M0 to M7	2	11	2.4	1.6	5.0	25.0	20.0
	HT/VHT20, M8 to M15	2	8	2.4	1.6	5.0	28.0	23.0
	HT/VHT20 Beam Forming, M0 to M7	2	11	-2.2	-2.4	0.7	25.0	24.3
	HT/VHT20 Beam Forming, M8 to M15	2	8	2.4	1.6	5.0	28.0	23.0
	HT/VHT20 STBC, M0 to M7	2	8	2.4	1.6	5.0	28.0	23.0

Power Spectral Density, 5745 MHz, Non HT20, 6 to 54 Mbps

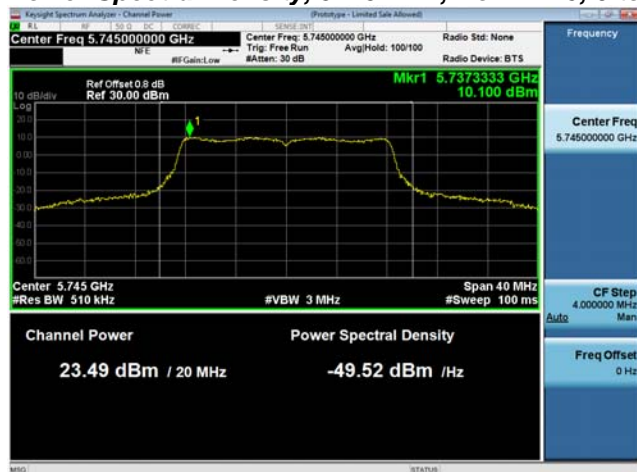

Antenna A



Antenna B

Antenna Gain: 13 dBi

Frequency (MHz)	Mode	Tx Paths	Correlated Antenna Gain (dBi)	Tx 1 PSD (dBm/MHz)	Tx 2 PSD (dBm/MHz)	Total PSD (dBm/500MHz)	Limit (dBm/500MHz)	Margin (dB)
5745	Non HT20, 6 to 54 Mbps	1	13	10.1		10.1	30.0	19.9
	Non HT20, 6 to 54 Mbps	2	13	10.1	10.3	13.2	30.0	16.8
	Non HT20 Beam Forming, 6 to 54 Mbps	2	13	10.1	10.3	13.2	30.0	16.8
	HT/VHT20, M0 to M7	1	13	8.3		8.3	30.0	21.7
	HT/VHT20, M0 to M7	2	13	-1.5	-1.1	1.7	30.0	28.3
	HT/VHT20, M8 to M15	2	13	-1.5	-1.1	1.7	30.0	28.3
	HT/VHT20 Beam Forming, M0 to M7	2	13	-1.5	-1.1	1.7	30.0	28.3
	HT/VHT20 Beam Forming, M8 to M15	2	13	-1.5	-1.1	1.7	30.0	28.3
	HT/VHT20 STBC, M0 to M7	2	13	-1.5	-1.1	1.7	30.0	28.3
5755	Non HT40, 6 to 54 Mbps	1	13	4.5		4.5	30.0	25.5
	Non HT40, 6 to 54 Mbps	2	13	-0.1	0.6	3.3	30.0	26.7
	HT/VHT40, M0 to M7	1	13	5.0		5.0	30.0	25.0
	HT/VHT40, M0 to M7	2	13	-3.4	-2.7	0.0	30.0	30.0
	HT/VHT40, M8 to M15	2	13	-3.4	-2.7	0.0	30.0	30.0
	HT/VHT40 Beam Forming, M0 to M7	2	13	-3.4	-2.7	0.0	30.0	30.0
	HT/VHT40 Beam Forming, M8 to M15	2	13	-3.4	-2.7	0.0	30.0	30.0
	HT/VHT40 STBC, M0 to M7	2	13	-3.4	-2.7	0.0	30.0	30.0
5775	Non HT80, 6 to 54 Mbps	1	13	-5.1		-5.1	30.0	35.1
	Non HT80, 6 to 54 Mbps	2	13	-5.1	-4.9	-2.0	30.0	32.0
	VHT80, M0 to M9 1ss	1	13	1.5		1.5	30.0	28.5
	VHT80, M0 to M9 1ss	2	13	-7.3	-6.6	-3.9	30.0	33.9
	VHT80, M0 to M9 2ss	2	13	-7.3	-6.6	-3.9	30.0	33.9
	VHT80 Beam Forming, M0 to M9 1ss	2	13	-7.3	-6.6	-3.9	30.0	33.9
	VHT80 Beam Forming, M0 to M9 2ss	2	13	-7.3	-6.6	-3.9	30.0	33.9
	VHT80 STBC, M0 to M9 1ss	2	13	-7.3	-6.6	-3.9	30.0	33.9
	5785	Non HT20, 6 to 54 Mbps	1	13	-1.8		-1.8	30.0
Non HT20, 6 to 54 Mbps		2	13	-3.3	-2.7	0.0	30.0	30.0
Non HT20 Beam Forming, 6 to 54 Mbps		2	13	-3.3	-2.7	0.0	30.0	30.0
HT/VHT20, M0 to M7		1	13	-1.7		-1.7	30.0	31.7
HT/VHT20, M0 to M7		2	13	-3.6	-2.9	-0.2	30.0	30.2
HT/VHT20, M8 to M15		2	13	-3.6	-2.9	-0.2	30.0	30.2
HT/VHT20 Beam Forming, M0 to M7		2	13	-3.6	-2.9	-0.2	30.0	30.2

	HT/VHT20 Beam Forming, M8 to M15	2	13	-3.6	-2.9	-0.2	30.0	30.2
	HT/VHT20 STBC, M0 to M7	2	13	-3.6	-2.9	-0.2	30.0	30.2
5795	Non HT40, 6 to 54 Mbps	1	13	-3.4		-3.4	30.0	33.4
	Non HT40, 6 to 54 Mbps	2	13	-7.6	-8.2	-4.9	30.0	34.9
	HT/VHT40, M0 to M7	1	13	-2.7		-2.7	30.0	32.7
	HT/VHT40, M0 to M7	2	13	-6.6	-6.4	-3.5	30.0	33.5
	HT/VHT40, M8 to M15	2	13	-6.6	-6.4	-3.5	30.0	33.5
	HT/VHT40 Beam Forming, M0 to M7	2	13	-6.6	-6.4	-3.5	30.0	33.5
	HT/VHT40 Beam Forming, M8 to M15	2	13	-6.6	-6.4	-3.5	30.0	33.5
	HT/VHT40 STBC, M0 to M7	2	13	-6.6	-6.4	-3.5	30.0	33.5
5825	Non HT20, 6 to 54 Mbps	1	13	0.0		0.0	30.0	30.0
	Non HT20, 6 to 54 Mbps	2	13	-3.3	-3.4	-0.3	30.0	30.3
	Non HT20 Beam Forming, 6 to 54 Mbps	2	13	-3.3	-3.4	-0.3	30.0	30.3
	HT/VHT20, M0 to M7	1	13	-0.6		-0.6	30.0	30.6
	HT/VHT20, M0 to M7	2	13	-3.7	-3.3	-0.5	30.0	30.5
	HT/VHT20, M8 to M15	2	13	-3.7	-3.3	-0.5	30.0	30.5
	HT/VHT20 Beam Forming, M0 to M7	2	13	-3.7	-3.3	-0.5	30.0	30.5
	HT/VHT20 Beam Forming, M8 to M15	2	13	-3.7	-3.3	-0.5	30.0	30.5
	HT/VHT20 STBC, M0 to M7	2	13	-3.7	-3.3	-0.5	30.0	30.5

Power Spectral Density, 5745 MHz, Non HT20, 6 to 54 Mbps



Antenna A



Antenna B

Antenna Gain: 14 (dBi)

Frequency (MHz)	Mode	Tx Paths	Correlated Antenna Gain (dBi)	Tx 1 PSD (dBm/MHz)	Tx 2 PSD (dBm/MHz)	Total PSD (dBm/500MHz)	Limit (dBm/500MHz)	Margin (dB)
5745	Non HT20, 6 to 54 Mbps	1	14	10.1		10.1	30.0	19.9
	Non HT20, 6 to 54 Mbps	2	14	10.1	10.3	13.2	30.0	16.8
	Non HT20 Beam Forming, 6 to 54 Mbps	2	14	10.1	10.3	13.2	30.0	16.8
	HT/VHT20, M0 to M7	1	14	8.3		8.3	30.0	21.7
	HT/VHT20, M0 to M7	2	14	-1.5	-1.1	1.7	30.0	28.3
	HT/VHT20, M8 to M15	2	14	-1.5	-1.1	1.7	30.0	28.3
	HT/VHT20 Beam Forming, M0 to M7	2	14	-1.5	-1.1	1.7	30.0	28.3
	HT/VHT20 Beam Forming, M8 to M15	2	14	-1.5	-1.1	1.7	30.0	28.3
	HT/VHT20 STBC, M0 to M7	2	14	-1.5	-1.1	1.7	30.0	28.3
5755	Non HT40, 6 to 54 Mbps	1	14	4.5		4.5	30.0	25.5
	Non HT40, 6 to 54 Mbps	2	14	-0.1	0.6	3.3	30.0	26.7
	HT/VHT40, M0 to M7	1	14	5.0		5.0	30.0	25.0
	HT/VHT40, M0 to M7	2	14	-4.5	-4.4	-1.4	30.0	31.4
	HT/VHT40, M8 to M15	2	14	-4.5	-4.4	-1.4	30.0	31.4
	HT/VHT40 Beam Forming, M0 to M7	2	14	-4.5	-4.4	-1.4	30.0	31.4
	HT/VHT40 Beam Forming, M8 to M15	2	14	-4.5	-4.4	-1.4	30.0	31.4
	HT/VHT40 STBC, M0 to M7	2	14	-4.5	-4.4	-1.4	30.0	31.4
5775	Non HT80, 6 to 54 Mbps	1	14	-5.1		-5.1	30.0	35.1
	Non HT80, 6 to 54 Mbps	2	14	-5.1	-4.9	-2.0	30.0	32.0
	VHT80, M0 to M9 1ss	1	14	1.5		1.5	30.0	28.5
	VHT80, M0 to M9 1ss	2	14	-8.0	-8.0	-5.0	30.0	35.0
	VHT80, M0 to M9 2ss	2	14	-8.0	-8.0	-5.0	30.0	35.0
	VHT80 Beam Forming, M0 to M9 1ss	2	14	-8.0	-8.0	-5.0	30.0	35.0
	VHT80 Beam Forming, M0 to M9 2ss	2	14	-8.0	-8.0	-5.0	30.0	35.0
	VHT80 STBC, M0 to M9 1ss	2	14	-8.0	-8.0	-5.0	30.0	35.0
5785	Non HT20, 6 to 54 Mbps	1	14	-1.8		-1.8	30.0	31.8
	Non HT20, 6 to 54 Mbps	2	14	-3.3	-2.7	0.0	30.0	30.0
	Non HT20 Beam Forming, 6 to 54 Mbps	2	14	-3.3	-2.7	0.0	30.0	30.0
	HT/VHT20, M0 to M7	1	14	-1.7		-1.7	30.0	31.7
	HT/VHT20, M0 to M7	2	14	-3.3	-4.7	-0.9	30.0	30.9
	HT/VHT20, M8 to M15	2	14	-3.3	-4.7	-0.9	30.0	30.9
	HT/VHT20 Beam Forming, M0 to M7	2	14	-3.3	-4.7	-0.9	30.0	30.9

	HT/VHT20 Beam Forming, M8 to M15	2	14	-3.3	-4.7	-0.9	30.0	30.9
	HT/VHT20 STBC, M0 to M7	2	14	-3.3	-4.7	-0.9	30.0	30.9
5795	Non HT40, 6 to 54 Mbps	1	14	-7.0		-7.0	30.0	37.0
	Non HT40, 6 to 54 Mbps	2	14	-7.6	-8.2	-4.9	30.0	34.9
	HT/VHT40, M0 to M7	1	14	-4.9		-4.9	30.0	34.9
	HT/VHT40, M0 to M7	2	14	-6.8	-7.3	-4.0	30.0	34.0
	HT/VHT40, M8 to M15	2	14	-6.8	-7.3	-4.0	30.0	34.0
	HT/VHT40 Beam Forming, M0 to M7	2	14	-6.8	-7.3	-4.0	30.0	34.0
	HT/VHT40 Beam Forming, M8 to M15	2	14	-6.8	-7.3	-4.0	30.0	34.0
	HT/VHT40 STBC, M0 to M7	2	14	-6.8	-7.3	-4.0	30.0	34.0
5825	Non HT20, 6 to 54 Mbps	1	14	-1.8		-1.8	30.0	31.8
	Non HT20, 6 to 54 Mbps	2	14	-3.8	-4.5	-1.1	30.0	31.1
	Non HT20 Beam Forming, 6 to 54 Mbps	2	14	-3.8	-4.5	-1.1	30.0	31.1
	HT/VHT20, M0 to M7	1	14	-2.2		-2.2	30.0	32.2
	HT/VHT20, M0 to M7	2	14	-4.1	-4.4	-1.2	30.0	31.2
	HT/VHT20, M8 to M15	2	14	-4.1	-4.4	-1.2	30.0	31.2
	HT/VHT20 Beam Forming, M0 to M7	2	14	-4.1	-4.4	-1.2	30.0	31.2
	HT/VHT20 Beam Forming, M8 to M15	2	14	-4.1	-4.4	-1.2	30.0	31.2
	HT/VHT20 STBC, M0 to M7	2	14	-4.1	-4.4	-1.2	30.0	31.2

Power Spectral Density, 5745 MHz, Non HT20, 6 to 54 Mbps

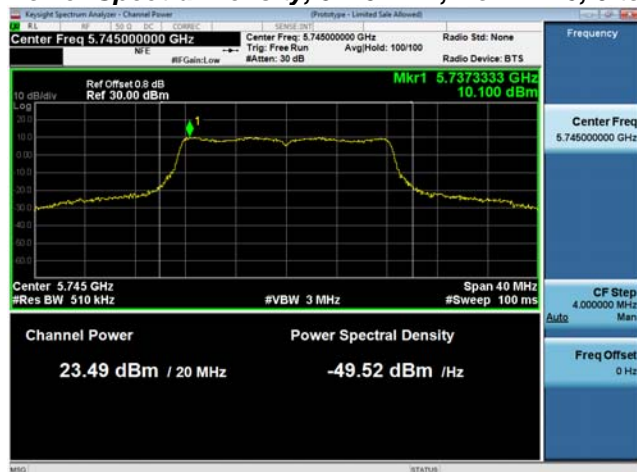

Antenna A

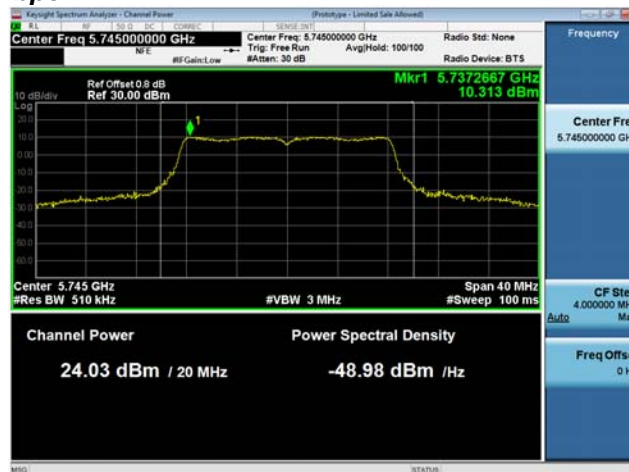

Antenna B

A.5 Conducted Spurious Emissions

15.205 / 15.209 / LP0002 - Radiated emissions which fall in the restricted bands, as defined in Section 15.205(a), must also comply with the radiated emission limits specified in Section 15.209(a) (see Section 15.205(c)).

RSS-Gen 8.9: Except when the requirements applicable to a given device state otherwise, emissions from licence-exempt transmitters shall comply with the field strength limits shown in Table 4 and Table 5 below. Additionally, the level of any transmitter emission shall not exceed the level of the transmitter's fundamental emission.

RSS-Gen 8.10 (b) Unwanted emissions that fall into restricted bands of Table 6 shall comply with the limits specified in RSS-Gen; and **(c)** Unwanted emissions that do not fall within the restricted frequency bands of Table 6 shall comply either with the limits specified in the applicable RSS or with those specified in this RSS-Gen.

Use formula below to substitute conducted measurements in place of radiated measurements

$$E[\text{dB}\mu\text{V}/\text{m}] = \text{EIRP}[\text{dBm}] - 20 \log(d[\text{meters}]) + 104.77, \text{ where } E = \text{field strength and } d = 3 \text{ meter}$$

- 1) Average Plot, Limit= -41.25 dBm eirp
- 2) Peak plot, Limit = -21.25 dBm eirp

Test Procedure

Ref. KDB 789033 D02 General UNII Test Procedures New Rules v01r03
ANSI C63.10: 2013

Conducted Spurious Emissions Test Procedure
<ol style="list-style-type: none"> 1. Connect the antenna port(s) to the spectrum analyzer input. 2. Place the radio in continuous transmit mode. Use the procedures in KDB 789033 D02 General UNII Test Procedures New Rules v01r03 to substitute conducted measurements in place of radiated measurements. 3. Configure Spectrum analyzer as per test parameters below (be sure to enter all losses between the transmitter output and the spectrum analyzer). 4. Record the marker waveform peak to spur difference. Also measure any emissions in the restricted bands. 5. The "measure-and-sum technique" is used for measuring in-band transmit power of a device. In the measure-and-sum approach, the conducted emission level is measured at each antenna port. The measured results at the various antenna ports are then summed mathematically to determine the total emission level from the device. Summing is performed in linear power units. The worst case output is recorded. 6. Capture graphs and record pertinent measurement data.

Ref. KDB 789033 D02 General UNII Test Procedures New Rules v01r03
ANSI C63.10: 2013 section 12.7.7.3 (average) & 12.7.6 (peak)

Conducted Spurious Emissions Test parameters
Span = 30MHz to 18GHz / 18GHz to 40GHz RBW = 1 MHz VBW ≥ 3 x RBW for Peak, 1kHz for Average Sweep = Auto couple Detector = Peak Trace = Max Hold.

System Number	Description	Samples	System under test	Support equipment
1	EUT	S01	<input checked="" type="checkbox"/>	<input type="checkbox"/>
	Support	S02	<input type="checkbox"/>	<input checked="" type="checkbox"/>

Tested By : Jose Aguirre	Date of testing: 20-April-16 - 08-Aug-16
------------------------------------	--

Test Result : PASS

See Appendix C for list of test equipment

Note: Radiated measurements have demonstrated that spurious emissions at the band edges are not correlated and therefore no array gain factor is used.



Conducted Spurs Average Upper, All Antennas

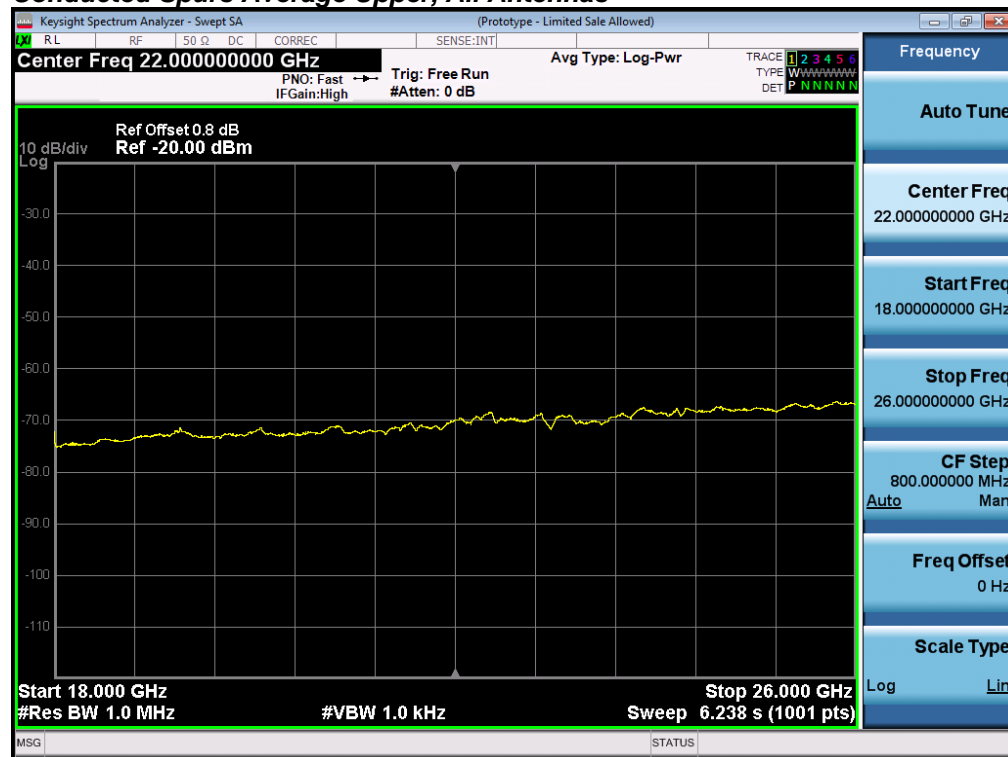

Conducted Spurs Peak Upper, All Antennas

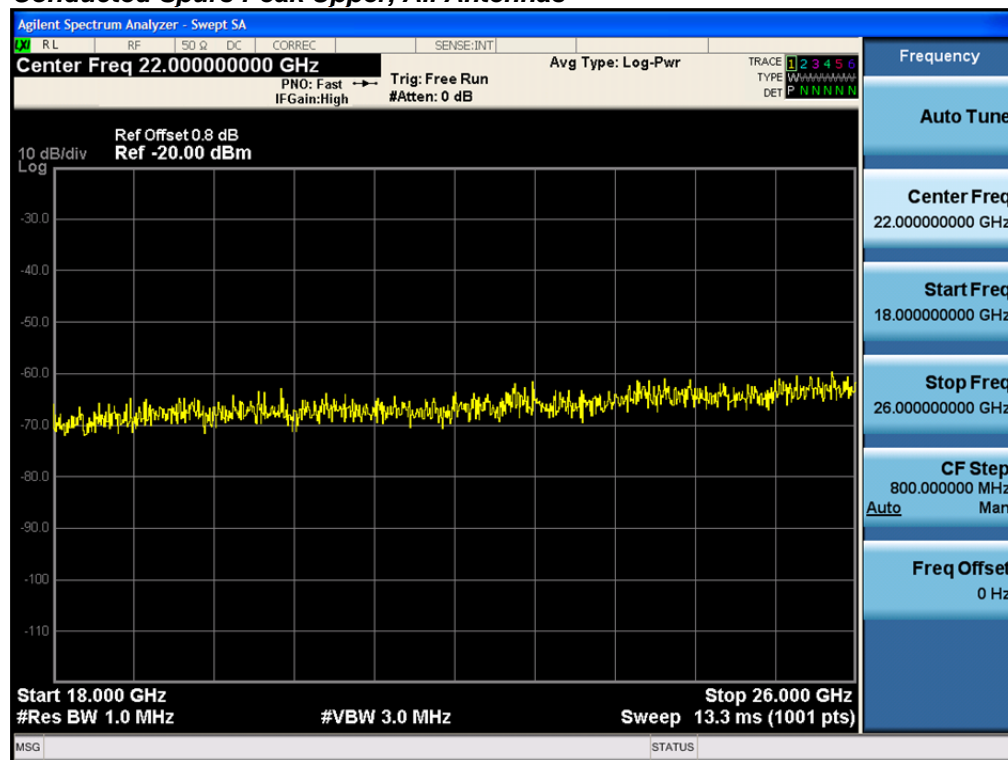

Conducted Spurious Emission results below represent the worst case for all antenna gain

Frequency (MHz)	Mode	Tx Paths	Correlated Antenna Gain (dBi)	Tx 1 Spur Power (dBm)	Tx 2 Spur Power (dBm)	Total Conducted Spur (dBm)	Limit (dBm)	Margin (dB)
5745	Non HT20, 6 to 54 Mbps	1	14	-71.3		-57.3	-41.25	16.1
	Non HT20, 6 to 54 Mbps	2	14	-71.3	-72.1	-54.7	-41.25	13.4
	Non HT20 Beam Forming, 6 to 54 Mbps	2	14	-71.3	-72.1	-54.7	-41.25	13.4
	HT/VHT20, M0 to M7	1	14	-72.0		-58.0	-41.25	16.8
	HT/VHT20, M0 to M7	2	14	-74.0	-73.7	-56.8	-41.25	15.6
	HT/VHT20, M8 to M15	2	14	-74.0	-73.7	-56.8	-41.25	15.6
	HT/VHT20 Beam Forming, M0 to M7	2	14	-74.0	-73.7	-56.8	-41.25	15.6
	HT/VHT20 Beam Forming, M8 to M15	2	14	-74.0	-73.7	-56.8	-41.25	15.6
	HT/VHT20 STBC, M0 to M7	2	14	-74.0	-73.7	-56.8	-41.25	15.6
5755	Non HT40, 6 to 54 Mbps	1	14	-57.8		-43.8	-41.25	2.6
	Non HT40, 6 to 54 Mbps	2	14	-70.0	-70.0	-53.0	-41.25	11.7
	HT/VHT40, M0 to M7	1	14	-71.4		-57.4	-41.25	16.2
	HT/VHT40, M0 to M7	2	14	-74.0	-73.8	-56.9	-41.25	15.6
	HT/VHT40, M8 to M15	2	14	-74.0	-73.8	-56.9	-41.25	15.6
	HT/VHT40 Beam Forming, M0 to M7	2	14	-74.0	-73.8	-56.9	-41.25	15.6
	HT/VHT40 Beam Forming, M8 to M15	2	14	-74.0	-73.8	-56.9	-41.25	15.6
	HT/VHT40 STBC, M0 to M7	2	14	-74.0	-73.8	-56.9	-41.25	15.6
5775	Non HT80, 6 to 54 Mbps	1	14	-71.5		-57.5	-41.25	16.3
	Non HT80, 6 to 54 Mbps	2	14	-71.5	-70.1	-53.7	-41.25	12.5
	VHT80, M0 to M9 1ss	1	14	-70.8		-56.8	-41.25	15.6
	VHT80, M0 to M9 1ss	2	14	-73.8	-73.8	-56.8	-41.25	15.5
	VHT80, M0 to M9 2ss	2	14	-73.8	-73.8	-56.8	-41.25	15.5
	VHT80 Beam Forming, M0 to M9 1ss	2	14	-73.8	-73.8	-56.8	-41.25	15.5
	VHT80 Beam Forming, M0 to M9 2ss	2	14	-73.8	-73.8	-56.8	-41.25	15.5
	VHT80 STBC, M0 to M9 1ss	2	14	-73.8	-73.8	-56.8	-41.25	15.5
5785	Non HT20, 6 to 54 Mbps	1	14	-57.5		-43.5	-41.25	2.3
	Non HT20, 6 to 54 Mbps	2	14	-58.5	-58.2	-41.3	-41.25	0.1
	Non HT20 Beam Forming, 6 to 54 Mbps	2	14	-58.5	-58.2	-41.3	-41.25	0.1
	HT/VHT20, M0 to M7	1	14	-57.3		-43.3	-41.25	2.1
	HT/VHT20, M0 to M7	2	14	-58.0	-59.1	-41.5	-41.25	0.3
	HT/VHT20, M8 to M15	2	14	-58.0	-59.1	-41.5	-41.25	0.3

	HT/VHT20 Beam Forming, M0 to M7	2	14	-58.0	-59.1	-41.5	-41.25	0.3
	HT/VHT20 Beam Forming, M8 to M15	2	14	-58.0	-59.1	-41.5	-41.25	0.3
	HT/VHT20 STBC, M0 to M7	2	14	-58.0	-59.1	-41.5	-41.25	0.3
5795	Non HT40, 6 to 54 Mbps	1	14	-58.3		-44.3	-41.25	3.1
	Non HT40, 6 to 54 Mbps	2	14	-59.3	-59.9	-42.6	-41.25	1.3
	HT/VHT40, M0 to M7	1	14	-57.8		-43.8	-41.25	2.6
	HT/VHT40, M0 to M7	2	14	-58.5	-59.5	-42.0	-41.25	0.7
	HT/VHT40, M8 to M15	2	14	-58.5	-59.5	-42.0	-41.25	0.7
	HT/VHT40 Beam Forming, M0 to M7	2	14	-58.5	-59.5	-42.0	-41.25	0.7
	HT/VHT40 Beam Forming, M8 to M15	2	14	-58.5	-59.5	-42.0	-41.25	0.7
	HT/VHT40 STBC, M0 to M7	2	14	-58.5	-59.5	-42.0	-41.25	0.7
5825	Non HT20, 6 to 54 Mbps	1	14	-55.6		-41.6	-41.25	0.4
	Non HT20, 6 to 54 Mbps	2	14	-58.8	-58.3	-41.5	-41.25	0.3
	Non HT20 Beam Forming, 6 to 54 Mbps	2	14	-58.8	-58.3	-41.5	-41.25	0.3
	HT/VHT20, M0 to M7	1	14	-55.7		-41.7	-41.25	0.5
	HT/VHT20, M0 to M7	2	14	-58.9	-58.5	-41.7	-41.25	0.4
	HT/VHT20, M8 to M15	2	14	-58.9	-58.5	-41.7	-41.25	0.4
	HT/VHT20 Beam Forming, M0 to M7	2	14	-58.9	-58.5	-41.7	-41.25	0.4
	HT/VHT20 Beam Forming, M8 to M15	2	14	-58.9	-58.5	-41.7	-41.25	0.4
	HT/VHT20 STBC, M0 to M7	2	14	-58.9	-58.5	-41.7	-41.25	0.4



Conducted Spurs Average, 5785 MHz, Non HT20, 6 to 54 Mbps



Antenna A



Antenna B

Frequency (MHz)	Mode	Tx Paths	Correlated Antenna Gain (dBi)	Tx 1 Spur Power (dBm)	Tx 2 Spur Power (dBm)	Total Conducted Spur (dBm)	Limit (dBm)	Margin (dB)
5745	Non HT20, 6 to 54 Mbps	1	14	-58.6		-44.6	-21.25	23.4
	Non HT20, 6 to 54 Mbps	2	14	-58.6	-58.0	-41.3	-21.25	20.0
	Non HT20 Beam Forming, 6 to 54 Mbps	2	14	-58.6	-58.0	-41.3	-21.25	20.0
	HT/VHT20, M0 to M7	1	14	-58.4		-44.4	-21.25	23.2
	HT/VHT20, M0 to M7	2	14	-54.8	-45.8	-31.3	-21.25	10.0
	HT/VHT20, M8 to M15	2	14	-54.8	-45.8	-31.3	-21.25	10.0
	HT/VHT20 Beam Forming, M0 to M7	2	14	-54.8	-45.8	-31.3	-21.25	10.0
	HT/VHT20 Beam Forming, M8 to M15	2	14	-54.8	-45.8	-31.3	-21.25	10.0
HT/VHT20 STBC, M0 to M7	2	14	-54.8	-45.8	-31.3	-21.25	10.0	
5755	Non HT40, 6 to 54 Mbps	1	14	-58.5		-44.5	-21.25	23.3
	Non HT40, 6 to 54 Mbps	2	14	-56.8	-39.9	-25.8	-21.25	4.6
	HT/VHT40, M0 to M7	1	14	-56.2		-42.2	-21.25	21.0
	HT/VHT40, M0 to M7	2	14	-58.1	-58.5	-41.3	-21.25	20.0
	HT/VHT40, M8 to M15	2	14	-58.1	-58.5	-41.3	-21.25	20.0
	HT/VHT40 Beam Forming, M0 to M7	2	14	-58.1	-58.5	-41.3	-21.25	20.0
	HT/VHT40 Beam Forming, M8 to M15	2	14	-58.1	-58.5	-41.3	-21.25	20.0
	HT/VHT40 STBC, M0 to M7	2	14	-58.1	-58.5	-41.3	-21.25	20.0
5775	Non HT80, 6 to 54 Mbps	1	14	-59.9		-45.9	-21.25	24.7
	Non HT80, 6 to 54 Mbps	2	14	-59.9	-58.2	-42.0	-21.25	20.7
	VHT80, M0 to M9 1ss	1	14	-58.8		-44.8	-21.25	23.6
	VHT80, M0 to M9 1ss	2	14	-58.7	-44.1	-30.0	-21.25	8.7
	VHT80, M0 to M9 2ss	2	14	-58.7	-44.1	-30.0	-21.25	8.7
	VHT80 Beam Forming, M0 to M9 1ss	2	14	-58.7	-44.1	-30.0	-21.25	8.7
	VHT80 Beam Forming, M0 to M9 2ss	2	14	-58.7	-44.1	-30.0	-21.25	8.7
	VHT80 STBC, M0 to M9 1ss	2	14	-58.7	-44.1	-30.0	-21.25	8.7
5785	Non HT20, 6 to 54 Mbps	1	14	-48.5		-34.5	-21.25	13.3
	Non HT20, 6 to 54 Mbps	2	14	-48.0	-48.1	-31.0	-21.25	9.8
	Non HT20 Beam Forming, 6 to 54 Mbps	2	14	-48.0	-48.1	-31.0	-21.25	9.8
	HT/VHT20, M0 to M7	1	14	-47.2		-33.2	-21.25	12.0
	HT/VHT20, M0 to M7	2	14	-48.2	-48.6	-31.4	-21.25	10.1
	HT/VHT20, M8 to M15	2	14	-48.2	-48.6	-31.4	-21.25	10.1
	HT/VHT20 Beam Forming, M0 to M7	2	14	-48.2	-48.6	-31.4	-21.25	10.1

	HT/VHT20 Beam Forming, M8 to M15	2	14	-48.2	-48.6	-31.4	-21.25	10.1
	HT/VHT20 STBC, M0 to M7	2	14	-48.2	-48.6	-31.4	-21.25	10.1
5795	Non HT40, 6 to 54 Mbps	1	14	-49.0		-35.0	-21.25	13.8
	Non HT40, 6 to 54 Mbps	2	14	-49.4	-50.9	-33.1	-21.25	11.8
	HT/VHT40, M0 to M7	1	14	-48.8		-34.8	-21.25	13.6
	HT/VHT40, M0 to M7	2	14	-48.3	-48.9	-31.6	-21.25	10.3
	HT/VHT40, M8 to M15	2	14	-48.3	-48.9	-31.6	-21.25	10.3
	HT/VHT40 Beam Forming, M0 to M7	2	14	-48.3	-48.9	-31.6	-21.25	10.3
	HT/VHT40 Beam Forming, M8 to M15	2	14	-48.3	-48.9	-31.6	-21.25	10.3
	HT/VHT40 STBC, M0 to M7	2	14	-48.3	-48.9	-31.6	-21.25	10.3
5825	Non HT20, 6 to 54 Mbps	1	14	-46.9		-32.9	-21.25	11.7
	Non HT20, 6 to 54 Mbps	2	14	-49.1	-46.7	-30.7	-21.25	9.5
	Non HT20 Beam Forming, 6 to 54 Mbps	2	14	-49.1	-46.7	-30.7	-21.25	9.5
	HT/VHT20, M0 to M7	1	14	-47.0		-33.0	-21.25	11.8
	HT/VHT20, M0 to M7	2	14	-49.1	-48.8	-31.9	-21.25	10.7
	HT/VHT20, M8 to M15	2	14	-49.1	-48.8	-31.9	-21.25	10.7
	HT/VHT20 Beam Forming, M0 to M7	2	14	-49.1	-48.8	-31.9	-21.25	10.7
	HT/VHT20 Beam Forming, M8 to M15	2	14	-49.1	-48.8	-31.9	-21.25	10.7
	HT/VHT20 STBC, M0 to M7	2	14	-49.1	-48.8	-31.9	-21.25	10.7



Conducted Spurs Peak, 5755 MHz, Non HT40, 6 to 54 Mbps

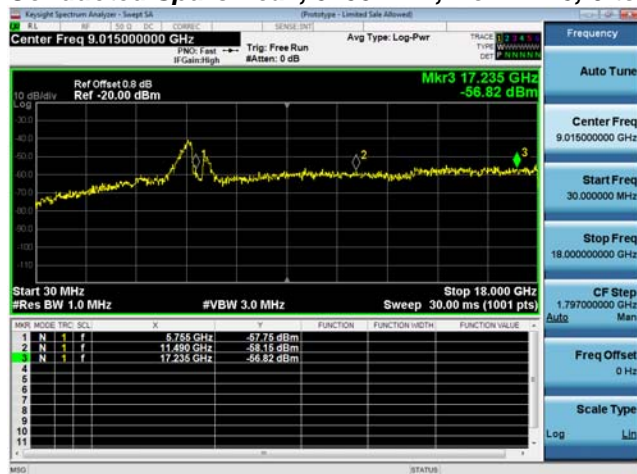

Antenna A



Antenna B



A.6 Conducted Bandedge

15.205 / 15.247 / LP0002 / RSS-247 In any 100 kHz bandwidth outside the frequency band in which the digitally modulated intentional radiator is operating, the radio frequency power that is produced by the intentional radiator shall be at least 30 dB below that in the 100 kHz bandwidth within the band that contains the highest level of the desired power.

Test Procedure

Ref. KDB 789033 D02 General UNII Test Procedures New Rules v01r03
ANSI C63.10: 2013

<p>Conducted Bandedge Test Procedure</p> <ol style="list-style-type: none"> 1. Connect the antenna port(s) to the spectrum analyzer input. 2. Place the radio in continuous transmit mode. Use the procedures in ANSI C63.10: 2013 to substitute conducted measurements in place of radiated measurements. 3. Configure Spectrum analyzer as per test parameters below (be sure to enter all losses between the transmitter output and the spectrum analyzer). 4. Place a marker at the end of the restricted band closest to the transmit frequency to show compliance. Also measure any emissions in the restricted bands. 5. The "measure-and-sum technique" is used for measuring in-band transmit power of a device. In the measure-and-sum approach, the conducted emission level is measured at each antenna port. The measured results at the various antenna ports are then summed mathematically to determine the total emission level from the device. Summing is performed in linear power units. The worst case output is recorded. 6. Place a marker at the end of the restricted band closest to the transmit frequency to show compliance. Also measure any emissions in the restricted bands 7. Capture graphs and record pertinent measurement data.
--

Ref. ANSI C63.10: 2013 section 12.7.6 (peak) & 12.7.7.3 (average, Method VB-A (Alternative))

<p>Conducted Bandedge Test parameters restricted Band</p> <p>RBW = 1 MHz VBW ≥ 3 x RBW for Peak, 100Hz for Average Sweep = Auto couple Detector = Peak Trace = Max Hold.</p>

System Number	Description	Samples	System under test	Support equipment
1	EUT	S01	<input checked="" type="checkbox"/>	<input type="checkbox"/>
	Support	S02	<input type="checkbox"/>	<input checked="" type="checkbox"/>

<p>Tested By : Jose Aguirre</p>	<p>Date of testing: 20-April-16 - 08-Aug-16</p>
<p>Test Result : PASS</p>	

See Appendix C for list of test equipment

Note: Radiated measurements have demonstrated that spurious emissions at the band edges are not correlated and therefore no array gain factor is used.

Frequency (MHz)	Mode	Data Rate (Mbps)	Conducted Bandedge Delta (dB)	Limit (dBc)	Margin (dB)
5745	Non HT20, 6 to 54 Mbps	6	40.8	>30	10.8
	HT/VHT20, M0 to M15	m0	38.1	>30	8.1
5755	Non HT40, 6 to 54 Mbps	6	32.7	>30	2.7
	HT/VHT40, M0 to M15	m0	33.3	>30	3.3
5775	Non HT80, 6 to 54 Mbps	6	34.6	>30	4.6
	VHT80, M0 to M9, M0 to M9 1-1ss	m0x1	32.3	>30	2.3
5795	Non HT40, 6 to 54 Mbps	6	46.0	>30	16.0
	HT/VHT40, M0 to M15	m0	48.5	>30	18.5
5825	Non HT20, 6 to 54 Mbps	6	49.0	>30	19.0
	HT/VHT20, M0 to M15	m0	47.4	>30	17.4



Conducted Bandedge Delta, 5745 MHz, Non HT20, 6 to 54 Mbps

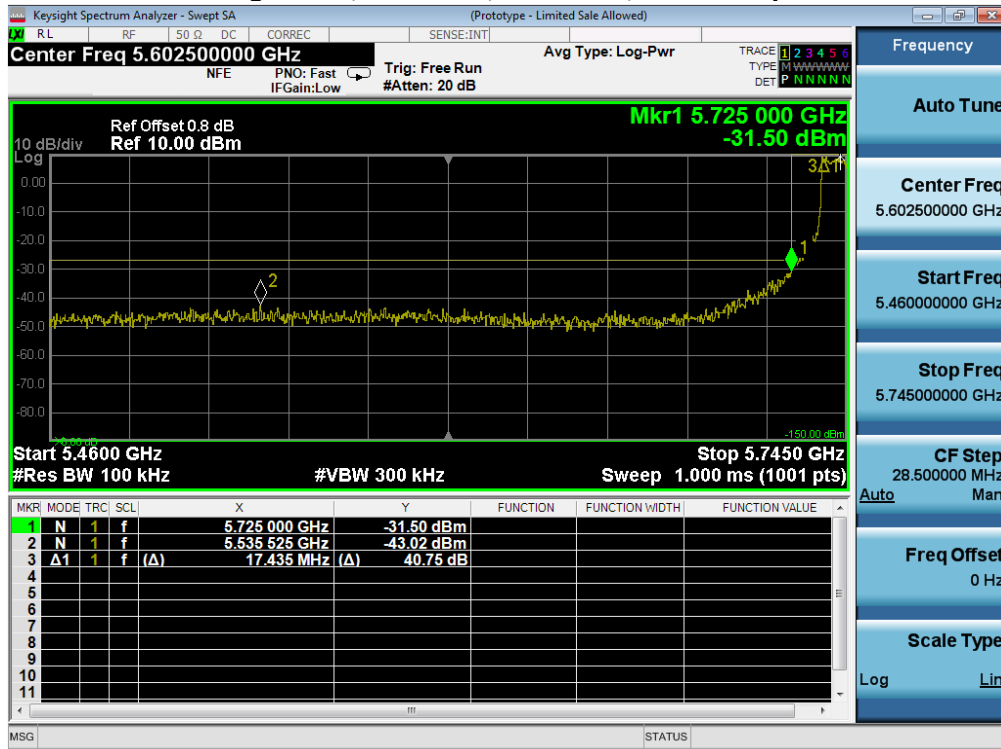

Conducted Bandedge Delta, 5745 MHz, HT/VHT20, M0 to M15

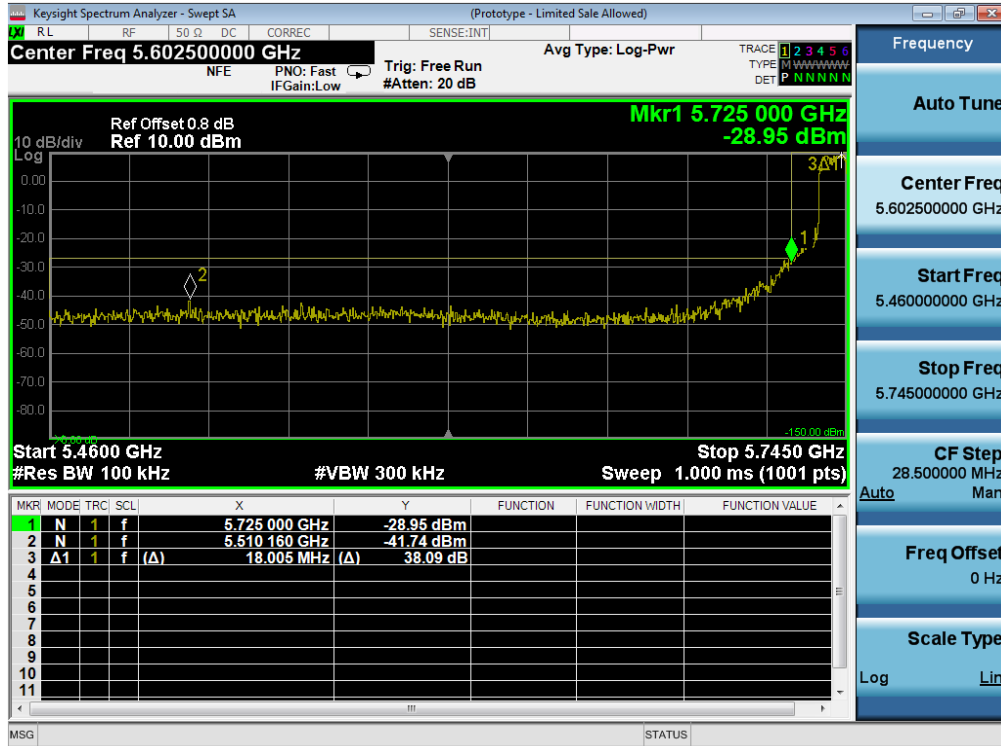



Conducted Bandedge Delta, 5755 MHz, Non HT40, 6 to 54 Mbps

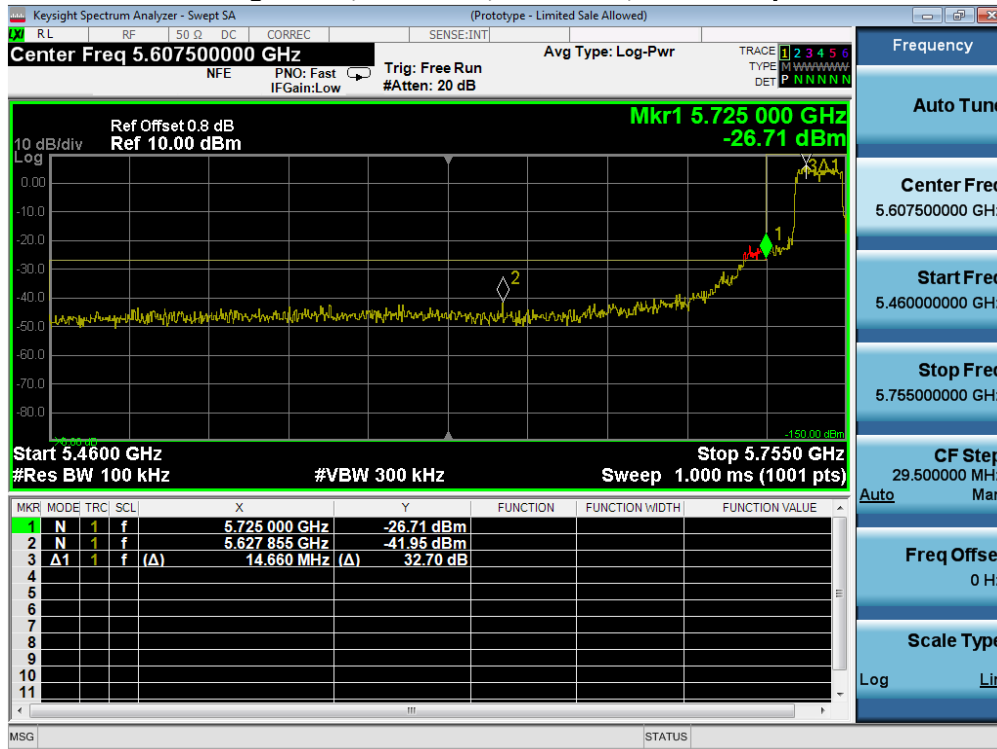

Conducted Bandedge Delta, 5755 MHz, HT/VHT40, M0 to M15

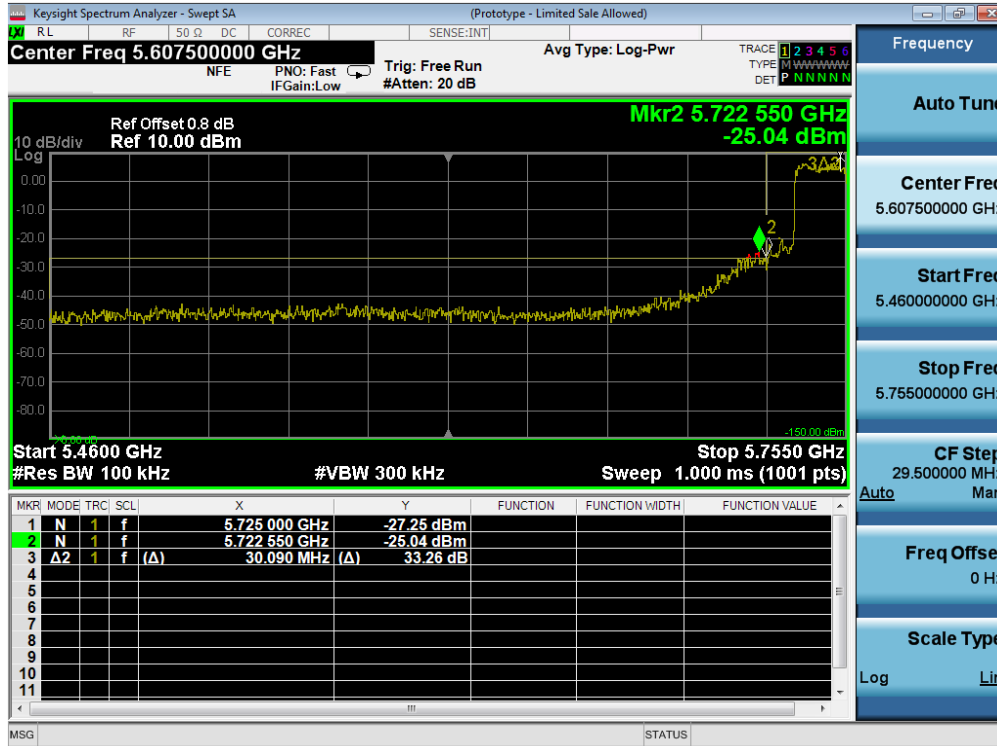

Conducted Bandedge Delta, 5775 MHz, Non HT80, 6 to 54 Mbps

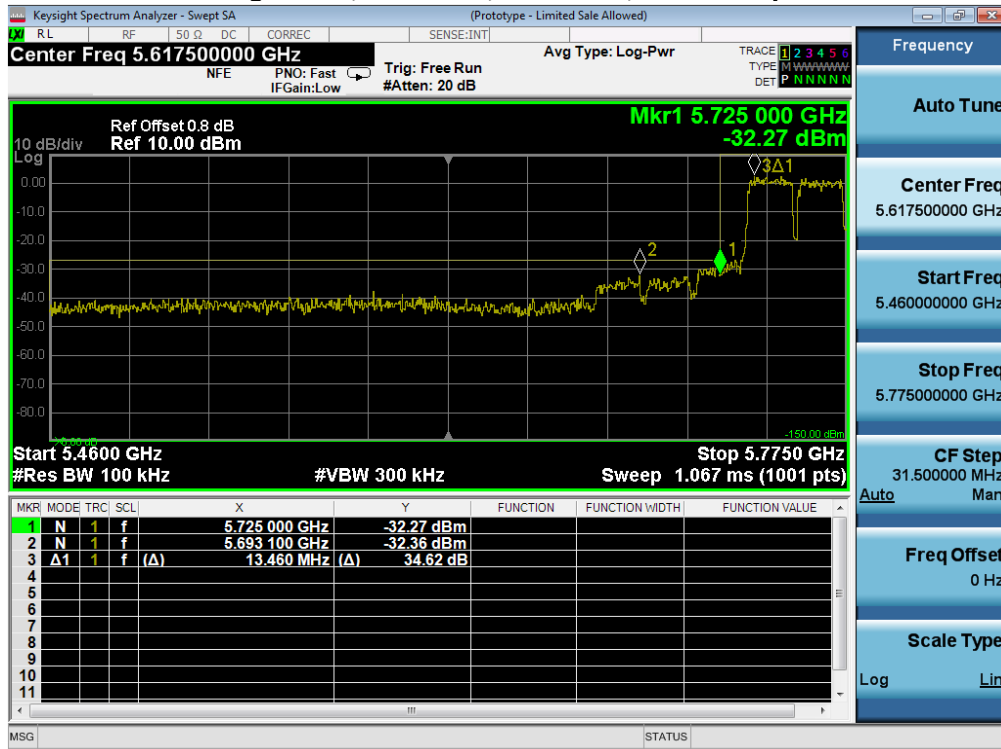

Conducted Bandedge Delta, 5775 MHz, VHT80, M0 to M9, M0 to M9 1-1ss

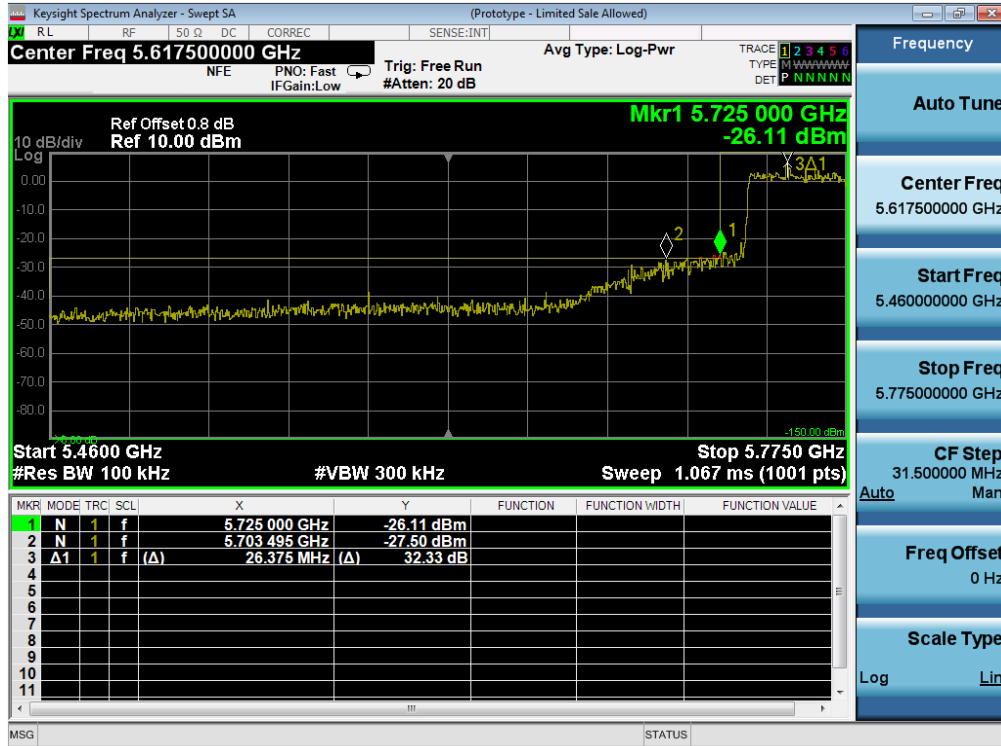

Conducted Bandedge Delta, 5795 MHz, Non HT40, 6 to 54 Mbps

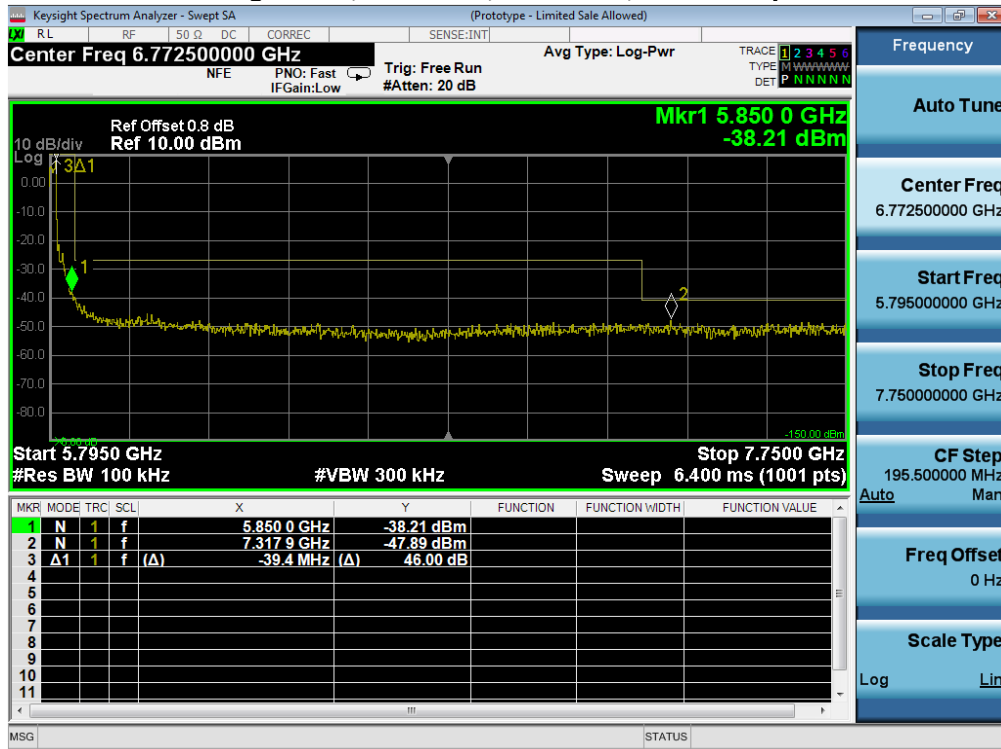

Conducted Bandedge Delta, 5795 MHz, HT/VHT40, M0 to M15

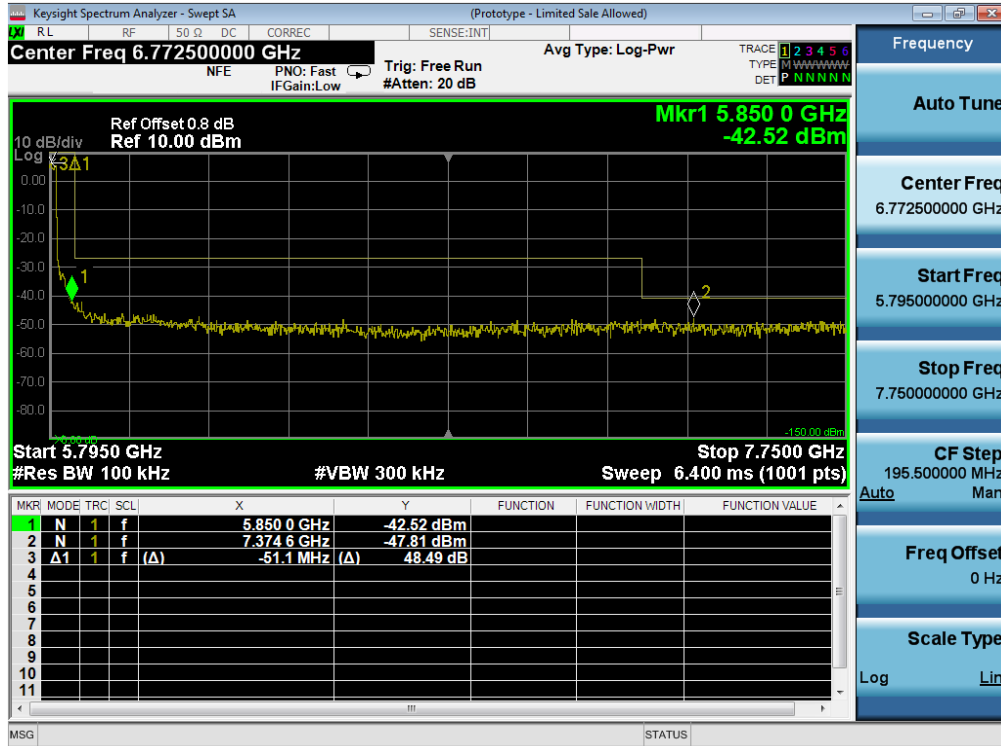

Conducted Bandedge Delta, 5825 MHz, Non HT20, 6 to 54 Mbps

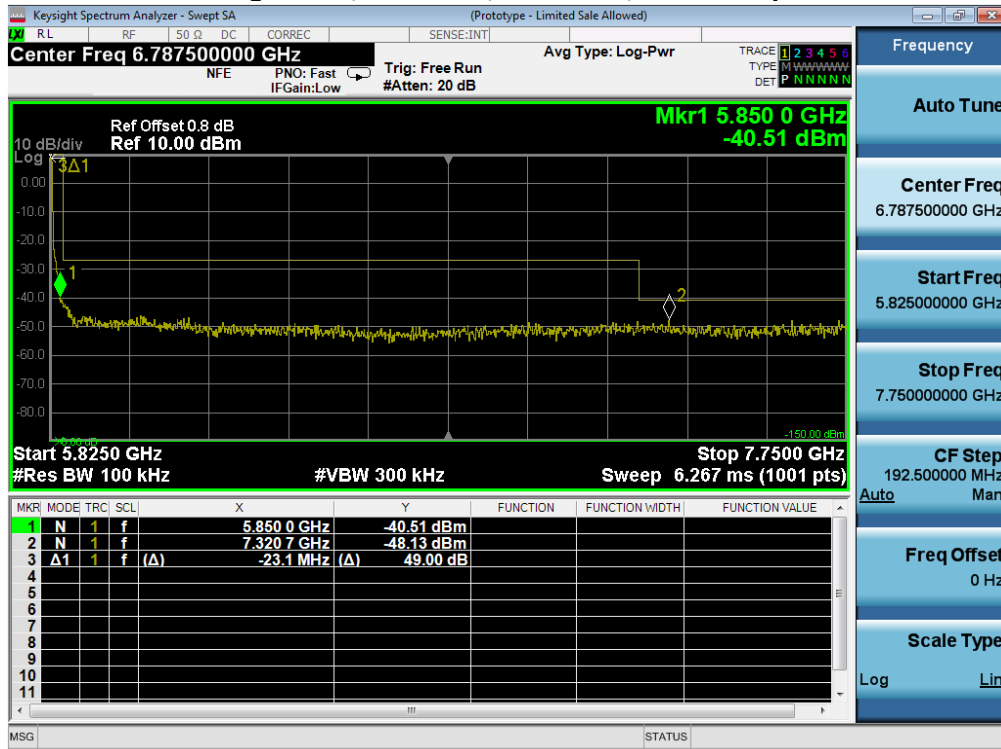

Conducted Bandedge Delta, 5825 MHz, HT/VHT20, M0 to M15

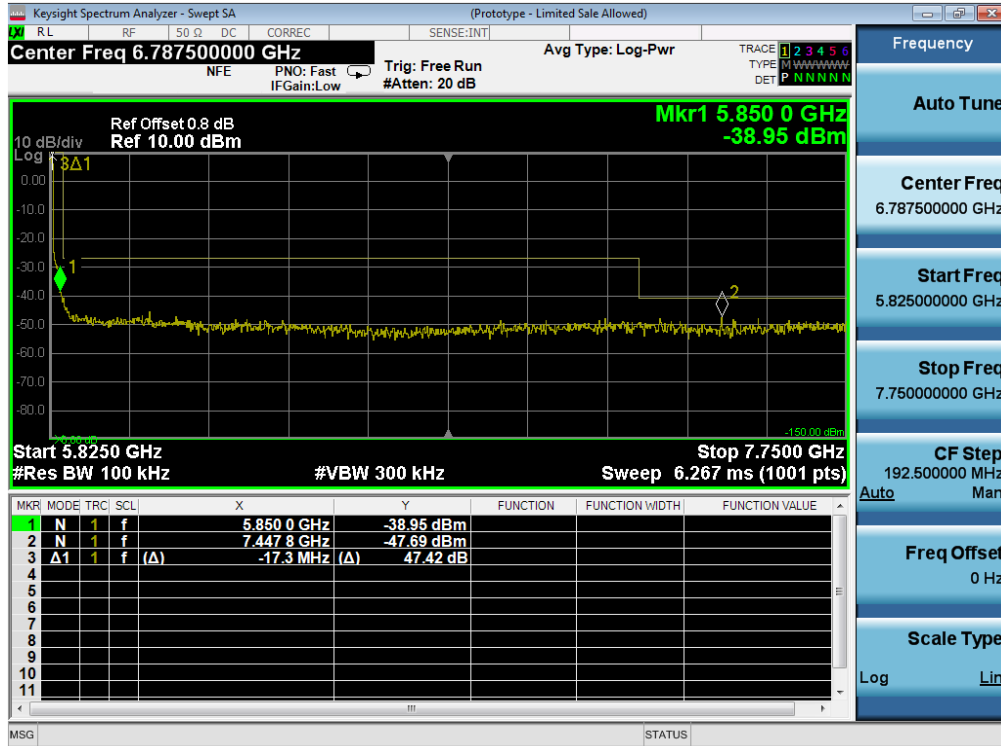



Title: Physical Test Arrangement Photograph

This is a dual band 2.4GHz / 5GHz device. All ports in this test set up photo are connected as all testing is automated. Section 2.6 of this test report given an overview of the different Tx antenna combinations used by this device.

Appendix B: Emission Test Results

Testing Laboratory: Cisco Systems, Inc., 125 West Tasman Drive, San Jose, CA 95134, USA

Radiated Emission Setup Diagram-Below 1G

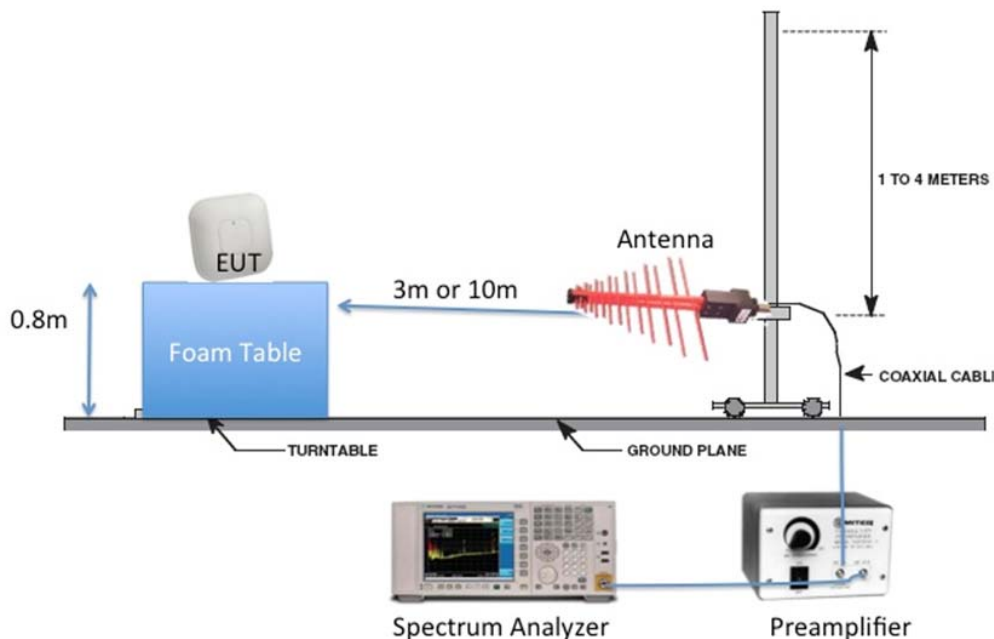

Radiated Emission Setup Diagram-Above 1G

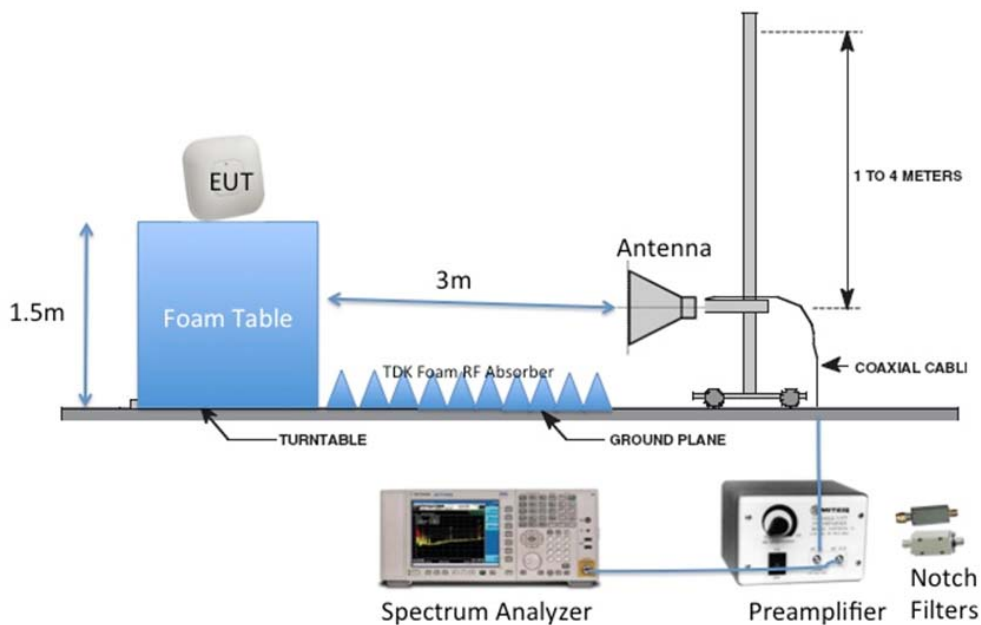



B.1 Radiated Spurious Emissions

15.407 / 15.209 / 15.205 For transmitters operating in the 5.725-5.85 GHz band: All emissions within the frequency range from the band edge to 10 MHz above or below the band edge shall not exceed an e.i.r.p. of -17 dBm/MHz; for frequencies 10 MHz or greater above or below the band edge, emissions shall not exceed an e.i.r.p. of -27 dBm/MHz. Unwanted emissions below 1 GHz must comply with the general field strength limits set forth in 15.209. The provisions of §15.205 apply to intentional radiators operating under this section. When measuring the emission limits, the nominal carrier frequency shall be adjusted as close to the upper and lower frequency band edges as the design of the equipment permits

RSS-GEN Radiated emissions which fall in the restricted bands, as defined in RSS-GEN section 8.10. must also comply with the radiated limits specified in RSS-GEN section 8.9

Ref. ANSI C63.10: 2013 section 12.7.6 (peak) & 12.7.7.3 (average)

Using Vasona, configure the spectrum analyzer as shown below (be sure to enter all losses between the transmitter output and the spectrum analyzer). Place the radio in continuous transmit mode.

Span:	1GHz – 18 GHz/18GHz-26G/26GHz-40GHz
Reference Level:	80 dBuV
Attenuation:	10 dB
Sweep Time:	Coupled
Resolution Bandwidth:	1MHz
Video Bandwidth:	3 MHz for peak, 1 KHz for average
Detector:	Peak

Terminate the access Point RF ports with 50 ohm loads.

Maximize Turntable (find worst case table angle), Maximize Antenna (find worst case height)

Save 2 plots: 1) Average plot (Vertical and Horizontal), Limit= 54dBuV/m @3m
 2) Peak plot (Vertical and Horizontal), Limit = 74dBuV/m @3m

Place a marker at the end of the restricted band closest to the transmit frequency to show compliance. Also measure any emissions in the restricted bands.

This report represents the worst case data for all supported operating modes and antennas. There are no measurable emissions above 18 GHz.

System Number	Description	Samples	System under test	Support equipment
1	EUT	S01	<input checked="" type="checkbox"/>	<input type="checkbox"/>
	Support	S02	<input type="checkbox"/>	<input checked="" type="checkbox"/>

Tested By : Jose Aguirre	Date of testing: 20-April-16 - 08-Aug-16
Test Result : PASS	

See Appendix C for list of test equipment

**B.1.A Transmitter Radiated Spurious Emissions-Average Worst Case**

Frequency (MHz)	Mode	Data Rate (Mbps)	Spurious Emission Level (dBuV/m)	Limit (dBuV/m)	Margin (MHz)
5745	Non HT20, 6 to 54 Mbps	6	50.0	54.0	4.0
5755	HT/VHT40, M0 to M23	m0	50.9	54.0	3.1
5775	VHT80, M0 to M9	m0x1	50.9	54.0	3.1
5785	Non HT20, 6 to 54 Mbps	6	52.1	54.0	1.9
5795	HT/VHT40, M0 to M23	m0	50.9	54.0	3.1
5825	Non HT20, 6 to 54 Mbps	6	53.4	54.0	0.6

Average Radiated Transmitter Spurs, 5745 MHz, Non HT20, 6 to 54 Mbps

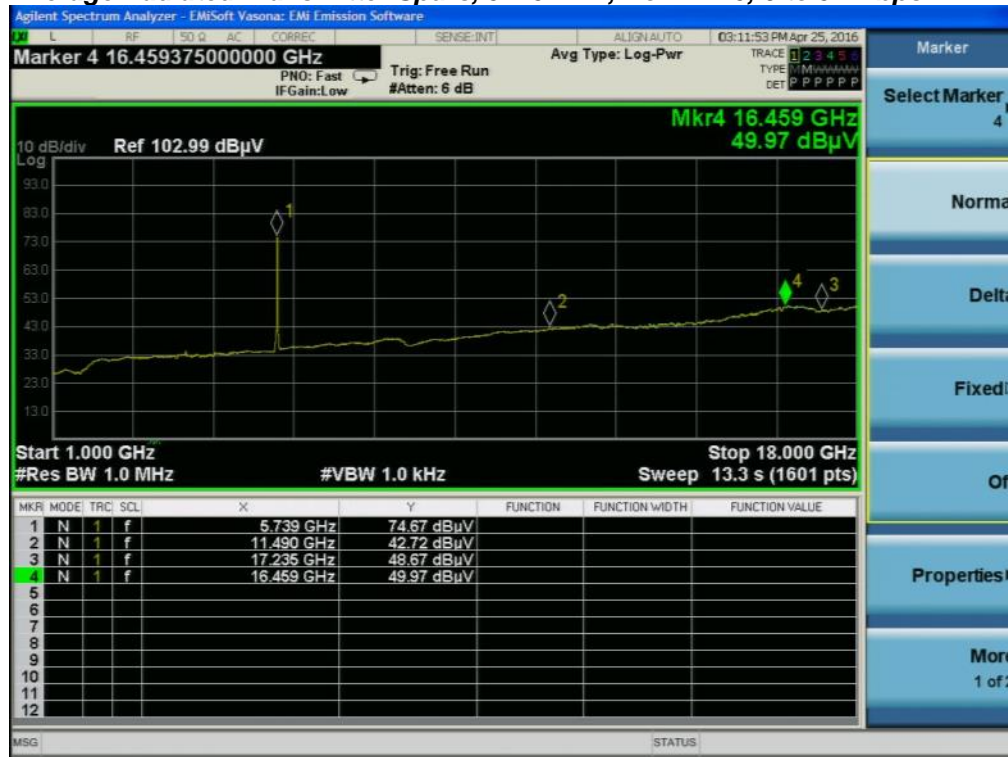

Average Radiated Transmitter Spurs, 5755 MHz, HT/VHT40, M0 to M23

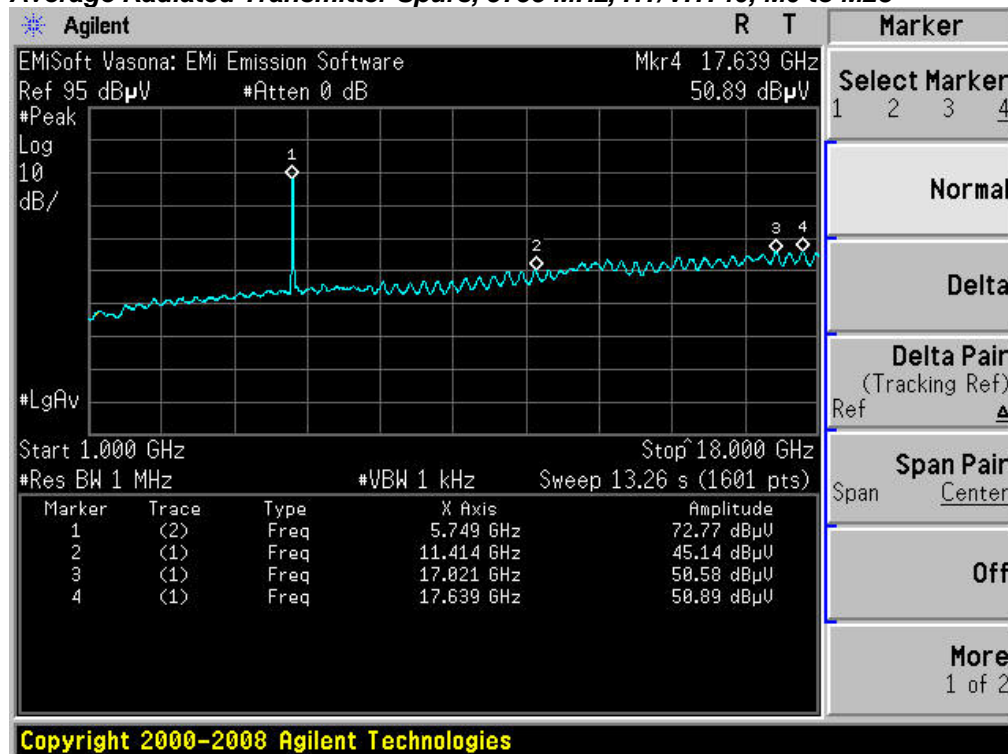

Copyright 2000-2008 Agilent Technologies

Average Radiated Transmitter Spurs, 5775 MHz, VHT80, M0 to M9

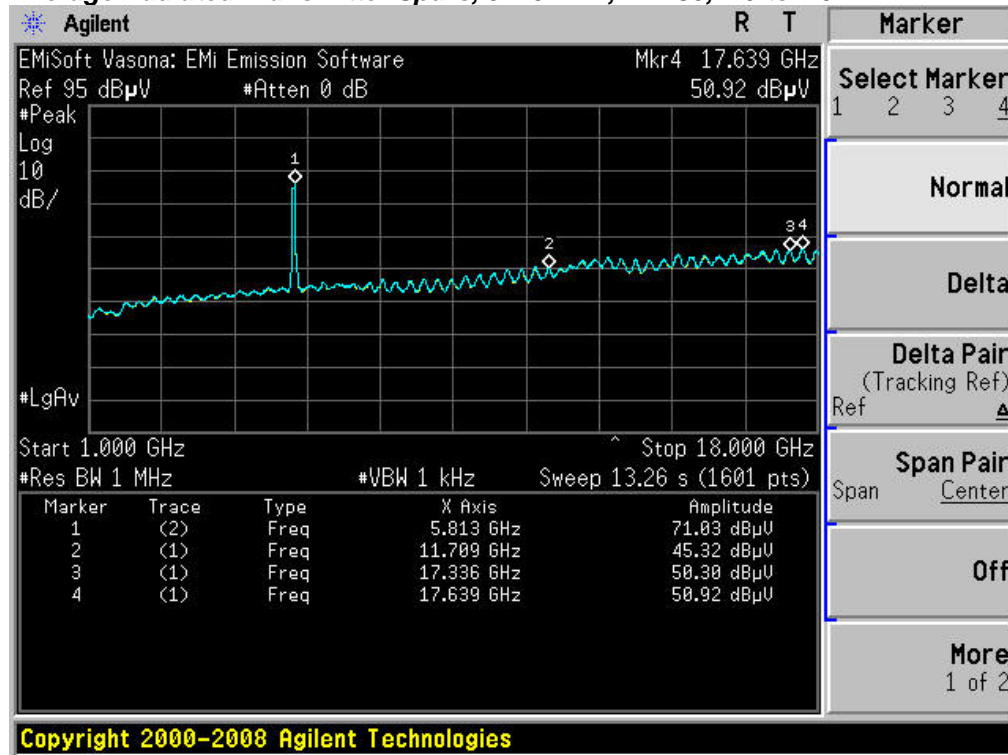

Average Radiated Transmitter Spurs, 5785 MHz, Non HT20, 6 to 54 Mbps

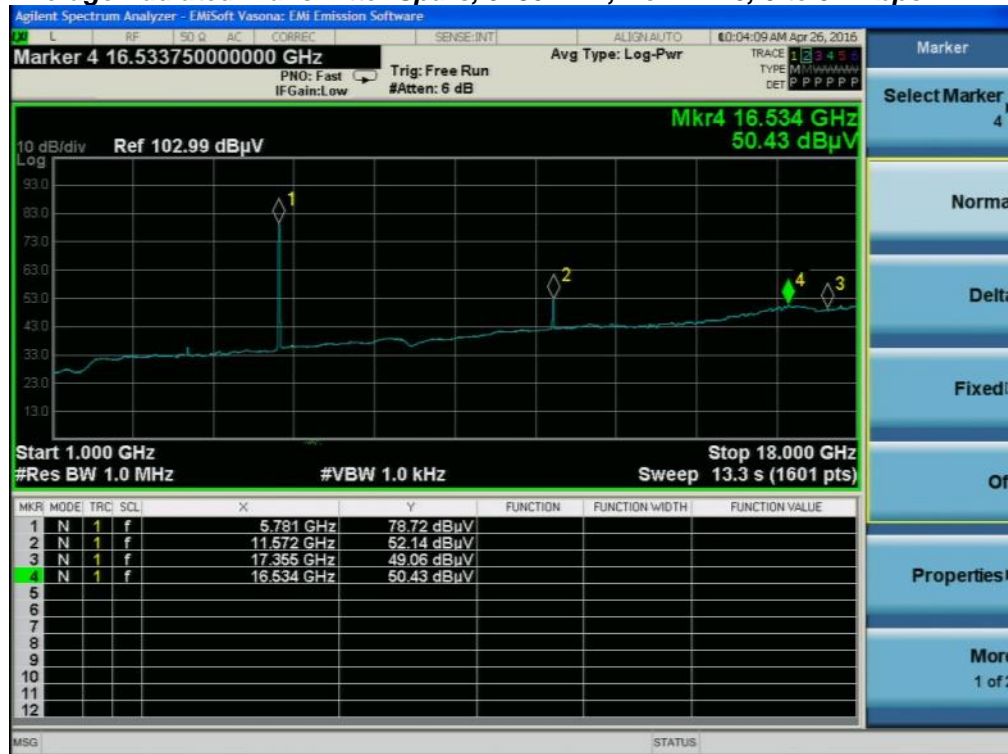

Average Radiated Transmitter Spurs, 5795 MHz, HT/VHT40, M0 to M23

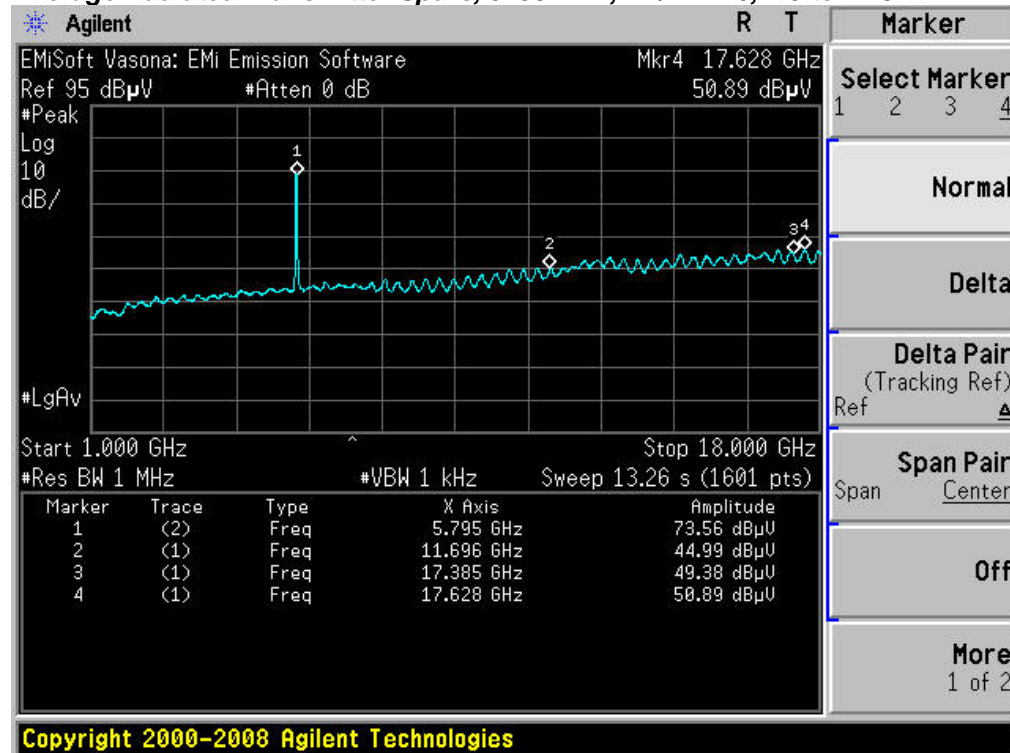

Average Radiated Transmitter Spurs, 5825 MHz, Non HT20, 6 to 54 Mbps





Average Radiated Transmitter Spurs, All modes, All rates, 18-26GHz

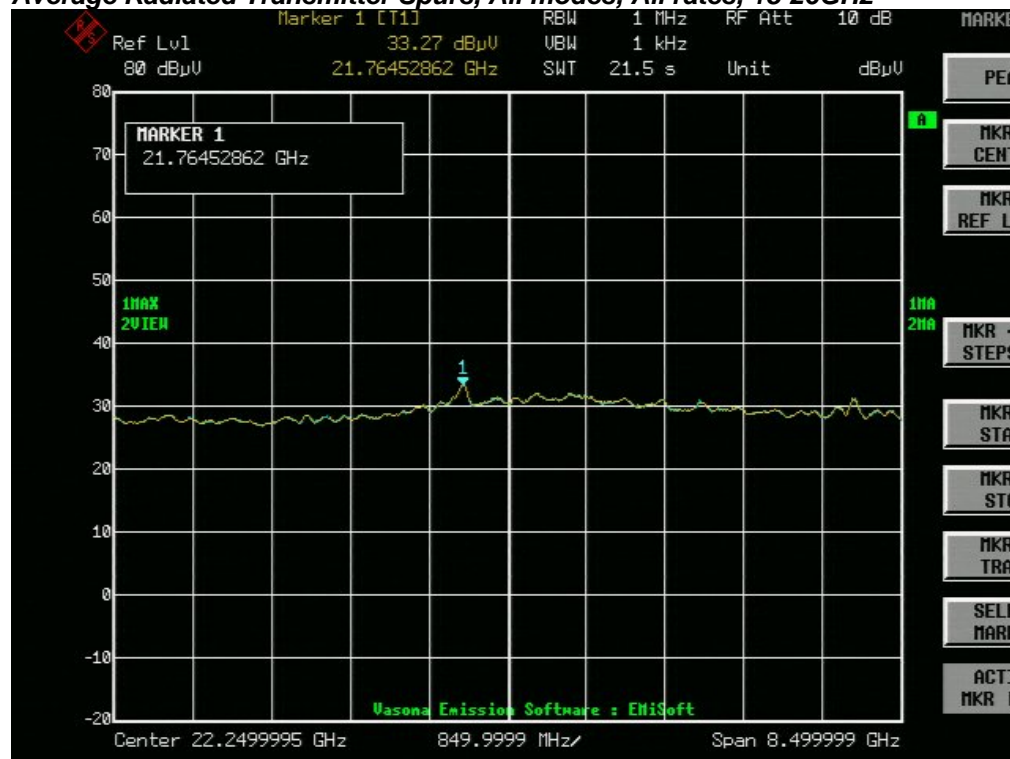

Average Radiated Transmitter Spurs, All modes, All rates, 26-40GHz

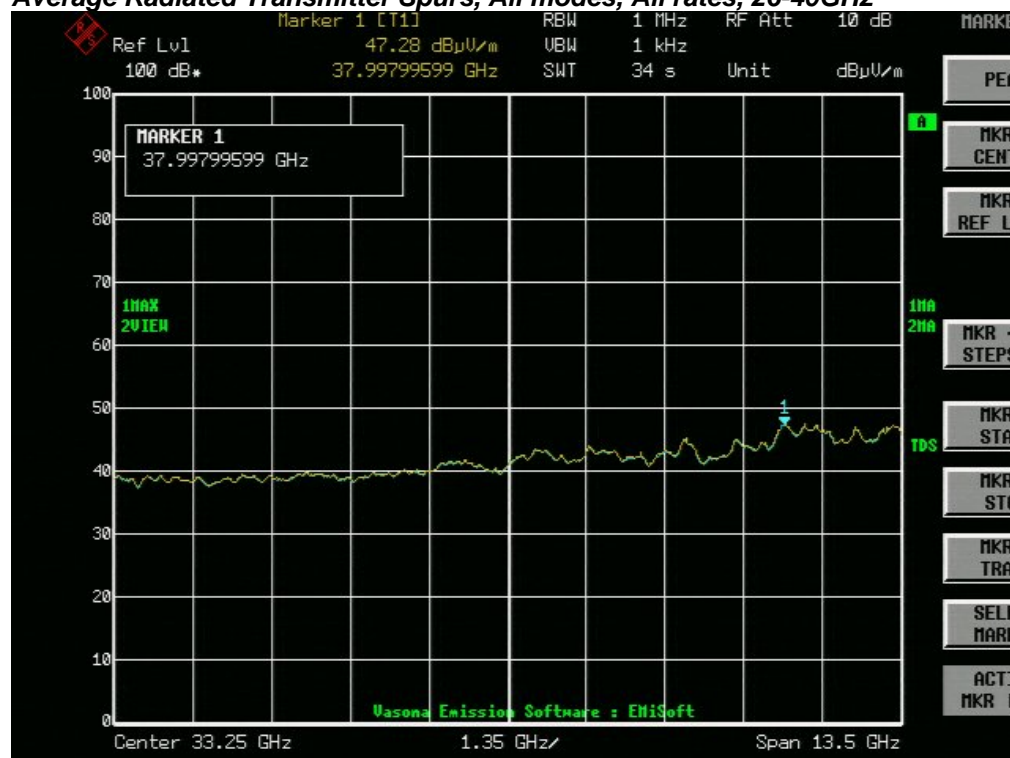

B.1.P Transmitter Radiated Spurious Emissions-Peak Worst Case

Frequency (MHz)	Mode	Data Rate (Mbps)	Spurious Emission Level (dBuV/m)	Limit (dBuV/m)	Margin (MHz)
5745	Non HT20, 6 to 54 Mbps	6	62.3	74.0	11.7
5755	HT/VHT40, M0 to M23	m0	61.3	74.0	12.7
5775	VHT80, M0 to M9	m0x1	62.2	74.0	11.8
5785	Non HT20, 6 to 54 Mbps	6	67.1	74.0	6.9
5795	HT/VHT40, M0 to M23	m0	62.4	74.0	11.6
5825	Non HT20, 6 to 54 Mbps	6	66.9	74.0	7.1

Peak Radiated Transmitter Spurs, 5745 MHz, Non HT20, 6 to 54 Mbps

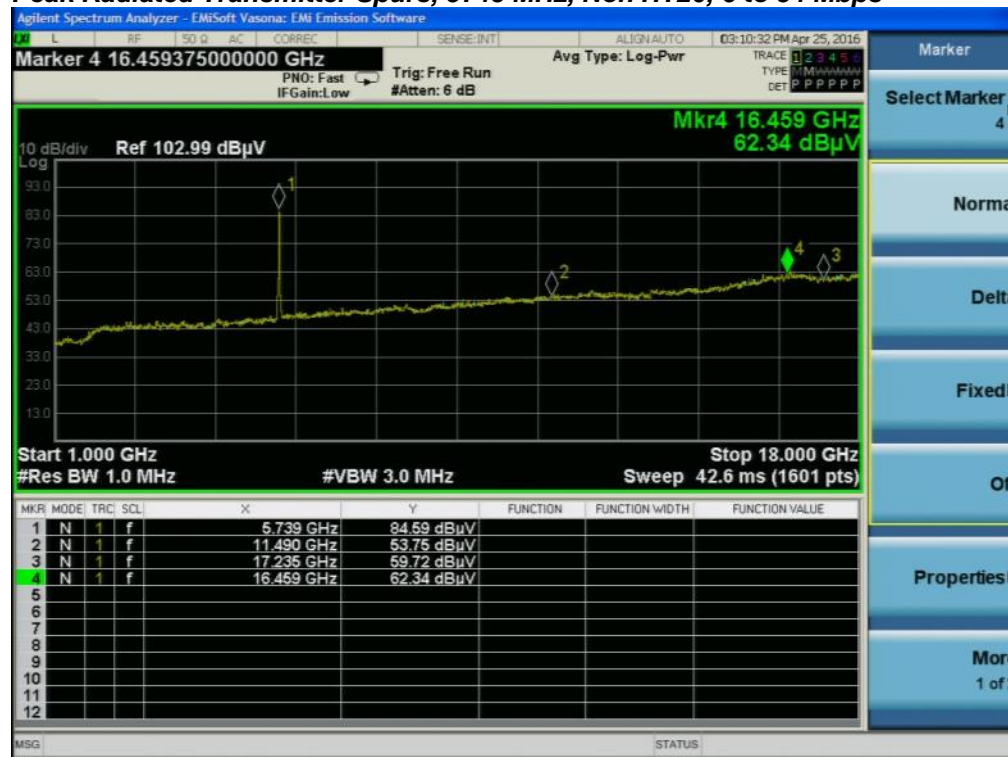

Peak Radiated Transmitter Spurs, 5755 MHz, HT/VHT40, M0 to M23

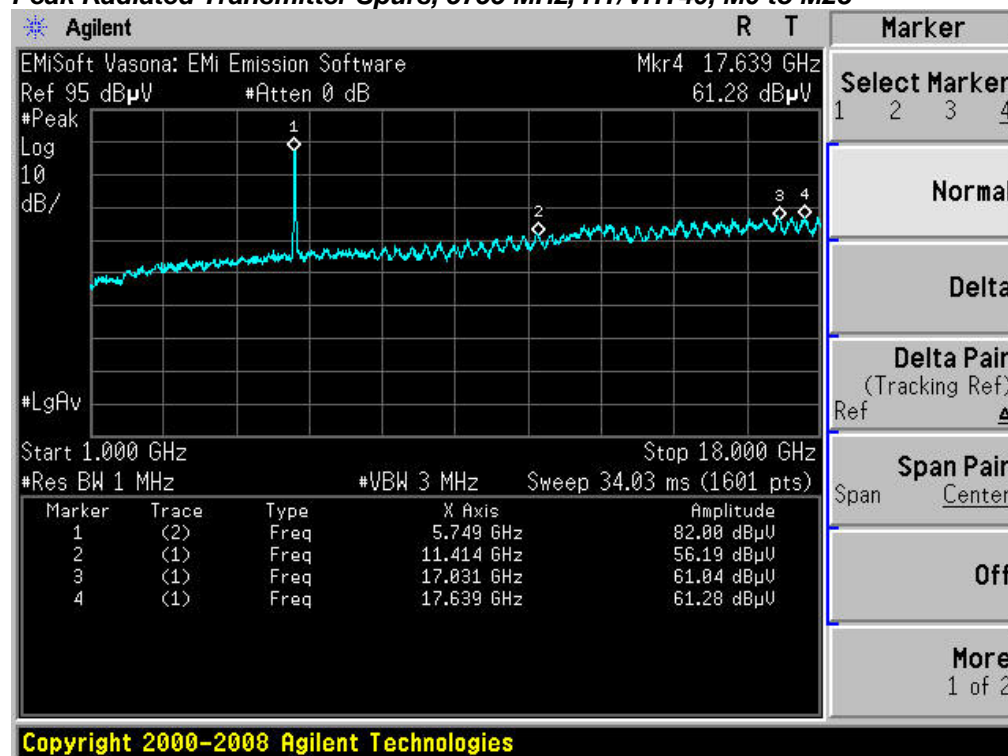

Peak Radiated Transmitter Spurs, 5775 MHz, VHT80, M0 to M9

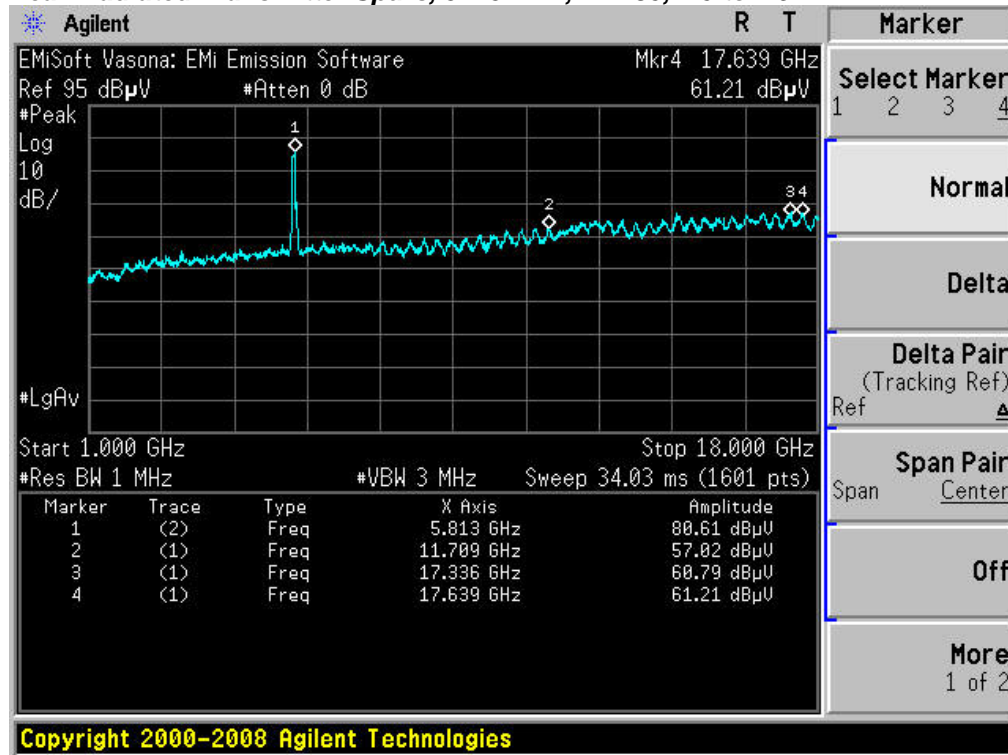

Peak Radiated Transmitter Spurs, 5785 MHz, Non HT20, 6 to 54 Mbps

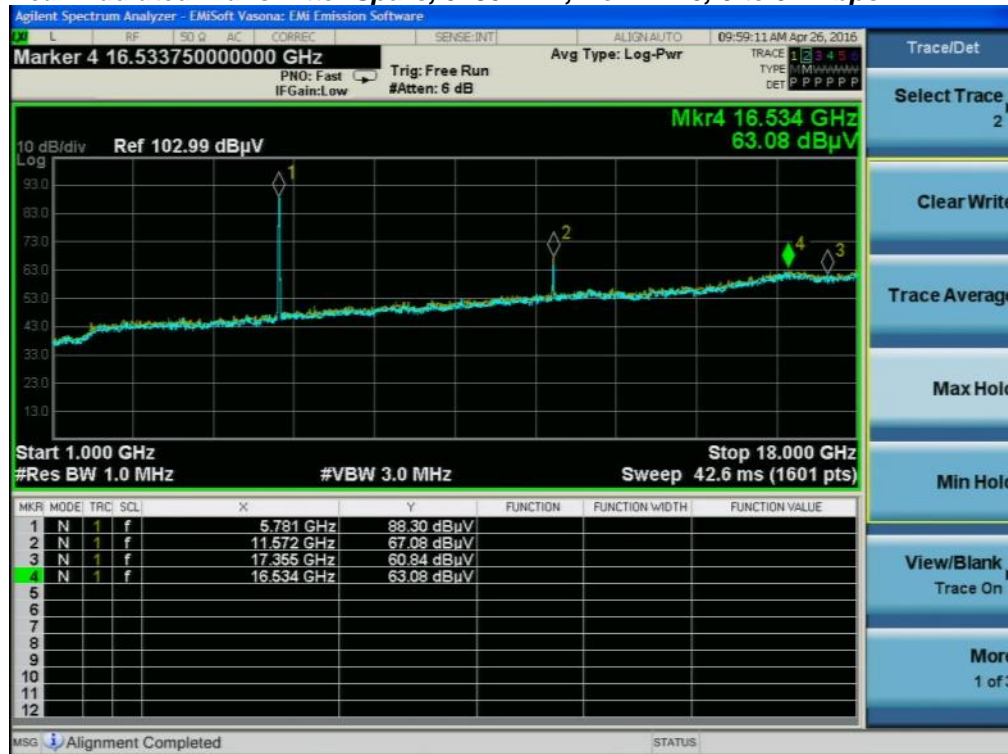

Peak Radiated Transmitter Spurs, 5795 MHz, HT/VHT40, M0 to M23

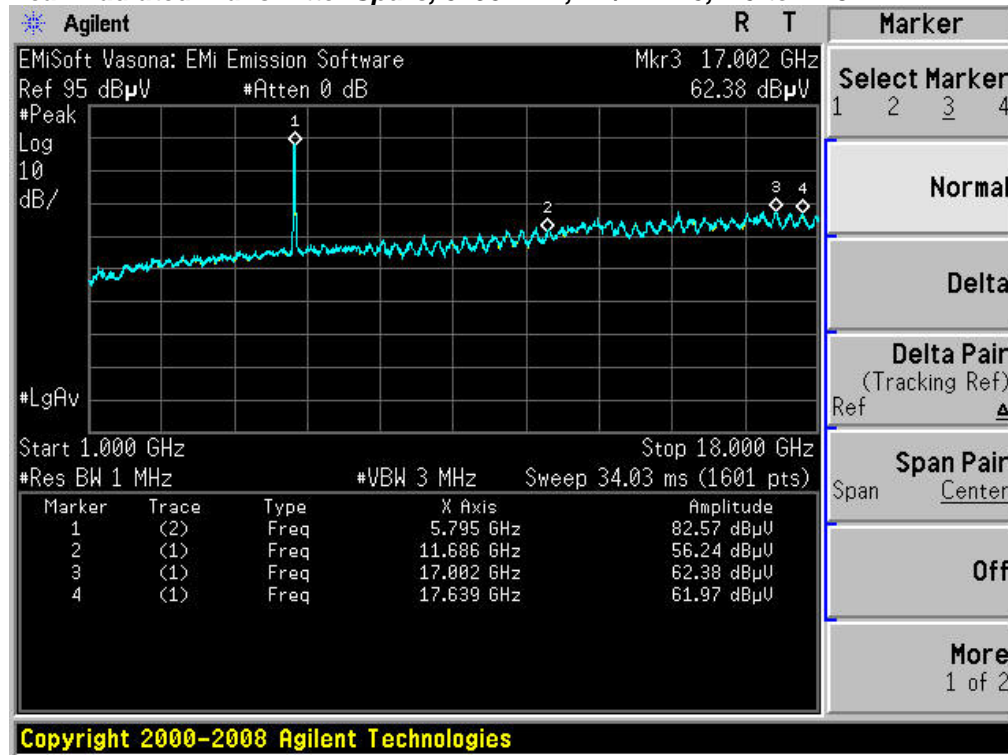

Peak Radiated Transmitter Spurs, 5825 MHz, Non HT20, 6 to 54 Mbps



Peak Radiated Transmitter Spurs, All modes, All rates, 18-26GHz

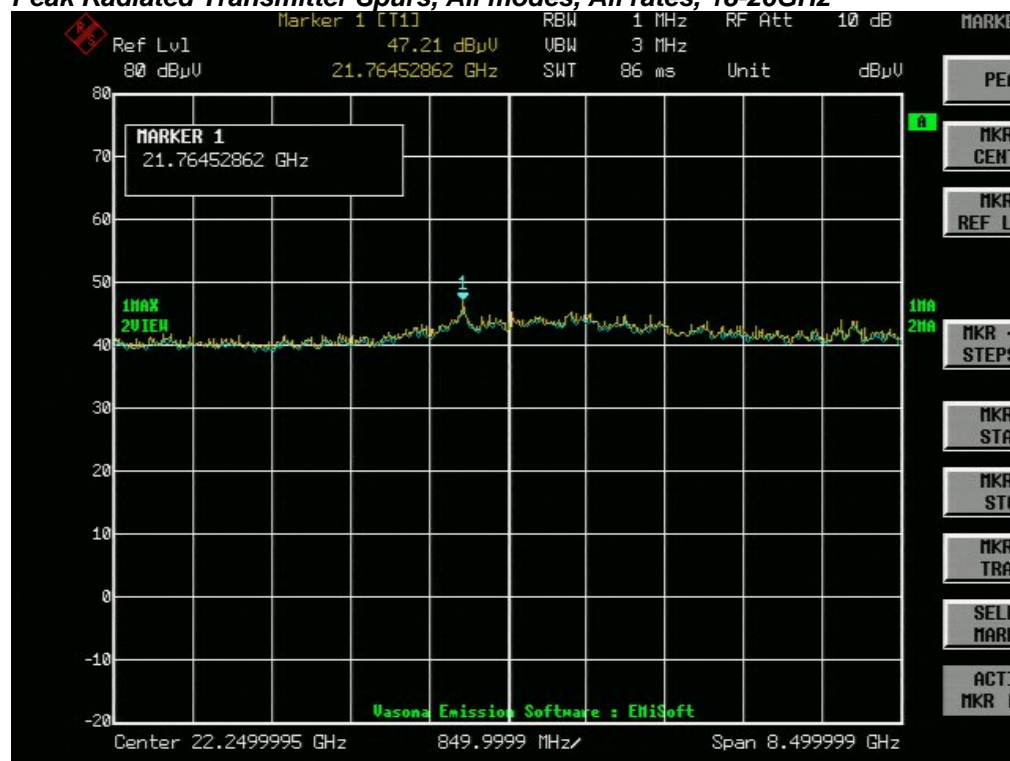

Peak Radiated Transmitter Spurs, All modes, All rates, 26-40GHz

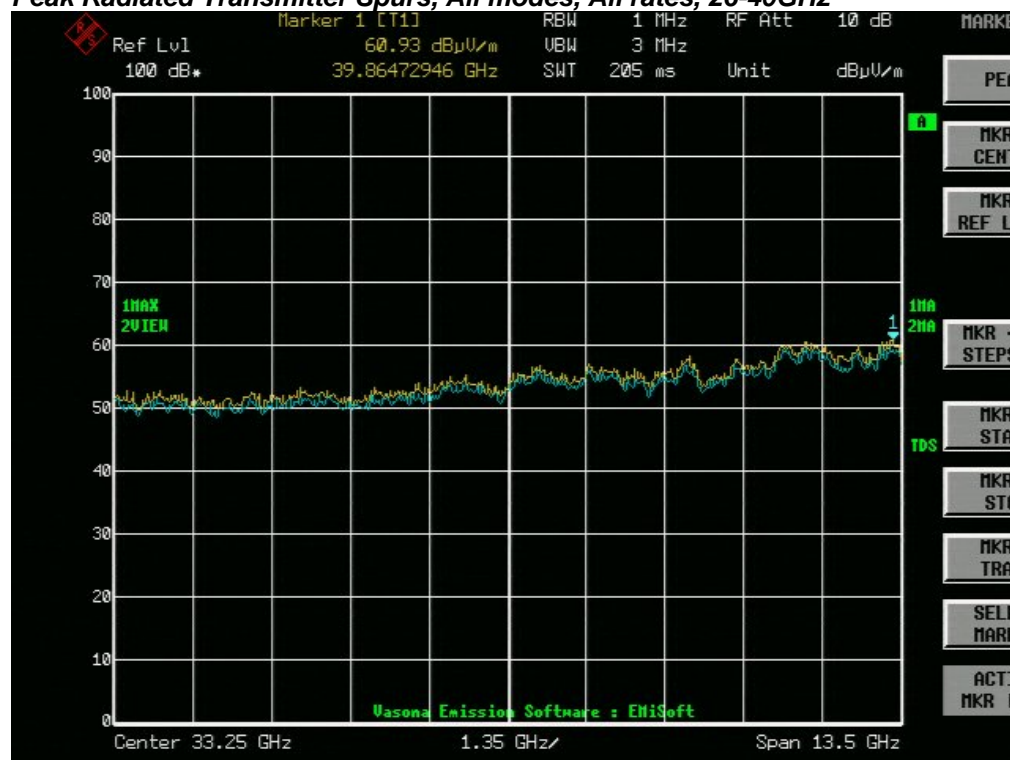



B.2 Receiver Spurious Emissions

RSS-Gen Receivers are required to comply with the limits of spurious emissions as set out in this section. Receiver emission measurements are to be performed as per the normative test method referenced in Section 3.

Radiated emissions which fall in the restricted bands, as defined in RSS-Gen section 8.10, must also comply with the radiated emission limits specified in RSS-Gen section 8.9.

For emissions at frequencies below 1 GHz, measurements shall be performed using a CISPR quasi-peak detector and the related measurement bandwidth. At frequencies above 1 GHz, measurements shall be performed using a linear average detector with a minimum resolution bandwidth of 1 MHz.

Ref. RSS-Gen section 8.9 & 8.10
ANSI C63.10: 2013 section 4.1.4.2.2, 4.1.4.2.3, 6.6.4 & 11.12.2

Using Vasona, configure the spectrum analyzer as shown below (be sure to enter all losses between the transmitter output and the spectrum analyzer). Place the radio in continuous transmit mode.

Span:	1GHz – 18 GHz
Reference Level:	80 dBuV
Attenuation:	10 dB
Sweep Time:	Coupled
Resolution Bandwidth:	1MHz
Video Bandwidth:	3MHz for Peak, 1 kHz for average
Detector:	Peak

Radiated emission measurements shall be performed with the receiver antenna connected to the receiver antenna terminals.

Maximize Turntable (find worst case table angle), Maximize Antenna (find worst case height)

Save plot: 1) Average Plot (Vertical and Horizontal), Limit= 54dBuV/m @3m
2) Peak Plot (Vertical and Horizontal), Limit= 74dBuV/m @3m

This report represents the worst case data for all supported operating modes and antennas. There are no measurable emissions above 18 GHz.

System Number	Description	Samples	System under test	Support equipment
2	EUT	S03	<input checked="" type="checkbox"/>	<input type="checkbox"/>
	Support	S04	<input type="checkbox"/>	<input checked="" type="checkbox"/>

Tested By : Jose Aguirre	Date of testing: 20-April-16 - 08-Aug-16
Test Result : PASS	

See Appendix C for list of test equipment

B.2.A Receiver Radiated Spurious Emissions (Average Measurements)

Average Radiated Receiver Spurs, All modes, All rates, 1-18GHz

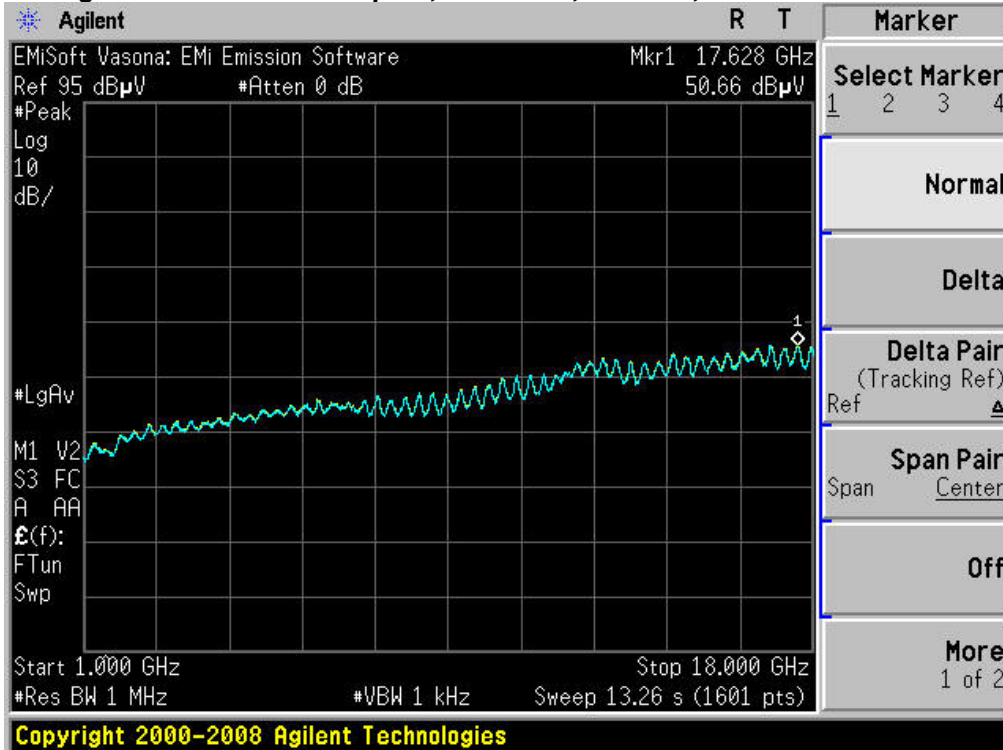

B.2.A Receiver Radiated Spurious Emissions (Peak Measurements)

Peak Radiated Receiver Spurs, All modes, All rates, 1-18GHz

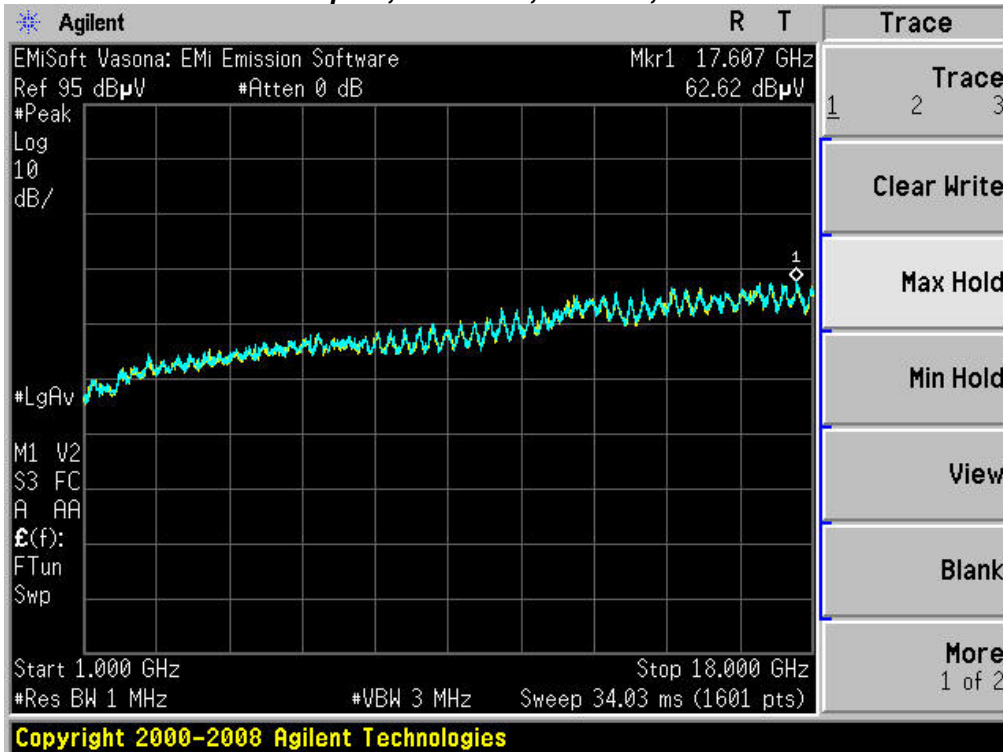



B.3 Radiated Emissions 30MHz to 1GHz

15.205 / 15.209 / RSS-Gen / LP0002:3.10.1(5)/2.8 Radiated emissions which fall in the restricted bands, as defined in Section 15.205(a), must also comply with the radiated emission limits specified in Section 15.209(a) (see Section 15.205(c)) and RSS-Gen section 8.9.

Ref. ANSI C63.10: 2013 section 6.5

Using Vasona, configure the spectrum analyzer as shown below (be sure to enter all losses between the transmitter output and the spectrum analyzer). Place the radio in continuous transmit mode.

Span:	30MHz – 1GHz
Reference Level:	80 dBuV
Attenuation:	10 dB
Sweep Time:	Coupled
Resolution Bandwidth:	100kHz
Video Bandwidth:	300kHz
Detector:	Peak for Pre-scan, Quasi-Peak

Compliance shall be determined using CISPR quasi-peak detection; however, peak detection is permitted as an alternative to quasi-peak detection.

Terminate the access Point RF ports with 50 ohm loads.

Maximize Turntable (find worst case table angle), Maximize Antenna (find worst case height)

This report represents the worst case data for all supported operating modes and antennas.

System Number	Description	Samples	System under test	Support equipment
2	EUT	S03	<input checked="" type="checkbox"/>	<input type="checkbox"/>
	Support	S04	<input type="checkbox"/>	<input checked="" type="checkbox"/>

Tested By : Jose Aguirre	Date of testing: 20-April-16 - 08-Aug-16
Test Result : PASS	

See Appendix C for list of test equipment

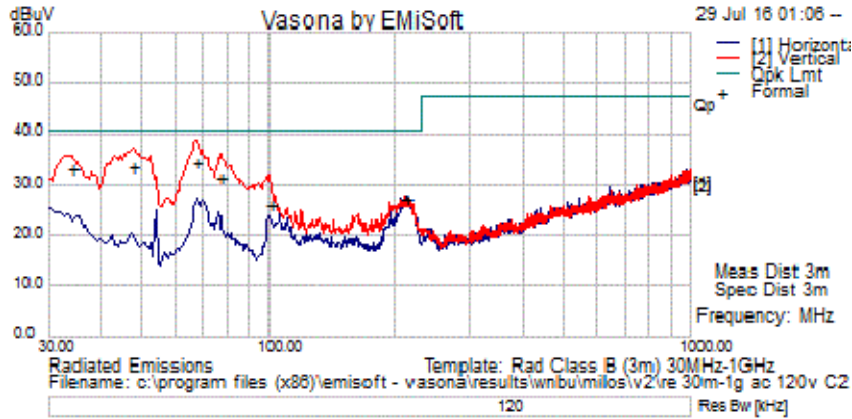

Test Results Table

Frequency (MHz)	Raw (dBuV)	Cable Loss	AF (dB)	Level (dBuV/m)	Measurement Type	Poi	Hgt (cm)	Azt (Deg)	Limit (dBuV/m)	Margin (dB)	Pass/Fail	Comments
34.24375	14.29	0.69	17.95	32.93	Quasi Max	H	105	12	40.50	-7.57	Pass	
47.58125	24.03	0.80	8.83	33.66	Quasi Max	H	113	36	40.50	-6.84	Pass	
212.48125	14.97	1.77	10.50	27.24	Quasi Max	V	117	182	40.50	-13.26	Pass	
100.325	14.43	1.20	10.39	26.02	Quasi Max	H	233	244	40.50	-14.48	Pass	
66.98125	25.03	1.00	8.26	34.29	Quasi Max	H	113	292	40.50	-6.21	Pass	
76.68125	22.45	1.06	8.19	31.70	Quasi Max	H	128	344	40.50	-8.80	Pass	

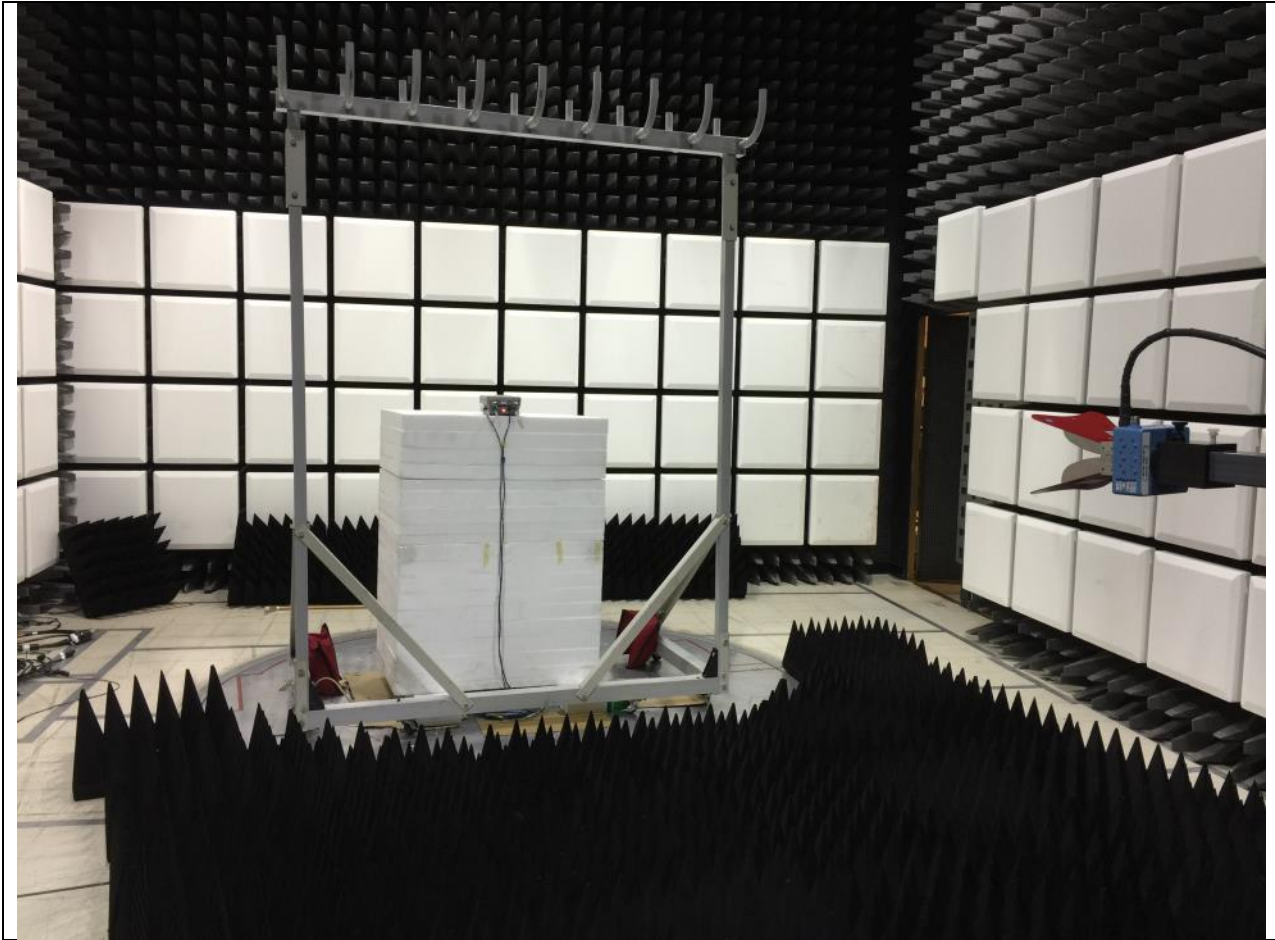

Title: Radiated Emissions Configuration Photograph

B.4 AC Conducted Emissions

FCC 15.207 (a) & RSS-Gen 8.8 / LP0002:2.3 Except when the requirements applicable to a given device state otherwise, for any radio apparatus equipped to operate from the public utility AC power supply, either directly or indirectly (such as with a battery charger), the radio frequency voltage of emissions conducted back onto the AC power lines in the frequency range of 0.15 MHz to 30 MHz shall not exceed the limits shown in the table in these sections. The more stringent limit applies at the frequency range boundaries.

Measurement Procedure

Accordance with ANSI C63.10:2013 section 6.2

Using Vasona, configure the spectrum analyzer as shown below (be sure to enter all losses between the transmitter output and the spectrum analyzer). Place the radio in continuous transmit mode.

Span:	150 KHz – 30 MHz
Attenuation:	10 dB
Sweep Time:	Coupled
Resolution Bandwidth:	9 KHz
Video Bandwidth:	30 KHz
Detector:	Quasi-Peak / Average

System Number	Description	Samples	System under test	Support equipment
2	EUT	S03	<input checked="" type="checkbox"/>	<input type="checkbox"/>
	Support	S04	<input type="checkbox"/>	<input checked="" type="checkbox"/>

Tested By : Jose Aguirre	Date of testing: 20-April-16 - 08-Aug-16
Test Result : PASS	

See separate EMC test report for test data.

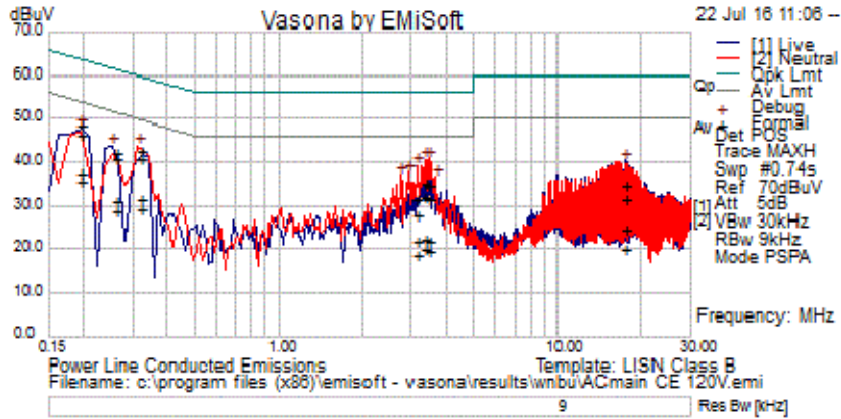

Test Results Table

Frequency (MHz)	Raw (dBuV)	Cable Loss	Factors (dB)	Level (dBuV/m)	Measurement Type	Line	Limit (dBuV/m)	Margin (dB)	Pass/Fail	Comments
.318	22.63	20.28	0.04	42.96	Quasi Peak	Live	59.76	-16.80	Pass	
3.446	14.92	19.99	0.05	34.95	Quasi Peak	Live	56.00	-21.05	Pass	
3.135	11.83	19.98	0.06	31.86	Quasi Peak	Live	56.00	-24.14	Pass	
.195	27.83	20.78	0.05	48.66	Quasi Peak	Live	63.82	-15.16	Pass	
17.358	14.25	20.33	0.19	34.77	Quasi Peak	Live	60.00	-25.23	Pass	
3.350	15.24	19.98	0.05	35.27	Quasi Peak	Live	56.00	-20.73	Pass	
.261	21.84	20.48	0.04	42.36	Quasi Peak	Live	61.40	-19.04	Pass	
3.446	11.71	19.99	0.05	31.75	Quasi Peak	Neutral	56.00	-24.25	Pass	
.195	25.78	20.78	0.05	46.61	Quasi Peak	Neutral	63.82	-17.21	Pass	
3.350	11.97	19.98	0.05	32.01	Quasi Peak	Neutral	56.00	-23.99	Pass	
3.135	8.12	19.98	0.06	28.16	Quasi Peak	Neutral	56.00	-27.84	Pass	
.261	20.21	20.48	0.04	40.73	Quasi Peak	Neutral	61.40	-20.67	Pass	
17.358	4.23	20.33	0.19	24.75	Quasi Peak	Neutral	60.00	-35.25	Pass	
.318	20.63	20.28	0.04	40.95	Quasi Peak	Neutral	59.76	-18.81	Pass	
.318	11.54	20.28	0.04	31.87	Average	Live	49.76	-17.89	Pass	
3.446	1.77	19.99	0.05	21.81	Average	Live	46.00	-24.19	Pass	
3.135	1.82	19.98	0.06	21.86	Average	Live	46.00	-24.14	Pass	
.195	17.05	20.78	0.05	37.87	Average	Live	53.82	-15.95	Pass	
17.358	11.08	20.33	0.19	31.59	Average	Live	50.00	-18.41	Pass	
3.350	2.45	19.98	0.05	22.49	Average	Live	46.00	-23.51	Pass	
.261	10.69	20.48	0.04	31.21	Average	Live	51.40	-20.19	Pass	
3.446	-0.15	19.99	0.05	19.89	Average	Neutral	46.00	-26.11	Pass	
.195	14.85	20.78	0.05	35.68	Average	Neutral	53.82	-18.14	Pass	
3.350	0.12	19.98	0.05	20.16	Average	Neutral	46.00	-25.84	Pass	
3.135	-1.39	19.98	0.06	18.64	Average	Neutral	46.00	-27.36	Pass	
.261	8.30	20.48	0.04	28.82	Average	Neutral	51.40	-22.58	Pass	



Frequency (MHz)	Raw (dBuV)	Cable Loss	Factors (dB)	Level (dBuV/m)	Measurement Type	Line	Limit (dBuV/m)	Margin (dB)	Pass/Fail	Comments
17.358	-0.50	20.33	0.19	20.02	Average	Neutral	50.00	-29.98	Pass	
.318	9.08	20.28	0.04	29.41	Average	Neutral	49.76	-20.35	Pass	



Title: Conducted Emissions Configuration Photograph

Appendix C: List of Test Equipment Used to perform the test

Test Equipment used for Radiated Emissions					
Equip#	Manufacturer/ Model	Description	Last Cal	Next Cal	Test Item
CIS051796	TTA1800-30-HG Miteq	SMA 18 GHz Pre-Amplifier	29-Sep-15	29-Sep-16	B.1, B.2
CIS035285	3117 ETS-Lindgren	Double Ridged Waveguide Horn Antenna	30-Sep-15	30-Sep-16	B.1, B.2
CIS008447	NSA 10m Chamber Cisco	NSA 10m Chamber	14-Oct-15	14-Oct-16	B.3
CIS045096	TH0118 Cisco	Mast Mount Preamplifier Array, 1-18GHz	4-Nov-15	4-Nov-16	B.1, B.2
CIS030652	JB1 Sunol Sciences	Combination Antenna, 30MHz-2GHz	4-Dec-15	4-Dec-16	B.3
CIS041929	iBTHP-5-DB9 Newport	5 inch Temp/RH/Press Sensor w/20ft cable	22-Dec-15	22-Dec-16	B.1, B.2, B.3
CIS043124	Above 1GHz Site Cal Cisco	Above 1GHz Cispr Site Verification	14-Jan-16	14-Jan-17	B.1, B.2
CIS047300	N9038A Agilent Technologies	MXE EMI Receiver 20Hz to 26.5 Ghz	28-Jan-16	28-Jan-17	B.1, B.2, B.3
CIS051642	Sucoflex 106PA Huber+Suhner	RF N Type Cable 8.5m	11-Feb-16	11-Feb-17	B.1, B.2, B.3
CIS030559	UFB311A-1-0950-504504 Micro-Coax	RF Coaxial Cable, to 18GHz, 95 in	15-Feb-16	15-Feb-17	B.1, B.2, B.3
CIS020975	UFB311A-0-1344-520520 Micro-Coax	RF Coaxial Cable, to 18GHz, 134.4 in	17-Feb-16	17-Feb-17	B.1, B.2, B.3
CIS051708	UFB293C-2-0840-300504 Micro-Coax	RF Coaxial SMA-N Type Cable	28-Jun-16	28-Jun-17	B.1, B.2, B.3
CIS044940	ESU40 Rohde & Schwarz	EMI Test Receiver, 20Hz-40GHz	2-Nov-15	2-Nov-16	B.1, B.2
CIS034075	RSG 2000 Schaffner	Reference Spectrum Generator, 1-18GHz	Cal Not Required		
CIS041979	1840 Cisco	18-40GHz EMI Test Head/ Verification Fixture	13-Jul-15	13-Jul-16	B.1, B.2
CIS044940	ESU40 Rohde & Schwarz	EMI Test Receiver, 20Hz-40GHz	2-Nov-15	2-Nov-16	B.1, B.2,
CIS030652	JB1 Sunol Sciences	Combination Antenna, 30MHz-2GHz	4-Dec-15	4-Dec-16	B.3
CIS003003	83731B HP	Synthesized Signal Generator	29-Jan-16	29-Jan-17	B.1, B.2
CIS037236	50CB-015 JFW	GPIB Control Box			B.1, B.2

Test Equipment used for AC Mains Conducted Emissions

Equip#	Manufacturer/ Model	Description	Last Cal	Next Cal	Test Item
8510	Fischer Custom Communications FCC-450B-2.4-N	Instrumentation Limiter	5/16/16	5/16/17	B.4
23802	Fischer Custom Communications FCC-801-M2-50A	CDN, 2-LINE 50A	1/12/16	1/12/17	B.4
45995	Fischer Custom Communications F-090527-1009-2	Lisn Adapter	6/17/16	6/17/17	B.4
49468	Coleman RG223	BNC 25 ft Cable	3/9/16	3/9/17	B.4
31918	Midwest Microwave TRM-2048-MC-BNC-10	50 Ohm, 5W Terminator, Type BNC	11/9/15	11/9/16	B.4
49531	TTE H785-150K-50-21378	High Pass Filter	5/3/16	5/3/17	B.4
45994	Fischer Custom Communications F-090527-1009-1	Line Impedance Stabilization Network	6/17/16	6/17/17	B.4
18963	York CNE V	Comparison Noise Emitter, 30 - 1000MHz	Cal Not Required	Cal Not Required	B.4
45050	Rohde & Schwarz ESCI	EMI Test Receiver	11/3/15	11/3/16	B.4
51721	Teseq CDN ST08A	Coupling Decoupling Network	6/7/16	6/7/17	B.4
54231	Newport iBTHP-5-DB9	5 inch Temp/RH/Press Sensor w/20ft cable	2/10/16	2/10/17	B.4

Test Equipment used for RF Conducted Tests

Equip#	Manufacturer/ Model	Description	Last Cal	Next Cal	Test Item
CIS054666	RA08-S1S1-18 MegaPhase	SMA 18" Cable	25-Sep-15	25-Sep-16	A1 thru A7
CIS054667	RA08-S1S1-18 MegaPhase	SMA 18" Cable	25-Sep-15	25-Sep-16	A1 thru A7
CIS054668	RA08-S1S1-18 MegaPhase	SMA 18" Cable	25-Sep-15	25-Sep-16	A1 thru A7
CIS054669	RA08-S1S1-18 MegaPhase	SMA 18" Cable	25-Sep-15	25-Sep-16	A1 thru A7
CIS054686	NI PXI-2796 National Instruments	Plug-in switch module	6-Oct-15	6-Oct-16	A1 thru A7
CIS055166	RFLT4WDC40GK RF Lambda	4 Way Power Divider 40GHz	23-Nov-15	23-Nov-16	A1 thru A7
CIS054662	RFLT4WDC40GK RF Lambda	SMA 36" cable	24-Sep-15	24-Sep-16	A1 thru A7
CIS054656	BRC50705-02 Micro-Tronics	Band Reject Filter	24-Sep-15	24-Sep-16	A1 thru A7
CIS054655	BRC50704-02 Micro-Tronics	Notch Filter, SB:5.470-5.725GHz, to 12GHz	24-Sep-15	24-Sep-16	A1 thru A7
CIS054654	BRC50703-02	Notch Filter,	24-Sep-15	24-Sep-16	A1 thru A7

	Micro-Tronics	SB:5.150-5.350GHz, to 11GHz			
CIS054653	BRM50702-02 Micro-Tronics	Notch Filter, SB:2.400-2.500GHz, to 18GHz	24-Sep-15	24-Sep-16	A1 thru A7
CIS054678	RA08-S1S1-12 MegaPhase	SMA 12" Cable	25-Sep-15	25-Sep-16	A1 thru A7
CIS054677	RA08-S1S1-12 MegaPhase	SMA 12" Cable	25-Sep-15	25-Sep-16	A1 thru A7
CIS054676	RA08-S1S1-12 MegaPhase	SMA 12" Cable	25-Sep-15	25-Sep-16	A1 thru A7
CIS054675	RA08-S1S1-12 MegaPhase	SMA 12" Cable	25-Sep-15	25-Sep-16	A1 thru A7
CIS054674	RA08-S1S1-12 MegaPhase	SMA 12" Cable	25-Sep-15	25-Sep-16	A1 thru A7
CIS054673	RA08-S1S1-12 MegaPhase	SMA 12" Cable	25-Sep-15	25-Sep-16	A1 thru A7
CIS054672	RA08-S1S1-12 MegaPhase	SMA 12" Cable	25-Sep-15	25-Sep-16	A1 thru A7
CIS054671	RA08-S1S1-12 MegaPhase	SMA 12" Cable	25-Sep-15	25-Sep-16	A1 thru A7
CIS054670	RA08-S1S1-12 MegaPhase	SMA 12" Cable	25-Sep-15	25-Sep-16	A1 thru A7
CIS054664	GC12-8181-16 MegaPhase	SMA 16" Cable	25-Sep-15	25-Sep-16	A1 thru A7
CIS054663	F120-S1S1-48 MegaPhase	SMA 48" Cable	25-Sep-15	25-Sep-16	A1 thru A7
CIS054686	NI PXI-2796 National Instruments	Plug-in switch module	6-Oct-15	6-Oct-16	A1 thru A7
CIS042005	BWS30W2+ Mini-Circuits	SMA 30dB Attenuator	16-Oct-15	16-Oct-16	A1 thru A7
CIS041995	BW-S6W2 Mini-Circuits	6dB Attenuator	16-Oct-15	16-Oct-16	A1 thru A7
CIS054695	D3C2060 Ditom	Circulator	20-Oct-15	20-Oct-16	A1 thru A7
CIS055146	RA08-S1S1-12 Megaphase	12" SMA Cable	17-Nov-15	17-Nov-16	A1 thru A7
CIS050721	N9030A Keysight	PXA Signal Analyzer	30-Mar-16	30-Mar-17	A1 thru A7
CIS054303	N5182B Keysight	MXG X-Series RF Vector Signal Generator	6-Apr-16	6-Apr-17	A1 thru A7
CIS055358	ZFSC-2-10G Mini-Circuits	Splitter	11-Apr-16	11-Apr-17	A1 thru A7
CIS055099	SMART2200RM2U Tripp-Lite	Power Supply	Cal Not Required		A1 thru A7
CIS055094	PXI-1042 National Instruments	Chassis	Cal Not Required		A1 thru A7

Appendix E: Abbreviation Key and Definitions

The following table defines abbreviations used within this test report.

Abbreviation	Description	Abbreviation	Description
EMC	Electro Magnetic Compatibility	°F	Degrees Fahrenheit
EMI	Electro Magnetic Interference	°C	Degrees Celsius
EUT	Equipment Under Test	Temp	Temperature
ITE	Information Technology Equipment	S/N	Serial Number
TAP	Test Assessment Schedule	Qty	Quantity
ESD	Electro Static Discharge	emf	Electromotive force
EFT	Electric Fast Transient	RMS	Root mean square
EDCS	Engineering Document Control System	Qp	Quasi Peak
Config	Configuration	Av	Average
CIS#	Cisco Number (unique identification number for Cisco test equipment)	Pk	Peak
Cal	Calibration	kHz	Kilohertz (1x10 ³)
EN	European Norm	MHz	MegaHertz (1x10 ⁶)
IEC	International Electro technical Commission	GHz	Gigahertz (1x10 ⁹)
CISPR	International Special Committee on Radio Interference	H	Horizontal
CDN	Coupling/Decoupling Network	V	Vertical
LISN	Line Impedance Stabilization Network	dB	decibel
PE	Protective Earth	V	Volt
GND	Ground	kV	Kilovolt (1x10 ³)
L1	Line 1	μV	Microvolt (1x10 ⁻⁶)
L2	Line2	A	Amp
L3	Line 3	μA	Micro Amp (1x10 ⁻⁶)
DC	Direct Current	mS	Milli Second (1x10 ⁻³)
RAW	Uncorrected measurement value, as indicated by the measuring device	μS	Micro Second (1x10 ⁻⁶)
RF	Radio Frequency	μS	Micro Second (1x10 ⁻⁶)
SLCE	Signal Line Conducted Emissions	m	Meter
Meas dist	Measurement distance	Spec dist	Specification distance
N/A or NA	Not Applicable	SL	Signal Line (or Telecom Line)
P	Power Line	L	Live Line
N	Neutral Line	R	Return
S	Supply	AC	Alternating Current

End