

Test Report

AIR-AP1562E-B-K9

Cisco Aironet 802.11ac Dual Band Outdoor Access Points

FCC ID: LDK102103

5150-5250 MHz

Against the following Specifications:

CFR47 Part 15.407



Cisco Systems

170 West Tasman Drive

San Jose, CA 95134

	
Author: Jose Aguirre Tested By:	Approved By: Jim Nicholson Title: Technical Leader, Engineering Revision: 2

This report replaces any previously entered test report under EDCS – **11346265**. This test report has been electronically authorized and archived using the CISCO Engineering Document Control system.

This test report has been electronically authorized and archived using the CISCO Engineering Document Control system.

SECTION 1: OVERVIEW	4
SECTION 2: ASSESSMENT INFORMATION	5
2.1 GENERAL	5
2.2 DATE OF TESTING.....	7
2.3 REPORT ISSUE DATE	7
2.4 TESTING FACILITIES	7
2.5 EQUIPMENT ASSESSED (EUT).....	7
2.6 EUT DESCRIPTION.....	8
SECTION 3: RESULT SUMMARY	10
3.1 RESULTS SUMMARY TABLE	10
SECTION 4: SAMPLE DETAILS.....	12
4.1 SAMPLE DETAILS	12
4.2 SYSTEM DETAILS	12
4.3 MODE OF OPERATION DETAILS.....	12
APPENDIX A: EMISSION TEST RESULTS	13
CONDUCTED TEST SETUP DIAGRAM.....	13
TARGET MAXIMUM CHANNEL POWER	13
Antenna Gain: 5 dBi	13
Antenna Gain: 7 dBi	14
Antenna Gain: 8 dBi	15
Antenna Gain: 13 dBi	16
Antenna Gain: 14 dBi	17
A.1 99% AND 26DB BANDWIDTH.....	18
A.2 MAXIMUM CONDUCTED OUTPUT POWER/ POWER SPECTRAL DENSITY	26
Antenna Gain: 5 dBi	28
Antenna Gain: 7 dBi	31
Antenna Gain: 8 dBi	34
Antenna Gain: 13 dBi	37
Antenna Gain: 14 dBi	40
Power Spectral Density	43
Antenna Gain: 5 dBi	43
Antenna Gain: 7 dBi	46
Antenna Gain: 8 dBi	49
Antenna Gain: 13 dBi	52
Antenna Gain: 14 dBi	55
Antenna Gain: 5 (-5) dBi.....	58
Antenna Gain: 7 (-6) dBi.....	60
Antenna Gain: 8 (3) dBi.....	62
Antenna Gain: 13 (-5) dBi.....	64
Antenna Gain: 14 (5) dBi.....	66
A.3 CONDUCTED SPURIOUS EMISSIONS	68
A.4 CONDUCTED BAND EDGE	76
Antenna Gain: 5 dBi	77



Antenna Gain: 7 dBi	79
Antenna Gain: 8 dBi	81
Antenna Gain: 13 dBi	83
Antenna Gain: 14 dBi	85
Antenna Gain: 5 dBi	87
Antenna Gain: 7 dBi	89
Antenna Gain: 8 dBi	91
Antenna Gain: 13 dBi	93
Antenna Gain: 14 dBi	95
APPENDIX B: EMISSION TEST RESULTS	98
RADIATED EMISSION SETUP DIAGRAM-BELOW 1G	98
B.1 RADIATED SPURIOUS EMISSIONS	99
B.2 RADIATED EMISSIONS 30MHZ TO 1GHZ	110
B.3 AC CONDUCTED EMISSIONS	113
APPENDIX C: LIST OF TEST EQUIPMENT USED TO PERFORM THE TEST	117
APPENDIX E: ABBREVIATION KEY AND DEFINITIONS	120



Section 1: Overview

The samples were assessed against the tests detailed in section 3 under the requirements of the following specifications:

Specifications:
CFR47 Part 15.407

Measurements were made in accordance with

- ANSI C63.10:2013
- KDB 789033 D02 General UNII Test Procedures New Rules v01r03
- KDB 662911 D01 Multiple Transmitter Output v02r01

Section 2: Assessment Information

2.1 General

This report contains an assessment of an apparatus against Electromagnetic Compatibility Standards based upon tests carried out on the samples submitted. The testing was performed by and for the use of Cisco systems Inc:

With regard to this assessment, the following points should be noted:

- a) The results contained in this report relate only to the items tested and were obtained in the period between the date of the initial assessment and the date of issue of the report. Manufactured products will not necessarily give identical results due to production and measurement tolerances.
- b) The apparatus was set up and exercised using the configuration and modes of operation defined in this report only.
- c) Where relevant, the apparatus was only assessed using the susceptibility criteria defined in this report and the Test Assessment Plan (TAP).
- d) All testing was performed under the following environmental conditions:

Temperature	15°C to 35°C (54°F to 95°F)
Atmospheric Pressure	860mbar to 1060mbar (25.4" to 31.3")
Humidity	10% to 75*%
- e) All AC testing was performed at one or more of the following supply voltages:
110V 60 Hz (+/-20%)

Units of Measurement

The units of measurements defined in the appendices are reported in specific terms, which are test dependent. Where radiated measurements are concerned these are defined at a particular distance. Basic voltage measurements are defined in units of [dBuV]

As an example, the basic calculation for all measurements is as follows:

$$\text{Emission level [dBuV]} = \text{Indicated voltage level [dBuV]} + \text{Cable Loss [dB]} + \text{Other correction factors [dB]}$$

The combinations of correction factors are dependent upon the exact test configurations [see test equipment lists for further details] and may include:-

Antenna Factors, Pre Amplifier Gain, LISN Loss, Pulse Limiter Loss and Filter Insertion Loss..

Note: to convert the results from dBuV/m to uV/m use the following formula:-

$$\text{Level in uV/m} = \text{Common Antilogarithm} [(X \text{ dBuV/m})/20] = Y \text{ uV/m}$$

Measurement Uncertainty Values

voltage and power measurements	± 2 dB
conducted EIRP measurements	± 1.4 dB
radiated measurements	± 3.2 dB
frequency measurements	± 2.4 10 ⁻⁷
temperature measurements	± 0.54°
humidity measurements	± 2.3%
DC and low frequency measurements	± 2.5%

Where relevant measurement uncertainty levels have been estimated for tests performed on the apparatus. This uncertainty represents an expanded uncertainty expressed at approximately the 95% confidence level using a coverage factor of k=2.

Radiated emissions (expanded uncertainty, confidence interval 95%)

30 MHz - 300 MHz	+/- 3.8 dB
300 MHz - 1000 MHz	+/- 4.3 dB
1 GHz - 10 GHz	+/- 4.0 dB
10 GHz - 18GHz	+/- 8.2 dB
18GHz - 26.5GHz	+/- 4.1 dB
26.5GHz - 40GHz	+/- 3.9 dB

Conducted emissions (expanded uncertainty, confidence interval 95%)

30 MHz – 40GHz	+/- 0.38 dB
----------------	-------------

A product is considered to comply with a requirement if the nominal measured value is below the limit line. The product is considered to not be in compliance in case the nominal measured value is above the limit line.

This report must not be reproduced except in full, without written approval of Cisco Systems.

2.2 Date of testing

20-April-16 - 08-Aug-16

2.3 Report Issue Date

24-August-2016

Cisco uses an electronic system to issue, store and control the revision of test reports. This system is called the Engineering Document Control System (EDCS). The actual report issue date is embedded into the original file on EDCS. Any copies of this report, either electronic or paper, that are not on EDCS must be considered uncontrolled.

2.4 Testing facilities

This assessment was performed by:

Testing Laboratory

Cisco Systems, Inc.,
125 West Tasman Drive
San Jose, CA 95134, USA

Registration Numbers for Industry Canada

Cisco System Site	Address	Site Identifier
Building P, 10m Chamber	125 West Tasman Dr San Jose, CA 95134	Company #: 2461N-2
Building P, 5m Chamber	125 West Tasman Dr San Jose, CA 95134	Company #: 2461N-1
Building I, 5m Chamber	285 W. Tasman Drive San Jose, California 95134	Company #: 2461M-1

Test Engineers

Jose Aguirre

2.5 Equipment Assessed (EUT)

AIR-AP1562E-B-K9

2.6 EUT Description

The Cisco Aironet 802.11ac Radio supports the following modes of operation. The modes are further defined in the radio Theory of Operation. The modes included in this report represent the worst case data for all modes.

802.11n/ac - Non HT20, One Antenna, 6 to 54 Mbps
802.11n/ac - Non HT20, Two Antennas, 6 to 54 Mbps

802.11n/ac-Non HT20 Beam Forming, Two Antenna, 6-54 Mbps

802.11n/ac - HT/VHT20, One Antenna, M0 to M7
802.11n/ac - HT/VHT20, Two Antennas, M0 to M7
802.11n/ac - HT/VHT20, Two Antennas, M8 to M15

802.11n/ac - HT/VHT20 Beam Forming, Two Antennas, M0 to M7
802.11n/ac - HT/VHT20 Beam Forming, Two Antennas, M8 to M15

802.11n/ac - HT/VHT20 STBC, Two Antennas, M0 to M7

802.11n/ac - Non HT40 Duplicate, One Antenna, 6 to 54 Mbps
802.11n/ac - Non HT40 Duplicate, Two Antennas, 6 to 54 Mbps

802.11n/ac - HT/VHT40, One Antenna, M0 to M7
802.11n/ac - HT/VHT40, Two Antennas, M0 to M7
802.11n/ac - HT/VHT40, Two Antennas, M8 to M15

802.11n/ac - HT/VHT40 Beam Forming, Two Antennas, M0 to M7
802.11n/ac - HT/VHT40 Beam Forming, Two Antennas, M8 to M15

802.11n/ac - HT/VHT40 STBC, Two Antennas, M0 to M7

802.11n/ac - Non HT80 Duplicate, One Antenna, 6 to 54 Mbps
802.11n/ac - Non HT80 Duplicate, Two Antennas, 6 to 54 Mbps

802.11ac - VHT80, One Antenna, M0 to M9 1ss
802.11ac - VHT80, Two Antennas, M0 to M9 1ss
802.11ac - VHT80, Two Antennas, M0 to M9 2ss

802.11ac - VHT80 Beam Forming, Two Antennas, M0 to M9 1ss
802.11ac - VHT80 Beam Forming, Two Antennas, M0 to M9 2ss

802.11ac - VHT80 STBC, Two Antennas, M0 to M9 1ss

The following antennas are supported by this product series.
The data included in this report represent the worst case data for all antennas.

Frequency	Part Number	Antenna Type	Antenna Gain (dBi)	>30 degree 5 GHz Antenna Gain (dBi)
5 GHz	AIR-ANT5180V-N	Single Band Omni	8	-3
	AIR-ANT5150HG-N	Horizontal Polarized Omni	5	-5
	AIR-ANT5150VG-N	Vertical Polarized Omni	5	-6
	AIR-ANT5114P2M-N	Single Band, Cross Polarized Directional Patch	14	5
5 GHz	AIR-ANT2547V-N=	Dual-band Omni	7	-6
	AIR-ANT2547VG-N=	Dual-band Omni, Gray	7	-6
	AIR-ANT2568VG-N	Dual-band Omni	8	3
	AIR-ANT2588P3M-N=	Dual-band/Dual Polarized Directional, Patch	8	1
	AIR-ANT2513P4M-N	Dual-band Cross Polarization Patch Array	13	-5

Section 3: Result Summary

3.1 Results Summary Table

Conducted emissions

Basic Standard	Technical Requirements / Details	Result
FCC 15.407	<p>99% & 26 dB Bandwidth: The 99% occupied bandwidth is the frequency bandwidth such that, below its lower and above its upper frequency limits, the mean powers are each equal to 0.5% of the total mean power of the given emission. There is no limit for 99% OBW.</p> <p>The 26 dB emission is the width of the emission that is constrained by the frequencies associated with the two outermost amplitude points (upper and lower frequencies) that are attenuated by 26 dB relative to the maximum level measured in the fundamental emission.</p>	Pass
FCC 15.407	<p>Output Power: 15.407: (i) For an outdoor access point operating in the band 5.15-5.25 GHz, the maximum conducted output power over the frequency band of operation shall not exceed 1 W provided the maximum antenna gain does not exceed 6 dBi. If transmitting antennas of directional gain greater than 6 dBi are used, the maximum conducted output power shall be reduced by the amount in dB that the directional gain of the antenna exceeds 6 dBi. The maximum e.i.r.p. at any elevation angle above 30 degrees as measured from the horizon must not exceed 125 mW (21 dBm).</p> <p>(ii) For an indoor access point operating in the band 5.15-5.25 GHz, the maximum conducted output power over the frequency band of operation shall not exceed 1 W provided the maximum antenna gain does not exceed 6 dBi. If transmitting antennas of directional gain greater than 6 dBi are used, the maximum conducted output power shall be reduced by the amount in dB that the directional gain of the antenna exceeds 6 dBi.</p>	Pass
FCC 15.407	<p>Power Spectral Density: 15.407 The maximum power spectral density shall not exceed 17 dBm in any 1 megahertz band. If transmitting antennas of directional gain greater than 6 dBi are used, both the maximum conducted output power and the maximum power spectral density shall be reduced by the amount in dB that the directional gain of the antenna exceeds 6 dBi.</p>	Pass
FCC 15.407	<p>Conducted Spurious Emissions / Band-Edge: For transmitters operating in the 5.15-5.25 GHz band: all emissions outside of the 5.15-5.25 GHz band shall not exceed an EIRP of -27dBm/MHz.</p>	Pass
FCC 15.407 FCC 15.209 FCC 15.205	<p>Restricted band: Unwanted emissions falling within the restricted bands, as defined in FCC 15.205 (a) must also comply with the radiated emission limits specified in FCC 15.209 (a).</p>	Pass

Radiated Emissions (General requirements)

Basic Standard	Technical Requirements / Details	Result
FCC 15.209 FCC 15.205	TX Spurious Emissions: Except as provided elsewhere in this subpart, the emissions from an intentional radiator shall not exceed the field strength levels specified in the filed strength limits table in this section.	Pass
FCC 15.207	AC conducted Emissions: Except when the requirements applicable to a given device state otherwise, for any radio apparatus equipped to operate from the public utility AC power supply, either directly or indirectly (such as with a battery charger), the radio frequency voltage of emissions conducted back onto the AC power lines in the frequency range of 0.15 MHz to 30 MHz shall not exceed the limits shown in the table in these sections. The more stringent limit applies at the frequency range boundaries.	Pass

* MPE calculation is recorded in a separate report

Section 4: Sample Details

Note: Each sample was evaluated to ensure that its condition was suitable to be used as a test sample prior to the commencement of testing.

4.1 Sample Details

Sample No.	Equipment Details	Manufacturer	Hardware Rev.	Firmware Rev.	Software Rev.	Serial Number
S01	AIR-AP1562E-B-K9	Cisco Systems	P2	9.1.8.1	9.0.5.5-W8964	RFDP2BML083
S02*	AIR-PWRADPT-RGD1	Meanwell	A0	NA	NA	EB3F71752

(*) S02 is support equipment Power supply for EUT S01

4.2 System Details

System #	Description	Samples
1	AIR-AP1562E-B-K9	S01
2	AIR-PWRADPT-RGD1	S02

4.3 Mode of Operation Details

Mode#	Description	Comments
1	Continuous Transmitting	Continuous Transmitting $\geq 98\%$ duty cycle

All measurements were made in accordance with

- ANSI C63.10:2013
- KDB 789033 D02 General UNII Test Procedures New Rules v01r03
- KDB 662911 D01 Multiple Transmitter Output v02r01

Appendix A: Emission Test Results

Conducted Test Setup Diagram

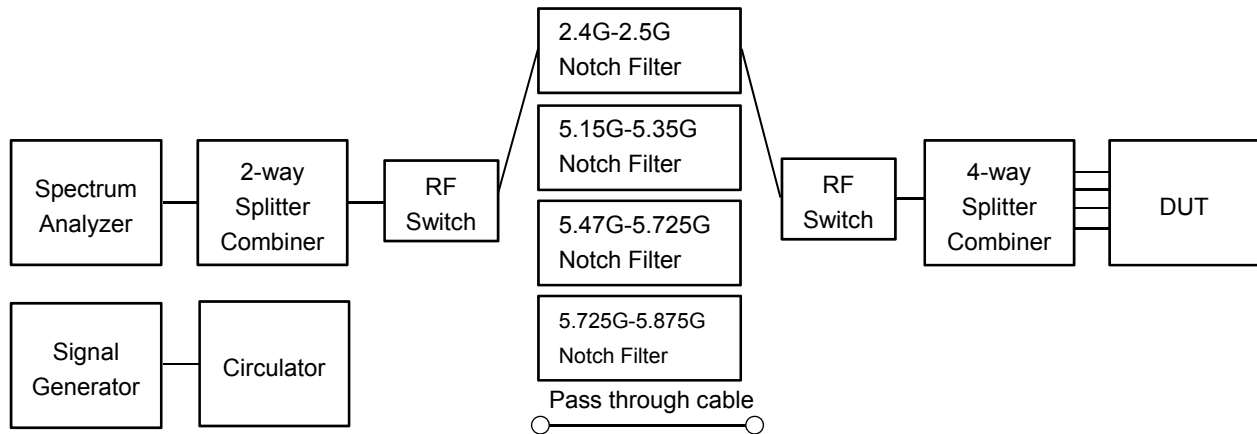

Target Maximum Channel Power

The following table details the maximum supported Total Channel Power for all operating modes.

Antenna Gain: 5 dBi

Operating Mode	Maximum Channel Power (dBm)		
	Frequency (MHz)		
	5180	5220	5240
Non HT20, 6 to 54 Mbps	19	26	25
Non HT20 Beam Forming, 6 to 54 Mbps	18	23	22
HT/VHT20, M0 to M15	19	26	26
HT/VHT20 Beam Forming, M0 to M15	19	26	26
HT/VHT20 STBC, M0 to M7	19	26	26
	5190	5230	
Non HT40, 6 to 54 Mbps	15	26	
HT/VHT40, M0 to M15	16	26	
HT/VHT40 Beam Forming, M0 to M15	15	26	
HT/VHT40 STBC, M0 to M7	15	26	
	5210		
Non HT80, 6 to 54 Mbps	14		
VHT80, M0 to M9, M0 to M9 1-1ss	14		
VHT80 Beam Forming, M0 to M9, M0 to M9 1-1ss	14		
VHT80 STBC, M0 to M9 1ss	14		

Antenna Gain: 7 dBi

Operating Mode	Maximum Channel Power (dBm)		
	Frequency (MHz)		
	5180	5220	5240
Non HT20, 6 to 54 Mbps	18	24	24
Non HT20 Beam Forming, 6 to 54 Mbps	17	23	23
HT/VHT20, M0 to M15	18	27	27
HT/VHT20 Beam Forming, M0 to M15	18	27	27
HT/VHT20 STBC, M0 to M7	18	27	27
	5190	5230	
Non HT40, 6 to 54 Mbps	13	26	
HT/VHT40, M0 to M15	14	27	
HT/VHT40 Beam Forming, M0 to M15	14	27	
HT/VHT40 STBC, M0 to M7	14	27	
	5210		
Non HT80, 6 to 54 Mbps	13		
VHT80, M0 to M9, M0 to M9 1-1ss	14		
VHT80 Beam Forming, M0 to M9, M0 to M9 1-1ss	13		
VHT80 STBC, M0 to M9 1ss	13		

Antenna Gain: 8 dBi

Operating Mode	Maximum Channel Power (dBm)		
	Frequency (MHz)		
	5180	5220	5240
Non HT20, 6 to 54 Mbps	17	18	18
Non HT20 Beam Forming, 6 to 54 Mbps	15	15	14
HT/VHT20, M0 to M15	17	18	18
HT/VHT20 Beam Forming, M0 to M15	17	18	18
HT/VHT20 STBC, M0 to M7	17	18	18
	5190	5230	
Non HT40, 6 to 54 Mbps	13	18	
HT/VHT40, M0 to M15	14	17	
HT/VHT40 Beam Forming, M0 to M15	13	17	
HT/VHT40 STBC, M0 to M7	13	17	
	5210		
Non HT80, 6 to 54 Mbps	13		
VHT80, M0 to M9, M0 to M9 1-1ss	14		
VHT80 Beam Forming, M0 to M9, M0 to M9 1-1ss	14		
VHT80 STBC, M0 to M9 1ss	14		

Antenna Gain: 13 dBi

Operating Mode	Maximum Channel Power (dBm)		
	Frequency (MHz)		
	5180	5220	5240
Non HT20, 6 to 54 Mbps	15	20	20
Non HT20 Beam Forming, 6 to 54 Mbps	15	20	20
HT/VHT20, M0 to M15	14	21	21
HT/VHT20 Beam Forming, M0 to M15	14	20	21
HT/VHT20 STBC, M0 to M7	14	20	21
	5190	5230	
Non HT40, 6 to 54 Mbps	11	23	
HT/VHT40, M0 to M15	12	23	
HT/VHT40 Beam Forming, M0 to M15	12	23	
HT/VHT40 STBC, M0 to M7	12	23	
	5210		
Non HT80, 6 to 54 Mbps	10		
VHT80, M0 to M9, M0 to M9 1-1ss	11		
VHT80 Beam Forming, M0 to M9, M0 to M9 1-1ss	11		
VHT80 STBC, M0 to M9 1ss	11		

Antenna Gain: 14 dBi

Operating Mode	Maximum Channel Power (dBm)		
	Frequency (MHz)		
	5180	5220	5240
Non HT20, 6 to 54 Mbps	14	16	15
Non HT20 Beam Forming, 6 to 54 Mbps	13	12	13
HT/VHT20, M0 to M15	15	16	15
HT/VHT20 Beam Forming, M0 to M15	15	16	15
HT/VHT20 STBC, M0 to M7	15	16	15
	5190	5230	
Non HT40, 6 to 54 Mbps	11	16	
HT/VHT40, M0 to M15	11	15	
HT/VHT40 Beam Forming, M0 to M15	11	15	
HT/VHT40 STBC, M0 to M7	11	15	
	5210		
Non HT80, 6 to 54 Mbps	9		
VHT80, M0 to M9, M0 to M9 1-1ss	10		
VHT80 Beam Forming, M0 to M9, M0 to M9 1-1ss	10		
VHT80 STBC, M0 to M9 1ss	10		

A.1 99% and 26dB Bandwidth

FCC 15.407 The 99% occupied bandwidth is the frequency bandwidth such that, below its lower and above its upper frequency limits, the mean powers are each equal to 0.5% of the total mean power of the given emission. There is no limit for 99% OBW.

The 26 dB emission is the width of the emission that is constrained by the frequencies associated with the two outermost amplitude points (upper and lower frequencies) that are attenuated by 26 dB relative to the maximum level measured in the fundamental emission.

Test Procedure

Ref. ANSI C63.10: 2013 Section 6.9.3

99% BW and EBW (-26dB)
Test Procedure
<ol style="list-style-type: none"> 1. Set the radio in the continuous transmitting mode. 2. Allow the trace to stabilize. 3. Setting the x-dB bandwidth mode to -26dB and OBW power function to 99% within the measurement set up function. 4. Select the automatic OBW measurement function of an instrument to perform bandwidth measurement. 5. Capture graphs and record pertinent measurement data.

Ref. ANSI C63.10: 2013 Section 6.9.3

99% BW and EBW (-26dB)
Test parameters
Span = 1.5 x to 5.0 times OBW
RBW = approx. 1% to 5% of the OBW
VBW ≥ 3 x RBW
Detector = Peak or where practical sample shall be used
Trace = Max. Hold

System Number	Description	Samples	System under test	Support equipment
1	EUT	S01	<input checked="" type="checkbox"/>	<input type="checkbox"/>
	Support	S02	<input type="checkbox"/>	<input checked="" type="checkbox"/>

Tested By : Jose Aguirre	Date of testing: 20-April-16 - 08-Aug-16
Test Result : PASS	

See Appendix C for list of test equipment

Frequency (MHz)	Mode	Data Rate (Mbps)	26dB BW (MHz)	99% BW (MHz)
5180	Non HT20, 6 to 54 Mbps	6	22.8	17.990
	HT/VHT20, M0 to M15	m0	23.6	18.303
5190	Non HT40, 6 to 54 Mbps	6	47.7	37.011
	HT/VHT40, M0 to M15	m0	44.1	36.734
5210	Non HT80, 6 to 54 Mbps	6	83.5	76.438
	VHT80, M0 to M9, M0 to M9 1-1ss	m0x1	82.6	76.441
5220	Non HT20, 6 to 54 Mbps	6	26.0	18.056
	HT/VHT20, M0 to M15	m0	28.6	18.448
5230	Non HT40, 6 to 54 Mbps	6	76.4	39.338
	HT/VHT40, M0 to M15	m0	49.3	36.750
5240	Non HT20, 6 to 54 Mbps	6	27.6	18.080
	HT/VHT20, M0 to M15	m0	28.6	18.441



26dB / 99% Bandwidth, 5180 MHz, Non HT20, 6 to 54 Mbps

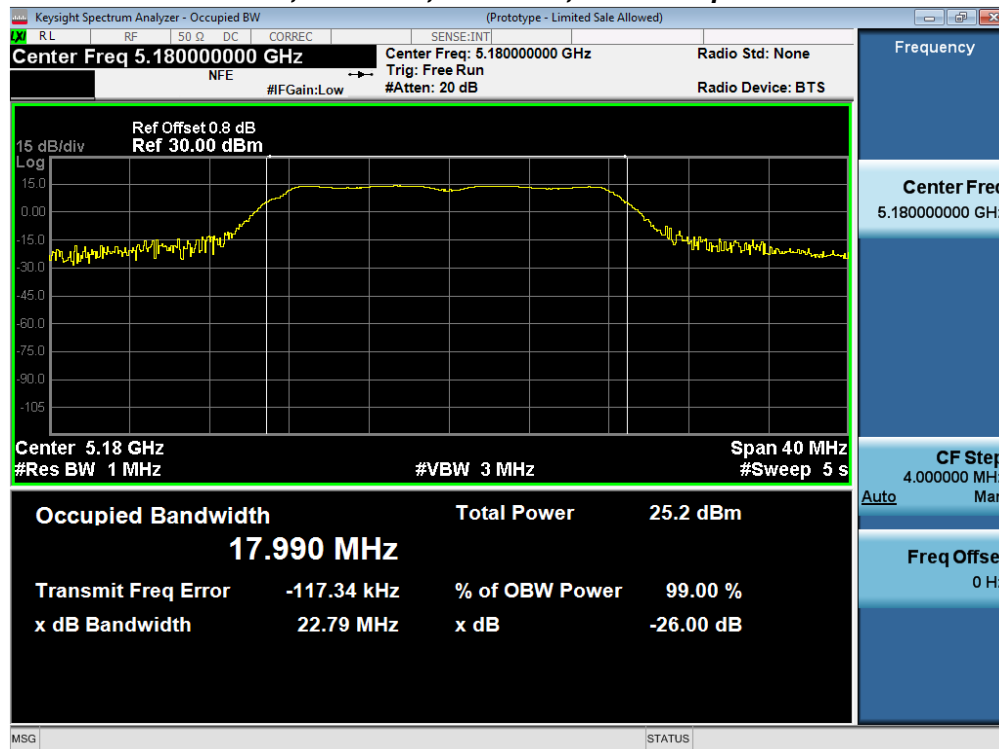

26dB / 99% Bandwidth, 5180 MHz, HT/VHT20, M0 to M15

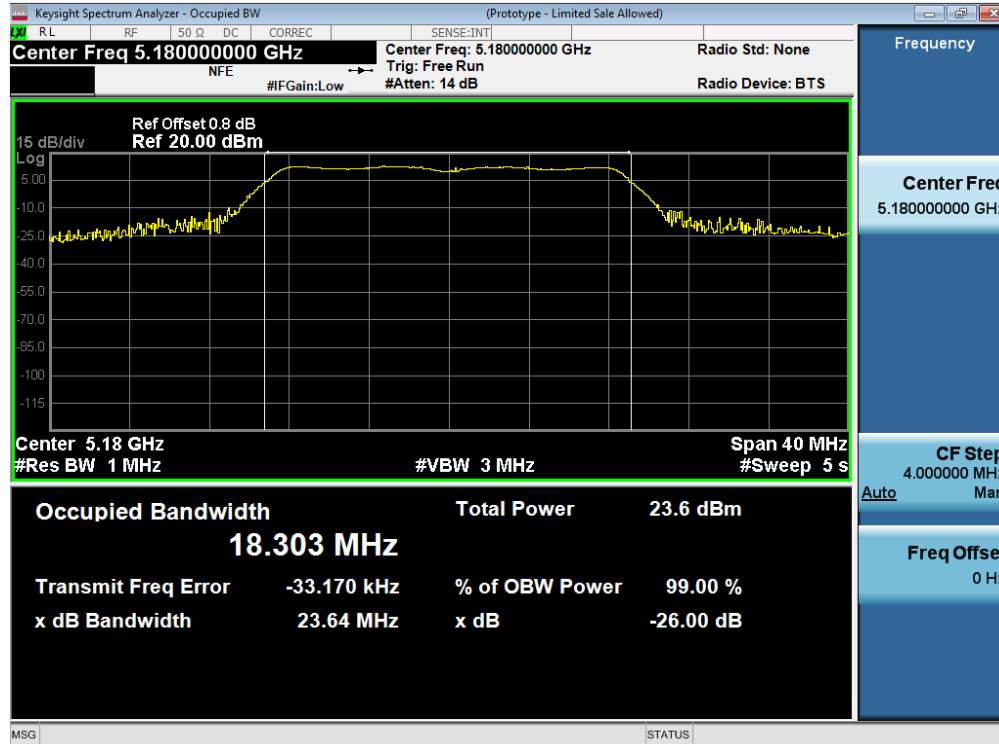

26dB / 99% Bandwidth, 5190 MHz, Non HT40, 6 to 54 Mbps

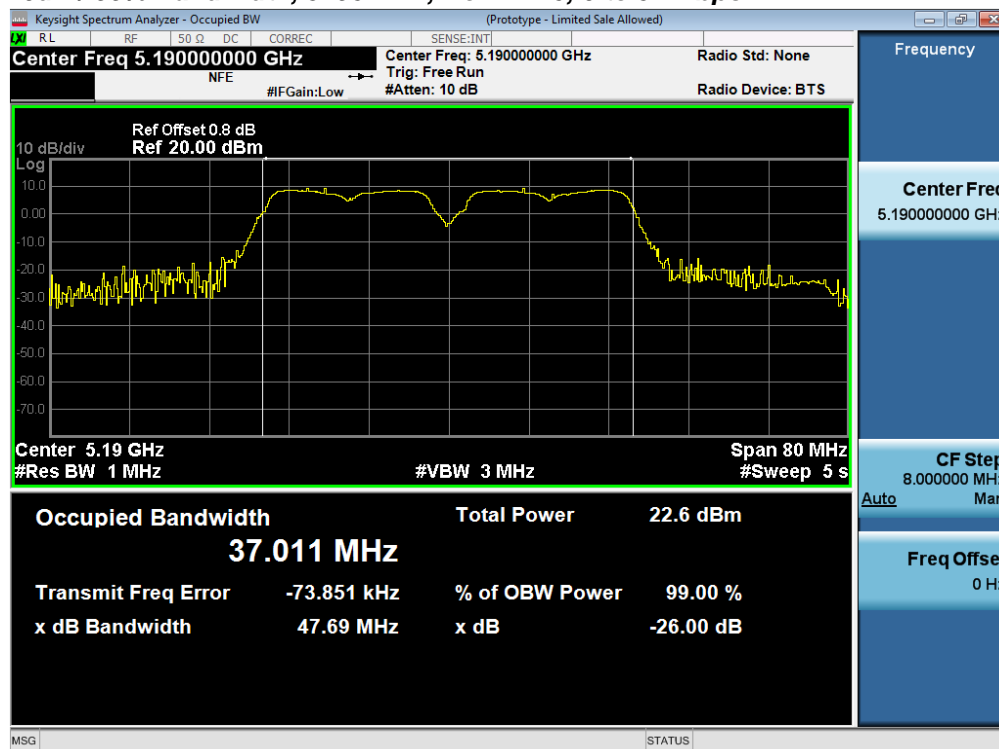

26dB / 99% Bandwidth, 5190 MHz, HT/VHT40, M0 to M15

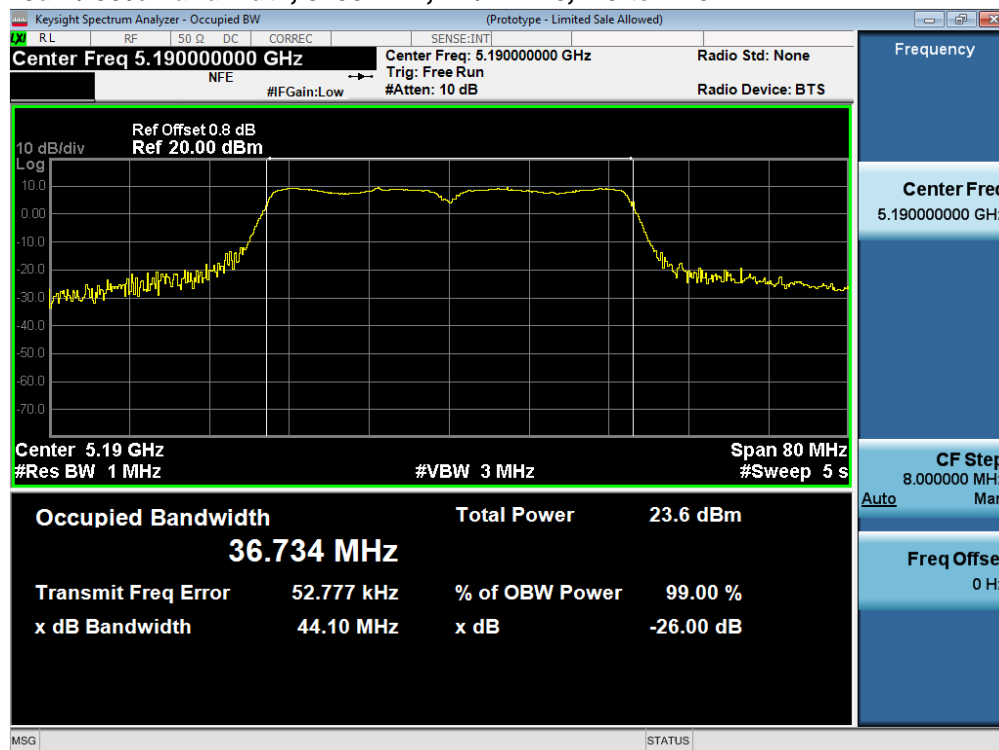

26dB / 99% Bandwidth, 5210 MHz, Non HT80, 6 to 54 Mbps

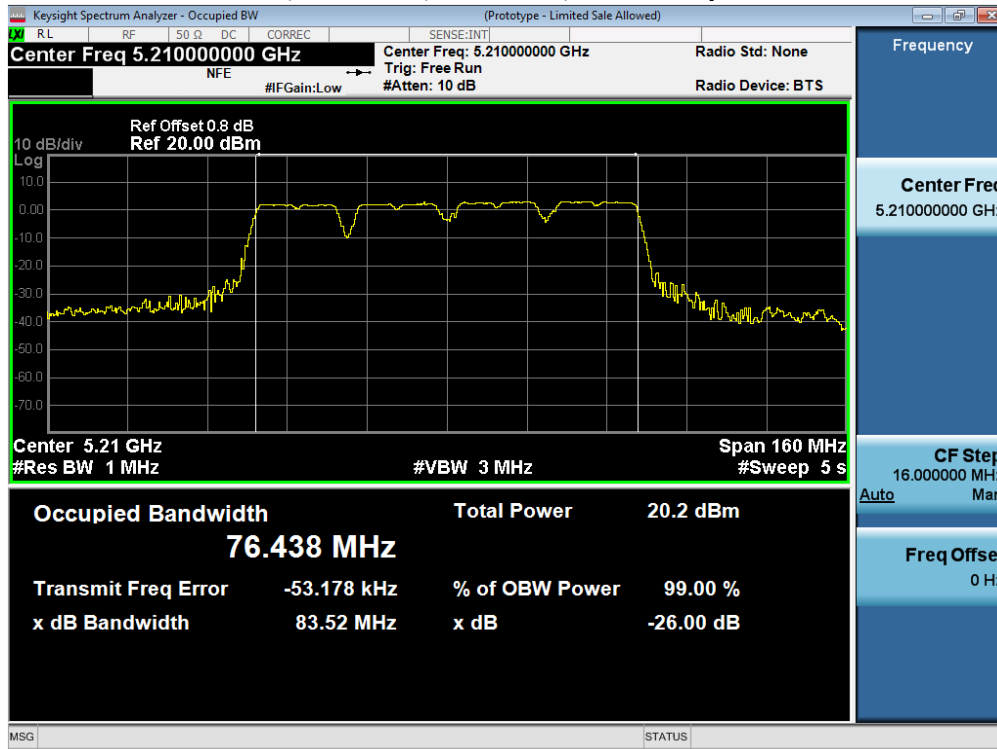

26dB / 99% Bandwidth, 5210 MHz, VHT80, M0 to M9, M0 to M9 1-1ss

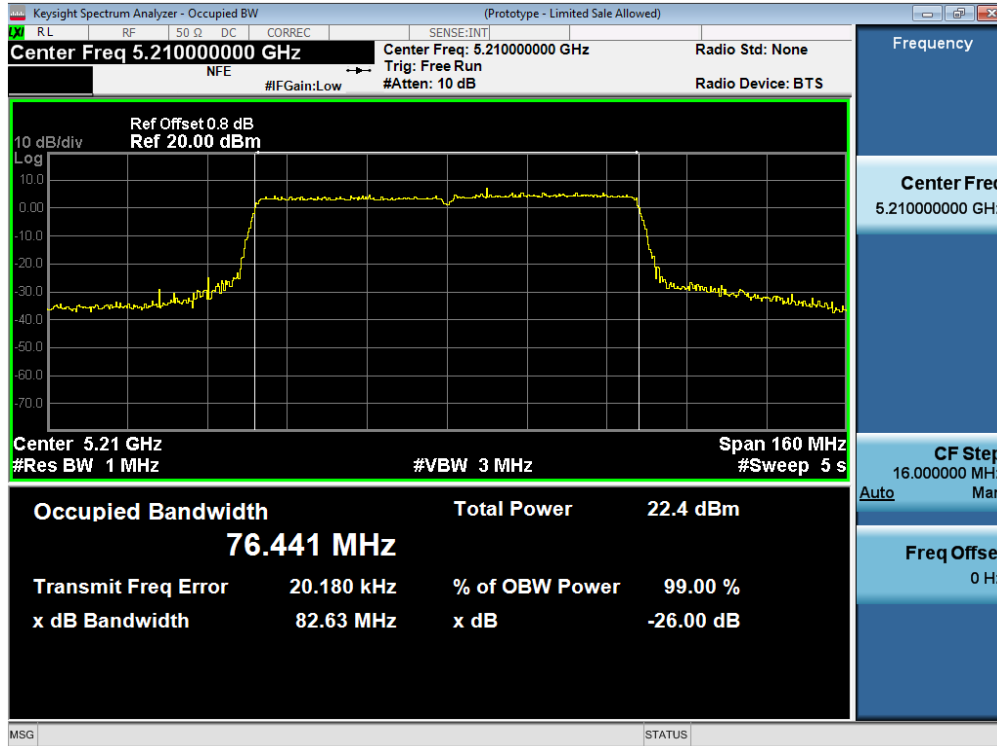



26dB / 99% Bandwidth, 5220 MHz, Non HT20, 6 to 54 Mbps

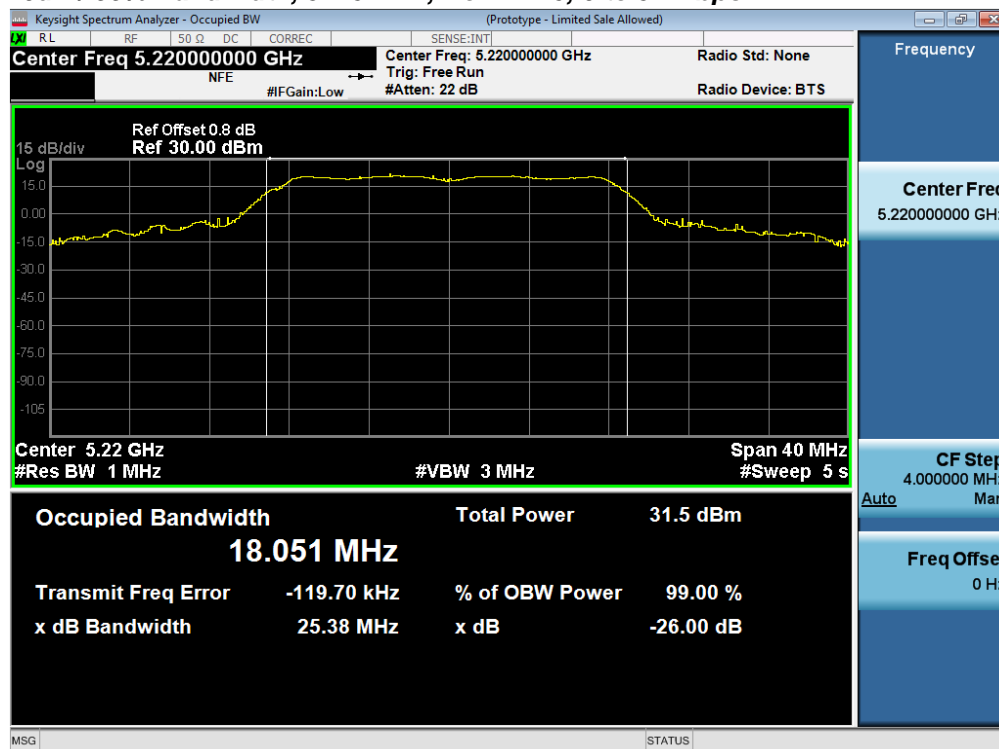

26dB / 99% Bandwidth, 5220 MHz, HT/VHT20, M0 to M15

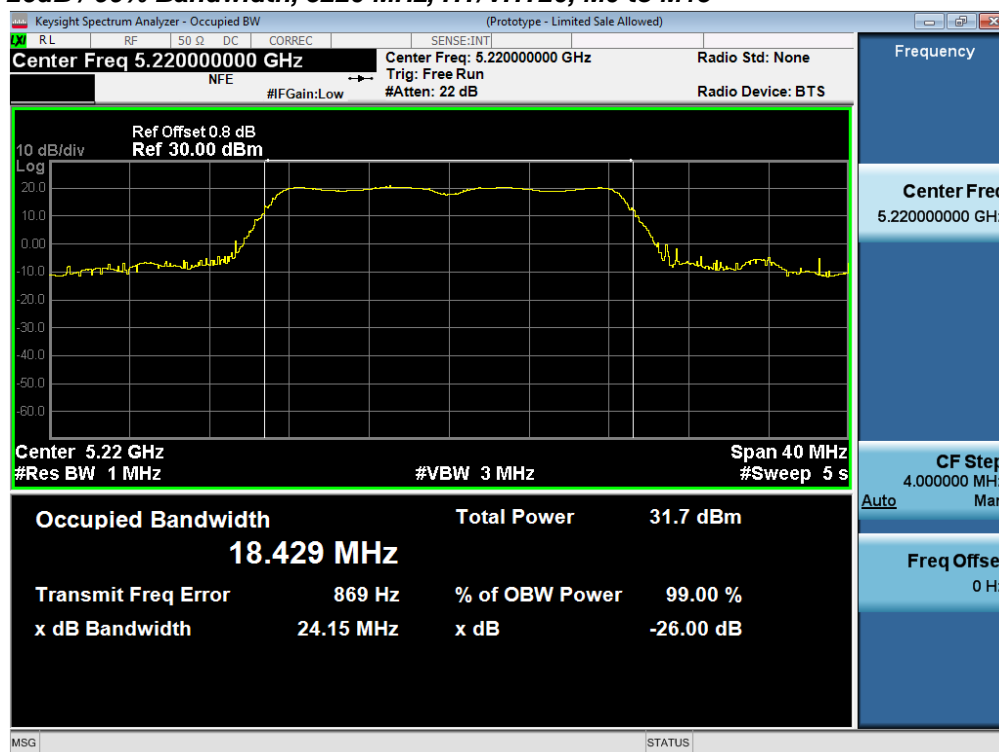



26dB / 99% Bandwidth, 5230 MHz, Non HT40, 6 to 54 Mbps

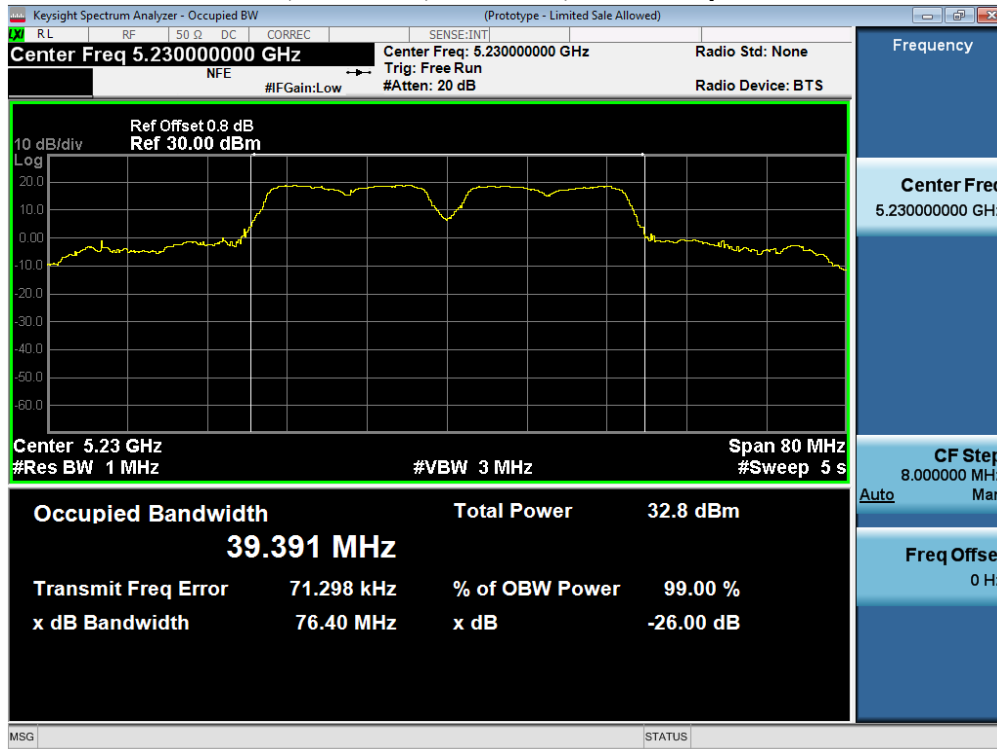

26dB / 99% Bandwidth, 5230 MHz, HT/VHT40, M0 to M15

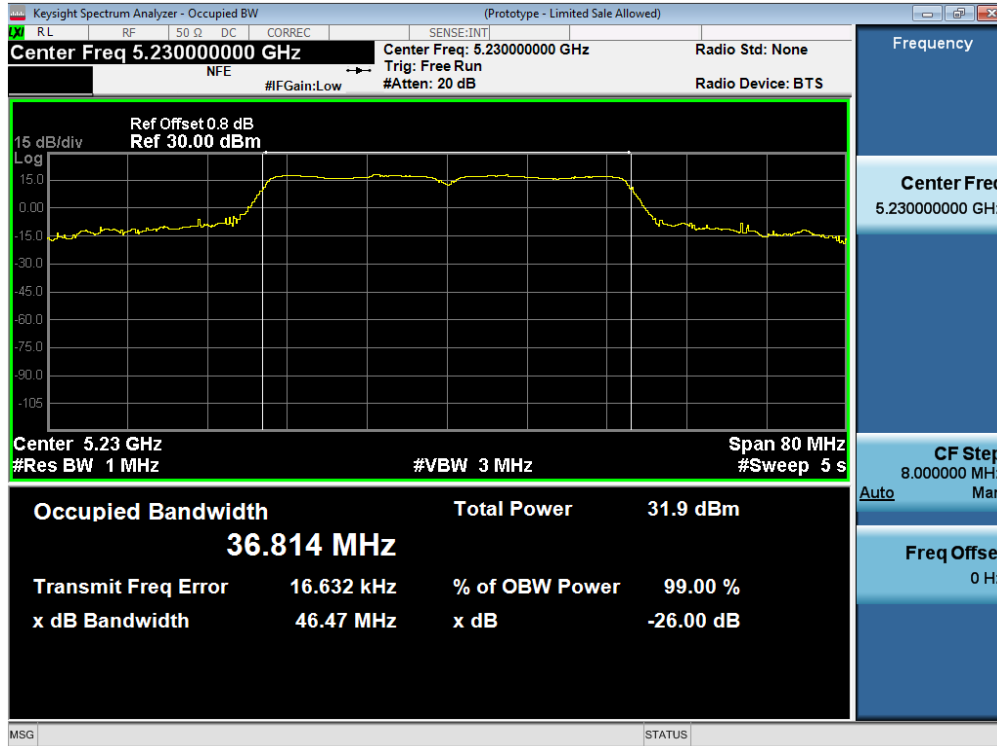



26dB / 99% Bandwidth, 5240 MHz, Non HT20, 6 to 54 Mbps

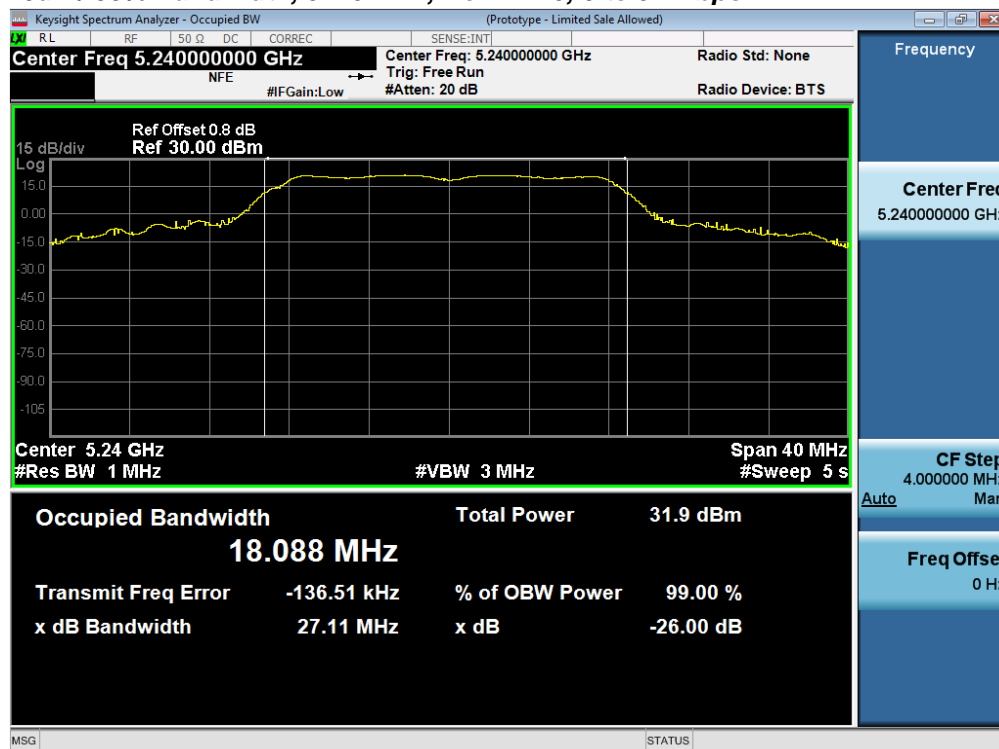

26dB / 99% Bandwidth, 5240 MHz, HT/VHT20, M0 to M15

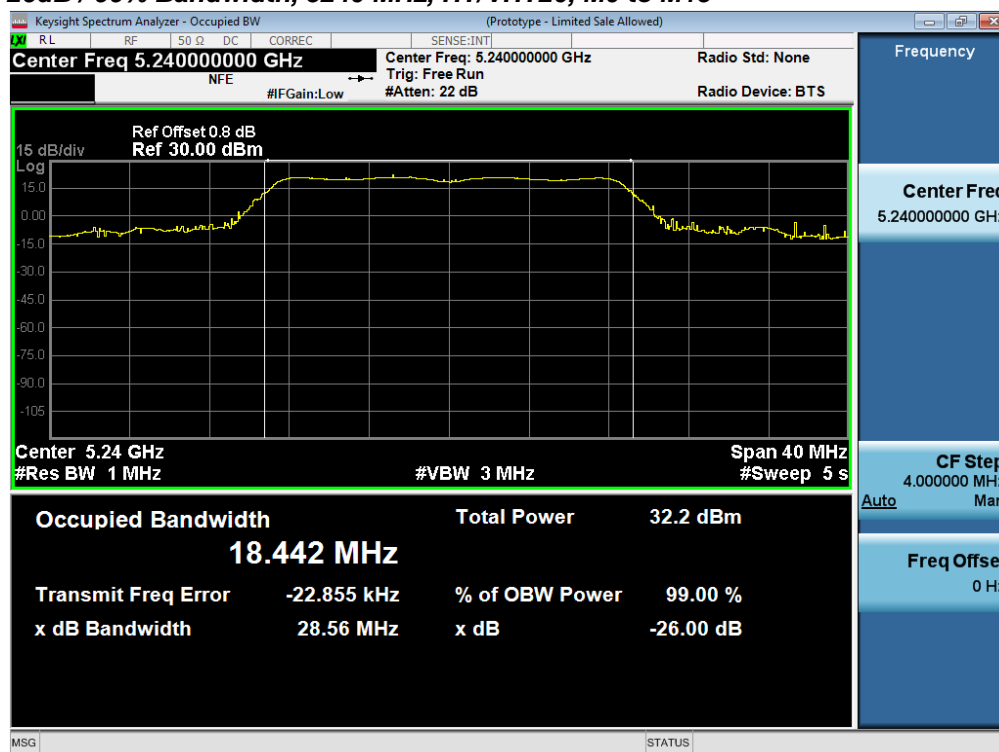

A.2 Maximum Conducted Output Power/ Power Spectral Density

15.407 (i) For an outdoor access point operating in the band 5.15-5.25 GHz, the maximum conducted output power over the frequency band of operation shall not exceed 1 W provided the maximum antenna gain does not exceed 6 dBi. In addition, the maximum power spectral density shall not exceed 17 dBm in any 1 megahertz band. If transmitting antennas of directional gain greater than 6 dBi are used, both the maximum conducted output power and the maximum power spectral density shall be reduced by the amount in dB that the directional gain of the antenna exceeds 6 dBi. The maximum e.i.r.p. at any elevation angle above 30 degrees as measured from the horizon must not exceed 125 mW (21 dBm).

(ii) For an indoor access point operating in the band 5.15-5.25 GHz, the maximum conducted output power over the frequency band of operation shall not exceed 1 W provided the maximum antenna gain does not exceed 6 dBi. In addition, the maximum power spectral density shall not exceed 17 dBm in any 1 megahertz band. If transmitting antennas of directional gain greater than 6 dBi are used, both the maximum conducted output power and the maximum power spectral density shall be reduced by the amount in dB that the directional gain of the antenna exceeds 6 dBi.

Test Procedure

Ref. KDB 789033 D02 General UNII Test Procedures New Rules v01r03
ANSI C63.10: 2013

Output Power Test Procedure
<ol style="list-style-type: none"> 1. Set the radio in the continuous transmitting mode at full power 2. Compute power by integrating the spectrum across the EBW (or alternatively entire 99% OBW) of the signal using the instrument's band power measurement function. The integration shall be performed using the spectrum analyzer band-power measurement function with band limits set equal to the EBW or the OBW band edges. 3. Capture graphs and record pertinent measurement data.

Ref. KDB 789033 D02 General UNII Test Procedures New Rules v01r03
ANSI C63.10: 2013 section 12.3.2.2 Method SA-1

Output Power Test parameters
Span = >1.5 times the OBW RBW = 1MHz VBW ≥ 3 x RBW Sweep = Auto couple Detector = sample Trace = Trace Average 100

The "measure-and-sum technique" is used for measuring in-band transmit power of a device. In the measure-and-sum approach, the conducted emission level is measured at each antenna port. The measured results at the various antenna ports are then summed mathematically to determine the total emission level from the device. Summing is performed in linear power units. (See ANSI C63.10 section 14.3.2.2)

System Number	Description	Samples	System under test	Support equipment
1	EUT	S01	<input checked="" type="checkbox"/>	<input type="checkbox"/>
	Support	S02	<input type="checkbox"/>	<input checked="" type="checkbox"/>



Tested By : Jose Aguirre	Date of testing: 20-April-16 - 08-Aug-16
Test Result : PASS	

See Appendix C for list of test equipment

Antenna Gain: 5 dBi

Frequency (MHz)	Mode	Tx Paths	Correlated Antenna Gain (dBi)	Tx 1 Max Power (dBm)	Tx 2 Max Power (dBm)	Total Tx Channel Power (dBm)	Limit (dBm)	Margin (dB)
5180	Non HT20, 6 to 54 Mbps	1	5	17.3		17.3	30.0	12.7
	Non HT20, 6 to 54 Mbps	2	5	15.7	15.4	18.6	30.0	11.4
	Non HT20 Beam Forming, 6 to 54 Mbps	2	8	14.7	14.5	17.6	28.0	10.4
	HT/VHT20, M0 to M7	1	5	15.6		15.6	30.0	14.4
	HT/VHT20, M0 to M7	2	5	15.8	15.6	18.7	30.0	11.3
	HT/VHT20, M8 to M15	2	5	15.8	15.6	18.7	30.0	11.3
	HT/VHT20 Beam Forming, M0 to M7	2	8	13.7	13.1	16.4	28.0	11.6
	HT/VHT20 Beam Forming, M8 to M15	2	5	15.8	15.6	18.7	30.0	11.3
	HT/VHT20 STBC, M0 to M7	2	5	15.8	15.6	18.7	30.0	11.3
5190	Non HT40, 6 to 54 Mbps	1	5	14.7		14.7	30.0	15.3
	Non HT40, 6 to 54 Mbps	2	5	11.0	10.7	13.9	30.0	16.1
	HT/VHT40, M0 to M7	1	5	15.5		15.5	30.0	14.5
	HT/VHT40, M0 to M7	2	5	12.3	12.0	15.2	30.0	14.8
	HT/VHT40, M8 to M15	2	5	12.3	12.0	15.2	30.0	14.8
	HT/VHT40 Beam Forming, M0 to M7	2	8	11.4	11.1	14.3	28.0	13.7
	HT/VHT40 Beam Forming, M8 to M15	2	5	12.3	12.0	15.2	30.0	14.8
	HT/VHT40 STBC, M0 to M7	2	5	12.3	12.0	15.2	30.0	14.8
5210	Non HT80, 6 to 54 Mbps	1	5	12.2		12.2	30.0	17.8
	Non HT80, 6 to 54 Mbps	2	5	11.5	11.3	14.4	30.0	15.6
	VHT80, M0 to M9 1ss	1	5	13.9		13.9	30.0	16.1
	VHT80, M0 to M9 1ss	2	5	10.9	10.5	13.7	30.0	16.3
	VHT80, M0 to M9 2ss	2	5	10.9	10.5	13.7	30.0	16.3
	VHT80 Beam Forming, M0 to M9 1ss	2	8	10.5	10.0	13.3	28.0	14.7
	VHT80 Beam Forming, M0 to M9 2ss	2	5	10.9	10.5	13.7	30.0	16.3
	VHT80 STBC, M0 to M9 1ss	2	5	10.9	10.5	13.7	30.0	16.3
5220	Non HT20, 6 to 54 Mbps	1	5	23.6		23.6	30.0	6.4
	Non HT20, 6 to 54 Mbps	2	5	22.5	22.7	25.6	30.0	4.4
	Non HT20 Beam Forming, 6 to 54 Mbps	2	8	19.3	20.2	22.8	28.0	5.2
	HT/VHT20, M0 to M7	1	5	23.7		23.7	30.0	6.3
	HT/VHT20, M0 to M7	2	5	22.6	22.8	25.7	30.0	4.3
	HT/VHT20, M8 to M15	2	5	22.6	22.8	25.7	30.0	4.3
	HT/VHT20 Beam Forming, M0 to M7	2	8	19.5	20.4	23.0	28.0	5.0

	HT/VHT20 Beam Forming, M8 to M15	2	5	22.6	22.8	25.7	30.0	4.3
	HT/VHT20 STBC, M0 to M7	2	5	22.6	22.8	25.7	30.0	4.3
5230	Non HT40, 6 to 54 Mbps	1	5	24.8		24.8	30.0	5.2
	Non HT40, 6 to 54 Mbps	2	5	22.8	23.1	26.0	30.0	4.0
	HT/VHT40, M0 to M7	1	5	23.8		23.8	30.0	6.2
	HT/VHT40, M0 to M7	2	5	22.8	22.6	25.7	30.0	4.3
	HT/VHT40, M8 to M15	2	5	22.8	22.6	25.7	30.0	4.3
	HT/VHT40 Beam Forming, M0 to M7	2	8	19.8	20.1	23.0	28.0	5.0
	HT/VHT40 Beam Forming, M8 to M15	2	5	22.8	22.6	25.7	30.0	4.3
	HT/VHT40 STBC, M0 to M7	2	5	22.8	22.6	25.7	30.0	4.3
5240	Non HT20, 6 to 54 Mbps	1	5	24.0		24.0	30.0	6.0
	Non HT20, 6 to 54 Mbps	2	5	21.9	22.2	25.1	30.0	4.9
	Non HT20 Beam Forming, 6 to 54 Mbps	2	8	18.6	19.0	21.8	28.0	6.2
	HT/VHT20, M0 to M7	1	5	24.1		24.1	30.0	5.9
	HT/VHT20, M0 to M7	2	5	22.0	22.3	25.2	30.0	4.8
	HT/VHT20, M8 to M15	2	5	23.0	22.8	25.9	30.0	4.1
	HT/VHT20 Beam Forming, M0 to M7	2	8	18.7	19.1	21.9	28.0	6.1
	HT/VHT20 Beam Forming, M8 to M15	2	5	23.0	22.8	25.9	30.0	4.1
	HT/VHT20 STBC, M0 to M7	2	5	23.0	22.8	25.9	30.0	4.1

Maximum Transmit Power, 5230 MHz, Non HT40, 6 to 54 Mbps



Antenna A



Antenna B

Antenna Gain: 7 dBi

Frequency (MHz)	Mode	Tx Paths	Correlated Antenna Gain (dBi)	Tx 1 Max Power (dBm)	Tx 2 Max Power (dBm)	Total Tx Channel Power (dBm)	Limit (dBm)	Margin (dB)
5180	Non HT20, 6 to 54 Mbps	1	7	15.4		15.4	29.0	13.6
	Non HT20, 6 to 54 Mbps	2	7	14.7	14.5	17.6	29.0	11.4
	Non HT20 Beam Forming, 6 to 54 Mbps	2	10	13.8	13.5	16.7	26.0	9.3
	HT/VHT20, M0 to M7	1	7	15.6		15.6	29.0	13.4
	HT/VHT20, M0 to M7	2	7	14.9	14.7	17.8	29.0	11.2
	HT/VHT20, M8 to M15	2	7	14.9	14.7	17.8	29.0	11.2
	HT/VHT20 Beam Forming, M0 to M7	2	10	13.1	12.6	15.9	26.0	10.1
	HT/VHT20 Beam Forming, M8 to M15	2	7	14.9	14.7	17.8	29.0	11.2
	HT/VHT20 STBC, M0 to M7	2	7	14.9	14.7	17.8	29.0	11.2
5190	Non HT40, 6 to 54 Mbps	1	7	12.5		12.5	29.0	16.5
	Non HT40, 6 to 54 Mbps	2	7	10.2	9.7	13.0	29.0	16.0
	HT/VHT40, M0 to M7	1	7	13.6		13.6	29.0	15.4
	HT/VHT40, M0 to M7	2	7	11.4	11.1	14.3	29.0	14.7
	HT/VHT40, M8 to M15	2	7	11.4	11.1	14.3	29.0	14.7
	HT/VHT40 Beam Forming, M0 to M7	2	10	10.5	10.1	13.3	26.0	12.7
	HT/VHT40 Beam Forming, M8 to M15	2	7	11.4	11.1	14.3	29.0	14.7
	HT/VHT40 STBC, M0 to M7	2	7	11.4	11.1	14.3	29.0	14.7
5210	Non HT80, 6 to 54 Mbps	1	7	11.3		11.3	29.0	17.7
	Non HT80, 6 to 54 Mbps	2	7	10.5	10.4	13.5	29.0	15.5
	VHT80, M0 to M9 1ss	1	7	13.9		13.9	29.0	15.1
	VHT80, M0 to M9 1ss	2	7	10.5	10.0	13.3	29.0	15.7
	VHT80, M0 to M9 2ss	2	7	10.5	10.0	13.3	29.0	15.7
	VHT80 Beam Forming, M0 to M9 1ss	2	10	9.6	9.1	12.4	26.0	13.6
	VHT80 Beam Forming, M0 to M9 2ss	2	7	10.5	10.0	13.3	29.0	15.7
	VHT80 STBC, M0 to M9 1ss	2	7	10.5	10.0	13.3	29.0	15.7
5220	Non HT20, 6 to 54 Mbps	1	7	23.6		23.6	29.0	5.4
	Non HT20, 6 to 54 Mbps	2	7	19.3	20.2	22.8	29.0	6.2
	Non HT20 Beam Forming, 6 to 54 Mbps	2	10	20.9	19.3	23.2	26.0	2.8
	HT/VHT20, M0 to M7	1	7	23.7		23.7	29.0	5.3
	HT/VHT20, M0 to M7	2	7	19.5	20.4	23.0	29.0	6.0
	HT/VHT20, M8 to M15	2	7	23.7	23.8	26.8	29.0	2.2
	HT/VHT20 Beam Forming, M0 to M7	2	10	20.9	19.5	23.3	26.0	2.7

	HT/VHT20 Beam Forming, M8 to M15	2	7	23.7	23.8	26.8	29.0	2.2
	HT/VHT20 STBC, M0 to M7	2	7	23.7	23.8	26.8	29.0	2.2
5230	Non HT40, 6 to 54 Mbps	1	7	24.8		24.8	29.0	4.2
	Non HT40, 6 to 54 Mbps	2	7	23.1	21.8	25.5	29.0	3.5
	HT/VHT40, M0 to M7	1	7	23.8		23.8	29.0	5.2
	HT/VHT40, M0 to M7	2	7	23.8	23.6	26.7	29.0	2.3
	HT/VHT40, M8 to M15	2	7	23.8	23.6	26.7	29.0	2.3
	HT/VHT40 Beam Forming, M0 to M7	2	10	20.7	20.9	23.8	26.0	2.2
	HT/VHT40 Beam Forming, M8 to M15	2	7	23.8	23.6	26.7	29.0	2.3
	HT/VHT40 STBC, M0 to M7	2	7	23.8	23.6	26.7	29.0	2.3
5240	Non HT20, 6 to 54 Mbps	1	7	24.0		24.0	29.0	5.0
	Non HT20, 6 to 54 Mbps	2	7	20.1	20.2	23.2	29.0	5.8
	Non HT20 Beam Forming, 6 to 54 Mbps	2	10	20.2	20.3	23.3	26.0	2.7
	HT/VHT20, M0 to M7	1	7	24.1		24.1	29.0	4.9
	HT/VHT20, M0 to M7	2	7	20.2	20.3	23.3	29.0	5.7
	HT/VHT20, M8 to M15	2	7	24.5	23.0	26.8	29.0	2.2
	HT/VHT20 Beam Forming, M0 to M7	2	10	20.3	20.5	23.4	26.0	2.6
	HT/VHT20 Beam Forming, M8 to M15	2	7	24.5	23.0	26.8	29.0	2.2
	HT/VHT20 STBC, M0 to M7	2	7	24.5	23.0	26.8	29.0	2.2

Maximum Transmit Power, 5240 MHz, HT/VHT20, M8 to M15



Antenna A



Antenna B

Antenna Gain: 8 dBi

Frequency (MHz)	Mode	Tx Paths	Correlated Antenna Gain (dBi)	Tx 1 Max Power (dBm)	Tx 2 Max Power (dBm)	Total Tx Channel Power (dBm)	Limit (dBm)	Margin (dB)
5180	Non HT20, 6 to 54 Mbps	1	8	15.4		15.4	28.0	12.6
	Non HT20, 6 to 54 Mbps	2	8	13.8	13.5	16.7	28.0	11.3
	Non HT20 Beam Forming, 6 to 54 Mbps	2	11	11.8	11.6	14.7	25.0	10.3
	HT/VHT20, M0 to M7	1	8	15.6		15.6	28.0	12.4
	HT/VHT20, M0 to M7	2	8	14.0	13.7	16.9	28.0	11.1
	HT/VHT20, M8 to M15	2	8	14.0	13.7	16.9	28.0	11.1
	HT/VHT20 Beam Forming, M0 to M7	2	11	12.0	11.7	14.9	25.0	10.1
	HT/VHT20 Beam Forming, M8 to M15	2	8	14.0	13.7	16.9	28.0	11.1
	HT/VHT20 STBC, M0 to M7	2	8	14.0	13.7	16.9	28.0	11.1
5190	Non HT40, 6 to 54 Mbps	1	8	12.5		12.5	28.0	15.5
	Non HT40, 6 to 54 Mbps	2	8	9.7	9.4	12.6	28.0	15.4
	HT/VHT40, M0 to M7	1	8	13.6		13.6	28.0	14.4
	HT/VHT40, M0 to M7	2	8	10.5	10.1	13.3	28.0	14.7
	HT/VHT40, M8 to M15	2	8	10.5	10.1	13.3	28.0	14.7
	HT/VHT40 Beam Forming, M0 to M7	2	11	9.5	9.2	12.4	25.0	12.6
	HT/VHT40 Beam Forming, M8 to M15	2	8	10.5	10.1	13.3	28.0	14.7
	HT/VHT40 STBC, M0 to M7	2	8	10.5	10.1	13.3	28.0	14.7
5210	Non HT80, 6 to 54 Mbps	1	8	11.3		11.3	28.0	16.7
	Non HT80, 6 to 54 Mbps	2	8	9.6	9.5	12.6	28.0	15.4
	VHT80, M0 to M9 1ss	1	8	11.8		11.8	28.0	16.2
	VHT80, M0 to M9 1ss	2	8	10.9	10.5	13.7	28.0	14.3
	VHT80, M0 to M9 2ss	2	8	10.9	10.5	13.7	28.0	14.3
	VHT80 Beam Forming, M0 to M9 1ss	2	11	9.1	9.1	12.1	25.0	12.9
	VHT80 Beam Forming, M0 to M9 2ss	2	8	10.9	10.5	13.7	28.0	14.3
	VHT80 STBC, M0 to M9 1ss	2	8	10.9	10.5	13.7	28.0	14.3
5220	Non HT20, 6 to 54 Mbps	1	8	18.0		18.0	28.0	10.0
	Non HT20, 6 to 54 Mbps	2	8	15.4	14.2	17.9	28.0	10.1
	Non HT20 Beam Forming, 6 to 54 Mbps	2	11	12.2	11.3	14.8	25.0	10.2
	HT/VHT20, M0 to M7	1	8	17.3		17.3	28.0	10.7
	HT/VHT20, M0 to M7	2	8	15.5	14.4	18.0	28.0	10.0
	HT/VHT20, M8 to M15	2	8	15.5	14.4	18.0	28.0	10.0
	HT/VHT20 Beam Forming, M0 to M7	2	11	12.4	11.5	15.0	25.0	10.0

	HT/VHT20 Beam Forming, M8 to M15	2	8	15.5	14.4	18.0	28.0	10.0
	HT/VHT20 STBC, M0 to M7	2	8	15.5	14.4	18.0	28.0	10.0
5230	Non HT40, 6 to 54 Mbps	1	8	17.2		17.2	28.0	10.8
	Non HT40, 6 to 54 Mbps	2	8	14.6	14.5	17.6	28.0	10.4
	HT/VHT40, M0 to M7	1	8	17.2		17.2	28.0	10.8
	HT/VHT40, M0 to M7	2	8	14.3	14.6	17.5	28.0	10.5
	HT/VHT40, M8 to M15	2	8	14.3	14.6	17.5	28.0	10.5
	HT/VHT40 Beam Forming, M0 to M7	2	11	11.2	11.5	14.4	25.0	10.6
	HT/VHT40 Beam Forming, M8 to M15	2	8	14.3	14.6	17.5	28.0	10.5
	HT/VHT40 STBC, M0 to M7	2	8	14.3	14.6	17.5	28.0	10.5
5240	Non HT20, 6 to 54 Mbps	1	8	17.1		17.1	28.0	10.9
	Non HT20, 6 to 54 Mbps	2	8	14.3	14.8	17.6	28.0	10.4
	Non HT20 Beam Forming, 6 to 54 Mbps	2	11	11.2	11.7	14.5	25.0	10.5
	HT/VHT20, M0 to M7	1	8	17.3		17.3	28.0	10.7
	HT/VHT20, M0 to M7	2	8	14.5	14.9	17.7	28.0	10.3
	HT/VHT20, M8 to M15	2	8	14.5	14.9	17.7	28.0	10.3
	HT/VHT20 Beam Forming, M0 to M7	2	11	11.2	11.8	14.5	25.0	10.5
	HT/VHT20 Beam Forming, M8 to M15	2	8	14.5	14.9	17.7	28.0	10.3
	HT/VHT20 STBC, M0 to M7	2	8	14.5	14.9	17.7	28.0	10.3

Maximum Transmit Power, 5220 MHz, Non HT20, 6 to 54 Mbps



Antenna A

Antenna Gain: 13 dBi

Frequency (MHz)	Mode	Tx Paths	Correlated Antenna Gain (dBi)	Tx 1 Max Power (dBm)	Tx 2 Max Power (dBm)	Total Tx Channel Power (dBm)	Limit (dBm)	Margin (dB)
5180	Non HT20, 6 to 54 Mbps	1	13	13.8		13.8	23.0	9.2
	Non HT20, 6 to 54 Mbps	2	13	12.4	12.3	15.4	23.0	7.6
	Non HT20 Beam Forming, 6 to 54 Mbps	2	13	12.4	12.3	15.4	23.0	7.6
	HT/VHT20, M0 to M7	1	13	14.0		14.0	23.0	9.0
	HT/VHT20, M0 to M7	2	13	11.4	11.0	14.2	23.0	8.8
	HT/VHT20, M8 to M15	2	13	11.4	11.0	14.2	23.0	8.8
	HT/VHT20 Beam Forming, M0 to M7	2	13	11.4	11.0	14.2	23.0	8.8
	HT/VHT20 Beam Forming, M8 to M15	2	13	11.4	11.0	14.2	23.0	8.8
	HT/VHT20 STBC, M0 to M7	2	13	11.4	11.0	14.2	23.0	8.8
5190	Non HT40, 6 to 54 Mbps	1	13	9.7		9.7	23.0	13.3
	Non HT40, 6 to 54 Mbps	2	13	8.1	7.9	11.0	23.0	12.0
	HT/VHT40, M0 to M7	1	13	10.5		10.5	23.0	12.5
	HT/VHT40, M0 to M7	2	13	9.5	9.2	12.4	23.0	10.6
	HT/VHT40, M8 to M15	2	13	9.5	9.2	12.4	23.0	10.6
	HT/VHT40 Beam Forming, M0 to M7	2	13	9.5	9.2	12.4	23.0	10.6
	HT/VHT40 Beam Forming, M8 to M15	2	13	9.5	9.2	12.4	23.0	10.6
	HT/VHT40 STBC, M0 to M7	2	13	9.5	9.2	12.4	23.0	10.6
5210	Non HT80, 6 to 54 Mbps	1	13	7.8		7.8	23.0	15.2
	Non HT80, 6 to 54 Mbps	2	13	6.6	6.5	9.6	23.0	13.4
	VHT80, M0 to M9 1ss	1	13	9.6		9.6	23.0	13.4
	VHT80, M0 to M9 1ss	2	13	8.6	8.2	11.4	23.0	11.6
	VHT80, M0 to M9 2ss	2	13	8.6	8.2	11.4	23.0	11.6
	VHT80 Beam Forming, M0 to M9 1ss	2	13	8.6	8.2	11.4	23.0	11.6
	VHT80 Beam Forming, M0 to M9 2ss	2	13	8.6	8.2	11.4	23.0	11.6
	VHT80 STBC, M0 to M9 1ss	2	13	8.6	8.2	11.4	23.0	11.6
5220	Non HT20, 6 to 54 Mbps	1	13	20.4		20.4	23.0	2.6
	Non HT20, 6 to 54 Mbps	2	13	17.2	17.2	20.2	23.0	2.8
	Non HT20 Beam Forming, 6 to 54 Mbps	2	13	17.2	17.2	20.2	23.0	2.8
	HT/VHT20, M0 to M7	1	13	20.6		20.6	23.0	2.4
	HT/VHT20, M0 to M7	2	13	17.3	17.3	20.3	23.0	2.7
	HT/VHT20, M8 to M15	2	13	17.3	17.3	20.3	23.0	2.7
	HT/VHT20 Beam Forming, M0 to M7	2	13	17.3	17.3	20.3	23.0	2.7

	HT/VHT20 Beam Forming, M8 to M15	2	13	17.3	17.3	20.3	23.0	2.7
	HT/VHT20 STBC, M0 to M7	2	13	17.3	17.3	20.3	23.0	2.7
5230	Non HT40, 6 to 54 Mbps	1	13	21.8		21.8	23.0	1.2
	Non HT40, 6 to 54 Mbps	2	13	19.7	19.7	22.7	23.0	0.3
	HT/VHT40, M0 to M7	1	13	22.8		22.8	23.0	0.2
	HT/VHT40, M0 to M7	2	13	20.2	19.6	22.9	23.0	0.1
	HT/VHT40, M8 to M15	2	13	20.2	19.6	22.9	23.0	0.1
	HT/VHT40 Beam Forming, M0 to M7	2	13	20.2	19.6	22.9	23.0	0.1
	HT/VHT40 Beam Forming, M8 to M15	2	13	20.2	19.6	22.9	23.0	0.1
	HT/VHT40 STBC, M0 to M7	2	13	20.2	19.6	22.9	23.0	0.1
5240	Non HT20, 6 to 54 Mbps	1	13	20.2		20.2	23.0	2.8
	Non HT20, 6 to 54 Mbps	2	13	17.1	17.6	20.4	23.0	2.6
	Non HT20 Beam Forming, 6 to 54 Mbps	2	13	17.1	17.6	20.4	23.0	2.6
	HT/VHT20, M0 to M7	1	13	20.3		20.3	23.0	2.7
	HT/VHT20, M0 to M7	2	13	17.3	17.7	20.5	23.0	2.5
	HT/VHT20, M8 to M15	2	13	17.3	17.7	20.5	23.0	2.5
	HT/VHT20 Beam Forming, M0 to M7	2	13	17.3	17.7	20.5	23.0	2.5
	HT/VHT20 Beam Forming, M8 to M15	2	13	17.3	17.7	20.5	23.0	2.5
	HT/VHT20 STBC, M0 to M7	2	13	17.3	17.7	20.5	23.0	2.5

Maximum Transmit Power, 5230 MHz, HT/VHT40, M0 to M7



Antenna A



Antenna B

Antenna Gain: 14 dBi

Frequency (MHz)	Mode	Tx Paths	Correlated Antenna Gain (dBi)	Tx 1 Max Power (dBm)	Tx 2 Max Power (dBm)	Total Tx Channel Power (dBm)	Limit (dBm)	Margin (dB)
5180	Non HT20, 6 to 54 Mbps	1	14	12.4		12.4	22.0	9.6
	Non HT20, 6 to 54 Mbps	2	14	11.6	11.3	14.5	22.0	7.5
	Non HT20 Beam Forming, 6 to 54 Mbps	2	14	9.8	9.5	12.7	22.0	9.3
	HT/VHT20, M0 to M7	1	14	12.6		12.6	22.0	9.4
	HT/VHT20, M0 to M7	2	14	11.7	11.4	14.6	22.0	7.4
	HT/VHT20, M8 to M15	2	14	11.7	11.4	14.6	22.0	7.4
	HT/VHT20 Beam Forming, M0 to M7	2	14	9.9	9.6	12.8	22.0	9.2
	HT/VHT20 Beam Forming, M8 to M15	2	14	11.7	11.4	14.6	22.0	7.4
	HT/VHT20 STBC, M0 to M7	2	14	11.7	11.4	14.6	22.0	7.4
5190	Non HT40, 6 to 54 Mbps	1	14	8.8		8.8	22.0	13.2
	Non HT40, 6 to 54 Mbps	2	14	7.9	7.4	10.7	22.0	11.3
	HT/VHT40, M0 to M7	1	14	10.1		10.1	22.0	11.9
	HT/VHT40, M0 to M7	2	14	8.6	8.2	11.4	22.0	10.6
	HT/VHT40, M8 to M15	2	14	8.6	8.2	11.4	22.0	10.6
	HT/VHT40 Beam Forming, M0 to M7	2	14	8.6	8.2	11.4	22.0	10.6
	HT/VHT40 Beam Forming, M8 to M15	2	14	8.6	8.2	11.4	22.0	10.6
	HT/VHT40 STBC, M0 to M7	2	14	8.6	8.2	11.4	22.0	10.6
5210	Non HT80, 6 to 54 Mbps	1	14	6.6		6.6	22.0	15.4
	Non HT80, 6 to 54 Mbps	2	14	6.5	6.0	9.3	22.0	12.7
	VHT80, M0 to M9 1ss	1	14	8.6		8.6	22.0	13.4
	VHT80, M0 to M9 1ss	2	14	7.4	7.2	10.3	22.0	11.7
	VHT80, M0 to M9 2ss	2	14	7.4	7.2	10.3	22.0	11.7
	VHT80 Beam Forming, M0 to M9 1ss	2	14	7.4	7.2	10.3	22.0	11.7
	VHT80 Beam Forming, M0 to M9 2ss	2	14	7.4	7.2	10.3	22.0	11.7
	VHT80 STBC, M0 to M9 1ss	2	14	7.4	7.2	10.3	22.0	11.7
5220	Non HT20, 6 to 54 Mbps	1	14	15.3		15.3	22.0	6.7
	Non HT20, 6 to 54 Mbps	2	14	13.2	12.3	15.8	22.0	6.2
	Non HT20 Beam Forming, 6 to 54 Mbps	2	14	9.5	9.3	12.4	22.0	9.6
	HT/VHT20, M0 to M7	1	14	15.5		15.5	22.0	6.5
	HT/VHT20, M0 to M7	2	14	13.4	12.4	15.9	22.0	6.1
	HT/VHT20, M8 to M15	2	14	13.4	12.4	15.9	22.0	6.1
	HT/VHT20 Beam Forming, M0 to M7	2	14	9.7	9.5	12.6	22.0	9.4

	HT/VHT20 Beam Forming, M8 to M15	2	14	13.4	12.4	15.9	22.0	6.1
	HT/VHT20 STBC, M0 to M7	2	14	13.4	12.4	15.9	22.0	6.1
5230	Non HT40, 6 to 54 Mbps	1	14	15.6		15.6	22.0	6.4
	Non HT40, 6 to 54 Mbps	2	14	12.8	12.6	15.7	22.0	6.3
	HT/VHT40, M0 to M7	1	14	15.3		15.3	22.0	6.7
	HT/VHT40, M0 to M7	2	14	12.2	12.4	15.3	22.0	6.7
	HT/VHT40, M8 to M15	2	14	12.2	12.4	15.3	22.0	6.7
	HT/VHT40 Beam Forming, M0 to M7	2	14	9.8	9.4	12.6	22.0	9.4
	HT/VHT40 Beam Forming, M8 to M15	2	14	12.2	12.4	15.3	22.0	6.7
	HT/VHT40 STBC, M0 to M7	2	14	12.2	12.4	15.3	22.0	6.7
5240	Non HT20, 6 to 54 Mbps	1	14	15.2		15.2	22.0	6.8
	Non HT20, 6 to 54 Mbps	2	14	12.0	12.5	15.3	22.0	6.7
	Non HT20 Beam Forming, 6 to 54 Mbps	2	14	9.8	9.3	12.6	22.0	9.4
	HT/VHT20, M0 to M7	1	14	15.4		15.4	22.0	6.6
	HT/VHT20, M0 to M7	2	14	12.2	12.6	15.4	22.0	6.6
	HT/VHT20, M8 to M15	2	14	12.2	12.6	15.4	22.0	6.6
	HT/VHT20 Beam Forming, M0 to M7	2	14	9.9	9.4	12.7	22.0	9.3
	HT/VHT20 Beam Forming, M8 to M15	2	14	12.2	12.6	15.4	22.0	6.6
	HT/VHT20 STBC, M0 to M7	2	14	12.2	12.6	15.4	22.0	6.6

Maximum Transmit Power, 5220 MHz, HT/VHT20, M0 to M7

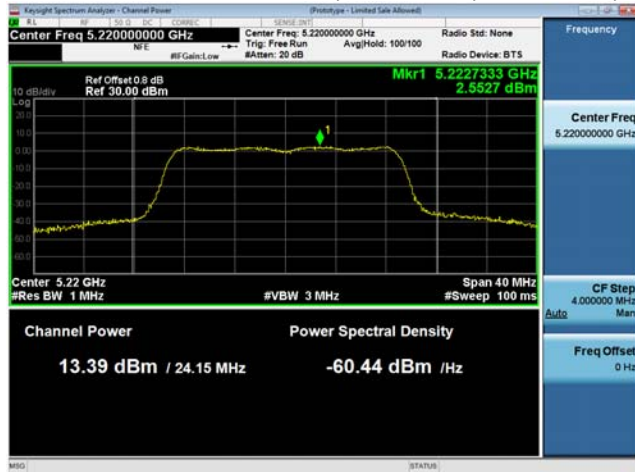

Antenna A



Antenna B

Power Spectral Density

Antenna Gain: 5 dBi

Frequency (MHz)	Mode	Tx Paths	Correlated Antenna Gain (dBi)	Tx 1 PSD (dBm/MHz)	Tx 2 PSD (dBm/MHz)	Total PSD (dBm/MHz)	Limit (dBm/MHz)	Margin (dB)
5180	Non HT20, 6 to 54 Mbps	1	5	6.8		6.8	17.0	10.2
	Non HT20, 6 to 54 Mbps	2	8	4.9	4.6	7.8	15.0	7.2
	Non HT20 Beam Forming, 6 to 54 Mbps	2	8	4.4	4.4	7.4	15.0	7.6
	HT/VHT20, M0 to M7	1	5	4.7		4.7	17.0	12.3
	HT/VHT20, M0 to M7	2	8	4.8	4.7	7.8	15.0	7.2
	HT/VHT20, M8 to M15	2	5	4.8	4.7	7.8	17.0	9.2
	HT/VHT20 Beam Forming, M0 to M7	2	8	2.9	2.8	5.9	15.0	9.1
	HT/VHT20 Beam Forming, M8 to M15	2	5	4.8	4.7	7.8	17.0	9.2
	HT/VHT20 STBC, M0 to M7	2	5	4.8	4.7	7.8	17.0	9.2
5190	Non HT40, 6 to 54 Mbps	1	5	1.3		1.3	17.0	15.7
	Non HT40, 6 to 54 Mbps	2	8	-2.5	-2.6	0.5	15.0	14.5
	HT/VHT40, M0 to M7	1	5	1.7		1.7	17.0	15.3
	HT/VHT40, M0 to M7	2	8	-1.5	-1.5	1.5	15.0	13.5
	HT/VHT40, M8 to M15	2	5	-1.5	-1.5	1.5	17.0	15.5
	HT/VHT40 Beam Forming, M0 to M7	2	8	-2.5	-2.6	0.5	15.0	14.5
	HT/VHT40 Beam Forming, M8 to M15	2	5	-1.5	-1.5	1.5	17.0	15.5
	HT/VHT40 STBC, M0 to M7	2	5	-1.5	-1.5	1.5	17.0	15.5
5210	Non HT80, 6 to 54 Mbps	1	5	-4.3		-4.3	17.0	21.3
	Non HT80, 6 to 54 Mbps	2	8	-5.4	-5.2	-2.3	15.0	17.3
	VHT80, M0 to M9 1ss	1	5	-3.2		-3.2	17.0	20.2
	VHT80, M0 to M9 1ss	2	8	-5.9	-6.6	-3.2	15.0	18.2
	VHT80, M0 to M9 2ss	2	5	-5.9	-6.6	-3.2	17.0	20.2
	VHT80 Beam Forming, M0 to M9 1ss	2	8	-6.6	-7.3	-3.9	15.0	18.9
	VHT80 Beam Forming, M0 to M9 2ss	2	5	-5.9	-6.6	-3.2	17.0	20.2
	VHT80 STBC, M0 to M9 1ss	2	5	-5.9	-6.6	-3.2	17.0	20.2
5220	Non HT20, 6 to 54 Mbps	1	5	12.9		12.9	17.0	4.1
	Non HT20, 6 to 54 Mbps	2	8	12.0	11.9	15.0	15.0	0.0
	Non HT20 Beam Forming, 6 to 54 Mbps	2	8	8.7	9.9	12.4	15.0	2.6
	HT/VHT20, M0 to M7	1	5	12.8		12.8	17.0	4.2
	HT/VHT20, M0 to M7	2	8	11.7	12.1	14.9	15.0	0.1

	HT/VHT20, M8 to M15	2	5	11.7	12.1	14.9	17.0	2.1
	HT/VHT20 Beam Forming, M0 to M7	2	8	8.6	9.5	12.1	15.0	2.9
	HT/VHT20 Beam Forming, M8 to M15	2	5	11.7	12.1	14.9	17.0	2.1
	HT/VHT20 STBC, M0 to M7	2	5	11.7	12.1	14.9	17.0	2.1
5230	Non HT40, 6 to 54 Mbps	1	5	11.3		11.3	17.0	5.7
	Non HT40, 6 to 54 Mbps	2	8	9.3	9.7	12.5	15.0	2.5
	HT/VHT40, M0 to M7	1	5	9.9		9.9	17.0	7.1
	HT/VHT40, M0 to M7	2	8	9.0	8.9	12.0	15.0	3.0
	HT/VHT40, M8 to M15	2	5	9.0	8.9	12.0	17.0	5.0
	HT/VHT40 Beam Forming, M0 to M7	2	8	6.0	6.5	9.3	15.0	5.7
	HT/VHT40 Beam Forming, M8 to M15	2	5	9.0	8.9	12.0	17.0	5.0
	HT/VHT40 STBC, M0 to M7	2	5	9.0	8.9	12.0	17.0	5.0
5240	Non HT20, 6 to 54 Mbps	1	5	13.6		13.6	17.0	3.4
	Non HT20, 6 to 54 Mbps	2	8	11.4	11.7	14.6	15.0	0.4
	Non HT20 Beam Forming, 6 to 54 Mbps	2	8	8.0	8.5	11.3	15.0	3.7
	HT/VHT20, M0 to M7	1	5	14.1		14.1	17.0	2.9
	HT/VHT20, M0 to M7	2	8	11.2	11.5	14.4	15.0	0.6
	HT/VHT20, M8 to M15	2	5	12.2	11.9	15.1	17.0	1.9
	HT/VHT20 Beam Forming, M0 to M7	2	8	8.0	8.3	11.2	15.0	3.8
	HT/VHT20 Beam Forming, M8 to M15	2	5	12.2	11.9	15.1	17.0	1.9
	HT/VHT20 STBC, M0 to M7	2	5	12.2	11.9	15.1	17.0	1.9

Power Spectral Density, 5220 MHz, Non HT20, 6 to 54 Mbps



Antenna A



Antenna B

Antenna Gain: 7 dBi

Frequency (MHz)	Mode	Tx Paths	Correlated Antenna Gain (dBi)	Tx 1 PSD (dBm/MHz)	Tx 2 PSD (dBm/MHz)	Total PSD (dBm/MHz)	Limit (dBm/MHz)	Margin (dB)
5180	Non HT20, 6 to 54 Mbps	1	7	4.6		4.6	16.0	11.4
	Non HT20, 6 to 54 Mbps	2	10	4.4	4.4	7.4	13.0	5.6
	Non HT20 Beam Forming, 6 to 54 Mbps	2	10	3.1	2.9	6.0	13.0	7.0
	HT/VHT20, M0 to M7	1	7	4.7		4.7	16.0	11.3
	HT/VHT20, M0 to M7	2	10	4.3	4.0	7.2	13.0	5.8
	HT/VHT20, M8 to M15	2	7	4.3	4.0	7.2	16.0	8.8
	HT/VHT20 Beam Forming, M0 to M7	2	10	2.8	1.9	5.4	13.0	7.6
	HT/VHT20 Beam Forming, M8 to M15	2	7	4.3	4.0	7.2	16.0	8.8
	HT/VHT20 STBC, M0 to M7	2	7	4.3	4.0	7.2	16.0	8.8
5190	Non HT40, 6 to 54 Mbps	1	7	-0.5		-0.5	16.0	16.5
	Non HT40, 6 to 54 Mbps	2	10	-3.4	-3.6	-0.5	13.0	13.5
	HT/VHT40, M0 to M7	1	7	-0.2		-0.2	16.0	16.2
	HT/VHT40, M0 to M7	2	10	-2.5	-2.6	0.5	13.0	12.5
	HT/VHT40, M8 to M15	2	7	-2.5	-2.6	0.5	16.0	15.5
	HT/VHT40 Beam Forming, M0 to M7	2	10	-3.4	-3.1	-0.2	13.0	13.2
	HT/VHT40 Beam Forming, M8 to M15	2	7	-2.5	-2.6	0.5	16.0	15.5
	HT/VHT40 STBC, M0 to M7	2	7	-2.5	-2.6	0.5	16.0	15.5
5210	Non HT80, 6 to 54 Mbps	1	7	-5.2		-5.2	16.0	21.2
	Non HT80, 6 to 54 Mbps	2	10	-6.3	-5.9	-3.1	13.0	16.1
	VHT80, M0 to M9 1ss	1	7	-3.2		-3.2	16.0	19.2
	VHT80, M0 to M9 1ss	2	10	-6.6	-7.3	-3.9	13.0	16.9
	VHT80, M0 to M9 2ss	2	7	-6.6	-7.3	-3.9	16.0	19.9
	VHT80 Beam Forming, M0 to M9 1ss	2	10	-7.9	-8.4	-5.1	13.0	18.1
	VHT80 Beam Forming, M0 to M9 2ss	2	7	-6.6	-7.3	-3.9	16.0	19.9
	VHT80 STBC, M0 to M9 1ss	2	7	-6.6	-7.3	-3.9	16.0	19.9
5220	Non HT20, 6 to 54 Mbps	1	7	12.9		12.9	16.0	3.1
	Non HT20, 6 to 54 Mbps	2	10	8.7	9.9	12.4	13.0	0.6
	Non HT20 Beam Forming, 6 to 54 Mbps	2	10	10.4	8.7	12.6	13.0	0.4
	HT/VHT20, M0 to M7	1	7	12.8		12.8	16.0	3.2
	HT/VHT20, M0 to M7	2	10	8.6	9.5	12.1	13.0	0.9
	HT/VHT20, M8 to M15	2	7	12.8	12.8	15.8	16.0	0.2
	HT/VHT20 Beam Forming, M0 to M7	2	10	10.5	8.6	12.7	13.0	0.3



	HT/VHT20 Beam Forming, M8 to M15	2	7	12.8	12.8	15.8	16.0	0.2
	HT/VHT20 STBC, M0 to M7	2	7	12.8	12.8	15.8	16.0	0.2
5230	Non HT40, 6 to 54 Mbps	1	7	11.3		11.3	16.0	4.7
	Non HT40, 6 to 54 Mbps	2	10	9.7	8.2	12.0	13.0	1.0
	HT/VHT40, M0 to M7	1	7	9.9		9.9	16.0	6.1
	HT/VHT40, M0 to M7	2	10	9.9	9.7	12.8	13.0	0.2
	HT/VHT40, M8 to M15	2	7	9.9	9.7	12.8	16.0	3.2
	HT/VHT40 Beam Forming, M0 to M7	2	10	7.1	7.2	10.2	13.0	2.8
	HT/VHT40 Beam Forming, M8 to M15	2	7	9.9	9.7	12.8	16.0	3.2
	HT/VHT40 STBC, M0 to M7	2	7	9.9	9.7	12.8	16.0	3.2
5240	Non HT20, 6 to 54 Mbps	1	7	13.6		13.6	16.0	2.4
	Non HT20, 6 to 54 Mbps	2	10	9.6	9.7	12.7	13.0	0.3
	Non HT20 Beam Forming, 6 to 54 Mbps	2	10	9.7	9.7	12.7	13.0	0.3
	HT/VHT20, M0 to M7	1	7	14.1		14.1	16.0	1.9
	HT/VHT20, M0 to M7	2	10	9.4	9.7	12.6	13.0	0.4
	HT/VHT20, M8 to M15	2	7	13.5	12.2	15.9	16.0	0.1
	HT/VHT20 Beam Forming, M0 to M7	2	10	9.7	9.9	12.8	13.0	0.2
	HT/VHT20 Beam Forming, M8 to M15	2	7	13.5	12.2	15.9	16.0	0.1
	HT/VHT20 STBC, M0 to M7	2	7	13.5	12.2	15.9	16.0	0.1

Power Spectral Density, 5240 MHz, HT/VHT20, M8 to M15



Antenna A



Antenna B

Antenna Gain: 8 dBi

Frequency (MHz)	Mode	Tx Paths	Correlated Antenna Gain (dBi)	Tx 1 PSD (dBm/MHz)	Tx 2 PSD (dBm/MHz)	Total PSD (dBm/MHz)	Limit (dBm/MHz)	Margin (dB)
5180	Non HT20, 6 to 54 Mbps	1	8	4.6		4.6	15.0	10.4
	Non HT20, 6 to 54 Mbps	2	11	3.1	2.9	6.0	12.0	6.0
	Non HT20 Beam Forming, 6 to 54 Mbps	2	11	1.3	1.2	4.3	12.0	7.7
	HT/VHT20, M0 to M7	1	8	4.7		4.7	15.0	10.3
	HT/VHT20, M0 to M7	2	11	3.2	2.9	6.1	12.0	5.9
	HT/VHT20, M8 to M15	2	8	3.2	2.9	6.1	15.0	8.9
	HT/VHT20 Beam Forming, M0 to M7	2	11	1.0	0.8	3.9	12.0	8.1
	HT/VHT20 Beam Forming, M8 to M15	2	8	3.2	2.9	6.1	15.0	8.9
	HT/VHT20 STBC, M0 to M7	2	8	3.2	2.9	6.1	15.0	8.9
5190	Non HT40, 6 to 54 Mbps	1	8	-0.5		-0.5	15.0	15.5
	Non HT40, 6 to 54 Mbps	2	11	-3.6	-3.6	-0.6	12.0	12.6
	HT/VHT40, M0 to M7	1	8	-0.2		-0.2	15.0	15.2
	HT/VHT40, M0 to M7	2	11	-3.4	-3.1	-0.2	12.0	12.2
	HT/VHT40, M8 to M15	2	8	-3.4	-3.1	-0.2	15.0	15.2
	HT/VHT40 Beam Forming, M0 to M7	2	11	-4.3	-4.4	-1.3	12.0	13.3
	HT/VHT40 Beam Forming, M8 to M15	2	8	-3.4	-3.1	-0.2	15.0	15.2
	HT/VHT40 STBC, M0 to M7	2	8	-3.4	-3.1	-0.2	15.0	15.2
5210	Non HT80, 6 to 54 Mbps	1	8	-5.2		-5.2	15.0	20.2
	Non HT80, 6 to 54 Mbps	2	11	-7.4	-7.2	-4.3	12.0	16.3
	VHT80, M0 to M9 1ss	1	8	-5.2		-5.2	15.0	20.2
	VHT80, M0 to M9 1ss	2	11	-5.9	-6.6	-3.2	12.0	15.2
	VHT80, M0 to M9 2ss	2	8	-5.9	-6.6	-3.2	15.0	18.2
	VHT80 Beam Forming, M0 to M9 1ss	2	11	-8.4	-8.0	-5.2	12.0	17.2
	VHT80 Beam Forming, M0 to M9 2ss	2	8	-5.9	-6.6	-3.2	15.0	18.2
	VHT80 STBC, M0 to M9 1ss	2	8	-5.9	-6.6	-3.2	15.0	18.2
	5220	Non HT20, 6 to 54 Mbps	1	8	7.4		7.4	15.0
Non HT20, 6 to 54 Mbps		2	11	4.7	3.6	7.2	12.0	4.8
Non HT20 Beam Forming, 6 to 54 Mbps		2	11	1.8	1.1	4.5	12.0	7.5
HT/VHT20, M0 to M7		1	8	6.6		6.6	15.0	8.4
HT/VHT20, M0 to M7		2	11	4.9	3.5	7.3	12.0	4.7
HT/VHT20, M8 to M15		2	8	4.9	3.5	7.3	15.0	7.7
HT/VHT20 Beam Forming, M0 to M7		2	11	1.7	0.6	4.2	12.0	7.8

	HT/VHT20 Beam Forming, M8 to M15	2	8	4.9	3.5	7.3	15.0	7.7
	HT/VHT20 STBC, M0 to M7	2	8	4.9	3.5	7.3	15.0	7.7
5230	Non HT40, 6 to 54 Mbps	1	8	3.8		3.8	15.0	11.2
	Non HT40, 6 to 54 Mbps	2	11	1.1	1.1	4.1	12.0	7.9
	HT/VHT40, M0 to M7	1	8	3.3		3.3	15.0	11.7
	HT/VHT40, M0 to M7	2	11	0.6	0.9	3.8	12.0	8.2
	HT/VHT40, M8 to M15	2	8	0.6	0.9	3.8	15.0	11.2
	HT/VHT40 Beam Forming, M0 to M7	2	11	-2.5	-2.4	0.6	12.0	11.4
	HT/VHT40 Beam Forming, M8 to M15	2	8	0.6	0.9	3.8	15.0	11.2
	HT/VHT40 STBC, M0 to M7	2	8	0.6	0.9	3.8	15.0	11.2
5240	Non HT20, 6 to 54 Mbps	1	8	6.5		6.5	15.0	8.5
	Non HT20, 6 to 54 Mbps	2	11	3.8	4.1	7.0	12.0	5.0
	Non HT20 Beam Forming, 6 to 54 Mbps	2	11	0.6	1.0	3.8	12.0	8.2
	HT/VHT20, M0 to M7	1	8	6.6		6.6	15.0	8.4
	HT/VHT20, M0 to M7	2	11	3.6	4.4	7.0	12.0	5.0
	HT/VHT20, M8 to M15	2	8	3.6	4.4	7.0	15.0	8.0
	HT/VHT20 Beam Forming, M0 to M7	2	11	0.6	1.1	3.9	12.0	8.1
	HT/VHT20 Beam Forming, M8 to M15	2	8	3.6	4.4	7.0	15.0	8.0
	HT/VHT20 STBC, M0 to M7	2	8	3.6	4.4	7.0	15.0	8.0

Power Spectral Density, 5220 MHz, HT/VHT20, M0 to M7



Antenna A



Antenna B

Antenna Gain: 13 dBi

Frequency (MHz)	Mode	Tx Paths	Correlated Antenna Gain (dBi)	Tx 1 PSD (dBm/MHz)	Tx 2 PSD (dBm/MHz)	Total PSD (dBm/MHz)	Limit (dBm/MHz)	Margin (dB)
5180	Non HT20, 6 to 54 Mbps	1	13	3.1		3.1	10.0	6.9
	Non HT20, 6 to 54 Mbps	2	13	2.1	1.7	4.9	10.0	5.1
	Non HT20 Beam Forming, 6 to 54 Mbps	2	13	2.1	1.7	4.9	10.0	5.1
	HT/VHT20, M0 to M7	1	13	3.2		3.2	10.0	6.8
	HT/VHT20, M0 to M7	2	13	0.6	0.4	3.5	10.0	6.5
	HT/VHT20, M8 to M15	2	13	0.6	0.4	3.5	10.0	6.5
	HT/VHT20 Beam Forming, M0 to M7	2	13	0.6	0.4	3.5	10.0	6.5
	HT/VHT20 Beam Forming, M8 to M15	2	13	0.6	0.4	3.5	10.0	6.5
	HT/VHT20 STBC, M0 to M7	2	13	0.6	0.4	3.5	10.0	6.5
5190	Non HT40, 6 to 54 Mbps	1	13	-3.6		-3.6	10.0	13.6
	Non HT40, 6 to 54 Mbps	2	13	-5.4	-5.5	-2.4	10.0	12.4
	HT/VHT40, M0 to M7	1	13	-3.4		-3.4	10.0	13.4
	HT/VHT40, M0 to M7	2	13	-4.3	-4.4	-1.3	10.0	11.3
	HT/VHT40, M8 to M15	2	13	-4.3	-4.4	-1.3	10.0	11.3
	HT/VHT40 Beam Forming, M0 to M7	2	13	-4.3	-4.4	-1.3	10.0	11.3
	HT/VHT40 Beam Forming, M8 to M15	2	13	-4.3	-4.4	-1.3	10.0	11.3
	HT/VHT40 STBC, M0 to M7	2	13	-4.3	-4.4	-1.3	10.0	11.3
	5210	Non HT80, 6 to 54 Mbps	1	13	-9.1		-9.1	10.0
Non HT80, 6 to 54 Mbps		2	13	-10.0	-9.9	-6.9	10.0	16.9
VHT80, M0 to M9 1ss		1	13	-7.9		-7.9	10.0	17.9
VHT80, M0 to M9 1ss		2	13	-8.9	-9.4	-6.1	10.0	16.1
VHT80, M0 to M9 2ss		2	13	-8.9	-9.4	-6.1	10.0	16.1
VHT80 Beam Forming, M0 to M9 1ss		2	13	-8.9	-9.4	-6.1	10.0	16.1
VHT80 Beam Forming, M0 to M9 2ss		2	13	-8.9	-9.4	-6.1	10.0	16.1
VHT80 STBC, M0 to M9 1ss		2	13	-8.9	-9.4	-6.1	10.0	16.1
5220		Non HT20, 6 to 54 Mbps	1	13	9.8		9.8	10.0
	Non HT20, 6 to 54 Mbps	2	13	6.6	6.8	9.7	10.0	0.3
	Non HT20 Beam Forming, 6 to 54 Mbps	2	13	6.6	6.8	9.7	10.0	0.3
	HT/VHT20, M0 to M7	1	13	9.7		9.7	10.0	0.3
	HT/VHT20, M0 to M7	2	13	6.6	6.4	9.5	10.0	0.5
	HT/VHT20, M8 to M15	2	13	6.6	6.4	9.5	10.0	0.5
	HT/VHT20 Beam Forming, M0 to M7	2	13	6.6	6.4	9.5	10.0	0.5

	HT/VHT20 Beam Forming, M8 to M15	2	13	6.6	6.4	9.5	10.0	0.5
	HT/VHT20 STBC, M0 to M7	2	13	6.6	6.4	9.5	10.0	0.5
5230	Non HT40, 6 to 54 Mbps	1	13	8.2		8.2	10.0	1.8
	Non HT40, 6 to 54 Mbps	2	13	6.3	6.3	9.3	10.0	0.7
	HT/VHT40, M0 to M7	1	13	9.0		9.0	10.0	1.0
	HT/VHT40, M0 to M7	2	13	6.3	5.8	9.1	10.0	0.9
	HT/VHT40, M8 to M15	2	13	6.3	5.8	9.1	10.0	0.9
	HT/VHT40 Beam Forming, M0 to M7	2	13	6.3	5.8	9.1	10.0	0.9
	HT/VHT40 Beam Forming, M8 to M15	2	13	6.3	5.8	9.1	10.0	0.9
	HT/VHT40 STBC, M0 to M7	2	13	6.3	5.8	9.1	10.0	0.9
5240	Non HT20, 6 to 54 Mbps	1	13	9.7		9.7	10.0	0.3
	Non HT20, 6 to 54 Mbps	2	13	6.5	7.1	9.8	10.0	0.2
	Non HT20 Beam Forming, 6 to 54 Mbps	2	13	6.5	7.1	9.8	10.0	0.2
	HT/VHT20, M0 to M7	1	13	9.7		9.7	10.0	0.3
	HT/VHT20, M0 to M7	2	13	6.6	6.9	9.8	10.0	0.2
	HT/VHT20, M8 to M15	2	13	6.6	6.9	9.8	10.0	0.2
	HT/VHT20 Beam Forming, M0 to M7	2	13	6.6	6.9	9.8	10.0	0.2
	HT/VHT20 Beam Forming, M8 to M15	2	13	6.6	6.9	9.8	10.0	0.2
	HT/VHT20 STBC, M0 to M7	2	13	6.6	6.9	9.8	10.0	0.2

Power Spectral Density, 5240 MHz, Non HT20, 6 to 54 Mbps



Antenna A



Antenna B

Antenna Gain: 14 dBi

Frequency (MHz)	Mode	Tx Paths	Correlated Antenna Gain (dBi)	Tx 1 PSD (dBm/MHz)	Tx 2 PSD (dBm/MHz)	Total PSD (dBm/MHz)	Limit (dBm/MHz)	Margin (dB)
5180	Non HT20, 6 to 54 Mbps	1	14	2.1		2.1	9.0	6.9
	Non HT20, 6 to 54 Mbps	2	14	1.2	0.9	4.1	9.0	4.9
	Non HT20 Beam Forming, 6 to 54 Mbps	2	14	-0.7	-1.2	2.1	9.0	6.9
	HT/VHT20, M0 to M7	1	14	1.9		1.9	9.0	7.1
	HT/VHT20, M0 to M7	2	14	0.8	0.6	3.7	9.0	5.3
	HT/VHT20, M8 to M15	2	14	0.8	0.6	3.7	9.0	5.3
	HT/VHT20 Beam Forming, M0 to M7	2	14	-1.0	-1.2	1.9	9.0	7.1
	HT/VHT20 Beam Forming, M8 to M15	2	14	0.8	0.6	3.7	9.0	5.3
	HT/VHT20 STBC, M0 to M7	2	14	0.8	0.6	3.7	9.0	5.3
5190	Non HT40, 6 to 54 Mbps	1	14	-4.6		-4.6	9.0	13.6
	Non HT40, 6 to 54 Mbps	2	14	-5.5	-6.0	-2.7	9.0	11.7
	HT/VHT40, M0 to M7	1	14	-3.1		-3.1	9.0	12.1
	HT/VHT40, M0 to M7	2	14	-5.1	-5.5	-2.3	9.0	11.3
	HT/VHT40, M8 to M15	2	14	-5.1	-5.5	-2.3	9.0	11.3
	HT/VHT40 Beam Forming, M0 to M7	2	14	-5.1	-5.5	-2.3	9.0	11.3
	HT/VHT40 Beam Forming, M8 to M15	2	14	-5.1	-5.5	-2.3	9.0	11.3
	HT/VHT40 STBC, M0 to M7	2	14	-5.1	-5.5	-2.3	9.0	11.3
5210	Non HT80, 6 to 54 Mbps	1	14	-10.0		-10.0	9.0	19.0
	Non HT80, 6 to 54 Mbps	2	14	-9.9	-10.8	-7.3	9.0	16.3
	VHT80, M0 to M9 1ss	1	14	-8.9		-8.9	9.0	17.9
	VHT80, M0 to M9 1ss	2	14	-10.0	-10.3	-7.1	9.0	16.1
	VHT80, M0 to M9 2ss	2	14	-10.0	-10.3	-7.1	9.0	16.1
	VHT80 Beam Forming, M0 to M9 1ss	2	14	-10.0	-10.3	-7.1	9.0	16.1
	VHT80 Beam Forming, M0 to M9 2ss	2	14	-10.0	-10.3	-7.1	9.0	16.1
	VHT80 STBC, M0 to M9 1ss	2	14	-10.0	-10.3	-7.1	9.0	16.1
	5220	Non HT20, 6 to 54 Mbps	1	14	4.7		4.7	9.0
Non HT20, 6 to 54 Mbps		2	14	2.6	1.7	5.2	9.0	3.8
Non HT20 Beam Forming, 6 to 54 Mbps		2	14	-1.0	-0.9	2.1	9.0	6.9
HT/VHT20, M0 to M7		1	14	4.6		4.6	9.0	4.4
HT/VHT20, M0 to M7		2	14	2.6	1.5	5.1	9.0	3.9
HT/VHT20, M8 to M15		2	14	2.6	1.5	5.1	9.0	3.9
HT/VHT20 Beam Forming, M0 to M7		2	14	-1.2	-1.4	1.7	9.0	7.3



	HT/VHT20 Beam Forming, M8 to M15	2	14	2.6	1.5	5.1	9.0	3.9
	HT/VHT20 STBC, M0 to M7	2	14	2.6	1.5	5.1	9.0	3.9
5230	Non HT40, 6 to 54 Mbps	1	14	2.1		2.1	9.0	6.9
	Non HT40, 6 to 54 Mbps	2	14	-0.8	-1.0	2.1	9.0	6.9
	HT/VHT40, M0 to M7	1	14	1.7		1.7	9.0	7.3
	HT/VHT40, M0 to M7	2	14	-1.6	-1.0	1.7	9.0	7.3
	HT/VHT40, M8 to M15	2	14	-1.6	-1.0	1.7	9.0	7.3
	HT/VHT40 Beam Forming, M0 to M7	2	14	-4.0	-4.1	-1.0	9.0	10.0
	HT/VHT40 Beam Forming, M8 to M15	2	14	-1.6	-1.0	1.7	9.0	7.3
	HT/VHT40 STBC, M0 to M7	2	14	-1.6	-1.0	1.7	9.0	7.3
5240	Non HT20, 6 to 54 Mbps	1	14	4.6		4.6	9.0	4.4
	Non HT20, 6 to 54 Mbps	2	14	1.5	2.0	4.8	9.0	4.2
	Non HT20 Beam Forming, 6 to 54 Mbps	2	14	-0.8	-1.2	2.0	9.0	7.0
	HT/VHT20, M0 to M7	1	14	4.7		4.7	9.0	4.3
	HT/VHT20, M0 to M7	2	14	1.8	2.0	4.9	9.0	4.1
	HT/VHT20, M8 to M15	2	14	1.8	2.0	4.9	9.0	4.1
	HT/VHT20 Beam Forming, M0 to M7	2	14	-1.0	-1.0	2.0	9.0	7.0
	HT/VHT20 Beam Forming, M8 to M15	2	14	1.8	2.0	4.9	9.0	4.1
	HT/VHT20 STBC, M0 to M7	2	14	1.8	2.0	4.9	9.0	4.1

Power Spectral Density, 5220 MHz, Non HT20, 6 to 54 Mbps

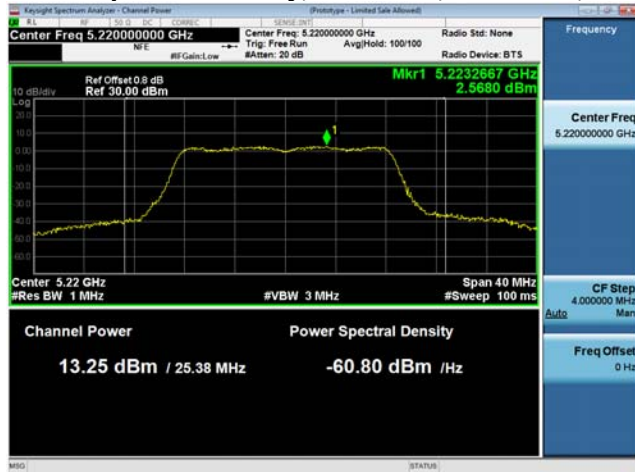

Antenna A

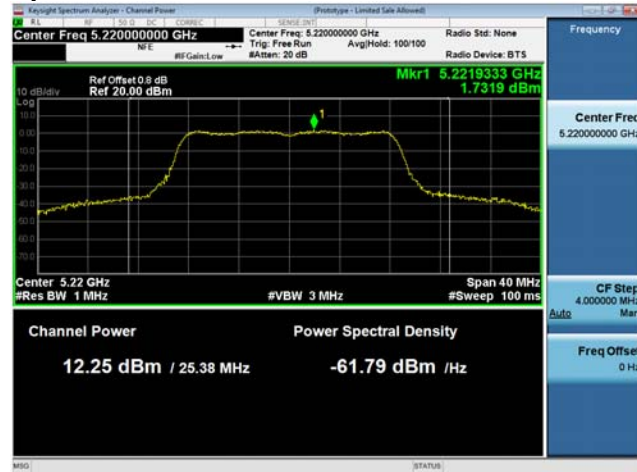

Antenna B

15.407 (i) The maximum e.i.r.p. at any elevation angle above 30 degrees as measured from the horizon must not exceed 125 mW (21 dBm).

Antenna Gain: 5 (-5) dBi

Frequency (MHz)	Mode	Tx Paths	Correlated Antenna Gain (dBi)	Tx 1 Max Power (dBm)	Tx 2 Max Power (dBm)	Total Radiated Channel Power (dBm)	Limit (dBm)	Margin (dB)
5180	Non HT20, 6 to 54 Mbps	1	-5	17.3		12.3	21.0	8.7
	Non HT20, 6 to 54 Mbps	2	-5	15.7	15.4	13.6	21.0	7.4
	Non HT20 Beam Forming, 6 to 54 Mbps	2	-2	14.7	14.5	15.6	21.0	5.4
	HT/VHT20, M0 to M7	1	-5	15.6		10.6	21.0	10.4
	HT/VHT20, M0 to M7	2	-5	15.8	15.6	13.7	21.0	7.3
	HT/VHT20, M8 to M15	2	-5	15.8	15.6	13.7	21.0	7.3
	HT/VHT20 Beam Forming, M0 to M7	2	-2	13.7	13.1	14.4	21.0	6.6
	HT/VHT20 Beam Forming, M8 to M15	2	-5	15.8	15.6	13.7	21.0	7.3
	HT/VHT20 STBC, M0 to M7	2	-5	15.8	15.6	13.7	21.0	7.3
5190	Non HT40, 6 to 54 Mbps	1	-5	14.7		9.7	21.0	11.3
	Non HT40, 6 to 54 Mbps	2	-5	11.0	10.7	8.9	21.0	12.1
	HT/VHT40, M0 to M7	1	-5	15.5		10.5	21.0	10.5
	HT/VHT40, M0 to M7	2	-5	12.3	12.0	10.2	21.0	10.8
	HT/VHT40, M8 to M15	2	-5	12.3	12.0	10.2	21.0	10.8
	HT/VHT40 Beam Forming, M0 to M7	2	-2	11.4	11.1	12.3	21.0	8.7
	HT/VHT40 Beam Forming, M8 to M15	2	-5	12.3	12.0	10.2	21.0	10.8
	HT/VHT40 STBC, M0 to M7	2	-5	12.3	12.0	10.2	21.0	10.8
5210	Non HT80, 6 to 54 Mbps	1	-5	12.2		7.2	21.0	13.8
	Non HT80, 6 to 54 Mbps	2	-5	11.5	11.3	9.4	21.0	11.6
	VHT80, M0 to M9 1ss	1	-5	13.9		8.9	21.0	12.1
	VHT80, M0 to M9 1ss	2	-5	10.9	10.5	8.7	21.0	12.3
	VHT80, M0 to M9 2ss	2	-5	10.9	10.5	8.7	21.0	12.3
	VHT80 Beam Forming, M0 to M9 1ss	2	-2	10.5	10.0	11.3	21.0	9.7
	VHT80 Beam Forming, M0 to M9 2ss	2	-5	10.9	10.5	8.7	21.0	12.3
	VHT80 STBC, M0 to M9 1ss	2	-5	10.9	10.5	8.7	21.0	12.3
5220	Non HT20, 6 to 54 Mbps	1	-5	23.6		18.6	21.0	2.4
	Non HT20, 6 to 54 Mbps	2	-5	22.5	22.7	20.6	21.0	0.4
	Non HT20 Beam Forming, 6 to 54 Mbps	2	-2	19.3	20.2	20.8	21.0	0.2
	HT/VHT20, M0 to M7	1	-5	23.7		18.7	21.0	2.3

	HT/VHT20, M0 to M7	2	-5	22.6	22.8	20.7	21.0	0.3
	HT/VHT20, M8 to M15	2	-5	22.6	22.8	20.7	21.0	0.3
	HT/VHT20 Beam Forming, M0 to M7	2	-2	19.5	20.4	21.0	21.0	0.0
	HT/VHT20 Beam Forming, M8 to M15	2	-5	22.6	22.8	20.7	21.0	0.3
	HT/VHT20 STBC, M0 to M7	2	-5	22.6	22.8	20.7	21.0	0.3
5230	Non HT40, 6 to 54 Mbps	1	-5	24.8		19.8	21.0	1.2
	Non HT40, 6 to 54 Mbps	2	-5	22.8	23.1	21.0	21.0	0.0
	HT/VHT40, M0 to M7	1	-5	23.8		18.8	21.0	2.2
	HT/VHT40, M0 to M7	2	-5	22.8	22.6	20.7	21.0	0.3
	HT/VHT40, M8 to M15	2	-5	22.8	22.6	20.7	21.0	0.3
	HT/VHT40 Beam Forming, M0 to M7	2	-2	19.8	20.1	21.0	21.0	0.0
	HT/VHT40 Beam Forming, M8 to M15	2	-5	22.8	22.6	20.7	21.0	0.3
	HT/VHT40 STBC, M0 to M7	2	-5	22.8	22.6	20.7	21.0	0.3
5240	Non HT20, 6 to 54 Mbps	1	-5	24.0		19.0	21.0	2.0
	Non HT20, 6 to 54 Mbps	2	-5	21.9	22.2	20.1	21.0	0.9
	Non HT20 Beam Forming, 6 to 54 Mbps	2	-2	18.6	19.0	19.8	21.0	1.2
	HT/VHT20, M0 to M7	1	-5	24.1		19.1	21.0	1.9
	HT/VHT20, M0 to M7	2	-5	22.0	22.3	20.2	21.0	0.8
	HT/VHT20, M8 to M15	2	-5	23.0	22.8	20.9	21.0	0.1
	HT/VHT20 Beam Forming, M0 to M7	2	-2	18.7	19.1	19.9	21.0	1.1
	HT/VHT20 Beam Forming, M8 to M15	2	-5	23.0	22.8	20.9	21.0	0.1
	HT/VHT20 STBC, M0 to M7	2	-5	23.0	22.8	20.9	21.0	0.1

Antenna Gain: 7 (-6) dBi

Frequency (MHz)	Mode	Tx Paths	Correlated Antenna Gain (dBi)	Tx 1 Max Power (dBm)	Tx 2 Max Power (dBm)	Total Radiated Channel Power (dBm)	Limit (dBm)	Margin (dB)
5180	Non HT20, 6 to 54 Mbps	1	-6	15.4		9.4	21.0	11.6
	Non HT20, 6 to 54 Mbps	2	-6	14.7	14.5	11.6	21.0	9.4
	Non HT20 Beam Forming, 6 to 54 Mbps	2	-3	13.8	13.5	13.7	21.0	7.3
	HT/VHT20, M0 to M7	1	-6	15.6		9.6	21.0	11.4
	HT/VHT20, M0 to M7	2	-6	14.9	14.7	11.8	21.0	9.2
	HT/VHT20, M8 to M15	2	-6	14.9	14.7	11.8	21.0	9.2
	HT/VHT20 Beam Forming, M0 to M7	2	-3	13.1	12.6	12.9	21.0	8.1
	HT/VHT20 Beam Forming, M8 to M15	2	-6	14.9	14.7	11.8	21.0	9.2
	HT/VHT20 STBC, M0 to M7	2	-6	14.9	14.7	11.8	21.0	9.2
5190	Non HT40, 6 to 54 Mbps	1	-6	12.5		6.5	21.0	14.5
	Non HT40, 6 to 54 Mbps	2	-6	10.2	9.7	7.0	21.0	14.0
	HT/VHT40, M0 to M7	1	-6	13.6		7.6	21.0	13.4
	HT/VHT40, M0 to M7	2	-6	11.4	11.1	8.3	21.0	12.7
	HT/VHT40, M8 to M15	2	-6	11.4	11.1	8.3	21.0	12.7
	HT/VHT40 Beam Forming, M0 to M7	2	-3	10.5	10.1	10.3	21.0	10.7
	HT/VHT40 Beam Forming, M8 to M15	2	-6	11.4	11.1	8.3	21.0	12.7
	HT/VHT40 STBC, M0 to M7	2	-6	11.4	11.1	8.3	21.0	12.7
5210	Non HT80, 6 to 54 Mbps	1	-6	11.3		5.3	21.0	15.7
	Non HT80, 6 to 54 Mbps	2	-6	10.5	10.4	7.5	21.0	13.5
	VHT80, M0 to M9 1ss	1	-6	13.9		7.9	21.0	13.1
	VHT80, M0 to M9 1ss	2	-6	10.5	10.0	7.3	21.0	13.7
	VHT80, M0 to M9 2ss	2	-6	10.5	10.0	7.3	21.0	13.7
	VHT80 Beam Forming, M0 to M9 1ss	2	-3	9.6	9.1	9.4	21.0	11.6
	VHT80 Beam Forming, M0 to M9 2ss	2	-6	10.5	10.0	7.3	21.0	13.7
	VHT80 STBC, M0 to M9 1ss	2	-6	10.5	10.0	7.3	21.0	13.7
5220	Non HT20, 6 to 54 Mbps	1	-6	23.6		17.6	21.0	3.4
	Non HT20, 6 to 54 Mbps	2	-6	19.3	20.2	16.8	21.0	4.2
	Non HT20 Beam Forming, 6 to 54 Mbps	2	-3	20.9	19.3	20.2	21.0	0.8
	HT/VHT20, M0 to M7	1	-6	23.7		17.7	21.0	3.3
	HT/VHT20, M0 to M7	2	-6	19.5	20.4	17.0	21.0	4.0
	HT/VHT20, M8 to M15	2	-6	23.7	23.8	20.8	21.0	0.2
	HT/VHT20 Beam Forming, M0 to M7	2	-3	20.9	19.5	20.3	21.0	0.7

	HT/VHT20 Beam Forming, M8 to M15	2	-6	23.7	23.8	20.8	21.0	0.2
	HT/VHT20 STBC, M0 to M7	2	-6	23.7	23.8	20.8	21.0	0.2
5230	Non HT40, 6 to 54 Mbps	1	-6	24.8		18.8	21.0	2.2
	Non HT40, 6 to 54 Mbps	2	-6	23.1	21.8	19.5	21.0	1.5
	HT/VHT40, M0 to M7	1	-6	23.8		17.8	21.0	3.2
	HT/VHT40, M0 to M7	2	-6	23.8	23.6	20.7	21.0	0.3
	HT/VHT40, M8 to M15	2	-6	23.8	23.6	20.7	21.0	0.3
	HT/VHT40 Beam Forming, M0 to M7	2	-3	20.7	20.9	20.8	21.0	0.2
	HT/VHT40 Beam Forming, M8 to M15	2	-6	23.8	23.6	20.7	21.0	0.3
	HT/VHT40 STBC, M0 to M7	2	-6	23.8	23.6	20.7	21.0	0.3
5240	Non HT20, 6 to 54 Mbps	1	-6	24.0		18.0	21.0	3.0
	Non HT20, 6 to 54 Mbps	2	-6	20.1	20.2	17.2	21.0	3.8
	Non HT20 Beam Forming, 6 to 54 Mbps	2	-3	20.2	20.3	20.3	21.0	0.7
	HT/VHT20, M0 to M7	1	-6	24.1		18.1	21.0	2.9
	HT/VHT20, M0 to M7	2	-6	20.2	20.3	17.3	21.0	3.7
	HT/VHT20, M8 to M15	2	-6	24.5	23.0	20.8	21.0	0.2
	HT/VHT20 Beam Forming, M0 to M7	2	-3	20.3	20.5	20.4	21.0	0.6
	HT/VHT20 Beam Forming, M8 to M15	2	-6	24.5	23.0	20.8	21.0	0.2
	HT/VHT20 STBC, M0 to M7	2	-6	24.5	23.0	20.8	21.0	0.2

Antenna Gain: 8 (3) dBi

Frequency (MHz)	Mode	Tx Paths	Correlated Antenna Gain (dBi)	Tx 1 Max Power (dBm)	Tx 2 Max Power (dBm)	Total Radiated Channel Power (dBm)	Limit (dBm)	Margin (dB)
5180	Non HT20, 6 to 54 Mbps	1	3	15.4		18.4	21.0	2.6
	Non HT20, 6 to 54 Mbps	2	3	13.8	13.5	19.7	21.0	1.3
	Non HT20 Beam Forming, 6 to 54 Mbps	2	6	11.8	11.6	20.7	21.0	0.3
	HT/VHT20, M0 to M7	1	3	15.6		18.6	21.0	2.4
	HT/VHT20, M0 to M7	2	3	14.0	13.7	19.9	21.0	1.1
	HT/VHT20, M8 to M15	2	3	14.0	13.7	19.9	21.0	1.1
	HT/VHT20 Beam Forming, M0 to M7	2	6	12.0	11.7	20.9	21.0	0.1
	HT/VHT20 Beam Forming, M8 to M15	2	3	14.0	13.7	19.9	21.0	1.1
	HT/VHT20 STBC, M0 to M7	2	3	14.0	13.7	19.9	21.0	1.1
5190	Non HT40, 6 to 54 Mbps	1	3	12.5		15.5	21.0	5.5
	Non HT40, 6 to 54 Mbps	2	3	9.7	9.4	15.6	21.0	5.4
	HT/VHT40, M0 to M7	1	3	13.6		16.6	21.0	4.4
	HT/VHT40, M0 to M7	2	3	10.5	10.1	16.3	21.0	4.7
	HT/VHT40, M8 to M15	2	3	10.5	10.1	16.3	21.0	4.7
	HT/VHT40 Beam Forming, M0 to M7	2	6	9.5	9.2	18.4	21.0	2.6
	HT/VHT40 Beam Forming, M8 to M15	2	3	10.5	10.1	16.3	21.0	4.7
	HT/VHT40 STBC, M0 to M7	2	3	10.5	10.1	16.3	21.0	4.7
5210	Non HT80, 6 to 54 Mbps	1	3	11.3		14.3	21.0	6.7
	Non HT80, 6 to 54 Mbps	2	3	9.6	9.5	15.6	21.0	5.4
	VHT80, M0 to M9 1ss	1	3	11.8		14.8	21.0	6.2
	VHT80, M0 to M9 1ss	2	3	10.9	10.5	16.7	21.0	4.3
	VHT80, M0 to M9 2ss	2	3	10.9	10.5	16.7	21.0	4.3
	VHT80 Beam Forming, M0 to M9 1ss	2	6	9.1	9.1	18.1	21.0	2.9
	VHT80 Beam Forming, M0 to M9 2ss	2	3	10.9	10.5	16.7	21.0	4.3
	VHT80 STBC, M0 to M9 1ss	2	3	10.9	10.5	16.7	21.0	4.3
5220	Non HT20, 6 to 54 Mbps	1	3	18.0		21.0	21.0	0.0
	Non HT20, 6 to 54 Mbps	2	3	15.4	14.2	20.9	21.0	0.1
	Non HT20 Beam Forming, 6 to 54 Mbps	2	6	12.2	11.3	20.8	21.0	0.2
	HT/VHT20, M0 to M7	1	3	17.3		20.3	21.0	0.7
	HT/VHT20, M0 to M7	2	3	15.5	14.4	21.0	21.0	0.0
	HT/VHT20, M8 to M15	2	3	15.5	14.4	21.0	21.0	0.0
	HT/VHT20 Beam Forming, M0 to M7	2	6	12.4	11.5	21.0	21.0	0.0

	HT/VHT20 Beam Forming, M8 to M15	2	3	15.5	14.4	21.0	21.0	0.0
	HT/VHT20 STBC, M0 to M7	2	3	15.5	14.4	21.0	21.0	0.0
5230	Non HT40, 6 to 54 Mbps	1	3	17.2		20.2	21.0	0.8
	Non HT40, 6 to 54 Mbps	2	3	14.6	14.5	20.6	21.0	0.4
	HT/VHT40, M0 to M7	1	3	17.2		20.2	21.0	0.8
	HT/VHT40, M0 to M7	2	3	14.3	14.6	20.5	21.0	0.5
	HT/VHT40, M8 to M15	2	3	14.3	14.6	20.5	21.0	0.5
	HT/VHT40 Beam Forming, M0 to M7	2	6	11.2	11.5	20.4	21.0	0.6
	HT/VHT40 Beam Forming, M8 to M15	2	3	14.3	14.6	20.5	21.0	0.5
	HT/VHT40 STBC, M0 to M7	2	3	14.3	14.6	20.5	21.0	0.5
5240	Non HT20, 6 to 54 Mbps	1	3	17.1		20.1	21.0	0.9
	Non HT20, 6 to 54 Mbps	2	3	14.3	14.8	20.6	21.0	0.4
	Non HT20 Beam Forming, 6 to 54 Mbps	2	6	11.2	11.7	20.5	21.0	0.5
	HT/VHT20, M0 to M7	1	3	17.3		20.3	21.0	0.7
	HT/VHT20, M0 to M7	2	3	14.5	14.9	20.7	21.0	0.3
	HT/VHT20, M8 to M15	2	3	14.5	14.9	20.7	21.0	0.3
	HT/VHT20 Beam Forming, M0 to M7	2	6	11.2	11.8	20.5	21.0	0.5
	HT/VHT20 Beam Forming, M8 to M15	2	3	14.5	14.9	20.7	21.0	0.3
	HT/VHT20 STBC, M0 to M7	2	3	14.5	14.9	20.7	21.0	0.3

Antenna Gain: 13 (-5) dBi

Frequency (MHz)	Mode	Tx Paths	Correlated Antenna Gain (dBi)	Tx 1 Max Power (dBm)	Tx 2 Max Power (dBm)	Total Radiated Channel Power (dBm)	Limit (dBm)	Margin (dB)
5180	Non HT20, 6 to 54 Mbps	1	-5	13.8		8.8	21.0	12.2
	Non HT20, 6 to 54 Mbps	2	-5	12.4	12.3	10.4	21.0	10.6
	Non HT20 Beam Forming, 6 to 54 Mbps	2	-2	12.4	12.3	13.4	21.0	7.6
	HT/VHT20, M0 to M7	1	-5	14.0		9.0	21.0	12.0
	HT/VHT20, M0 to M7	2	-5	11.4	11.0	9.2	21.0	11.8
	HT/VHT20, M8 to M15	2	-5	11.4	11.0	9.2	21.0	11.8
	HT/VHT20 Beam Forming, M0 to M7	2	-2	11.4	11.0	12.2	21.0	8.8
	HT/VHT20 Beam Forming, M8 to M15	2	-5	11.4	11.0	9.2	21.0	11.8
	HT/VHT20 STBC, M0 to M7	2	-5	11.4	11.0	9.2	21.0	11.8
5190	Non HT40, 6 to 54 Mbps	1	-5	9.7		4.7	21.0	16.3
	Non HT40, 6 to 54 Mbps	2	-5	8.1	7.9	6.0	21.0	15.0
	HT/VHT40, M0 to M7	1	-5	10.5		5.5	21.0	15.5
	HT/VHT40, M0 to M7	2	-5	9.5	9.2	7.4	21.0	13.6
	HT/VHT40, M8 to M15	2	-5	9.5	9.2	7.4	21.0	13.6
	HT/VHT40 Beam Forming, M0 to M7	2	-2	9.5	9.2	10.4	21.0	10.6
	HT/VHT40 Beam Forming, M8 to M15	2	-5	9.5	9.2	7.4	21.0	13.6
	HT/VHT40 STBC, M0 to M7	2	-5	9.5	9.2	7.4	21.0	13.6
5210	Non HT80, 6 to 54 Mbps	1	-5	7.8		2.8	21.0	18.2
	Non HT80, 6 to 54 Mbps	2	-5	6.6	6.5	4.6	21.0	16.4
	VHT80, M0 to M9 1ss	1	-5	9.6		4.6	21.0	16.4
	VHT80, M0 to M9 1ss	2	-5	8.6	8.2	6.4	21.0	14.6
	VHT80, M0 to M9 2ss	2	-5	8.6	8.2	6.4	21.0	14.6
	VHT80 Beam Forming, M0 to M9 1ss	2	-2	8.6	8.2	9.4	21.0	11.6
	VHT80 Beam Forming, M0 to M9 2ss	2	-5	8.6	8.2	6.4	21.0	14.6
	VHT80 STBC, M0 to M9 1ss	2	-5	8.6	8.2	6.4	21.0	14.6
5220	Non HT20, 6 to 54 Mbps	1	-5	20.4		15.4	21.0	5.6
	Non HT20, 6 to 54 Mbps	2	-5	17.2	17.2	15.2	21.0	5.8
	Non HT20 Beam Forming, 6 to 54 Mbps	2	-2	17.2	17.2	18.2	21.0	2.8
	HT/VHT20, M0 to M7	1	-5	20.6		15.6	21.0	5.4
	HT/VHT20, M0 to M7	2	-5	17.3	17.3	15.3	21.0	5.7
	HT/VHT20, M8 to M15	2	-5	17.3	17.3	15.3	21.0	5.7
	HT/VHT20 Beam Forming, M0 to M7	2	-2	17.3	17.3	18.3	21.0	2.7

	HT/VHT20 Beam Forming, M8 to M15	2	-5	17.3	17.3	15.3	21.0	5.7
	HT/VHT20 STBC, M0 to M7	2	-5	17.3	17.3	15.3	21.0	5.7
5230	Non HT40, 6 to 54 Mbps	1	-5	21.8		16.8	21.0	4.2
	Non HT40, 6 to 54 Mbps	2	-5	19.7	19.7	17.7	21.0	3.3
	HT/VHT40, M0 to M7	1	-5	22.8		17.8	21.0	3.2
	HT/VHT40, M0 to M7	2	-5	20.2	19.6	17.9	21.0	3.1
	HT/VHT40, M8 to M15	2	-5	20.2	19.6	17.9	21.0	3.1
	HT/VHT40 Beam Forming, M0 to M7	2	-2	20.2	19.6	20.9	21.0	0.1
	HT/VHT40 Beam Forming, M8 to M15	2	-5	20.2	19.6	17.9	21.0	3.1
	HT/VHT40 STBC, M0 to M7	2	-5	20.2	19.6	17.9	21.0	3.1
5240	Non HT20, 6 to 54 Mbps	1	-5	20.2		15.2	21.0	5.8
	Non HT20, 6 to 54 Mbps	2	-5	17.1	17.6	15.4	21.0	5.6
	Non HT20 Beam Forming, 6 to 54 Mbps	2	-2	17.1	17.6	18.4	21.0	2.6
	HT/VHT20, M0 to M7	1	-5	20.3		15.3	21.0	5.7
	HT/VHT20, M0 to M7	2	-5	17.3	17.7	15.5	21.0	5.5
	HT/VHT20, M8 to M15	2	-5	17.3	17.7	15.5	21.0	5.5
	HT/VHT20 Beam Forming, M0 to M7	2	-2	17.3	17.7	18.5	21.0	2.5
	HT/VHT20 Beam Forming, M8 to M15	2	-5	17.3	17.7	15.5	21.0	5.5
	HT/VHT20 STBC, M0 to M7	2	-5	17.3	17.7	15.5	21.0	5.5

Antenna Gain: 14 (5) dBi

Frequency (MHz)	Mode	Tx Paths	Correlated Antenna Gain (dBi)	Tx 1 Max Power (dBm)	Tx 2 Max Power (dBm)	Total Radiated Channel Power (dBm)	Limit (dBm)	Margin (dB)
5180	Non HT20, 6 to 54 Mbps	1	5	12.4		17.4	21.0	3.6
	Non HT20, 6 to 54 Mbps	2	5	11.6	11.3	19.5	21.0	1.5
	Non HT20 Beam Forming, 6 to 54 Mbps	2	8	9.8	9.5	20.7	21.0	0.3
	HT/VHT20, M0 to M7	1	5	12.6		17.6	21.0	3.4
	HT/VHT20, M0 to M7	2	5	11.7	11.4	19.6	21.0	1.4
	HT/VHT20, M8 to M15	2	5	11.7	11.4	19.6	21.0	1.4
	HT/VHT20 Beam Forming, M0 to M7	2	8	9.9	9.6	20.8	21.0	0.2
	HT/VHT20 Beam Forming, M8 to M15	2	5	11.7	11.4	19.6	21.0	1.4
	HT/VHT20 STBC, M0 to M7	2	5	11.7	11.4	19.6	21.0	1.4
5190	Non HT40, 6 to 54 Mbps	1	5	8.8		13.8	21.0	7.2
	Non HT40, 6 to 54 Mbps	2	5	7.9	7.4	15.7	21.0	5.3
	HT/VHT40, M0 to M7	1	5	10.1		15.1	21.0	5.9
	HT/VHT40, M0 to M7	2	5	8.6	8.2	16.4	21.0	4.6
	HT/VHT40, M8 to M15	2	5	8.6	8.2	16.4	21.0	4.6
	HT/VHT40 Beam Forming, M0 to M7	2	8	8.6	8.2	19.4	21.0	1.6
	HT/VHT40 Beam Forming, M8 to M15	2	5	8.6	8.2	16.4	21.0	4.6
	HT/VHT40 STBC, M0 to M7	2	5	8.6	8.2	16.4	21.0	4.6
5210	Non HT80, 6 to 54 Mbps	1	5	6.6		11.6	21.0	9.4
	Non HT80, 6 to 54 Mbps	2	5	6.5	6.0	14.3	21.0	6.7
	VHT80, M0 to M9 1ss	1	5	8.6		13.6	21.0	7.4
	VHT80, M0 to M9 1ss	2	5	7.4	7.2	15.3	21.0	5.7
	VHT80, M0 to M9 2ss	2	5	7.4	7.2	15.3	21.0	5.7
	VHT80 Beam Forming, M0 to M9 1ss	2	8	7.4	7.2	18.3	21.0	2.7
	VHT80 Beam Forming, M0 to M9 2ss	2	5	7.4	7.2	15.3	21.0	5.7
	VHT80 STBC, M0 to M9 1ss	2	5	7.4	7.2	15.3	21.0	5.7
5220	Non HT20, 6 to 54 Mbps	1	5	15.3		20.3	21.0	0.7
	Non HT20, 6 to 54 Mbps	2	5	13.2	12.3	20.8	21.0	0.2
	Non HT20 Beam Forming, 6 to 54 Mbps	2	8	9.5	9.3	20.4	21.0	0.6
	HT/VHT20, M0 to M7	1	5	15.5		20.5	21.0	0.5
	HT/VHT20, M0 to M7	2	5	13.4	12.4	20.9	21.0	0.1
	HT/VHT20, M8 to M15	2	5	13.4	12.4	20.9	21.0	0.1
	HT/VHT20 Beam Forming, M0 to M7	2	8	9.7	9.5	20.6	21.0	0.4

	HT/VHT20 Beam Forming, M8 to M15	2	5	13.4	12.4	20.9	21.0	0.1
	HT/VHT20 STBC, M0 to M7	2	5	13.4	12.4	20.9	21.0	0.1
5230	Non HT40, 6 to 54 Mbps	1	5	15.6		20.6	21.0	0.4
	Non HT40, 6 to 54 Mbps	2	5	12.8	12.6	20.7	21.0	0.3
	HT/VHT40, M0 to M7	1	5	15.3		20.3	21.0	0.7
	HT/VHT40, M0 to M7	2	5	12.2	12.4	20.3	21.0	0.7
	HT/VHT40, M8 to M15	2	5	12.2	12.4	20.3	21.0	0.7
	HT/VHT40 Beam Forming, M0 to M7	2	8	9.8	9.4	20.6	21.0	0.4
	HT/VHT40 Beam Forming, M8 to M15	2	5	12.2	12.4	20.3	21.0	0.7
	HT/VHT40 STBC, M0 to M7	2	5	12.2	12.4	20.3	21.0	0.7
5240	Non HT20, 6 to 54 Mbps	1	5	15.2		20.2	21.0	0.8
	Non HT20, 6 to 54 Mbps	2	5	12.0	12.5	20.3	21.0	0.7
	Non HT20 Beam Forming, 6 to 54 Mbps	2	8	9.8	9.3	20.6	21.0	0.4
	HT/VHT20, M0 to M7	1	5	15.4		20.4	21.0	0.6
	HT/VHT20, M0 to M7	2	5	12.2	12.6	20.4	21.0	0.6
	HT/VHT20, M8 to M15	2	5	12.2	12.6	20.4	21.0	0.6
	HT/VHT20 Beam Forming, M0 to M7	2	8	9.9	9.4	20.7	21.0	0.3
	HT/VHT20 Beam Forming, M8 to M15	2	5	12.2	12.6	20.4	21.0	0.6
	HT/VHT20 STBC, M0 to M7	2	5	12.2	12.6	20.4	21.0	0.6

A.3 Conducted Spurious Emissions

15.407 (b) Undesirable emission limits. Except as shown in paragraph (b) (7) of this section, the maximum emissions outside of the frequency bands of operation shall be attenuated in accordance with the following limits:

(1) For transmitters operating in the 5.15-5.25 GHz band: All emissions outside of the 5.15-5.35 GHz band shall not exceed an e.i.r.p. of -27 dBm/MHz.

Radiated emissions which fall in the restricted bands, as defined in Section 15.205(a), must also comply with the radiated emission limits specified in Section 15.209(a) (see Section 15.205(c)).

Test Procedure

Ref. KDB 789033 D02 General UNII Test Procedures New Rules v01r03
ANSI C63.10: 2013

Conducted Spurious Emissions

Test Procedure

1. Connect the antenna port(s) to the spectrum analyzer input.
2. Place the radio in continuous transmit mode. Use the procedures in KDB 789033 D02 General UNII Test Procedures New Rules v01r03 to substitute conducted measurements in place of radiated measurements.
3. Configure Spectrum analyzer as per test parameters below (be sure to enter all losses between the transmitter output and the spectrum analyzer).
4. Record the marker waveform peak to spur difference. Also measure any emissions in the restricted bands.
5. The "measure-and-sum technique" is used for measuring in-band transmit power of a device. In the measure-and-sum approach, the conducted emission level is measured at each antenna port. The measured results at the various antenna ports are then summed mathematically to determine the total emission level from the device. Summing is performed in linear power units. The worst case output is recorded.
6. Capture graphs and record pertinent measurement data.

Ref. KDB 789033 D02 General UNII Test Procedures New Rules v01r03
ANSI C63.10: 2013 section 12.7.7.3 (average) & 12.7.6 (peak)

Conducted Spurious Emissions

Test parameters

Span = 30MHz to 18GHz / 18GHz to 40GHz
RBW = 1 MHz
VBW \geq 3 x RBW for Peak, 1kHz for Average
Sweep = Auto couple
Detector = Peak
Trace = Max Hold.

System Number	Description	Samples	System under test	Support equipment
1	EUT	S01	<input checked="" type="checkbox"/>	<input type="checkbox"/>
	Support	S02	<input type="checkbox"/>	<input checked="" type="checkbox"/>

Tested By :

Jose Aguirre

Date of testing:

20-April-16 - 08-Aug-16

Test Result : PASS

See Appendix C for list of test equipment

Note: Radiated measurements have demonstrated that spurious emissions at the band edges are not correlated and therefore no array gain factor is used.

Conducted Spurs Average Upper, All Antennas

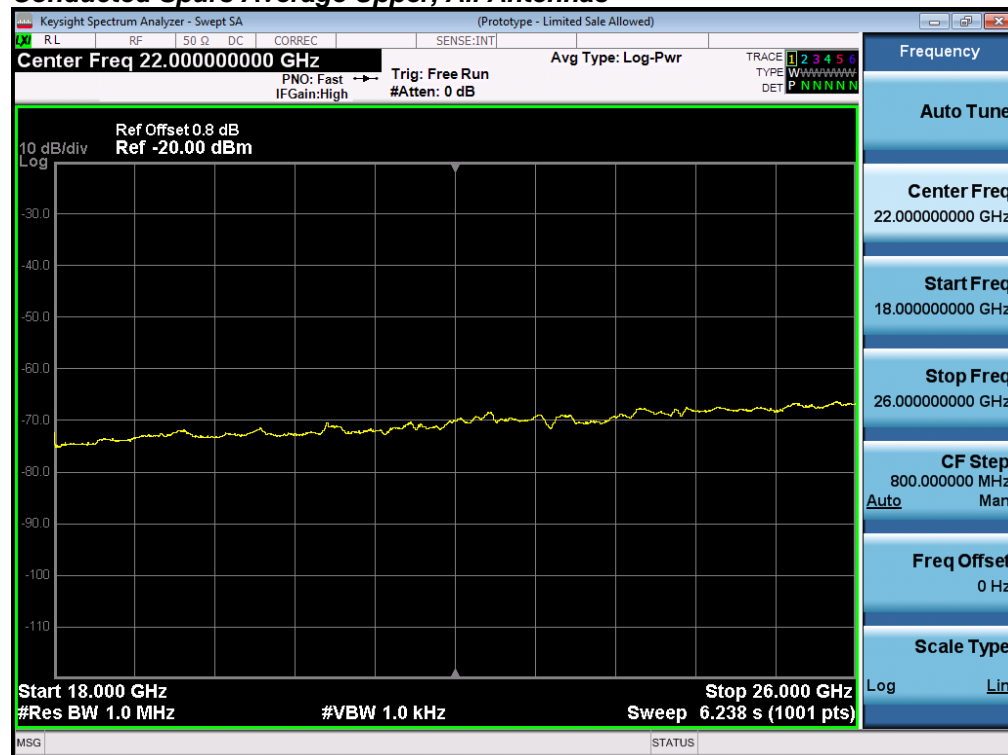

Conducted Spurs Peak Upper, All Antennas

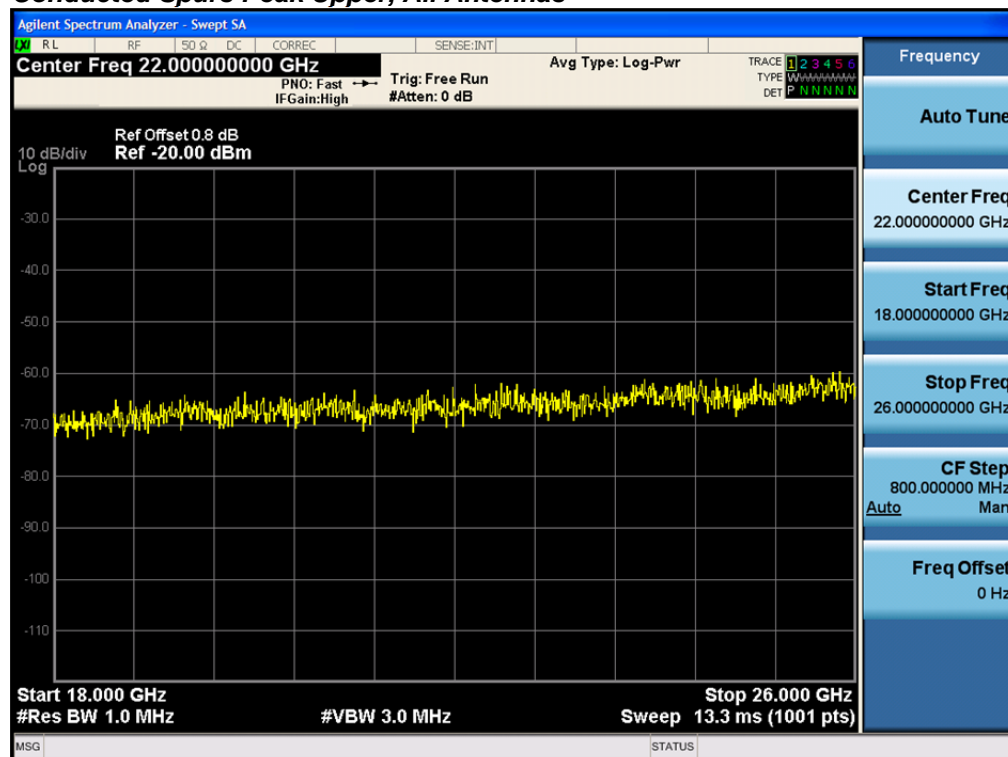

Conducted Spurious Emission results below represent the worst case for all antenna gain

Frequency (MHz)	Mode	Tx Paths	Correlated Antenna Gain (dBi)	Tx 1 Spur Power (dBm)	Tx 2 Spur Power (dBm)	Total Conducted Spur (dBm)	Limit (dBm)	Margin (dB)
5180	Non HT20, 6 to 54 Mbps	1	14	-73.3		-59.3	-41.25	18.1
	Non HT20, 6 to 54 Mbps	2	14	-73.4	-73.9	-56.6	-41.25	15.4
	Non HT20 Beam Forming, 6 to 54 Mbps	2	14	-72.9	-73.5	-56.2	-41.25	14.9
	HT/VHT20, M0 to M7	1	14	-71.8		-57.8	-41.25	16.6
	HT/VHT20, M0 to M7	2	14	-72.5	-73.5	-56.0	-41.25	14.7
	HT/VHT20, M8 to M15	2	14	-72.5	-73.5	-56.0	-41.25	14.7
	HT/VHT20 Beam Forming, M0 to M7	2	14	-73.3	-73.6	-56.4	-41.25	15.2
	HT/VHT20 Beam Forming, M8 to M15	2	14	-72.5	-73.5	-56.0	-41.25	14.7
	HT/VHT20 STBC, M0 to M7	2	14	-72.5	-73.5	-56.0	-41.25	14.7
5190	Non HT40, 6 to 54 Mbps	1	14	-73.6		-59.6	-41.25	18.4
	Non HT40, 6 to 54 Mbps	2	14	-73.0	-73.1	-56.0	-41.25	14.8
	HT/VHT40, M0 to M7	1	14	-73.3		-59.3	-41.25	18.1
	HT/VHT40, M0 to M7	2	14	-73.1	-73.1	-56.1	-41.25	14.8
	HT/VHT40, M8 to M15	2	14	-73.1	-73.1	-56.1	-41.25	14.8
	HT/VHT40 Beam Forming, M0 to M7	2	14	-73.1	-73.1	-56.1	-41.25	14.8
	HT/VHT40 Beam Forming, M8 to M15	2	14	-73.1	-73.1	-56.1	-41.25	14.8
	HT/VHT40 STBC, M0 to M7	2	14	-73.1	-73.1	-56.1	-41.25	14.8
5210	Non HT80, 6 to 54 Mbps	1	14	-73.3		-59.3	-41.25	18.1
	Non HT80, 6 to 54 Mbps	2	14	-73.7	-73.2	-56.4	-41.25	15.2
	VHT80, M0 to M9 1ss	1	14	-73.3		-59.3	-41.25	18.1
	VHT80, M0 to M9 1ss	2	14	-73.1	-73.2	-56.1	-41.25	14.9
	VHT80, M0 to M9 2ss	2	14	-73.1	-73.2	-56.1	-41.25	14.9
	VHT80 Beam Forming, M0 to M9 1ss	2	14	-73.1	-73.2	-56.1	-41.25	14.9
	VHT80 Beam Forming, M0 to M9 2ss	2	14	-73.1	-73.2	-56.1	-41.25	14.9
	VHT80 STBC, M0 to M9 1ss	2	14	-73.1	-73.2	-56.1	-41.25	14.9
5220	Non HT20, 6 to 54 Mbps	1	14	-74.0		-60.0	-41.25	18.8
	Non HT20, 6 to 54 Mbps	2	14	-73.1	-74.2	-56.6	-41.25	15.4
	Non HT20 Beam Forming, 6 to 54 Mbps	2	14	-59.9	-74.3	-45.7	-41.25	4.5
	HT/VHT20, M0 to M7	1	14	-74.1		-60.1	-41.25	18.9
	HT/VHT20, M0 to M7	2	14	-74.1	-74.1	-57.1	-41.25	15.8
	HT/VHT20, M8 to M15	2	14	-74.1	-74.1	-57.1	-41.25	15.8

	HT/VHT20 Beam Forming, M0 to M7	2	14	-74.0	-74.4	-57.2	-41.25	15.9
	HT/VHT20 Beam Forming, M8 to M15	2	14	-74.1	-74.1	-57.1	-41.25	15.8
	HT/VHT20 STBC, M0 to M7	2	14	-74.1	-74.1	-57.1	-41.25	15.8
5230	Non HT40, 6 to 54 Mbps	1	14	-58.2		-44.2	-41.25	3.0
	Non HT40, 6 to 54 Mbps	2	14	-58.3	-74.4	-44.2	-41.25	2.9
	HT/VHT40, M0 to M7	1	14	-74.4		-60.4	-41.25	19.2
	HT/VHT40, M0 to M7	2	14	-74.3	-74.2	-57.2	-41.25	16.0
	HT/VHT40, M8 to M15	2	14	-74.3	-74.2	-57.2	-41.25	16.0
	HT/VHT40 Beam Forming, M0 to M7	2	14	-74.6	-73.9	-57.2	-41.25	16.0
	HT/VHT40 Beam Forming, M8 to M15	2	14	-74.3	-74.2	-57.2	-41.25	16.0
	HT/VHT40 STBC, M0 to M7	2	14	-74.3	-74.2	-57.2	-41.25	16.0
5240	Non HT20, 6 to 54 Mbps	1	14	-73.4		-59.4	-41.25	18.2
	Non HT20, 6 to 54 Mbps	2	14	-73.6	-74.0	-56.8	-41.25	15.5
	Non HT20 Beam Forming, 6 to 54 Mbps	2	14	-73.5	-73.8	-56.6	-41.25	15.4
	HT/VHT20, M0 to M7	1	14	-74.2		-60.2	-41.25	19.0
	HT/VHT20, M0 to M7	2	14	-73.8	-73.4	-56.6	-41.25	15.3
	HT/VHT20, M8 to M15	2	14	-73.8	-73.4	-56.6	-41.25	15.3
	HT/VHT20 Beam Forming, M0 to M7	2	14	-73.9	-74.0	-56.9	-41.25	15.7
	HT/VHT20 Beam Forming, M8 to M15	2	14	-73.8	-73.4	-56.6	-41.25	15.3
	HT/VHT20 STBC, M0 to M7	2	14	-73.8	-73.4	-56.6	-41.25	15.3

Conducted Spurs Average, 5230 MHz, Non HT40, 6 to 54 Mbps



Antenna A



Antenna B

Frequency (MHz)	Mode	Tx Paths	Correlated Antenna Gain (dBi)	Tx 1 Spur Power (dBm)	Tx 2 Spur Power (dBm)	Total Conducted Spur (dBm)	Limit (dBm)	Margin (dB)
5180	Non HT20, 6 to 54 Mbps	1	14	-56.3		-42.3	-21.25	21.1
	Non HT20, 6 to 54 Mbps	2	14	-57.2	-58.0	-40.6	-21.25	19.3
	Non HT20 Beam Forming, 6 to 54 Mbps	2	14	-53.8	-58.2	-38.5	-21.25	17.2
	HT/VHT20, M0 to M7	1	14	-54.4		-40.4	-21.25	19.2
	HT/VHT20, M0 to M7	2	14	-55.9	-58.0	-39.8	-21.25	18.6
	HT/VHT20, M8 to M15	2	14	-55.9	-58.0	-39.8	-21.25	18.6
	HT/VHT20 Beam Forming, M0 to M7	2	14	-58.0	-53.2	-38.0	-21.25	16.7
	HT/VHT20 Beam Forming, M8 to M15	2	14	-55.9	-58.0	-39.8	-21.25	18.6
HT/VHT20 STBC, M0 to M7	2	14	-55.9	-58.0	-39.8	-21.25	18.6	
5190	Non HT40, 6 to 54 Mbps	1	14	-58.3		-44.3	-21.25	23.1
	Non HT40, 6 to 54 Mbps	2	14	-58.2	-58.1	-41.1	-21.25	19.9
	HT/VHT40, M0 to M7	1	14	-53.6		-39.6	-21.25	18.4
	HT/VHT40, M0 to M7	2	14	-59.0	-59.2	-42.1	-21.25	20.8
	HT/VHT40, M8 to M15	2	14	-59.0	-59.2	-42.1	-21.25	20.8
	HT/VHT40 Beam Forming, M0 to M7	2	14	-59.0	-59.2	-42.1	-21.25	20.8
	HT/VHT40 Beam Forming, M8 to M15	2	14	-59.0	-59.2	-42.1	-21.25	20.8
	HT/VHT40 STBC, M0 to M7	2	14	-59.0	-59.2	-42.1	-21.25	20.8
5210	Non HT80, 6 to 54 Mbps	1	14	-57.8		-43.8	-21.25	22.6
	Non HT80, 6 to 54 Mbps	2	14	-56.8	-57.0	-39.9	-21.25	18.6
	VHT80, M0 to M9 1ss	1	14	-59.5		-45.5	-21.25	24.3
	VHT80, M0 to M9 1ss	2	14	-59.0	-57.6	-41.2	-21.25	20.0
	VHT80, M0 to M9 2ss	2	14	-59.0	-57.6	-41.2	-21.25	20.0
	VHT80 Beam Forming, M0 to M9 1ss	2	14	-59.0	-57.6	-41.2	-21.25	20.0
	VHT80 Beam Forming, M0 to M9 2ss	2	14	-59.0	-57.6	-41.2	-21.25	20.0
	VHT80 STBC, M0 to M9 1ss	2	14	-59.0	-57.6	-41.2	-21.25	20.0
5220	Non HT20, 6 to 54 Mbps	1	14	-58.2		-44.2	-21.25	23.0
	Non HT20, 6 to 54 Mbps	2	14	-58.4	-59.3	-41.8	-21.25	20.6
	Non HT20 Beam Forming, 6 to 54 Mbps	2	14	-53.5	-59.3	-38.5	-21.25	17.2
	HT/VHT20, M0 to M7	1	14	-57.3		-43.3	-21.25	22.1
	HT/VHT20, M0 to M7	2	14	-58.3	-58.0	-41.1	-21.25	19.9
	HT/VHT20, M8 to M15	2	14	-58.3	-58.0	-41.1	-21.25	19.9
	HT/VHT20 Beam Forming, M0 to M7	2	14	-57.5	-58.8	-41.1	-21.25	19.8

	HT/VHT20 Beam Forming, M8 to M15	2	14	-58.3	-58.0	-41.1	-21.25	19.9
	HT/VHT20 STBC, M0 to M7	2	14	-58.3	-58.0	-41.1	-21.25	19.9
5230	Non HT40, 6 to 54 Mbps	1	14	-58.1		-44.1	-21.25	22.9
	Non HT40, 6 to 54 Mbps	2	14	-58.2	-59.1	-41.6	-21.25	20.4
	HT/VHT40, M0 to M7	1	14	-57.3		-43.3	-21.25	22.1
	HT/VHT40, M0 to M7	2	14	-60.8	-59.2	-42.9	-21.25	21.7
	HT/VHT40, M8 to M15	2	14	-60.8	-59.2	-42.9	-21.25	21.7
	HT/VHT40 Beam Forming, M0 to M7	2	14	-53.3	-59.1	-38.3	-21.25	17.0
	HT/VHT40 Beam Forming, M8 to M15	2	14	-60.8	-59.2	-42.9	-21.25	21.7
	HT/VHT40 STBC, M0 to M7	2	14	-60.8	-59.2	-42.9	-21.25	21.7
5240	Non HT20, 6 to 54 Mbps	1	14	-59.6		-45.6	-21.25	24.4
	Non HT20, 6 to 54 Mbps	2	14	-57.3	-57.9	-40.6	-21.25	19.3
	Non HT20 Beam Forming, 6 to 54 Mbps	2	14	-57.7	-58.9	-41.2	-21.25	20.0
	HT/VHT20, M0 to M7	1	14	-59.1		-45.1	-21.25	23.9
	HT/VHT20, M0 to M7	2	14	-59.8	-58.9	-42.3	-21.25	21.1
	HT/VHT20, M8 to M15	2	14	-59.8	-58.9	-42.3	-21.25	21.1
	HT/VHT20 Beam Forming, M0 to M7	2	14	-53.6	-58.9	-38.5	-21.25	17.2
	HT/VHT20 Beam Forming, M8 to M15	2	14	-59.8	-58.9	-42.3	-21.25	21.1
	HT/VHT20 STBC, M0 to M7	2	14	-59.8	-58.9	-42.3	-21.25	21.1

Conducted Spurs Peak, 5180 MHz, HT/VHT20 Beam Forming, M0 to M7

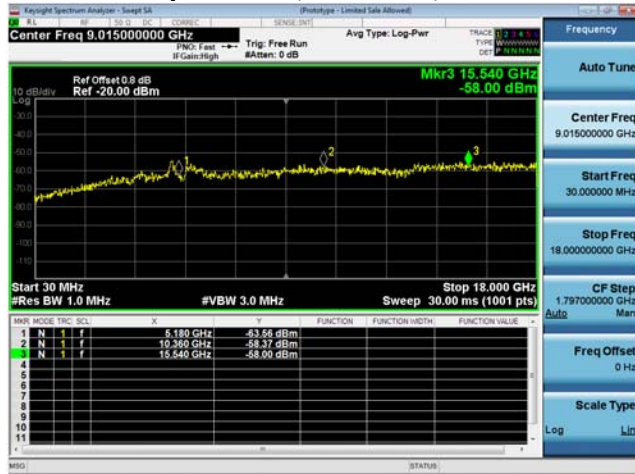

Antenna A

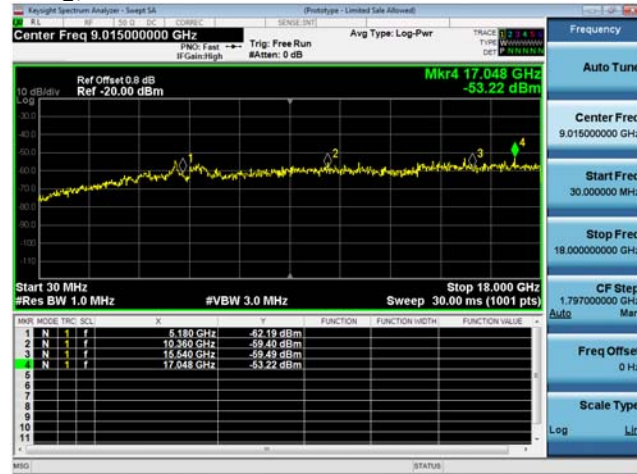

Antenna B

A.4 Conducted Band Edge

15.205 / 15.209 - Radiated emissions which fall in the restricted bands, as defined in Section 15.205(a), must also comply with the radiated emission limits specified in Section 15.209(a) (see Section 15.205(c)).
Use formula below to substitute conducted measurements in place of radiated measurements

$$E[\text{dB}\mu\text{V}/\text{m}] = \text{EIRP}[\text{dBm}] - 20 \log(d[\text{meters}]) + 104.77, \text{ where } E = \text{field strength and } d = 3 \text{ meter}$$

- 1) Average Plot, Limit= -41.25 dBm eirp
- 2) Peak plot, Limit = -21.25 dBm eirp

Test Procedure

Ref. ANSI C63.10: 2013

Conducted Bandedge
Test Procedure
<ol style="list-style-type: none"> 1. Connect the antenna port(s) to the spectrum analyzer input. 2. Place the radio in continuous transmit mode. Use the procedures in ANSI C63.10: 2013 to substitute conducted measurements in place of radiated measurements. 3. Configure Spectrum analyzer as per test parameters below (be sure to enter all losses between the transmitter output and the spectrum analyzer). 4. Place a marker at the end of the restricted band closest to the transmit frequency to show compliance. Also measure any emissions in the restricted bands. 5. The "measure-and-sum technique" is used for measuring in-band transmit power of a device. In the measure-and-sum approach, the conducted emission level is measured at each antenna port. The measured results at the various antenna ports are then summed mathematically to determine the total emission level from the device. Summing is performed in linear power units. The worst case output is recorded. 6. Place a marker at the end of the restricted band closest to the transmit frequency to show compliance. Also measure any emissions in the restricted bands 7. Capture graphs and record pertinent measurement data.

Ref. ANSI C63.10: 2013 section 12.7.6 (peak) & 12.7.7.3 (average, Method VB-A (Alternative))

Conducted Bandedge
Test parameters restricted Band
RBW = 1 MHz VBW ≥ 3 x RBW for Peak, 100Hz for Average Sweep = Auto couple Detector = Peak Trace = Max Hold.

System Number	Description	Samples	System under test	Support equipment
1	EUT	S01	<input checked="" type="checkbox"/>	<input type="checkbox"/>
	Support	S02	<input type="checkbox"/>	<input checked="" type="checkbox"/>

Tested By : Jose Aguirre	Date of testing: 20-April-16 - 08-Aug-16
Test Result : PASS	

See Appendix C for list of test equipment

Note: Radiated measurements have demonstrated that spurious emissions at the band edges are not correlated and therefore no array gain factor is used.

Antenna Gain: 5 dBi

Frequency (MHz)	Mode	Tx Paths	Correlated Antenna Gain (dBi)	Tx 1 Bandedge Level (dBm)	Tx 2 Bandedge Level (dBm)	Total Tx Bandedge Level (dBm)	Limit (dBm)	Margin (dB)
5180	Non HT20, 6 to 54 Mbps	1	5	-46.4		-41.4	-41.25	0.1
	Non HT20, 6 to 54 Mbps	2	5	-50.4	-50.4	-42.4	-41.25	1.1
	Non HT20 Beam Forming, 6 to 54 Mbps	2	8	-53.2	-52.5	-41.8	-41.25	0.6
	HT/VHT20, M0 to M7	1	5	-49.4		-44.4	-41.25	3.2
	HT/VHT20, M0 to M7	2	5	-50.0	-49.4	-41.7	-41.25	0.4
	HT/VHT20, M8 to M15	2	5	-50.0	-49.4	-41.7	-41.25	0.4
	HT/VHT20 Beam Forming, M0 to M7	2	8	-53.2	-52.2	-41.7	-41.25	0.4
	HT/VHT20 Beam Forming, M8 to M15	2	5	-50.0	-49.4	-41.7	-41.25	0.4
	HT/VHT20 STBC, M0 to M7	2	5	-50.0	-49.4	-41.7	-41.25	0.4
5190	Non HT40, 6 to 54 Mbps	1	5	-46.4		-41.4	-41.25	0.1
	Non HT40, 6 to 54 Mbps	2	5	-49.7	-52.7	-42.9	-41.25	1.7
	HT/VHT40, M0 to M7	1	5	-46.3		-41.3	-41.25	0.0
	HT/VHT40, M0 to M7	2	5	-51.7	-48.4	-41.7	-41.25	0.5
	HT/VHT40, M8 to M15	2	5	-51.7	-48.4	-41.7	-41.25	0.5
	HT/VHT40 Beam Forming, M0 to M7	2	8	-54.0	-51.8	-41.8	-41.25	0.5
	HT/VHT40 Beam Forming, M8 to M15	2	5	-51.7	-48.4	-41.7	-41.25	0.5
	HT/VHT40 STBC, M0 to M7	2	5	-51.7	-48.4	-41.7	-41.25	0.5
	5210	Non HT80, 6 to 54 Mbps	1	5	-47.5		-42.5	-41.25
Non HT80, 6 to 54 Mbps		2	5	-48.6	-51.1	-41.7	-41.25	0.4
VHT80, M0 to M9 1ss		1	5	-48.7		-43.7	-41.25	2.5
VHT80, M0 to M9 1ss		2	5	-53.5	-52.2	-44.8	-41.25	3.5
VHT80, M0 to M9 2ss		2	5	-53.5	-52.2	-44.8	-41.25	3.5
VHT80 Beam Forming, M0 to M9 1ss		2	8	-52.2	-52.7	-41.4	-41.25	0.2
VHT80 Beam Forming, M0 to M9 2ss		2	5	-53.5	-52.2	-44.8	-41.25	3.5
VHT80 STBC, M0 to M9 1ss		2	5	-53.5	-52.2	-44.8	-41.25	3.5

Conducted Bandedge Average, 5190 MHz, HT/VHT40, M0 to M7



Antenna A

Antenna Gain: 7 dBi

Frequency (MHz)	Mode	Tx Paths	Correlated Antenna Gain (dBi)	Tx 1 Bandedge Level (dBm)	Tx 2 Bandedge Level (dBm)	Total Tx Bandedge Level (dBm)	Limit (dBm)	Margin (dB)
5180	Non HT20, 6 to 54 Mbps	1	7	-50.4		-43.4	-41.25	2.2
	Non HT20, 6 to 54 Mbps	2	7	-53.2	-52.5	-42.8	-41.25	1.6
	Non HT20 Beam Forming, 6 to 54 Mbps	2	10	-55.4	-54.2	-41.7	-41.25	0.5
	HT/VHT20, M0 to M7	1	7	-49.4		-42.4	-41.25	1.2
	HT/VHT20, M0 to M7	2	7	-52.6	-51.3	-41.9	-41.25	0.6
	HT/VHT20, M8 to M15	2	7	-52.6	-51.3	-41.9	-41.25	0.6
	HT/VHT20 Beam Forming, M0 to M7	2	10	-52.2	-59.7	-41.5	-41.25	0.2
	HT/VHT20 Beam Forming, M8 to M15	2	7	-52.6	-51.3	-41.9	-41.25	0.6
	HT/VHT20 STBC, M0 to M7	2	7	-52.6	-51.3	-41.9	-41.25	0.6
5190	Non HT40, 6 to 54 Mbps	1	7	-49.4		-42.4	-41.25	1.2
	Non HT40, 6 to 54 Mbps	2	7	-51.8	-57.4	-43.7	-41.25	2.5
	HT/VHT40, M0 to M7	1	7	-49.6		-42.6	-41.25	1.4
	HT/VHT40, M0 to M7	2	7	-54.0	-51.8	-42.8	-41.25	1.5
	HT/VHT40, M8 to M15	2	7	-54.0	-51.8	-42.8	-41.25	1.5
	HT/VHT40 Beam Forming, M0 to M7	2	10	-55.7	-55.3	-42.5	-41.25	1.2
	HT/VHT40 Beam Forming, M8 to M15	2	7	-54.0	-51.8	-42.8	-41.25	1.5
	HT/VHT40 STBC, M0 to M7	2	7	-54.0	-51.8	-42.8	-41.25	1.5
5210	Non HT80, 6 to 54 Mbps	1	7	-51.1		-44.1	-41.25	2.9
	Non HT80, 6 to 54 Mbps	2	7	-51.0	-52.3	-41.6	-41.25	0.3
	VHT80, M0 to M9 1ss	1	7	-48.7		-41.7	-41.25	0.5
	VHT80, M0 to M9 1ss	2	7	-52.2	-52.7	-42.4	-41.25	1.2
	VHT80, M0 to M9 2ss	2	7	-52.2	-52.7	-42.4	-41.25	1.2
	VHT80 Beam Forming, M0 to M9 1ss	2	10	-55.1	-55.0	-42.0	-41.25	0.8
	VHT80 Beam Forming, M0 to M9 2ss	2	7	-52.2	-52.7	-42.4	-41.25	1.2
	VHT80 STBC, M0 to M9 1ss	2	7	-52.2	-52.7	-42.4	-41.25	1.2



Conducted Bandedge Average, 5180 MHz, HT/VHT20 Beam Forming, M0 to M7



Antenna A



Antenna B

Antenna Gain: 8 dBi

Frequency (MHz)	Mode	Tx Paths	Correlated Antenna Gain (dBi)	Tx 1 Bandedge Level (dBm)	Tx 2 Bandedge Level (dBm)	Total Tx Bandedge Level (dBm)	Limit (dBm)	Margin (dB)
5180	Non HT20, 6 to 54 Mbps	1	8	-50.4		-42.4	-41.25	1.2
	Non HT20, 6 to 54 Mbps	2	8	-55.4	-54.2	-43.7	-41.25	2.5
	Non HT20 Beam Forming, 6 to 54 Mbps	2	11	-55.8	-60.6	-43.6	-41.25	2.3
	HT/VHT20, M0 to M7	1	8	-49.4		-41.4	-41.25	0.2
	HT/VHT20, M0 to M7	2	8	-54.9	-53.2	-43.0	-41.25	1.7
	HT/VHT20, M8 to M15	2	8	-54.9	-53.2	-43.0	-41.25	1.7
	HT/VHT20 Beam Forming, M0 to M7	2	11	-54.5	-60.3	-42.5	-41.25	1.2
	HT/VHT20 Beam Forming, M8 to M15	2	8	-54.9	-53.2	-43.0	-41.25	1.7
	HT/VHT20 STBC, M0 to M7	2	8	-54.9	-53.2	-43.0	-41.25	1.7
5190	Non HT40, 6 to 54 Mbps	1	8	-49.4		-41.4	-41.25	0.2
	Non HT40, 6 to 54 Mbps	2	8	-57.4	-51.9	-42.8	-41.25	1.6
	HT/VHT40, M0 to M7	1	8	-49.6		-41.6	-41.25	0.4
	HT/VHT40, M0 to M7	2	8	-55.7	-55.3	-44.5	-41.25	3.2
	HT/VHT40, M8 to M15	2	8	-55.7	-55.3	-44.5	-41.25	3.2
	HT/VHT40 Beam Forming, M0 to M7	2	11	-57.2	-58.3	-43.7	-41.25	2.5
	HT/VHT40 Beam Forming, M8 to M15	2	8	-55.7	-55.3	-44.5	-41.25	3.2
	HT/VHT40 STBC, M0 to M7	2	8	-55.7	-55.3	-44.5	-41.25	3.2
5210	Non HT80, 6 to 54 Mbps	1	8	-51.1		-43.1	-41.25	1.9
	Non HT80, 6 to 54 Mbps	2	8	-53.1	-52.9	-42.0	-41.25	0.7
	VHT80, M0 to M9 1ss	1	8	-52.1		-44.1	-41.25	2.9
	VHT80, M0 to M9 1ss	2	8	-53.5	-52.2	-41.8	-41.25	0.5
	VHT80, M0 to M9 2ss	2	8	-53.5	-52.2	-41.8	-41.25	0.5
	VHT80 Beam Forming, M0 to M9 1ss	2	11	-55.0	-56.1	-41.5	-41.25	0.3
	VHT80 Beam Forming, M0 to M9 2ss	2	8	-53.5	-52.2	-41.8	-41.25	0.5
	VHT80 STBC, M0 to M9 1ss	2	8	-53.5	-52.2	-41.8	-41.25	0.5

Conducted Bandedge Average, 5180 MHz, HT/VHT20, M0 to M7



Antenna A

Antenna Gain: 13 dBi

Frequency (MHz)	Mode	Tx Paths	Correlated Antenna Gain (dBi)	Tx 1 Bandedge Level (dBm)	Tx 2 Bandedge Level (dBm)	Total Tx Bandedge Level (dBm)	Limit (dBm)	Margin (dB)
5180	Non HT20, 6 to 54 Mbps	1	13	-55.4		-42.4	-41.25	1.2
	Non HT20, 6 to 54 Mbps	2	13	-60.1	-56.2	-41.7	-41.25	0.5
	Non HT20 Beam Forming, 6 to 54 Mbps	2	13	-60.1	-56.2	-41.7	-41.25	0.5
	HT/VHT20, M0 to M7	1	13	-54.9		-41.9	-41.25	0.7
	HT/VHT20, M0 to M7	2	13	-59.8	-56.9	-42.1	-41.25	0.9
	HT/VHT20, M8 to M15	2	13	-59.8	-56.9	-42.1	-41.25	0.9
	HT/VHT20 Beam Forming, M0 to M7	2	13	-59.8	-56.9	-42.1	-41.25	0.9
	HT/VHT20 Beam Forming, M8 to M15	2	13	-59.8	-56.9	-42.1	-41.25	0.9
	HT/VHT20 STBC, M0 to M7	2	13	-59.8	-56.9	-42.1	-41.25	0.9
5190	Non HT40, 6 to 54 Mbps	1	13	-57.4		-44.4	-41.25	3.2
	Non HT40, 6 to 54 Mbps	2	13	-57.4	-60.2	-42.6	-41.25	1.3
	HT/VHT40, M0 to M7	1	13	-55.7		-42.7	-41.25	1.5
	HT/VHT40, M0 to M7	2	13	-57.2	-58.3	-41.7	-41.25	0.5
	HT/VHT40, M8 to M15	2	13	-57.2	-58.3	-41.7	-41.25	0.5
	HT/VHT40 Beam Forming, M0 to M7	2	13	-57.2	-58.3	-41.7	-41.25	0.5
	HT/VHT40 Beam Forming, M8 to M15	2	13	-57.2	-58.3	-41.7	-41.25	0.5
	HT/VHT40 STBC, M0 to M7	2	13	-57.2	-58.3	-41.7	-41.25	0.5
5210	Non HT80, 6 to 54 Mbps	1	13	-55.8		-42.8	-41.25	1.6
	Non HT80, 6 to 54 Mbps	2	13	-59.3	-58.5	-42.9	-41.25	1.6
	VHT80, M0 to M9 1ss	1	13	-55.1		-42.1	-41.25	0.9
	VHT80, M0 to M9 1ss	2	13	-57.9	-57.0	-41.4	-41.25	0.2
	VHT80, M0 to M9 2ss	2	13	-57.9	-57.0	-41.4	-41.25	0.2
	VHT80 Beam Forming, M0 to M9 1ss	2	13	-57.9	-57.0	-41.4	-41.25	0.2
	VHT80 Beam Forming, M0 to M9 2ss	2	13	-57.9	-57.0	-41.4	-41.25	0.2
	VHT80 STBC, M0 to M9 1ss	2	13	-57.9	-57.0	-41.4	-41.25	0.2



Conducted Bandedge Average, 5210 MHz, VHT80, M0 to M9 1ss

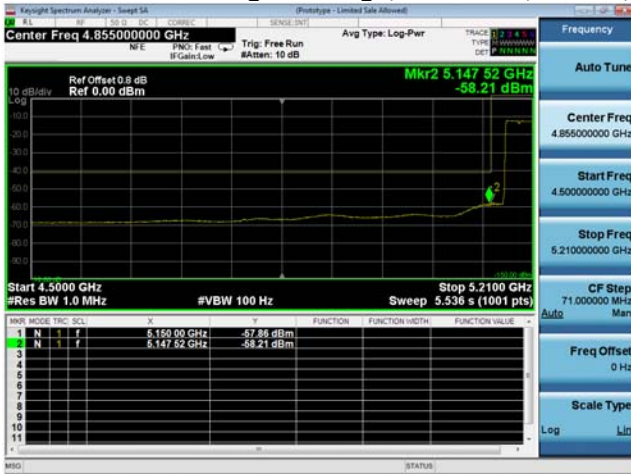

Antenna A



Antenna B

Antenna Gain: 14 dBi

Frequency (MHz)	Mode	Tx Paths	Correlated Antenna Gain (dBi)	Tx 1 Bandedge Level (dBm)	Tx 2 Bandedge Level (dBm)	Total Tx Bandedge Level (dBm)	Limit (dBm)	Margin (dB)
5180	Non HT20, 6 to 54 Mbps	1	14	-60.1		-46.1	-41.25	4.9
	Non HT20, 6 to 54 Mbps	2	14	-60.6	-60.4	-43.5	-41.25	2.2
	Non HT20 Beam Forming, 6 to 54 Mbps	2	14	-61.2	-62.2	-44.7	-41.25	3.4
	HT/VHT20, M0 to M7	1	14	-59.7		-45.7	-41.25	4.5
	HT/VHT20, M0 to M7	2	14	-60.3	-59.8	-43.0	-41.25	1.8
	HT/VHT20, M8 to M15	2	14	-60.3	-59.8	-43.0	-41.25	1.8
	HT/VHT20 Beam Forming, M0 to M7	2	14	-61.2	-62.1	-44.6	-41.25	3.4
	HT/VHT20 Beam Forming, M8 to M15	2	14	-60.3	-59.8	-43.0	-41.25	1.8
	HT/VHT20 STBC, M0 to M7	2	14	-60.3	-59.8	-43.0	-41.25	1.8
5190	Non HT40, 6 to 54 Mbps	1	14	-59.2		-45.2	-41.25	4.0
	Non HT40, 6 to 54 Mbps	2	14	-60.2	-58.2	-42.1	-41.25	0.8
	HT/VHT40, M0 to M7	1	14	-55.3		-41.3	-41.25	0.1
	HT/VHT40, M0 to M7	2	14	-58.9	-62.3	-43.3	-41.25	2.0
	HT/VHT40, M8 to M15	2	14	-58.9	-62.3	-43.3	-41.25	2.0
	HT/VHT40 Beam Forming, M0 to M7	2	14	-58.9	-62.3	-43.3	-41.25	2.0
	HT/VHT40 Beam Forming, M8 to M15	2	14	-58.9	-62.3	-43.3	-41.25	2.0
	HT/VHT40 STBC, M0 to M7	2	14	-58.9	-62.3	-43.3	-41.25	2.0
5210	Non HT80, 6 to 54 Mbps	1	14	-59.3		-45.3	-41.25	4.1
	Non HT80, 6 to 54 Mbps	2	14	-58.5	-58.4	-41.4	-41.25	0.2
	VHT80, M0 to M9 1ss	1	14	-57.9		-43.9	-41.25	2.7
	VHT80, M0 to M9 1ss	2	14	-59.6	-59.3	-42.4	-41.25	1.2
	VHT80, M0 to M9 2ss	2	14	-59.6	-59.3	-42.4	-41.25	1.2
	VHT80 Beam Forming, M0 to M9 1ss	2	14	-59.6	-59.3	-42.4	-41.25	1.2
	VHT80 Beam Forming, M0 to M9 2ss	2	14	-59.6	-59.3	-42.4	-41.25	1.2
	VHT80 STBC, M0 to M9 1ss	2	14	-59.6	-59.3	-42.4	-41.25	1.2

Conducted Bandedge Average, 5190 MHz, HT/VHT40, M0 to M7



Antenna A

Antenna Gain: 5 dBi

Frequency (MHz)	Mode	Tx Paths	Correlated Antenna Gain (dBi)	Tx 1 Bandedge Level (dBm)	Tx 2 Bandedge Level (dBm)	Total Tx Bandedge Level (dBm)	Limit (dBm)	Margin (dB)
5180	Non HT20, 6 to 54 Mbps	1	5	-37.0		-32.0	-21.25	10.8
	Non HT20, 6 to 54 Mbps	2	5	-36.1	-39.3	-29.4	-21.25	8.2
	Non HT20 Beam Forming, 6 to 54 Mbps	2	8	-41.8	-39.8	-29.7	-21.25	8.4
	HT/VHT20, M0 to M7	1	5	-34.9		-29.9	-21.25	8.7
	HT/VHT20, M0 to M7	2	5	-34.8	-34.9	-26.8	-21.25	5.6
	HT/VHT20, M8 to M15	2	5	-34.8	-34.9	-26.8	-21.25	5.6
	HT/VHT20 Beam Forming, M0 to M7	2	8	-42.8	-35.8	-27.0	-21.25	5.8
	HT/VHT20 Beam Forming, M8 to M15	2	5	-34.8	-34.9	-26.8	-21.25	5.6
	HT/VHT20 STBC, M0 to M7	2	5	-34.8	-34.9	-26.8	-21.25	5.6
5190	Non HT40, 6 to 54 Mbps	1	5	-32.0		-27.0	-21.25	5.8
	Non HT40, 6 to 54 Mbps	2	5	-36.8	-39.9	-30.1	-21.25	8.8
	HT/VHT40, M0 to M7	1	5	-33.0		-28.0	-21.25	6.8
	HT/VHT40, M0 to M7	2	5	-41.9	-35.0	-29.2	-21.25	7.9
	HT/VHT40, M8 to M15	2	5	-41.9	-35.0	-29.2	-21.25	7.9
	HT/VHT40 Beam Forming, M0 to M7	2	8	-36.6	-40.1	-27.0	-21.25	5.7
	HT/VHT40 Beam Forming, M8 to M15	2	5	-41.9	-35.0	-29.2	-21.25	7.9
	HT/VHT40 STBC, M0 to M7	2	5	-41.9	-35.0	-29.2	-21.25	7.9
5210	Non HT80, 6 to 54 Mbps	1	5	-36.2		-31.2	-21.25	10.0
	Non HT80, 6 to 54 Mbps	2	5	-38.6	-43.4	-32.4	-21.25	11.1
	VHT80, M0 to M9 1ss	1	5	-40.0		-35.0	-21.25	13.8
	VHT80, M0 to M9 1ss	2	5	-43.7	-42.1	-34.8	-21.25	13.6
	VHT80, M0 to M9 2ss	2	5	-43.7	-42.1	-34.8	-21.25	13.6
	VHT80 Beam Forming, M0 to M9 1ss	2	8	-42.1	-38.2	-28.7	-21.25	7.5
	VHT80 Beam Forming, M0 to M9 2ss	2	5	-43.7	-42.1	-34.8	-21.25	13.6
	VHT80 STBC, M0 to M9 1ss	2	5	-43.7	-42.1	-34.8	-21.25	13.6

Conducted Bandedge Peak, 5180 MHz, HT/VHT20, M0 to M7

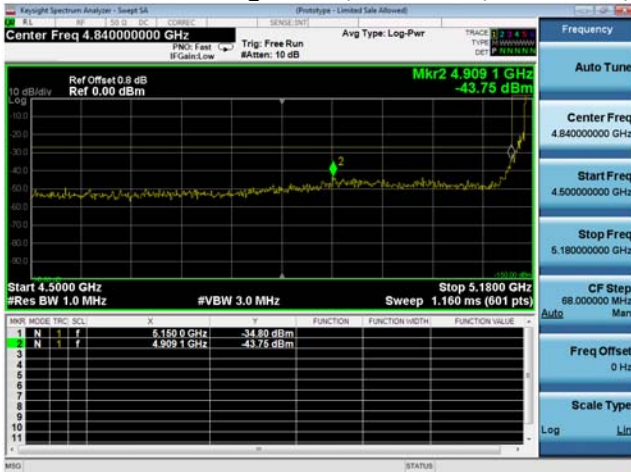

Antenna A

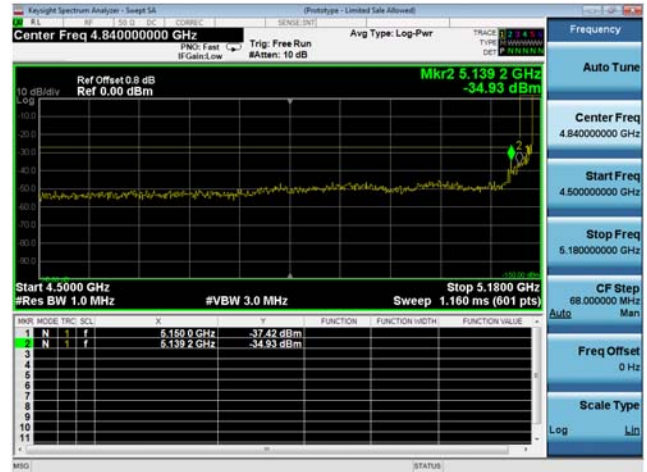

Antenna B

Antenna Gain: 7 dBi

Frequency (MHz)	Mode	Tx Paths	Correlated Antenna Gain (dBi)	Tx 1 Bandedge Level (dBm)	Tx 2 Bandedge Level (dBm)	Total Tx Bandedge Level (dBm)	Limit (dBm)	Margin (dB)
5180	Non HT20, 6 to 54 Mbps	1	7	-39.3		-32.3	-21.25	11.1
	Non HT20, 6 to 54 Mbps	2	7	-41.8	-39.8	-30.7	-21.25	9.4
	Non HT20 Beam Forming, 6 to 54 Mbps	2	10	-43.2	-39.5	-28.0	-21.25	6.7
	HT/VHT20, M0 to M7	1	7	-34.9		-27.9	-21.25	6.7
	HT/VHT20, M0 to M7	2	7	-33.9	-38.8	-25.7	-21.25	4.4
	HT/VHT20, M8 to M15	2	7	-33.9	-38.8	-25.7	-21.25	4.4
	HT/VHT20 Beam Forming, M0 to M7	2	10	-35.8	-46.8	-25.5	-21.25	4.2
	HT/VHT20 Beam Forming, M8 to M15	2	7	-33.9	-38.8	-25.7	-21.25	4.4
	HT/VHT20 STBC, M0 to M7	2	7	-33.9	-38.8	-25.7	-21.25	4.4
5190	Non HT40, 6 to 54 Mbps	1	7	-40.9		-33.9	-21.25	12.7
	Non HT40, 6 to 54 Mbps	2	7	-38.4	-39.3	-28.8	-21.25	7.6
	HT/VHT40, M0 to M7	1	7	-39.6		-32.6	-21.25	11.4
	HT/VHT40, M0 to M7	2	7	-36.6	-40.1	-28.0	-21.25	6.7
	HT/VHT40, M8 to M15	2	7	-36.6	-40.1	-28.0	-21.25	6.7
	HT/VHT40 Beam Forming, M0 to M7	2	10	-45.2	-42.5	-30.6	-21.25	9.4
	HT/VHT40 Beam Forming, M8 to M15	2	7	-36.6	-40.1	-28.0	-21.25	6.7
	HT/VHT40 STBC, M0 to M7	2	7	-36.6	-40.1	-28.0	-21.25	6.7
	5210	Non HT80, 6 to 54 Mbps	1	7	-43.4		-36.4	-21.25
Non HT80, 6 to 54 Mbps		2	7	-38.7	-41.5	-29.9	-21.25	8.6
VHT80, M0 to M9 1ss		1	7	-40.0		-33.0	-21.25	11.8
VHT80, M0 to M9 1ss		2	7	-42.1	-38.2	-29.7	-21.25	8.5
VHT80, M0 to M9 2ss		2	7	-42.1	-38.2	-29.7	-21.25	8.5
VHT80 Beam Forming, M0 to M9 1ss		2	10	-40.4	-46.5	-29.4	-21.25	8.2
VHT80 Beam Forming, M0 to M9 2ss		2	7	-42.1	-38.2	-29.7	-21.25	8.5
VHT80 STBC, M0 to M9 1ss		2	7	-42.1	-38.2	-29.7	-21.25	8.5

Conducted Bandedge Peak, 5180 MHz, HT/VHT20 Beam Forming, M0 to M7

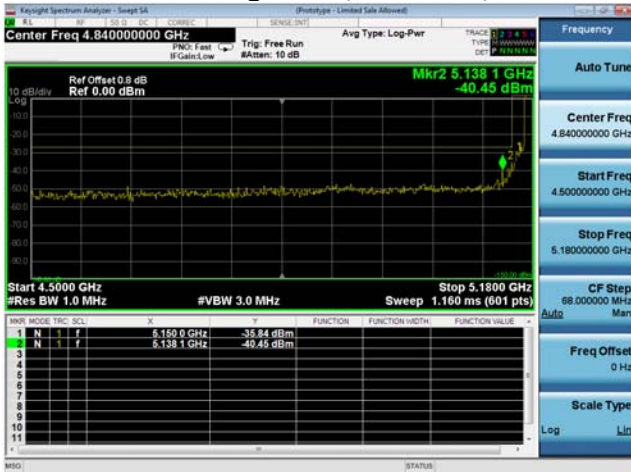

Antenna A



Antenna B

Antenna Gain: 8 dBi

Frequency (MHz)	Mode	Tx Paths	Correlated Antenna Gain (dBi)	Tx 1 Bandedge Level (dBm)	Tx 2 Bandedge Level (dBm)	Total Tx Bandedge Level (dBm)	Limit (dBm)	Margin (dB)
5180	Non HT20, 6 to 54 Mbps	1	8	-39.3		-31.3	-21.25	10.1
	Non HT20, 6 to 54 Mbps	2	8	-43.2	-39.5	-30.0	-21.25	8.7
	Non HT20 Beam Forming, 6 to 54 Mbps	2	11	-42.0	-44.5	-29.1	-21.25	7.8
	HT/VHT20, M0 to M7	1	8	-34.9		-26.9	-21.25	5.7
	HT/VHT20, M0 to M7	2	8	-36.6	-42.8	-27.7	-21.25	6.4
	HT/VHT20, M8 to M15	2	8	-36.6	-42.8	-27.7	-21.25	6.4
	HT/VHT20 Beam Forming, M0 to M7	2	11	-39.6	-47.1	-27.9	-21.25	6.6
	HT/VHT20 Beam Forming, M8 to M15	2	8	-36.6	-42.8	-27.7	-21.25	6.4
	HT/VHT20 STBC, M0 to M7	2	8	-36.6	-42.8	-27.7	-21.25	6.4
5190	Non HT40, 6 to 54 Mbps	1	8	-40.9		-32.9	-21.25	11.7
	Non HT40, 6 to 54 Mbps	2	8	-39.3	-36.5	-26.7	-21.25	5.4
	HT/VHT40, M0 to M7	1	8	-39.6		-31.6	-21.25	10.4
	HT/VHT40, M0 to M7	2	8	-45.2	-42.5	-32.6	-21.25	11.4
	HT/VHT40, M8 to M15	2	8	-45.2	-42.5	-32.6	-21.25	11.4
	HT/VHT40 Beam Forming, M0 to M7	2	11	-47.8	-43.2	-30.9	-21.25	9.7
	HT/VHT40 Beam Forming, M8 to M15	2	8	-45.2	-42.5	-32.6	-21.25	11.4
	HT/VHT40 STBC, M0 to M7	2	8	-45.2	-42.5	-32.6	-21.25	11.4
5210	Non HT80, 6 to 54 Mbps	1	8	-43.4		-35.4	-21.25	14.2
	Non HT80, 6 to 54 Mbps	2	8	-40.7	-45.7	-31.5	-21.25	10.3
	VHT80, M0 to M9 1ss	1	8	-42.9		-34.9	-21.25	13.7
	VHT80, M0 to M9 1ss	2	8	-43.7	-42.1	-31.8	-21.25	10.6
	VHT80, M0 to M9 2ss	2	8	-43.7	-42.1	-31.8	-21.25	10.6
	VHT80 Beam Forming, M0 to M9 1ss	2	11	-46.5	-46.0	-32.2	-21.25	11.0
	VHT80 Beam Forming, M0 to M9 2ss	2	8	-43.7	-42.1	-31.8	-21.25	10.6
	VHT80 STBC, M0 to M9 1ss	2	8	-43.7	-42.1	-31.8	-21.25	10.6

Conducted Bandedge Peak, 5190 MHz, Non HT40, 6 to 54 Mbps



Antenna A

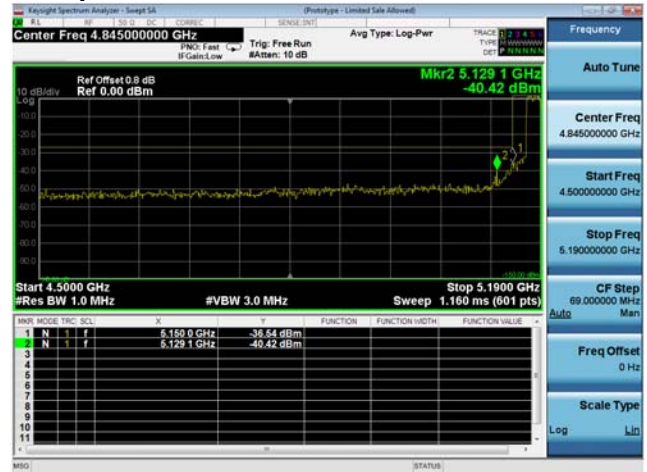

Antenna B

Antenna Gain: 13 dBi

Frequency (MHz)	Mode	Tx Paths	Correlated Antenna Gain (dBi)	Tx 1 Bandedge Level (dBm)	Tx 2 Bandedge Level (dBm)	Total Tx Bandedge Level (dBm)	Limit (dBm)	Margin (dB)
5180	Non HT20, 6 to 54 Mbps	1	13	-43.2		-30.2	-21.25	9.0
	Non HT20, 6 to 54 Mbps	2	13	-46.1	-45.7	-29.9	-21.25	8.6
	Non HT20 Beam Forming, 6 to 54 Mbps	2	13	-46.1	-45.7	-29.9	-21.25	8.6
	HT/VHT20, M0 to M7	1	13	-36.6		-23.6	-21.25	2.4
	HT/VHT20, M0 to M7	2	13	-40.4	-45.4	-26.2	-21.25	5.0
	HT/VHT20, M8 to M15	2	13	-40.4	-45.4	-26.2	-21.25	5.0
	HT/VHT20 Beam Forming, M0 to M7	2	13	-40.4	-45.4	-26.2	-21.25	5.0
	HT/VHT20 Beam Forming, M8 to M15	2	13	-40.4	-45.4	-26.2	-21.25	5.0
	HT/VHT20 STBC, M0 to M7	2	13	-40.4	-45.4	-26.2	-21.25	5.0
5190	Non HT40, 6 to 54 Mbps	1	13	-39.3		-26.3	-21.25	5.1
	Non HT40, 6 to 54 Mbps	2	13	-47.3	-43.6	-29.1	-21.25	7.8
	HT/VHT40, M0 to M7	1	13	-45.2		-32.2	-21.25	11.0
	HT/VHT40, M0 to M7	2	13	-47.8	-43.2	-28.9	-21.25	7.7
	HT/VHT40, M8 to M15	2	13	-47.8	-43.2	-28.9	-21.25	7.7
	HT/VHT40 Beam Forming, M0 to M7	2	13	-47.8	-43.2	-28.9	-21.25	7.7
	HT/VHT40 Beam Forming, M8 to M15	2	13	-47.8	-43.2	-28.9	-21.25	7.7
	HT/VHT40 STBC, M0 to M7	2	13	-47.8	-43.2	-28.9	-21.25	7.7
	5210	Non HT80, 6 to 54 Mbps	1	13	-42.6		-29.6	-21.25
Non HT80, 6 to 54 Mbps		2	13	-47.0	-46.4	-30.7	-21.25	9.4
VHT80, M0 to M9 1ss		1	13	-40.4		-27.4	-21.25	6.2
VHT80, M0 to M9 1ss		2	13	-44.0	-47.0	-29.2	-21.25	8.0
VHT80, M0 to M9 2ss		2	13	-44.0	-47.0	-29.2	-21.25	8.0
VHT80 Beam Forming, M0 to M9 1ss		2	13	-44.0	-47.0	-29.2	-21.25	8.0
VHT80 Beam Forming, M0 to M9 2ss		2	13	-44.0	-47.0	-29.2	-21.25	8.0
VHT80 STBC, M0 to M9 1ss		2	13	-44.0	-47.0	-29.2	-21.25	8.0

Conducted Bandedge Peak, 5180 MHz, HT/VHT20, M0 to M7

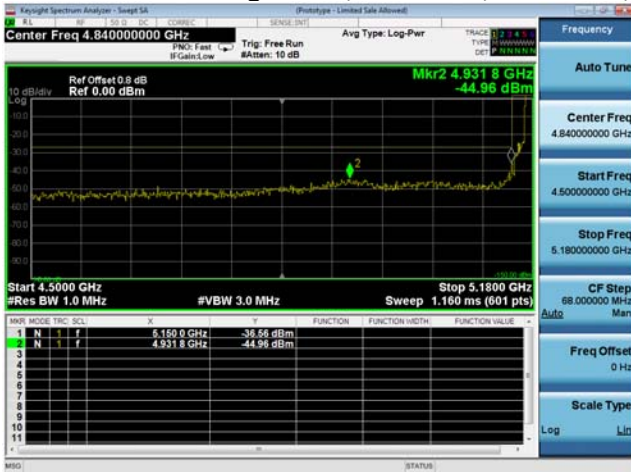

Antenna A

Antenna Gain: 14 dBi

Frequency (MHz)	Mode	Tx Paths	Correlated Antenna Gain (dBi)	Tx 1 Bandedge Level (dBm)	Tx 2 Bandedge Level (dBm)	Total Tx Bandedge Level (dBm)	Limit (dBm)	Margin (dB)
5180	Non HT20, 6 to 54 Mbps	1	14	-46.1		-32.1	-21.25	10.9
	Non HT20, 6 to 54 Mbps	2	14	-44.5	-47.1	-28.6	-21.25	7.3
	Non HT20 Beam Forming, 6 to 54 Mbps	2	14	-47.2	-47.8	-30.5	-21.25	9.2
	HT/VHT20, M0 to M7	1	14	-46.8		-32.8	-21.25	11.6
	HT/VHT20, M0 to M7	2	14	-47.1	-40.4	-25.6	-21.25	4.3
	HT/VHT20, M8 to M15	2	14	-47.1	-40.4	-25.6	-21.25	4.3
	HT/VHT20 Beam Forming, M0 to M7	2	14	-46.2	-47.3	-29.7	-21.25	8.5
	HT/VHT20 Beam Forming, M8 to M15	2	14	-47.1	-40.4	-25.6	-21.25	4.3
	HT/VHT20 STBC, M0 to M7	2	14	-47.1	-40.4	-25.6	-21.25	4.3
5190	Non HT40, 6 to 54 Mbps	1	14	-47.7		-33.7	-21.25	12.5
	Non HT40, 6 to 54 Mbps	2	14	-43.6	-37.4	-22.5	-21.25	1.2
	HT/VHT40, M0 to M7	1	14	-42.5		-28.5	-21.25	7.3
	HT/VHT40, M0 to M7	2	14	-47.9	-48.2	-31.0	-21.25	9.8
	HT/VHT40, M8 to M15	2	14	-47.9	-48.2	-31.0	-21.25	9.8
	HT/VHT40 Beam Forming, M0 to M7	2	14	-47.9	-48.2	-31.0	-21.25	9.8
	HT/VHT40 Beam Forming, M8 to M15	2	14	-47.9	-48.2	-31.0	-21.25	9.8
	HT/VHT40 STBC, M0 to M7	2	14	-47.9	-48.2	-31.0	-21.25	9.8
	5210	Non HT80, 6 to 54 Mbps	1	14	-47.0		-33.0	-21.25
Non HT80, 6 to 54 Mbps		2	14	-46.4	-49.7	-30.7	-21.25	9.5
VHT80, M0 to M9 1ss		1	14	-44.0		-30.0	-21.25	8.8
VHT80, M0 to M9 1ss		2	14	-47.5	-47.7	-30.6	-21.25	9.3
VHT80, M0 to M9 2ss		2	14	-47.5	-47.7	-30.6	-21.25	9.3
VHT80 Beam Forming, M0 to M9 1ss		2	14	-47.5	-47.7	-30.6	-21.25	9.3
VHT80 Beam Forming, M0 to M9 2ss		2	14	-47.5	-47.7	-30.6	-21.25	9.3
VHT80 STBC, M0 to M9 1ss		2	14	-47.5	-47.7	-30.6	-21.25	9.3



Conducted Bandedge Peak, 5190 MHz, Non HT40, 6 to 54 Mbps

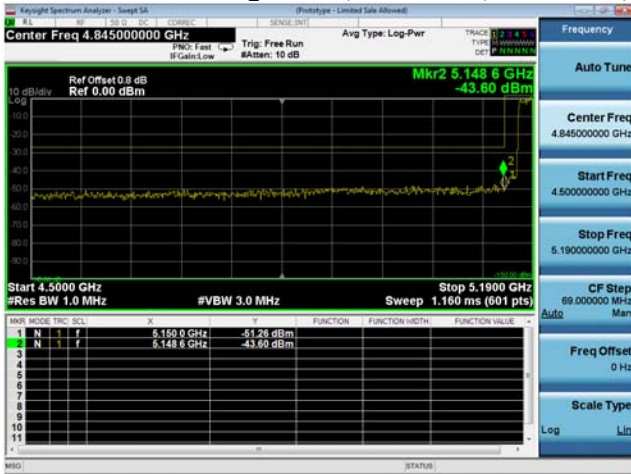

Antenna A

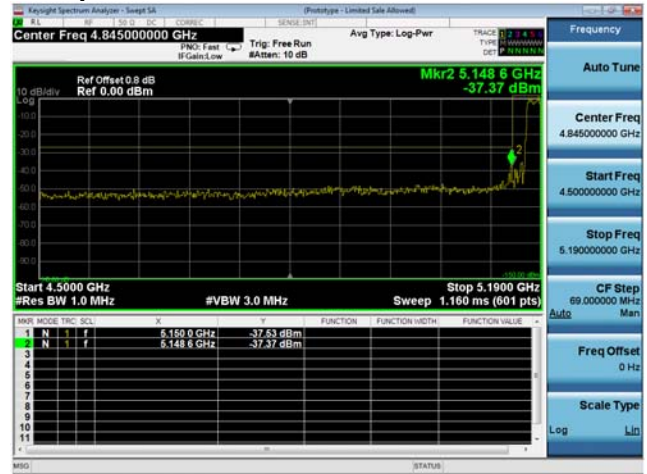

Antenna B



Title: Physical Test Arrangement Photograph

This is a dual band 2.4GHz / 5GHz device. All ports in this test set up photo are connected as all testing is automated. Section 2.6 of this test report given an overview of the different Tx antenna combinations used by this device.

Appendix B: Emission Test Results

Testing Laboratory: Cisco Systems, Inc., 125 West Tasman Drive, San Jose, CA 95134, USA

Radiated Emission Setup Diagram-Below 1G

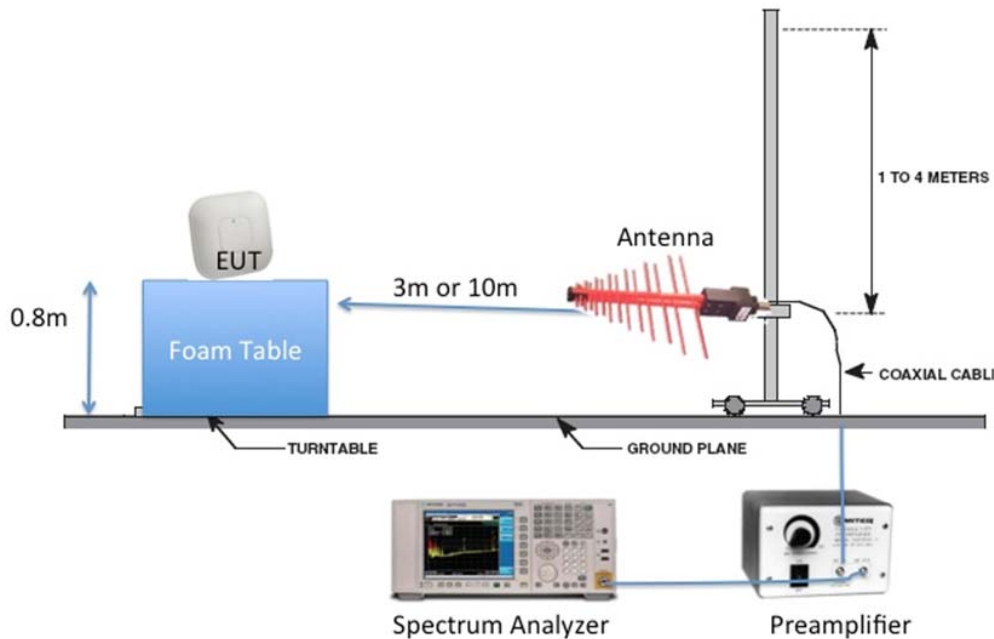

Radiated Emission Setup Diagram-Above 1G

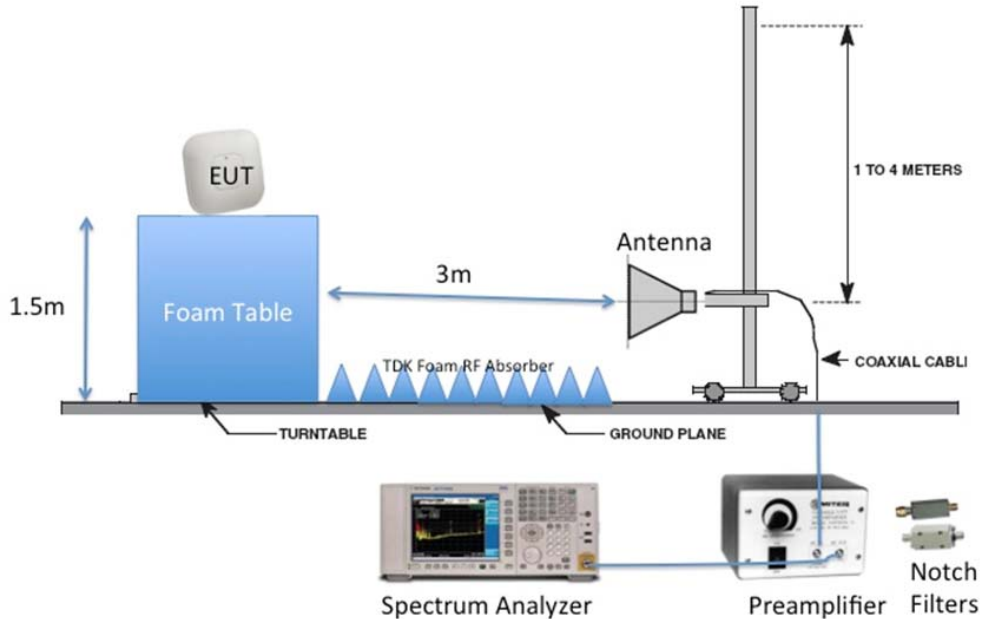

B.1 Radiated Spurious Emissions

FCC 15.205 / 15.407 Radiated emissions which fall in the restricted bands, as defined in Section 15.205(a), must also comply with the radiated emission limits specified in Section 15.209(a) (see Section 15.205(c)).

Ref. ANSI C63.10: 2013 section 12.7.6 (peak) & 12.7.7.3 (average)

Using Vasona, configure the spectrum analyzer as shown below (be sure to enter all losses between the transmitter output and the spectrum analyzer). Place the radio in continuous transmit mode.

Span:	1GHz – 18 GHz/18GHz-26G/26GHz-40GHz
Reference Level:	80 dBuV
Attenuation:	10 dB
Sweep Time:	Coupled
Resolution Bandwidth:	1MHz
Video Bandwidth:	3 MHz for peak, 1 KHz for average
Detector:	Peak

Terminate the access Point RF ports with 50 ohm loads.

Maximize Turntable (find worst case table angle), Maximize Antenna (find worst case height)

Save 2 plots: 1) Average plot (Vertical and Horizontal), Limit= 54dBuV/m @3m
 2) Peak plot (Vertical and Horizontal), Limit = 74dBuV/m @3m

Place a marker at the end of the restricted band closest to the transmit frequency to show compliance.
 Also measure any emissions in the restricted bands.

This report represents the worst case data for all supported operating modes and antennas. There are no measurable emissions above 18 GHz.

System Number	Description	Samples	System under test	Support equipment
2	EUT	S03	<input checked="" type="checkbox"/>	<input type="checkbox"/>
	Support	S04	<input type="checkbox"/>	<input checked="" type="checkbox"/>

Tested By : Jose Aguirre	Date of testing: 20-April-16 - 08-Aug-16
Test Result : PASS	

See Appendix C for list of test equipment

B.1.A Transmitter Radiated Spurious Emissions-Average Worst Case

Frequency (MHz)	Mode	Data Rate (Mbps)	Spurious Emission Level (dBuV/m)	Limit (dBuV/m)	Margin (MHz)
5180Mhz	Non HT20, 6 to 54 Mbps	6	50.4	54.0	3.6
5190Mhz	HT/VHT40, M0 to M23	m0	50.3	54.0	3.7
5200Mhz	Non HT20, 6 to 54 Mbps	6	50.3	54.0	3.7
5210Mhz	VHT80, M0 to M9	m0x1	50.3	54.0	3.7
5230Mhz	HT/VHT40, M0 to M23	m0	50.4	54.0	3.6
5240Mhz	Non HT20, 6 to 54 Mbps	6	50.5	54.0	3.5



Average Radiated Transmitter Spurs, 5180MHz MHz, Non HT20, 6 to 54 Mbps



Average Radiated Transmitter Spurs, 5190MHz MHz, HT/VHT40, M0 to M23



Average Radiated Transmitter Spurs, 5200MHz MHz, Non HT20, 6 to 54 Mbps



Average Radiated Transmitter Spurs, 5210MHz MHz, VHT80, M0 to M9



Average Radiated Transmitter Spurs, 5230MHz MHz, HT/VHT40, M0 to M23



Average Radiated Transmitter Spurs, 5240MHz MHz, Non HT20, 6 to 54 Mbps

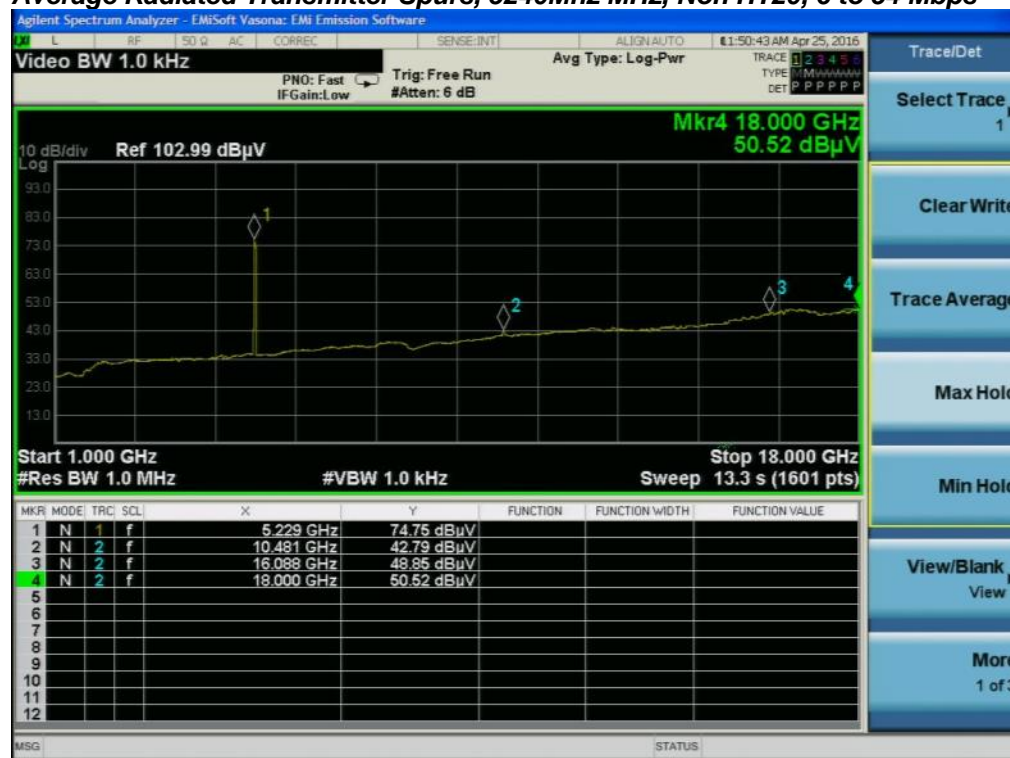



Average Radiated Transmitter Spurs, All modes, All rates, 18-26GHz

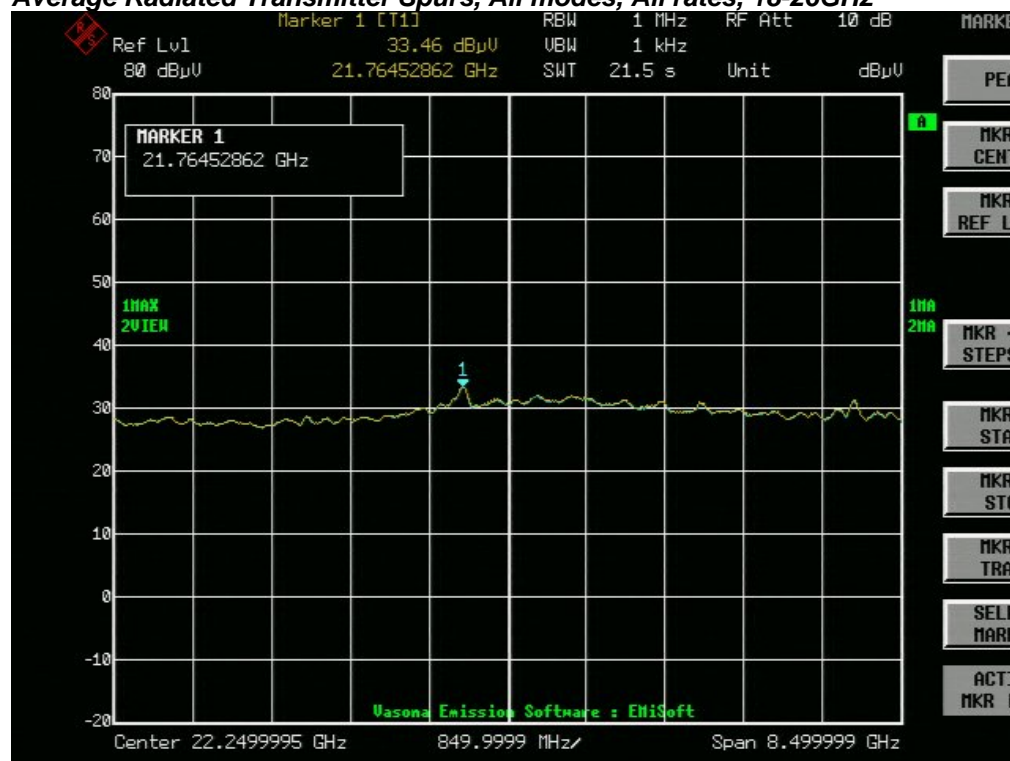

Average Radiated Transmitter Spurs, All modes, All rates, 26-40GHz

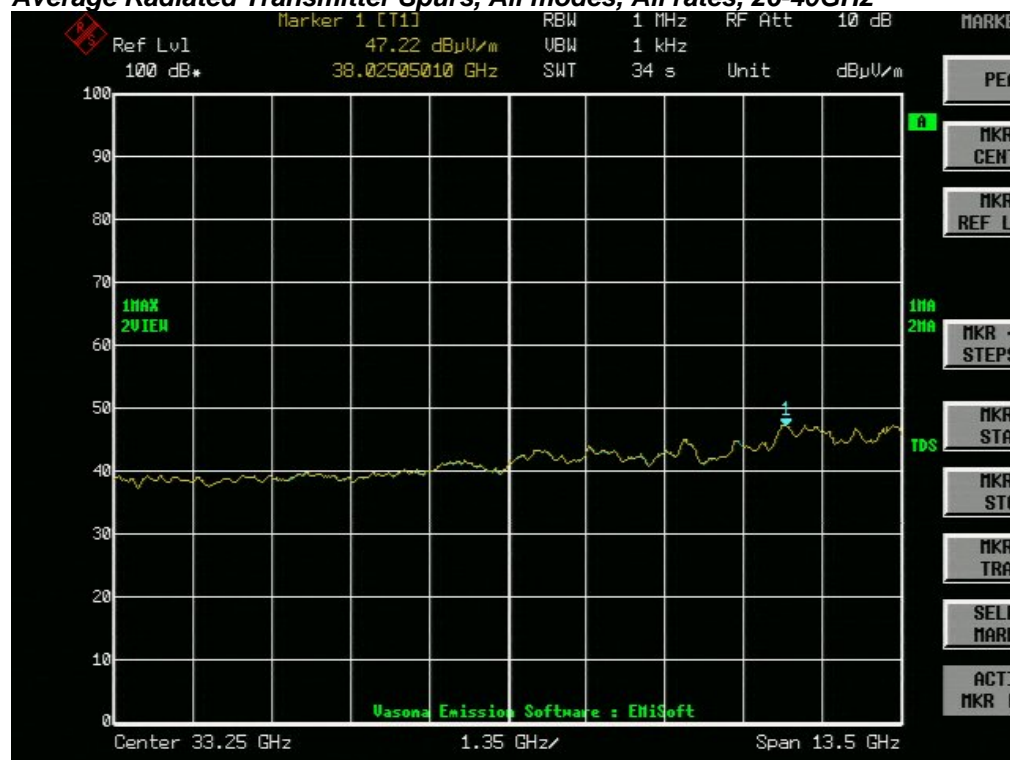



B.1.P Transmitter Radiated Spurious Emissions-Peak Worst Case

Frequency (MHz)	Mode	Data Rate (Mbps)	Spurious Emission Level (dBuV/m)	Limit (dBuV/m)	Margin (MHz)
5180Mhz	Non HT20, 6 to 54 Mbps	6	63.6	74.0	10.4
5190Mhz	HT/VHT40, M0 to M23	m0	61.9	74.0	12.1
5200Mhz	Non HT20, 6 to 54 Mbps	6	63.2	74.0	10.8
5210Mhz	VHT80, M0 to M9	m0x1	62.1	74.0	11.9
5230Mhz	HT/VHT40, M0 to M23	m0	62.9	74.0	11.1
5240Mhz	Non HT20, 6 to 54 Mbps	6	63.7	74.0	10.3

Peak Radiated Transmitter Spurs, 5180MHz MHz, Non HT20, 6 to 54 Mbps

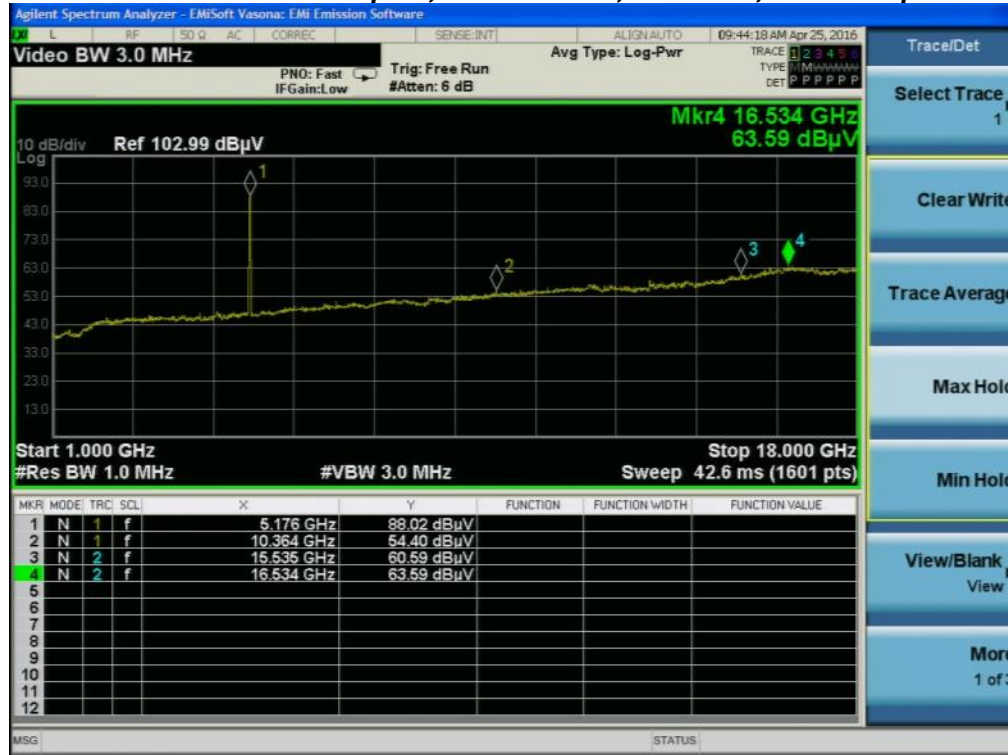

Peak Radiated Transmitter Spurs, 5190MHz MHz, HT/VHT40, M0 to M23



Peak Radiated Transmitter Spurs, 5200MHz MHz, Non HT20, 6 to 54 Mbps



Peak Radiated Transmitter Spurs, 5210MHz MHz, VHT80, M0 to M9



Peak Radiated Transmitter Spurs, 5230MHz MHz, HT/VHT40, M0 to M23



Peak Radiated Transmitter Spurs, 5240MHz MHz, Non HT20, 6 to 54 Mbps



Peak Radiated Transmitter Spurs, All modes, All rates, 18-26GHz

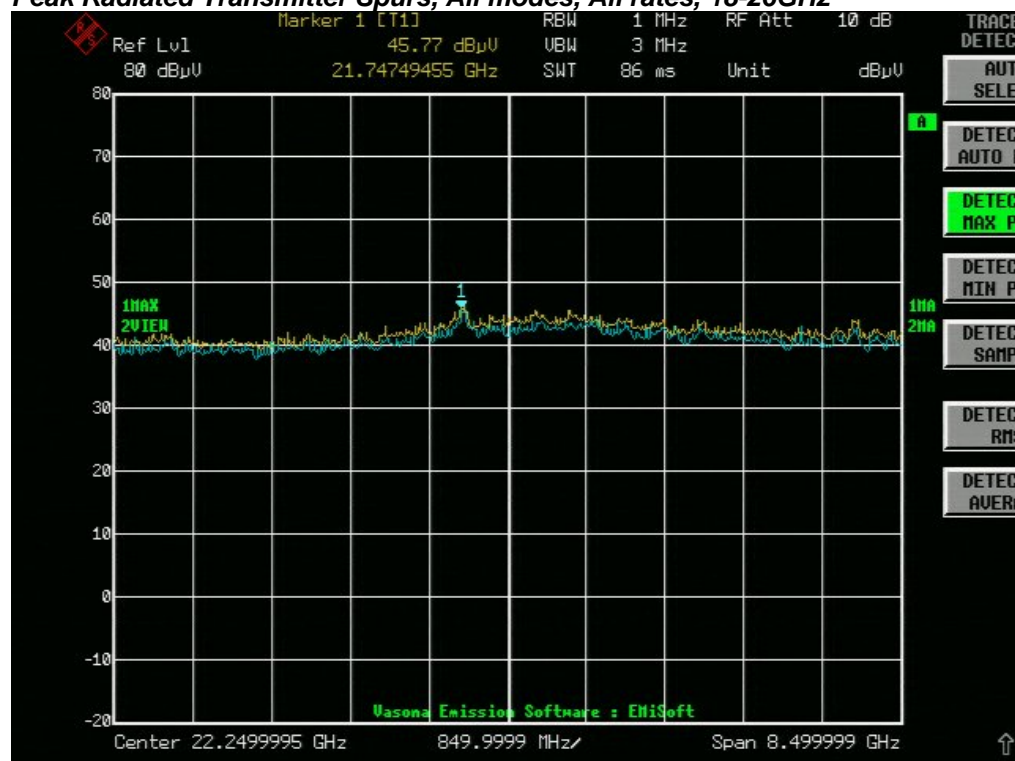

Peak Radiated Transmitter Spurs, All modes, All rates, 26-40GHz

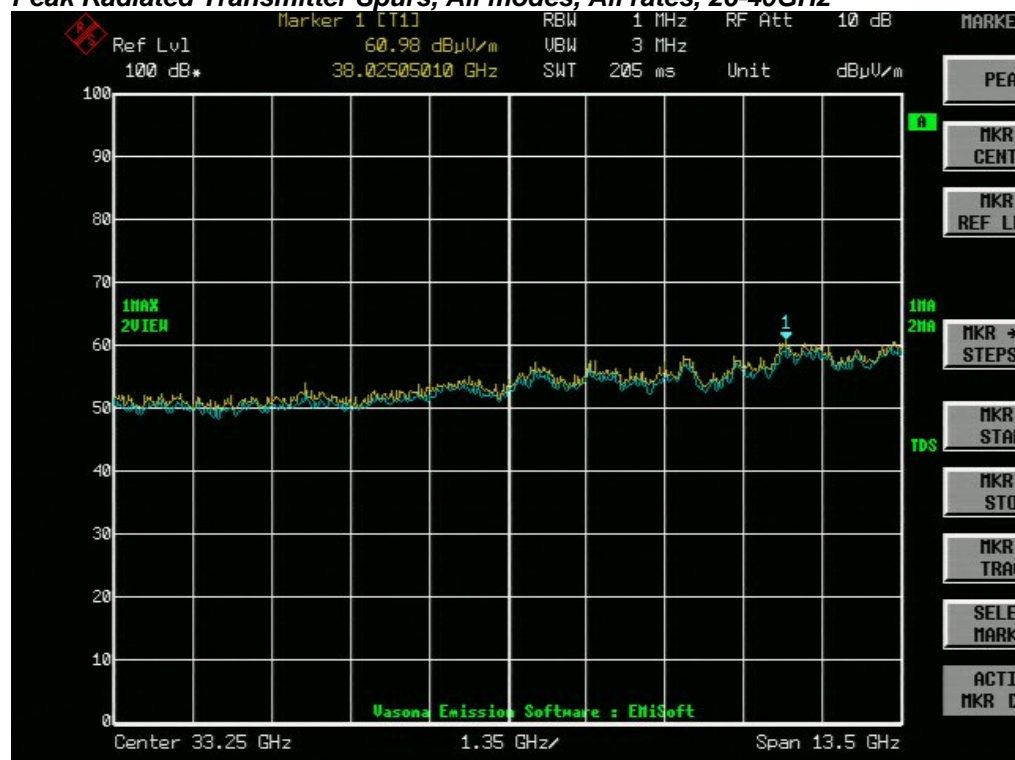

B.2 Radiated Emissions 30MHz to 1GHz

FCC 15.209 / 15.205 / 15.407 Radiated emissions which fall in the restricted bands, as defined in Section 15.205(a), must also comply with the radiated emission limits specified in Section 15.209(a) (see Section 15.205(c)).

Ref. ANSI C63.10: 2013 section 6.5

Using Vasona, configure the spectrum analyzer as shown below (be sure to enter all losses between the transmitter output and the spectrum analyzer). Place the radio in continuous transmit mode.

Span:	30MHz – 1GHz
Reference Level:	80 dBuV
Attenuation:	10 dB
Sweep Time:	Coupled
Resolution Bandwidth:	100kHz
Video Bandwidth:	300kHz
Detector:	Peak for Pre-scan, Quasi-Peak

Compliance shall be determined using CISPR quasi-peak detection; however, peak detection is permitted as an alternative to quasi-peak detection.

Terminate the access Point RF ports with 50 ohm loads.

Maximize Turntable (find worst case table angle), Maximize Antenna (find worst case height)

This report represents the worst case data for all supported operating modes and antennas.

System Number	Description	Samples	System under test	Support equipment
2	EUT	S03	<input checked="" type="checkbox"/>	<input type="checkbox"/>
	Support	S04	<input type="checkbox"/>	<input checked="" type="checkbox"/>

Tested By : Jose Aguirre	Date of testing: 20-April-16 - 08-Aug-16
Test Result : PASS	

See Appendix C for list of test equipment

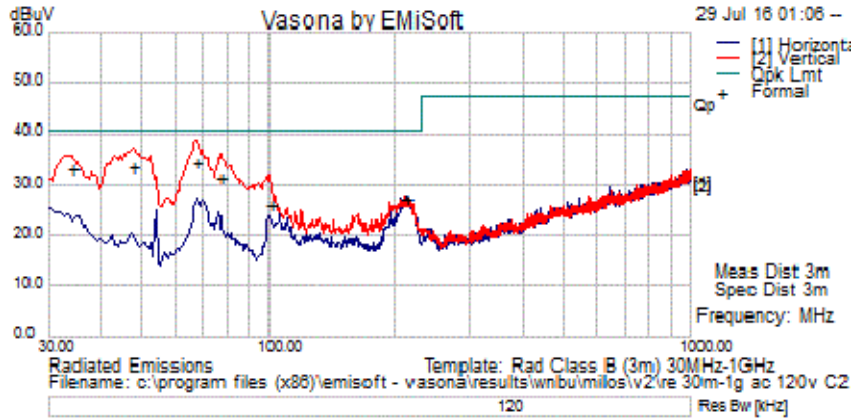

Test Results Table

Frequency (MHz)	Raw (dBuV)	Cable Loss	AF (dB)	Level (dBuV/m)	Measurement Type	Poi	Hgt (cm)	Azt (Deg)	Limit (dBuV/m)	Margin (dB)	Pass/Fail	Comments
34.24375	14.29	0.69	17.95	32.93	Quasi Max	H	105	12	40.50	-7.57	Pass	
47.58125	24.03	0.80	8.83	33.66	Quasi Max	H	113	36	40.50	-6.84	Pass	
212.48125	14.97	1.77	10.50	27.24	Quasi Max	V	117	182	40.50	-13.26	Pass	
100.325	14.43	1.20	10.39	26.02	Quasi Max	H	233	244	40.50	-14.48	Pass	
66.98125	25.03	1.00	8.26	34.29	Quasi Max	H	113	292	40.50	-6.21	Pass	
76.68125	22.45	1.06	8.19	31.70	Quasi Max	H	128	344	40.50	-8.80	Pass	

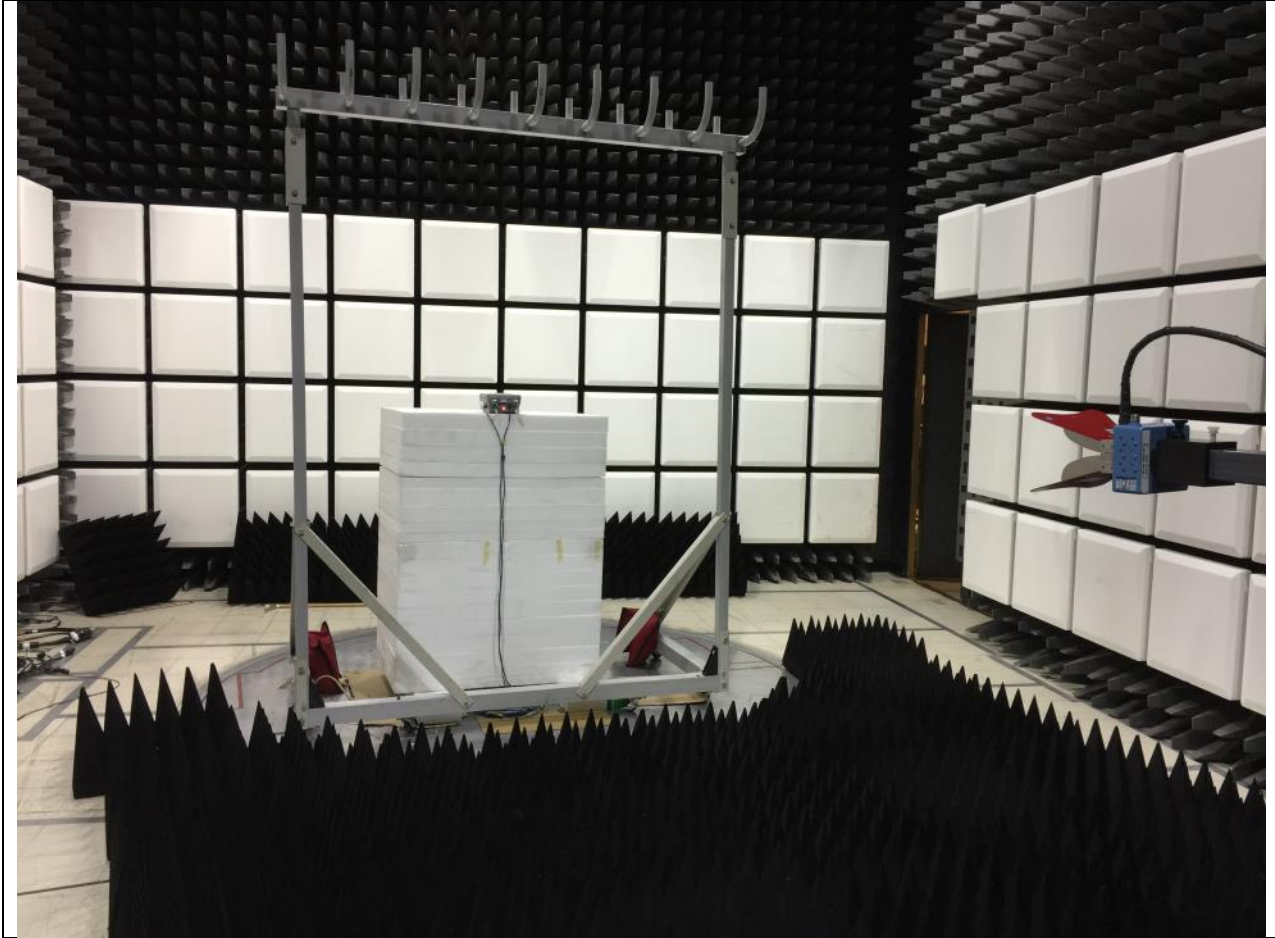

Title: Radiated Emissions Configuration Photograph

B.3 AC Conducted Emissions

FCC 15.207 Except when the requirements applicable to a given device state otherwise, for any radio apparatus equipped to operate from the public utility AC power supply, either directly or indirectly (such as with a battery charger), the radio frequency voltage of emissions conducted back onto the AC power lines in the frequency range of 0.15 MHz to 30 MHz shall not exceed the limits shown in the table in these sections. The more stringent limit applies at the frequency range boundaries.

Measurement Procedure

Accordance with ANSI C63.10:2013 section 6.2

Using Vasona, configure the spectrum analyzer as shown below (be sure to enter all losses between the transmitter output and the spectrum analyzer). Place the radio in continuous transmit mode.

Span:	150 KHz – 30 MHz
Attenuation:	10 dB
Sweep Time:	Coupled
Resolution Bandwidth:	9 KHz
Video Bandwidth:	30 KHz
Detector:	Quasi-Peak / Average

System Number	Description	Samples	System under test	Support equipment
2	EUT	S03	<input checked="" type="checkbox"/>	<input type="checkbox"/>
	Support	S04	<input type="checkbox"/>	<input checked="" type="checkbox"/>

Tested By : Jose Aguirre	Date of testing: 20-April-16 - 08-Aug-16
Test Result : PASS	

See Appendix C for list of test equipment

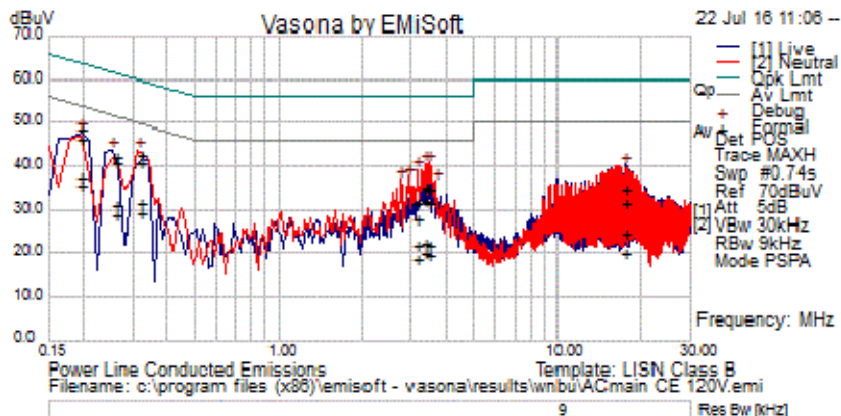

Test Results Table

Frequency (MHz)	Raw (dBuV)	Cable Loss	Factors (dB)	Level (dBuV/m)	Measurement Type	Line	Limit (dBuV/m)	Margin (dB)	Pass/Fail	Comments
.318	22.63	20.28	0.04	42.96	Quasi Peak	Live	59.76	-16.80	Pass	
3.446	14.92	19.99	0.05	34.95	Quasi Peak	Live	56.00	-21.05	Pass	
3.135	11.83	19.98	0.06	31.86	Quasi Peak	Live	56.00	-24.14	Pass	
.195	27.83	20.78	0.05	48.66	Quasi Peak	Live	63.82	-15.16	Pass	
17.358	14.25	20.33	0.19	34.77	Quasi Peak	Live	60.00	-25.23	Pass	
3.350	15.24	19.98	0.05	35.27	Quasi Peak	Live	56.00	-20.73	Pass	
.261	21.84	20.48	0.04	42.36	Quasi Peak	Live	61.40	-19.04	Pass	
3.446	11.71	19.99	0.05	31.75	Quasi Peak	Neutral	56.00	-24.25	Pass	
.195	25.78	20.78	0.05	46.61	Quasi Peak	Neutral	63.82	-17.21	Pass	
3.350	11.97	19.98	0.05	32.01	Quasi Peak	Neutral	56.00	-23.99	Pass	
3.135	8.12	19.98	0.06	28.16	Quasi Peak	Neutral	56.00	-27.84	Pass	
.261	20.21	20.48	0.04	40.73	Quasi Peak	Neutral	61.40	-20.67	Pass	
17.358	4.23	20.33	0.19	24.75	Quasi Peak	Neutral	60.00	-35.25	Pass	
.318	20.63	20.28	0.04	40.95	Quasi Peak	Neutral	59.76	-18.81	Pass	
.318	11.54	20.28	0.04	31.87	Average	Live	49.76	-17.89	Pass	
3.446	1.77	19.99	0.05	21.81	Average	Live	46.00	-24.19	Pass	
3.135	1.82	19.98	0.06	21.86	Average	Live	46.00	-24.14	Pass	
.195	17.05	20.78	0.05	37.87	Average	Live	53.82	-15.95	Pass	
17.358	11.08	20.33	0.19	31.59	Average	Live	50.00	-18.41	Pass	
3.350	2.45	19.98	0.05	22.49	Average	Live	46.00	-23.51	Pass	
.261	10.69	20.48	0.04	31.21	Average	Live	51.40	-20.19	Pass	
3.446	-0.15	19.99	0.05	19.89	Average	Neutral	46.00	-26.11	Pass	
.195	14.85	20.78	0.05	35.68	Average	Neutral	53.82	-18.14	Pass	
3.350	0.12	19.98	0.05	20.16	Average	Neutral	46.00	-25.84	Pass	
3.135	-1.39	19.98	0.06	18.64	Average	Neutral	46.00	-27.36	Pass	
.261	8.30	20.48	0.04	28.82	Average	Neutral	51.40	-22.58	Pass	



Frequency (MHz)	Raw (dBuV)	Cable Loss	Factors (dB)	Level (dBuV/m)	Measurement Type	Line	Limit (dBuV/m)	Margin (dB)	Pass/Fail	Comments
17.358	-0.50	20.33	0.19	20.02	Average	Neutral	50.00	-29.98	Pass	
.318	9.08	20.28	0.04	29.41	Average	Neutral	49.76	-20.35	Pass	



Title: Conducted Emissions Configuration Photograph

This is a dual band 2.4GHz / 5GHz device. All ports in this test set up photo are connected as all testing is automated. Section 2.6 of this test report given an overview of the different Tx antenna combinations used by this device.

Appendix C: List of Test Equipment Used to perform the test

Test Equipment used for Radiated Emissions					
Equip#	Manufacturer/ Model	Description	Last Cal	Next Cal	Test Item
CIS051796	TTA1800-30-HG Miteq	SMA 18 GHz Pre-Amplifier	29-Sep-15	29-Sep-16	B.1, B.2
CIS035285	3117 ETS-Lindgren	Double Ridged Waveguide Horn Antenna	30-Sep-15	30-Sep-16	B.1, B.2
CIS008447	NSA 10m Chamber Cisco	NSA 10m Chamber	14-Oct-15	14-Oct-16	B.3
CIS045096	TH0118 Cisco	Mast Mount Preamplifier Array, 1-18GHz	4-Nov-15	4-Nov-16	B.1, B.2
CIS030652	JB1 Sunol Sciences	Combination Antenna, 30MHz-2GHz	4-Dec-15	4-Dec-16	B.3
CIS041929	iBTHP-5-DB9 Newport	5 inch Temp/RH/Press Sensor w/20ft cable	22-Dec-15	22-Dec-16	B.1, B.2, B.3
CIS043124	Above 1GHz Site Cal Cisco	Above 1GHz Cispr Site Verification	14-Jan-16	14-Jan-17	B.1, B.2
CIS047300	N9038A Agilent Technologies	MXE EMI Receiver 20Hz to 26.5 Ghz	28-Jan-16	28-Jan-17	B.1, B.2, B.3
CIS051642	Sucoflex 106PA Huber+Suhner	RF N Type Cable 8.5m	11-Feb-16	11-Feb-17	B.1, B.2, B.3
CIS030559	UFB311A-1-0950-504504 Micro-Coax	RF Coaxial Cable, to 18GHz, 95 in	15-Feb-16	15-Feb-17	B.1, B.2, B.3
CIS020975	UFB311A-0-1344-520520 Micro-Coax	RF Coaxial Cable, to 18GHz, 134.4 in	17-Feb-16	17-Feb-17	B.1, B.2, B.3
CIS051708	UFB293C-2-0840-300504 Micro-Coax	RF Coaxial SMA-N Type Cable	28-Jun-16	28-Jun-17	B.1, B.2, B.3
CIS044940	ESU40 Rohde & Schwarz	EMI Test Receiver, 20Hz-40GHz	2-Nov-15	2-Nov-16	B.1, B.2
CIS034075	RSG 2000 Schaffner	Reference Spectrum Generator, 1-18GHz	Cal Not Required		
CIS041979	1840 Cisco	18-40GHz EMI Test Head/ Verification Fixture	13-Jul-15	13-Jul-16	B.1, B.2
CIS044940	ESU40 Rohde & Schwarz	EMI Test Receiver, 20Hz-40GHz	2-Nov-15	2-Nov-16	B.1, B.2,
CIS030652	JB1 Sunol Sciences	Combination Antenna, 30MHz-2GHz	4-Dec-15	4-Dec-16	B.3
CIS003003	83731B HP	Synthesized Signal Generator	29-Jan-16	29-Jan-17	B.1, B.2
CIS037236	50CB-015 JFW	GPIB Control Box			B.1, B.2

Test Equipment used for AC Mains Conducted Emissions					
Equip#	Manufacturer/ Model	Description	Last Cal	Next Cal	Test Item
8510	Fischer Custom Communications FCC-450B-2.4-N	Instrumentation Limiter	5/16/16	5/16/17	B.4
23802	Fischer Custom Communications FCC-801-M2-50A	CDN, 2-LINE 50A	1/12/16	1/12/17	B.4
45995	Fischer Custom Communications F-090527-1009-2	Lisn Adapter	6/17/16	6/17/17	B.4
49468	Coleman RG223	BNC 25 ft Cable	3/9/16	3/9/17	B.4
31918	Midwest Microwave TRM-2048-MC-BNC-10	50 Ohm, 5W Terminator, Type BNC	11/9/15	11/9/16	B.4
49531	TTE H785-150K-50-21378	High Pass Filter	5/3/16	5/3/17	B.4
45994	Fischer Custom Communications F-090527-1009-1	Line Impedance Stabilization Network	6/17/16	6/17/17	B.4
18963	York CNE V	Comparison Noise Emitter, 30 - 1000MHz	Cal Not Required	Cal Not Required	B.4
45050	Rohde & Schwarz ESCI	EMI Test Receiver	11/3/15	11/3/16	B.4
51721	Teseq CDN ST08A	Coupling Decoupling Network	6/7/16	6/7/17	B.4
54231	Newport iBTHP-5-DB9	5 inch Temp/RH/Press Sensor w/20ft cable	2/10/16	2/10/17	B.4

Test Equipment used for RF Conducted Tests					
Equip#	Manufacturer/ Model	Description	Last Cal	Next Cal	Test Item
CIS054666	RA08-S1S1-18 MegaPhase	SMA 18" Cable	25-Sep-15	25-Sep-16	A1 thru A7
CIS054667	RA08-S1S1-18 MegaPhase	SMA 18" Cable	25-Sep-15	25-Sep-16	A1 thru A7
CIS054668	RA08-S1S1-18 MegaPhase	SMA 18" Cable	25-Sep-15	25-Sep-16	A1 thru A7
CIS054669	RA08-S1S1-18 MegaPhase	SMA 18" Cable	25-Sep-15	25-Sep-16	A1 thru A7
CIS054686	NI PXI-2796 National Instruments	Plug-in switch module	6-Oct-15	6-Oct-16	A1 thru A7
CIS055166	RFLT4WDC40GK RF Lambda	4 Way Power Divider 40GHz	23-Nov-15	23-Nov-16	A1 thru A7
CIS054662	RFLT4WDC40GK RF Lambda	SMA 36" cable	24-Sep-15	24-Sep-16	A1 thru A7
CIS054656	BRC50705-02 Micro-Tronics	Band Reject Filter	24-Sep-15	24-Sep-16	A1 thru A7
CIS054655	BRC50704-02 Micro-Tronics	Notch Filter, SB:5.470-5.725GHz, to 12GHz	24-Sep-15	24-Sep-16	A1 thru A7
CIS054654	BRC50703-02	Notch Filter,	24-Sep-15	24-Sep-16	A1 thru A7

	Micro-Tronics	SB:5.150-5.350GHz, to 11GHz			
CIS054653	BRM50702-02 Micro-Tronics	Notch Filter, SB:2.400-2.500GHz, to 18GHz	24-Sep-15	24-Sep-16	A1 thru A7
CIS054678	RA08-S1S1-12 MegaPhase	SMA 12" Cable	25-Sep-15	25-Sep-16	A1 thru A7
CIS054677	RA08-S1S1-12 MegaPhase	SMA 12" Cable	25-Sep-15	25-Sep-16	A1 thru A7
CIS054676	RA08-S1S1-12 MegaPhase	SMA 12" Cable	25-Sep-15	25-Sep-16	A1 thru A7
CIS054675	RA08-S1S1-12 MegaPhase	SMA 12" Cable	25-Sep-15	25-Sep-16	A1 thru A7
CIS054674	RA08-S1S1-12 MegaPhase	SMA 12" Cable	25-Sep-15	25-Sep-16	A1 thru A7
CIS054673	RA08-S1S1-12 MegaPhase	SMA 12" Cable	25-Sep-15	25-Sep-16	A1 thru A7
CIS054672	RA08-S1S1-12 MegaPhase	SMA 12" Cable	25-Sep-15	25-Sep-16	A1 thru A7
CIS054671	RA08-S1S1-12 MegaPhase	SMA 12" Cable	25-Sep-15	25-Sep-16	A1 thru A7
CIS054670	RA08-S1S1-12 MegaPhase	SMA 12" Cable	25-Sep-15	25-Sep-16	A1 thru A7
CIS054664	GC12-8181-16 MegaPhase	SMA 16" Cable	25-Sep-15	25-Sep-16	A1 thru A7
CIS054663	F120-S1S1-48 MegaPhase	SMA 48" Cable	25-Sep-15	25-Sep-16	A1 thru A7
CIS054686	NI PXI-2796 National Instruments	Plug-in switch module	6-Oct-15	6-Oct-16	A1 thru A7
CIS042005	BWS30W2+ Mini-Circuits	SMA 30dB Attenuator	16-Oct-15	16-Oct-16	A1 thru A7
CIS041995	BW-S6W2 Mini-Circuits	6dB Attenuator	16-Oct-15	16-Oct-16	A1 thru A7
CIS054695	D3C2060 Ditom	Circulator	20-Oct-15	20-Oct-16	A1 thru A7
CIS055146	RA08-S1S1-12 Megaphase	12" SMA Cable	17-Nov-15	17-Nov-16	A1 thru A7
CIS050721	N9030A Keysight	PXA Signal Analyzer	30-Mar-16	30-Mar-17	A1 thru A7
CIS054303	N5182B Keysight	MXG X-Series RF Vector Signal Generator	6-Apr-16	6-Apr-17	A1 thru A7
CIS055358	ZFSC-2-10G Mini-Circuits	Splitter	11-Apr-16	11-Apr-17	A1 thru A7
CIS055099	SMART2200RM2U Tripp-Lite	Power Supply	Cal Not Required		A1 thru A7
CIS055094	PXI-1042 National Instruments	Chassis	Cal Not Required		A1 thru A7

Appendix E: Abbreviation Key and Definitions

The following table defines abbreviations used within this test report.

Abbreviation	Description	Abbreviation	Description
EMC	Electro Magnetic Compatibility	°F	Degrees Fahrenheit
EMI	Electro Magnetic Interference	°C	Degrees Celsius
EUT	Equipment Under Test	Temp	Temperature
ITE	Information Technology Equipment	S/N	Serial Number
TAP	Test Assessment Schedule	Qty	Quantity
ESD	Electro Static Discharge	emf	Electromotive force
EFT	Electric Fast Transient	RMS	Root mean square
EDCS	Engineering Document Control System	Qp	Quasi Peak
Config	Configuration	Av	Average
CIS#	Cisco Number (unique identification number for Cisco test equipment)	Pk	Peak
Cal	Calibration	kHz	Kilohertz (1×10^3)
EN	European Norm	MHz	MegaHertz (1×10^6)
IEC	International Electro technical Commission	GHz	Gigahertz (1×10^9)
CISPR	International Special Committee on Radio Interference	H	Horizontal
CDN	Coupling/Decoupling Network	V	Vertical
LISN	Line Impedance Stabilization Network	dB	decibel
PE	Protective Earth	V	Volt
GND	Ground	kV	Kilovolt (1×10^3)
L1	Line 1	μ V	Microvolt (1×10^{-6})
L2	Line2	A	Amp
L3	Line 3	μ A	Micro Amp (1×10^{-6})
DC	Direct Current	mS	Milli Second (1×10^{-3})
RAW	Uncorrected measurement value, as indicated by the measuring device	μ S	Micro Second (1×10^{-6})
RF	Radio Frequency	μ S	Micro Second (1×10^{-6})
SLCE	Signal Line Conducted Emissions	m	Meter
Meas dist	Measurement distance	Spec dist	Specification distance
N/A or NA	Not Applicable	SL	Signal Line (or Telecom Line)
P	Power Line	L	Live Line
N	Neutral Line	R	Return
S	Supply	AC	Alternating Current

End