



## Dynamic Frequency Selection (DFS) Test Report

**AIR-AP3802P-x-K9**  
**AIR-AP3802P-UXK9**  
(x=A,B)

Cisco Aironet 802.11ac Dual Band Access Points

FCC ID: LDK102101  
IC: 2461B-102101

**5250-5350, 5470-5725 MHz**

**Against the following Specifications:**

**CFR47 Part 15.407**  
**RSS247**

**Cisco Systems**  
170 West Tasman Drive  
San Jose, CA 95134

	
<b>Author:</b> Jose Aguirre <b>Tested By</b>	<b>Approved By:</b> Jim Nicholson <b>Title:</b> Technical Leader, Engineering <b>Revision:</b> 1

This report replaces any previously entered test report under EDCS – **1552576**. This test report has been electronically authorized and archived using the CISCO Engineering Document Control system.



This test report has been electronically authorized and archived using the CISCO Engineering Document Control system.

**SECTION 1: OVERVIEW ..... 3**

**SECTION 2: ASSESSMENT INFORMATION ..... 4**

    2.1 GENERAL .....4

    2.2 DATE OF TESTING .....6

    2.3 REPORT ISSUE DATE .....6

    2.4 TESTING FACILITIES .....6

    2.5 EQUIPMENT ASSESSED (EUT) .....6

**SECTION 3: RESULT SUMMARY ..... 7**

    3.1 RESULTS SUMMARY TABLE .....7

**SECTION 4: SAMPLE DETAILS ..... 8**

**APPENDIX A: DYNAMIC FREQUENCY SELECTION (DFS) ..... 9**

    A.1 UNII DEVICE DESCRIPTION .....9

    A.2 DFS DETECTION THRESHOLDS .....11

    A.3 RADAR TEST WAVEFORMS .....12

**APPENDIX B: DYNAMIC FREQUENCY SELECTION / TEST RESULTS.....16**

    B.1 TEST PROCEDURE/RESULTS .....22

    B.2 UNII DETECTION BANDWIDTH .....24

    B.3 INITIAL CHANNEL AVAILABILITY CHECK TIME .....89

    B.4 RADAR BURST AT THE BEGINNING OF THE CHANNEL AVAILABILITY CHECK TIME .....90

    B.5 RADAR BURST AT THE END OF THE CHANNEL AVAILABILITY CHECK TIME .....91

    B.6 IN-SERVICE MONITORING FOR CHANNEL MOVE TIME, CHANNEL CLOSING TRANSMISSION TIME AND NON-OCCUPANCY PERIOD.92

    B.7 STATISTICAL PERFORMANCE CHECK .....95

**APPENDIX C: LIST OF TEST EQUIPMENT USED TO PERFORM THE TEST .....112**



## Section 1: Overview

The samples were assessed against the tests detailed in section 3 under the requirements of the following specifications:

<b>Specifications:</b>
CFR47 Part 15.407 RSS-247

RSS-247 section A9.3a allows the use of applicable FCC KDBs

Measurements were made in accordance with

- KDB 905462 D02 UNII DFS Compliance Procedures New Rules v01r02

## Section 2: Assessment Information

### 2.1 General

This report contains an assessment of an apparatus against Electromagnetic Compatibility Standards based upon tests carried out on the samples submitted. The testing was performed by and for the use of Cisco systems Inc:

With regard to this assessment, the following points should be noted:

- a) The results contained in this report relate only to the items tested and were obtained in the period between the date of the initial assessment and the date of issue of the report. Manufactured products will not necessarily give identical results due to production and measurement tolerances.
- b) The apparatus was set up and exercised using the configuration and modes of operation defined in this report only.
- c) Where relevant, the apparatus was only assessed using the susceptibility criteria defined in this report and the Test Assessment Plan (TAP).
- d) All testing was performed under the following environmental conditions:

Temperature	15°C to 35°C (54°F to 95°F)
Atmospheric Pressure	860mbar to 1060mbar (25.4" to 31.3")
Humidity	10% to 75*%
- e) All AC testing was performed at one or more of the following supply voltages:  
110V 60 Hz (+/-20%)

### Units of Measurement

The units of measurements defined in the appendices are reported in specific terms, which are test dependent. Where radiated measurements are concerned these are defined at a particular distance. Basic voltage measurements are defined in units of [dBuV]

As an example, the basic calculation for all measurements is as follows:

$$\text{Emission level [dBuV]} = \text{Indicated voltage level [dBuV]} + \text{Cable Loss [dB]} + \text{Other correction factors [dB]}$$

The combinations of correction factors are dependent upon the exact test configurations [see test equipment lists for further details] and may include:-

Antenna Factors, Pre Amplifier Gain, LISN Loss, Pulse Limiter Loss and Filter Insertion Loss..

Note: to convert the results from dBuV/m to uV/m use the following formula:-

$$\text{Level in uV/m} = \text{Common Antilogarithm} [(X \text{ dBuV/m})/20] = Y \text{ uV/m}$$

## Measurement Uncertainty Values

voltage and power measurements	$\pm 2$ dB
conducted EIRP measurements	$\pm 1.4$ dB
radiated measurements	$\pm 3.2$ dB
frequency measurements	$\pm 2.4 \cdot 10^{-7}$
temperature measurements	$\pm 0.54^{\circ}$
humidity measurements	$\pm 2.3\%$
DC and low frequency measurements	$\pm 2.5\%$

Where relevant measurement uncertainty levels have been estimated for tests performed on the apparatus. This uncertainty represents an expanded uncertainty expressed at approximately the 95% confidence level using a coverage factor of  $k=2$ .

## Radiated emissions (expanded uncertainty, confidence interval 95%)

30 MHz - 300 MHz	+/- 3.8 dB
300 MHz - 1000 MHz	+/- 4.3 dB
1 GHz - 10 GHz	+/- 4.0 dB
10 GHz - 18GHz	+/- 8.2 dB
18GHz - 26.5GHz	+/- 4.1 dB
26.5GHz - 40GHz	+/- 3.9 dB

## Conducted emissions (expanded uncertainty, confidence interval 95%)

30 MHz – 40GHz	+/- 0.38 dB
----------------	-------------

A product is considered to comply with a requirement if the nominal measured value is below the limit line. The product is considered to not be in compliance in case the nominal measured value is above the limit line.

**This report must not be reproduced except in full, without written approval of Cisco Systems.**

**2.2 Date of testing**

19-February-16

**2.3 Report Issue Date**

04-March-2016

Cisco uses an electronic system to issue, store and control the revision of test reports. This system is called the Engineering Document Control System (EDCS). The actual report issue date is embedded into the original file on EDCS. Any copies of this report, either electronic or paper, that are not on EDCS must be considered uncontrolled.

**2.4 Testing facilities**

This assessment was performed by:

**Testing Laboratory**

Cisco Systems, Inc.,  
125 West Tasman Drive  
San Jose, CA 95134, USA

**Registration Numbers for Industry Canada**

<b>Cisco System Site</b>	<b>Address</b>	<b>Site Identifier</b>
Building P, 10m Chamber	125 West Tasman Dr San Jose, CA 95134	Company #: 2461N-2
Building P, 5m Chamber	125 West Tasman Dr San Jose, CA 95134	Company #: 2461N-1
Building I, 5m Chamber	285 W. Tasman Drive San Jose, California 95134	Company #: 2461M-1

**Test Engineers**

Jose Aguirre

**2.5 Equipment Assessed (EUT)**

AIR-AP3802y-B-K9

### Section 3: Result Summary

#### 3.1 Results Summary Table

##### Conducted emissions

Basic Standard	Technical Requirements / Details	Result
FCC 15.407 RSS-247	Dynamic Frequency Selection (DFS) Detection Threshold	Pass
FCC 15.407 RSS-247	Channel Availability Check Time	Pass
FCC 15.407 RSS-247	Channel Move Time	Pass
FCC 15.407 RSS-247	Channel Closing Time	Pass
FCC 15.407 RSS-247	Non-Occupancy Period	Pass
FCC 15.407 RSS-247	U-NII Detection Bandwidth	Pass



## Section 4: Sample Details

Note: Each sample was evaluated to ensure that its condition was suitable to be used as a test sample prior to the commencement of testing.

### 4.1 Sample Details

Sample No.	Equipment Details	Manufacturer	Hardware Rev.	Firmware Rev.	Software Rev.	Serial Number
S01	AIR-AP3802y-B-K9	Cisco Systems	P2	3.14.33	AP3G3-K9W7-M	FOC19454BA3
S02	AIR-PWR-C	Meanwell	A0	NA	NA	EB46E93226
S03	AIR-CAP3702E-A-K9	Cisco Systems	P2	15.3	AP3G2-K9W7-M	FCW1906NUYD

### 4.2 System Details

System Number	Description	Samples	System under test	Support equipment
1	AIR-AP3802y-B-K9	S01	<input checked="" type="checkbox"/>	<input type="checkbox"/>
	Support Power Supply	S02	<input type="checkbox"/>	<input checked="" type="checkbox"/>
	Support Client Equipment	S03	<input type="checkbox"/>	<input checked="" type="checkbox"/>

### 4.3 Mode of Operation Details

Mode#	Description	Comments
1	Continuous Transmitting	Continuous Transmitting

All measurements were made in accordance with

- KDB 905462 D02 UNII DFS Compliance Procedures New Rules v01r02



## Appendix A: Dynamic Frequency Selection (DFS)

15.407: U-NII devices operating in the 5.25-5.35 GHz band and the 5.47-5.725 GHz band shall employ a TPC mechanism. The U-NII device is required to have the capability to operate at least 6 dB below the mean EIRP value of 30 dBm. A TPC mechanism is not required for systems with an e.i.r.p. of less than 500 mW.

U-NII devices operating in the 5.25-5.35 GHz and 5.47-5.725 GHz bands shall employ a DFS radar detection mechanism to detect the presence of radar systems and to avoid co-channel operation with radar systems.

### A.1 UNII Device Description

1. The AIR-AP3802y-B-K9 Cisco Aironet 802.11ac Access point operates in the following bands:
  - a. 5150-5250 MHz
  - b. 5250-5350 MHz
  - c. 5470-5725 MHz
  - d. 5725-5850 MHz
2. The maximum EIRP of the 5GHz equipment is 30 dBm, and the minimum possible EIRP is -1 dBm.

Below are the available 50 ohm antenna assemblies and their corresponding gains. 0dBi gain was used to set the -63 dBm threshold level (-64dBm +1 dB) during calibration of the test setup.

Frequency	Part Number	Antenna Type	Antenna Gain (dBi)	Model	Antenna Gain >30 degrees (dBi)
<b>2.4 GHz</b>	AIR-ANT24020V-R	Omni	2	3800P	NA
	AIR-ANT2452V-R	Diversity Omni-directional	5.2	3800P	NA
	AIR-ANT2430V-R	MIMO 3-Element Omni	3	3800P	NA
	AIR-ANT2440NV-R	MIMO Wall-Mount Omni Antenna	4	3800P	NA
	AIR-ANT2460NP-R	MIMO 3-Element Patch	6	3800P	NA
<b>5 GHz</b>	AIR-ANT5140V-R	MIMO 3-Element Omni	4	3800P	Indoor Only
	AIR-ANT5140NV-R	MIMO Wall-Mount Omni Antenna	4	3800P	-8
	AIR-ANT5145V-R	Diversity Omni-directional	4.5	3800P	Indoor Only
	AIR-ANT5160NP-R	MIMO 3-Element Patch	6	3800P	3
<b>2.4 / 5 GHz</b>	AIR-ANT2451V-R	Omni	2 / 3	3800P	Indoor Only
	AIR-ANT2451NV-R	Omni	3 / 4	3800P	Indoor Only
	AIR-ANT2524DB-R	Dual-resonant black dipole	2 / 4	3800P	Indoor Only
	AIR-ANT2524DW-R	Dual-resonant white dipole	2 / 4	3800P	Indoor Only
	AIR-ANT2524DG-R	Dual-resonant gray dipole	2 / 4	3800P	Indoor Only
	AIR-ANT2524V4C-R	Dual-resonant ceiling mount omni (4-pack)	2 / 4	3800P	Indoor Only
	AIR-ANT2535SDW-R	Dual-resonant "stubby" monopole	3 / 5	3800P	Indoor Only



AIR-ANT2544V4M-R	Dual-resonant omni (4-pack)	4 / 4	3800P	Indoor Only
AIR-ANT2566P4W-R	Dual-resonant "directional" antenna (4-pack)	6 / 6	3800P	3
AIR-ANT2566D4M-R	Dual-Band Polarization-Diverse Directional Array	6 / 6	3800P	3
AIR-ANT2513P4M-N	Dual-resonant cross-pol "directional" antenna (4-pack)	13 / 13	3800P	-7
AIR-ANT25-LOC-02	Directional HL / Directional WiFi	3 / 4	3800P	
AIR-ANT25-LOC-03	Linear HL / Omni WiFi	0 / 1	3800P	
AIR-ANT25-LOC-04	Omni HL / Omni WiFi	0 / 1	3800P	

3. System testing was performed with the designated MPEG test file that streams full motion video at 30 frames per second from the Master to the Client IP based system.
4. The Master requires 106.5 seconds to complete its power-on cycle.
5. Information regarding the parameters of the detected Radar Waveforms is not available to the end user.
6. For the 5250-5350 MHz and 5470-5725 MHz bands, the Master device provides, on aggregate, uniform loading of the spectrum across all devices by selecting an operating channel among the available channels using a random algorithm.

## A.2 DFS Detection Thresholds

### 1. Interference Threshold values, Master or Client incorporating In-Service Monitoring

Maximum Transmit Power	Value (See Notes 1, 2, and 3)
EIRP $\geq$ 200 milliwatt	-64 dBm
EIRP < 200 milliwatt and power spectral density < 10 dBm/MHz	-62 dBm
EIRP < 200 milliwatt that do not meet the power spectral density requirement	-64 dBm
<p><b>Note 1:</b> This is the level at the input of the receiver assuming a 0 dBi receive antenna.</p> <p><b>Note 2:</b> Throughout these test procedures an additional 1 dB has been added to the amplitude of the test transmission waveforms to account for variations in measurement equipment. This will ensure that the test signal is at or above the detection threshold level to trigger a DFS response.</p> <p><b>Note 3:</b> EIRP is based on the highest antenna gain. For MIMO devices refer to KDB Publication 662911 D01.</p>	

### 2. DFS Response requirement values

Parameter	Value
<i>Non-occupancy period</i>	Minimum 30 minutes
<i>Channel Availability Check Time</i>	60 seconds
<i>Channel Move Time</i>	10 seconds See Note 1.
<i>Channel Closing Transmission Time</i>	200 milliseconds + an aggregate of 60 milliseconds over remaining 10 second period. See Notes 1 and 2.
<i>U-NII Detection Bandwidth</i>	Minimum 100% of the U-NII 99% transmission power bandwidth. See Note 3.
<p><b>Note 1:</b> <i>Channel Move Time</i> and the <i>Channel Closing Transmission Time</i> should be performed with Radar Type 0. The measurement timing begins at the end of the Radar Type 0 burst.</p> <p><b>Note 2:</b> The <i>Channel Closing Transmission Time</i> is comprised of 200 milliseconds starting at the beginning of the <i>Channel Move Time</i> plus any additional intermittent control signals required to facilitate a <i>Channel</i> move (an aggregate of 60 milliseconds) during the remainder of the 10 second period. The aggregate duration of control signals will not count quiet periods in between transmissions.</p> <p><b>Note 3:</b> During the <i>U-NII Detection Bandwidth</i> detection test, radar type 0 should be used. For each frequency step the minimum percentage of detection is 90 percent. Measurements are performed with no data traffic.</p>	



**A.3 Radar Test Waveforms**

This section provides the parameters for required test waveforms, minimum percentage of successful detections, and the minimum number of trials that must be used for determining DFS conformance. Step intervals of 0.1 microsecond for Pulse Width, 1 microsecond for PRI, 1 MHz for chirp width and 1 for the number of pulses will be utilized for the random determination of specific test waveforms.

**1. Short Pulse Radar Test Waveforms**

Radar Type	Pulse Width (μsec)	PRI (μsec)	Number of Pulses	Minimum Percentage of Successful Detection	Minimum Numbers of Trials
0	1	1428	18	See Note 1	See Note 1
1	1	Test A: 15 unique PRI values randomly selected from the list of 23 PRI values in Table 5a	$\text{Roundup} \left\{ \left( \frac{1}{360} \right) \cdot \left( \frac{19 \cdot 10^6}{\text{PRI}_{\mu\text{sec}}} \right) \right\}$	60%	30
		Test B: 15 unique PRI values randomly selected within the range of 518-3066 μsec, with a minimum increment of 1 μsec, excluding PRI values selected in Test A			
2	1-5	150-230	23-29	60%	30
3	6-10	200-500	16-18	60%	30
4	11-20	200-500	12-16	60%	30
Aggregate (Radar Types 1-4)				80%	120
<p><b>Note 1:</b> Short Pulse Radar Type 0 shall only be used for the channel availability and detection bandwidth tests. It should be noted that any of the radar test waveforms 0 – 4 can be used for the channel availability and detection bandwidth tests.</p>					

A minimum of 30 unique waveforms are required for each of the Short Pulse Radar Types 2 through 4. If more than 30 waveforms are used for Short Pulse Radar Types 2 through 4, then each additional waveform must also be unique and not repeated from the previous waveforms. If more than 30 waveforms are used for Short Pulse Radar Type 1, then each additional waveform is generated with Test B and must also be unique and not repeated from the previous waveforms in Tests A or B.



For example if in Short Pulse Radar Type 1 Test B a PRI of 3066  $\mu$ sec is selected, the number of pulses would be  $\text{Roundup}\left\{\left(\frac{1}{360}\right) \cdot \left(\frac{19 \cdot 10^6}{3066}\right)\right\} = \text{Roundup}\{17.2\} = 18$

**Table 5a – Pulse Repetition Intervals Values for Test A**

Pulse Repetition Frequency Number	Pulse Repetition Frequency (Pulses Per Second)	Pulse Repetition Interval (Microseconds)
1	1930.5	518
2	1858.7	538
3	1792.1	558
4	1730.1	578
5	1672.2	598
6	1618.1	618
7	1567.4	638
8	1519.8	658
9	1474.9	678
10	1432.7	698
11	1392.8	718
12	1355.0	738
13	1319.3	758
14	1285.3	778
15	1253.1	798
16	1222.5	818
17	1193.3	838
18	1165.6	858
19	1139.0	878
20	1113.6	898
21	1089.3	918
22	1066.1	938
23	326.2	3066

The aggregate is the average of the percentage of successful detections of Short Pulse Radar Types 1-4. For example, the following table indicates how to compute the aggregate of percentage of successful detections.

Radar Type	Number of Trials	Number of Successful Detections	Minimum Percentage of Successful Detection
1	35	29	82.9%
2	30	18	60%
3	30	27	90%
4	50	44	88%
Aggregate $(82.9\% + 60\% + 90\% + 88\%)/4 = 80.2\%$			

## 2. Long Pulse Radar Test Waveform

Radar Type	Pulse Width (µsec)	Chirp Width (MHz)	PRI (µsec)	Number of Pulses per Burst	Number of Bursts	Minimum Percentage of Successful Detection	Minimum Trials
5	50-100	5-20	1000- 2000	1-3	8-20	80%	30

The parameters for this waveform are randomly chosen. Thirty unique waveforms are required for the Long Pulse radar test signal. If more than 30 waveforms are used for the Long Pulse radar test signal, then each additional waveform must also be unique and not repeated from the previous waveforms.

Each waveform is defined as follows:

- 1) The transmission period for the Long Pulse Radar test signal is 12 seconds.
- 2) There are a total of 8 to 20 Bursts in the 12 second period, with the number of Bursts being randomly chosen. This number is Burst\_Count.
- 3) Each Burst consists of 1 to 3 pulses, with the number of pulses being randomly chosen. Each Burst within the 12 second sequence may have a different number of pulses.
- 4) The pulse width is between 50 and 100 microseconds, with the pulse width being randomly chosen. Each pulse within a Burst will have the same pulse width. Pulses in different Bursts may have different pulse widths.
- 5) Each pulse has a linear FM chirp between 5 and 20 MHz, with the chirp width being randomly chosen. Each pulse within a Burst will have the same chirp width. Pulses in different Bursts may have different chirp widths. The chirp is centered on the pulse. For example, with a radar frequency of 5300 MHz and a 20 MHz chirped signal, the chirp starts at 5290 MHz and ends at 5310 MHz.
- 6) If more than one pulse is present in a Burst, the time between the pulses will be between 1000 and 2000 microseconds, with the time being randomly chosen. If three pulses are present in a Burst, the time between the first and second pulses is chosen independently of the time between the second and third pulses.
- 7) The 12 second transmission period is divided into even intervals. The number of intervals is equal to Burst\_Count. Each interval is of length  $(12,000,000 / \text{Burst\_Count})$  microseconds. Each interval contains one Burst. The start time for the Burst, relative to the beginning of the interval, is between 1 and  $[(12,000,000 / \text{Burst\_Count}) - (\text{Total Burst Length}) + (\text{One Random PRI Interval})]$  microseconds, with the start time being randomly chosen. The step interval for the start time is 1 microsecond. The start time for each Burst is chosen randomly.

### A representative example of a Long Pulse radar test waveform:

- 1) The total test signal length is 12 seconds.
- 2) 8 Bursts are randomly generated for the Burst\_Count.
- 3) Burst 1 has 2 randomly generated pulses.
- 4) The pulse width (for both pulses) is randomly selected to be 75 microseconds.
- 5) The PRI is randomly selected to be at 1213 microseconds.
- 6) Bursts 2 through 8 are generated using steps 3 – 5.
- 7) Each Burst is contained in even intervals of 1,500,000 microseconds. The starting location for Pulse 1, Burst 1 is randomly generated (1 to 1,500,000 minus the total Burst 1 length + 1 random PRI interval) at the 325,001 microsecond step. Bursts 2 through 8 randomly fall in successive 1,500,000 microsecond intervals (i.e. Burst 2 falls in the 1,500,001 – 3,000,000 microsecond range).

**Graphical Representation of a Long Pulse radar Test Waveform**

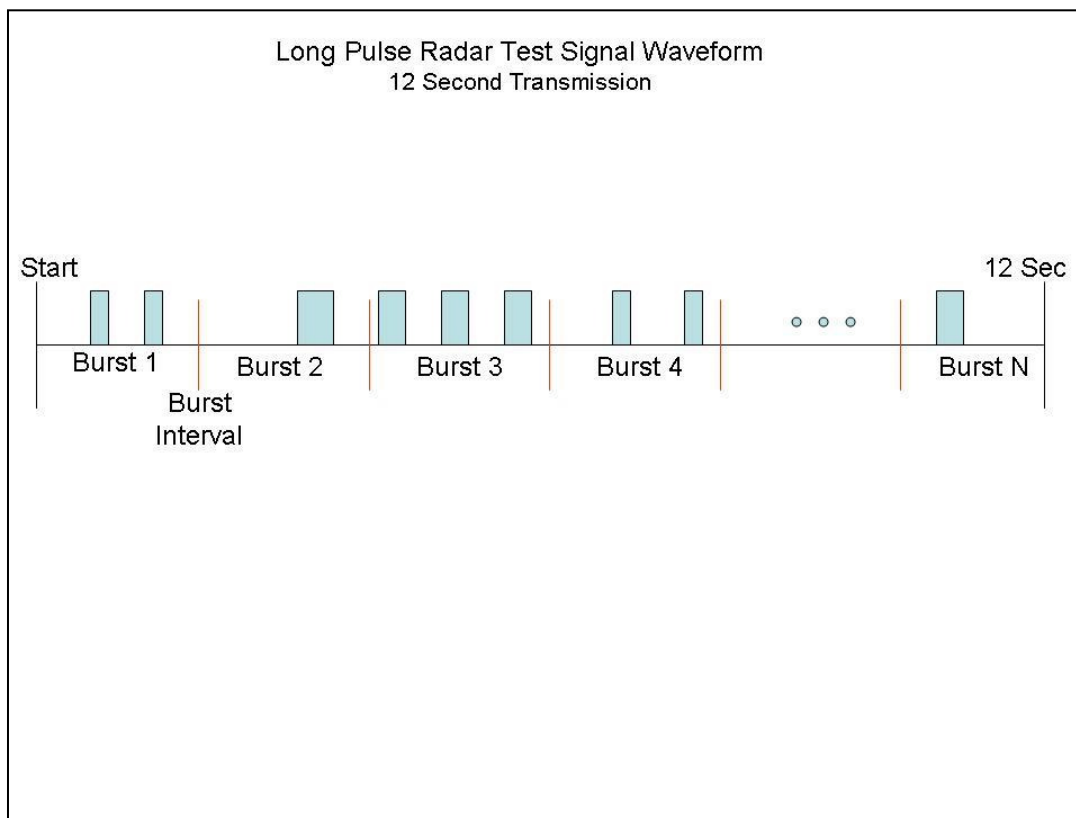

**3. Long Pulse Radar Test Waveform**

Radars Type	Pulse Width (μsec)	PRI (μsec)	Pulses per Hop	Hopping Rate (kHz)	Hopping Sequence Length (msec)	Minimum Percentage of Successful Detection	Minimum Trials
6	1	333	9	.333	300	70%	30

For the Frequency Hopping Radar Type, the same *Burst* parameters are used for each waveform. The hopping sequence is different for each waveform and a 100-length segment is selected<sup>1</sup> from the hopping sequence defined by the following algorithm:

The first frequency in a hopping sequence is selected randomly from the group of 475 integer frequencies from 5250 – 5724 MHz. Next, the frequency that was just chosen is removed from the group and a frequency is randomly selected from the remaining 474 frequencies in the group. This process continues until all 475 frequencies are chosen for the set. For selection of a random frequency, the frequencies remaining within the group are always treated as equally likely.



**Appendix B: Dynamic Frequency Selection / Test Results**

**Standards Reference:**

FCC 15.407 / RSS-247

**Test Procedure**

**Ref.** KDB 905462 D02 UNII DFS Compliance Procedures New Rules v01r02

Test parameters
Span = 0 Hz
RBW ≥ 3 MHz
VBW ≥ 3 MHz
Detector = Peak
Trace = Single Sweep

System Number	Description	Samples	System under test	Support equipment
1	AIR-AP3802y-B-K9	S01	<input checked="" type="checkbox"/>	<input type="checkbox"/>
	Support Power Supply	S02	<input type="checkbox"/>	<input checked="" type="checkbox"/>
	Support Client Equipment	S03	<input type="checkbox"/>	<input checked="" type="checkbox"/>

<b>Tested By :</b> Jose Aguirre	<b>Date of testing:</b> 19-February-16
<b>Test Result : PASS</b>	

See Appendix C for list of test equipment



The following equipment setup was used to calibrate the conducted Radar Waveform. A spectrum analyzer was used to establish the test signal level for each radar type. During this process there were no transmissions by either the Master or Client Device. The spectrum analyzer was switched to the zero span (Time Domain) mode at the frequency of the Radar Waveform generator. Peak detection was utilized. The spectrum analyzer resolution bandwidth (RBW) and video bandwidth (VBW) were set to 3 MHz.

The signal generator amplitude was set so that the power level measured at the spectrum analyzer was -63dBm.

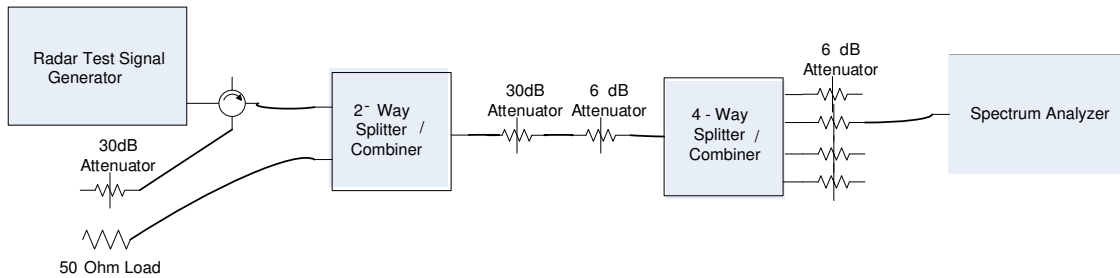

**Conducted Calibration Setup**

Following are the calibration plots for each of the required radar waveforms.

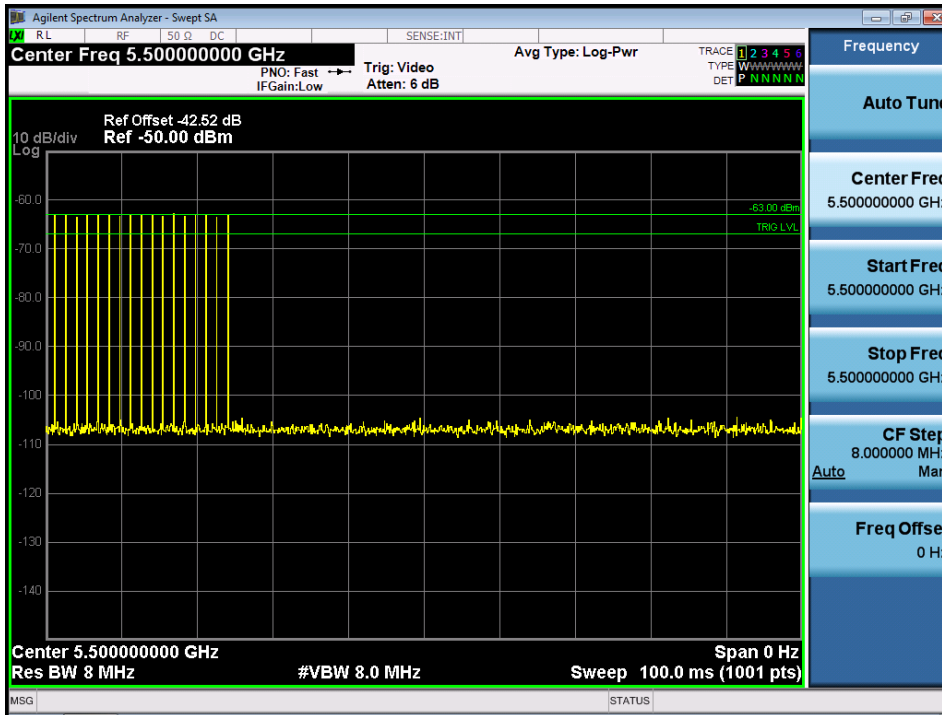

**USA Bin 0 Radar Calibration**

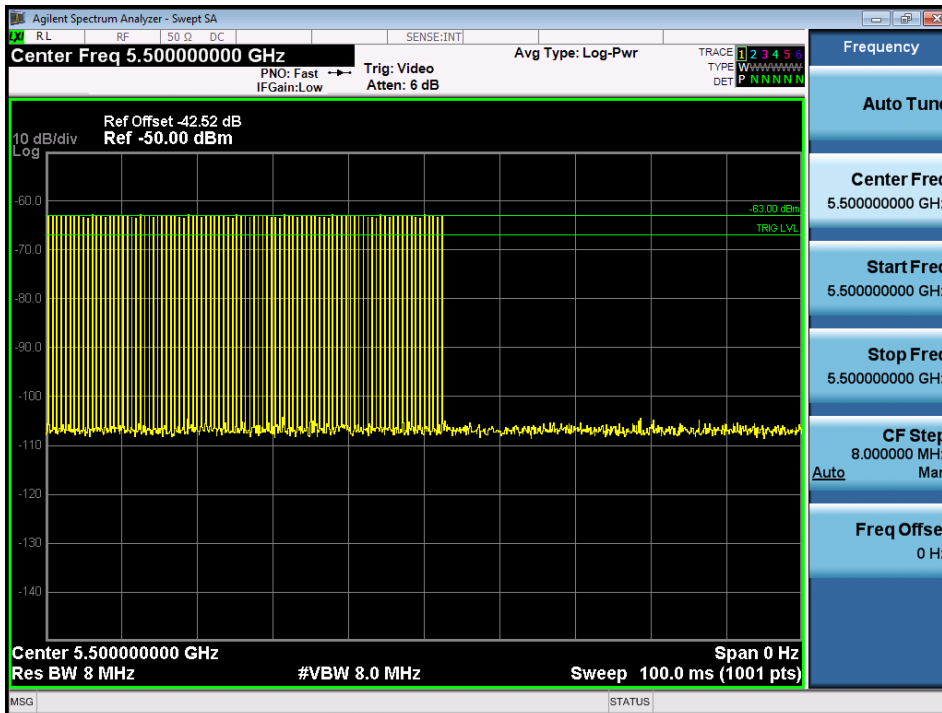

**USA Bin 1A Radar Calibration**

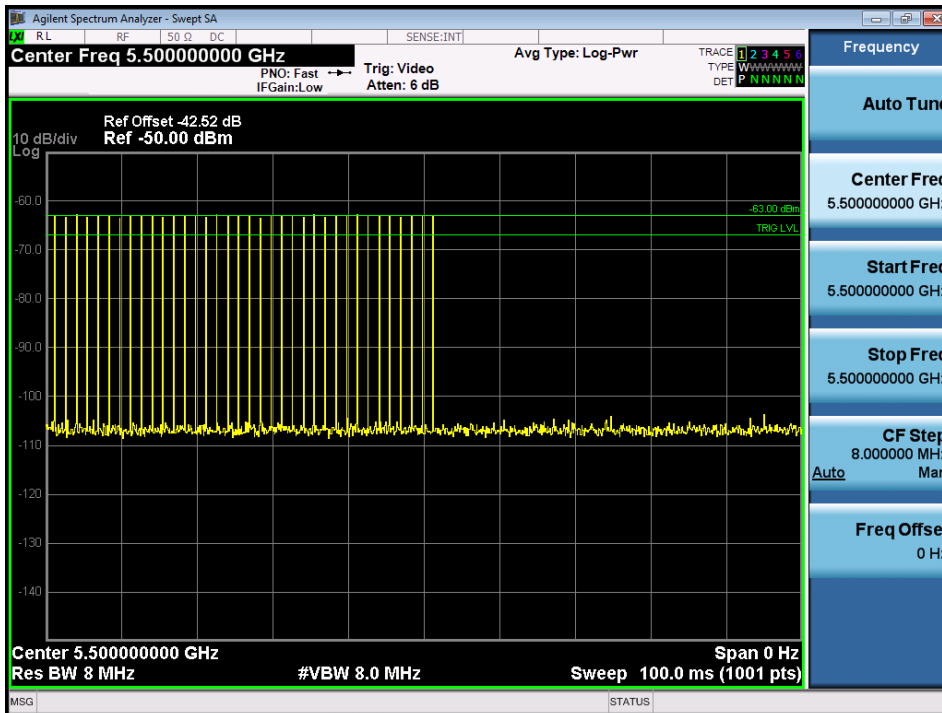

**USA Bin 1B Radar Calibration**

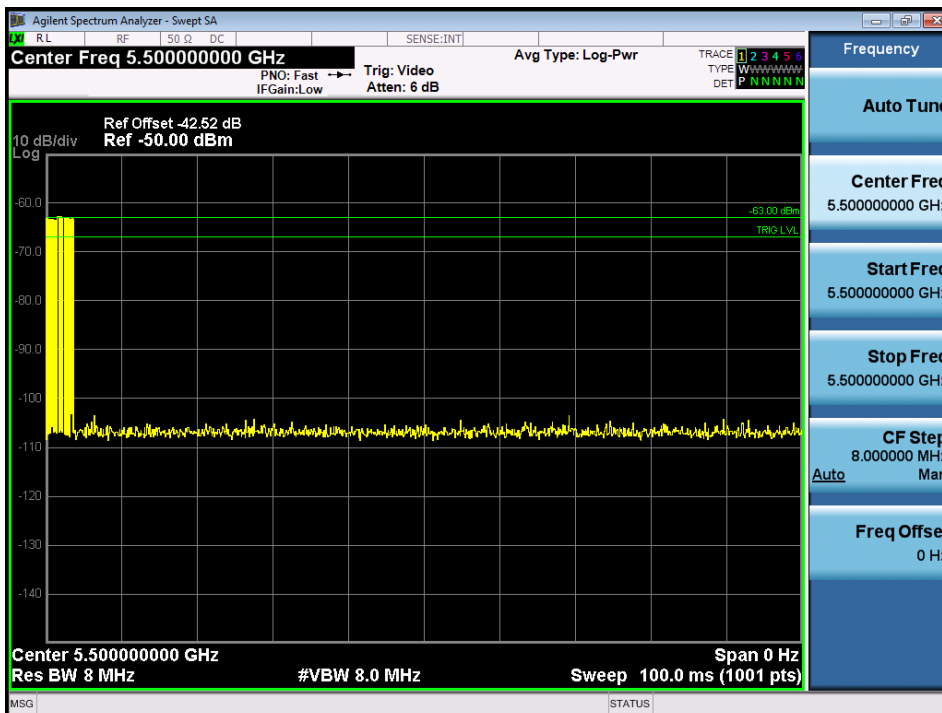

**USA Bin 2 Radar Calibration**

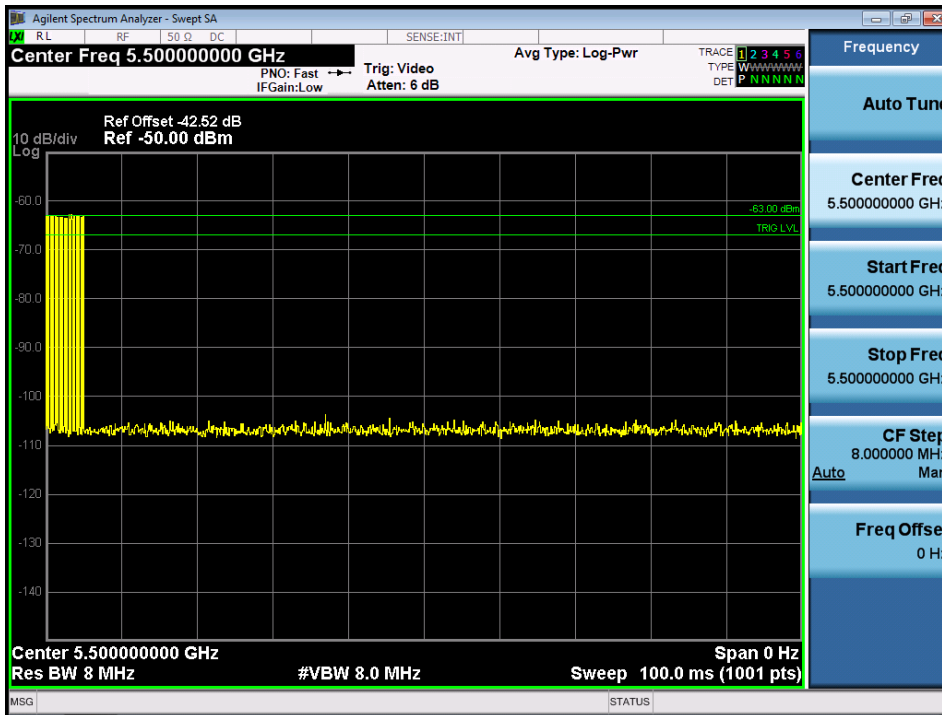

**USA Bin 3 Radar Calibration**

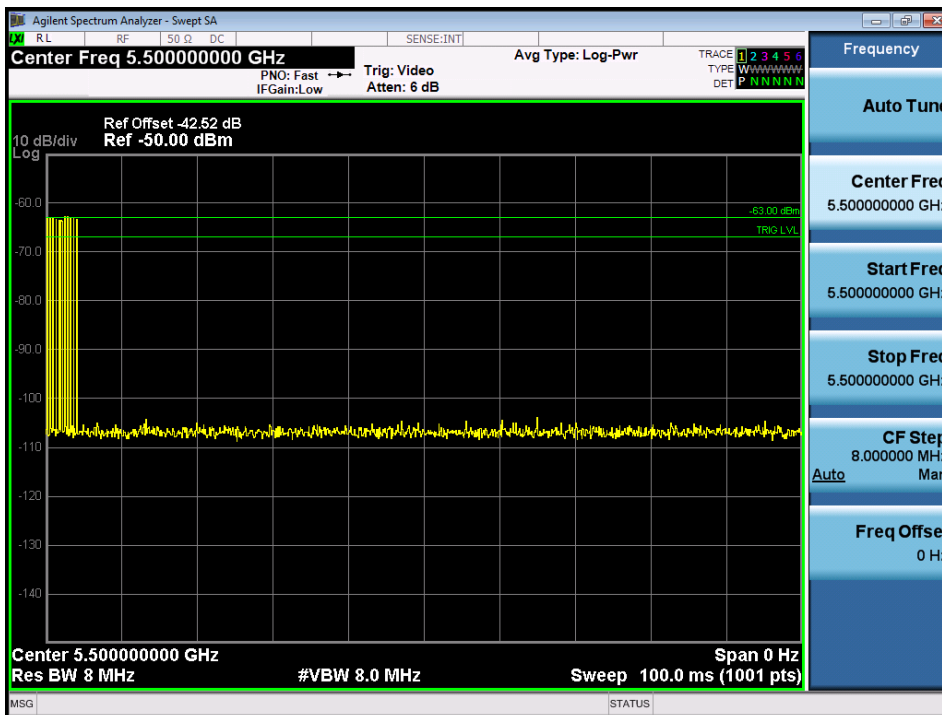

**USA Bin 4 Radar Calibration**

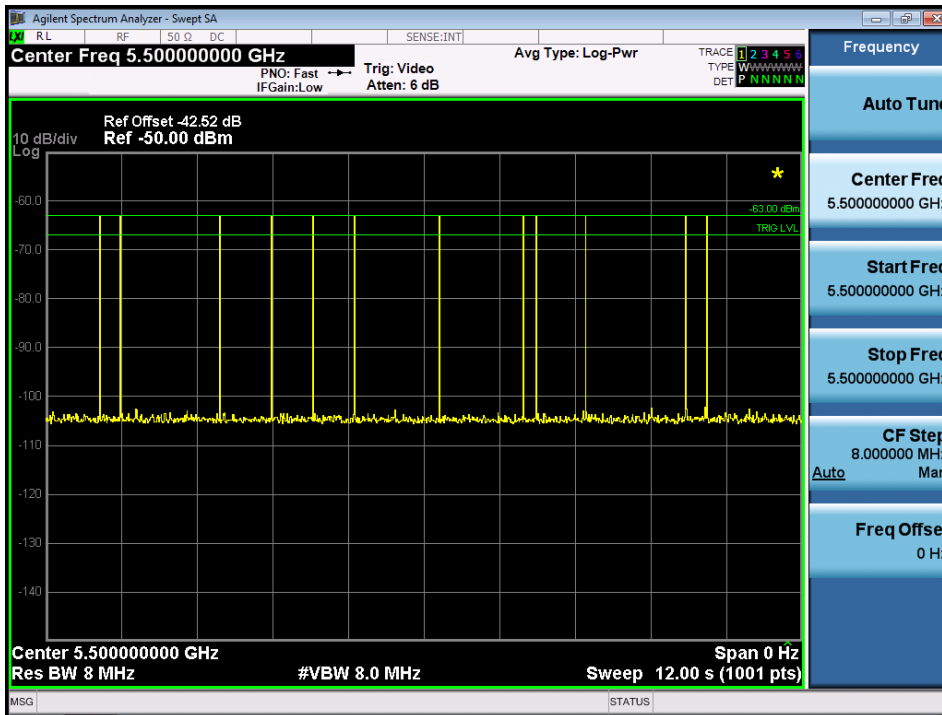

**USA Bin 5 Radar Calibration**

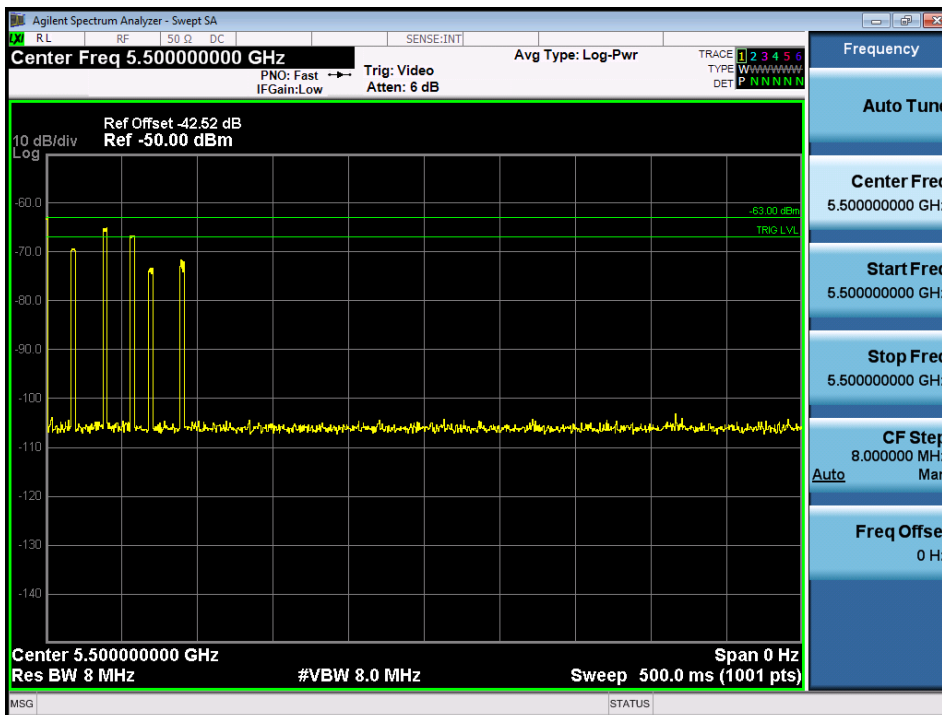

**USA Frequency Hopping Radar Calibration**

**B.1 Test Procedure/Results**

A spectrum analyzer is used as a monitor to verify that the UUT has vacated the Channel within the (Channel Closing Transmission Time and Channel Move Time) and does not transmit on a Channel during the Non-Occupancy Period after the detection and Channel move. It is also used to monitor UUT transmissions during the Channel Availability Check Time.

Following is the test setup used to generate the Radar Waveforms, and for all DFS tests described herein.

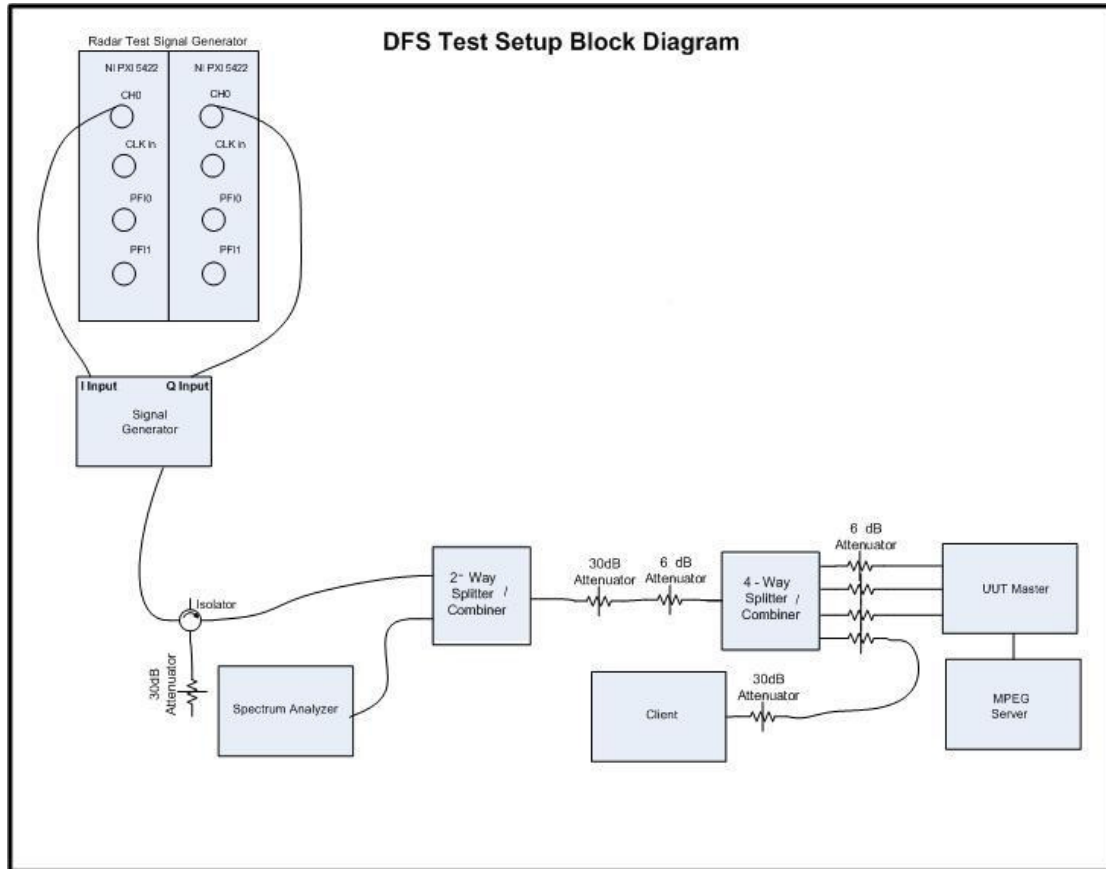

**Conducted Setup: Radar Test Waveforms are injected into the Master**

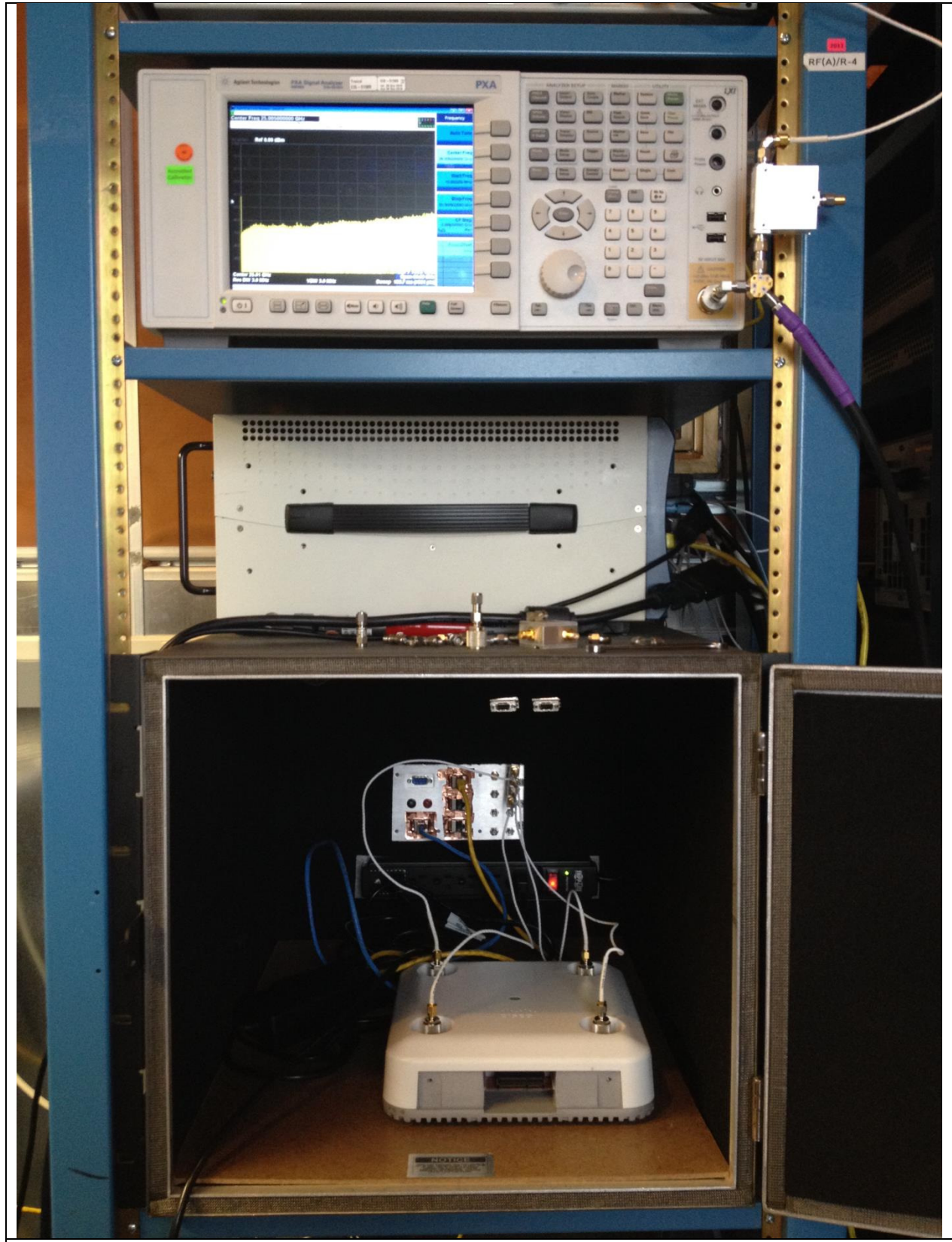

**Title:** DFS Setup

## B.2 UNII Detection Bandwidth

### Test Procedure

**Ref.** KDB 905462 D02 UNII section 7.8.1

All UNII 20 MHz channels for this device have identical Channel bandwidths, all 40 MHz channels have identical Channel bandwidths, and all 80 MHz channels have identical Channel bandwidths. Therefore, all DFS testing was done at 5500 MHz. The 99% channel bandwidth for 20MHz signals is 18 MHz, the the 99% channel bandwidth for 40MHz signals is 36 MHz, and the 99% channel bandwidth for 80MHz signals is 76. (See the 26dB BW section of the RF report for further measurement details).

The generating equipment is configured as shown in the Conducted Test Setup above. A single *Burst* of the desired radar profile is produced at 5500MHz at a -63dBm level. The UUT is set up as a standalone device (no associated Client and no traffic).

A single radar Burst is generated for a minimum of 10 trials, and the response of the UUT is noted. The UUT must detect the Radar Waveform 90% or more of the time.

The radar frequency is increased in 1 MHz steps, repeating the above test sequence, until the detection rate falls below 90%. The highest frequency at which detection is greater than or equal to 90% is denoted as  $F_H$ .

The radar frequency is decreased in 1 MHz steps, repeating the above test sequence, until the detection rate falls below 90%. The lowest frequency at which detection is greater than or equal to 90% is denoted as  $F_L$ .

The U-NII Detection Bandwidth is calculated as follows:

$$\text{U-NII Detection Bandwidth} = F_H - F_L$$

The U-NII Detection Bandwidth must be at least 100% of the UUT transmitter 99% power bandwidth (18 MHz for 20MHz signals, 36 MHz for 40 MHz signals, and 76 MHz for 80 MHz signals); otherwise, the UUT does not comply with DFS requirements.

For the chirped Bin 5 radar, the U-NII Detection Bandwidth must be at least 80% of the UUT transmitter 99% power bandwidth (14 MHz for 20MHz signals, 28 MHz for 40 MHz signals, and 60 MHz for 80 MHz signals); otherwise, the UUT does not comply with DFS requirements.





Radars Frequency	DFS Detection Trials (1=Detection, Blank= No Detection)										Detection Rate (%)	Detection Bandwidth (MHz)	Limit (MHz)
	1	2	3	4	5	6	7	8	9	10			
5490	1	1	1	1	1	1	1	1	1	1	100	20	17
5491	1	1	1	1	1	1	1	1	1	1	100		
5492	1	1	1	1	1	1	1	1	1	1	100		
5493	1	1	1	1	1	1	1	1	1	1	100		
5494	1	1	1	1	1	1	1	1	1	1	100		
5495	1	1	1	1	1	1	1	1	1	1	100		
5496	1	1	1	1	1	1	1	1	1	1	100		
5497	1	1	1	1	1	1	1	1	1	1	100		
5498	1	1	1	1	1	1	1	1	1	1	100		
5499	1	1	1	1	1	1	1	1	1	1	100		
5500	1	1	1	1	1	1	1	1	1	1	100		
5501	1	1	1	1	1	1	1	1	1	1	100		
5502	1	1	1	1	1	1	1	1	1	1	100		
5503	1	1	1	1	1	1	1	1	1	1	100		
5504	1	1	1	1	1	1	1	1	1	1	100		
5505	1	1	1	1	1	1	1	1	1	1	100		
5506	1	1	1	1	1	1	1	1	1	1	100		
5507	1	1	1	1	1	1	1	1	1	1	100		
5508	1	1	1	1	1	1	1	1	1	1	100		
5509	1	1	1	1	1	1	1	1	1	1	100		
5510	1	1	1	1	1	1	1	1	1	1	100		

**USA Bin 0**



Radars	DFS Detection Trials (1=Detection, Blank= No Detection)										Detection Rate (%)	Detection Bandwidth (MHz)	Limit (MHz)
	1	2	3	4	5	6	7	8	9	10			
5490	1	1	1	1	1	1	1	1	1	1	100	20	17
5491	1	1	1	1	1	1	1	1	1	1	100		
5492	1	1	1	1	1	1	1	1	1	1	100		
5493	1	1	1	1	1	1	1	1	1	1	100		
5494	1	1	1	1	1	1	1	1	1	1	100		
5495	1	1	1	1	1	1	1	1	1	1	100		
5496	1	1	1	1	1	1	1	1	1	1	100		
5497	1	1	1	1	1	1	1	1	1	1	100		
5498	1	1	1	1	1	1	1	1	1	1	100		
5499	1	1	1	1	1	1	1	1	1	1	100		
5500	1	1	1	1	1	1	1	1	1	1	100		
5501	1	1	1	1	1	1	1	1	1	1	100		
5502	1	1	1	1	1	1	1	1	1	1	100		
5503	1	1	1	1	1	1	1	1	1	1	100		
5504	1	1	1	1	1	1	1	1	1	1	100		
5505	1	1	1	1	1	1	1	1	1	1	100		
5506	1	1	1	1	1	1	1	1	1	1	100		
5507	1	1	1	1	1	1	1	1	1	1	100		
5508	1	1	1	1	1	1	1	1	1	1	100		
5509	1	1	1	1	1	1	1	1	1	1	100		
5510	1	1	1	1	1	1	1	1	1	1	100		

**USA Bin 1A Radar**



Radars	DFS Detection Trials (1=Detection, Blank= No Detection)										Detection Rate (%)	Detection Bandwidth (MHz)	Limit (MHz)
	1	2	3	4	5	6	7	8	9	10			
5490	1	1	1	1	1	1	1	1	1	1	100	20	17
5491	1	1	1	1	1	1	1	1	1	1	100		
5492	1	1	1	1	1	1	1	0	1	1	90		
5493	1	1	1	1	1	1	1	1	1	1	100		
5494	1	1	1	1	1	1	1	1	1	1	100		
5495	1	1	1	1	1	1	1	1	1	1	100		
5496	1	1	1	1	1	1	1	1	1	1	100		
5497	1	1	1	1	1	1	1	1	1	1	100		
5498	1	1	1	1	1	1	1	1	1	1	100		
5499	1	1	1	1	1	1	1	1	1	1	100		
5500	1	1	1	1	1	1	1	1	1	1	100		
5501	1	1	1	1	1	1	1	1	1	1	100		
5502	1	1	1	1	1	1	1	1	1	1	100		
5503	1	1	1	1	1	1	1	1	1	1	100		
5504	1	1	1	1	1	1	1	1	1	1	100		
5505	1	1	1	1	1	1	1	1	1	1	100		
5506	1	1	1	1	1	1	1	1	1	1	100		
5507	1	1	1	1	1	1	1	1	1	1	100		
5508	1	1	1	1	1	1	1	1	1	1	100		
5509	1	1	1	1	1	1	1	1	1	1	100		
5510	1	1	1	1	1	1	1	1	1	1	100		

**USA Bin 1B Radar**



Radars Frequency	DFS Detection Trials (1=Detection, Blank= No Detection)										Detection Rate (%)	Detection Bandwidth (MHz)	Limit (MHz)
	1	2	3	4	5	6	7	8	9	10			
5490	1	1	1	1	1	1	1	1	1	1	100	20	17
5491	1	1	1	1	1	1	1	1	1	1	100		
5492	1	1	1	1	1	1	1	1	1	1	100		
5493	1	1	1	1	1	1	1	1	1	1	100		
5494	1	1	1	1	1	1	1	1	1	1	100		
5495	1	1	1	1	1	1	1	1	1	1	100		
5496	1	1	1	1	1	1	1	1	1	1	100		
5497	1	1	1	1	1	1	1	1	1	1	100		
5498	1	1	1	1	1	1	1	1	1	1	100		
5499	1	1	1	1	1	1	1	1	1	1	100		
5500	1	1	1	1	1	1	1	1	1	1	100		
5501	1	1	1	1	1	1	1	1	1	1	100		
5502	1	1	1	1	1	1	1	1	1	1	100		
5503	1	1	1	1	1	1	1	1	1	1	100		
5504	1	1	1	1	1	1	1	1	1	1	100		
5505	1	1	1	1	1	1	1	1	1	1	100		
5506	1	1	1	1	1	1	1	1	1	1	100		
5507	1	1	1	1	1	1	1	1	1	1	100		
5508	1	1	1	1	1	1	1	1	1	1	100		
5509	1	1	1	1	1	1	1	1	1	1	100		
5510	1	1	1	1	1	1	1	1	1	1	100		

**USA Bin 2 Radar**



Radars Frequency	DFS Detection Trials (1=Detection, Blank= No Detection)										Detection Rate (%)	Detection Bandwidth (MHz)	Limit (MHz)
	1	2	3	4	5	6	7	8	9	10			
5490	1	0	1	0	1	1	1	1	1	1	80	18	17
5491	1	1	1	1	1	1	1	1	1	1	100		
5492	1	1	1	1	1	1	1	1	1	1	100		
5493	1	1	1	1	1	1	1	1	1	1	100		
5494	1	1	1	1	1	1	1	1	1	1	100		
5495	1	1	1	1	1	1	1	1	1	1	100		
5496	1	1	1	1	1	1	1	1	1	1	100		
5497	1	1	1	1	1	1	1	1	1	1	100		
5498	1	1	1	1	1	1	1	1	1	1	100		
5499	1	1	1	1	1	1	1	1	1	1	100		
5500	1	1	1	1	1	1	1	1	1	1	100		
5501	1	1	1	1	1	1	1	1	1	1	100		
5502	1	1	1	1	1	1	1	1	1	1	100		
5503	1	1	1	1	1	1	1	1	1	1	100		
5504	1	1	1	1	1	1	1	1	1	1	100		
5505	1	1	1	1	1	1	1	1	1	1	100		
5506	1	1	1	1	1	1	1	1	1	1	100		
5507	1	1	1	1	1	1	1	1	1	1	100		
5508	1	1	1	1	1	1	1	1	1	1	100		
5509	1	1	1	1	1	1	1	1	1	1	100		
5510	1	1	1	0	0	0	1	1	0	1	60		

**USA Bin 3 Radar**



Radars Frequency	DFS Detection Trials (1=Detection, Blank= No Detection)										Detection Rate (%)	Detection Bandwidth (MHz)	Limit (MHz)
	1	2	3	4	5	6	7	8	9	10			
5490	0	0	0	0	0	0	0	0	0	0	0	18	17
5491	1	1	1	1	1	1	1	1	1	1	100		
5492	1	1	1	1	1	1	1	1	1	1	100		
5493	1	1	1	1	1	1	1	1	1	1	100		
5494	1	1	1	1	1	1	1	1	1	1	100		
5495	1	1	1	1	1	1	1	1	1	1	100		
5496	1	1	1	1	1	1	1	1	1	1	100		
5497	1	1	1	1	1	1	1	1	1	1	100		
5498	1	1	1	1	1	1	1	1	1	1	100		
5499	1	1	1	1	1	1	1	1	1	1	100		
5500	1	1	1	1	1	1	1	1	1	1	100		
5501	1	1	1	1	1	1	1	1	1	1	100		
5502	1	1	1	1	1	1	1	1	1	1	100		
5503	1	1	1	1	1	1	1	1	1	1	100		
5504	1	1	1	1	1	1	1	1	1	1	100		
5505	1	1	1	1	1	1	1	1	1	1	100		
5506	1	1	1	1	1	1	1	1	1	1	100		
5507	1	1	1	1	1	1	1	1	1	1	100		
5508	1	1	1	1	1	1	1	1	1	1	100		
5509	1	1	1	1	1	1	1	1	1	1	100		
5510	0	0	0	0	1	0	0	0	0	0	10		

**USA Bin 4 Radar**



Radars Frequency	DFS Detection Trials (1=Detection, Blank= No Detection)										Detection Rate (%)	Detection Bandwidth (MHz)	Limit (MHz)
	1	2	3	4	5	6	7	8	9	10			
5490	1	1	1	1	1	1	1	1	1	1	100	20	17
5491	1	1	1	1	1	1	1	1	1	1	100		
5492	1	1	1	1	1	1	1	1	1	1	100		
5493	1	1	1	1	1	1	1	1	1	1	100		
5494	1	1	1	1	1	1	1	1	1	1	100		
5495	1	1	1	1	1	1	1	1	1	1	100		
5496	1	1	1	1	1	1	1	1	1	1	100		
5497	1	1	1	1	1	1	1	1	1	1	100		
5498	1	1	1	1	1	1	1	1	1	1	100		
5499	1	1	1	1	1	1	1	1	1	1	100		
5500	1	1	1	1	1	1	1	1	1	1	100		
5501	1	1	1	1	1	1	1	1	1	1	100		
5502	1	1	1	1	1	1	1	1	1	1	100		
5503	1	1	1	1	1	1	1	1	1	1	100		
5504	1	1	1	1	1	1	1	1	1	1	100		
5505	1	1	1	1	1	1	1	1	1	1	100		
5506	1	1	1	1	1	1	1	1	1	1	100		
5507	1	1	1	1	1	1	1	1	1	1	100		
5508	1	1	1	1	1	1	1	1	1	1	100		
5509	1	1	1	1	1	1	1	1	1	1	100		
5510	1	1	1	1	1	1	1	1	1	1	100		

**USA Bin 5 Radar**



Radars Frequency	DFS Detection Trials (1=Detection, Blank= No Detection)										Detection Rate (%)	Detection Bandwidth (MHz)	Limit (MHz)
	1	2	3	4	5	6	7	8	9	10			
5490	1	1	1	1	1	0	1	1	1	1	90	20	17
5491	1	1	1	1	1	1	1	0	1	1	90		
5492	1	1	1	1	1	1	1	1	1	1	100		
5493	1	1	1	1	0	1	1	1	1	1	90		
5494	1	1	1	1	1	1	1	1	1	1	100		
5495	1	1	1	1	1	1	1	1	1	1	100		
5496	1	1	1	1	1	1	1	1	1	1	100		
5497	1	1	1	1	1	1	1	1	1	1	100		
5498	1	1	1	1	1	1	1	1	1	1	100		
5499	1	1	1	1	1	1	1	1	1	1	100		
5500	1	1	1	1	1	1	1	1	1	1	100		
5501	1	1	1	1	1	1	1	1	1	1	100		
5502	1	1	1	1	1	1	1	1	1	1	100		
5503	1	1	1	1	1	1	1	1	1	1	100		
5504	0	1	1	1	1	1	1	1	1	1	90		
5505	1	1	1	1	1	1	1	1	1	1	100		
5506	1	1	1	1	1	1	1	1	1	1	100		
5507	1	1	1	1	1	1	1	1	1	1	100		
5508	1	1	1	1	1	1	1	1	1	1	100		
5509	1	0	1	1	1	1	1	1	1	1	90		
5510	1	1	1	1	1	0	1	1	1	1	90		

**USA Frequency Hopping Radar**





Radars Frequency	DFS Detection Trials (1=Detection, Blank= No Detection)										Detection Rate (%)	Detection Bandwidth (MHz)	Limit (MHz)
	1	2	3	4	5	6	7	8	9	10			
5490	1	1	1	1	1	1	1	1	1	1	100	40	36
5491	1	1	1	1	1	1	1	1	1	1	100		
5492	1	1	1	1	1	1	1	1	1	1	100		
5493	1	1	1	1	1	1	1	1	1	1	100		
5494	1	1	1	1	1	1	1	1	1	1	100		
5495	1	1	1	1	1	1	1	1	1	1	100		
5496	1	1	1	1	1	1	1	1	1	1	100		
5497	1	1	1	1	1	1	1	1	1	1	100		
5498	1	1	1	1	1	1	1	1	1	1	100		
5499	1	1	1	1	1	1	1	1	1	1	100		
5500	1	1	1	1	1	1	1	1	1	1	100		
5501	1	1	1	1	1	1	1	1	1	1	100		
5502	1	1	1	1	1	1	1	1	1	1	100		
5503	1	1	1	1	1	1	1	1	1	1	100		
5504	1	1	1	1	1	1	1	1	1	1	100		
5505	1	1	1	1	1	1	1	1	1	1	100		
5506	1	1	1	1	1	1	1	1	1	1	100		
5507	1	1	1	1	1	1	1	1	1	1	100		
5508	1	1	1	1	1	1	1	1	1	1	100		
5509	1	1	1	1	1	1	1	1	1	1	100		
5510	1	1	1	1	1	1	1	1	1	1	100		
5511	1	1	1	1	1	1	1	1	1	1	100		
5512	1	1	1	1	1	1	1	1	1	1	100		
5513	1	1	1	1	1	1	1	1	1	1	100		
5514	1	1	1	1	1	1	1	1	1	1	100		
5515	1	1	1	1	1	1	1	1	1	1	100		
5516	1	1	1	1	1	1	1	1	1	1	100		
5517	1	1	1	1	1	1	1	1	1	1	100		
5518	1	1	1	1	1	1	1	1	1	1	100		
5519	1	1	1	1	1	1	1	1	1	1	100		
5520	1	1	1	1	1	1	1	1	1	1	100		
5521	1	1	1	1	1	1	1	1	1	1	100		
5522	1	1	1	1	1	1	1	1	1	1	100		
5523	1	1	1	1	1	1	1	1	1	1	100		
5524	1	1	1	1	1	1	1	1	1	1	100		
5525	1	1	1	1	1	1	1	1	1	1	100		
5526	1	1	1	1	1	1	1	1	1	1	100		
5527	1	1	1	1	1	1	1	1	1	1	100		
5528	1	1	1	1	1	1	1	1	1	1	100		
5529	1	1	1	1	1	1	1	1	1	1	100		
5530	1	1	1	1	1	1	1	1	1	1	100		

**USA Bin 0 Radar**



Radars Frequency	DFS Detection Trials (1=Detection, Blank= No Detection)										Detection Rate (%)	Detection Bandwidth (MHz)	Limit (MHz)
	1	2	3	4	5	6	7	8	9	10			
5490	1	1	1	1	1	1	1	1	1	1	100	40	36
5491	1	1	1	1	1	1	1	1	1	1	100		
5492	1	1	1	1	1	1	1	1	1	1	100		
5493	1	1	1	1	1	1	1	1	1	1	100		
5494	1	1	1	1	1	1	1	1	1	1	100		
5495	1	1	1	1	1	1	1	1	1	1	100		
5496	1	1	1	1	1	1	1	1	1	1	100		
5497	1	1	1	1	1	1	1	1	1	1	100		
5498	1	1	1	1	1	1	1	1	1	1	100		
5499	1	1	1	1	1	1	1	1	1	1	100		
5500	1	1	1	1	1	1	1	1	1	1	100		
5501	1	1	1	1	1	1	1	1	1	1	100		
5502	1	1	1	1	1	1	1	1	1	1	100		
5503	1	1	1	1	1	1	1	1	1	1	100		
5504	1	1	1	1	1	1	1	1	1	1	100		
5505	1	1	1	1	1	1	1	1	1	1	100		
5506	1	1	1	1	1	1	1	1	1	1	100		
5507	1	1	1	1	1	1	1	1	1	1	100		
5508	1	1	1	1	1	1	1	1	1	1	100		
5509	1	1	1	1	1	1	1	1	1	1	100		
5510	1	1	1	1	1	1	1	1	1	1	100		
5511	1	1	1	1	1	1	1	1	1	1	100		
5512	1	1	1	1	1	1	1	1	1	1	100		
5513	1	1	1	1	1	1	1	1	1	1	100		
5514	1	1	1	1	1	1	1	1	1	1	100		
5515	1	1	1	1	1	1	1	1	1	1	100		
5516	1	1	1	1	1	1	1	1	1	1	100		
5517	1	1	1	1	1	1	1	1	1	1	100		
5518	1	1	1	1	1	1	1	1	1	1	100		
5519	1	1	1	1	1	1	1	1	1	1	100		
5520	1	1	1	1	1	1	1	1	1	1	100		
5521	1	1	1	1	1	1	1	1	1	1	100		
5522	1	1	1	1	1	1	1	1	1	1	100		
5523	1	1	1	1	1	1	1	1	1	1	100		
5524	1	1	1	1	1	1	1	1	1	1	100		
5525	1	1	1	1	1	1	1	1	1	1	100		
5526	1	1	1	1	1	1	1	1	1	1	100		
5527	1	1	1	1	1	1	1	1	1	1	100		
5528	1	1	1	1	1	1	1	1	1	1	100		
5529	1	1	1	1	1	1	1	1	1	1	100		
5530	1	1	1	1	1	1	1	1	1	1	100		

USA Bin 1A Radar



Radars Frequency	DFS Detection Trials (1=Detection, Blank= No Detection)										Detection Rate (%)	Detection Bandwidth (MHz)	Limit (MHz)
	1	2	3	4	5	6	7	8	9	10			
5490	1	1	1	1	1	1	1	1	1	1	100	40	36
5491	1	1	1	1	1	1	1	1	1	1	100		
5492	1	1	1	1	1	1	1	1	1	1	100		
5493	1	1	1	1	1	1	1	1	1	1	100		
5494	1	1	1	1	1	1	1	1	1	1	100		
5495	1	1	1	1	1	1	1	1	1	1	100		
5496	1	1	1	1	1	1	1	1	1	1	100		
5497	1	1	1	1	1	1	1	1	1	1	100		
5498	1	1	1	1	1	1	1	1	1	1	100		
5499	1	1	1	1	1	1	1	1	1	1	100		
5500	1	1	1	1	1	1	1	1	1	1	100		
5501	1	1	1	1	1	1	1	1	1	1	100		
5502	1	1	1	1	1	1	1	1	1	1	100		
5503	1	1	1	1	1	1	1	1	1	1	100		
5504	1	1	1	1	1	1	1	1	1	1	100		
5505	1	1	1	1	1	1	1	1	1	1	100		
5506	1	1	1	1	1	1	1	1	1	1	100		
5507	1	1	1	1	1	1	1	1	1	1	100		
5508	1	1	1	1	1	1	1	1	1	1	100		
5509	1	1	1	1	1	1	1	1	1	1	100		
5510	1	1	1	1	1	1	1	1	1	1	100		
5511	1	1	1	1	1	1	1	1	1	1	100		
5512	1	1	1	1	1	1	1	1	1	1	100		
5513	1	1	1	1	1	1	1	1	1	1	100		
5514	1	1	1	1	1	1	1	1	1	1	100		
5515	1	1	1	1	1	1	1	1	1	1	100		
5516	1	1	1	1	1	1	1	1	1	1	100		
5517	1	1	1	1	1	1	1	1	1	1	100		
5518	1	1	1	1	1	1	1	1	1	1	100		
5519	1	1	1	1	1	1	1	1	1	1	100		
5520	1	1	1	1	1	1	1	1	1	1	100		
5521	1	1	1	1	1	1	1	1	1	1	100		
5522	1	1	1	1	1	1	1	1	1	1	100		
5523	1	1	1	1	1	1	1	1	1	1	100		
5524	1	1	1	1	1	1	1	1	1	1	100		
5525	1	1	1	1	1	1	1	1	1	1	100		
5526	1	1	1	1	1	1	1	1	1	1	100		
5527	1	1	1	1	1	1	1	1	1	1	100		
5528	1	1	1	1	1	1	1	1	1	1	100		
5529	1	1	1	1	1	1	1	1	1	1	100		
5530	1	1	1	1	1	1	1	1	1	1	100		

**USA Bin 1B Radar**



Radar Frequency	DFS Detection Trials (1=Detection, Blank= No Detection)										Detection Rate (%)	Detection Bandwidth (MHz)	Limit (MHz)
	1	2	3	4	5	6	7	8	9	10			
5490	1	1	1	1	1	1	1	1	1	1	100	40	36
5491	1	1	1	1	1	1	1	1	1	1	100		
5492	1	1	1	1	1	1	1	1	1	1	100		
5493	1	1	1	1	1	1	1	1	1	1	100		
5494	1	1	0	1	1	1	1	1	1	1	90		
5495	1	1	1	1	1	1	1	1	1	1	100		
5496	1	1	1	1	1	1	1	1	1	1	100		
5497	1	1	1	1	1	1	1	1	1	1	100		
5498	1	1	1	1	1	1	1	1	1	1	100		
5499	1	1	1	1	1	1	1	1	1	1	100		
5500	1	1	1	1	1	1	1	1	1	1	100		
5501	1	1	1	1	1	1	1	1	1	1	100		
5502	1	1	1	1	1	1	1	1	1	1	100		
5503	1	1	1	1	1	1	1	1	1	1	100		
5504	1	1	1	1	1	1	1	1	1	1	100		
5505	1	1	1	1	1	1	1	1	1	1	100		
5506	1	1	1	1	1	1	1	1	1	1	100		
5507	1	1	1	1	1	1	1	1	1	1	100		
5508	1	1	1	1	1	1	1	1	1	1	100		
5509	1	1	1	1	1	1	1	1	1	1	100		
5510	1	1	1	1	1	1	1	1	1	1	100		
5511	1	1	1	1	1	1	1	1	1	1	100		
5512	1	1	1	1	1	1	1	1	1	1	100		
5513	1	1	1	1	1	1	1	1	1	1	100		
5514	1	1	1	1	1	1	1	1	1	1	100		
5515	1	1	1	1	1	1	1	1	1	1	100		
5516	1	1	1	1	1	1	1	1	1	1	100		
5517	1	1	1	1	1	1	1	1	1	1	100		
5518	1	1	1	1	1	1	1	1	1	1	100		
5519	1	1	1	1	1	1	1	1	1	1	100		
5520	1	1	1	1	1	1	1	1	1	1	100		
5521	1	1	1	1	1	1	1	1	1	1	100		
5522	1	1	1	1	1	1	1	1	1	1	100		
5523	1	1	1	1	1	1	1	1	1	1	100		
5524	1	1	1	1	1	1	1	1	1	1	100		
5525	1	1	1	1	1	1	1	1	1	1	100		
5526	1	1	1	1	1	1	1	1	1	1	100		
5527	1	1	1	1	1	1	1	1	1	1	100		
5528	1	1	1	1	1	1	1	1	1	1	100		
5529	1	1	1	1	1	1	1	1	1	1	100		
5530	1	1	1	1	1	1	1	1	1	1	100		

**USA Bin 2 Radar**



Radars Frequency	DFS Detection Trials (1=Detection, Blank= No Detection)										Detection Rate (%)	Detection Bandwidth (MHz)	Limit (MHz)
	1	2	3	4	5	6	7	8	9	10			
5490	0	1	0	0	0	0	0	0	0	1	20	38	36
5491	1	1	1	1	1	1	1	1	1	1	100		
5492	1	1	1	1	1	1	1	1	1	1	100		
5493	1	1	1	1	1	1	1	1	1	1	100		
5494	1	1	1	1	1	1	1	1	1	1	100		
5495	1	1	1	1	1	1	1	1	1	1	100		
5496	1	1	1	1	1	1	1	1	1	1	100		
5497	1	1	1	1	1	1	1	1	1	1	100		
5498	1	1	1	1	1	1	1	1	1	1	100		
5499	1	1	1	1	1	1	1	1	1	1	100		
5500	1	1	1	1	1	1	1	1	1	1	100		
5501	1	1	1	1	1	1	1	1	1	1	100		
5502	1	1	1	1	1	1	1	1	1	1	100		
5503	1	1	1	1	1	1	1	1	1	1	100		
5504	1	1	1	1	1	1	1	1	1	1	100		
5505	1	1	1	1	1	1	1	1	1	1	100		
5506	1	1	1	1	1	1	1	1	1	1	100		
5507	1	1	1	1	1	1	1	1	1	1	100		
5508	1	1	1	1	1	1	1	1	1	1	100		
5509	1	1	1	1	1	1	1	1	1	1	100		
5510	1	1	1	1	1	1	1	1	1	1	100		
5511	1	1	1	1	1	1	1	1	1	1	100		
5512	1	1	1	1	1	1	1	1	1	1	100		
5513	1	1	1	1	1	1	1	1	1	1	100		
5514	1	1	1	1	1	1	1	1	1	1	100		
5515	1	1	1	1	1	1	1	1	1	1	100		
5516	1	1	1	1	1	1	1	1	1	1	100		
5517	1	1	1	1	1	1	1	1	1	1	100		
5518	1	1	1	1	1	1	1	1	1	1	100		
5519	1	1	1	1	1	1	1	1	1	1	100		
5520	1	1	1	1	1	1	1	1	1	1	100		
5521	1	1	1	1	1	1	1	1	1	1	100		
5522	1	1	1	1	1	1	1	1	1	1	100		
5523	1	1	1	1	1	1	1	1	1	1	100		
5524	1	1	1	1	1	1	1	1	1	1	100		
5525	1	1	1	1	1	1	1	1	1	1	100		
5526	1	1	1	1	1	1	1	1	1	1	100		
5527	1	1	1	1	1	1	1	1	1	1	100		
5528	1	1	1	1	1	1	1	1	1	1	100		
5529	1	1	1	1	1	1	1	1	1	1	100		
5530	0	0	0	0	0	0	1	0	0	1	20		

**USA Bin 3 Radar**



Radars Frequency	DFS Detection Trials (1=Detection, Blank= No Detection)										Detection Rate (%)	Detection Bandwidth (MHz)	Limit (MHz)
	1	2	3	4	5	6	7	8	9	10			
5490	0	0	0	0	0	0	0	0	0	0	0	38	36
5491	1	1	1	1	1	1	1	1	1	1	100		
5492	1	1	1	1	1	1	1	1	1	1	100		
5493	1	1	1	1	1	1	1	1	1	1	100		
5494	1	1	1	1	1	1	1	1	1	1	100		
5495	1	1	1	1	1	1	1	1	1	1	100		
5496	1	1	1	1	1	1	1	1	1	1	100		
5497	1	1	1	1	1	1	1	1	1	1	100		
5498	1	1	1	1	1	1	1	1	1	1	100		
5499	1	1	1	1	1	1	1	1	1	1	100		
5500	1	1	1	1	1	1	1	1	1	1	100		
5501	1	1	1	1	1	1	1	1	1	1	100		
5502	1	1	1	1	1	1	1	1	1	1	100		
5503	1	1	1	1	1	1	1	1	1	1	100		
5504	1	1	1	1	1	1	1	1	1	1	100		
5505	1	1	1	1	1	1	1	1	1	1	100		
5506	1	1	1	1	1	1	1	1	1	1	100		
5507	1	1	1	1	1	1	1	1	1	1	100		
5508	1	1	1	1	1	1	1	1	1	1	100		
5509	1	1	1	1	1	1	1	1	1	1	100		
5510	1	1	1	1	1	1	1	1	1	1	100		
5511	1	1	1	1	1	1	1	1	1	1	100		
5512	1	1	1	1	1	1	1	1	1	1	100		
5513	1	1	1	1	1	1	1	1	1	1	100		
5514	1	1	1	1	1	1	1	1	1	1	100		
5515	1	1	1	1	1	1	1	1	1	1	100		
5516	1	1	1	1	1	1	1	1	1	1	100		
5517	1	1	1	1	1	1	1	1	1	1	100		
5518	1	1	1	1	1	1	1	1	1	1	100		
5519	1	1	1	1	1	1	1	1	1	1	100		
5520	1	1	1	1	1	1	1	1	1	1	100		
5521	1	1	1	1	1	1	1	1	1	1	100		
5522	1	1	1	1	1	1	1	1	1	1	100		
5523	1	1	1	1	1	1	1	1	1	1	100		
5524	1	1	1	1	1	1	1	1	1	1	100		
5525	1	1	1	1	1	1	1	1	1	1	100		
5526	1	1	1	1	1	1	1	1	1	1	100		
5527	1	1	1	1	1	1	1	1	1	1	100		
5528	1	1	1	1	1	1	1	1	1	1	100		
5529	1	1	1	1	1	1	1	1	1	1	100		
5530	0	0	0	0	0	0	0	0	0	0	0		

**USA Bin 4 Radar**



Radars Frequency	DFS Detection Trials (1=Detection, Blank= No Detection)										Detection Rate (%)	Detection Bandwidth (MHz)	Limit (MHz)
	1	2	3	4	5	6	7	8	9	10			
5490	1	1	1	1	1	1	1	1	1	1	100	40	36
5491	1	1	1	1	1	1	1	1	1	1	100		
5492	1	1	1	1	1	1	1	1	1	1	100		
5493	1	1	1	1	1	1	1	1	1	1	100		
5494	1	1	1	1	1	1	1	1	1	1	100		
5495	1	1	1	1	1	1	1	1	1	1	100		
5496	1	1	1	1	1	1	1	1	1	1	100		
5497	1	1	1	1	1	1	1	1	1	1	100		
5498	1	1	1	1	1	1	1	1	1	1	100		
5499	1	1	1	1	1	1	1	1	1	1	100		
5500	1	1	1	1	1	1	1	1	1	1	100		
5501	1	1	1	1	1	1	1	1	1	1	100		
5502	1	1	1	1	1	1	1	1	1	1	100		
5503	1	1	1	1	1	1	1	1	1	1	100		
5504	1	1	1	1	1	1	1	1	1	1	100		
5505	1	1	1	1	1	1	1	1	1	1	100		
5506	1	1	1	1	1	1	1	1	1	1	100		
5507	1	1	1	1	1	1	1	1	1	1	100		
5508	1	1	1	1	1	1	1	1	1	1	100		
5509	1	1	1	1	1	1	1	1	1	1	100		
5510	1	1	1	1	1	1	1	1	1	1	100		
5511	1	1	1	1	1	1	1	1	1	1	100		
5512	1	1	1	1	1	1	1	1	1	1	100		
5513	1	1	1	1	1	1	1	1	1	1	100		
5514	1	1	1	1	1	1	1	1	1	1	100		
5515	1	1	1	1	1	1	1	1	1	1	100		
5516	1	1	1	1	1	1	1	1	1	1	100		
5517	1	1	1	1	1	1	1	1	1	1	100		
5518	1	1	1	1	1	1	1	1	1	1	100		
5519	1	1	1	1	1	1	1	1	1	1	100		
5520	1	1	1	1	1	1	1	1	1	1	100		
5521	1	1	1	1	1	1	1	1	1	1	100		
5522	1	1	1	1	1	1	1	1	1	1	100		
5523	1	1	1	1	1	1	1	1	1	1	100		
5524	1	1	1	1	1	1	1	1	1	1	100		
5525	1	1	1	1	1	1	1	1	1	1	100		
5526	1	1	1	1	1	1	1	1	1	1	100		
5527	1	1	1	1	1	1	1	1	1	1	100		
5528	1	1	1	1	1	1	1	1	1	1	100		
5529	1	1	1	1	1	1	1	1	1	1	100		
5530	1	1	1	1	1	1	1	1	1	1	100		

**USA Bin 5 Radar**



Radar Frequency	DFS Detection Trials (1=Detection, Blank= No Detection)										Detection Rate (%)	Detection Bandwidth (MHz)	Limit (MHz)
	1	2	3	4	5	6	7	8	9	10			
5490	1	1	1	1	1	1	1	1	1	1	100	40	36
5491	1	1	1	1	1	1	1	1	1	1	100		
5492	1	1	1	1	1	1	1	1	1	1	100		
5493	1	1	1	1	1	1	1	1	1	1	100		
5494	1	1	1	0	1	1	1	1	1	1	90		
5495	1	1	1	1	1	1	1	1	1	1	100		
5496	1	1	1	1	1	1	1	1	1	1	100		
5497	1	1	1	1	1	1	1	1	1	1	100		
5498	1	1	1	1	1	1	1	1	1	1	100		
5499	1	1	1	1	1	1	1	1	1	1	100		
5500	1	1	1	1	1	1	1	1	1	1	100		
5501	1	1	1	1	1	1	1	1	1	1	100		
5502	1	1	1	1	1	1	1	1	1	1	100		
5503	1	1	1	1	1	1	1	1	1	1	100		
5504	1	1	1	1	1	1	1	1	1	1	100		
5505	1	1	1	1	1	1	1	1	1	1	100		
5506	1	1	1	1	1	1	1	1	1	1	100		
5507	1	1	1	1	1	1	1	1	1	1	100		
5508	1	1	1	1	1	1	1	1	1	1	100		
5509	1	1	1	1	1	1	1	1	1	1	100		
5510	1	1	1	1	1	1	1	1	1	1	100		
5511	1	1	1	1	1	1	1	1	1	1	100		
5512	1	1	1	1	1	1	1	1	1	1	100		
5513	1	1	1	1	1	1	1	1	1	1	100		
5514	1	1	1	1	1	1	1	1	1	1	100		
5515	1	1	1	1	1	1	1	1	1	1	100		
5516	1	1	1	1	1	1	1	1	1	1	100		
5517	1	1	1	1	1	1	1	1	1	1	100		
5518	1	1	1	1	1	1	1	1	1	1	100		
5519	1	1	1	1	1	1	1	1	1	1	100		
5520	1	1	1	1	1	1	1	1	1	1	100		
5521	1	1	1	1	1	1	1	1	1	1	100		
5522	1	1	1	1	1	1	1	1	1	1	100		
5523	1	1	1	1	1	1	1	1	1	1	100		
5524	1	1	1	1	1	1	1	1	1	1	100		
5525	1	1	1	1	1	1	1	1	1	1	100		
5526	1	1	1	1	1	1	1	1	1	1	100		
5527	1	1	1	1	1	1	1	1	1	1	100		
5528	1	1	1	1	1	1	1	1	1	1	100		
5529	1	1	1	1	1	1	1	1	1	1	100		
5530	1	1	1	1	1	1	1	1	1	1	100		

**USA Frequency Hopping Radar**





Radars Frequency	DFS Detection Trials (1=Detection, Blank= No Detection)										Detection Rate (%)	Detection Bandwidth (MHz)	Limit (MHz)
	1	2	3	4	5	6	7	8	9	10			
5490	0	1	0	0	0	1	1	0	1	1	50	78	76
5491	1	1	1	1	1	1	1	1	1	1	100		
5492	1	1	1	1	1	1	1	1	1	1	100		
5493	1	1	1	1	1	1	1	1	1	1	100		
5494	1	1	1	1	1	1	1	1	1	1	100		
5495	1	1	1	1	1	1	1	1	1	1	100		
5496	1	1	1	1	1	1	1	1	1	1	100		
5497	1	1	1	1	1	1	1	1	1	1	100		
5498	1	1	1	1	1	0	1	1	1	1	90		
5499	1	1	1	1	1	1	1	1	1	1	100		
5500	1	1	1	1	1	1	1	1	1	1	100		
5501	1	1	1	1	1	1	1	1	1	1	100		
5502	1	1	1	1	1	1	1	1	1	1	100		
5503	1	1	1	1	1	1	1	1	1	1	100		
5504	1	1	1	1	1	1	1	1	1	1	100		
5505	1	1	1	1	1	1	1	1	1	1	100		
5506	1	1	1	1	1	1	1	1	1	1	100		
5507	1	1	1	1	1	1	1	1	1	1	100		
5508	1	1	1	1	1	1	1	1	1	1	100		
5509	1	1	1	1	1	1	1	1	1	1	100		
5510	1	1	1	1	1	1	1	1	1	1	100		
5511	1	1	1	1	1	1	1	1	1	1	100		
5512	1	1	1	1	1	1	1	1	1	1	100		
5513	1	1	1	1	1	1	1	1	1	1	100		
5514	1	1	1	1	1	1	1	1	1	1	100		
5515	1	1	1	1	1	1	1	1	1	1	100		
5516	1	1	1	1	1	1	1	1	1	1	100		
5517	1	1	1	1	1	1	1	1	1	1	100		
5518	1	1	1	1	1	1	1	1	1	1	100		
5519	1	1	1	1	1	1	1	1	1	1	100		
5520	1	1	1	1	1	1	1	1	1	1	100		
5521	1	1	1	1	1	1	1	1	1	1	100		
5522	1	1	1	1	1	1	1	1	1	1	100		
5523	1	1	1	1	1	1	1	1	1	1	100		
5524	1	1	1	1	1	1	1	1	1	1	100		
5525	1	1	1	1	1	1	1	1	1	1	100		
5526	1	1	1	1	1	1	1	1	1	1	100		
5527	1	1	1	1	1	1	1	1	1	1	100		
5528	1	1	1	1	1	1	1	1	1	1	100		
5529	1	1	1	1	1	1	1	1	1	1	100		

USA Bin 0 Radar



Radars Frequency	DFS Detection Trials (1=Detection, Blank= No Detection)										Detection Rate (%)	Detection Bandwidth (MHz)	Limit (MHz)
	1	2	3	4	5	6	7	8	9	10			
5530	1	1	1	1	1	1	1	1	1	1	100	78	76
5531	1	1	1	1	1	1	1	1	1	1	100		
5532	1	1	1	1	1	1	1	1	1	1	100		
5533	1	1	1	1	1	1	1	1	1	1	100		
5534	1	1	1	1	1	1	1	1	1	1	100		
5535	1	1	1	1	1	1	1	1	1	1	100		
5536	1	1	1	1	1	1	1	1	1	1	100		
5537	1	1	1	1	1	1	1	1	1	1	100		
5538	1	1	1	1	1	1	1	1	1	1	100		
5539	1	1	1	1	1	1	1	1	1	1	100		
5540	1	1	1	1	1	1	1	1	1	1	100		
5541	1	1	1	1	1	1	1	1	1	1	100		
5542	1	1	1	1	1	1	1	1	1	1	100		
5543	1	1	1	1	1	1	1	1	1	1	100		
5544	1	1	1	1	1	1	1	1	1	1	100		
5545	1	1	1	1	1	1	1	1	1	1	100		
5546	1	1	1	1	1	1	1	1	1	1	100		
5547	1	1	1	1	1	1	1	1	1	1	100		
5548	1	1	1	1	1	1	1	1	1	1	100		
5549	1	1	1	1	1	1	1	1	1	1	100		
5550	1	1	1	1	1	1	1	1	1	1	100		
5551	1	1	1	1	1	1	1	1	1	1	100		
5552	1	1	1	1	1	1	1	1	1	1	100		
5553	1	1	1	1	1	1	1	1	1	1	100		
5554	1	1	1	1	1	1	1	1	1	1	100		
5555	1	1	1	1	1	1	1	1	1	1	100		
5556	1	1	1	1	1	1	1	1	1	1	100		
5557	1	1	1	1	1	1	1	1	1	1	100		
5558	1	1	1	1	1	1	1	1	1	1	100		
5559	1	1	1	1	1	1	1	1	1	1	100		
5560	1	1	1	1	1	1	1	1	1	1	100		
5561	1	1	1	1	1	1	1	1	1	1	100		
5562	1	1	1	1	1	1	1	1	1	1	100		
5563	1	1	1	1	1	1	1	1	1	1	100		
5564	1	1	1	1	1	1	1	1	1	1	100		
5565	1	1	1	1	1	1	1	1	1	1	100		
5566	1	1	1	1	1	1	1	1	1	1	100		
5567	1	1	1	1	1	1	1	1	1	1	100		
5568	1	1	1	1	1	1	1	1	1	1	100		
5569	1	1	1	1	1	1	1	1	1	1	100		
5570	1	0	0	1	1	1	0	1	1	0	60		

**USA Bin 0 Radar (cont)**



Radars Frequency	DFS Detection Trials (1=Detection, Blank= No Detection)										Detection Rate (%)	Detection Bandwidth (MHz)	Limit (MHz)
	1	2	3	4	5	6	7	8	9	10			
5490	1	1	0	1	1	1	1	1	0	1	80	78	76
5491	1	1	1	1	1	1	1	1	1	1	100		
5492	1	1	1	1	1	1	1	1	1	1	100		
5493	1	1	1	1	1	1	1	1	1	1	100		
5494	1	1	1	1	1	1	1	1	1	1	100		
5495	1	1	1	1	1	1	1	1	1	1	100		
5496	1	1	1	1	1	1	1	1	1	1	100		
5497	1	1	1	1	1	1	1	1	1	1	100		
5498	0	1	1	1	1	1	1	1	1	1	90		
5499	1	1	1	1	1	1	1	1	1	1	100		
5500	1	1	1	1	1	1	1	1	1	1	100		
5501	1	1	1	1	1	1	1	1	1	1	100		
5502	1	1	1	1	1	1	1	1	1	1	100		
5503	1	1	1	1	1	1	1	1	1	1	100		
5504	1	1	1	1	1	1	1	1	1	1	100		
5505	1	1	1	1	1	1	1	1	1	1	100		
5506	1	1	1	1	1	1	1	1	1	1	100		
5507	1	1	1	1	1	1	1	1	1	1	100		
5508	1	1	1	1	1	1	1	1	1	1	100		
5509	1	1	1	1	1	1	1	1	1	1	100		
5510	1	1	1	1	1	1	1	1	1	1	100		
5511	1	1	1	1	1	1	1	1	1	1	100		
5512	1	1	1	1	1	1	1	1	1	1	100		
5513	1	1	1	1	1	1	1	1	1	1	100		
5514	1	1	1	1	1	1	1	1	1	1	100		
5515	1	1	1	1	1	1	1	1	1	1	100		
5516	1	1	1	1	1	1	1	1	1	1	100		
5517	1	1	1	1	1	1	1	1	1	1	100		
5518	1	1	1	1	1	1	1	1	1	1	100		
5519	1	1	1	1	1	1	1	1	1	1	100		
5520	1	1	1	1	1	1	1	1	1	1	100		
5521	1	1	1	1	1	1	1	1	1	1	100		
5522	1	1	1	1	1	1	1	1	1	1	100		
5523	1	1	1	1	1	1	1	1	1	1	100		
5524	1	1	1	1	1	1	1	1	1	1	100		
5525	1	1	1	1	1	1	1	1	1	1	100		
5526	1	1	1	1	1	1	1	1	1	1	100		
5527	1	1	1	1	1	1	1	1	1	1	100		
5528	1	1	1	1	1	1	1	1	1	1	100		
5529	1	1	1	1	1	1	1	1	1	1	100		

**USA Bin 1A Radar**



Radars Frequency	DFS Detection Trials (1=Detection, Blank= No Detection)										Detection Rate (%)	Detection Bandwidth (MHz)	Limit (MHz)
	1	2	3	4	5	6	7	8	9	10			
5530	1	1	1	1	1	1	1	1	1	1	100	78	76
5531	1	1	1	1	1	1	1	1	1	1	100		
5532	1	1	1	1	1	1	1	1	1	1	100		
5533	1	1	1	1	1	1	1	1	1	1	100		
5534	1	1	1	1	1	1	1	1	1	1	100		
5535	1	1	1	1	1	1	1	1	1	1	100		
5536	1	1	1	1	1	1	1	1	1	1	100		
5537	1	1	1	1	1	1	1	1	1	1	100		
5538	1	1	1	1	1	1	1	1	1	1	100		
5539	1	1	1	1	1	1	1	1	1	1	100		
5540	1	1	1	1	1	1	1	1	1	1	100		
5541	1	1	1	1	1	1	1	1	1	1	100		
5542	1	1	1	1	1	1	1	1	1	1	100		
5543	1	1	1	1	1	1	1	1	1	1	100		
5544	1	1	1	1	1	1	1	1	1	1	100		
5545	1	1	1	1	1	1	1	1	1	1	100		
5546	1	1	1	1	1	1	1	1	1	1	100		
5547	1	1	1	1	1	1	1	1	1	1	100		
5548	1	1	1	1	1	1	1	1	1	1	100		
5549	1	1	1	1	1	1	1	1	1	1	100		
5550	1	1	1	1	1	1	1	1	1	1	100		
5551	1	1	1	1	1	1	1	1	1	1	100		
5552	1	1	1	1	1	1	1	1	1	1	100		
5553	1	1	1	1	1	1	1	1	1	1	100		
5554	1	1	1	1	1	1	1	1	1	1	100		
5555	1	1	1	1	1	1	1	1	1	1	100		
5556	1	1	1	1	1	1	1	1	1	1	100		
5557	1	1	1	1	1	1	1	1	1	1	100		
5558	1	1	1	1	1	1	1	1	1	1	100		
5559	1	1	1	1	1	1	1	1	1	1	100		
5560	1	1	1	1	1	1	1	1	1	1	100		
5561	1	1	1	1	1	1	1	1	1	1	100		
5562	1	1	1	1	1	1	1	1	1	1	100		
5563	1	1	1	1	1	1	1	1	1	1	100		
5564	1	1	1	1	1	1	1	1	1	1	100		
5565	1	1	1	1	1	1	1	1	1	1	100		
5566	1	1	1	1	1	1	1	1	1	1	100		
5567	1	1	1	1	1	1	1	1	1	1	100		
5568	1	1	1	1	1	1	1	1	1	1	100		
5569	1	1	1	1	1	1	1	1	1	1	100		
5570	0	0	1	1	0	1	1	1	1	0	60		

**USA Bin 1A Radar (cont)**



Radar Frequency	DFS Detection Trials (1=Detection, Blank= No Detection)										Detection Rate (%)	Detection Bandwidth (MHz)	Limit (MHz)
	1	2	3	4	5	6	7	8	9	10			
5490	1	1	1	0	1	1	1	1	1	0	80	78	76
5491	1	1	1	1	1	1	1	1	1	1	100		
5492	1	1	1	1	1	1	1	1	1	1	100		
5493	1	1	1	1	1	1	1	1	1	1	100		
5494	1	1	1	1	1	1	1	1	1	1	100		
5495	1	1	1	1	1	1	1	1	1	1	100		
5496	1	1	1	1	1	1	1	1	1	1	100		
5497	1	1	1	1	1	1	1	1	1	1	100		
5498	1	1	1	1	1	1	1	1	1	1	100		
5499	1	1	1	1	1	1	1	1	1	1	100		
5500	1	1	1	1	1	1	1	1	1	1	100		
5501	1	1	1	1	1	1	1	1	1	1	100		
5502	1	1	1	1	1	1	1	1	1	1	100		
5503	1	1	1	1	1	1	1	1	1	1	100		
5504	1	1	1	1	1	1	1	1	1	1	100		
5505	1	1	1	1	1	1	1	1	1	1	100		
5506	1	1	1	1	1	1	1	1	1	1	100		
5507	1	1	1	1	1	1	1	1	1	1	100		
5508	1	1	1	1	1	1	1	1	1	1	100		
5509	1	1	1	1	1	1	1	1	1	1	100		
5510	1	1	1	1	1	1	1	1	1	1	100		
5511	1	1	1	1	1	1	1	1	1	1	100		
5512	1	1	1	1	1	1	1	1	1	1	100		
5513	1	1	1	1	1	1	1	1	1	1	100		
5514	1	1	1	1	1	1	1	1	1	1	100		
5515	1	1	1	1	1	1	1	1	1	1	100		
5516	1	1	1	1	1	1	1	1	1	1	100		
5517	1	1	1	1	1	1	1	1	1	1	100		
5518	1	1	1	1	1	1	1	1	1	1	100		
5519	1	1	1	1	1	1	1	1	1	1	100		
5520	1	1	1	1	1	1	1	1	1	1	100		
5521	1	1	1	1	1	1	1	1	1	1	100		
5522	1	1	1	1	1	1	1	1	1	1	100		
5523	1	1	1	1	1	1	1	1	1	1	100		
5524	1	1	1	1	1	1	1	1	1	1	100		
5525	1	1	1	1	1	1	1	1	1	1	100		
5526	1	1	1	1	1	1	1	1	1	1	100		
5527	1	1	1	1	1	1	1	1	1	1	100		
5528	1	1	1	1	1	1	1	1	1	1	100		
5529	1	1	1	1	1	1	1	1	1	1	100		

**USA Bin 1B Radar**



Radars Frequency	DFS Detection Trials (1=Detection, Blank= No Detection)										Detection Rate (%)	Detection Bandwidth (MHz)	Limit (MHz)
	1	2	3	4	5	6	7	8	9	10			
5530	1	1	1	1	1	1	1	1	1	1	100	78	76
5531	1	1	1	1	1	1	1	1	1	1	100		
5532	1	1	1	1	1	1	1	1	1	1	100		
5533	1	1	1	1	1	1	1	1	1	1	100		
5534	1	1	1	1	1	1	1	1	1	1	100		
5535	1	1	1	1	1	1	1	1	1	1	100		
5536	1	1	1	1	1	1	1	1	1	1	100		
5537	1	1	1	1	1	1	1	1	1	1	100		
5538	1	1	1	1	1	1	1	1	1	1	100		
5539	1	1	1	1	1	1	1	1	1	1	100		
5540	1	1	1	1	1	1	1	1	1	1	100		
5541	1	1	1	1	1	1	1	1	1	1	100		
5542	1	1	1	1	1	1	1	1	1	1	100		
5543	1	1	1	1	1	1	1	1	1	1	100		
5544	1	1	1	1	1	1	1	1	1	1	100		
5545	1	1	1	1	1	1	1	1	1	1	100		
5546	1	1	1	1	1	1	1	1	1	1	100		
5547	1	1	1	1	1	1	1	1	1	1	100		
5548	1	1	1	1	1	1	1	1	1	1	100		
5549	1	1	1	1	1	1	1	1	1	1	100		
5550	1	1	1	1	1	1	1	1	1	1	100		
5551	1	1	1	1	1	1	1	1	1	1	100		
5552	1	1	1	1	1	1	1	1	1	1	100		
5553	1	1	1	1	1	1	1	1	1	1	100		
5554	1	1	1	1	1	1	1	1	1	1	100		
5555	1	1	1	1	1	1	1	1	1	1	100		
5556	1	1	1	1	1	1	1	1	1	1	100		
5557	1	1	1	1	1	1	1	1	1	1	100		
5558	1	1	1	1	1	1	1	1	1	1	100		
5559	1	1	1	1	1	1	1	1	1	1	100		
5560	1	1	1	1	1	1	1	1	1	1	100		
5561	1	1	1	1	1	1	1	1	1	1	100		
5562	1	1	1	1	1	1	1	1	1	1	100		
5563	1	1	1	1	1	1	1	1	1	1	100		
5564	1	1	1	1	1	1	1	1	1	1	100		
5565	1	1	1	1	1	1	1	1	1	1	100		
5566	1	1	1	1	1	1	1	1	1	1	100		
5567	1	1	1	1	1	1	1	1	1	1	100		
5568	1	1	1	1	1	1	1	1	1	1	100		
5569	1	1	1	1	1	1	1	1	1	1	100		
5570	1	1	0	1	0	1	0	1	1	0	60		

USA Bin 1B Radar (cont)



Radars Frequency	DFS Detection Trials (1=Detection, Blank= No Detection)										Detection Rate (%)	Detection Bandwidth (MHz)	Limit (MHz)
	1	2	3	4	5	6	7	8	9	10			
5490	0	0	1	1	1	0	1	0	1	0	50	78	76
5491	1	1	1	1	1	1	1	1	1	1	100		
5492	1	1	1	1	1	1	1	1	1	1	100		
5493	1	1	1	1	1	1	1	1	1	1	100		
5494	1	1	1	1	1	1	1	1	1	1	100		
5495	1	1	1	1	1	1	1	1	1	1	100		
5496	1	1	1	1	1	1	1	1	1	1	100		
5497	1	1	1	1	1	1	1	1	1	1	100		
5498	1	1	1	1	1	1	1	1	1	1	100		
5499	1	1	1	1	1	1	1	1	1	1	100		
5500	1	1	1	1	1	1	1	1	1	1	100		
5501	1	1	1	1	1	1	1	1	1	1	100		
5502	1	1	1	1	1	1	1	1	1	1	100		
5503	1	1	1	1	1	1	1	1	1	1	100		
5504	1	1	1	1	1	1	1	1	1	1	100		
5505	1	1	1	1	1	1	1	1	1	1	100		
5506	1	1	1	1	1	1	1	1	1	1	100		
5507	1	1	1	1	1	1	1	1	1	1	100		
5508	1	1	1	1	1	1	1	1	1	1	100		
5509	1	1	1	1	1	1	1	1	1	1	100		
5510	1	1	1	1	1	1	1	1	1	1	100		
5511	1	1	1	1	1	1	1	1	1	1	100		
5512	1	1	1	1	1	1	1	1	1	1	100		
5513	1	1	1	1	1	1	1	1	1	1	100		
5514	1	1	1	1	1	1	1	1	1	1	100		
5515	1	1	1	1	1	1	1	1	1	1	100		
5516	1	1	1	1	1	1	1	1	1	1	100		
5517	1	1	1	1	1	1	1	1	1	1	100		
5518	1	1	1	1	1	1	1	1	1	1	100		
5519	1	1	1	1	1	1	1	1	1	1	100		
5520	1	1	1	1	1	1	1	1	1	1	100		
5521	1	1	1	1	1	1	1	1	1	1	100		
5522	1	1	1	1	1	1	1	1	1	1	100		
5523	1	1	1	1	1	1	1	1	1	1	100		
5524	1	1	1	1	1	1	1	1	1	1	100		
5525	1	1	1	1	1	1	1	1	1	1	100		
5526	1	1	1	1	1	1	1	1	1	1	100		
5527	1	1	1	1	1	1	1	1	1	1	100		
5528	1	1	1	1	1	1	1	1	1	1	100		
5529	1	1	1	1	1	1	1	1	1	1	100		

**USA Bin 2 Radar**



Radars Frequency	DFS Detection Trials (1=Detection, Blank= No Detection)										Detection Rate (%)	Detection Bandwidth (MHz)	Limit (MHz)
	1	2	3	4	5	6	7	8	9	10			
5530	1	1	1	1	1	1	1	1	1	1	100	78	76
5531	1	1	1	1	1	1	1	1	1	1	100		
5532	1	1	1	1	1	1	1	1	1	1	100		
5533	1	1	1	1	1	1	1	1	1	1	100		
5534	1	1	1	1	1	1	1	1	1	1	100		
5535	1	1	1	1	1	1	1	1	1	1	100		
5536	1	1	1	1	1	1	1	1	1	1	100		
5537	1	1	1	1	1	1	1	1	1	1	100		
5538	1	1	1	1	1	1	1	1	1	1	100		
5539	1	1	1	1	1	1	1	1	1	1	100		
5540	1	1	1	1	1	1	1	1	1	1	100		
5541	1	1	1	1	1	1	1	1	1	1	100		
5542	1	1	1	1	1	1	1	1	1	1	100		
5543	1	1	1	1	1	1	1	1	1	1	100		
5544	1	1	1	1	1	1	1	1	1	1	100		
5545	1	1	1	1	1	1	1	1	1	1	100		
5546	1	1	1	1	1	1	1	1	1	1	100		
5547	1	1	1	1	1	1	1	1	1	1	100		
5548	1	1	1	1	1	1	1	1	1	1	100		
5549	1	1	1	1	1	1	1	1	1	1	100		
5550	1	1	1	1	1	1	1	1	1	1	100		
5551	1	1	1	1	1	1	1	1	1	1	100		
5552	1	1	1	1	1	1	1	1	1	1	100		
5553	1	1	1	1	1	1	1	1	1	1	100		
5554	1	1	1	1	1	1	1	1	1	1	100		
5555	1	1	1	1	1	1	1	1	1	1	100		
5556	1	1	1	1	1	1	1	1	1	1	100		
5557	1	1	1	1	1	1	1	1	1	1	100		
5558	1	1	1	1	1	1	1	1	1	1	100		
5559	1	1	1	1	1	1	1	1	1	1	100		
5560	1	1	1	1	1	1	1	1	1	1	100		
5561	1	1	1	1	1	1	1	1	1	1	100		
5562	1	1	1	1	1	1	0	1	1	1	90		
5563	1	1	1	1	1	1	1	1	1	1	100		
5564	1	1	1	1	1	1	1	1	1	1	100		
5565	1	1	1	1	1	1	1	1	1	1	100		
5566	1	1	1	1	1	1	1	1	1	1	100		
5567	1	1	1	1	1	1	1	1	1	1	100		
5568	1	1	1	1	1	1	1	1	1	1	100		
5569	1	1	1	1	1	1	1	1	1	1	100		
5570	1	1	0	1	1	1	0	0	0	1	60		

**USA Bin 2 Radar (cont)**





Radars Frequency	DFS Detection Trials (1=Detection, Blank= No Detection)										Detection Rate (%)	Detection Bandwidth (MHz)	Limit (MHz)
	1	2	3	4	5	6	7	8	9	10			
5490	0	0	0	0	0	0	0	0	0	0	0	76	76
5491	0	0	0	0	0	0	0	0	0	0	0		
5492	1	1	1	1	1	1	1	1	1	1	1		
5493	1	1	1	1	1	1	1	1	1	1	1		
5494	1	1	1	1	1	1	1	1	1	1	1		
5495	1	1	1	1	1	1	1	1	1	1	1		
5496	1	1	1	1	1	1	1	1	1	1	1		
5497	1	1	1	1	1	1	1	1	1	1	1		
5498	1	1	1	1	1	1	1	1	1	1	1		
5499	1	1	1	1	1	1	1	1	1	1	1		
5500	1	1	1	1	1	1	1	1	1	1	1		
5501	1	1	1	1	1	1	1	1	1	1	1		
5502	1	1	1	1	1	1	1	1	1	1	1		
5503	1	1	1	1	1	1	1	1	1	1	1		
5504	1	1	1	1	1	1	1	1	1	1	1		
5505	1	1	1	1	1	1	1	1	1	1	1		
5506	1	1	1	1	1	1	1	1	1	1	1		
5507	1	1	1	1	1	1	1	1	1	1	1		
5508	1	1	1	1	1	1	1	1	1	1	1		
5509	1	1	1	1	1	1	1	1	1	1	1		
5510	1	1	1	1	1	1	1	1	1	1	1		
5511	1	1	1	1	1	1	1	1	1	1	1		
5512	1	1	1	1	1	1	1	1	1	1	1		
5513	1	1	1	1	1	1	1	1	1	1	1		
5514	1	1	1	1	1	1	1	1	1	1	1		
5515	1	1	1	1	1	1	1	1	1	1	1		
5516	1	1	1	1	1	1	1	1	1	1	1		
5517	1	1	1	1	1	1	1	1	1	1	1		
5518	1	1	1	1	1	1	1	1	1	1	1		
5519	1	1	1	1	1	1	1	1	1	1	1		
5520	1	1	1	1	1	1	1	1	1	1	1		
5521	1	1	1	1	1	1	1	1	1	1	1		
5522	1	1	1	1	1	1	1	1	1	1	1		
5523	1	1	1	1	1	1	1	1	1	1	1		
5524	1	1	1	1	1	1	1	1	1	1	1		
5525	1	1	1	1	1	1	1	1	1	1	1		
5526	1	1	1	1	1	1	1	1	1	1	1		
5527	1	1	1	1	1	1	1	1	1	1	1		
5528	1	1	1	1	1	1	1	1	1	1	1		
5529	1	1	1	1	1	1	1	1	1	1	1		

**USA Bin 3 Radar**



Radars Frequency	DFS Detection Trials (1=Detection, Blank= No Detection)										Detection Rate (%)	Detection Bandwidth (MHz)	Limit (MHz)
	1	2	3	4	5	6	7	8	9	10			
5530	1	1	1	1	1	1	1	1	1	1	100	76	76
5531	1	1	1	1	1	1	1	1	1	1	100		
5532	1	1	0	1	1	1	1	1	1	1	90		
5533	1	1	1	1	1	1	1	1	1	1	100		
5534	1	1	1	1	1	1	1	1	1	1	100		
5535	1	1	1	1	1	1	1	1	1	1	100		
5536	1	1	1	1	1	1	1	1	1	1	100		
5537	1	1	1	1	1	1	1	1	1	1	100		
5538	1	1	1	1	1	1	1	1	1	1	100		
5539	1	1	1	1	1	1	1	1	1	1	100		
5540	1	1	1	1	1	1	1	1	1	1	100		
5541	1	1	1	1	1	1	1	1	1	1	100		
5542	1	1	1	1	1	1	1	1	1	1	100		
5543	1	1	1	1	1	1	1	1	1	1	100		
5544	1	1	1	1	1	1	1	1	1	1	100		
5545	1	1	1	1	1	1	1	1	1	1	100		
5546	1	1	1	1	1	1	1	1	1	1	100		
5547	1	1	1	1	1	1	1	1	1	1	100		
5548	1	1	1	1	1	1	1	1	1	1	100		
5549	1	1	1	1	1	1	1	1	1	1	100		
5550	1	1	1	1	1	1	1	1	1	1	100		
5551	1	1	1	1	1	1	1	1	1	1	100		
5552	1	1	1	1	1	1	1	1	1	1	100		
5553	1	1	1	1	1	1	1	1	1	1	100		
5554	1	1	1	1	1	1	1	1	1	1	100		
5555	1	1	1	1	1	1	1	1	1	1	100		
5556	1	1	1	1	1	1	1	1	1	1	100		
5557	1	1	1	1	1	1	1	1	1	1	100		
5558	1	1	1	1	1	1	1	1	1	1	100		
5559	1	1	1	1	1	1	1	1	1	1	100		
5560	1	1	1	1	1	1	1	1	1	1	100		
5561	1	1	1	1	1	1	1	1	1	1	100		
5562	1	1	1	1	1	1	1	1	1	1	100		
5563	1	1	1	1	1	1	1	1	1	1	100		
5564	1	1	1	1	1	1	1	1	1	1	100		
5565	1	1	1	1	1	1	1	1	1	1	100		
5566	1	1	1	1	1	1	1	1	1	1	100		
5567	1	1	1	1	1	1	1	1	1	1	100		
5568	1	1	1	1	1	1	1	1	1	1	100		
5569	0	0	0	0	0	0	0	0	0	0	0		
5570	0	0	0	0	0	0	0	0	0	0	0		

**USA Bin 3 Radar (cont)**



Radars Frequency	DFS Detection Trials (1=Detection, Blank= No Detection)										Detection Rate (%)	Detection Bandwidth (MHz)	Limit (MHz)
	1	2	3	4	5	6	7	8	9	10			
5490	0	0	0	0	0	0	0	0	0	0	0	76	76
5491	0	0	0	0	0	0	0	0	0	0	0		
5492	1	1	1	1	1	1	1	1	1	1	100		
5493	1	1	1	1	1	1	1	1	1	1	100		
5494	1	1	1	1	1	1	1	1	1	1	100		
5495	1	1	1	1	1	1	1	1	1	1	100		
5496	1	1	1	1	1	1	1	1	1	1	100		
5497	1	1	1	1	1	1	1	1	1	1	100		
5498	1	1	1	1	1	1	1	1	1	1	100		
5499	1	1	1	1	1	1	1	1	1	1	100		
5500	1	1	1	1	1	1	1	1	1	1	100		
5501	1	1	1	1	1	1	1	1	1	1	100		
5502	1	1	1	1	1	1	1	1	1	1	100		
5503	1	1	1	1	1	1	1	1	1	1	100		
5504	1	1	1	1	1	1	1	1	1	1	100		
5505	1	1	1	1	1	1	1	1	1	1	100		
5506	1	1	1	1	1	1	1	1	1	1	100		
5507	1	1	1	1	1	1	1	1	1	1	100		
5508	1	1	1	1	1	1	1	1	1	1	100		
5509	1	1	1	1	1	1	1	1	1	1	100		
5510	1	1	1	1	1	1	1	1	1	1	100		
5511	1	1	1	1	1	1	1	1	1	1	100		
5512	1	1	1	1	1	1	1	1	1	1	100		
5513	1	1	1	1	1	1	1	1	1	1	100		
5514	1	1	1	1	1	1	1	1	1	1	100		
5515	1	1	1	1	1	1	1	1	1	1	100		
5516	1	1	1	1	1	1	1	1	1	1	100		
5517	1	1	1	1	1	1	1	1	1	1	100		
5518	1	1	1	1	1	1	1	1	1	1	100		
5519	1	1	1	1	1	1	1	1	1	1	100		
5520	1	1	1	1	1	1	1	1	1	1	100		
5521	1	1	1	1	1	1	1	1	1	1	100		
5522	1	1	1	1	1	1	1	1	1	1	100		
5523	1	1	1	1	1	1	1	1	1	1	100		
5524	1	1	1	1	1	1	1	1	1	1	100		
5525	1	1	1	1	1	1	1	1	1	1	100		
5526	1	1	1	1	1	1	1	1	1	1	100		
5527	1	1	1	1	1	1	1	1	1	1	100		
5528	1	1	1	1	1	1	1	1	1	1	100		
5529	1	1	1	1	1	1	1	1	1	1	100		

**USA Bin 4 Radar**



Radars Frequency	DFS Detection Trials (1=Detection, Blank= No Detection)										Detection Rate (%)	Detection Bandwidth (MHz)	Limit (MHz)
	1	2	3	4	5	6	7	8	9	10			
5530	1	1	1	1	1	1	1	1	1	1	100	76	76
5531	1	1	1	1	1	1	1	1	1	1	100		
5532	1	1	1	1	1	1	1	1	1	1	100		
5533	1	1	1	1	1	1	1	1	1	1	100		
5534	1	1	1	1	1	1	1	1	1	1	100		
5535	1	1	1	1	1	1	1	1	1	1	100		
5536	1	1	1	1	1	1	1	1	1	1	100		
5537	1	1	1	1	1	1	1	1	1	1	100		
5538	1	1	1	1	1	1	1	1	1	1	100		
5539	1	1	1	1	1	1	1	1	1	1	100		
5540	1	1	1	1	1	1	1	1	1	1	100		
5541	1	1	1	1	1	1	1	1	1	1	100		
5542	1	1	1	1	1	1	1	1	1	1	100		
5543	1	1	1	1	1	1	1	1	1	1	100		
5544	1	1	1	1	1	1	1	1	1	1	100		
5545	1	1	1	1	1	1	1	1	1	1	100		
5546	1	1	1	1	1	1	1	1	1	1	100		
5547	1	1	1	1	1	1	1	1	1	1	100		
5548	1	1	1	1	1	1	1	1	1	1	100		
5549	1	1	1	1	1	1	1	1	1	1	100		
5550	1	1	1	1	1	1	1	1	1	1	100		
5551	1	1	1	1	1	1	1	1	1	1	100		
5552	1	1	1	1	1	1	1	1	1	1	100		
5553	1	1	1	1	1	1	1	1	1	1	100		
5554	1	1	1	1	1	1	1	1	1	1	100		
5555	1	1	1	1	1	1	1	1	1	1	100		
5556	1	1	1	1	1	1	1	1	1	1	100		
5557	1	1	1	1	1	1	1	1	1	1	100		
5558	1	1	1	1	1	1	1	1	1	1	100		
5559	1	1	1	1	1	1	1	1	1	1	100		
5560	1	1	1	1	1	1	1	1	1	1	100		
5561	1	1	1	1	1	1	1	1	1	1	100		
5562	1	1	1	1	1	1	1	1	1	1	100		
5563	1	1	1	1	1	1	1	1	1	1	100		
5564	1	1	1	1	1	1	1	1	1	1	100		
5565	1	1	1	1	1	1	1	1	1	1	100		
5566	1	1	1	1	1	1	1	1	1	1	100		
5567	1	1	1	1	1	1	1	1	1	1	100		
5568	1	1	1	1	1	1	1	1	1	1	100		
5569	0	0	0	0	0	0	0	0	0	0	0		
5570	0	0	0	0	0	0	0	0	0	0	0		

**USA Bin 4 Radar (cont)**



Radars Frequency	DFS Detection Trials (1=Detection, Blank= No Detection)										Detection Rate (%)	Detection Bandwidth (MHz)	Limit (MHz)
	1	2	3	4	5	6	7	8	9	10			
5490	1	1	1	1	1	1	1	1	1	1	100	76	76
5491	1	1	1	1	1	1	1	1	1	1	100		
5492	1	1	1	1	1	1	1	1	1	1	100		
5493	1	1	1	1	1	1	1	1	1	1	100		
5494	1	1	1	1	1	1	1	1	1	1	100		
5495	1	1	1	1	1	1	1	1	1	1	100		
5496	1	1	1	1	1	1	1	1	1	1	100		
5497	1	1	1	1	1	1	1	1	1	1	100		
5498	1	1	1	1	1	1	1	1	1	1	100		
5499	1	1	1	1	1	1	1	1	1	1	100		
5500	1	1	1	1	1	1	1	1	1	1	100		
5501	1	1	1	1	1	1	1	1	1	1	100		
5502	1	1	1	1	1	1	1	1	1	1	100		
5503	1	1	1	1	1	1	1	1	1	1	100		
5504	1	1	1	1	1	1	1	1	1	1	100		
5505	1	1	1	1	1	1	1	1	1	1	100		
5506	1	1	1	1	1	1	1	1	1	1	100		
5507	1	1	1	1	1	1	1	1	1	1	100		
5508	1	1	1	1	1	1	1	1	1	1	100		
5509	1	1	1	1	1	1	1	1	1	1	100		
5510	1	1	1	1	1	1	1	1	1	1	100		
5511	1	1	1	1	1	1	1	1	1	1	100		
5512	1	1	1	1	1	1	1	1	1	1	100		
5513	1	1	1	1	1	1	1	1	1	1	100		
5514	1	1	1	1	1	1	1	1	1	1	100		
5515	1	1	1	1	1	1	1	1	1	1	100		
5516	1	1	1	1	1	1	1	1	1	1	100		
5517	1	1	1	1	1	1	1	1	1	1	100		
5518	1	1	1	1	1	1	1	1	1	1	100		
5519	1	1	1	1	1	1	1	1	1	1	100		
5520	1	1	1	1	1	1	1	1	1	1	100		
5521	1	1	1	1	1	1	1	1	1	1	100		
5522	1	1	1	1	1	1	1	1	1	1	100		
5523	1	1	1	1	1	1	1	1	1	1	100		
5524	1	1	1	1	1	1	1	1	1	1	100		
5525	1	1	1	1	1	1	1	1	1	1	100		
5526	1	1	1	1	1	1	1	1	1	1	100		
5527	1	1	1	1	1	1	1	1	1	1	100		
5528	1	1	1	1	1	1	1	1	1	1	100		
5529	1	1	1	1	1	1	1	1	1	1	100		

**USA Bin 5 Radar**



Radars Frequency	DFS Detection Trials (1=Detection, Blank= No Detection)										Detection Rate (%)	Detection Bandwidth (MHz)	Limit (MHz)
	1	2	3	4	5	6	7	8	9	10			
5530	1	1	1	1	1	1	1	1	1	1	100	76	76
5531	1	1	1	1	1	1	1	1	1	1	100		
5532	1	1	1	1	1	1	1	1	1	1	100		
5533	1	1	1	1	1	1	1	1	1	1	100		
5534	1	1	1	1	1	1	1	1	1	1	100		
5535	1	1	1	1	1	1	1	1	1	1	100		
5536	1	1	1	1	1	1	1	1	1	1	100		
5537	1	1	1	1	1	1	1	1	1	1	100		
5538	1	1	1	1	1	1	1	1	1	1	100		
5539	1	1	1	1	1	1	1	1	1	1	100		
5540	1	1	1	1	1	1	1	1	1	1	100		
5541	1	1	1	1	1	1	1	1	1	1	100		
5542	1	1	1	1	1	1	1	1	1	1	100		
5543	1	1	1	1	1	1	1	1	1	1	100		
5544	1	1	1	1	1	1	1	1	1	1	100		
5545	1	1	1	1	1	1	1	1	1	1	100		
5546	1	1	1	1	1	1	1	1	1	1	100		
5547	1	1	1	1	1	1	1	1	1	1	100		
5548	1	1	1	1	1	1	1	1	1	1	100		
5549	1	1	1	1	1	1	1	1	1	1	100		
5550	1	1	1	1	1	1	1	1	1	1	100		
5551	1	1	1	1	1	1	1	1	1	1	100		
5552	1	1	1	1	1	1	1	1	1	1	100		
5553	1	1	1	1	1	1	1	1	1	1	100		
5554	1	1	1	1	1	1	1	1	1	1	100		
5555	1	1	1	1	1	1	1	1	1	1	100		
5556	1	1	1	1	1	1	1	1	1	1	100		
5557	1	1	1	1	1	1	1	1	1	1	100		
5558	1	1	1	1	1	1	1	1	1	1	100		
5559	1	1	1	1	1	1	1	1	1	1	100		
5560	1	1	1	1	1	1	1	1	1	1	100		
5561	1	1	1	1	1	1	1	1	1	1	100		
5562	1	1	1	1	1	1	1	1	1	1	100		
5563	1	1	1	1	1	1	1	1	1	1	100		
5564	1	1	1	1	1	1	1	1	1	1	100		
5565	1	1	1	1	1	1	1	1	1	1	100		
5566	1	1	1	0	1	1	1	1	1	1	90		
5567	1	1	0	1	1	1	1	1	1	1	90		
5568	1	1	1	1	1	1	0	1	1	1	90		
5569	0	1	1	1	1	0	1	1	1	1	80		
5570	1	1	1	1	1	1	1	1	1	1	100		

USA Bin 5 Radar (cont)



Radar Frequency	DFS Detection Trials (1=Detection, Blank= No Detection)										Detection Rate (%)	Detection Bandwidth (MHz)	Limit (MHz)
	1	2	3	4	5	6	7	8	9	10			
5490	0	0	0	0	0	1	0	0	0	0	10	78	76
5491	1	1	1	1	1	1	1	1	1	1	100		
5492	1	1	1	1	1	1	1	1	1	1	100		
5493	1	1	1	1	1	1	1	1	1	1	100		
5494	1	1	1	1	1	1	1	1	1	1	100		
5495	1	1	1	1	1	1	1	1	1	1	100		
5496	1	1	1	1	1	1	1	1	1	1	100		
5497	1	1	1	1	1	1	1	1	1	1	100		
5498	1	0	1	1	1	1	1	1	1	1	90		
5499	1	1	1	1	1	1	1	1	1	1	100		
5500	1	1	1	1	1	1	1	1	1	1	100		
5501	1	1	1	1	1	1	1	1	1	1	100		
5502	1	1	1	1	1	1	1	1	1	1	100		
5503	1	1	1	1	1	1	1	1	1	1	100		
5504	1	1	1	1	1	1	1	1	1	1	100		
5505	1	1	1	1	1	1	1	1	1	1	100		
5506	1	1	1	1	1	1	1	1	1	1	100		
5507	1	1	1	1	1	1	1	1	1	1	100		
5508	1	1	1	1	1	1	1	1	1	1	100		
5509	1	1	1	1	1	1	1	1	1	1	100		
5510	1	1	1	1	1	1	1	1	1	1	100		
5511	1	1	1	1	1	1	1	1	1	1	100		
5512	1	1	1	1	1	1	1	1	1	1	100		
5513	1	1	1	1	1	1	1	1	1	1	100		
5514	1	1	1	1	1	1	1	1	1	1	100		
5515	1	1	1	1	1	1	1	1	1	1	100		
5516	1	1	1	1	1	1	1	1	1	1	100		
5517	1	1	1	1	1	1	1	1	1	1	100		
5518	1	1	1	1	1	1	1	1	1	1	100		
5519	1	1	1	1	1	1	1	1	1	1	100		
5520	1	1	1	1	1	1	1	1	1	1	100		
5521	1	1	1	1	1	1	1	1	1	1	100		
5522	1	1	1	1	1	1	1	1	1	1	100		
5523	1	1	1	1	1	1	1	1	1	1	100		
5524	1	1	1	1	1	1	1	1	1	1	100		
5525	1	1	1	1	1	1	1	1	1	1	100		
5526	1	1	1	1	1	1	1	1	1	1	100		
5527	1	1	1	1	1	1	1	1	1	1	100		
5528	1	1	1	1	1	1	1	1	1	1	100		
5529	1	1	1	1	1	1	1	1	1	1	100		

**USA Frequency Hopping Radar**



Radars Frequency	DFS Detection Trials (1=Detection, Blank= No Detection)										Detection Rate (%)	Detection Bandwidth (MHz)	Limit (MHz)
	1	2	3	4	5	6	7	8	9	10			
5530	1	1	1	1	1	1	1	1	1	1	100	78	76
5531	1	1	1	1	1	1	1	1	1	1	100		
5532	1	1	1	1	1	1	1	1	1	1	100		
5533	1	1	1	1	1	1	1	1	1	1	100		
5534	1	1	1	1	1	1	1	1	1	1	100		
5535	1	1	1	1	1	1	1	1	1	1	100		
5536	1	1	1	1	1	1	1	1	1	1	100		
5537	1	1	1	1	1	1	1	1	1	1	100		
5538	1	1	1	1	1	1	1	1	1	1	100		
5539	1	1	1	1	1	1	1	1	1	1	100		
5540	1	1	1	1	1	1	1	1	1	1	100		
5541	1	1	1	1	1	1	1	1	1	1	100		
5542	1	1	1	1	1	1	1	1	1	1	100		
5543	1	1	1	1	1	1	1	1	1	1	100		
5544	1	1	1	1	1	1	1	1	1	1	100		
5545	1	1	1	1	1	1	1	1	1	1	100		
5546	1	1	1	1	1	1	1	1	1	1	100		
5547	1	1	1	1	1	1	1	1	1	1	100		
5548	1	1	1	1	1	1	1	1	1	1	100		
5549	1	1	1	1	1	1	1	1	1	1	100		
5550	1	1	1	1	1	1	1	1	1	1	100		
5551	1	1	1	1	1	1	1	1	1	1	100		
5552	1	1	1	1	1	1	1	1	1	1	100		
5553	1	1	1	1	1	1	1	1	1	1	100		
5554	1	1	1	1	1	1	1	1	1	1	100		
5555	1	1	1	1	1	1	1	1	1	1	100		
5556	1	1	1	1	1	1	1	1	1	1	100		
5557	1	1	1	1	1	1	1	1	1	1	100		
5558	1	1	1	1	1	1	1	1	1	1	100		
5559	1	1	1	1	1	1	1	1	1	1	100		
5560	1	1	1	1	1	1	1	1	1	1	100		
5561	1	1	1	1	1	1	1	1	1	1	100		
5562	1	1	1	1	1	1	0	1	1	1	90		
5563	1	1	1	1	1	1	1	1	1	1	100		
5564	1	1	1	1	1	1	1	1	1	1	100		
5565	1	1	1	1	1	1	1	1	1	1	100		
5566	1	1	1	1	1	1	1	1	1	1	100		
5567	1	1	1	1	1	1	1	1	1	1	100		
5568	1	1	1	1	1	1	1	1	1	1	100		
5569	1	1	1	1	1	1	1	1	1	0	90		
5570	0	0	1	0	0	0	0	1	0	0	20		

**USA Frequency Hopping Radar (cont)**





Radar Frequency	DFS Detection Trials (1=Detection, Blank= No Detection)										Detection Rate (%)	Detection Bandwidth (MHz)	Limit (MHz)
	1	2	3	4	5	6	7	8	9	10			
5490	0	0	0	0	1	1	1	0	0	0	30	158	156
5491	1	1	1	1	1	1	1	1	1	1	100		
5492	1	1	1	1	1	1	1	1	1	1	100		
5493	1	1	1	1	1	1	1	1	1	1	100		
5494	1	1	1	1	1	1	1	1	1	1	100		
5495	1	1	1	1	1	1	1	1	1	1	100		
5496	1	1	1	1	1	1	1	1	1	1	100		
5497	1	1	1	1	1	1	1	1	1	1	100		
5498	1	1	1	1	1	1	1	1	1	1	100		
5499	1	1	1	1	1	1	1	1	1	1	100		
5500	1	1	1	1	1	1	1	1	1	1	100		
5501	1	1	1	1	1	1	1	1	1	1	100		
5502	1	1	1	1	1	1	1	1	1	1	100		
5503	1	1	1	1	1	1	1	1	1	1	100		
5504	1	1	1	1	1	1	1	1	1	1	100		
5505	1	1	1	1	1	1	1	1	1	1	100		
5506	1	1	1	1	1	1	1	1	1	1	100		
5507	1	1	1	1	1	1	1	1	1	1	100		
5508	1	1	1	1	1	1	1	1	1	1	100		
5509	1	1	1	1	1	1	1	1	1	1	100		
5510	1	1	1	1	1	1	1	1	1	1	100		
5511	1	1	1	1	1	1	1	1	1	1	100		
5512	1	1	1	1	1	1	1	1	1	1	100		
5513	1	1	1	1	1	1	1	1	1	1	100		
5514	1	1	1	1	1	1	1	1	1	1	100		
5515	1	1	1	1	1	1	1	1	1	1	100		
5516	1	1	1	1	1	1	1	1	1	1	100		
5517	1	1	1	1	1	1	1	1	1	1	100		
5518	1	1	1	1	1	1	1	1	1	1	100		
5519	1	1	1	1	1	1	1	1	1	1	100		
5520	1	1	1	1	1	1	1	1	1	1	100		
5521	1	1	1	1	1	1	1	1	1	1	100		
5522	1	1	1	1	1	1	1	1	1	1	100		
5523	1	1	1	1	1	1	1	1	1	1	100		
5524	1	1	1	1	1	1	1	1	1	1	100		
5525	1	1	1	1	1	1	1	1	1	1	100		
5526	1	1	1	1	1	1	1	1	1	1	100		
5527	1	1	1	1	1	1	1	1	1	1	100		
5528	1	1	1	1	1	1	1	1	1	1	100		
5529	1	1	1	1	1	1	1	1	1	1	100		

**USA Bin 0 Radar**



Radar Frequency	DFS Detection Trials (1=Detection, Blank= No Detection)										Detection Rate (%)	Detection Bandwidth (MHz)	Limit (MHz)
	1	2	3	4	5	6	7	8	9	10			
5530	1	1	1	1	1	1	1	1	1	1	100	158	156
5531	1	1	1	1	1	1	1	1	1	1	100		
5532	1	1	1	1	1	1	1	1	1	1	100		
5533	1	1	1	1	1	1	1	1	1	1	100		
5534	1	1	1	1	1	1	1	1	1	1	100		
5535	1	1	1	1	1	1	1	1	1	1	100		
5536	1	1	1	1	1	1	1	1	1	1	100		
5537	1	1	1	1	1	1	1	1	1	1	100		
5538	1	1	1	1	1	1	1	1	1	1	100		
5539	1	1	1	1	1	1	1	1	1	1	100		
5540	1	1	1	1	1	1	1	1	1	1	100		
5541	1	1	1	1	1	1	1	1	1	1	100		
5542	1	1	1	1	1	1	1	1	1	1	100		
5543	1	1	1	1	1	1	1	1	1	1	100		
5544	1	1	1	1	1	1	1	1	1	1	100		
5545	1	1	1	1	1	1	1	1	1	1	100		
5546	1	1	1	1	1	1	1	1	1	1	100		
5547	1	1	1	1	1	1	1	1	1	1	100		
5548	1	1	1	1	1	1	1	1	1	1	100		
5549	1	1	1	1	1	1	1	1	1	1	100		
5550	1	1	1	1	1	1	1	1	1	1	100		
5551	1	1	1	1	1	1	1	1	1	1	100		
5552	1	1	1	1	1	1	1	1	1	1	100		
5553	1	1	1	1	1	1	1	1	1	1	100		
5554	1	1	1	1	1	1	1	1	1	1	100		
5555	1	1	1	1	1	1	1	1	1	1	100		
5556	1	1	1	1	1	1	1	1	1	1	100		
5557	1	1	1	1	1	1	1	1	1	1	100		
5558	1	1	1	1	1	1	1	1	1	1	100		
5559	1	1	1	1	1	1	1	1	1	1	100		
5560	1	1	1	1	1	1	1	1	1	1	100		
5561	1	1	1	1	1	1	1	1	1	1	100		
5562	1	1	1	1	1	1	1	1	1	1	100		
5563	1	1	1	1	1	1	1	1	1	1	100		
5564	1	1	1	1	1	1	1	1	1	1	100		
5565	1	1	1	1	1	1	1	1	1	1	100		
5566	1	1	1	1	1	1	1	1	1	1	100		
5567	1	1	1	1	1	1	1	1	1	1	100		
5568	1	1	1	1	1	1	1	1	1	1	100		
5569	1	1	1	1	1	1	1	1	1	1	100		

USA Bin 0 Radar (cont)



Radars Frequency	DFS Detection Trials (1=Detection, Blank= No Detection)										Detection Rate (%)	Detection Bandwidth (MHz)	Limit (MHz)
	1	2	3	4	5	6	7	8	9	10			
5570	1	1	1	1	1	1	1	1	1	1	100	158	156
5571	1	1	1	1	1	1	1	1	1	1	100		
5572	1	1	1	1	1	1	1	1	1	1	100		
5573	1	1	1	1	1	1	1	1	1	1	100		
5574	1	1	1	1	1	1	1	1	1	1	100		
5575	1	1	1	1	1	1	1	1	1	1	100		
5576	1	1	1	1	1	1	1	1	1	1	100		
5577	1	1	1	1	1	1	1	1	1	1	100		
5578	1	1	1	1	1	1	1	1	1	1	100		
5579	1	1	1	1	1	1	1	1	1	1	100		
5580	1	1	1	1	1	1	1	1	1	1	100		
5581	1	1	1	1	1	1	1	1	1	1	100		
5582	1	1	1	1	1	1	1	1	1	1	100		
5583	1	1	1	1	1	1	1	1	1	1	100		
5584	1	1	1	1	1	1	1	1	1	1	100		
5585	1	1	1	1	1	1	1	1	1	1	100		
5586	1	1	1	1	1	1	1	1	1	1	100		
5587	1	1	1	1	1	1	1	1	1	1	100		
5588	1	1	1	1	1	1	1	1	1	1	100		
5589	1	1	1	1	1	1	1	1	1	1	100		
5590	1	1	1	1	1	1	1	1	1	1	100		
5591	1	1	1	1	1	1	1	1	1	1	100		
5592	1	1	1	1	1	1	1	1	1	1	100		
5593	1	1	1	1	1	1	1	1	1	1	100		
5594	1	1	1	1	1	1	1	1	1	1	100		
5595	1	1	1	1	1	1	1	1	1	1	100		
5596	1	1	1	1	1	1	1	1	1	1	100		
5597	1	1	1	1	1	1	1	1	1	1	100		
5598	1	1	1	1	1	1	1	1	1	1	100		
5599	1	1	1	1	1	1	1	1	1	1	100		
5600	1	1	1	1	1	1	1	1	1	1	100		
5601	1	1	1	1	1	1	1	1	1	1	100		
5602	1	1	1	1	1	1	1	1	1	1	100		
5603	1	1	1	1	1	1	1	1	1	1	100		
5604	1	1	1	1	1	1	1	1	1	1	100		
5605	1	1	1	1	1	1	1	1	1	1	100		
5606	1	1	1	1	1	1	1	1	1	1	100		
5607	1	1	1	1	1	1	1	1	1	1	100		
5608	1	1	1	1	1	1	1	1	1	1	100		
5609	1	1	1	1	1	1	1	1	1	1	100		

**USA Bin 0 Radar (cont)**



Radars Frequency	DFS Detection Trials (1=Detection, Blank= No Detection)										Detection Rate (%)	Detection Bandwidth (MHz)	Limit (MHz)
	1	2	3	4	5	6	7	8	9	10			
5610	1	1	1	1	1	1	1	1	1	1	100	158	156
5611	1	1	1	1	1	1	1	1	1	1	100		
5612	1	1	1	1	1	1	1	1	1	1	100		
5613	1	1	1	1	1	1	1	1	1	1	100		
5614	1	1	1	1	1	1	1	1	1	1	100		
5615	1	1	1	1	1	1	1	1	1	1	100		
5616	1	1	1	1	1	1	1	1	1	1	100		
5617	1	1	1	1	1	1	1	1	1	1	100		
5618	1	1	1	1	1	1	1	1	1	1	100		
5619	1	1	1	1	1	1	1	1	1	1	100		
5620	1	1	1	1	1	1	1	1	1	1	100		
5621	1	1	1	1	1	1	1	1	1	1	100		
5622	1	1	1	1	1	1	1	1	1	1	100		
5623	1	1	1	1	1	1	1	1	1	1	100		
5624	1	1	1	1	1	1	1	1	1	1	100		
5625	1	1	1	1	1	1	1	1	1	1	100		
5626	1	1	1	1	1	1	1	1	1	1	100		
5627	1	1	1	1	1	1	1	1	1	1	100		
5628	1	1	1	1	1	1	1	1	1	1	100		
5629	1	1	1	1	1	1	1	1	1	1	100		
5630	1	1	1	1	1	1	1	1	1	1	100		
5631	1	1	1	1	1	1	1	1	1	1	100		
5632	1	1	1	1	1	1	1	1	1	1	100		
5633	1	1	1	1	1	1	1	1	1	1	100		
5634	1	1	1	1	1	1	1	1	1	1	100		
5635	1	1	1	1	1	1	1	1	1	1	100		
5636	1	1	1	1	1	1	1	1	1	1	100		
5637	1	1	1	1	1	1	1	1	1	1	100		
5638	1	1	1	1	1	1	1	1	1	1	100		
5639	1	1	1	1	1	1	1	1	1	1	100		
5640	1	1	1	1	1	1	1	1	1	1	100		
5641	1	1	1	1	1	1	1	1	1	1	100		
5642	1	1	1	1	1	1	1	1	1	1	100		
5643	1	1	1	1	1	1	1	1	1	1	100		
5644	1	1	1	1	1	1	1	1	1	1	100		
5645	1	1	1	1	1	1	1	1	1	1	100		
5646	1	1	1	1	1	1	1	1	1	1	100		
5647	1	1	1	1	1	1	1	1	1	1	100		
5648	1	1	1	1	1	1	1	1	1	1	100		
5649	1	1	1	1	1	1	1	1	1	1	100		
5650	0	0	0	0	0	0	0	1	0	0	10		

**USA Bin 0 Radar (cont)**



Radars Frequency	DFS Detection Trials (1=Detection, Blank= No Detection)										Detection Rate (%)	Detection Bandwidth (MHz)	Limit (MHz)
	1	2	3	4	5	6	7	8	9	10			
5490	0	0	0	0	0	0	0	0	0	0	0	158	156
5491	1	1	1	1	1	1	1	1	1	1	100		
5492	1	1	1	1	1	1	1	1	1	1	100		
5493	1	1	1	1	1	1	1	1	1	1	100		
5494	1	1	1	1	1	1	1	1	1	1	100		
5495	1	1	1	1	1	1	1	1	1	1	100		
5496	1	1	1	1	1	1	1	1	1	1	100		
5497	1	1	1	1	1	1	1	1	1	1	100		
5498	1	1	1	1	1	1	1	1	1	1	100		
5499	1	1	1	1	1	1	1	1	1	1	100		
5500	1	1	1	1	1	1	1	1	1	1	100		
5501	1	1	1	1	1	1	1	1	1	1	100		
5502	1	1	1	1	1	1	1	1	1	1	100		
5503	1	1	1	1	1	1	1	1	1	1	100		
5504	1	1	1	1	1	1	1	1	1	1	100		
5505	1	1	1	1	1	1	1	1	1	1	100		
5506	1	1	1	1	1	1	1	1	1	1	100		
5507	1	1	1	1	1	1	1	1	1	1	100		
5508	1	1	1	1	1	1	1	1	1	1	100		
5509	1	1	1	1	1	1	1	1	1	1	100		
5510	1	1	1	1	1	1	1	1	1	1	100		
5511	1	1	1	1	1	1	1	1	1	1	100		
5512	1	1	1	1	1	1	1	1	1	1	100		
5513	1	1	1	1	1	1	1	1	1	1	100		
5514	1	1	1	1	1	1	1	1	1	1	100		
5515	1	1	1	1	1	1	1	1	1	1	100		
5516	1	1	1	1	1	1	1	1	1	1	100		
5517	1	1	1	1	1	1	1	1	1	1	100		
5518	1	1	1	1	1	1	1	1	1	1	100		
5519	1	1	1	1	1	1	1	1	1	1	100		
5520	1	1	1	1	1	1	1	1	1	1	100		
5521	1	1	1	1	1	1	1	1	1	1	100		
5522	1	1	1	1	1	1	1	1	1	1	100		
5523	1	1	1	1	1	1	1	1	1	1	100		
5524	1	1	1	1	1	1	1	1	1	1	100		
5525	1	1	1	1	1	1	1	1	1	1	100		
5526	1	1	1	1	1	1	1	1	1	1	100		
5527	1	1	1	1	1	1	1	1	1	1	100		
5528	1	1	1	1	1	1	1	1	1	1	100		
5529	1	1	1	1	1	1	1	1	1	1	100		

**USA Bin 1A Radar**



Radars Frequency	DFS Detection Trials (1=Detection, Blank= No Detection)										Detection Rate (%)	Detection Bandwidth (MHz)	Limit (MHz)
	1	2	3	4	5	6	7	8	9	10			
5530	1	1	1	1	1	1	1	1	1	1	100	158	156
5531	1	1	1	1	1	1	1	1	1	1	100		
5532	1	1	1	1	1	1	1	1	1	1	100		
5533	1	1	1	1	1	1	1	1	1	1	100		
5534	1	1	1	1	1	1	1	1	1	1	100		
5535	1	1	1	1	1	1	1	1	1	1	100		
5536	1	1	1	1	1	1	1	1	1	1	100		
5537	1	1	1	1	1	1	1	1	1	1	100		
5538	1	1	1	1	1	1	1	1	1	1	100		
5539	1	1	1	1	1	1	1	1	1	1	100		
5540	1	1	1	1	1	1	1	1	1	1	100		
5541	1	1	1	1	1	1	1	1	1	1	100		
5542	1	1	1	1	1	1	1	1	1	1	100		
5543	1	1	1	1	1	1	1	1	1	1	100		
5544	1	1	1	1	1	1	1	1	1	1	100		
5545	1	1	1	1	1	1	1	1	1	1	100		
5546	1	1	1	1	1	1	1	1	1	1	100		
5547	1	1	1	1	1	1	1	1	1	1	100		
5548	1	1	1	1	1	1	1	1	1	1	100		
5549	1	1	1	1	1	1	1	1	1	1	100		
5550	1	1	1	1	1	1	1	1	1	1	100		
5551	1	1	1	1	1	1	1	1	1	1	100		
5552	1	1	1	1	1	1	1	1	1	1	100		
5553	1	1	1	1	1	1	1	1	1	1	100		
5554	1	1	1	1	1	1	1	1	1	1	100		
5555	1	1	1	1	1	1	1	1	1	1	100		
5556	1	1	1	1	1	1	1	1	1	1	100		
5557	1	1	1	1	1	1	1	1	1	1	100		
5558	1	1	1	1	1	1	1	1	1	1	100		
5559	1	1	1	1	1	1	1	1	1	1	100		
5560	1	1	1	1	1	1	1	1	1	1	100		
5561	1	1	1	1	1	1	1	1	1	1	100		
5562	1	1	1	1	1	1	1	1	1	1	100		
5563	1	1	1	1	1	1	1	1	1	1	100		
5564	1	1	1	1	1	1	1	1	1	1	100		
5565	1	1	1	1	1	1	1	1	1	1	100		
5566	1	1	1	1	1	1	1	1	1	1	100		
5567	1	1	1	1	1	1	1	1	1	1	100		
5568	1	1	1	1	1	1	1	1	1	1	100		
5569	1	1	1	1	1	1	1	1	1	1	100		

**USA Bin 1A Radar (cont)**



Radars Frequency	DFS Detection Trials (1=Detection, Blank= No Detection)										Detection Rate (%)	Detection Bandwidth (MHz)	Limit (MHz)
	1	2	3	4	5	6	7	8	9	10			
5570	1	1	1	1	1	1	1	1	1	1	100	158	156
5571	1	1	1	1	1	1	1	1	1	1	100		
5572	1	1	1	1	1	1	1	1	1	1	100		
5573	1	1	1	1	1	1	1	1	1	1	100		
5574	1	1	1	1	1	1	1	1	1	1	100		
5575	1	1	1	1	1	1	1	1	1	1	100		
5576	1	1	1	1	1	1	1	1	1	1	100		
5577	1	1	1	1	1	1	1	1	1	1	100		
5578	1	1	1	1	1	1	1	1	1	1	100		
5579	1	1	1	1	1	1	1	1	1	1	100		
5580	1	1	1	1	1	1	1	1	1	1	100		
5581	1	1	1	1	1	1	1	1	1	1	100		
5582	1	1	1	1	1	1	1	1	1	1	100		
5583	1	1	1	1	1	1	1	1	1	1	100		
5584	1	1	1	1	1	1	1	1	1	1	100		
5585	1	1	1	1	1	1	1	1	1	1	100		
5586	1	1	1	1	1	1	1	1	1	1	100		
5587	1	1	1	1	1	1	1	1	1	1	100		
5588	1	1	1	1	1	1	1	1	1	1	100		
5589	1	1	1	1	1	1	1	1	1	1	100		
5590	1	1	1	1	1	1	1	1	1	1	100		
5591	1	1	1	1	1	1	1	1	1	1	100		
5592	1	1	1	1	1	1	1	1	1	1	100		
5593	1	1	1	1	1	1	1	1	1	1	100		
5594	1	1	1	1	1	1	1	1	1	1	100		
5595	1	1	1	1	1	1	1	1	1	1	100		
5596	1	1	1	1	1	1	1	1	1	1	100		
5597	1	1	1	1	1	1	1	1	1	1	100		
5598	1	1	1	1	1	1	1	1	1	1	100		
5599	1	1	1	1	1	1	1	1	1	1	100		
5600	1	1	1	1	1	1	1	1	1	1	100		
5601	1	1	1	1	1	1	1	1	1	1	100		
5602	1	1	1	1	1	1	1	1	1	1	100		
5603	1	1	1	1	1	1	1	1	1	1	100		
5604	1	1	1	1	1	1	1	1	1	1	100		
5605	1	1	1	1	1	1	1	1	1	1	100		
5606	1	1	1	1	1	1	1	1	1	1	100		
5607	1	1	1	1	1	1	1	1	1	1	100		
5608	1	1	1	1	1	1	1	1	1	1	100		
5609	1	1	1	1	1	1	1	1	1	1	100		

USA Bin 1A Radar (cont)



Radars Frequency	DFS Detection Trials (1=Detection, Blank= No Detection)										Detection Rate (%)	Detection Bandwidth (MHz)	Limit (MHz)
	1	2	3	4	5	6	7	8	9	10			
5610	1	1	1	1	1	1	1	1	1	1	100	158	156
5611	1	1	1	1	1	1	1	1	1	1	100		
5612	1	1	1	1	1	1	1	1	1	1	100		
5613	1	1	1	1	1	1	1	1	1	1	100		
5614	1	1	1	1	1	1	1	1	1	1	100		
5615	1	1	1	1	1	1	1	1	1	1	100		
5616	1	1	1	1	1	1	1	1	1	1	100		
5617	1	1	1	1	1	1	1	1	1	1	100		
5618	1	1	1	1	1	1	1	1	1	1	100		
5619	1	1	1	1	1	1	1	1	1	1	100		
5620	1	1	1	1	1	1	1	1	1	1	100		
5621	1	1	1	1	1	1	1	1	1	1	100		
5622	1	1	1	1	1	1	1	1	1	1	100		
5623	1	1	1	1	1	1	1	1	1	1	100		
5624	1	1	1	1	1	1	1	1	1	1	100		
5625	1	1	1	1	1	1	1	1	1	1	100		
5626	1	1	1	1	1	1	1	1	1	1	100		
5627	1	1	1	1	1	1	1	1	1	1	100		
5628	1	1	1	1	1	1	1	1	1	1	100		
5629	1	1	1	1	1	1	1	1	1	1	100		
5630	1	1	1	1	1	1	1	1	1	1	100		
5631	1	1	1	1	1	1	1	1	1	1	100		
5632	1	1	1	1	1	1	1	1	1	1	100		
5633	1	1	1	1	1	1	1	1	1	1	100		
5634	1	1	1	1	1	1	1	1	1	1	100		
5635	1	1	1	1	1	1	1	1	1	1	100		
5636	1	1	1	1	1	1	1	1	1	1	100		
5637	1	1	1	1	1	1	1	1	1	1	100		
5638	1	1	1	1	1	1	1	1	1	1	100		
5639	1	1	1	1	1	1	1	1	1	1	100		
5640	1	1	1	1	1	1	1	1	1	1	100		
5641	1	1	1	1	1	1	1	1	1	1	100		
5642	1	1	1	1	1	1	1	1	1	1	100		
5643	1	1	1	1	1	1	1	1	1	1	100		
5644	1	1	1	1	1	1	1	1	1	1	100		
5645	1	1	1	1	1	1	1	1	1	1	100		
5646	1	1	1	1	1	1	1	1	1	1	100		
5647	1	1	1	1	1	1	1	1	1	1	100		
5648	1	1	1	1	1	1	1	1	1	1	100		
5649	1	1	1	1	1	1	1	1	1	1	100		
5650	0	0	0	0	0	0	0	0	0	0	0		

**USA Bin 1A Radar (cont)**





Radars Frequency	DFS Detection Trials (1=Detection, Blank= No Detection)										Detection Rate (%)	Detection Bandwidth (MHz)	Limit (MHz)
	1	2	3	4	5	6	7	8	9	10			
5490	1	0	0	1	0	1	1	0	0	0	40	158	156
5491	1	1	1	1	1	1	1	1	1	1	100		
5492	1	1	1	1	1	1	1	1	1	1	100		
5493	1	1	1	1	1	1	1	1	1	1	100		
5494	1	1	1	1	1	1	1	1	1	1	100		
5495	1	1	1	1	1	1	1	1	1	1	100		
5496	1	1	1	1	1	1	1	1	1	1	100		
5497	1	1	1	1	1	1	1	1	1	1	100		
5498	1	1	1	1	1	1	1	1	1	1	100		
5499	1	1	1	1	1	1	1	1	1	1	100		
5500	1	1	1	1	1	1	1	1	1	1	100		
5501	1	1	1	1	1	1	1	1	1	1	100		
5502	1	1	1	1	1	1	1	1	1	1	100		
5503	1	1	1	1	1	1	1	1	1	1	100		
5504	1	1	1	1	1	1	1	1	1	1	100		
5505	1	1	1	1	1	1	1	1	1	1	100		
5506	1	1	1	1	1	1	1	1	1	1	100		
5507	1	1	1	1	1	1	1	1	1	1	100		
5508	1	1	1	1	1	1	1	1	1	1	100		
5509	1	1	1	1	1	1	1	1	1	1	100		
5510	1	1	1	1	1	1	1	1	1	1	100		
5511	1	1	1	1	1	1	1	1	1	1	100		
5512	1	1	1	1	1	1	1	1	1	1	100		
5513	1	1	1	1	1	1	1	1	1	1	100		
5514	1	1	1	1	1	1	1	1	1	1	100		
5515	1	1	1	1	1	1	1	1	1	1	100		
5516	1	1	1	1	1	1	1	1	1	1	100		
5517	1	1	1	1	1	1	1	1	1	1	100		
5518	1	1	1	1	1	1	1	1	1	1	100		
5519	1	1	1	1	1	1	1	1	1	1	100		
5520	1	1	1	1	1	1	1	1	1	1	100		
5521	1	1	1	1	1	1	1	1	1	1	100		
5522	1	1	1	1	1	1	1	1	1	1	100		
5523	1	1	1	1	1	1	1	1	1	1	100		
5524	1	1	1	1	1	1	1	1	1	1	100		
5525	1	1	1	1	1	1	1	1	1	1	100		
5526	1	1	1	1	1	1	1	1	1	1	100		
5527	1	1	1	1	1	1	1	1	1	1	100		
5528	1	1	1	1	1	1	1	1	1	1	100		
5529	1	1	1	1	1	1	1	1	1	1	100		

**USA Bin 1B Radar**



Radars Frequency	DFS Detection Trials (1=Detection, Blank= No Detection)										Detection Rate (%)	Detection Bandwidth (MHz)	Limit (MHz)
	1	2	3	4	5	6	7	8	9	10			
5530	1	1	1	1	1	1	1	1	1	1	100	158	156
5531	1	1	1	1	1	1	1	1	1	1	100		
5532	1	1	1	1	1	1	1	1	1	1	100		
5533	1	1	1	1	1	1	1	1	1	1	100		
5534	1	1	1	1	1	1	1	1	1	1	100		
5535	1	1	1	1	1	1	1	1	1	1	100		
5536	1	1	1	1	1	1	1	1	1	1	100		
5537	1	1	1	1	1	1	1	1	1	1	100		
5538	1	1	1	1	1	1	1	1	1	1	100		
5539	1	1	1	1	1	1	1	1	1	1	100		
5540	1	1	1	1	1	1	1	1	1	1	100		
5541	1	1	1	1	1	1	1	1	1	1	100		
5542	1	1	1	1	1	1	1	1	1	1	100		
5543	1	1	1	1	1	1	1	1	1	1	100		
5544	1	1	1	1	1	1	1	1	1	1	100		
5545	1	1	1	1	1	1	1	1	1	1	100		
5546	1	1	1	1	1	1	1	1	1	1	100		
5547	1	1	1	1	1	1	1	1	1	1	100		
5548	1	1	1	1	1	1	1	1	1	1	100		
5549	1	1	1	1	1	1	1	1	1	1	100		
5550	1	1	1	1	1	1	1	1	1	1	100		
5551	1	1	1	1	1	1	1	1	1	1	100		
5552	1	1	1	1	1	1	1	1	1	1	100		
5553	1	1	1	1	1	1	1	1	1	1	100		
5554	1	1	1	1	1	1	1	1	1	1	100		
5555	1	1	1	1	1	1	1	1	1	1	100		
5556	1	1	1	1	1	1	1	1	1	1	100		
5557	1	1	1	1	1	1	1	1	1	1	100		
5558	1	1	1	1	1	1	1	1	1	1	100		
5559	1	1	1	1	1	1	1	1	1	1	100		
5560	1	1	1	1	1	1	1	1	1	1	100		
5561	1	1	1	1	1	1	1	1	1	1	100		
5562	1	1	1	1	1	1	1	1	1	1	100		
5563	1	1	1	1	1	1	1	1	1	1	100		
5564	1	1	1	1	1	1	1	1	1	1	100		
5565	1	1	1	1	1	1	1	1	1	1	100		
5566	1	1	1	1	1	1	1	1	1	1	100		
5567	1	1	1	1	1	1	1	1	1	1	100		
5568	1	1	1	1	1	1	1	1	1	1	100		
5569	1	1	1	1	1	1	1	1	1	1	100		

**USA Bin 1B Radar (cont)**



Radars Frequency	DFS Detection Trials (1=Detection, Blank= No Detection)										Detection Rate (%)	Detection Bandwidth (MHz)	Limit (MHz)
	1	2	3	4	5	6	7	8	9	10			
5570	1	1	1	1	1	1	1	1	1	1	100	158	156
5571	1	1	1	1	1	1	1	1	1	1	100		
5572	1	1	1	1	1	1	1	1	1	1	100		
5573	1	1	1	1	1	1	1	1	1	1	100		
5574	1	1	1	1	1	1	1	1	1	1	100		
5575	1	1	1	1	1	1	1	1	1	1	100		
5576	1	1	1	1	1	1	1	1	1	1	100		
5577	1	1	1	1	1	1	1	1	1	1	100		
5578	1	1	1	1	1	1	1	1	1	1	100		
5579	1	1	1	1	1	1	1	1	1	1	100		
5580	1	1	1	1	1	1	1	1	1	1	100		
5581	1	1	1	1	1	1	1	1	1	1	100		
5582	1	1	1	1	1	1	1	1	1	1	100		
5583	1	1	1	1	1	1	1	1	1	1	100		
5584	1	1	1	1	1	1	1	1	1	1	100		
5585	1	1	1	1	1	1	1	1	1	1	100		
5586	1	1	1	1	1	1	1	1	1	1	100		
5587	1	1	1	1	1	1	1	1	1	1	100		
5588	1	1	1	1	1	1	1	1	1	1	100		
5589	1	1	1	1	1	1	1	1	1	1	100		
5590	1	1	1	1	1	1	1	1	1	1	100		
5591	1	1	1	1	1	1	1	1	1	1	100		
5592	1	1	1	1	1	1	1	1	1	1	100		
5593	1	1	1	1	1	1	1	1	1	1	100		
5594	1	1	1	1	1	1	1	1	1	1	100		
5595	1	1	1	1	1	1	1	1	1	1	100		
5596	1	1	1	1	1	1	1	1	1	1	100		
5597	1	1	1	1	1	1	1	1	1	1	100		
5598	1	1	1	1	1	1	1	1	1	1	100		
5599	1	1	1	1	1	1	1	1	1	1	100		
5600	1	1	1	1	1	1	1	1	1	1	100		
5601	1	1	1	1	1	1	1	1	1	1	100		
5602	1	1	1	1	1	1	1	1	1	1	100		
5603	1	1	1	1	1	1	1	1	1	1	100		
5604	1	1	1	1	1	1	1	1	1	1	100		
5605	1	1	1	1	1	1	1	1	1	1	100		
5606	1	1	1	1	1	1	1	1	1	1	100		
5607	1	1	1	1	1	1	1	1	1	1	100		
5608	1	1	1	1	1	1	1	1	1	1	100		
5609	1	1	1	1	1	1	1	1	1	1	100		

**USA Bin 1B Radar (cont)**



Radars Frequency	DFS Detection Trials (1=Detection, Blank= No Detection)										Detection Rate (%)	Detection Bandwidth (MHz)	Limit (MHz)
	1	2	3	4	5	6	7	8	9	10			
5610	1	1	1	1	1	1	1	1	1	1	100	158	156
5611	1	1	1	1	1	1	1	1	1	1	100		
5612	1	1	1	1	1	1	1	1	1	1	100		
5613	1	1	1	1	1	1	1	1	1	1	100		
5614	1	1	1	1	1	1	1	1	1	1	100		
5615	1	1	1	1	1	1	1	1	1	1	100		
5616	1	1	1	1	1	1	1	1	1	1	100		
5617	1	1	1	1	1	1	1	1	1	1	100		
5618	1	1	1	1	1	1	1	1	1	1	100		
5619	1	1	1	1	1	1	1	1	1	1	100		
5620	1	1	1	1	1	1	1	1	1	1	100		
5621	1	1	1	1	1	1	1	1	1	1	100		
5622	1	1	1	1	1	1	1	1	1	1	100		
5623	1	1	1	1	1	1	1	1	1	1	100		
5624	1	1	1	1	1	1	1	1	1	1	100		
5625	1	1	1	1	1	1	1	1	1	1	100		
5626	1	1	1	1	1	1	1	1	1	1	100		
5627	1	1	1	1	1	1	1	1	1	1	100		
5628	1	1	1	1	1	1	1	1	1	1	100		
5629	1	1	1	1	1	1	1	1	1	1	100		
5630	1	1	1	1	1	1	1	1	1	1	100		
5631	1	1	1	1	1	1	1	1	1	1	100		
5632	1	1	1	1	1	1	1	1	1	1	100		
5633	1	1	1	1	1	1	1	1	1	1	100		
5634	1	1	1	1	1	1	1	1	1	1	100		
5635	1	1	1	1	1	1	1	1	1	1	100		
5636	1	1	1	1	1	1	1	1	1	1	100		
5637	1	1	1	1	1	1	1	1	1	1	100		
5638	1	1	1	1	1	1	1	1	1	1	100		
5639	1	1	1	1	1	1	1	1	1	1	100		
5640	1	1	1	1	1	1	1	1	1	1	100		
5641	1	1	1	1	1	1	1	1	1	1	100		
5642	1	1	1	1	1	1	1	1	1	1	100		
5643	1	1	1	1	1	1	1	1	1	1	100		
5644	1	1	1	1	1	1	1	1	1	1	100		
5645	1	1	1	1	1	1	1	1	1	1	100		
5646	1	1	1	1	1	1	1	1	1	1	100		
5647	1	1	1	1	1	1	1	1	1	1	100		
5648	1	1	1	1	1	1	1	1	1	1	100		
5649	1	1	1	1	1	1	1	1	1	1	100		
5650	0	1	0	0	0	0	0	0	1	0	20		

USA Bin 1B Radar (cont)



Radars Frequency	DFS Detection Trials (1=Detection, Blank= No Detection)										Detection Rate (%)	Detection Bandwidth (MHz)	Limit (MHz)
	1	2	3	4	5	6	7	8	9	10			
5490	0	0	0	0	0	0	0	0	0	0	0	156	156
5491	1	1	1	1	1	1	0	1	1	1	90		
5492	1	1	1	1	1	1	1	1	1	1	100		
5493	1	1	1	1	1	1	1	1	1	1	100		
5494	1	1	1	1	1	1	1	1	1	1	100		
5495	1	1	1	1	1	1	1	1	1	1	100		
5496	1	1	1	1	1	1	1	1	1	1	100		
5497	1	1	1	1	1	1	1	1	1	1	100		
5498	1	1	1	1	1	1	1	1	1	1	100		
5499	1	1	1	1	1	1	1	1	1	1	100		
5500	1	1	1	1	1	1	1	1	1	1	100		
5501	1	1	1	1	1	1	1	1	1	1	100		
5502	1	1	1	1	1	1	1	1	1	1	100		
5503	1	1	1	1	1	1	1	1	1	1	100		
5504	1	1	1	1	1	1	1	1	1	1	100		
5505	1	1	1	1	1	1	1	1	1	1	100		
5506	1	1	1	1	1	1	1	1	1	1	100		
5507	1	1	1	1	1	1	1	1	1	1	100		
5508	1	1	1	1	1	1	1	1	1	1	100		
5509	1	1	1	1	1	1	1	1	1	1	100		
5510	1	1	1	1	1	1	1	1	1	1	100		
5511	1	1	1	1	1	1	1	1	1	1	100		
5512	1	1	1	1	1	1	1	1	1	1	100		
5513	1	1	1	1	1	1	1	1	1	1	100		
5514	1	1	1	1	1	1	1	1	1	1	100		
5515	1	1	1	1	1	1	1	1	1	1	100		
5516	1	1	1	1	1	1	1	1	1	1	100		
5517	1	1	1	1	1	1	1	1	1	1	100		
5518	1	1	1	1	1	1	1	1	1	1	100		
5519	1	1	1	1	1	1	1	1	1	1	100		
5520	1	1	1	1	1	1	1	1	1	1	100		
5521	1	1	1	1	1	1	1	1	1	1	100		
5522	1	1	1	1	1	1	1	1	1	1	100		
5523	1	1	1	1	1	1	1	1	1	1	100		
5524	1	1	1	1	1	1	1	1	1	1	100		
5525	1	1	1	1	1	1	1	1	1	1	100		
5526	1	1	1	1	1	1	1	1	1	1	100		
5527	1	1	1	1	1	1	1	1	1	1	100		
5528	1	1	1	1	1	1	1	1	1	1	100		
5529	1	1	1	1	1	1	1	1	1	1	100		

**USA Bin 2 Radar**



Radars Frequency	DFS Detection Trials (1=Detection, Blank= No Detection)										Detection Rate (%)	Detection Bandwidth (MHz)	Limit (MHz)
	1	2	3	4	5	6	7	8	9	10			
5530	1	1	1	1	1	1	1	1	1	1	100	156	156
5531	1	1	1	1	1	1	1	1	1	1	100		
5532	1	1	1	1	1	1	1	1	1	1	100		
5533	1	1	1	1	1	1	1	1	1	1	100		
5534	1	1	1	1	1	1	1	1	1	1	100		
5535	1	1	1	1	1	1	1	1	1	1	100		
5536	1	1	1	1	1	1	1	1	1	1	100		
5537	1	1	1	1	1	1	1	1	1	1	100		
5538	1	1	1	1	1	1	1	1	1	1	100		
5539	1	1	1	1	1	1	1	1	1	1	100		
5540	1	1	1	1	1	1	1	1	1	1	100		
5541	1	1	1	1	1	1	1	1	1	1	100		
5542	1	1	1	1	1	1	1	1	1	1	100		
5543	1	1	1	1	1	1	1	1	1	1	100		
5544	1	1	1	1	1	1	1	1	1	1	100		
5545	1	1	1	1	1	1	1	1	1	1	100		
5546	1	1	1	1	1	1	1	1	1	1	100		
5547	1	1	1	1	1	1	1	1	1	1	100		
5548	1	1	1	1	1	1	1	1	1	1	100		
5549	1	1	1	1	1	1	1	1	1	1	100		
5550	1	1	1	1	1	1	1	1	1	1	100		
5551	1	1	1	1	1	1	1	1	1	1	100		
5552	1	1	1	1	1	1	1	1	1	1	100		
5553	1	1	1	1	1	1	1	1	1	1	100		
5554	1	1	1	1	1	1	1	1	1	1	100		
5555	1	1	1	1	1	1	1	1	1	1	100		
5556	1	1	1	1	1	1	1	1	1	1	100		
5557	1	1	1	1	1	1	1	1	1	1	100		
5558	1	1	1	1	1	1	1	1	1	1	100		
5559	1	1	1	1	1	1	1	1	1	1	100		
5560	1	1	1	1	1	1	1	1	1	1	100		
5561	1	1	1	1	1	1	1	1	1	1	100		
5562	1	1	1	1	1	1	1	1	1	1	100		
5563	1	1	1	1	1	1	1	1	1	1	100		
5564	1	1	1	1	1	1	1	1	1	1	100		
5565	1	1	1	1	1	1	1	1	1	1	100		
5566	1	1	1	1	1	1	1	1	1	1	100		
5567	1	1	1	1	1	1	1	1	1	1	100		
5568	1	1	1	1	1	1	1	1	1	1	100		
5569	1	1	1	1	1	1	1	1	1	1	100		

**USA Bin 2 Radar (cont)**



Radars Frequency	DFS Detection Trials (1=Detection, Blank= No Detection)										Detection Rate (%)	Detection Bandwidth (MHz)	Limit (MHz)
	1	2	3	4	5	6	7	8	9	10			
5570	1	1	1	1	1	1	1	1	1	1	100	156	156
5571	1	1	1	1	1	1	1	1	1	1	100		
5572	1	1	1	1	1	1	1	1	1	1	100		
5573	1	1	1	1	1	1	1	1	1	1	100		
5574	1	1	1	1	1	1	1	1	1	1	100		
5575	1	1	1	1	1	1	1	1	1	1	100		
5576	1	1	1	1	1	1	1	1	1	1	100		
5577	1	1	1	1	1	1	1	1	1	1	100		
5578	1	1	1	1	1	1	1	1	1	1	100		
5579	1	1	1	1	1	1	1	1	1	1	100		
5580	1	1	1	1	1	1	1	1	1	1	100		
5581	1	1	1	1	1	1	1	1	1	1	100		
5582	1	1	1	1	1	1	1	1	1	1	100		
5583	1	1	1	1	1	1	1	1	1	1	100		
5584	1	1	1	1	1	1	1	1	1	1	100		
5585	1	1	1	1	1	1	1	1	1	1	100		
5586	1	1	1	1	1	1	1	1	1	1	100		
5587	1	1	1	1	1	1	1	1	1	1	100		
5588	1	1	1	1	1	1	1	1	1	1	100		
5589	1	1	1	1	1	1	1	1	1	1	100		
5590	1	1	1	1	1	1	1	1	1	1	100		
5591	1	1	1	1	1	1	1	1	1	1	100		
5592	1	1	1	1	1	1	1	1	1	1	100		
5593	1	1	1	1	1	1	1	1	1	1	100		
5594	1	1	1	1	1	1	1	1	1	1	100		
5595	1	1	1	1	1	1	1	1	1	1	100		
5596	1	1	1	1	1	1	1	1	1	1	100		
5597	1	1	1	1	1	1	1	1	1	1	100		
5598	1	1	1	1	1	1	1	1	1	1	100		
5599	1	1	1	1	1	1	1	1	1	1	100		
5600	1	1	1	1	1	1	1	1	1	1	100		
5601	1	1	1	1	1	1	1	1	1	1	100		
5602	1	1	1	1	1	1	1	1	1	1	100		
5603	1	1	1	1	1	1	1	1	1	1	100		
5604	1	1	1	1	1	1	1	1	1	1	100		
5605	1	1	1	1	1	1	1	1	1	1	100		
5606	1	1	1	1	1	1	1	1	1	1	100		
5607	1	1	1	1	1	1	1	1	1	1	100		
5608	1	1	1	1	1	1	1	1	1	1	100		
5609	1	1	1	1	1	1	1	1	1	1	100		

**USA Bin 2 Radar (cont)**



Radars Frequency	DFS Detection Trials (1=Detection, Blank= No Detection)										Detection Rate (%)	Detection Bandwidth (MHz)	Limit (MHz)
	1	2	3	4	5	6	7	8	9	10			
5610	1	1	1	1	1	1	1	1	1	1	100	156	156
5611	1	1	1	1	1	1	1	1	1	1	100		
5612	1	1	1	1	1	1	1	1	1	1	100		
5613	1	1	1	1	1	1	1	1	1	1	100		
5614	1	1	1	1	1	1	1	1	1	1	100		
5615	1	1	1	1	1	1	1	1	1	1	100		
5616	1	1	1	1	1	1	1	1	1	1	100		
5617	1	1	1	1	1	1	1	1	1	1	100		
5618	1	1	1	1	1	1	1	1	1	1	100		
5619	1	1	1	1	1	1	1	1	1	1	100		
5620	1	1	1	1	1	1	1	1	1	1	100		
5621	1	1	1	1	1	1	1	1	1	1	100		
5622	1	1	1	1	1	1	1	1	1	1	100		
5623	1	1	1	1	1	1	1	1	1	1	100		
5624	1	1	1	1	1	1	1	1	1	1	100		
5625	1	1	1	1	1	1	1	1	1	1	100		
5626	1	1	1	1	1	1	1	1	1	1	100		
5627	1	1	1	1	1	1	1	1	1	1	100		
5628	1	1	1	1	1	1	1	1	1	1	100		
5629	1	1	1	1	1	1	1	1	1	1	100		
5630	1	1	1	1	1	1	1	1	1	1	100		
5631	1	1	1	1	1	1	1	1	1	1	100		
5632	1	1	1	1	1	1	1	1	1	1	100		
5633	1	1	1	1	1	1	1	1	1	1	100		
5634	1	1	1	1	1	1	1	1	1	1	100		
5635	1	1	1	1	1	1	1	1	1	1	100		
5636	1	1	1	1	1	1	1	1	1	1	100		
5637	1	1	1	1	1	1	1	1	1	1	100		
5638	1	1	1	1	1	1	1	1	1	1	100		
5639	1	1	1	1	1	1	1	1	1	1	100		
5640	1	1	1	1	1	1	1	1	1	1	100		
5641	1	1	1	1	1	1	1	1	1	1	100		
5642	1	1	1	1	1	1	1	1	1	1	100		
5643	1	1	1	1	1	1	1	1	1	1	100		
5644	1	1	1	1	1	1	1	1	1	1	100		
5645	1	1	1	1	1	1	1	1	1	1	100		
5646	1	1	1	1	1	1	1	1	1	1	100		
5647	1	1	1	1	1	1	1	1	1	1	100		
5648	1	1	1	1	1	1	1	1	1	1	100		
5649	1	1	0	1	1	1	0	0	1	0	60		
5650	0	0	0	0	0	0	0	0	0	0	0		

**USA Bin 2 Radar (cont)**





Radars Frequency	DFS Detection Trials (1=Detection, Blank= No Detection)										Detection Rate (%)	Detection Bandwidth (MHz)	Limit (MHz)
	1	2	3	4	5	6	7	8	9	10			
5490	0	0	0	0	0	0	0	0	0	0	0	156	156
5491	0	0	0	0	0	0	0	0	0	0	0		
5492	1	1	1	1	1	1	1	1	1	1	1		
5493	1	1	1	1	1	1	1	1	1	1	1		
5494	1	1	1	1	1	1	1	1	1	1	1		
5495	1	1	1	1	1	1	1	1	1	1	1		
5496	1	1	1	1	1	1	1	1	1	1	1		
5497	1	1	1	1	1	1	1	1	1	1	1		
5498	1	1	1	1	1	1	1	1	1	1	1		
5499	1	1	1	1	1	1	1	1	1	1	1		
5500	1	1	1	1	1	1	1	1	1	1	1		
5501	1	1	1	1	1	1	1	1	1	1	1		
5502	1	1	1	1	1	1	1	1	1	1	1		
5503	1	1	1	1	1	1	1	1	1	1	1		
5504	1	1	1	1	1	1	1	1	1	1	1		
5505	1	1	1	1	1	1	1	1	1	1	1		
5506	1	1	1	1	1	1	1	1	1	1	1		
5507	1	1	1	1	1	1	1	1	1	1	1		
5508	1	1	1	1	1	1	1	1	1	1	1		
5509	1	1	1	1	1	1	1	1	1	1	1		
5510	1	1	1	1	1	1	1	1	1	1	1		
5511	1	1	1	1	1	1	1	1	1	1	1		
5512	1	1	1	1	1	1	1	1	1	1	1		
5513	1	1	1	1	1	1	1	1	1	1	1		
5514	1	1	1	1	1	1	1	1	1	1	1		
5515	1	1	1	1	1	1	1	1	1	1	1		
5516	1	1	1	1	1	1	1	1	1	1	1		
5517	1	1	1	1	1	1	1	1	1	1	1		
5518	1	1	1	1	1	1	1	1	1	1	1		
5519	1	1	1	1	1	1	1	1	1	1	1		
5520	1	1	1	1	1	1	1	1	1	1	1		
5521	1	1	1	1	1	1	1	1	1	1	1		
5522	1	1	1	1	1	1	1	1	1	1	1		
5523	1	1	1	1	1	1	1	1	1	1	1		
5524	1	1	1	1	1	1	1	1	1	1	1		
5525	1	1	1	1	1	1	1	1	1	1	1		
5526	1	1	1	1	1	1	1	1	1	1	1		
5527	1	1	1	1	1	1	1	1	1	1	1		
5528	1	1	1	1	1	1	1	1	1	1	1		
5529	1	1	1	1	1	1	1	1	1	1	1		

**USA Bin 3 Radar**



Radar Frequency	DFS Detection Trials (1=Detection, Blank= No Detection)										Detection Rate (%)	Detection Bandwidth (MHz)	Limit (MHz)
	1	2	3	4	5	6	7	8	9	10			
5530	1	1	1	1	1	1	1	1	1	1	100	156	156
5531	1	1	1	1	1	1	1	1	1	1	100		
5532	1	1	1	1	1	1	1	1	1	1	100		
5533	1	1	1	1	1	1	1	1	1	1	100		
5534	1	1	1	1	1	1	1	1	1	1	100		
5535	1	1	1	1	1	1	1	1	1	1	100		
5536	1	1	1	1	1	1	1	1	1	1	100		
5537	1	1	1	1	1	1	1	1	1	1	100		
5538	1	1	1	1	1	1	1	1	1	1	100		
5539	1	1	1	1	1	1	1	1	1	1	100		
5540	1	1	1	1	1	1	1	1	1	1	100		
5541	1	1	1	1	1	1	1	1	1	1	100		
5542	1	1	1	1	1	1	1	1	1	1	100		
5543	1	1	1	1	1	1	1	1	1	1	100		
5544	1	1	1	1	1	1	1	1	1	1	100		
5545	1	1	1	1	1	1	1	1	1	1	100		
5546	1	1	1	1	1	1	1	1	1	1	100		
5547	1	1	1	1	1	1	1	1	1	1	100		
5548	1	1	1	1	1	1	1	1	1	1	100		
5549	1	1	1	1	1	1	1	1	1	1	100		
5550	1	1	1	1	1	1	1	1	1	1	100		
5551	1	1	1	1	1	1	1	1	1	1	100		
5552	1	1	1	1	1	1	1	1	1	1	100		
5553	1	1	1	1	1	1	1	1	1	1	100		
5554	1	1	1	1	1	1	1	1	1	1	100		
5555	1	1	1	1	1	1	1	1	1	1	100		
5556	1	1	1	1	1	1	1	1	1	1	100		
5557	1	1	1	1	1	1	1	1	1	1	100		
5558	1	1	1	1	1	1	1	1	1	1	100		
5559	1	1	1	1	1	1	1	1	1	1	100		
5560	1	1	1	1	1	1	1	1	1	1	100		
5561	1	1	1	1	1	1	1	1	1	1	100		
5562	1	1	1	1	1	1	1	1	1	1	100		
5563	1	1	1	1	1	1	1	1	1	1	100		
5564	1	1	1	1	1	1	1	1	1	1	100		
5565	1	1	1	1	1	1	1	1	1	1	100		
5566	1	0	1	1	1	1	1	1	1	1	90		
5567	1	1	1	1	1	1	1	1	1	1	100		
5568	1	1	1	1	1	1	1	1	1	1	100		
5569	1	1	1	1	1	1	1	1	1	1	100		

USA Bin 3 Radar (cont)



Radars Frequency	DFS Detection Trials (1=Detection, Blank= No Detection)										Detection Rate (%)	Detection Bandwidth (MHz)	Limit (MHz)
	1	2	3	4	5	6	7	8	9	10			
5570	1	1	1	1	1	1	1	1	1	1	100	156	156
5571	1	1	1	1	1	1	1	1	1	1	100		
5572	1	1	1	1	1	1	1	1	1	1	100		
5573	1	1	1	1	1	1	1	1	1	1	100		
5574	1	1	1	1	1	1	1	1	1	1	100		
5575	1	1	1	1	1	1	1	1	1	1	100		
5576	1	1	1	1	1	1	1	1	1	1	100		
5577	1	1	1	1	1	1	1	1	1	1	100		
5578	1	1	1	1	1	1	1	1	1	1	100		
5579	1	1	1	1	1	1	1	1	1	1	100		
5580	1	1	1	1	1	1	1	1	1	1	100		
5581	1	1	1	1	1	1	1	1	1	1	100		
5582	1	1	1	1	1	1	1	1	1	1	100		
5583	1	1	1	1	1	1	1	1	1	1	100		
5584	1	1	1	1	1	1	1	1	1	1	100		
5585	1	1	1	1	1	1	1	1	1	1	100		
5586	1	1	1	1	1	1	1	1	1	1	100		
5587	1	1	1	1	1	1	1	1	1	1	100		
5588	1	1	1	1	1	1	1	1	1	1	100		
5589	1	1	1	1	1	1	1	1	1	1	100		
5590	1	1	1	1	1	1	1	1	1	1	100		
5591	1	1	1	1	1	1	1	1	1	1	100		
5592	1	1	1	1	1	1	1	1	1	1	100		
5593	1	1	1	1	1	1	1	1	1	1	100		
5594	1	1	1	1	1	1	1	1	1	1	100		
5595	1	1	1	1	1	1	1	1	1	1	100		
5596	1	1	1	1	1	1	1	1	1	1	100		
5597	1	1	1	1	1	1	1	1	1	1	100		
5598	1	1	1	1	1	1	1	1	1	1	100		
5599	1	1	1	1	1	1	1	1	1	1	100		
5600	1	1	1	1	1	1	1	1	1	1	100		
5601	1	1	1	1	1	1	1	1	1	1	100		
5602	1	1	1	1	1	1	1	1	1	1	100		
5603	1	1	1	1	1	1	1	1	1	1	100		
5604	1	1	1	1	1	1	1	1	1	1	100		
5605	1	1	1	1	1	1	1	1	1	1	100		
5606	1	1	1	1	1	1	1	1	1	1	100		
5607	1	1	1	1	1	1	1	1	1	1	100		
5608	1	1	1	1	1	1	1	1	1	1	100		
5609	1	1	1	1	1	1	1	1	1	1	100		

**USA Bin 3 Radar (cont)**



Radars Frequency	DFS Detection Trials (1=Detection, Blank= No Detection)										Detection Rate (%)	Detection Bandwidth (MHz)	Limit (MHz)
	1	2	3	4	5	6	7	8	9	10			
5610	1	1	1	1	1	1	1	1	1	1	100	156	156
5611	1	1	1	1	1	1	1	1	1	1	100		
5612	1	1	1	1	1	1	1	1	1	1	100		
5613	1	1	1	1	1	1	1	1	1	1	100		
5614	1	1	1	1	1	1	1	1	1	1	100		
5615	1	1	1	1	1	1	1	1	1	1	100		
5616	1	1	1	1	1	1	1	1	1	1	100		
5617	1	1	1	1	1	1	1	1	1	1	100		
5618	1	1	1	1	1	1	1	1	1	1	100		
5619	1	1	1	1	1	1	1	1	1	1	100		
5620	1	1	1	1	1	1	1	1	1	1	100		
5621	1	1	1	1	1	1	1	1	1	1	100		
5622	1	1	1	1	1	1	1	1	1	1	100		
5623	1	1	1	1	1	1	1	1	1	1	100		
5624	1	1	1	1	1	1	1	1	1	1	100		
5625	1	1	1	1	1	1	1	1	1	1	100		
5626	1	1	1	1	1	1	1	1	1	1	100		
5627	1	1	1	1	1	1	1	1	1	1	100		
5628	1	1	1	1	1	1	1	1	1	1	100		
5629	1	1	1	1	1	1	1	1	1	1	100		
5630	1	1	1	1	1	1	1	1	1	1	100		
5631	1	1	1	1	1	1	1	1	1	1	100		
5632	1	1	1	1	1	1	1	1	1	1	100		
5633	1	1	1	1	1	1	1	1	1	1	100		
5634	1	1	1	1	1	1	1	1	1	1	100		
5635	1	1	1	1	1	1	1	1	1	1	100		
5636	1	1	1	1	1	1	1	1	1	1	100		
5637	1	1	1	1	1	1	1	1	1	1	100		
5638	1	1	1	1	1	1	1	1	1	1	100		
5639	1	1	1	1	1	1	1	1	1	1	100		
5640	1	1	1	1	1	1	1	1	1	1	100		
5641	1	1	1	1	1	1	1	1	1	1	100		
5642	1	1	1	1	1	1	1	1	1	1	100		
5643	1	1	1	1	1	1	1	1	1	1	100		
5644	1	1	1	1	1	1	1	1	1	1	100		
5645	1	1	1	1	1	1	1	1	1	1	100		
5646	1	1	1	1	1	1	1	1	1	1	100		
5647	1	1	1	1	1	1	1	1	1	1	100		
5648	1	1	1	1	1	1	1	1	1	1	100		
5649	0	0	0	0	0	0	0	0	0	0	0		
5650	0	0	0	0	0	0	0	0	0	0	0		

USA Bin 3 Radar (cont)



Radars Frequency	DFS Detection Trials (1=Detection, Blank= No Detection)										Detection Rate (%)	Detection Bandwidth (MHz)	Limit (MHz)
	1	2	3	4	5	6	7	8	9	10			
5490	0	0	0	0	0	0	0	0	0	0	0	156	156
5491	0	0	0	0	0	0	0	0	0	0	0		
5492	1	1	1	1	1	1	1	1	1	1	1		
5493	1	1	1	1	1	1	1	1	1	1	1		
5494	1	1	1	1	1	1	1	1	1	1	1		
5495	1	1	1	1	1	1	1	1	1	1	1		
5496	1	1	1	1	1	1	1	1	1	1	1		
5497	1	1	1	1	1	1	1	1	1	1	1		
5498	1	1	1	1	1	1	1	1	1	1	1		
5499	1	1	1	1	1	1	1	1	1	1	1		
5500	1	1	1	1	1	1	1	1	1	1	1		
5501	1	1	1	1	1	1	1	1	1	1	1		
5502	1	1	1	1	1	1	1	1	1	1	1		
5503	1	1	1	1	1	1	1	1	1	1	1		
5504	1	1	1	1	1	1	1	1	1	1	1		
5505	1	1	1	1	1	1	1	1	1	1	1		
5506	1	1	1	1	1	1	1	1	1	1	1		
5507	1	1	1	1	1	1	1	1	1	1	1		
5508	1	1	1	1	1	1	1	1	1	1	1		
5509	1	1	1	1	1	1	1	1	1	1	1		
5510	1	1	1	1	1	1	1	1	1	1	1		
5511	1	1	1	1	1	1	1	1	1	1	1		
5512	1	1	1	1	1	1	1	1	1	1	1		
5513	1	1	1	1	1	1	1	1	1	1	1		
5514	1	1	1	1	1	1	1	1	1	1	1		
5515	1	1	1	1	1	1	1	1	1	1	1		
5516	1	1	1	1	1	1	1	1	1	1	1		
5517	1	1	1	1	1	1	1	1	1	1	1		
5518	1	1	1	1	1	1	1	1	1	1	1		
5519	1	1	1	1	1	1	1	1	1	1	1		
5520	1	1	1	1	1	1	1	1	1	1	1		
5521	1	1	1	1	1	1	1	1	1	1	1		
5522	1	1	1	1	1	1	1	1	1	1	1		
5523	1	1	1	1	1	1	1	1	1	1	1		
5524	1	1	1	1	1	1	1	1	1	1	1		
5525	1	1	1	1	1	1	1	1	1	1	1		
5526	1	1	1	1	1	1	1	1	1	1	1		
5527	1	1	1	1	1	1	1	1	1	1	1		
5528	1	1	1	1	1	1	1	1	1	1	1		
5529	1	1	1	1	1	1	1	1	1	1	1		

**USA Bin 4 Radar**



Radars Frequency	DFS Detection Trials (1=Detection, Blank= No Detection)										Detection Rate (%)	Detection Bandwidth (MHz)	Limit (MHz)
	1	2	3	4	5	6	7	8	9	10			
5530	1	1	1	1	1	1	1	1	1	1	100	156	156
5531	1	1	1	1	1	1	1	1	1	1	100		
5532	1	1	1	1	1	1	1	1	1	1	100		
5533	1	1	1	1	1	1	1	1	1	1	100		
5534	1	1	1	1	1	1	1	1	1	1	100		
5535	1	1	1	1	1	1	1	1	1	1	100		
5536	1	1	1	1	1	1	1	1	1	1	100		
5537	1	1	1	1	1	1	1	1	1	1	100		
5538	1	1	1	1	1	1	1	1	1	1	100		
5539	1	1	1	1	1	1	1	1	1	1	100		
5540	1	1	1	1	1	1	1	1	1	1	100		
5541	1	1	1	1	1	1	1	1	1	1	100		
5542	1	1	1	1	1	1	1	1	1	1	100		
5543	1	1	1	1	1	1	1	1	1	1	100		
5544	1	1	1	1	1	1	1	1	1	1	100		
5545	1	1	1	1	1	1	1	1	1	1	100		
5546	1	1	1	1	1	1	1	1	1	1	100		
5547	1	1	1	1	1	1	1	1	1	1	100		
5548	1	1	1	1	1	1	1	1	1	1	100		
5549	1	1	1	1	1	1	1	1	1	1	100		
5550	1	1	1	1	1	1	1	1	1	1	100		
5551	1	1	1	1	1	1	1	1	1	1	100		
5552	1	1	1	1	1	1	1	1	1	1	100		
5553	1	1	1	1	1	1	1	1	1	1	100		
5554	1	1	1	1	1	1	1	1	1	1	100		
5555	1	1	1	1	1	1	1	1	1	1	100		
5556	1	1	1	1	1	1	1	1	1	1	100		
5557	1	1	1	1	1	1	1	1	1	1	100		
5558	1	1	1	0	1	1	1	1	1	1	90		
5559	1	1	1	1	1	1	1	1	1	1	100		
5560	1	1	1	1	1	1	1	1	1	1	100		
5561	1	1	1	1	1	1	1	1	1	1	100		
5562	1	1	1	1	1	1	1	1	1	1	100		
5563	1	1	1	1	1	1	1	1	1	1	100		
5564	1	1	1	1	1	1	1	1	1	1	100		
5565	1	1	1	1	1	1	1	1	1	1	100		
5566	1	1	1	1	1	1	1	1	1	1	100		
5567	1	1	1	1	1	1	1	1	1	1	100		
5568	1	1	1	1	1	1	1	1	1	1	100		
5569	1	1	1	1	1	1	1	1	1	1	100		

USA Bin 4 Radar (cont)



Radars Frequency	DFS Detection Trials (1=Detection, Blank= No Detection)										Detection Rate (%)	Detection Bandwidth (MHz)	Limit (MHz)
	1	2	3	4	5	6	7	8	9	10			
5570	1	1	1	1	1	1	1	1	1	1	100	156	156
5571	1	1	1	1	1	1	1	1	1	1	100		
5572	1	1	1	1	1	1	1	1	1	1	100		
5573	1	1	1	1	1	1	1	1	1	1	100		
5574	1	1	1	1	1	1	1	1	1	1	100		
5575	1	1	1	1	1	1	1	1	1	1	100		
5576	1	1	1	1	1	1	1	1	1	1	100		
5577	1	1	1	1	1	1	1	1	1	1	100		
5578	1	1	1	1	1	1	1	1	1	1	100		
5579	1	1	1	1	1	1	1	1	1	1	100		
5580	1	1	1	1	1	1	1	1	1	1	100		
5581	1	1	1	1	1	1	1	1	1	1	100		
5582	1	1	1	1	1	1	1	1	1	1	100		
5583	1	1	1	1	1	1	1	1	1	1	100		
5584	1	1	1	1	1	1	1	1	1	1	100		
5585	1	1	1	1	1	1	1	1	1	1	100		
5586	1	1	1	1	1	1	1	1	1	1	100		
5587	1	1	1	1	1	1	1	1	1	1	100		
5588	1	1	1	1	1	1	1	1	1	1	100		
5589	1	1	1	1	1	1	1	1	1	1	100		
5590	1	1	1	1	1	1	1	1	1	1	100		
5591	1	1	1	1	1	1	1	1	1	1	100		
5592	1	1	1	1	1	1	1	1	1	1	100		
5593	1	1	1	1	1	1	1	1	1	1	100		
5594	1	1	1	1	1	1	1	1	1	1	100		
5595	1	1	1	1	1	1	1	1	1	1	100		
5596	1	1	1	1	1	1	1	1	1	1	100		
5597	1	1	1	1	1	1	1	1	1	1	100		
5598	1	1	1	1	1	1	1	1	1	1	100		
5599	1	1	1	1	1	1	1	1	1	1	100		
5600	1	1	1	1	1	1	1	1	1	1	100		
5601	1	1	1	1	1	1	1	1	1	1	100		
5602	1	1	1	1	1	1	1	1	1	1	100		
5603	1	1	1	1	1	1	1	1	1	1	100		
5604	1	1	1	1	1	1	1	1	1	1	100		
5605	1	1	1	1	1	1	1	1	1	1	100		
5606	1	1	1	1	1	1	1	1	1	1	100		
5607	1	1	1	1	1	1	1	1	1	1	100		
5608	1	1	1	1	1	1	1	1	1	1	100		
5609	1	1	1	1	1	1	1	1	1	1	100		

**USA Bin 4 Radar (cont)**



Radars Frequency	DFS Detection Trials (1=Detection, Blank= No Detection)										Detection Rate (%)	Detection Bandwidth (MHz)	Limit (MHz)
	1	2	3	4	5	6	7	8	9	10			
5610	1	1	1	1	1	1	1	1	1	1	100	156	156
5611	1	1	1	1	1	1	1	1	1	1	100		
5612	1	1	1	1	1	1	1	1	1	1	100		
5613	1	1	1	1	1	1	1	1	1	1	100		
5614	1	1	1	1	1	1	1	1	1	1	100		
5615	1	1	1	1	1	1	1	1	1	1	100		
5616	1	1	1	1	1	1	1	1	1	1	100		
5617	1	1	1	1	1	1	1	1	1	1	100		
5618	1	1	1	1	1	1	1	1	1	1	100		
5619	1	1	1	1	1	1	1	1	1	1	100		
5620	1	1	1	1	1	1	1	1	1	1	100		
5621	1	1	1	1	1	1	1	1	1	1	100		
5622	1	1	1	1	1	1	1	1	1	1	100		
5623	1	1	1	1	1	1	1	1	1	1	100		
5624	1	1	1	1	1	1	1	1	1	1	100		
5625	1	1	1	1	1	1	1	1	1	1	100		
5626	1	1	1	1	1	1	1	1	1	1	100		
5627	1	1	1	1	1	1	1	1	1	1	100		
5628	1	1	1	1	1	1	1	1	1	1	100		
5629	1	1	1	1	1	1	1	1	1	1	100		
5630	1	1	1	1	1	1	1	1	1	1	100		
5631	1	1	1	1	1	1	1	1	1	1	100		
5632	1	1	1	1	1	1	1	1	1	1	100		
5633	1	1	1	1	1	1	1	1	1	1	100		
5634	1	1	1	1	1	1	1	1	1	1	100		
5635	1	1	1	1	1	1	1	1	1	1	100		
5636	1	1	1	1	1	1	1	1	1	1	100		
5637	1	1	1	1	1	1	1	1	1	1	100		
5638	1	1	1	1	1	1	1	1	1	1	100		
5639	1	1	1	1	1	1	1	1	1	1	100		
5640	1	1	1	1	1	1	1	1	1	1	100		
5641	1	1	1	1	1	1	1	1	1	1	100		
5642	1	1	1	1	1	1	1	1	1	1	100		
5643	1	1	1	1	1	1	1	1	1	1	100		
5644	1	1	1	1	1	1	1	1	1	1	100		
5645	1	1	1	1	1	1	1	1	1	1	100		
5646	1	1	1	1	1	1	1	1	1	1	100		
5647	1	1	1	1	1	1	1	1	1	1	100		
5648	1	1	1	1	1	1	1	1	1	1	100		
5649	0	0	0	0	0	0	0	0	0	0	0		
5650	0	0	0	0	0	0	0	0	0	0	0		

**USA Bin 4 Radar (cont)**





Radars Frequency	DFS Detection Trials (1=Detection, Blank= No Detection)										Detection Rate (%)	Detection Bandwidth (MHz)	Limit (MHz)
	1	2	3	4	5	6	7	8	9	10			
5490	1	1	1	1	1	1	1	1	1	1	100	160	156
5491	1	1	1	1	1	1	1	1	1	1	100		
5492	1	1	1	1	1	1	1	1	1	1	100		
5493	1	1	1	1	1	1	1	1	1	1	100		
5494	1	1	1	1	1	1	1	1	1	1	100		
5495	1	1	1	1	1	1	1	1	1	1	100		
5496	1	1	1	1	1	1	1	1	1	1	100		
5497	1	1	1	1	1	1	1	1	1	1	100		
5498	1	1	1	1	1	1	1	1	1	1	100		
5499	1	1	1	1	1	1	1	1	1	1	100		
5500	1	1	1	1	1	1	1	1	1	1	100		
5501	1	1	1	1	1	1	1	1	1	1	100		
5502	1	1	1	1	1	1	1	1	1	1	100		
5503	1	1	1	1	1	1	1	1	1	1	100		
5504	1	1	1	1	1	1	1	1	1	1	100		
5505	1	1	1	1	1	1	1	1	1	1	100		
5506	1	1	1	1	1	1	1	1	1	1	100		
5507	1	1	1	1	1	1	1	1	1	1	100		
5508	1	1	1	1	1	1	1	1	1	1	100		
5509	1	1	1	1	1	1	1	1	1	1	100		
5510	1	1	1	1	1	1	1	1	1	1	100		
5511	1	1	1	1	1	1	1	1	1	1	100		
5512	1	1	1	1	1	1	1	1	1	1	100		
5513	1	1	1	1	1	1	1	1	1	1	100		
5514	1	1	1	1	1	1	1	1	1	1	100		
5515	1	1	1	1	1	1	1	1	1	1	100		
5516	1	1	1	1	1	1	1	1	1	1	100		
5517	1	1	1	1	1	1	1	1	1	1	100		
5518	1	1	1	1	1	1	1	1	1	1	100		
5519	1	1	1	1	1	1	1	1	1	1	100		
5520	1	1	1	1	1	1	1	1	1	1	100		
5521	1	1	1	1	1	1	1	1	1	1	100		
5522	1	1	1	1	1	1	1	1	1	1	100		
5523	1	1	1	1	1	1	1	1	1	1	100		
5524	1	1	1	1	1	1	1	1	1	1	100		
5525	1	1	1	1	1	1	1	1	1	1	100		
5526	1	1	1	1	1	1	1	1	1	1	100		
5527	1	1	1	1	1	1	1	1	1	1	100		
5528	1	1	1	1	1	1	1	1	1	1	100		
5529	1	1	1	1	1	1	1	1	1	1	100		

**USA Bin 5 Radar**



Radars Frequency	DFS Detection Trials (1=Detection, Blank= No Detection)										Detection Rate (%)	Detection Bandwidth (MHz)	Limit (MHz)
	1	2	3	4	5	6	7	8	9	10			
5530	1	1	1	1	1	1	1	1	1	1	100	160	156
5531	1	1	1	1	1	1	1	1	1	1	100		
5532	1	1	1	1	1	1	1	1	1	1	100		
5533	1	1	1	1	1	1	1	1	1	1	100		
5534	1	1	1	1	1	1	1	1	1	1	100		
5535	1	1	1	1	1	1	1	1	1	1	100		
5536	1	1	1	1	1	1	1	1	1	1	100		
5537	1	1	1	1	1	1	1	1	1	1	100		
5538	1	1	1	1	1	1	1	1	1	1	100		
5539	1	1	1	1	1	1	1	1	1	1	100		
5540	1	1	1	1	1	1	1	1	1	1	100		
5541	1	1	1	1	1	1	1	1	1	1	100		
5542	1	1	1	1	1	1	1	1	1	1	100		
5543	1	1	1	1	1	1	1	1	1	1	100		
5544	1	1	1	1	1	1	1	1	1	1	100		
5545	1	1	1	1	1	1	1	1	1	1	100		
5546	1	1	1	1	1	1	1	1	1	1	100		
5547	1	1	1	1	1	1	1	1	1	1	100		
5548	1	1	1	1	1	1	1	1	1	1	100		
5549	1	1	1	1	1	1	1	1	1	1	100		
5550	1	1	1	1	1	1	1	1	1	1	100		
5551	1	1	1	1	1	1	1	1	1	1	100		
5552	1	1	1	1	1	1	1	1	1	1	100		
5553	1	1	1	1	1	1	1	1	1	1	100		
5554	1	1	1	1	1	1	1	1	1	1	100		
5555	1	1	1	1	1	1	1	1	1	1	100		
5556	1	1	1	1	1	1	1	1	1	1	100		
5557	1	1	1	1	1	1	1	1	1	1	100		
5558	1	1	1	1	1	1	1	1	1	1	100		
5559	1	1	1	1	1	1	1	1	1	1	100		
5560	1	1	1	1	1	1	1	1	1	1	100		
5561	1	1	1	1	1	1	1	1	1	1	100		
5562	1	1	1	1	1	1	1	1	1	1	100		
5563	1	1	1	1	1	1	1	1	1	1	100		
5564	1	1	1	1	1	1	1	1	1	1	100		
5565	1	1	1	1	1	1	1	1	1	1	100		
5566	1	1	1	1	1	1	1	1	1	1	100		
5567	1	1	1	1	1	1	1	1	1	1	100		
5568	1	1	1	1	1	1	1	1	1	1	100		
5569	1	1	1	1	1	1	1	1	1	1	100		

USA Bin 5 Radar (cont)



Radars Frequency	DFS Detection Trials (1=Detection, Blank= No Detection)										Detection Rate (%)	Detection Bandwidth (MHz)	Limit (MHz)
	1	2	3	4	5	6	7	8	9	10			
5570	1	1	1	1	1	1	1	1	1	1	100	160	156
5571	1	1	1	1	1	1	1	1	1	1	100		
5572	1	1	1	1	1	1	1	1	1	1	100		
5573	1	1	1	1	1	1	1	1	1	1	100		
5574	1	1	1	1	1	1	1	1	1	1	100		
5575	1	1	1	1	1	1	1	1	1	1	100		
5576	1	1	1	1	1	1	1	1	1	1	100		
5577	1	1	1	1	1	1	1	1	1	1	100		
5578	1	1	1	1	1	1	1	1	1	1	100		
5579	1	1	1	1	1	1	1	1	1	1	100		
5580	1	1	1	1	1	1	1	1	1	1	100		
5581	1	1	1	1	1	1	1	1	1	1	100		
5582	1	1	1	1	1	1	1	1	1	1	100		
5583	1	1	1	1	1	1	1	1	1	1	100		
5584	1	1	1	1	1	1	1	1	1	1	100		
5585	1	1	1	1	1	1	1	1	1	1	100		
5586	1	1	1	1	1	1	1	1	1	1	100		
5587	1	1	1	1	1	1	1	1	1	1	100		
5588	1	1	1	1	1	1	1	1	1	1	100		
5589	1	1	1	1	1	1	1	1	1	1	100		
5590	1	1	1	1	1	1	1	1	1	1	100		
5591	1	1	1	1	1	1	1	1	1	1	100		
5592	1	1	1	1	1	1	1	1	1	1	100		
5593	1	1	1	1	1	1	1	1	1	1	100		
5594	1	1	1	1	1	1	1	1	1	1	100		
5595	1	1	1	1	1	1	1	1	1	1	100		
5596	1	1	1	1	1	1	1	1	1	1	100		
5597	1	1	1	1	1	1	1	1	1	1	100		
5598	1	1	1	1	1	1	1	1	1	1	100		
5599	1	1	1	1	1	1	1	1	1	1	100		
5600	1	1	1	1	1	1	1	1	1	1	100		
5601	1	1	1	1	1	1	1	1	1	1	100		
5602	1	1	1	1	1	1	1	1	1	1	100		
5603	1	1	1	1	1	1	1	1	1	1	100		
5604	1	1	1	1	1	1	1	1	1	1	100		
5605	1	1	1	1	1	1	1	1	1	1	100		
5606	1	1	1	1	1	1	1	1	1	1	100		
5607	1	1	1	1	1	1	1	1	1	1	100		
5608	1	1	1	1	1	1	1	1	1	1	100		
5609	1	1	1	1	1	1	1	1	1	1	100		

USA Bin 5 Radar (cont)



Radars Frequency	DFS Detection Trials (1=Detection, Blank= No Detection)										Detection Rate (%)	Detection Bandwidth (MHz)	Limit (MHz)
	1	2	3	4	5	6	7	8	9	10			
5610	1	1	1	1	1	1	1	1	1	1	100	160	156
5611	1	1	1	1	1	1	1	1	1	1	100		
5612	1	1	1	1	1	1	1	1	1	1	100		
5613	1	1	1	1	1	1	1	1	1	1	100		
5614	1	1	1	1	1	1	1	1	1	1	100		
5615	1	1	1	1	1	1	1	1	1	1	100		
5616	1	1	1	1	1	1	1	1	1	1	100		
5617	1	1	1	1	1	1	1	1	1	1	100		
5618	1	1	1	1	1	1	1	1	1	1	100		
5619	1	1	1	1	1	1	1	1	1	1	100		
5620	1	1	1	1	1	1	1	1	1	1	100		
5621	1	1	1	1	1	1	1	1	1	1	100		
5622	1	1	1	1	1	1	1	1	1	1	100		
5623	1	1	1	1	1	1	1	1	1	1	100		
5624	1	1	1	1	1	1	1	1	1	1	100		
5625	1	1	1	1	1	1	1	1	1	1	100		
5626	1	1	1	1	1	1	1	1	1	1	100		
5627	1	1	1	1	1	1	1	1	1	1	100		
5628	1	1	1	1	1	1	1	1	1	1	100		
5629	1	1	1	1	1	1	1	1	1	1	100		
5630	1	1	1	1	1	1	1	1	1	1	100		
5631	1	1	1	1	1	1	1	1	1	1	100		
5632	1	1	1	1	1	1	1	1	1	1	100		
5633	1	1	1	1	1	1	1	1	1	1	100		
5634	1	1	1	1	1	1	1	1	1	1	100		
5635	1	1	1	1	1	1	1	1	1	1	100		
5636	1	1	1	1	1	1	1	1	1	1	100		
5637	1	1	1	1	1	1	1	1	1	1	100		
5638	1	1	1	1	1	1	1	1	1	1	100		
5639	1	1	1	1	1	1	1	1	1	1	100		
5640	1	1	1	1	1	1	1	1	1	1	100		
5641	1	1	1	1	1	1	1	1	1	1	100		
5642	1	1	1	1	1	1	1	1	1	1	100		
5643	1	1	1	1	1	1	1	1	1	1	100		
5644	1	1	1	1	1	1	1	1	1	1	100		
5645	1	1	1	1	1	1	1	1	1	1	100		
5646	1	1	1	1	1	1	1	1	1	1	100		
5647	1	1	1	1	1	1	1	1	1	1	100		
5648	1	1	1	1	1	1	1	1	1	1	100		
5649	1	1	1	1	1	1	1	1	1	1	100		
5650	1	1	1	1	1	1	1	1	1	1	100		

USA Bin 5 Radar (cont)



Radars Frequency	DFS Detection Trials (1=Detection, Blank= No Detection)										Detection Rate (%)	Detection Bandwidth (MHz)	Limit (MHz)
	1	2	3	4	5	6	7	8	9	10			
5490	0	0	0	0	0	0	0	0	0	0	0	156	156
5491	1	1	0	1	0	0	1	1	1	1	70		
5492	1	1	1	1	1	1	1	1	1	1	100		
5493	1	1	1	1	1	1	1	1	1	1	100		
5494	1	1	1	1	1	1	1	1	1	1	100		
5495	1	1	1	1	1	1	1	1	1	1	100		
5496	1	1	1	1	1	1	1	1	1	1	100		
5497	1	1	0	1	1	1	1	1	1	1	90		
5498	1	1	0	1	1	1	1	1	1	1	90		
5499	1	1	1	1	1	1	1	1	1	1	100		
5500	1	1	1	1	1	1	1	1	1	1	100		
5501	1	1	1	1	1	1	1	1	1	1	100		
5502	1	1	1	1	1	1	1	1	1	1	100		
5503	1	1	1	0	1	1	1	1	1	1	90		
5504	1	1	1	1	1	1	1	1	1	1	100		
5505	1	1	1	1	1	1	1	1	1	1	100		
5506	1	1	1	1	1	1	1	1	1	1	100		
5507	1	1	1	1	1	1	1	1	1	1	100		
5508	1	1	1	1	1	1	1	1	1	1	100		
5509	1	1	1	1	1	1	1	1	1	1	100		
5510	1	1	1	1	1	1	1	1	1	1	100		
5511	1	1	1	1	1	1	1	1	1	1	100		
5512	1	1	1	1	1	1	1	1	1	1	100		
5513	1	1	1	1	1	1	1	1	1	1	100		
5514	1	1	1	1	1	1	1	1	1	1	100		
5515	1	1	1	1	1	1	1	1	1	1	100		
5516	1	1	1	1	1	1	1	1	1	1	100		
5517	1	1	1	1	1	1	1	1	1	1	100		
5518	1	1	1	1	1	1	1	1	1	1	100		
5519	1	1	1	1	1	1	1	1	1	1	100		
5520	1	1	1	1	1	1	1	1	1	1	100		
5521	1	1	1	1	1	1	1	1	1	1	100		
5522	1	1	1	1	1	1	1	1	1	1	100		
5523	1	1	1	1	1	1	1	1	1	1	100		
5524	1	1	1	1	1	1	1	1	1	1	100		
5525	1	1	1	1	1	1	1	1	1	1	100		
5526	1	1	1	1	1	1	1	1	1	1	100		
5527	1	1	1	1	1	1	1	1	1	1	100		
5528	1	1	1	1	1	1	1	1	1	1	100		
5529	1	1	1	1	1	1	1	1	1	1	100		

**USA Frequency Hopping Radar**



Radar Frequency	DFS Detection Trials (1=Detection, Blank= No Detection)										Detection Rate (%)	Detection Bandwidth (MHz)	Limit (MHz)
	1	2	3	4	5	6	7	8	9	10			
5530	1	1	1	1	1	1	1	1	1	1	100	156	156
5531	1	1	1	1	1	1	1	1	1	1	100		
5532	1	1	1	1	1	1	1	1	1	1	100		
5533	1	1	1	1	1	1	1	1	1	1	100		
5534	1	1	1	1	1	1	1	1	1	1	100		
5535	1	1	1	1	1	1	1	1	1	1	100		
5536	1	1	1	1	1	1	1	1	1	1	100		
5537	1	1	1	1	1	1	1	1	1	1	100		
5538	1	1	1	1	1	1	1	1	1	1	100		
5539	1	1	1	1	1	1	1	1	1	1	100		
5540	1	1	1	1	1	1	1	1	1	1	100		
5541	1	1	1	1	1	1	1	1	1	1	100		
5542	1	1	1	1	1	1	1	1	1	1	100		
5543	1	1	1	1	1	1	1	1	1	1	100		
5544	1	1	1	1	1	1	1	1	1	1	100		
5545	1	1	1	1	1	1	1	1	1	1	100		
5546	1	1	1	1	1	1	1	1	1	1	100		
5547	1	1	1	1	1	1	1	1	1	1	100		
5548	1	1	1	1	1	1	1	1	1	1	100		
5549	1	1	1	1	1	1	1	1	1	1	100		
5550	1	1	1	1	1	1	1	1	1	1	100		
5551	1	1	1	1	1	1	1	1	1	1	100		
5552	1	1	1	1	1	1	1	1	1	1	100		
5553	1	1	1	1	1	1	1	1	1	1	100		
5554	1	1	1	1	1	1	1	1	1	1	100		
5555	1	1	1	1	1	1	1	1	1	1	100		
5556	1	1	1	1	1	1	1	1	1	1	100		
5557	1	1	1	1	1	1	1	1	1	1	100		
5558	1	1	1	1	1	1	1	1	1	1	100		
5559	1	1	1	1	1	1	1	1	1	1	100		
5560	1	1	1	1	1	1	1	1	1	1	100		
5561	1	1	1	1	1	1	1	1	1	1	100		
5562	1	1	1	1	1	1	1	1	1	1	100		
5563	1	1	1	1	1	1	1	1	1	1	100		
5564	1	1	1	1	1	1	1	1	1	1	100		
5565	1	1	1	1	1	1	1	1	1	1	100		
5566	1	1	1	1	1	1	1	1	1	1	100		
5567	1	1	1	1	1	1	1	1	1	1	100		
5568	1	1	1	1	1	1	1	1	1	1	100		
5569	1	1	1	1	1	1	1	1	1	1	100		

**USA Frequency Hopping Radar (cont)**



Radars Frequency	DFS Detection Trials (1=Detection, Blank= No Detection)										Detection Rate (%)	Detection Bandwidth (MHz)	Limit (MHz)
	1	2	3	4	5	6	7	8	9	10			
5570	1	1	1	1	1	1	1	1	1	1	100	156	156
5571	1	1	1	1	1	1	1	1	1	1	100		
5572	1	1	1	1	1	1	1	1	1	1	100		
5573	1	1	1	1	1	1	1	1	1	1	100		
5574	1	1	1	1	1	1	1	1	1	1	100		
5575	1	1	1	1	1	1	1	1	1	1	100		
5576	1	1	1	1	1	1	1	1	1	1	100		
5577	1	1	1	1	1	1	1	1	1	1	100		
5578	1	1	1	1	1	1	1	1	1	1	100		
5579	1	1	1	1	1	1	1	1	1	1	100		
5580	1	1	1	1	1	1	1	1	1	1	100		
5581	1	1	1	1	1	1	1	1	1	1	100		
5582	1	1	1	1	1	1	1	1	1	1	100		
5583	1	1	1	1	1	1	1	1	1	1	100		
5584	1	1	1	1	1	1	1	1	1	1	100		
5585	1	1	1	1	1	1	1	1	1	1	100		
5586	1	1	1	1	1	1	1	1	1	1	100		
5587	1	1	1	1	1	1	1	1	1	1	100		
5588	1	1	1	1	1	1	1	1	1	1	100		
5589	1	1	1	1	1	1	1	1	1	1	100		
5590	1	1	1	1	1	1	1	1	1	1	100		
5591	1	1	1	1	1	1	1	1	1	1	100		
5592	1	1	1	1	1	1	1	1	1	1	100		
5593	1	1	1	1	1	1	1	1	1	1	100		
5594	1	1	1	1	1	1	1	1	1	1	100		
5595	1	1	1	1	1	1	1	1	1	1	100		
5596	1	1	1	1	1	1	1	1	1	1	100		
5597	1	1	1	1	1	1	1	1	1	1	100		
5598	1	1	1	1	1	1	1	1	1	1	100		
5599	1	1	1	1	1	1	1	1	1	1	100		
5600	1	1	1	1	1	1	1	1	1	1	100		
5601	1	1	1	1	1	1	1	1	1	1	100		
5602	1	1	1	1	1	1	1	1	1	1	100		
5603	1	1	1	1	1	1	1	1	1	1	100		
5604	1	1	1	1	1	1	1	1	1	1	100		
5605	1	1	1	1	1	1	1	1	1	1	100		
5606	1	1	1	1	1	1	1	1	1	1	100		
5607	1	1	1	1	1	1	1	1	1	1	100		
5608	1	1	1	1	1	1	1	1	1	1	100		
5609	1	1	1	1	1	1	1	1	1	1	100		

**USA Frequency Hopping Radar (cont)**



Radars Frequency	DFS Detection Trials (1=Detection, Blank= No Detection)										Detection Rate (%)	Detection Bandwidth (MHz)	Limit (MHz)
	1	2	3	4	5	6	7	8	9	10			
5610	1	1	1	1	1	1	1	1	1	1	100	156	156
5611	1	1	1	1	1	1	1	1	1	1	100		
5612	1	1	1	1	1	1	1	1	1	1	100		
5613	1	1	1	1	1	1	1	1	1	1	100		
5614	1	1	1	1	1	1	1	1	1	1	100		
5615	1	1	1	1	1	1	1	1	1	1	100		
5616	1	1	1	1	1	1	1	1	1	1	100		
5617	1	1	1	1	1	1	1	1	1	1	100		
5618	1	1	1	1	1	1	1	1	1	1	100		
5619	1	1	1	1	1	1	1	1	1	1	100		
5620	1	1	1	1	1	1	1	1	1	1	100		
5621	1	1	1	1	1	1	1	1	1	1	100		
5622	1	1	1	1	1	1	1	1	1	1	100		
5623	1	1	1	1	1	1	1	1	1	1	100		
5624	1	1	1	1	1	1	1	1	1	1	100		
5625	1	1	1	1	1	1	1	1	1	1	100		
5626	1	1	1	1	1	1	1	1	1	1	100		
5627	1	1	1	1	1	1	1	1	1	1	100		
5628	1	1	1	1	1	1	1	1	1	1	100		
5629	1	1	1	1	1	1	1	1	1	1	100		
5630	1	1	1	1	1	1	1	1	1	1	100		
5631	1	1	1	1	1	1	1	1	1	1	100		
5632	1	1	1	1	1	1	1	1	1	1	100		
5633	1	1	1	1	1	1	1	1	1	1	100		
5634	1	1	1	1	1	1	1	1	1	1	100		
5635	1	1	1	1	1	1	1	1	1	1	100		
5636	1	1	1	1	1	1	1	1	1	1	100		
5637	1	1	1	1	1	1	1	1	1	1	100		
5638	1	1	1	0	1	1	1	1	1	1	90		
5639	1	1	1	1	1	1	1	1	1	1	100		
5640	1	1	1	1	1	1	1	1	1	1	100		
5641	1	1	1	1	1	1	1	1	1	1	100		
5642	1	1	1	1	1	1	0	1	1	1	90		
5643	1	1	1	1	1	1	0	1	1	1	90		
5644	1	1	1	1	1	1	1	1	1	1	100		
5645	1	1	1	1	1	1	1	1	1	1	100		
5646	1	1	1	1	1	1	1	1	1	1	100		
5647	1	1	1	1	1	0	1	1	1	1	90		
5648	1	1	1	1	1	1	1	1	1	1	100		
5649	1	1	1	1	0	0	1	0	1	1	70		
5650	0	0	0	0	0	0	0	0	0	0	0		

**USA Frequency Hopping Radar (cont)**





### B.3 Initial Channel Availability Check Time

The tests that the UUT does not emit beacon, control, or data signals on the test Channel until the power-up sequence has been completed and the U-NII device checks for Radar Waveforms for one minute on the test Channel. This test does not use any Radar Waveforms.

The U-NII device is powered on and instructed to operate at 5500 MHz. At the same time the UUT is powered on, the spectrum analyzer is set to zero span mode with a 3 MHz resolution bandwidth at 5500MHz with a 2.5 minute sweep time. The analyzer's sweep will be started the same time power is applied to the U-NII device.

The UUT should not transmit any beacon or data transmissions until at least 1 minute after the completion of the power-on cycle.

The initial power up time of the UUT is indicated by marker 1 in the plot. Initial beacons/data transmissions are indicated by marker 2.

#### Initial Channel Availability Check Time

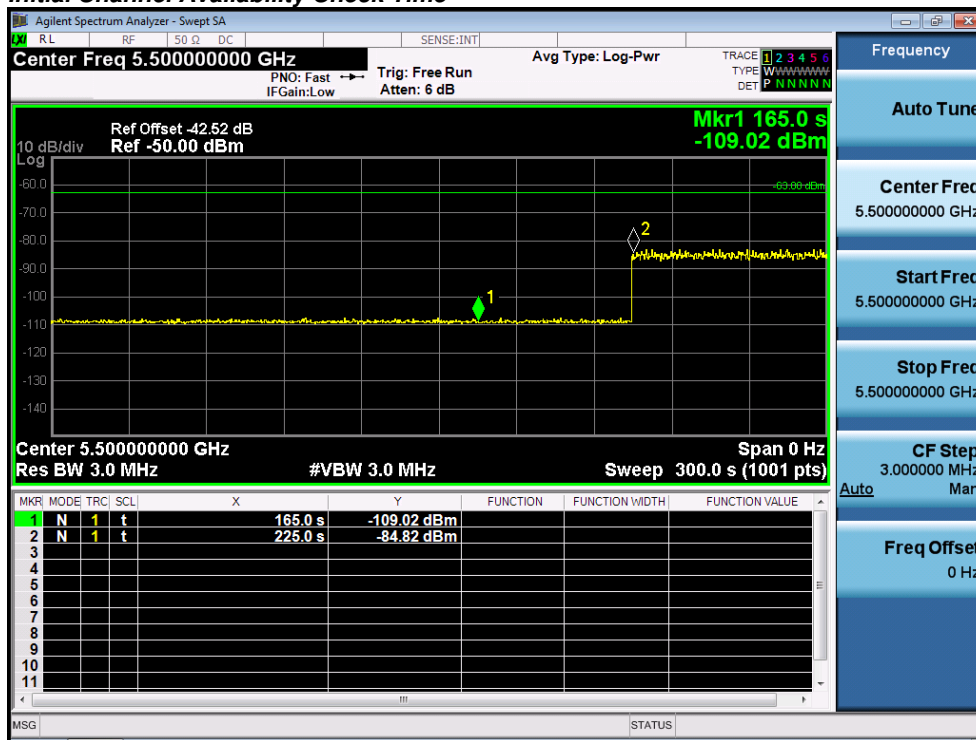



**B.4 Radar Burst at the Beginning of the Channel Availability Check Time**

The steps below define the procedure to verify successful radar detection on the selected Channel during a period equal to the Channel Availability Check Time and avoidance of operation on that Channel when a radar Burst with a level equal to the DFS Detection Threshold + 1 dB (-63dBm) occurs at the beginning of the Channel Availability Check Time.

The UUT is powered on at  $T_0$ .  $T_1$  denotes the instant when the UUT has completed its power-up sequence. The Channel Availability Check Time commences at instant  $T_1$  and will end no sooner than  $T_1 + 60$  seconds.

A single Burst of short pulse of radar type 0 at -63 dBm will commence within a 6 second window starting at  $T_1$ .

Visual indication on the UUT of successful detection of the radar Burst will be recorded and reported. Observation of emissions at 5500MHz will continue for 2.5 minutes after the radar Burst has been generated.

Verify that during the 2.5 minute measurement window no UUT transmissions occurred at 5500MHz.

**Radar Burst at the Beginning of the Channel Availability Check Time**

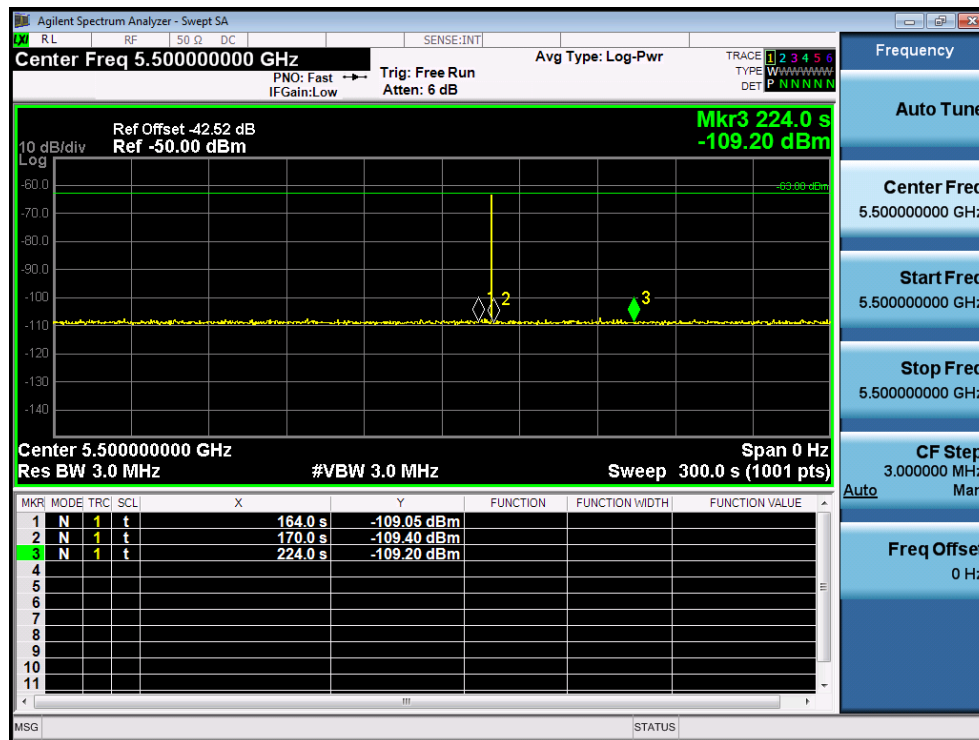



### B.5 Radar Burst at the End of the Channel Availability Check Time

The steps below define the procedure to verify successful radar detection on the selected Channel during a period equal to the Channel Availability Check Time and avoidance of operation on that Channel when a radar Burst with a level equal to the DFS Detection Threshold + 1 dB (-63dBm) occurs at the end of the Channel Availability Check Time.

The UUT is powered on at  $T_0$ .  $T_1$  denotes the instant when the UUT has completed its power-up sequence. The Channel Availability Check Time commences at instant  $T_1$  and will end no sooner than  $T_1 + 60$  seconds.

A single Burst of short pulse of radar type 0 at -63 dBm will commence within a 6 second window starting at  $T_1 + 54$  seconds.

Visual indication on the UUT of successful detection of the radar Burst will be recorded and reported. Observation of emissions at 5500MHz will continue for 2.5 minutes after the radar Burst has been generated.

Verify that during the 2.5 minute measurement window no UUT transmissions occurred at 5500MHz.

#### Radar Burst at the End of the Channel Availability Check Time

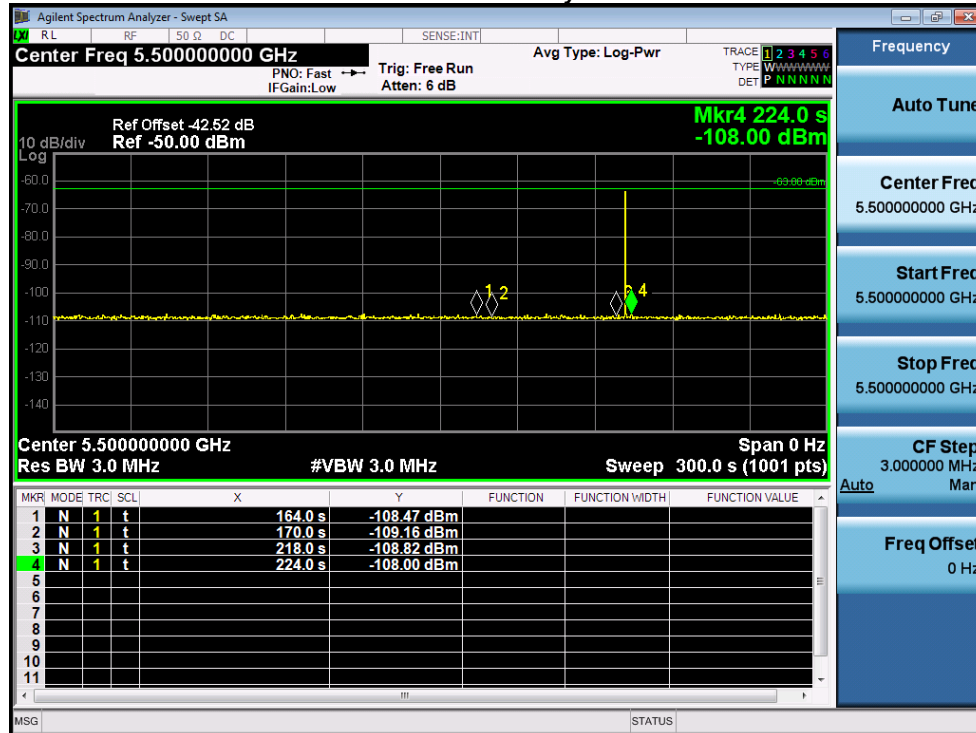



### B.6 In-Service Monitoring for Channel Move Time, Channel Closing Transmission Time and Non-Occupancy Period

These tests define how the following DFS parameters are verified during In-Service Monitoring; Channel Closing Transmission Time, Channel Move Time, and Non-Occupancy Period.

The steps below define the procedure to determine the above mentioned parameters when a radar Burst with a level equal to the DFS Detection Threshold + 1dB (-63dBm) is generated on the Operating Channel of the U-NII device.

A U-NII device operating as a Client Device will associate with the UUT (Master) at 5500 MHz. Stream the MPEG test file from the Master Device to the Client Device on the selected Channel for the entire period of the test.

At time  $T_0$  the Radar Waveform generator sends a Burst of pulses for radar type 0 at -63dBm.

Observe the transmissions of the UUT at the end of the radar Burst on the Operating Channel for duration greater than 10 seconds. Measure and record the transmissions from the UUT during the observation time (Channel Move Time). Compare the Channel Move Time and Channel Closing Transmission Time results to the limits defined in the *DFS Response requirement values table*.

**The following plot demonstrates a channel close time of 50ms, with an aggregate of no more than 60 ms. Type 0 radar was used for this data.**

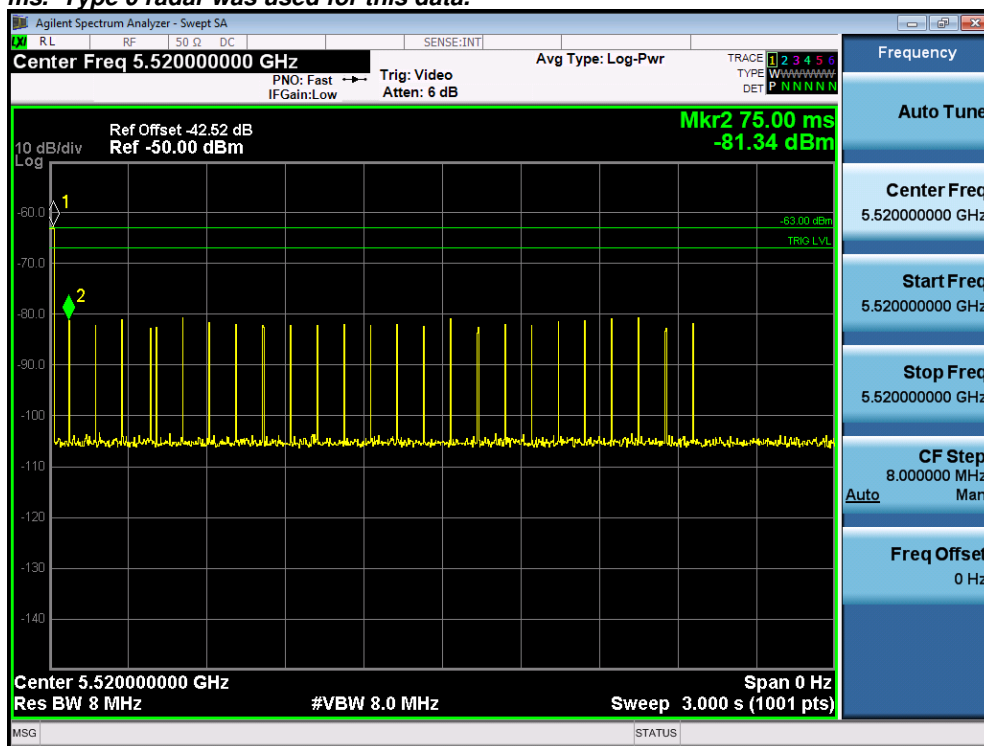



### Channel Move Time, Channel Closing Transmission Time for USA Bin 0

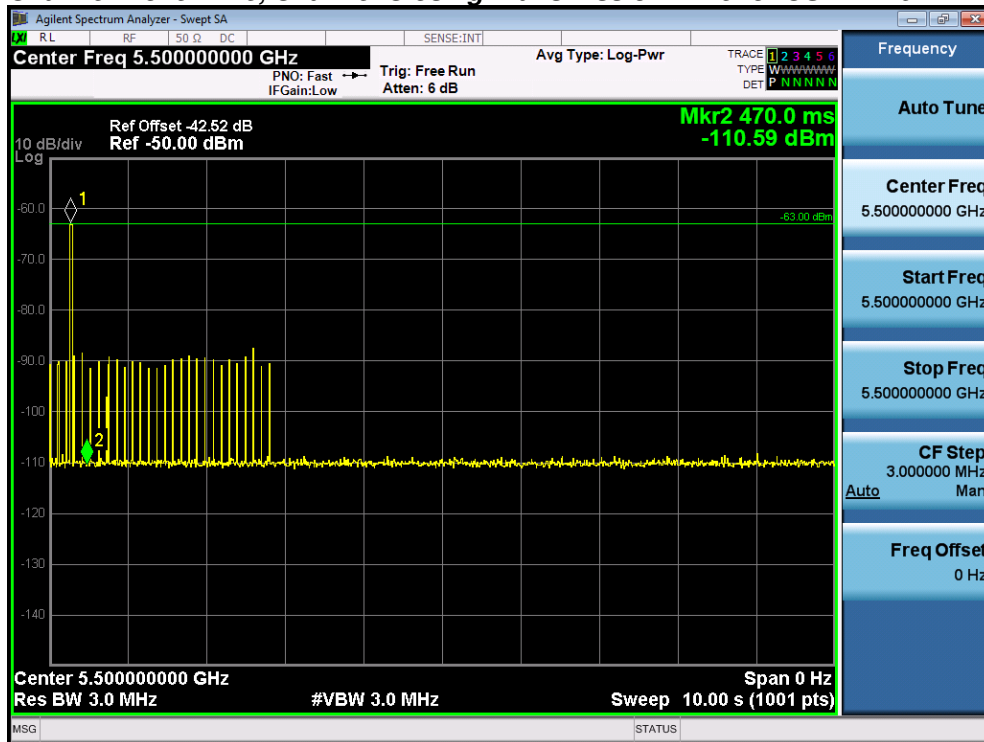



Measure the UUT for more than 30 minutes following the channel close/move time to verify that the UUT does not resume any transmissions on this Channel.

**30 Minute Non-Occupancy Period (using Type 0 radar)**

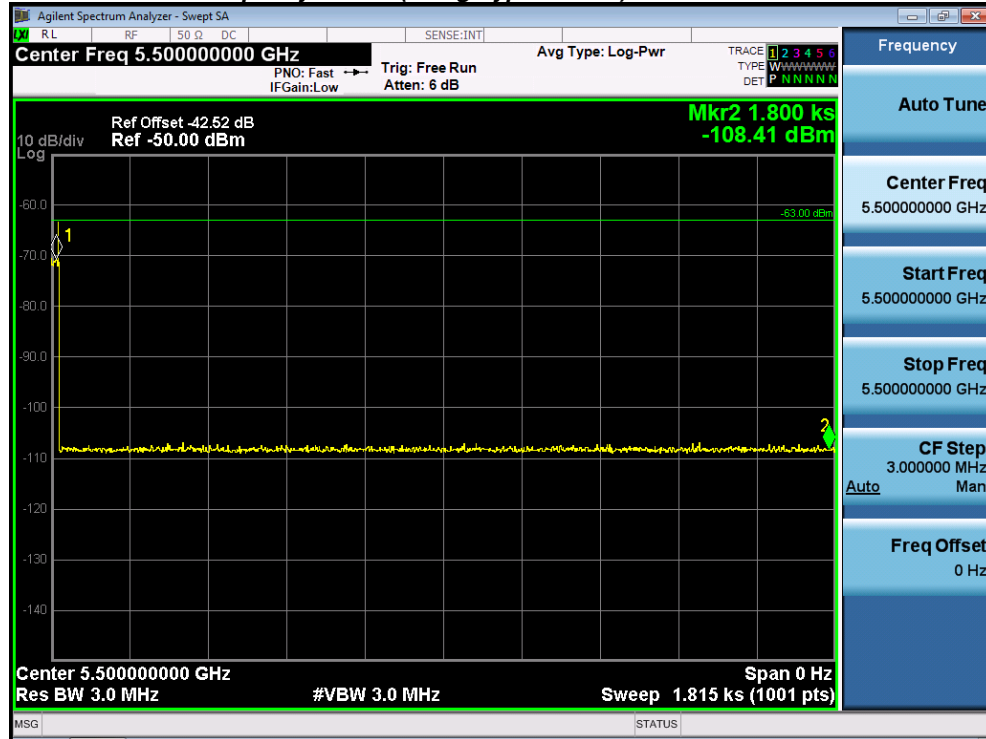

## B.7 Statistical Performance Check

The steps below define the procedure to determine the minimum percentage of detection when a radar burst with a level equal to the DFS Detection Threshold + 1 dB (-63dBm) is generated on the Operating Channel of the U-NII device.

A U-NII device operating as a Client Device will associate with the UUT (Master) at 5500 MHz. Stream the MPEG test file from the Master Device to the Client Device on the selected Channel for the entire period of the test.

The Radar Waveform generator sends the individual waveform for each of the radar types 1-6 at -63dbm. Statistical data will be gathered to determine the ability of the device to detect the radar test waveforms. The device can utilize a test mode to demonstrate when detection occurs to prevent the need to reset the device between trial runs. The percentage of successful detection is calculated by:

$$\frac{\textit{TotalWaveformDetections}}{\textit{TotalWaveformTrials}} \times 100 = \text{Probability of Detection Radar Waveform}$$

The Minimum number of trails, minimum percentage of successful detection and the average minimum percentage of successful detection are found in the *Radar Test Waveforms* section. The data represents the worst case detection for 20 MHz, 40 MHz, and 80 MHz signal bandwidths.



**USA Bin 1A/1B Radar Statistical Performance**

Trial #	Pulses	PW	PRI	1=Detection 0=No Detection	Detection Percentage	Limit
1	78	1	678	1	100.0%	60.0%
2	95	1	558	1		
3	72	1	738	1		
4	76	1	698	1		
5	67	1	798	1		
6	62	1	858	1		
7	92	1	578	1		
8	63	1	838	1		
9	92	1	578	1		
10	76	1	698	1		
11	62	1	858	1		
12	62	1	858	1		
13	102	1	518	1		
14	102	1	518	1		
15	86	1	618	1		
16	21	1	2630	1		
17	25	1	2180	1		
18	26	1	2084	1		
19	44	1	1214	1		
20	48	1	1119	1		
21	26	1	2097	1		
22	18	1	2973	1		
23	18	1	2940	1		
24	55	1	968	1		
25	19	1	2891	1		
26	29	1	1836	1		
27	21	1	2543	1		
28	22	1	2469	1		
29	66	1	806	1		
30	47	1	1137	1		





**USA Bin 2 Radar Statistical Performance**

Trial #	Pulses	PW	PRI	1=Detection 0=No Detection	Detection Percentage	Limit
1	24	1.5	218	1	80.0%	60.0%
2	27	2.9	183	1		
3	26	3	228	1		
4	29	1.1	170	1		
5	24	2.4	170	1		
6	27	4.2	185	0		
7	25	4.8	161	1		
8	29	2.8	183	1		
9	24	1	207	1		
10	27	3.3	151	1		
11	28	2.6	168	1		
12	23	2.2	153	1		
13	28	3.4	179	1		
14	24	2.8	191	0		
15	24	3.9	205	1		
16	23	1.7	201	1		
17	24	1.5	214	0		
18	23	3.2	199	0		
19	28	4.2	166	1		
20	29	1	221	1		
21	24	3.9	212	1		
22	25	3.6	225	0		
23	23	2.7	183	1		
24	26	3.7	151	1		
25	26	1.7	214	1		
26	24	3.5	197	1		
27	29	3.4	188	0		
28	29	2.8	198	1		
29	29	4.5	176	1		
30	23	2.7	178	1		



**USA Bin 3 Radar Statistical Performance**

Trial #	Pulses	PW	PRI	1=Detection 0=No Detection	Detection Percentage	Limit
1	17	9.7	358	1	93.3%	60.0%
2	18	8.1	371	1		
3	17	8.5	370	1		
4	18	6.9	260	1		
5	17	7.8	383	1		
6	18	8	387	1		
7	16	6.3	209	1		
8	18	7.4	398	1		
9	16	9.9	325	1		
10	18	9.7	451	1		
11	18	7.5	310	0		
12	18	7.5	278	1		
13	17	8.5	406	1		
14	17	7.7	474	1		
15	16	9.3	330	1		
16	17	6.5	312	1		
17	16	7.6	320	1		
18	18	8.6	459	1		
19	16	6.1	441	1		
20	18	8.3	493	1		
21	17	9.2	274	1		
22	16	7.8	493	1		
23	18	9.7	216	1		
24	18	6.7	459	1		
25	16	7.9	320	1		
26	17	8.6	204	1		
27	17	7.5	310	0		
28	18	9	275	1		
29	16	6.5	383	1		
30	18	6	312	1		



**USA Bin 4 Radar Statistical Performance**

Trial #	Pulses	PW	PRI	1=Detection 0=No Detection	Detection Percentage	Limit
1	13	18	290	1	73.3%	60.0%
2	12	17.5	435	0		
3	14	12	402	1		
4	15	12.2	293	1		
5	14	16.6	364	1		
6	14	14.6	304	1		
7	15	16.2	422	1		
8	15	18.1	374	1		
9	13	15.9	354	1		
10	16	18.8	372	0		
11	15	19.9	476	1		
12	12	19.2	374	0		
13	12	17.4	273	0		
14	16	18.7	404	1		
15	12	14.8	466	1		
16	16	18.4	244	0		
17	15	13.8	325	1		
18	16	12.9	434	1		
19	16	17.3	343	1		
20	13	11.1	362	0		
21	14	17.3	326	1		
22	14	19.6	346	1		
23	15	11.8	261	1		
24	15	19.2	280	0		
25	13	18.3	423	0		
26	15	11.6	400	1		
27	13	16	467	1		
28	15	12.9	424	1		
29	16	16.2	378	1		
30	15	16.9	428	1		

In addition an average minimum percentage of successful detection across all four Short pulse radar test waveforms is required and is calculated as follows:

$$\frac{P_d 1 + P_d 2 + P_d 3 + P_d 4}{4} = (100.0\% + 80.0\% + 93.3\% + 73.3\%) / 4 = 86.7\% (>80\%)$$



\*See the Bin5 Radar Characteristics at the end of this report.

**USA Bin 5 Radar Statistical Performance**

<b>Trial #</b>	<b>Name</b>	<b>1=Detection 0=No Detection</b>	<b>Detection Percentage</b>	<b>Limit</b>
1	USA Bin 5 Radar Test 1	1	100.0%	80.0%
2	USA Bin 5 Radar Test 2	1		
3	USA Bin 5 Radar Test 3	1		
4	USA Bin 5 Radar Test 4	1		
5	USA Bin 5 Radar Test 5	1		
6	USA Bin 5 Radar Test 6	1		
7	USA Bin 5 Radar Test 7	1		
8	USA Bin 5 Radar Test 8	1		
9	USA Bin 5 Radar Test 9	1		
10	USA Bin 5 Radar Test 10	1		
11	USA Bin 5 Radar Test 11	1		
12	USA Bin 5 Radar Test 12	1		
13	USA Bin 5 Radar Test 13	1		
14	USA Bin 5 Radar Test 14	1		
15	USA Bin 5 Radar Test 15	1		
16	USA Bin 5 Radar Test 16	1		
17	USA Bin 5 Radar Test 17	1		
18	USA Bin 5 Radar Test 18	1		
19	USA Bin 5 Radar Test 19	1		
20	USA Bin 5 Radar Test 20	1		
21	USA Bin 5 Radar Test 21	1		
22	USA Bin 5 Radar Test 22	1		
23	USA Bin 5 Radar Test 23	1		
24	USA Bin 5 Radar Test 24	1		
25	USA Bin 5 Radar Test 25	1		
26	USA Bin 5 Radar Test 26	1		
27	USA Bin 5 Radar Test 27	1		
28	USA Bin 5 Radar Test 28	1		
29	USA Bin 5 Radar Test 29	1		
30	USA Bin 5 Radar Test 30	1		



USA Bin 5 Trial #1							
Burst #	Pulses	Frequency (MHz)	Chirp (MHz)	PW (uS)	Inter-pulse spacing (uS)	Inter-pulse spacing (uS)	Pulse Start (S)
1	3	5499	20	100	1308	1005	0.363912
2	1	5499	20	80			0.91618
3	1	5499	20	75			2.535046
4	3	5499	20	70	1984	1048	2.713382
5	1	5499	20	55			3.583724
6	3	5499	20	60	1133	1803	4.508405
7	1	5499	20	50			5.766518
8	2	5499	20	70	1690		6.830979
9	2	5499	20	60	1503		6.995536
10	1	5499	20	70			8.3207
11	3	5499	20	65	1063	1490	9.115314
12	1	5499	20	80			9.964353
13	2	5499	20	100	1134		10.638299
14	3	5499	20	100	1945	1091	11.811772

USA Bin 5 Trial #2							
Burst #	Pulses	Frequency (MHz)	Chirp (MHz)	PW (uS)	Inter-pulse spacing (uS)	Inter-pulse spacing (uS)	Pulse Start (S)
1	2	5497.4	16	50	1410		0.48017
2	2	5497.4	16	100	1031		1.709718
3	2	5497.4	16	60	1972		3.179198
4	3	5497.4	16	95	1737	1108	4.167922
5	2	5497.4	16	75	1624		6.534551
6	2	5497.4	16	70	1159		7.752988
7	1	5497.4	16	75			8.069517
8	2	5497.4	16	65	1192		9.749443
9	3	5497.4	16	75	1153	1518	11.376501

USA Bin 5 Trial #3							
Burst #	Pulses	Frequency (MHz)	Chirp (MHz)	PW (uS)	Inter-pulse spacing (uS)	Inter-pulse spacing (uS)	Pulse Start (S)
1	1	5493.8	7	55			0.065493
2	3	5493.8	7	75	1027	1111	1.274676
3	2	5493.8	7	55	1902		1.809147
4	3	5493.8	7	85	1102	1299	2.391944
5	3	5493.8	7	95	1958	1247	3.302604
6	1	5493.8	7	75			3.992895
7	1	5493.8	7	80			4.008427
8	3	5493.8	7	60	1320	1737	5.026196
9	3	5493.8	7	95	1050	1066	5.639148
10	2	5493.8	7	75	1787		6.43081
11	3	5493.8	7	60	1798	1765	6.870003
12	3	5493.8	7	60	1627	1957	7.866764
13	1	5493.8	7	55			8.372395
14	2	5493.8	7	60	1170		8.732875
15	1	5493.8	7	70			9.788577
16	3	5493.8	7	90	1033	1497	10.066406
17	3	5493.8	7	55	1491	1639	10.78646
18	1	5493.8	7	85			11.488382

USA Bin 5 Trial #4							
Burst #	Pulses	Frequency (MHz)	Chirp (MHz)	PW (uS)	Inter-pulse spacing (uS)	Inter-pulse spacing (uS)	Pulse Start (S)
1	3	5495.8	12	80	1854	1981	0.446451
2	1	5495.8	12	60			1.365054
3	3	5495.8	12	95	1979	1966	2.025233
4	2	5495.8	12	75	1189		2.607859
5	1	5495.8	12	95			3.584956
6	2	5495.8	12	50	1850		4.360433
7	1	5495.8	12	65			4.949205
8	2	5495.8	12	55	1024		5.363602
9	2	5495.8	12	75	1522		6.569683
10	3	5495.8	12	50	1482	1455	7.156278
11	2	5495.8	12	70	1685		8.234076
12	2	5495.8	12	55	1398		8.771915
13	2	5495.8	12	70	1131		9.001368
14	2	5495.8	12	100	1565		9.829925
15	2	5495.8	12	85	1221		11.185586
16	2	5495.8	12	75	1284		11.317385

USA Bin 5 Trial #5							
Burst #	Pulses	Frequency (MHz)	Chirp (MHz)	PW (uS)	Inter-pulse spacing (uS)	Inter-pulse spacing (uS)	Pulse Start (S)
1	2	5495.8	12	95	1106		0.48184
2	1	5495.8	12	65			1.223173
3	1	5495.8	12	80			1.777443
4	3	5495.8	12	65	1366	1683	2.230547
5	1	5495.8	12	90			3.512595
6	1	5495.8	12	55			4.14002



7	1	5495.8	12	55			4.724861
8	2	5495.8	12	55	1358		5.468132
9	1	5495.8	12	95			6.309074
10	2	5495.8	12	90	1115		6.452042
11	3	5495.8	12	80	1307	1124	7.480106
12	3	5495.8	12	55	1416	1252	8.332978
13	1	5495.8	12	95			8.561013
14	3	5495.8	12	75	1011	1352	9.732296
15	2	5495.8	12	75	1461		10.450497
16	1	5495.8	12	85			10.748283
17	3	5495.8	12	90	1030	1866	11.475611

USA Bin 5 Trial #6

Burst #	Pulses	Frequency (MHz)	Chirp (MHz)	PW (uS)	Inter-pulse spacing (uS)	Inter-pulse spacing (uS)	Pulse Start (S)
1	2	5498.2	18	100	1567		0.64446
2	2	5498.2	18	100	1537		1.280757
3	2	5498.2	18	55	1365		3.222804
4	3	5498.2	18	70	1880	1600	3.989146
5	2	5498.2	18	90	1911		5.593759
6	3	5498.2	18	100	1886	1428	6.460738
7	2	5498.2	18	85	1855		7.327756
8	3	5498.2	18	55	1986	1004	9.55794
9	1	5498.2	18	80			10.692446
10	2	5498.2	18	80	1792		11.94928

USA Bin 5 Trial #7

Burst #	Pulses	Frequency (MHz)	Chirp (MHz)	PW (uS)	Inter-pulse spacing (uS)	Inter-pulse spacing (uS)	Pulse Start (S)
1	2	5495.8	12	100	1854		0.701579
2	3	5495.8	12	50	1194	1974	1.496292
3	3	5495.8	12	65	1898	1571	2.410809
4	3	5495.8	12	80	1419	1418	3.082219
5	1	5495.8	12	60			4.007518
6	3	5495.8	12	50	1353	1013	4.997231
7	3	5495.8	12	70	1807	1263	6.259747
8	3	5495.8	12	85	1717	1391	7.306543
9	2	5495.8	12	80	1073		7.951394
10	3	5495.8	12	65	1917	1033	9.225744
11	3	5495.8	12	55	1957	1899	9.888862
12	1	5495.8	12	70			10.817461
13	2	5495.8	12	70	1285		11.740542

USA Bin 5 Trial #8

Burst #	Pulses	Frequency (MHz)	Chirp (MHz)	PW (uS)	Inter-pulse spacing (uS)	Inter-pulse spacing (uS)	Pulse Start (S)
1	1	5497.8	17	65			0.251681
2	3	5497.8	17	75	1641	1339	0.746657
3	2	5497.8	17	85	1104		1.615152
4	2	5497.8	17	60	1685		2.39045
5	3	5497.8	17	80	1219	1957	2.814194
6	2	5497.8	17	60	1309		3.28084
7	1	5497.8	17	80			4.336248
8	2	5497.8	17	50	1865		4.650817
9	1	5497.8	17	55			5.285911
10	3	5497.8	17	55	1064	1584	6.19436
11	1	5497.8	17	75			6.360152
12	3	5497.8	17	70	1902	1493	7.328466
13	1	5497.8	17	100			7.644704
14	2	5497.8	17	60	1350		8.432897
15	1	5497.8	17	65			9.31182
16	3	5497.8	17	50	1766	1483	10.064195
17	1	5497.8	17	55			10.151694
18	3	5497.8	17	55	1710	1989	11.089214
19	1	5497.8	17	85			11.419971

USA Bin 5 Trial #9

Burst #	Pulses	Frequency (MHz)	Chirp (MHz)	PW (uS)	Inter-pulse spacing (uS)	Inter-pulse spacing (uS)	Pulse Start (S)
1	3	5497.4	16	90	1843	1374	0.250656
2	2	5497.4	16	60	1141		0.876912
3	3	5497.4	16	60	1944	1617	2.057753
4	3	5497.4	16	75	1665	1357	2.761686
5	1	5497.4	16	95			3.36299
6	2	5497.4	16	55	1435		3.667344
7	3	5497.4	16	55	1547	1023	4.370853
8	1	5497.4	16	95			5.058427
9	3	5497.4	16	60	1220	1088	5.99878
10	3	5497.4	16	50	1890	1921	6.736053
11	1	5497.4	16	65			7.633932
12	3	5497.4	16	60	1774	1735	7.896609
13	3	5497.4	16	85	1938	1697	9.006742
14	3	5497.4	16	95	1830	1001	9.401701



15	3	5497.4	16	55	1238	1991	10.122888
16	1	5497.4	16	90			10.782111
17	3	5497.4	16	65	1186	1044	11.481017
USA Bin 5 Trial #10							
Burst #	Pulses	Frequency (MHz)	Chirp (MHz)	PW (uS)	Inter-pulse spacing (uS)	Inter-pulse spacing (uS)	Pulse Start (S)
1	1	5500	13	60			0.103307
2	1	5500	13	85			1.134212
3	1	5500	13	50			2.189793
4	3	5500	13	70	1436	1462	3.053827
5	1	5500	13	50			3.885664
6	1	5500	13	60			5.082615
7	2	5500	13	85	1399		5.294963
8	1	5500	13	80			6.684542
9	1	5500	13	90			7.231273
10	1	5500	13	70			8.337159
11	1	5500	13	70			8.638883
12	1	5500	13	65			9.97885
13	2	5500	13	70	1534		10.374524
14	1	5500	13	60			11.955713
USA Bin 5 Trial #11							
Burst #	Pulses	Frequency (MHz)	Chirp (MHz)	PW (uS)	Inter-pulse spacing (uS)	Inter-pulse spacing (uS)	Pulse Start (S)
1	1	5500	9	80			0.373778
2	3	5500	9	60	1039	1904	2.111894
3	3	5500	9	80	1831	1045	2.80876
4	2	5500	9	50	1898		3.755912
5	1	5500	9	65			4.849887
6	2	5500	9	50	1490		6.872285
7	2	5500	9	90	1769		8.123122
8	1	5500	9	60			9.099677
9	1	5500	9	75			9.848229
10	3	5500	9	50	1724	1071	11.603574
USA Bin 5 Trial #12							
Burst #	Pulses	Frequency (MHz)	Chirp (MHz)	PW (uS)	Inter-pulse spacing (uS)	Inter-pulse spacing (uS)	Pulse Start (S)
1	3	5500	10	90	1358	1632	0.14677
2	2	5500	10	75	1116		1.08406
3	2	5500	10	65	1117		1.472359
4	3	5500	10	60	1907	1735	2.121292
5	1	5500	10	65			2.939108
6	1	5500	10	75			3.3309
7	1	5500	10	80			4.102035
8	1	5500	10	80			4.610452
9	2	5500	10	90	1986		5.131818
10	3	5500	10	100	1772	1549	5.603122
11	3	5500	10	100	1261	1696	6.117692
12	1	5500	10	100			7.024681
13	2	5500	10	50	1496		7.488743
14	3	5500	10	75	1739	1781	7.926956
15	2	5500	10	85	1741		8.787225
16	2	5500	10	85	1470		9.212022
17	2	5500	10	80	2000		10.142208
18	3	5500	10	80	1718	1839	10.46843
19	3	5500	10	85	1411	1472	10.805372
20	3	5500	10	100	1739	1240	11.70616
USA Bin 5 Trial #13							
Burst #	Pulses	Frequency (MHz)	Chirp (MHz)	PW (uS)	Inter-pulse spacing (uS)	Inter-pulse spacing (uS)	Pulse Start (S)
1	3	5500	9	100	1187	1800	0.382723
2	1	5500	9	50			1.288573
3	3	5500	9	85	1883	1127	1.787387
4	2	5500	9	90	1605		2.231314
5	1	5500	9	55			3.288487
6	2	5500	9	100	1566		4.202279
7	3	5500	9	100	1501	1349	4.535324
8	2	5500	9	80	1198		5.221895
9	3	5500	9	75	1932	1359	6.084952
10	1	5500	9	65			6.98281
11	2	5500	9	85	1127		7.689801
12	3	5500	9	100	1951	1165	8.042946
13	2	5500	9	55	1624		8.606419
14	3	5500	9	100	1889	1325	9.75506
15	1	5500	9	90			10.495663
16	3	5500	9	55	1283	1222	10.756526
17	1	5500	9	55			11.949032
USA Bin 5 Trial #14							
Burst #	Pulses	Frequency (MHz)	Chirp (MHz)	PW (uS)	Inter-pulse spacing (uS)	Inter-pulse spacing (uS)	Pulse Start (S)



1	2	5500	20	60	1939		0.666975
2	1	5500	20	55			1.137777
3	2	5500	20	60	1868		1.857129
4	3	5500	20	70	1920	1039	2.733574
5	3	5500	20	75	1189	1787	3.634162
6	2	5500	20	60	1469		3.848022
7	2	5500	20	80	1623		4.949906
8	1	5500	20	95			5.783771
9	3	5500	20	85	1999	1788	6.15823
10	2	5500	20	65	1107		7.074543
11	3	5500	20	100	1762	1422	8.026909
12	2	5500	20	100	1580		8.81332
13	3	5500	20	80	1719	1031	9.161714
14	2	5500	20	95	1082		10.164185
15	2	5500	20	90	1552		10.995931
16	3	5500	20	75	1263	1944	11.558705

USA Bin 5 Trial #15

Burst #	Pulses	Frequency (MHz)	Chirp (MHz)	PW (uS)	Inter-pulse spacing (uS)	Inter-pulse spacing (uS)	Pulse Start (S)
1	3	5500	7	85	1478	1666	0.202259
2	2	5500	7	95	1286		1.218317
3	1	5500	7	65			1.375561
4	1	5500	7	60			2.169533
5	2	5500	7	70	1567		3.287963
6	1	5500	7	65			3.965
7	3	5500	7	55	1837	1010	4.339174
8	3	5500	7	75	1704	1613	4.75602
9	2	5500	7	85	1558		5.347581
10	2	5500	7	55	1651		6.136662
11	3	5500	7	80	1524	1510	7.038753
12	2	5500	7	70	1673		7.952345
13	3	5500	7	80	1989	1598	8.47183
14	3	5500	7	55	1474	1077	8.969856
15	3	5500	7	50	1278	1043	9.49212
16	2	5500	7	55	1270		10.372097
17	2	5500	7	60	1408		11.129309
18	1	5500	7	50			11.580301

USA Bin 5 Trial #16

Burst #	Pulses	Frequency (MHz)	Chirp (MHz)	PW (uS)	Inter-pulse spacing (uS)	Inter-pulse spacing (uS)	Pulse Start (S)
1	2	5500	17	75	1331		0.086831
2	3	5500	17	75	1437	1646	1.140676
3	1	5500	17	90			1.278566
4	3	5500	17	95	1961	1209	2.063371
5	3	5500	17	75	1455	1572	2.767702
6	2	5500	17	55	1805		3.583156
7	2	5500	17	65	1002		4.062351
8	2	5500	17	90	1906		4.687468
9	3	5500	17	65	1615	1083	5.378704
10	3	5500	17	90	1344	1172	5.687724
11	2	5500	17	100	1240		6.389886
12	3	5500	17	50	1378	1730	7.044923
13	2	5500	17	80	1277		7.707963
14	2	5500	17	85	1030		8.107758
15	3	5500	17	95	1008	1158	8.933694
16	2	5500	17	80	1673		9.069335
17	3	5500	17	85	1745	1212	10.194788
18	1	5500	17	85			10.499382
19	2	5500	17	60	1917		11.321492
20	1	5500	17	90			11.772845

USA Bin 5 Trial #17

Burst #	Pulses	Frequency (MHz)	Chirp (MHz)	PW (uS)	Inter-pulse spacing (uS)	Inter-pulse spacing (uS)	Pulse Start (S)
1	1	5500	8	80			0.287452
2	2	5500	8	85	1135		0.716228
3	1	5500	8	80			1.366681
4	1	5500	8	75			2.257522
5	1	5500	8	50			2.888094
6	3	5500	8	60	1436	1387	3.975395
7	3	5500	8	95	1916	1334	4.206389
8	1	5500	8	95			5.082251
9	3	5500	8	55	1021	1823	5.58525
10	2	5500	8	70	1915		6.570655
11	2	5500	8	65	1756		6.809051
12	2	5500	8	60	1315		7.471617
13	2	5500	8	95	1474		8.581766
14	3	5500	8	50	1280	1440	9.118428
15	2	5500	8	65	1108		9.407671
16	2	5500	8	50	1381		10.195552





17	1	5500	8	50			11.150093
18	3	5500	8	70	1243	1786	11.946972
USA Bin 5 Trial #18							
Burst #	Pulses	Frequency (MHz)	Chirp (MHz)	PW (uS)	Inter-pulse spacing (uS)	Inter-pulse spacing (uS)	Pulse Start (S)
1	3	5500	13	50	1541	1191	0.110926
2	2	5500	13	80	1826		1.092613
3	1	5500	13	60			1.540162
4	2	5500	13	85	1152		1.866374
5	2	5500	13	75	1739		2.647283
6	1	5500	13	70			3.494867
7	1	5500	13	50			4.11411
8	3	5500	13	55	1701	1113	4.549512
9	2	5500	13	65	1415		4.935084
10	1	5500	13	65			5.844067
11	3	5500	13	55	1410	1085	6.060204
12	2	5500	13	95	1751		7.197614
13	2	5500	13	65	1847		7.5584
14	3	5500	13	70	1105	1557	8.170358
15	3	5500	13	85	1620	1111	8.469864
16	1	5500	13	55			9.506352
17	1	5500	13	100			9.866458
18	3	5500	13	55	1977	1945	10.661842
19	2	5500	13	60	1955		11.166413
20	3	5500	13	80	1839	1898	11.848031
USA Bin 5 Trial #19							
Burst #	Pulses	Frequency (MHz)	Chirp (MHz)	PW (uS)	Inter-pulse spacing (uS)	Inter-pulse spacing (uS)	Pulse Start (S)
1	3	5500	19	80	1585	1499	0.067188
2	2	5500	19	50	1740		1.050371
3	1	5500	19	65			2.001807
4	2	5500	19	85	1505		2.430168
5	1	5500	19	100			3.457259
6	2	5500	19	50	1931		4.09928
7	1	5500	19	50			4.546731
8	3	5500	19	80	1483	1032	5.463739
9	1	5500	19	75			6.248152
10	1	5500	19	80			6.873523
11	1	5500	19	75			7.305957
12	1	5500	19	55			8.053724
13	3	5500	19	50	1465	1675	9.151015
14	2	5500	19	85	1174		9.509596
15	2	5500	19	55	1637		10.236585
16	1	5500	19	60			10.899251
17	3	5500	19	95	1216	1517	11.879807
USA Bin 5 Trial #20							
Burst #	Pulses	Frequency (MHz)	Chirp (MHz)	PW (uS)	Inter-pulse spacing (uS)	Inter-pulse spacing (uS)	Pulse Start (S)
1	2	5505.8	8	85	1011		0.855467
2	3	5505.8	8	95	1254	1461	2.655846
3	1	5505.8	8	70			3.077473
4	3	5505.8	8	55	1559	1380	4.950072
5	1	5505.8	8	70			6.569503
6	2	5505.8	8	80	1598		7.453017
7	2	5505.8	8	90	1362		8.337732
8	2	5505.8	8	85	1708		9.816205
9	3	5505.8	8	100	1384	1115	11.944146
USA Bin 5 Trial #21							
Burst #	Pulses	Frequency (MHz)	Chirp (MHz)	PW (uS)	Inter-pulse spacing (uS)	Inter-pulse spacing (uS)	Pulse Start (S)
1	2	5504.6	11	70	1838		0.855869
2	3	5504.6	11	70	1808	1129	1.558396
3	2	5504.6	11	70	1870		2.564637
4	2	5504.6	11	75	1781		3.535032
5	2	5504.6	11	95	1347		3.926466
6	2	5504.6	11	95	1482		4.970728
7	1	5504.6	11	70			6.118018
8	3	5504.6	11	90	1649	1110	7.206482
9	3	5504.6	11	55	1119	1230	8.124978
10	2	5504.6	11	95	1396		8.944771
11	3	5504.6	11	60	1013	1836	10.106422
12	1	5504.6	11	55			11.006384
13	3	5504.6	11	95	1127	1133	11.443653
USA Bin 5 Trial #22							
Burst #	Pulses	Frequency (MHz)	Chirp (MHz)	PW (uS)	Inter-pulse spacing (uS)	Inter-pulse spacing (uS)	Pulse Start (S)
1	3	5502.6	16	75	1127	1306	0.737843
2	2	5502.6	16	95	1729		1.023854
3	1	5502.6	16	90			1.661344



4	3	5502.6	16	50	1681	1147	2.5725
5	2	5502.6	16	85	1548		3.752551
6	1	5502.6	16	55			4.132452
7	1	5502.6	16	100			5.191068
8	1	5502.6	16	70			6.352483
9	3	5502.6	16	75	1587	1327	6.820352
10	3	5502.6	16	50	1290	1701	7.822023
11	3	5502.6	16	75	1625	1745	8.584352
12	2	5502.6	16	80	1765		9.290569
13	3	5502.6	16	50	1719	1807	10.273938
14	2	5502.6	16	80	1430		11.147536
15	2	5502.6	16	65	1155		11.85334

USA Bin 5 Trial #23

Burst #	Pulses	Frequency (MHz)	Chirp (MHz)	PW (uS)	Inter-pulse spacing (uS)	Inter-pulse spacing (uS)	Pulse Start (S)
1	2	5504.2	12	75	1411		0.011536
2	3	5504.2	12	80	1188	1280	0.778799
3	2	5504.2	12	95	1081		1.892277
4	1	5504.2	12	55			2.541077
5	3	5504.2	12	50	1536	1729	3.389123
6	2	5504.2	12	75	1395		4.064176
7	1	5504.2	12	65			4.497052
8	1	5504.2	12	75			5.047302
9	3	5504.2	12	95	1516	1813	5.775798
10	2	5504.2	12	100	1858		6.875697
11	3	5504.2	12	55	1890	1351	7.690924
12	3	5504.2	12	90	1413	1623	8.224831
13	3	5504.2	12	90	1056	1696	8.831091
14	3	5504.2	12	90	1758	1803	9.631626
15	1	5504.2	12	90			10.202037
16	2	5504.2	12	50	1819		10.91722
17	1	5504.2	12	90			11.383743

USA Bin 5 Trial #24

Burst #	Pulses	Frequency (MHz)	Chirp (MHz)	PW (uS)	Inter-pulse spacing (uS)	Inter-pulse spacing (uS)	Pulse Start (S)
1	2	5505.4	9	100	1446		0.130566
2	3	5505.4	9	55	1793	1346	1.166351
3	2	5505.4	9	100	1067		1.463926
4	2	5505.4	9	65	1353		2.681626
5	1	5505.4	9	90			3.281187
6	3	5505.4	9	90	1447	1710	4.086807
7	3	5505.4	9	65	1390	1151	4.836739
8	3	5505.4	9	75	1850	1956	5.390706
9	2	5505.4	9	60	1732		5.715835
10	1	5505.4	9	55			6.737483
11	1	5505.4	9	95			7.58081
12	1	5505.4	9	70			8.153034
13	2	5505.4	9	70	1813		8.64621
14	3	5505.4	9	50	1620	1203	9.862169
15	3	5505.4	9	100	1404	1014	10.356512
16	3	5505.4	9	60	1630	1598	10.793058
17	2	5505.4	9	60	1788		11.373961

USA Bin 5 Trial #25

Burst #	Pulses	Frequency (MHz)	Chirp (MHz)	PW (uS)	Inter-pulse spacing (uS)	Inter-pulse spacing (uS)	Pulse Start (S)
1	3	5502.6	16	60	1255	1573	0.457215
2	3	5502.6	16	90	1823	1392	0.721622
3	2	5502.6	16	100	1426		1.792522
4	3	5502.6	16	65	1778	1293	2.461489
5	2	5502.6	16	80	1372		2.978784
6	2	5502.6	16	50	1146		3.324791
7	2	5502.6	16	85	1327		3.935901
8	3	5502.6	16	100	1756	1441	4.727186
9	2	5502.6	16	85	1377		5.569784
10	2	5502.6	16	100	1624		5.79313
11	3	5502.6	16	60	1543	1916	6.429759
12	3	5502.6	16	100	1416	1197	7.36622
13	2	5502.6	16	70	1015		7.580453
14	2	5502.6	16	80	1128		8.531865
15	2	5502.6	16	60	1678		9.256808
16	1	5502.6	16	70			9.70496
17	1	5502.6	16	85			10.711509
18	1	5502.6	16	100			10.819846
19	2	5502.6	16	55	1418		11.766613

USA Bin 5 Trial #26

Burst #	Pulses	Frequency (MHz)	Chirp (MHz)	PW (uS)	Inter-pulse spacing (uS)	Inter-pulse spacing (uS)	Pulse Start (S)
1	1	5501.8	18	50			1.171727
2	3	5501.8	18	55	1800	1621	1.759687



3	1	5501.8	18	95			2.473226
4	1	5501.8	18	60			4.398797
5	2	5501.8	18	80	1145		4.815643
6	1	5501.8	18	70			6.243132
7	3	5501.8	18	75	1631	1469	7.935341
8	3	5501.8	18	70	1786	1368	9.34412
9	2	5501.8	18	75	1481		10.65409
10	3	5501.8	18	55	1345	1928	11.383291
USA Bin 5 Trial #27							
Burst #	Pulses	Frequency (MHz)	Chirp (MHz)	PW (uS)	Inter-pulse spacing (uS)	Inter-pulse spacing (uS)	Pulse Start (S)
1	1	5506.2	7	55			0.466105
2	1	5506.2	7	70			2.328974
3	3	5506.2	7	70	1002	1990	3.079143
4	3	5506.2	7	75	1420	1193	4.876703
5	2	5506.2	7	95	1155		6.046055
6	2	5506.2	7	80	1721		7.674949
7	1	5506.2	7	65			8.002379
8	3	5506.2	7	70	1375	1218	9.470271
9	2	5506.2	7	60	1518		11.096757
USA Bin 5 Trial #28							
Burst #	Pulses	Frequency (MHz)	Chirp (MHz)	PW (uS)	Inter-pulse spacing (uS)	Inter-pulse spacing (uS)	Pulse Start (S)
1	2	5506.6	6	70	1214		0.588463
2	1	5506.6	6	85			1.146611
3	3	5506.6	6	100	1127	1866	2.463558
4	1	5506.6	6	100			2.599339
5	2	5506.6	6	65	1945		3.876032
6	1	5506.6	6	75			4.941133
7	3	5506.6	6	80	1199	1603	5.884323
8	2	5506.6	6	75	1118		6.30164
9	3	5506.6	6	95	1216	1040	7.342538
10	1	5506.6	6	65			7.909844
11	2	5506.6	6	60	1023		8.815309
12	3	5506.6	6	80	1161	1370	10.1677
13	1	5506.6	6	65			10.616371
14	2	5506.6	6	55	1330		11.27284
USA Bin 5 Trial #29							
Burst #	Pulses	Frequency (MHz)	Chirp (MHz)	PW (uS)	Inter-pulse spacing (uS)	Inter-pulse spacing (uS)	Pulse Start (S)
1	3	5501.4	19	60	1704	1871	0.286392
2	2	5501.4	19	100	1892		0.96355
3	3	5501.4	19	65	1692	1641	1.7494
4	1	5501.4	19	85			2.456117
5	1	5501.4	19	100			3.041072
6	2	5501.4	19	60	1112		3.239976
7	2	5501.4	19	90	1958		4.361569
8	2	5501.4	19	55	1055		4.942987
9	2	5501.4	19	100	1885		5.309614
10	3	5501.4	19	65	1089	1170	6.112343
11	3	5501.4	19	85	1654	1579	6.455311
12	2	5501.4	19	65	1497		7.283069
13	2	5501.4	19	90	1982		7.655219
14	1	5501.4	19	70			8.382135
15	2	5501.4	19	90	1583		9.154062
16	1	5501.4	19	100			9.86298
17	3	5501.4	19	80	1573	1860	10.467367
18	1	5501.4	19	85			11.198599
19	1	5501.4	19	75			11.474442
USA Bin 5 Trial #30							
Burst #	Pulses	Frequency (MHz)	Chirp (MHz)	PW (uS)	Inter-pulse spacing (uS)	Inter-pulse spacing (uS)	Pulse Start (S)
1	2	5497	15	95	1565		0.610036
2	2	5497	15	95	1026		1.724142
3	1	5497	15	60			2.967098
4	2	5497	15	55	1326		3.743091
5	1	5497	15	75			4.730787
6	2	5497	15	95	1600		5.887567
7	1	5497	15	90			6.572209
8	3	5497	15	80	1342	1983	7.388491
9	2	5497	15	75	1494		8.237923
10	1	5497	15	90			9.019341
11	1	5497	15	85			10.22591
12	3	5497	15	60	1131	1112	11.474371



\*See the Bin6 Radar Characteristics at the end of this report.

**USA Frequency Hopping Radar Statistical Performance**

<b>Trial #</b>	<b>Name</b>	<b>1=Detection 0=No Detection</b>	<b>Detection Percentage</b>	<b>Limit</b>
1	USA Bin 6 Radar Test 1	1	96.7%	70.0%
2	USA Bin 6 Radar Test 2	1		
3	USA Bin 6 Radar Test 3	1		
4	USA Bin 6 Radar Test 4	1		
5	USA Bin 6 Radar Test 5	1		
6	USA Bin 6 Radar Test 6	1		
7	USA Bin 6 Radar Test 7	1		
8	USA Bin 6 Radar Test 8	1		
9	USA Bin 6 Radar Test 9	1		
10	USA Bin 6 Radar Test 10	1		
11	USA Bin 6 Radar Test 11	1		
12	USA Bin 6 Radar Test 12	1		
13	USA Bin 6 Radar Test 13	1		
14	USA Bin 6 Radar Test 14	1		
15	USA Bin 6 Radar Test 15	1		
16	USA Bin 6 Radar Test 16	1		
17	USA Bin 6 Radar Test 17	1		
18	USA Bin 6 Radar Test 18	1		
19	USA Bin 6 Radar Test 19	1		
20	USA Bin 6 Radar Test 20	1		
21	USA Bin 6 Radar Test 21	1		
22	USA Bin 6 Radar Test 22	1		
23	USA Bin 6 Radar Test 23	0		
24	USA Bin 6 Radar Test 24	1		
25	USA Bin 6 Radar Test 25	1		
26	USA Bin 6 Radar Test 26	1		
27	USA Bin 6 Radar Test 27	1		
28	USA Bin 6 Radar Test 28	1		
29	USA Bin 6 Radar Test 29	1		
30	USA Bin 6 Radar Test 30	1		

## USA Frequency Hopping Trial #1

Hop #	Freq (GHz)	Pulse Start (mS)
16	5506	48
18	5501	54
27	5500	81
56	5494	168
59	5509	177
78	5493	234
85	5507	255

## USA Frequency Hopping Trial #2

Hop #	Freq (GHz)	Pulse Start (mS)
36	5494	108
64	5497	192
79	5503	237

## USA Frequency Hopping Trial #3

Hop #	Freq (GHz)	Pulse Start (mS)
3	5505	9
22	5501	66
37	5494	111

## USA Frequency Hopping Trial #4

Hop #	Freq (GHz)	Pulse Start (mS)
33	5502	99
74	5494	222
86	5495	258

## USA Frequency Hopping Trial #5

Hop #	Freq (GHz)	Pulse Start (mS)
6	5503	18
25	5494	75
36	5498	108
42	5506	126
62	5508	186
74	5502	222
88	5499	264
97	5504	291
98	5501	294

## USA Frequency Hopping Trial #6

Hop #	Freq (GHz)	Pulse Start (mS)
60	5493	180
64	5503	192

## USA Frequency Hopping Trial #7

Hop #	Freq (GHz)	Pulse Start (mS)
11	5502	33
13	5499	39
50	5504	150
61	5509	183
99	5495	297

## USA Frequency Hopping Trial #8

Hop #	Freq (GHz)	Pulse Start (mS)
3	5497	9
71	5494	213
81	5500	243

## USA Frequency Hopping Trial #9

Hop #	Freq (GHz)	Pulse Start (mS)
36	5505	108
37	5504	111
43	5499	129
50	5501	150
68	5509	204
76	5502	228
94	5507	282

## USA Frequency Hopping Trial #10

Hop #	Freq (GHz)	Pulse Start (mS)
18	5501	54
28	5494	84
32	5509	96
33	5496	99
38	5495	114
51	5507	153

89	5508	267
92	5506	276
USA Frequency Hopping Trial #11		
Hop #	Freq (GHz)	Pulse Start (mS)
13	5496	39
58	5494	174
USA Frequency Hopping Trial #12		
Hop #	Freq (GHz)	Pulse Start (mS)
6	5492	18
7	5493	21
61	5496	183
USA Frequency Hopping Trial #13		
Hop #	Freq (GHz)	Pulse Start (mS)
6	5498	18
28	5499	84
56	5509	168
84	5492	252
87	5507	261
91	5496	273
92	5506	276
USA Frequency Hopping Trial #14		
Hop #	Freq (GHz)	Pulse Start (mS)
13	5505	39
36	5493	108
48	5499	144
56	5504	168
USA Frequency Hopping Trial #15		
Hop #	Freq (GHz)	Pulse Start (mS)
56	5507	168
60	5501	180
89	5499	267
USA Frequency Hopping Trial #16		
Hop #	Freq (GHz)	Pulse Start (mS)
11	5494	33
76	5502	228
90	5492	270
USA Frequency Hopping Trial #17		
Hop #	Freq (GHz)	Pulse Start (mS)
32	5501	96
37	5499	111
USA Frequency Hopping Trial #18		
Hop #	Freq (GHz)	Pulse Start (mS)
1	5504	3
37	5500	111
80	5493	240
USA Frequency Hopping Trial #19		
Hop #	Freq (GHz)	Pulse Start (mS)
14	5491	42
17	5494	51
58	5495	174
74	5498	222
84	5500	252
90	5492	270
USA Frequency Hopping Trial #20		
Hop #	Freq (GHz)	Pulse Start (mS)
87	5498	261
USA Frequency Hopping Trial #21		
Hop #	Freq (GHz)	Pulse Start (mS)
47	5497	141
52	5495	156
56	5505	168
79	5506	237
USA Frequency Hopping Trial #22		
Hop #	Freq (GHz)	Pulse Start (mS)
6	5503	18
19	5494	57
21	5504	63
27	5505	81
64	5495	192



## USA Frequency Hopping Trial #23

Hop #	Freq (GHz)	Pulse Start (mS)
78	5500	234
82	5491	246

## USA Frequency Hopping Trial #24

Hop #	Freq (GHz)	Pulse Start (mS)
11	5502	33
27	5493	81
81	5491	243

## USA Frequency Hopping Trial #25

Hop #	Freq (GHz)	Pulse Start (mS)
20	5502	60
25	5506	75
60	5493	180
73	5495	219
91	5500	273

## USA Frequency Hopping Trial #26

Hop #	Freq (GHz)	Pulse Start (mS)
17	5503	51
50	5504	150
51	5492	153
56	5501	168
72	5494	216
87	5498	261

## USA Frequency Hopping Trial #27

Hop #	Freq (GHz)	Pulse Start (mS)
0	5509	0
47	5493	141
73	5506	219

## USA Frequency Hopping Trial #28

Hop #	Freq (GHz)	Pulse Start (mS)
10	5498	30
11	5506	33
76	5505	228

## USA Frequency Hopping Trial #29

Hop #	Freq (GHz)	Pulse Start (mS)
14	5499	42
45	5503	135
63	5504	189
87	5507	261
93	5502	279

## USA Frequency Hopping Trial #30

Hop #	Freq (GHz)	Pulse Start (mS)
19	5495	57
90	5503	270
98	5506	294

**Appendix C: List of Test Equipment Used to perform the test**

Equip#	Manufacturer/ Model	Description	Last Cal	Next Due
CIS-54303	Keysight / N5182B	MXG Signal Generator	09-Mar-15	09-Mar-16
CIS-49514	National Instruments /PXI-1042	DFS Automation System	Cal before Use	Cal before Use
	National Instruments /PXI-5422	16-Bit 200MS/s AWG	Cal before Use	Cal before Use
	National Instruments /PXI-5422	16-Bit 200MS/s AWG	Cal before Use	Cal before Use
	National Instruments /PXI-2796	40GHz Dual 6x1 Multiplex	Cal before Use	Cal before Use
CIS050721	N9030A Keysight	PXA Signal Analyzer	13-Apr-15	13-Apr-16
CIS054662	SF18-S1S1-36 MegaPhase	SMA 36" cable	24-Jun-15	24-Jun-16
CIS054661	BWS30-W2 Aeroflex	SMA 30dB Attenuator	24-Jun-15	24-Jun-16
CIS054660	BWS20-W2 Aeroflex	SMA 20dB Attenuator	24-Jun-15	24-Jun-16
CIS054659	PS4-09-452/4S Pulsar	Splitter	24-Jun-15	24-Jun-16
CIS054657	ZFSC-2-10G Mini-Circuits	Splitter	24-Jun-15	24-Jun-16
CIS054678	RA08-S1S1-12 MegaPhase	SMA 12" Cable	24-Jun-15	24-Jun-16
CIS054668	RA08-S1S1-18 MegaPhase	SMA 18" Cable	24-Jun-15	24-Jun-16
CIS054667	RA08-S1S1-18 MegaPhase	SMA 18" Cable	24-Jun-15	24-Jun-16
CIS054665	RA08-S1S1-24 MegaPhase	SMA 24" Cable	24-Jun-15	24-Jun-16
CIS054663	F120-S1S1-48 MegaPhase	SMA 48" Cable	24-Jun-15	24-Jun-16
CIS054686	NI PXI-2796 National Instruments	Plug-in switch module	6-Oct-15	6-Oct-16
CIS-49514	National Instruments /PXI-1042	DFS Automation System	Cal before Use	Cal before Use
CIS-49514	National Instruments /PXI-5422	16-Bit 200MS/s AWG	Cal before Use	Cal before Use
CIS-49514	National Instruments /PXI-5422	16-Bit 200MS/s AWG	Cal before Use	Cal before Use
CIS054695	D3C2060 Ditom	Circulator	20-Oct-15	20-Oct-16



**END**