



## Test Report

FCC ID: LDK102101

**AIR-AP3802P-B-K9, AIR-AP3802P-UXK9**

IC: 2461B-102101

**AIR-AP3802P-A-K9, AIR-AP3802P-UXK9**

Cisco Aironet 802.11ac Dual Band Access Points

**5725-5850 MHz**

Against the following Specifications:

CFR47 Part 15.407

RSS-247

**Cisco Systems**

170 West Tasman Drive

San Jose, CA 95134

	
<b>Author:</b> Jose Aguirre <b>Tested By</b>	<b>Approved By:</b> Jim Nicholson <b>Title:</b> Technical Leader, Engineering <b>Revision:</b> 1

This report replaces any previously entered test report under EDCS – **1552574**. This test report has been electronically authorized and archived using the CISCO Engineering Document Control system.



This test report has been electronically authorized and archived using the CISCO Engineering Document Control system.

<b>SECTION 1: OVERVIEW .....</b>	<b>4</b>
<b>SECTION 2: ASSESSMENT INFORMATION .....</b>	<b>5</b>
2.1 GENERAL .....	5
2.2 DATE OF TESTING.....	7
2.3 REPORT ISSUE DATE .....	7
2.4 TESTING FACILITIES .....	7
2.5 EQUIPMENT ASSESSED (EUT).....	7
2.6 EUT DESCRIPTION.....	8
<b>SECTION 3: RESULT SUMMARY.....</b>	<b>11</b>
3.1 RESULTS SUMMARY TABLE .....	11
<b>SECTION 4: SAMPLE DETAILS.....</b>	<b>12</b>
<b>APPENDIX A: EMISSION TEST RESULTS.....</b>	<b>13</b>
CONDUCTED TEST SETUP DIAGRAM.....	13
TARGET MAXIMUM CHANNEL POWER .....	13
ANTENNA GAIN : 2 DBI .....	13
ANTENNA GAIN : 3 DBI .....	14
ANTENNA GAIN : 4 DBI .....	15
ANTENNA GAIN : 5 DBI .....	16
ANTENNA GAIN : 6 DBI .....	17
ANTENNA GAIN : 8 DBI .....	18
ANTENNA GAIN : 13 DBI.....	19
A.1 6DB BANDWIDTH.....	20
A.2 99% AND 26dB BANDWIDTH .....	28
A.3 MAXIMUM CONDUCTED OUTPUT POWER .....	36
ANTENNA GAIN : 2 DBI .....	37
ANTENNA GAIN : 3 DBI .....	43
ANTENNA GAIN : 4 DBI .....	48
ANTENNA GAIN : 5 DBI .....	54
ANTENNA GAIN : 6 DBI .....	60
ANTENNA GAIN : 8 DBI .....	66
ANTENNA GAIN : 13 DBI.....	72
A.4 POWER SPECTRAL DENSITY .....	77
ANTENNA GAIN : 2 DBI .....	78
ANTENNA GAIN : 3 DBI .....	84
ANTENNA GAIN : 4 DBI .....	89
ANTENNA GAIN : 5 DBI .....	95
ANTENNA GAIN : 6 DBI .....	101
ANTENNA GAIN : 8 DBI .....	107
ANTENNA GAIN : 13 DBI.....	112
A.5 CONDUCTED SPURIOUS EMISSIONS.....	118
A.6 CONDUCTED BANDEDGE.....	132
ANTENNA GAIN : 2 DBI .....	133



ANTENNA GAIN : 3 DBI .....	139
ANTENNA GAIN : 4 DBI .....	145
ANTENNA GAIN : 5 DBI .....	151
ANTENNA GAIN : 6 DBI .....	157
ANTENNA GAIN : 8 DBI .....	163
ANTENNA GAIN : 13 DBI.....	169
<b>APPENDIX B: EMISSION TEST RESULTS.....</b>	<b>174</b>
RADIATED EMISSION SETUP DIAGRAM-BELOW 1G.....	174
RADIATED EMISSION SETUP DIAGRAM-ABOVE 1G .....	174
B.1 RADIATED SPURIOUS EMISSIONS .....	175
B.2 RADIATED RECEIVER SPURIOUS EMISSIONS .....	186
B.3 RADIATED EMISSIONS 30MHZ TO 1GHZ .....	191
B.4 AC CONDUCTED EMISSIONS .....	193
<b>APPENDIX C: LIST OF TEST EQUIPMENT USED TO PERFORM THE TEST.....</b>	<b>200</b>
<b>APPENDIX E: ABBREVIATION KEY AND DEFINITIONS .....</b>	<b>202</b>



## Section 1: Overview

The samples were assessed against the tests detailed in section 3 under the requirements of the following specifications:

<b>Specifications:</b>
CFR47 Part 15.407 RSS-247 Issue 1: May 2015 RSS-Gen Issue 4: Nov 2014

Measurements were made in accordance with

- ANSI C63.10:2013
- KDB 789033 D02 General UNII Test Procedures New Rules v01r01
- KDB 662911 D01 Multiple Transmitter Output v02r01



## Section 2: Assessment Information

### 2.1 General

This report contains an assessment of an apparatus against Electromagnetic Compatibility Standards based upon tests carried out on the samples submitted. The testing was performed by and for the use of Cisco systems Inc:

With regard to this assessment, the following points should be noted:

- a) The results contained in this report relate only to the items tested and were obtained in the period between the date of the initial assessment and the date of issue of the report. Manufactured products will not necessarily give identical results due to production and measurement tolerances.
- b) The apparatus was set up and exercised using the configuration and modes of operation defined in this report only.
- c) Where relevant, the apparatus was only assessed using the susceptibility criteria defined in this report and the Test Assessment Plan (TAP).
- d) All testing was performed under the following environmental conditions:

Temperature	15°C to 35°C (54°F to 95°F)
Atmospheric Pressure	860mbar to 1060mbar (25.4" to 31.3")
Humidity	10% to 75*%
- e) All AC testing was performed at one or more of the following supply voltages:  
110V 60 Hz (+/-20%)

### Units of Measurement

The units of measurements defined in the appendices are reported in specific terms, which are test dependent. Where radiated measurements are concerned these are defined at a particular distance. Basic voltage measurements are defined in units of [dBuV]

As an example, the basic calculation for all measurements is as follows:

$$\text{Emission level [dBuV]} = \text{Indicated voltage level [dBuV]} + \text{Cable Loss [dB]} + \text{Other correction factors [dB]}$$

The combinations of correction factors are dependent upon the exact test configurations [see test equipment lists for further details] and may include:-

Antenna Factors, Pre Amplifier Gain, LISN Loss, Pulse Limiter Loss and Filter Insertion Loss

Note: to convert the results from dBuV/m to uV/m use the following formula:-

$$\text{Level in uV/m} = \text{Common Antilogarithm } [(X \text{ dBuV/m})/20] = Y \text{ uV/m}$$



## Measurement Uncertainty Values

voltage and power measurements	± 2 dB
conducted EIRP measurements	± 1.4 dB
radiated measurements	± 3.2 dB
frequency measurements	± 2.4 10 <sup>-7</sup>
temperature measurements	± 0.54°
humidity measurements	± 2.3%
DC and low frequency measurements	± 2.5%

Where relevant measurement uncertainty levels have been estimated for tests performed on the apparatus. This uncertainty represents an expanded uncertainty expressed at approximately the 95% confidence level using a coverage factor of k=2.

## Radiated emissions (expanded uncertainty, confidence interval 95%)

30 MHz - 300 MHz	+/- 3.8 dB
300 MHz - 1000 MHz	+/- 4.3 dB
1 GHz - 10 GHz	+/- 4.0 dB
10 GHz - 18GHz	+/- 8.2 dB
18GHz - 26.5GHz	+/- 4.1 dB
26.5GHz - 40GHz	+/- 3.9 dB

## Conducted emissions (expanded uncertainty, confidence interval 95%)

30 MHz – 40GHz	+/- 0.38 dB
----------------	-------------

A product is considered to comply with a requirement if the nominal measured value is below the limit line. The product is considered to not be in compliance in case the nominal measured value is above the limit line.

**This report must not be reproduced except in full, without written approval of Cisco Systems.**

**2.2 Date of testing**

01-Jan-16 - 29-Feb-16

**2.3 Report Issue Date**

24-March-2016

Cisco uses an electronic system to issue, store and control the revision of test reports. This system is called the Engineering Document Control System (EDCS). The actual report issue date is embedded into the original file on EDCS. Any copies of this report, either electronic or paper, that are not on EDCS must be considered uncontrolled.

**2.4 Testing facilities**

This assessment was performed by:

**Testing Laboratory**

Cisco Systems, Inc.,  
125 West Tasman Drive  
San Jose, CA 95134, USA

**Registration Numbers for Industry Canada**

<b>Cisco System Site</b>	<b>Address</b>	<b>Site Identifier</b>
Building P, 10m Chamber	125 West Tasman Dr San Jose, CA 95134	Company #: 2461N-2
Building P, 5m Chamber	125 West Tasman Dr San Jose, CA 95134	Company #: 2461N-1
Building I, 5m Chamber	285 W. Tasman Drive San Jose, California 95134	Company #: 2461M-1

**Test Engineers**

Jose Aguirre

**2.5 Equipment Assessed (EUT)**

AIR-AP3802P-B-K9



## 2.6 EUT Description

The Cisco Aironet 802.11ac Radio supports the following modes of operation. The modes are further defined in the radio Theory of Operation. The modes included in this report represent the worst case data for all modes.

- 802.11n/ac - Non HT20, One Antenna, 6 to 54 Mbps
- 802.11n/ac - Non HT20, Two Antennas, 6 to 54 Mbps
- 802.11n/ac - Non HT20, Three Antennas, 6 to 54 Mbps
- 802.11n/ac - Non HT20, Four Antennas, 6 to 54 Mbps
  
- 802.11n/ac - Non HT20 Beam Forming, Two Antennas, 6 to 54 Mbps
- 802.11n/ac - Non HT20 Beam Forming, Three Antennas, 6 to 54 Mbps
- 802.11n/ac - Non HT20 Beam Forming, Four Antennas, 6 to 54 Mbps
  
- 802.11n/ac - HT/VHT20, One Antenna, M0 to M7
- 802.11n/ac - HT/VHT20, Two Antennas, M0 to M7
- 802.11n/ac - HT/VHT20, Two Antennas, M8 to M15
- 802.11n/ac - HT/VHT20, Three Antennas, M0 to M7
- 802.11n/ac - HT/VHT20, Three Antennas, M8 to M15
- 802.11n/ac - HT/VHT20, Three Antennas, M16 to M23
- 802.11n/ac - HT/VHT20, Four Antennas, M0 to M7
- 802.11n/ac - HT/VHT20, Four Antennas, M8 to M15
- 802.11n/ac - HT/VHT20, Four Antennas, M16 to M23
  
- 802.11n/ac - HT/VHT20 Beam Forming, Two Antennas, M0 to M7
- 802.11n/ac - HT/VHT20 Beam Forming, Two Antennas, M8 to M15
- 802.11n/ac - HT/VHT20 Beam Forming, Three Antennas, M0 to M7
- 802.11n/ac - HT/VHT20 Beam Forming, Three Antennas, M8 to M15
- 802.11n/ac - HT/VHT20 Beam Forming, Three Antennas, M16 to M23
- 802.11n/ac - HT/VHT20 Beam Forming, Four Antennas, M0 to M7
- 802.11n/ac - HT/VHT20 Beam Forming, Four Antennas, M8 to M15
- 802.11n/ac - HT/VHT20 Beam Forming, Four Antennas, M16 to M23
  
- 802.11n/ac - HT/VHT20 STBC, Two Antennas, M0 to M7
- 802.11n/ac - HT/VHT20 STBC, Three Antennas, M0 to M7
- 802.11n/ac - HT/VHT20 STBC, Four Antennas, M0 to M7
  
- 802.11n/ac - Non HT40 Duplicate, One Antenna, 6 to 54 Mbps
- 802.11n/ac - Non HT40 Duplicate, Two Antennas, 6 to 54 Mbps
- 802.11n/ac - Non HT40 Duplicate, Three Antennas, 6 to 54 Mbps
- 802.11n/ac - Non HT40 Duplicate, Four Antennas, 6 to 54 Mbps
  
- 802.11n/ac - HT/VHT40, One Antenna, M0 to M7
- 802.11n/ac - HT/VHT40, Two Antennas, M0 to M7
- 802.11n/ac - HT/VHT40, Two Antennas, M8 to M15
- 802.11n/ac - HT/VHT40, Three Antennas, M0 to M7
- 802.11n/ac - HT/VHT40, Three Antennas, M8 to M15
- 802.11n/ac - HT/VHT40, Three Antennas, M16 to M23
- 802.11n/ac - HT/VHT40, Four Antennas, M0 to M7
- 802.11n/ac - HT/VHT40, Four Antennas, M8 to M15
- 802.11n/ac - HT/VHT40, Four Antennas, M16 to M23





802.11n/ac - HT/VHT40 Beam Forming, Two Antennas, M0 to M7  
802.11n/ac - HT/VHT40 Beam Forming, Two Antennas, M8 to M15  
802.11n/ac - HT/VHT40 Beam Forming, Three Antennas, M0 to M7  
802.11n/ac - HT/VHT40 Beam Forming, Three Antennas, M8 to M15  
802.11n/ac - HT/VHT40 Beam Forming, Three Antennas, M16 to M23  
802.11n/ac - HT/VHT40 Beam Forming, Four Antennas, M0 to M7  
802.11n/ac - HT/VHT40 Beam Forming, Four Antennas, M8 to M15  
802.11n/ac - HT/VHT40 Beam Forming, Four Antennas, M16 to M23

802.11n/ac - HT/VHT40 STBC, Two Antennas, M0 to M7  
802.11n/ac - HT/VHT40 STBC, Three Antennas, M0 to M7  
802.11n/ac - HT/VHT40 STBC, Four Antennas, M0 to M7

802.11n/ac - Non HT80 Duplicate, One Antenna, 6 to 54 Mbps  
802.11n/ac - Non HT80 Duplicate, Two Antennas, 6 to 54 Mbps  
802.11n/ac - Non HT80 Duplicate, Three Antennas, 6 to 54 Mbps  
802.11n/ac - Non HT80 Duplicate, Four Antennas, 6 to 54 Mbps

802.11ac - VHT80, One Antenna, M0 to M9 1ss  
802.11ac - VHT80, Two Antennas, M0 to M9 1ss  
802.11ac - VHT80, Two Antennas, M0 to M9 2ss  
802.11ac - VHT80, Three Antennas, M0 to M9 1ss  
802.11ac - VHT80, Three Antennas, M0 to M9 2ss  
802.11ac - VHT80, Three Antennas, M0 to M9 3ss  
802.11ac - VHT80, Four Antennas, M0 to M9 1ss  
802.11ac - VHT80, Four Antennas, M0 to M9 2ss  
802.11ac - VHT80, Four Antennas, M0 to M9 3ss

802.11ac - VHT80 Beam Forming, Two Antennas, M0 to M9 1ss  
802.11ac - VHT80 Beam Forming, Two Antennas, M0 to M9 2ss  
802.11ac - VHT80 Beam Forming, Three Antennas, M0 to M9 1ss  
802.11ac - VHT80 Beam Forming, Three Antennas, M0 to M9 2ss  
802.11ac - VHT80 Beam Forming, Three Antennas, M0 to M9 3ss  
802.11ac - VHT80 Beam Forming, Four Antennas, M0 to M9 1ss  
802.11ac - VHT80 Beam Forming, Four Antennas, M0 to M9 2ss  
802.11ac - VHT80 Beam Forming, Four Antennas, M0 to M9 3ss

802.11ac - VHT80 STBC, Two Antennas, M0 to M9 1ss  
802.11ac - VHT80 STBC, Three Antennas, M0 to M9 1ss  
802.11ac - VHT80 STBC, Four Antennas, M0 to M9 1ss



The following antennas are supported by this product series.  
The data included in this report represent the worst case data for all antennas.

Frequency	Part Number	Antenna Type	Antenna Gain (dBi)	Model	Antenna Gain >30 degrees (dBi)
<b>2.4 GHz</b>	AIR-ANT24020V-R	Omni	2	3800P	NA
	AIR-ANT2452V-R	Diversity Omni-directional	5.2	3800P	NA
	AIR-ANT2430V-R	MIMO 3-Element Omni	3	3800P	NA
	AIR-ANT2440NV-R	MIMO Wall-Mount Omni Antenna	4	3800P	NA
	AIR-ANT2460NP-R	MIMO 3-Element Patch	6	3800P	NA
<b>5 GHz</b>	AIR-ANT5140V-R	MIMO 3-Element Omni	4	3800P	Indoor Only
	AIR-ANT5140NV-R	MIMO Wall-Mount Omni Antenna	4	3800P	-8
	AIR-ANT5145V-R	Diversity Omni-directional	4.5	3800P	Indoor Only
	AIR-ANT5160NP-R	MIMO 3-Element Patch	6	3800P	3
<b>2.4 / 5 GHz</b>	AIR-ANT2451V-R	Omni	2 / 3	3800P	Indoor Only
	AIR-ANT2451NV-R	Omni	3 / 4	3800P	Indoor Only
	AIR-ANT2524DB-R	Dual-resonant black dipole	2 / 4	3800P	Indoor Only
	AIR-ANT2524DW-R	Dual-resonant white dipole	2 / 4	3800P	Indoor Only
	AIR-ANT2524DG-R	Dual-resonant gray dipole	2 / 4	3800P	Indoor Only
	AIR-ANT2524V4C-R	Dual-resonant ceiling mount omni (4-pack)	2 / 4	3800P	Indoor Only
	AIR-ANT2535SDW-R	Dual-resonant "stubby" monopole	3 / 5	3800P	Indoor Only
	AIR-ANT2544V4M-R	Dual-resonant omni (4-pack)	4 / 4	3800P	Indoor Only
	AIR-ANT2566P4W-R	Dual-resonant "directional" antenna (4-pack)	6 / 6	3800P	3
	AIR-ANT2566D4M-R	Dual-Band Polarization-Diverse Directional Array	6 / 6	3800P	3
	AIR-ANT2513P4M-N	Dual-resonant cross-pol "directional" antenna (4-pack)	13 / 13	3800P	-7
	AIR-ANT25-LOC-02	Directional HL / Directional WiFi	3 / 4	3800P	
	AIR-ANT25-LOC-03	Linear HL / Omni WiFi	0 / 1	3800P	
	AIR-ANT25-LOC-04	Omni HL / Omni WiFi	0 / 1	3800P	

### Section 3: Result Summary

#### 3.1 Results Summary Table

##### Conducted emissions

Basic Standard	Technical Requirements / Details	Result
FCC 15.407 RSS-247	<b>6dB Bandwidth:</b> Systems using digital modulation techniques may operate in the 2400-2483.5MHz band. The minimum 6dB bandwidth shall be at least 500 kHz.	Pass
FCC 15.407 RSS-247	<b>99% &amp; 26 dB Bandwidth:</b> The 99% occupied bandwidth is the frequency bandwidth such that, below its lower and above its upper frequency limits, the mean powers are each equal to 0.5% of the total mean power of the given emission. There is no limit for 99% OBW.  The 26 dB emission is the width of the emission that is constrained by the frequencies associated with the two outermost amplitude points (upper and lower frequencies) that are attenuated by 26 dB relative to the maximum level measured in the fundamental emission.	Pass
FCC 15.407 RSS-247	<b>Output Power:</b> For the band 5.725-5.85 GHz, the maximum conducted output power over the frequency band of operation shall not exceed 1 W.	Pass
FCC 15.407 RSS-247	<b>Power Spectral Density:</b> <b>15.407</b> The maximum power spectral density shall not exceed 30 dBm in any 500-kHz band.	Pass
FCC 15.407 RSS-247	<b>Conducted Spurious Emissions / Band-Edge:</b> For transmitters operating in the 5.725-5.85 GHz band: All emissions within the frequency range from the band edge to 10 MHz above or below the band edge shall not exceed an e.i.r.p. of -17 dBm/MHz; for frequencies 10 MHz or greater above or below the band edge, emissions shall not exceed an e.i.r.p. of -27 dBm/MHz.	Pass
FCC 15.407 FCC 15.209 FCC 152.05 RSS-247 RSS-Gen	<b>Restricted band:</b> Unwanted emissions falling within the restricted bands, as defined in FCC 15.205 (a) must also comply with the radiated emission limits specified in FCC 15.209 (a).	Pass

##### Radiated Emissions (General requirements)

Basic Standard	Technical Requirements / Details	Result
FCC 15.407 FCC 15.209 FCC 15.205 RSS-Gen	<b>TX Spurious Emissions:</b> Except as provided elsewhere in this subpart, the emissions from an intentional radiator shall not exceed the field strength levels specified in the filed strength limits table in this section.	Pass
FCC 15.207 RSS-Gen	<b>AC conducted Emissions:</b> Except when the requirements applicable to a given device state otherwise, for any radio apparatus equipped to operate from the public utility AC power supply, either directly or indirectly (such as with a battery charger), the radio frequency voltage of emissions conducted back onto the AC power lines in the frequency range of 0.15 MHz to 30 MHz shall not exceed the limits shown in the table in these sections. The more stringent limit applies at the frequency range boundaries.	Pass

\* MPE calculation is recorded in a separate report



## Section 4: Sample Details

Note: Each sample was evaluated to ensure that its condition was suitable to be used as a test sample prior to the commencement of testing.

### 4.1 Sample Details

Sample No.	Equipment Details	Manufacturer	Hardware Rev.	Firmware Rev.	Software Rev.	Serial Number
S01	AIR-AP3802P-B-K9	Cisco Systems	01	Linux ver 3.14.33	U-boot	FOC1945132D
S02*	PWR-CUBE-B 341-100460-001	Delta	A0	NA	NA	Engineering sample

(\*) S02 are support equipment Power supplies for EUT S01

### 4.2 System Details

System #	Description	Samples
1	AIR-AP3802P-B-K9	S01
2	PWR-CUBE-B	S02

### 4.3 Mode of Operation Details

Mode#	Description	Comments
1	Continuous Transmitting	Continuous Transmitting $\geq 98\%$ duty cycle

All measurements were made in accordance with

- ANSI C63.10:2013
- KDB 789033 D02 General UNII Test Procedures New Rules v01r01
- KDB 662911 D01 Multiple Transmitter Output v02r01

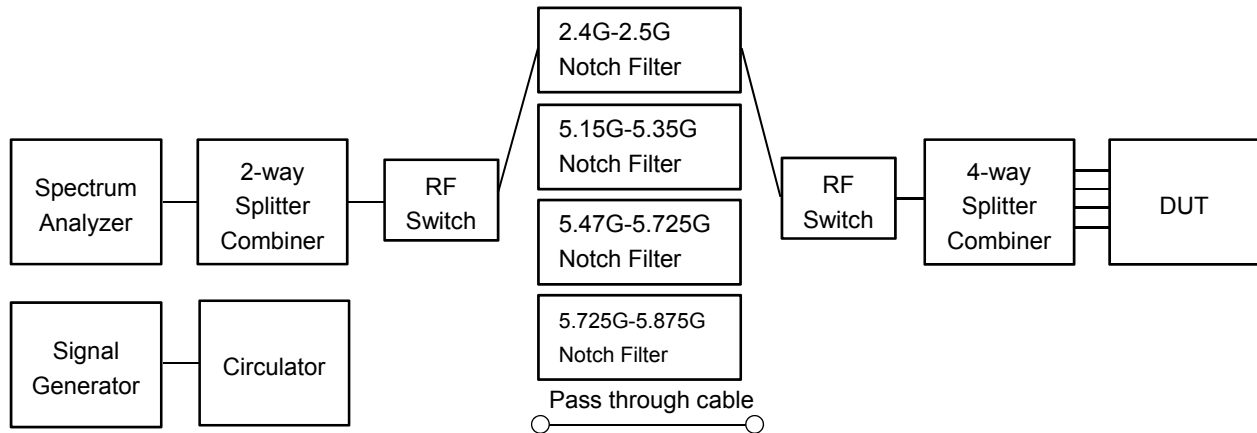
**Appendix A: Emission Test Results****Conducted Test Setup Diagram****Target Maximum Channel Power**

The following table details the maximum supported Total Channel Power for all operating modes.

**Antenna Gain : 2 dBi**

Operating Mode	Maximum Channel Power (dBm)	
	Frequency (MHz)	
	5745	5785
Non HT20, 6 to 54 Mbps	20	21
Non HT20 Beam Forming, 6 to 54 Mbps	16	21
HT/VHT20, M0 to M23	22	21
HT/VHT20 Beam Forming, M0 to M23	22	21
HT/VHT20 STBC, M0 to M7	22	21
	5755	5795
Non HT40, 6 to 54 Mbps	15	21
HT/VHT40, M0 to M23	20	21
HT/VHT40 Beam Forming, M0 to M23	18	21
HT/VHT40 STBC, M0 to M7	20	21
	5775	
Non HT80, 6 to 54 Mbps	16	
VHT80, M0 to M9, M0 to M9 1-1ss	19	
VHT80 Beam Forming, M0 to M9, M0 to M9 1-1ss	19	
VHT80 STBC, M0 to M9 1ss	19	

**Antenna Gain : 3 dBi**

Operating Mode	Maximum Channel Power (dBm)	
	Frequency (MHz)	
	5745	5785
Non HT20, 6 to 54 Mbps	20	21
Non HT20 Beam Forming, 6 to 54 Mbps	15	21
HT/VHT20, M0 to M23	22	21
HT/VHT20 Beam Forming, M0 to M23	20	21
HT/VHT20 STBC, M0 to M7	22	21
	5755	5795
Non HT40, 6 to 54 Mbps	15	21
HT/VHT40, M0 to M23	17	21
HT/VHT40 Beam Forming, M0 to M23	17	21
HT/VHT40 STBC, M0 to M7	17	21
	5775	
Non HT80, 6 to 54 Mbps	16	
VHT80, M0 to M9, M0 to M9 1-1ss	19	
VHT80 Beam Forming, M0 to M9, M0 to M9 1-1ss	18	
VHT80 STBC, M0 to M9 1ss	19	

**Antenna Gain : 4 dBi**

Operating Mode	Maximum Channel Power (dBm)	
	Frequency (MHz)	
	5745	5785
Non HT20, 6 to 54 Mbps	19	21
Non HT20 Beam Forming, 6 to 54 Mbps	14	21
HT/VHT20, M0 to M23	19	21
HT/VHT20 Beam Forming, M0 to M23	19	21
HT/VHT20 STBC, M0 to M7	19	21
	5755	5795
Non HT40, 6 to 54 Mbps	12	21
HT/VHT40, M0 to M23	17	21
HT/VHT40 Beam Forming, M0 to M23	17	21
HT/VHT40 STBC, M0 to M7	17	21
	5775	
Non HT80, 6 to 54 Mbps	15	
VHT80, M0 to M9, M0 to M9 1-1ss	18	
VHT80 Beam Forming, M0 to M9, M0 to M9 1-1ss	17	
VHT80 STBC, M0 to M9 1ss	18	

**Antenna Gain : 5 dBi**

Operating Mode	Maximum Channel Power (dBm)	
	Frequency (MHz)	
	5745	5785
Non HT20, 6 to 54 Mbps	18	21
Non HT20 Beam Forming, 6 to 54 Mbps	13	21
HT/VHT20, M0 to M23	19	21
HT/VHT20 Beam Forming, M0 to M23	19	21
HT/VHT20 STBC, M0 to M7	19	21
	5755	5795
Non HT40, 6 to 54 Mbps	12	21
HT/VHT40, M0 to M23	17	21
HT/VHT40 Beam Forming, M0 to M23	16	21
HT/VHT40 STBC, M0 to M7	17	21
	5775	
Non HT80, 6 to 54 Mbps	15	
VHT80, M0 to M9, M0 to M9 1-1ss	17	
VHT80 Beam Forming, M0 to M9, M0 to M9 1-1ss	17	
VHT80 STBC, M0 to M9 1ss	17	



**Antenna Gain : 6 dBi**

Operating Mode	Maximum Channel Power (dBm)	
	Frequency (MHz)	
	5745	5785
Non HT20, 6 to 54 Mbps	17	21
Non HT20 Beam Forming, 6 to 54 Mbps	12	21
HT/VHT20, M0 to M23	19	21
HT/VHT20 Beam Forming, M0 to M23	18	21
HT/VHT20 STBC, M0 to M7	19	21
	5755	5795
Non HT40, 6 to 54 Mbps	12	21
HT/VHT40, M0 to M23	16	21
HT/VHT40 Beam Forming, M0 to M23	16	21
HT/VHT40 STBC, M0 to M7	16	21
	5775	
Non HT80, 6 to 54 Mbps	15	
VHT80, M0 to M9, M0 to M9 1-1ss	17	
VHT80 Beam Forming, M0 to M9, M0 to M9 1-1ss	17	
VHT80 STBC, M0 to M9 1ss	17	

**Antenna Gain : 8 dBi**

Operating Mode	Maximum Channel Power (dBm)	
	Frequency (MHz)	
	5745	5785
Non HT20, 6 to 54 Mbps	16	21
Non HT20 Beam Forming, 6 to 54 Mbps	10	20
HT/VHT20, M0 to M23	16	21
HT/VHT20 Beam Forming, M0 to M23	15	21
HT/VHT20 STBC, M0 to M7	16	21
	5755	5795
Non HT40, 6 to 54 Mbps	10	21
HT/VHT40, M0 to M23	14	21
HT/VHT40 Beam Forming, M0 to M23	14	21
HT/VHT40 STBC, M0 to M7	14	21
	5775	
Non HT80, 6 to 54 Mbps	14	
VHT80, M0 to M9, M0 to M9 1-1ss	17	
VHT80 Beam Forming, M0 to M9, M0 to M9 1-1ss	15	
VHT80 STBC, M0 to M9 1ss	17	

**Antenna Gain : 13 dBi**

Operating Mode	Maximum Channel Power (dBm)	
	Frequency (MHz)	
	5745	5785
Non HT20, 6 to 54 Mbps	11	21
Non HT20 Beam Forming, 6 to 54 Mbps	9	17
HT/VHT20, M0 to M23	11	21
HT/VHT20 Beam Forming, M0 to M23	11	20
HT/VHT20 STBC, M0 to M7	11	21
	5755	5795
Non HT40, 6 to 54 Mbps	3	20
HT/VHT40, M0 to M23	9	21
HT/VHT40 Beam Forming, M0 to M23	9	19
HT/VHT40 STBC, M0 to M7	9	21
	5775	
Non HT80, 6 to 54 Mbps	9	
VHT80, M0 to M9, M0 to M9 1-1ss	10	
VHT80 Beam Forming, M0 to M9, M0 to M9 1-1ss	10	
VHT80 STBC, M0 to M9 1ss	10	



## A.1 6dB Bandwidth

**15.407** Within the 5.725-5.85 GHz band, the minimum 6 dB bandwidth of U-NII devices shall be at least 500 kHz.

### Test Procedure

Ref. KDB 789033 D02 General UNII Test Procedures New Rules v01r01  
ANSI C63.10: 2013

#### 6 BW

Test Procedure

1. Set the radio in the continuous transmitting mode.
2. Allow the trace to stabilize.
3. Setting the x-dB bandwidth mode to -6dB within the measurement set up function.
4. Select the automatic OBW measurement function of an instrument to perform bandwidth measurement.
5. Capture graphs and record pertinent measurement data.

Ref. KDB 789033 D02 General UNII Test Procedures New Rules v01r01  
ANSI C63.10: 2013 section 11.8.2 Option 2

#### 6 BW

Test parameters

X dB BW = 6dB (using the OBW function of the spectrum analyzer)

Span = Large enough to capture the entire EBW

RBW = 100 KHz

VBW  $\geq$  3 x RBW

Sweep = Auto couple

Detector = Peak or where practical sample shall be used

Trace = Max. Hold

System Number	Description	Samples	System under test	Support equipment
1	EUT	S01	<input checked="" type="checkbox"/>	<input type="checkbox"/>
	Support	S02	<input type="checkbox"/>	<input checked="" type="checkbox"/>

**Tested By :**

Jose Aguirre

**Date of testing:**

01-Jan-16 - 29-Feb-16

**Test Result : PASS**

See Appendix C for list of test equipment



Frequency (MHz)	Mode	Data Rate (Mbps)	6dB BW (MHz)	Limit (kHz)	Margin (MHz)
5745	Non HT20, 6 to 54 Mbps	6	16.4	>500	15.9
	HT/VHT20, M0 to M23	m0	17.4	>500	16.9
5755	Non HT40, 6 to 54 Mbps	6	35.8	>500	35.3
	HT/VHT40, M0 to M23	m0	35.5	>500	35.0
5775	Non HT80, 6 to 54 Mbps	6	76.0	>500	75.5
	VHT80, M0 to M9, M0 to M9 1-1ss	m0x1	76.0	>500	75.5
5785	Non HT20, 6 to 54 Mbps	6	16.4	>500	15.9
	HT/VHT20, M0 to M23	m0	17.6	>500	17.1
5795	Non HT40, 6 to 54 Mbps	6	36.2	>500	35.7
	HT/VHT40, M0 to M23	m0	35.6	>500	35.1
5825	Non HT20, 6 to 54 Mbps	6	16.4	>500	15.9
	HT/VHT20, M0 to M23	m0	17.5	>500	17.0



**6dB Bandwidth, 5745 MHz, Non HT20, 6 to 54 Mbps**

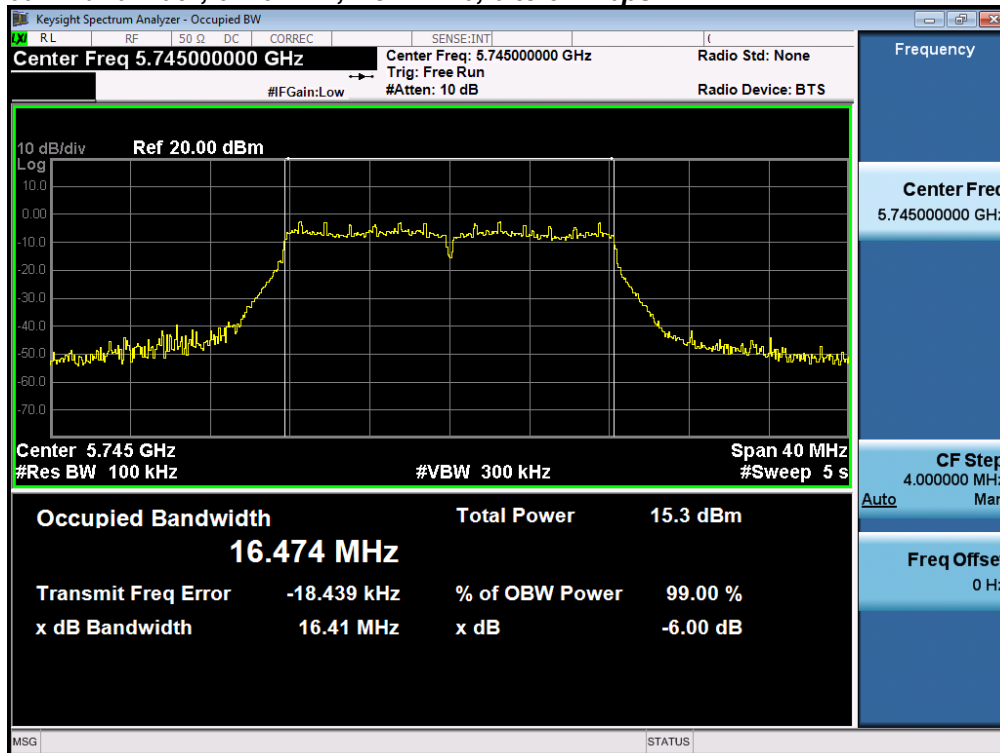

**6dB Bandwidth, 5745 MHz, HT/VHT20, M0 to M23**

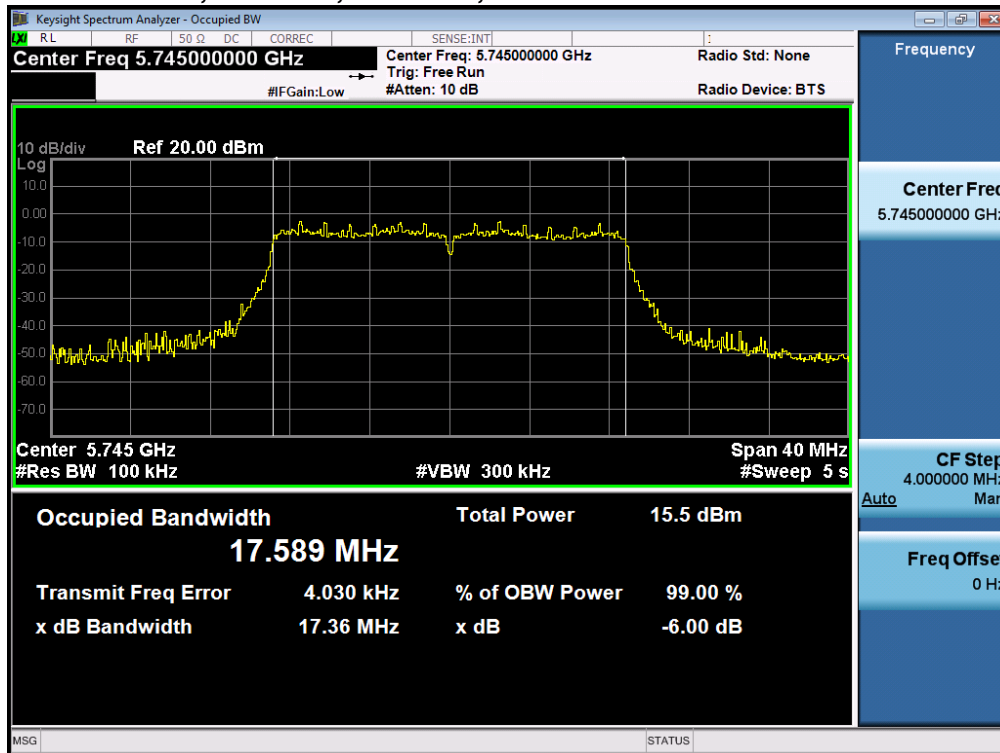



**6dB Bandwidth, 5755 MHz, Non HT40, 6 to 54 Mbps**

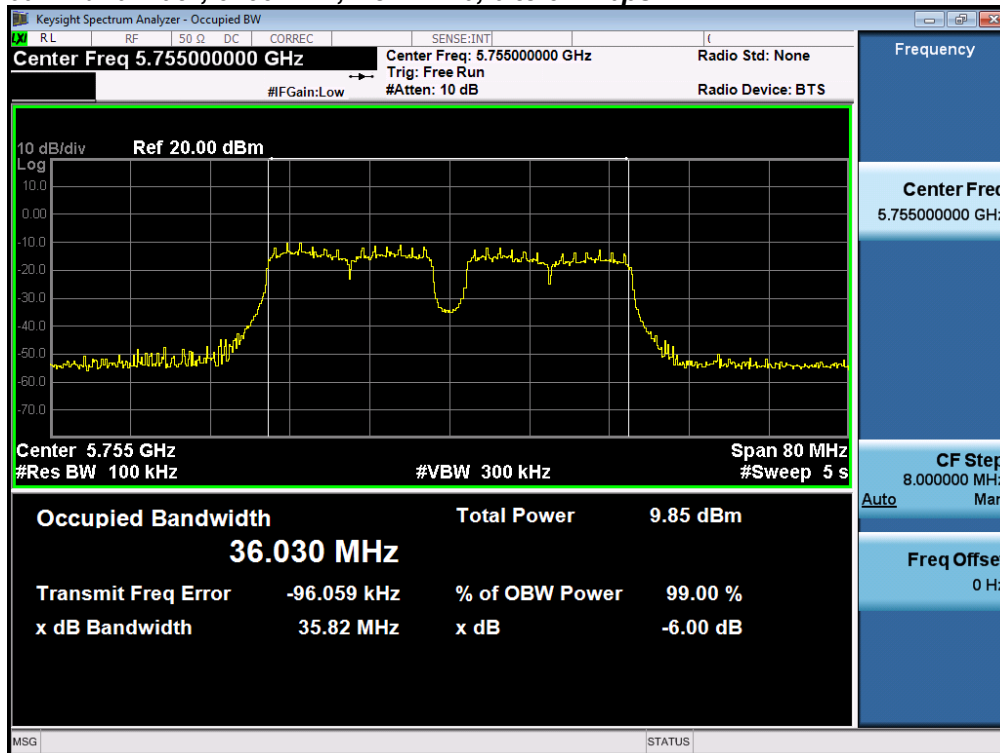

**6dB Bandwidth, 5755 MHz, HT/VHT40, M0 to M23**

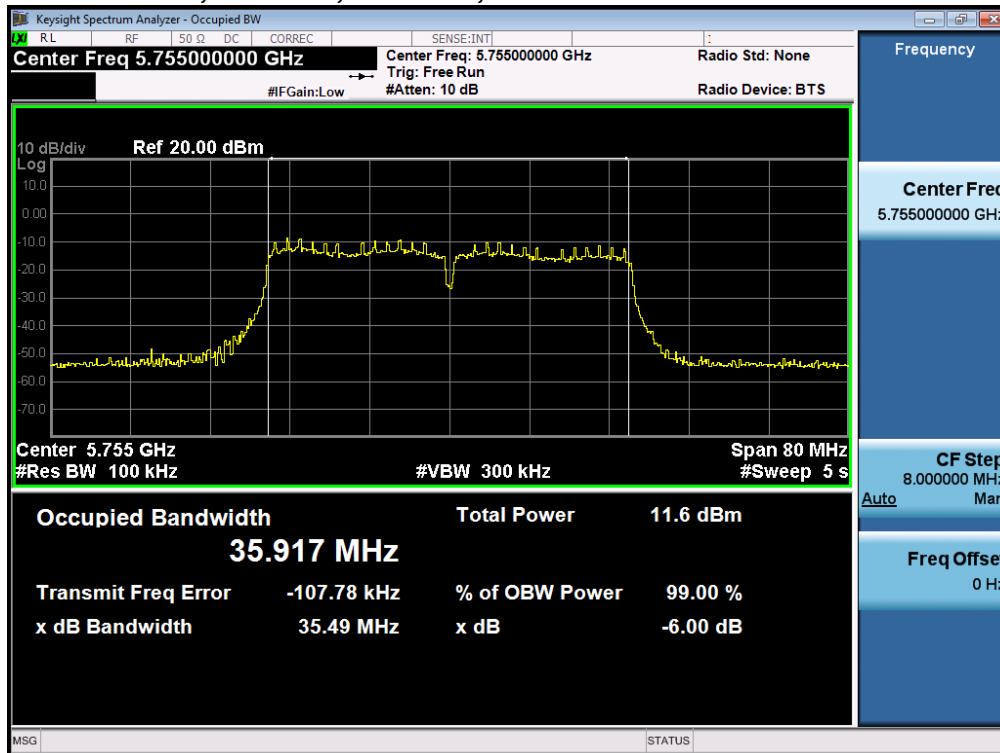



**6dB Bandwidth, 5775 MHz, Non HT80, 6 to 54 Mbps**

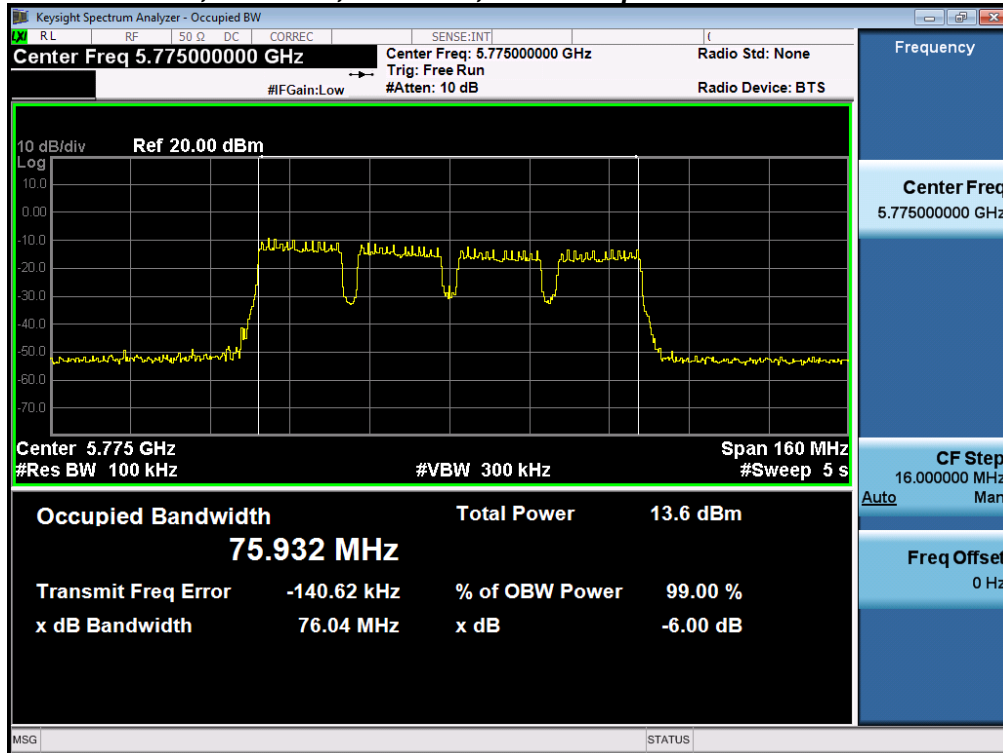

**6dB Bandwidth, 5775 MHz, VHT80, M0 to M9, M0 to M9 1-1ss**

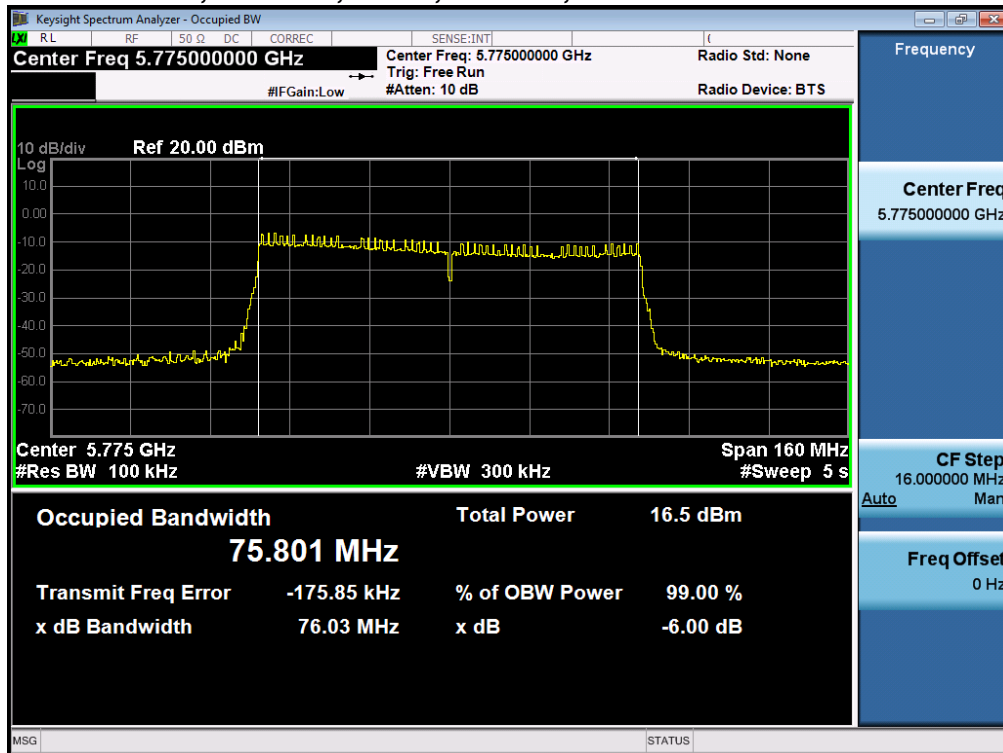





**6dB Bandwidth, 5785 MHz, Non HT20, 6 to 54 Mbps**

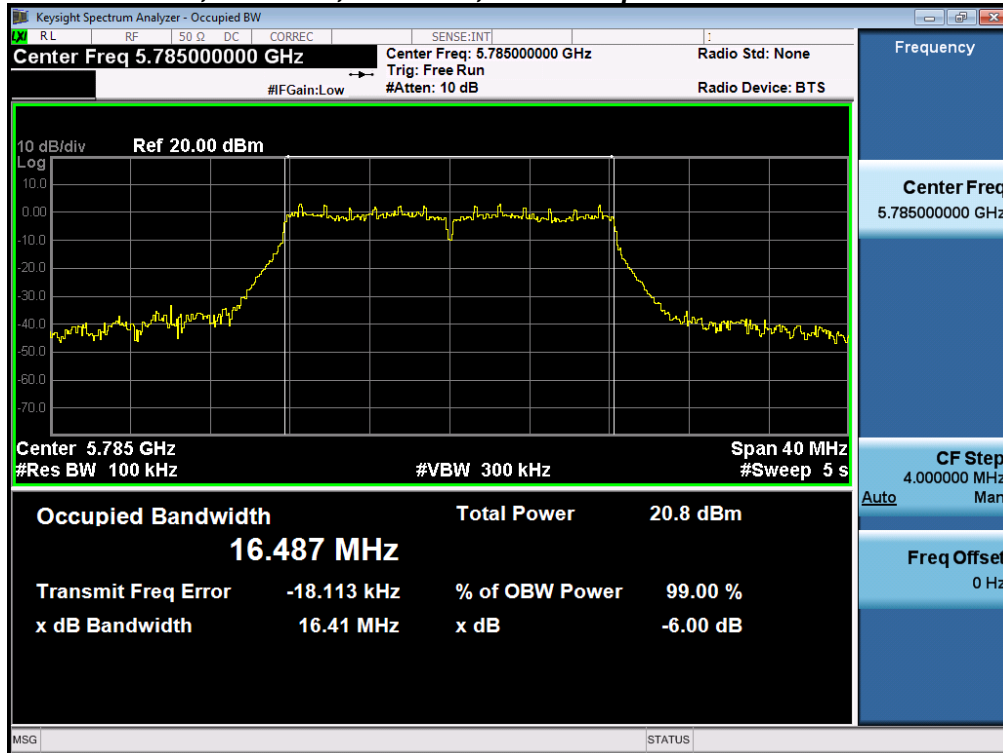

**6dB Bandwidth, 5785 MHz, HT/VHT20, M0 to M23**

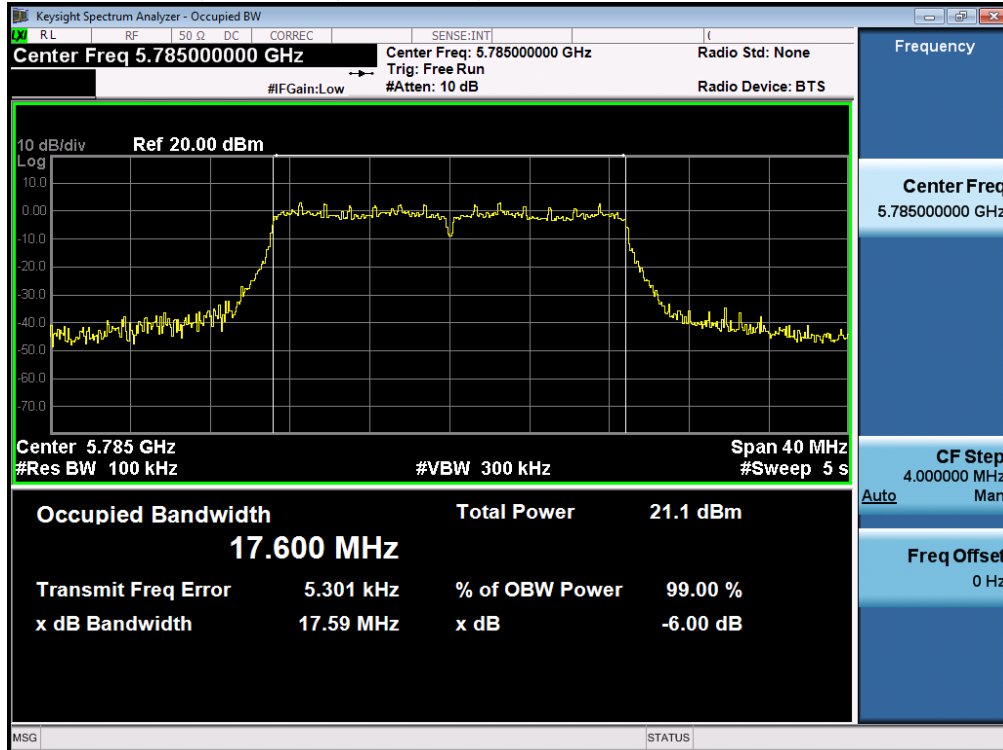



**6dB Bandwidth, 5795 MHz, Non HT40, 6 to 54 Mbps**

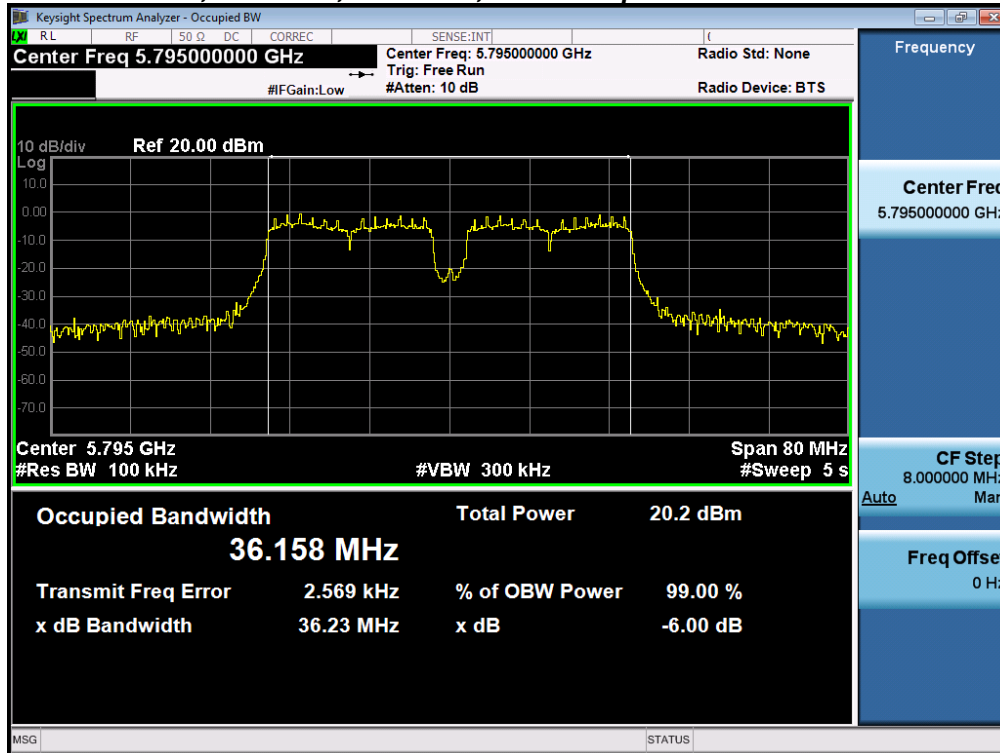

**6dB Bandwidth, 5795 MHz, HT/VHT40, M0 to M23**

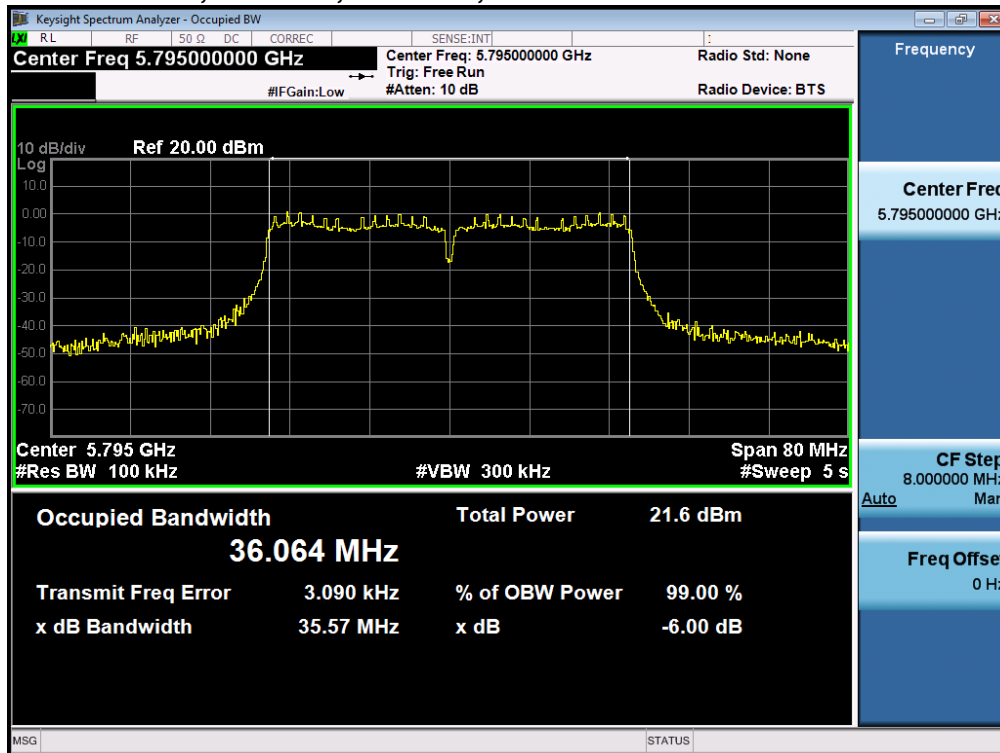



**6dB Bandwidth, 5825 MHz, Non HT20, 6 to 54 Mbps**

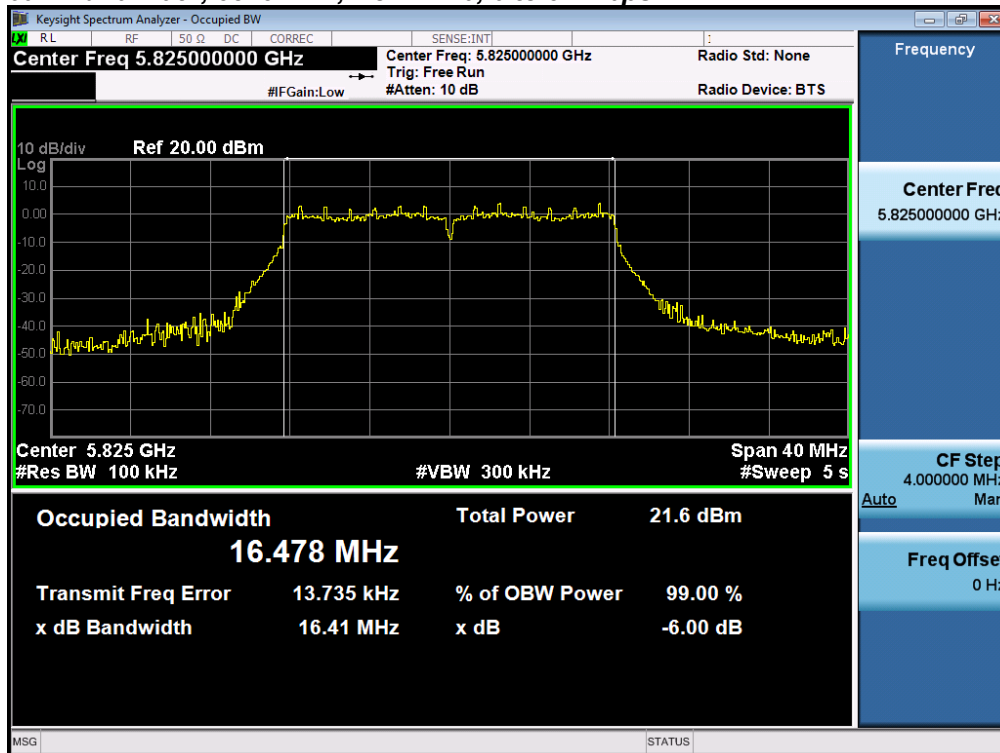

**6dB Bandwidth, 5825 MHz, HT/VHT20, M0 to M23**

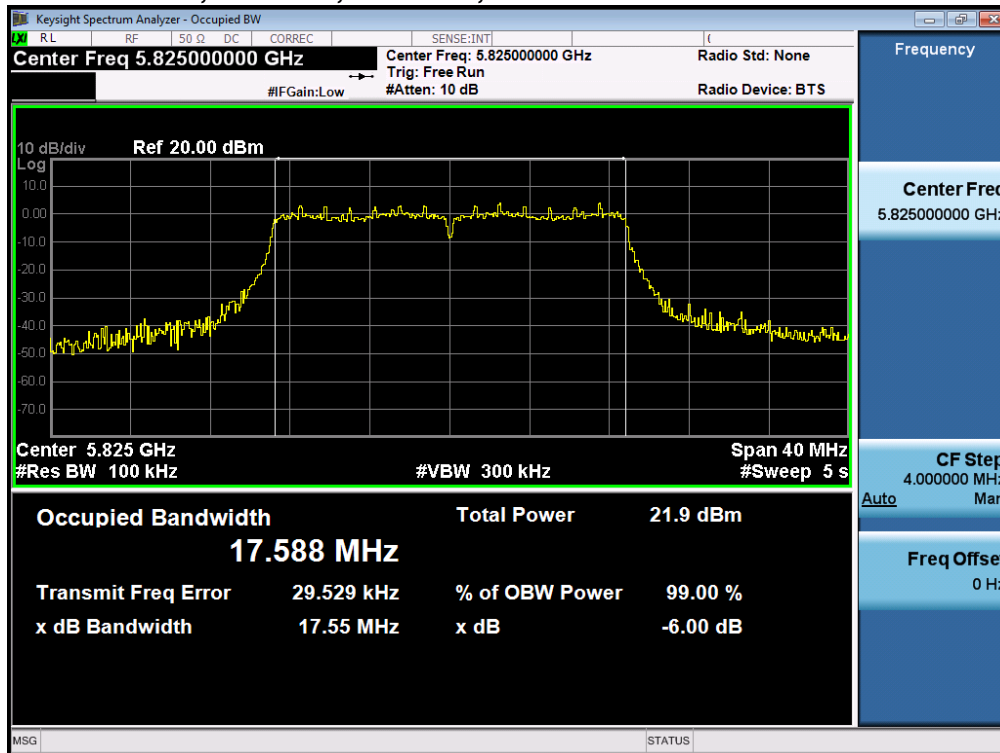



## A.2 99% and 26dB Bandwidth

**FCC 15.407** The 99% occupied bandwidth is the frequency bandwidth such that, below its lower and above its upper frequency limits, the mean powers are each equal to 0.5% of the total mean power of the given emission. There is no limit for 99% OBW.

The 26 dB emission is the width of the emission that is constrained by the frequencies associated with the two outermost amplitude points (upper and lower frequencies) that are attenuated by 26 dB relative to the maximum level measured in the fundamental emission.

### Test Procedure

Ref. ANSI C63.10: 2013 Section 6.9.3

#### 99% BW and EBW (-26dB)

Test Procedure

1. Set the radio in the continuous transmitting mode.
2. Allow the trace to stabilize.
3. Setting the x-dB bandwidth mode to -26dB and OBW power function to 99% within the measurement set up function.
4. Select the automatic OBW measurement function of an instrument to perform bandwidth measurement.
5. Capture graphs and record pertinent measurement data.

Ref. ANSI C63.10: 2013 Section 6.9.3

#### 99% BW and EBW (-26dB)

Test parameters

Span = 1.5 x to 5.0 times OBW

RBW = approx. 1% to 5% of the OBW

VBW ≥ 3 x RBW

Detector = Peak or where practical sample shall be used

Trace = Max. Hold

System Number	Description	Samples	System under test	Support equipment
1	EUT	S01	<input checked="" type="checkbox"/>	<input type="checkbox"/>
	Support	S02	<input type="checkbox"/>	<input checked="" type="checkbox"/>

**Tested By :**

Jose Aguirre

**Date of testing:**

01-Jan-16 - 29-Feb-16

**Test Result : PASS**

See Appendix C for list of test equipment



Frequency (MHz)	Mode	Data Rate (Mbps)	26dB BW (MHz)	99% BW (MHz)
5745	Non HT20, 6 to 54 Mbps	6	23.4	18.0
	HT/VHT20, M0 to M23	m0	22.9	18.3
5755	Non HT40, 6 to 54 Mbps	6	46.5	36.9
	HT/VHT40, M0 to M23	m0	42.8	36.6
5775	Non HT80, 6 to 54 Mbps	6	83.5	76.6
	VHT80, M0 to M9, M0 to M9 1-1ss	m0x1	83.3	76.8
5785	Non HT20, 6 to 54 Mbps	6	23.4	18.0
	HT/VHT20, M0 to M23	m0	23.1	18.3
5795	Non HT40, 6 to 54 Mbps	6	57.5	37.2
	HT/VHT40, M0 to M23	m0	45.4	36.8
5825	Non HT20, 6 to 54 Mbps	6	23.2	17.9
	HT/VHT20, M0 to M23	m0	24.3	18.3



**26dB / 99% Bandwidth, 5745 MHz, Non HT20, 6 to 54 Mbps**

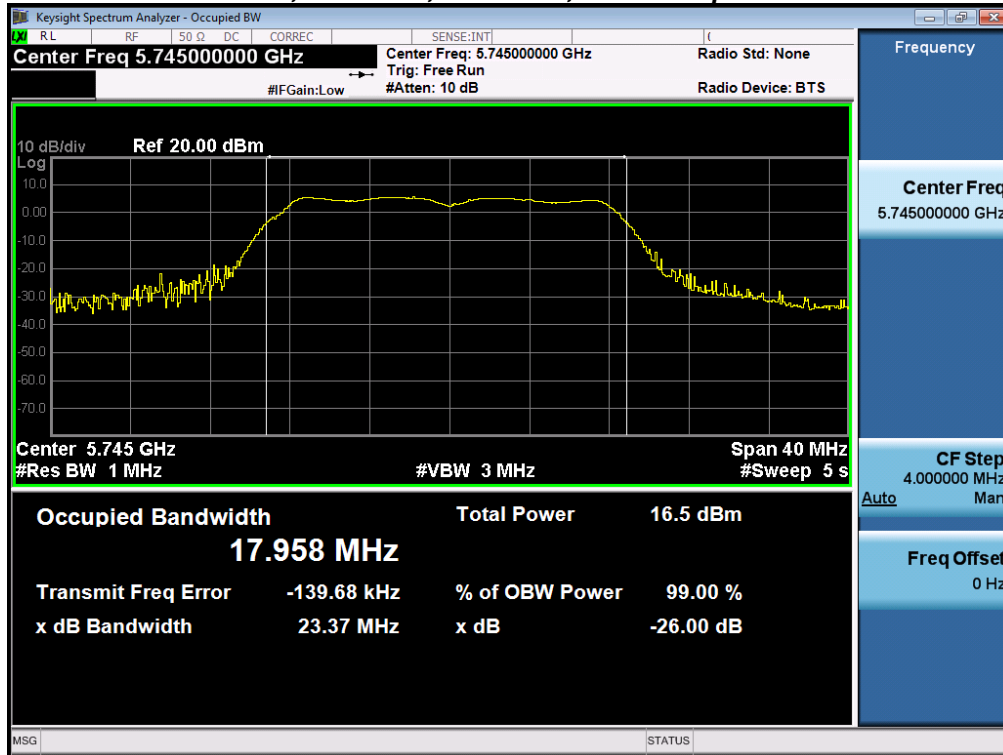

**26dB / 99% Bandwidth, 5745 MHz, HT/VHT20, M0 to M23**

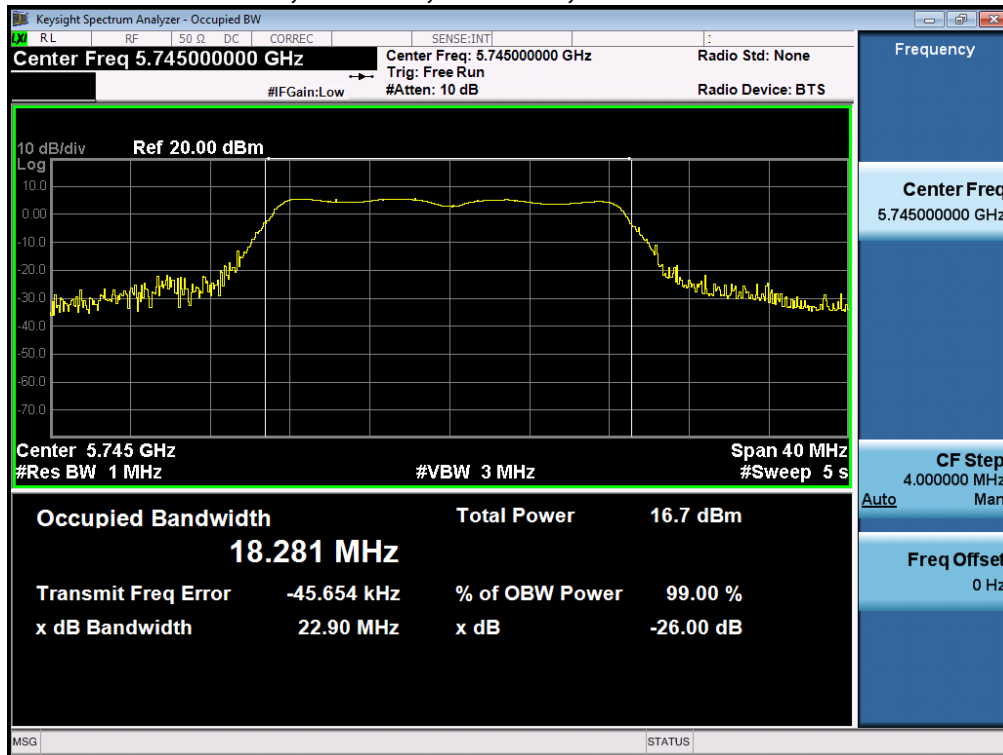



**26dB / 99% Bandwidth, 5755 MHz, Non HT40, 6 to 54 Mbps**

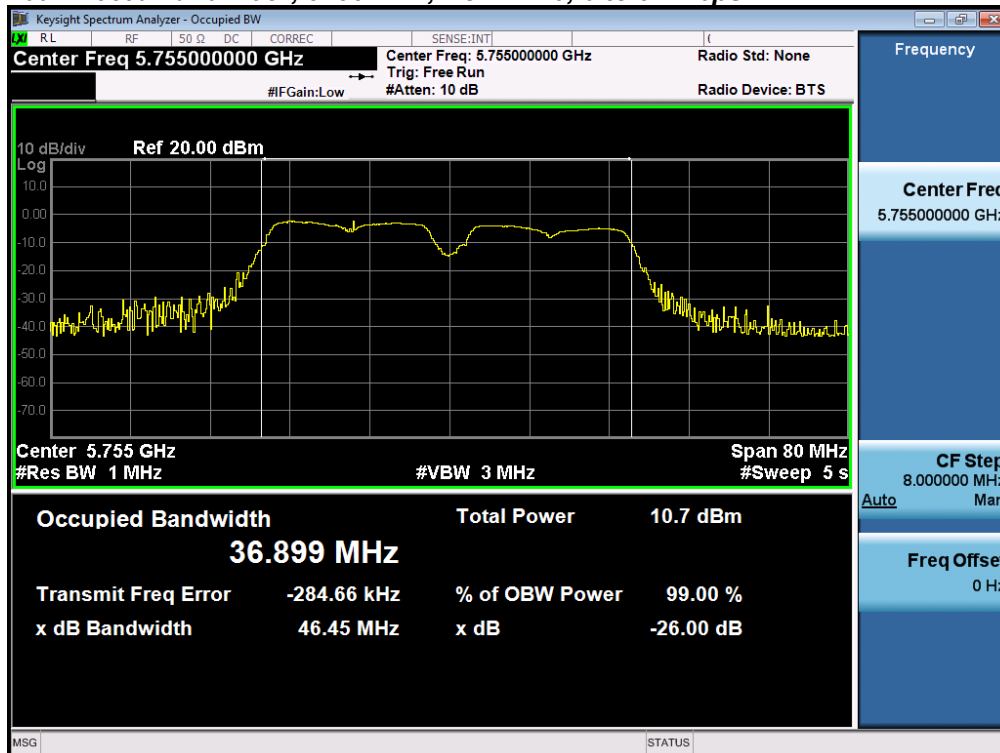

**26dB / 99% Bandwidth, 5755 MHz, HT/VHT40, M0 to M23**

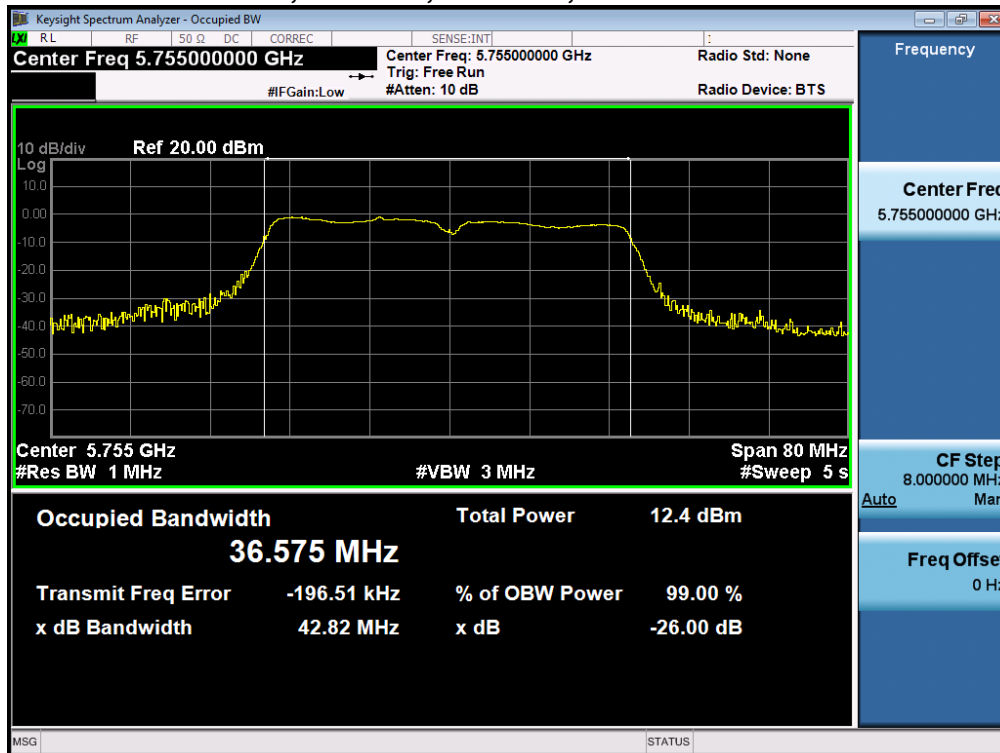



**26dB / 99% Bandwidth, 5775 MHz, Non HT80, 6 to 54 Mbps**

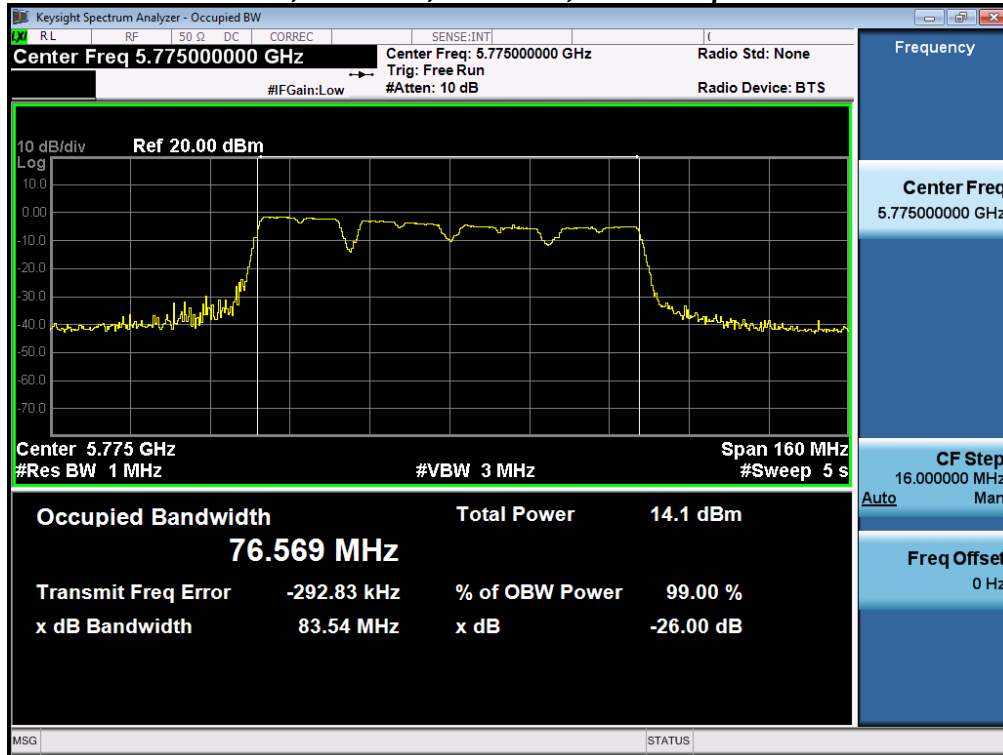

**26dB / 99% Bandwidth, 5775 MHz, VHT80, M0 to M9, M0 to M9 1-1ss**

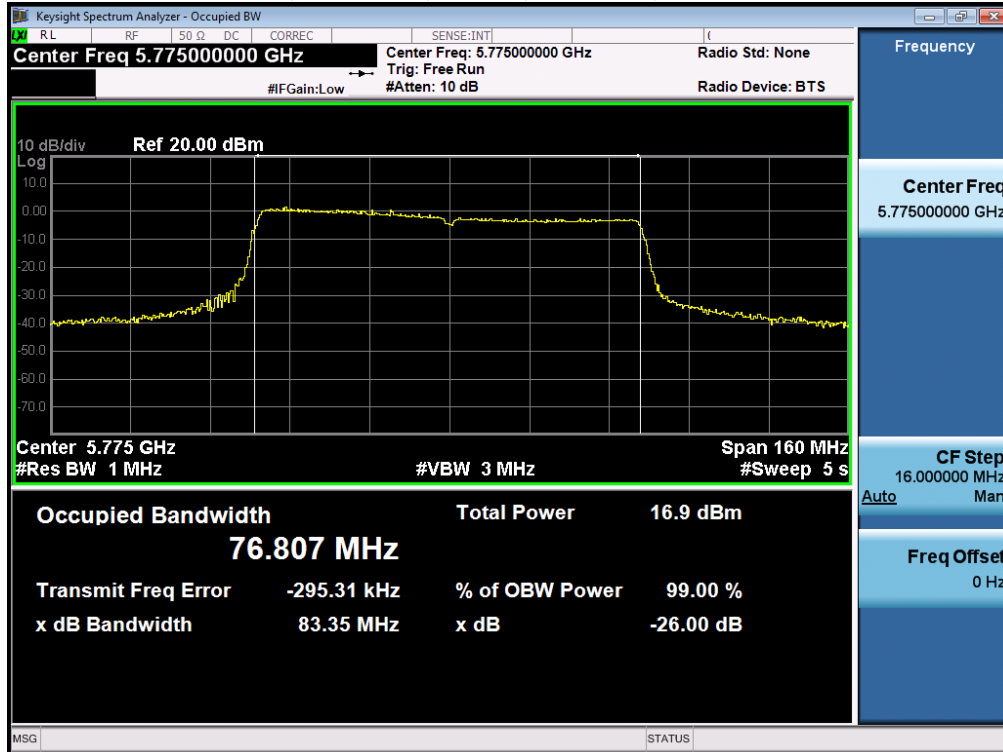





**26dB / 99% Bandwidth, 5785 MHz, Non HT20, 6 to 54 Mbps**

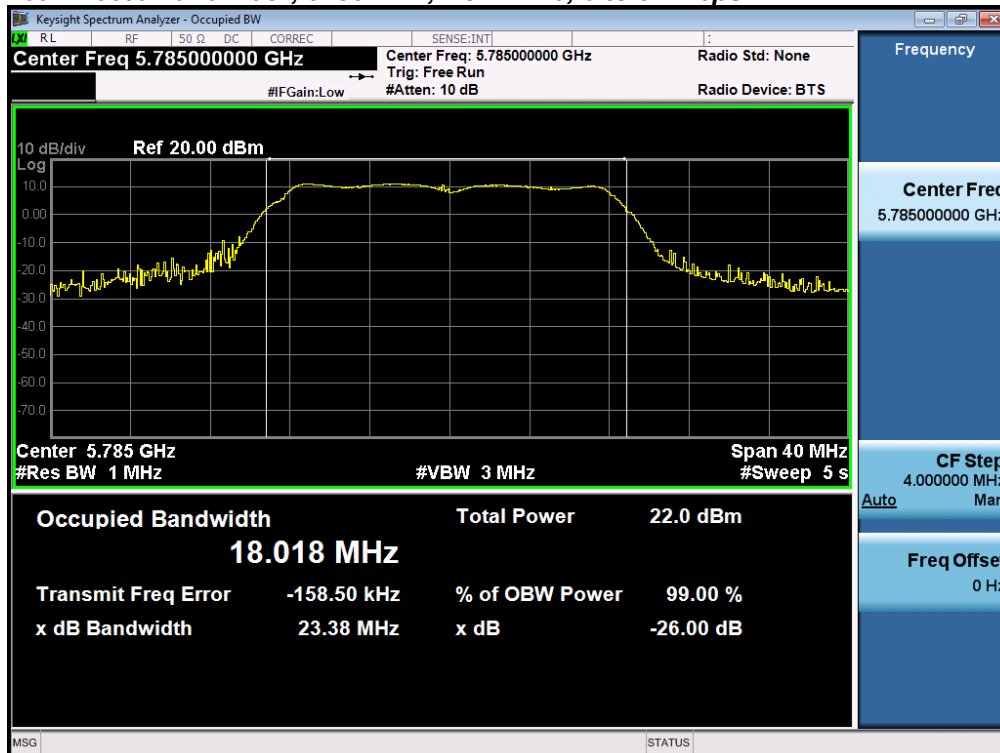

**26dB / 99% Bandwidth, 5785 MHz, HT/VHT20, M0 to M23**

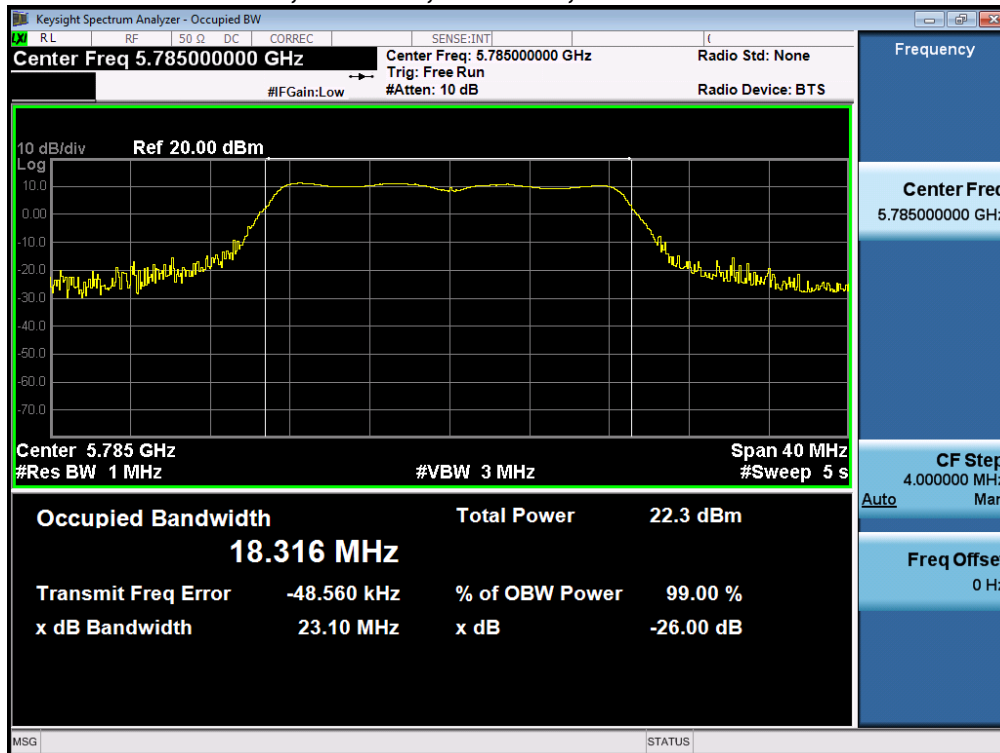



**26dB / 99% Bandwidth, 5795 MHz, Non HT40, 6 to 54 Mbps**

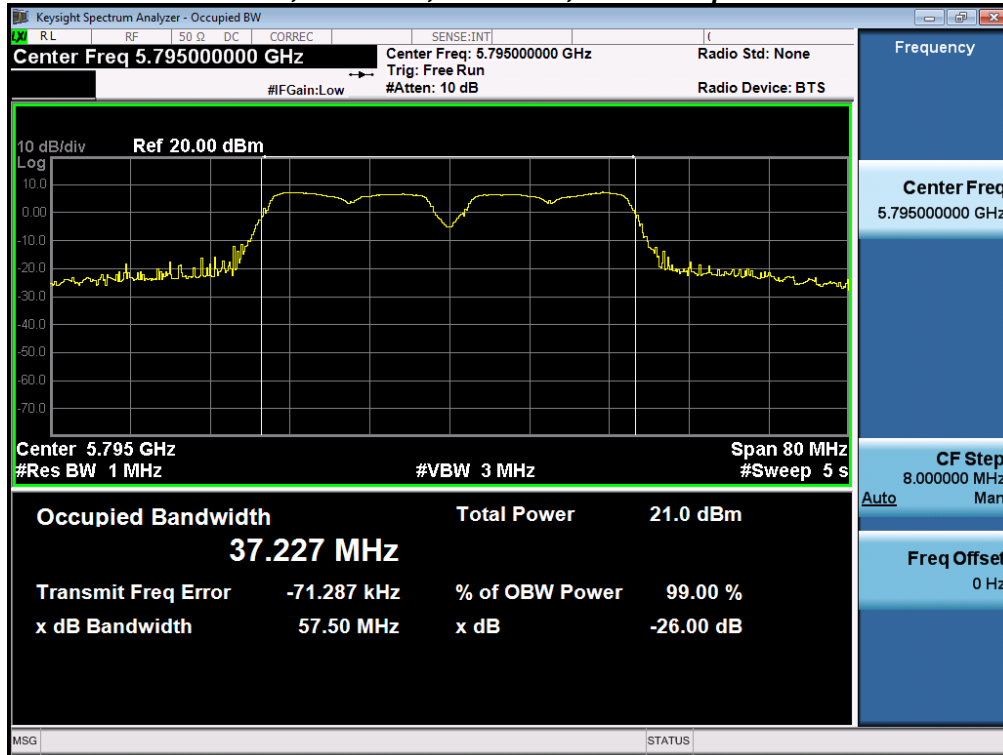

**26dB / 99% Bandwidth, 5795 MHz, HT/VHT40, M0 to M23**

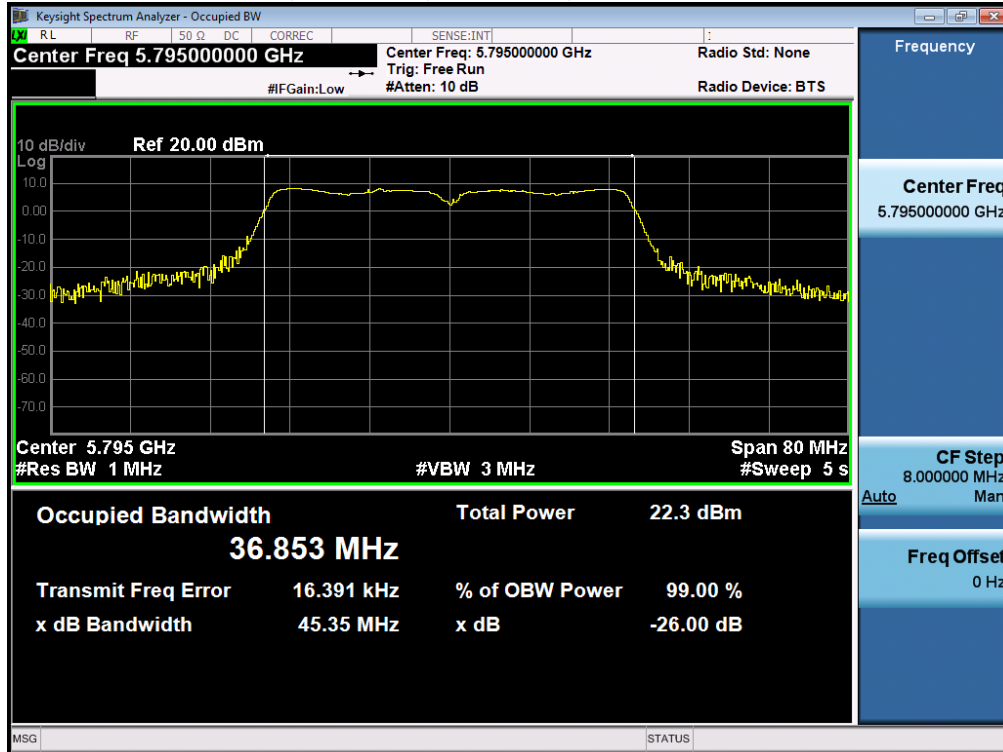



**26dB / 99% Bandwidth, 5825 MHz, Non HT20, 6 to 54 Mbps**

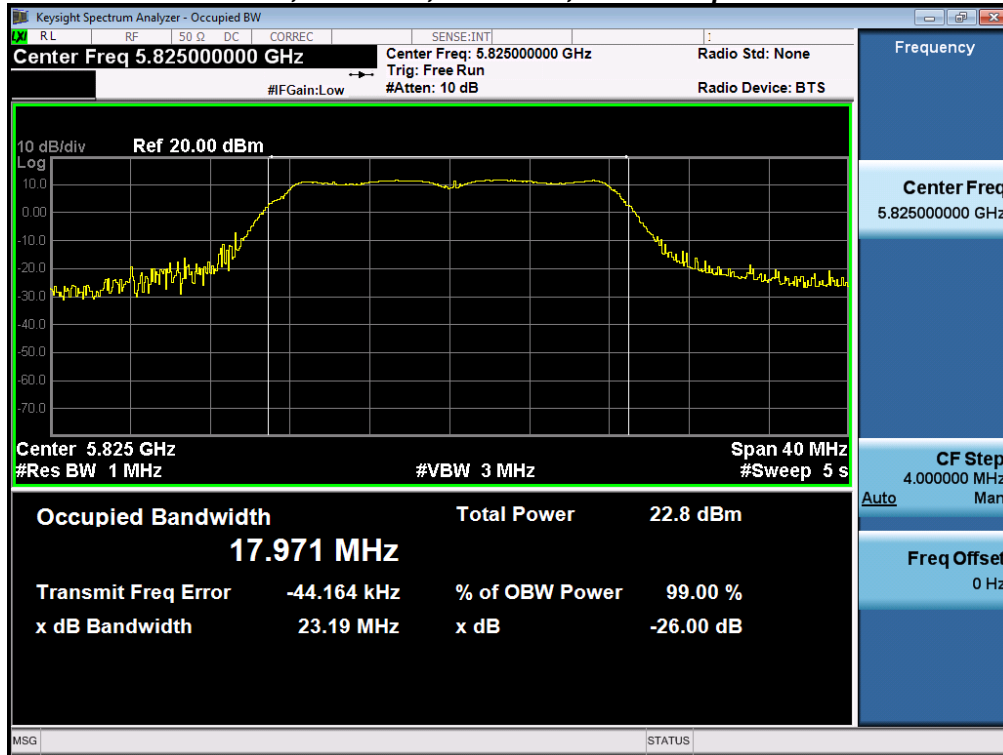

**26dB / 99% Bandwidth, 5825 MHz, HT/VHT20, M0 to M23**

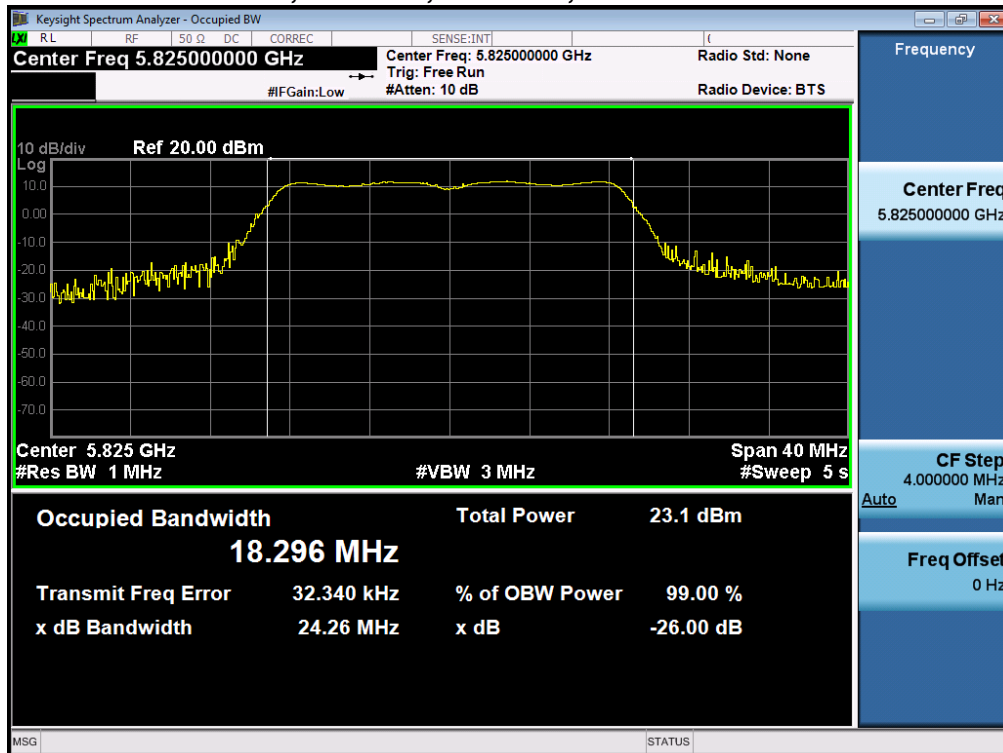



### A.3 Maximum Conducted Output Power

**15.407** (a) (3) For the band 5.725-5.85 GHz, the maximum conducted output power over the frequency band of operation shall not exceed 1 W. If transmitting antennas of directional gain greater than 6 dBi are used, both the maximum conducted output power and the maximum power spectral density shall be reduced by the amount in dB that the directional gain of the antenna exceeds 6 dBi. However, fixed point-to-point U-NII devices operating in this band may employ transmitting antennas with directional gain greater than 6 dBi without any corresponding reduction in transmitter conducted power. Fixed, point-to-point operations exclude the use of point-to-multipoint systems, omnidirectional applications, and multiple collocated transmitters transmitting the same information. The operator of the U-NII device, or if the equipment is professionally installed, the installer, is responsible for ensuring that systems employing high gain directional antennas are used exclusively for fixed, point-to-point operations.

The peak correlated gain for each mode is listed in the table below. See the Theory of Operation for details on the correlated gain for each mode.

#### Test Procedure

**Ref.** KDB 789033 D02 General UNII Test Procedures New Rules v01r01  
ANSI C63.10: 2013

<b>Output Power</b> Test Procedure
<ol style="list-style-type: none"> <li>1. Set the radio in the continuous transmitting mode at full power</li> <li>2. Compute power by integrating the spectrum across the EBW (or alternatively entire 99% OBW) of the signal using the instrument's band power measurement function. The integration shall be performed using the spectrum analyzer band-power measurement function with band limits set equal to the EBW or the OBW band edges.</li> <li>3. Capture graphs and record pertinent measurement data.</li> </ol>

**Ref.** KDB 789033 D02 General UNII Test Procedures New Rules v01r01  
ANSI C63.10: 2013 section 12.3.2.2 Method SA-1

<b>Output Power</b> Test parameters
Span = >1.5 times the OBW RBW = 1MHz VBW ≥ 3 x RBW Sweep = Auto couple Detector = sample Trace = Trace Average 100

The "measure-and-sum technique" is used for measuring in-band transmit power of a device. In the measure-and-sum approach, the conducted emission level is measured at each antenna port. The measured results at the various antenna ports are then summed mathematically to determine the total emission level from the device. Summing is performed in linear power units. (See ANSI C63.10 section 14.3.2.2)

System Number	Description	Samples	System under test	Support equipment
1	EUT	S01	<input checked="" type="checkbox"/>	<input type="checkbox"/>
	Support	S02	<input type="checkbox"/>	<input checked="" type="checkbox"/>

<b>Tested By :</b> Jose Aguirre	<b>Date of testing:</b> 01-Jan-16 - 29-Feb-16
<b>Test Result : PASS</b>	

See Appendix C for list of test equipment



## Antenna Gain : 2 dBi

Frequency (MHz)	Mode	Tx Paths	Correlated Antenna Gain (dBi)	Tx 1 Max Power (dBm)	Tx 2 Max Power (dBm)	Tx 3 Max Power (dBm)	Tx 4 Max Power (dBm)	Total Tx Channel Power (dBm)	Limit (dBm)	Margin (dB)	
5745	Non HT20, 6 to 54 Mbps	1	2	17.3				17.3	30.0	12.7	
	Non HT20, 6 to 54 Mbps	2	2	16.0	14.8			18.5	30.0	11.5	
	Non HT20, 6 to 54 Mbps	3	2	14.8	13.7	13.0		18.7	30.0	11.3	
	Non HT20, 6 to 54 Mbps	4	2	14.8	13.7	13.0	15.3	20.3	30.0	9.7	
	Non HT20 Beam Forming, 6 to 54 Mbps	2	5	13.6	12.5			16.1	30.0	13.9	
	Non HT20 Beam Forming, 6 to 54 Mbps	3	7	11.3	10.5	9.8		15.3	29.0	13.7	
	Non HT20 Beam Forming, 6 to 54 Mbps	4	8	10.4	9.4	8.7	11.2	16.0	28.0	12.0	
	HT/VHT20, M0 to M7	1	2	17.5				17.5	30.0	12.5	
	HT/VHT20, M0 to M7	2	2	16.2	15.0			18.7	30.0	11.3	
	HT/VHT20, M8 to M15	2	2	16.2	15.0			18.7	30.0	11.3	
	HT/VHT20, M0 to M7	3	2	16.2	15.0	14.3		20.0	30.0	10.0	
	HT/VHT20, M8 to M15	3	2	16.2	15.0	14.3		20.0	30.0	10.0	
	HT/VHT20, M16 to M23	3	2	16.2	15.0	14.3		20.0	30.0	10.0	
	HT/VHT20, M0 to M7	4	2	16.2	15.0	14.3	16.7	21.7	30.0	8.3	
	HT/VHT20, M8 to M15	4	2	16.2	15.0	14.3	16.7	21.7	30.0	8.3	
	HT/VHT20, M16 to M23	4	2	16.2	15.0	14.3	16.7	21.7	30.0	8.3	
	HT/VHT20 Beam Forming, M0 to M7	2	5	13.7	12.7			16.2	30.0	13.8	
	HT/VHT20 Beam Forming, M8 to M15	2	2	16.2	15.0			18.7	30.0	11.3	
	HT/VHT20 Beam Forming, M0 to M7	3	7	13.7	12.7	11.9		17.6	29.0	11.4	
	HT/VHT20 Beam Forming, M8 to M15	3	4	14.9	13.8	13.1		18.8	30.0	11.2	
	HT/VHT20 Beam Forming, M16 to M23	3	2	16.2	15.0	14.3		20.0	30.0	10.0	
	HT/VHT20 Beam Forming, M0 to M7	4	8	10.6	9.6	8.9	11.4	16.2	28.0	11.8	
	HT/VHT20 Beam Forming, M8 to M15	4	5	13.7	12.7	11.9	14.3	19.3	30.0	10.7	
	HT/VHT20 Beam Forming, M16 to M23	4	3	16.2	15.0	14.3	16.7	21.7	30.0	8.3	
	HT/VHT20 STBC, M0 to M7	2	2	16.2	15.0			18.7	30.0	11.3	
	HT/VHT20 STBC, M0 to M7	3	2	16.2	15.0	14.3		20.0	30.0	10.0	
	HT/VHT20 STBC, M0 to M7	4	2	16.2	15.0	14.3	16.7	21.7	30.0	8.3	
	5755	Non HT40, 6 to 54 Mbps	1	2	12.5				12.5	30.0	17.5
		Non HT40, 6 to 54 Mbps	2	2	12.5	11.5			15.0	30.0	15.0
		Non HT40, 6 to 54 Mbps	3	2	9.7	8.7	8.0		13.6	30.0	16.4
Non HT40, 6 to 54 Mbps		4	2	4.7	3.5	3.0	5.6	10.3	30.0	19.7	
HT/VHT40, M0 to M7		1	2	15.7				15.7	30.0	14.3	



	HT/VHT40, M0 to M7	2	2	14.5	13.4			17.0	30.0	13.0
	HT/VHT40, M8 to M15	2	2	14.5	13.4			17.0	30.0	13.0
	HT/VHT40, M0 to M7	3	2	14.5	13.4	12.7		18.4	30.0	11.6
	HT/VHT40, M8 to M15	3	2	14.5	13.4	12.7		18.4	30.0	11.6
	HT/VHT40, M16 to M23	3	2	14.5	13.4	12.7		18.4	30.0	11.6
	HT/VHT40, M0 to M7	4	2	14.5	13.4	12.7	15.1	20.0	30.0	10.0
	HT/VHT40, M8 to M15	4	2	14.5	13.4	12.7	15.1	20.0	30.0	10.0
	HT/VHT40, M16 to M23	4	2	14.5	13.4	12.7	15.1	20.0	30.0	10.0
	HT/VHT40 Beam Forming, M0 to M7	2	5	11.3	10.3			13.8	30.0	16.2
	HT/VHT40 Beam Forming, M8 to M15	2	2	14.5	13.4			17.0	30.0	13.0
	HT/VHT40 Beam Forming, M0 to M7	3	7	10.3	9.4	8.5		14.2	29.0	14.8
	HT/VHT40 Beam Forming, M8 to M15	3	4	11.3	10.3	9.6		15.2	30.0	14.8
	HT/VHT40 Beam Forming, M16 to M23	3	2	14.5	13.4	12.7		18.4	30.0	11.6
	HT/VHT40 Beam Forming, M0 to M7	4	8	6.3	5.1	4.6	7.2	11.9	28.0	16.1
	HT/VHT40 Beam Forming, M8 to M15	4	5	11.3	10.3	9.6	12.0	16.9	30.0	13.1
	HT/VHT40 Beam Forming, M16 to M23	4	3	11.3	10.3	9.6	12.0	16.9	30.0	13.1
	HT/VHT40 STBC, M0 to M7	2	2	14.5	13.4			17.0	30.0	13.0
	HT/VHT40 STBC, M0 to M7	3	2	14.5	13.4	12.7		18.4	30.0	11.6
	HT/VHT40 STBC, M0 to M7	4	2	14.5	13.4	12.7	15.1	20.0	30.0	10.0
5775	Non HT80, 6 to 54 Mbps	1	2	11.9				11.9	30.0	18.1
	Non HT80, 6 to 54 Mbps	2	2	11.9	11.7			14.8	30.0	15.2
	Non HT80, 6 to 54 Mbps	3	2	10.8	10.6	10.7		15.5	30.0	14.5
	Non HT80, 6 to 54 Mbps	4	2	9.7	9.4	9.5	11.2	16.0	30.0	14.0
	VHT80, M0 to M9 1ss	1	2	14.8				14.8	30.0	15.2
	VHT80, M0 to M9 1ss	2	2	13.7	13.5			16.6	30.0	13.4
	VHT80, M0 to M9 2ss	2	2	13.7	13.5			16.6	30.0	13.4
	VHT80, M0 to M9 1ss	3	2	12.5	12.3	12.4		17.2	30.0	12.8
	VHT80, M0 to M9 2ss	3	2	12.5	12.3	12.4		17.2	30.0	12.8
	VHT80, M0 to M9 3ss	3	2	12.5	12.3	12.4		17.2	30.0	12.8
	VHT80, M0 to M9 1ss	4	2	12.5	12.3	12.4	14.0	18.9	30.0	11.1
	VHT80, M0 to M9 2ss	4	2	12.5	12.3	12.4	14.0	18.9	30.0	11.1
	VHT80, M0 to M9 3ss	4	2	12.5	12.3	12.4	14.0	18.9	30.0	11.1
	VHT80 Beam Forming, M0 to M9 1ss	2	5	12.5	12.3			15.4	30.0	14.6
	VHT80 Beam Forming, M0 to M9 2ss	2	2	13.7	13.5			16.6	30.0	13.4
	VHT80 Beam Forming, M0 to M9 1ss	3	7	10.3	10.0	10.3		15.0	29.0	14.0
	VHT80 Beam Forming, M0 to M9 2ss	3	4	12.5	12.3	12.4		17.2	30.0	12.8
	VHT80 Beam Forming, M0 to M9 3ss	3	2	12.5	12.3	12.4		17.2	30.0	12.8
	VHT80 Beam Forming, M0 to M9 1ss	4	8	10.3	10.0	10.3	11.5	16.6	28.0	11.4
	VHT80 Beam Forming, M0 to M9 2ss	4	5	10.3	10.0	10.3	11.5	16.6	30.0	13.4
VHT80 Beam Forming, M0 to M9 3ss	4	3	12.5	12.3	12.4	14.0	18.9	30.0	11.1	



	VHT80 STBC, M0 to M9 1ss	2	2	13.7	13.5			16.6	30.0	13.4
	VHT80 STBC, M0 to M9 1ss	3	2	12.5	12.3	12.4		17.2	30.0	12.8
	VHT80 STBC, M0 to M9 1ss	4	2	12.5	12.3	12.4	14.0	18.9	30.0	11.1
5785	Non HT20, 6 to 54 Mbps	1	2	14.0				14.0	30.0	16.0
	Non HT20, 6 to 54 Mbps	2	2	14.0	14.1			17.1	30.0	12.9
	Non HT20, 6 to 54 Mbps	3	2	14.0	14.1	13.7		18.7	30.0	11.3
	Non HT20, 6 to 54 Mbps	4	2	14.0	14.1	13.7	15.8	20.5	30.0	9.5
	Non HT20 Beam Forming, 6 to 54 Mbps	2	5	14.0	14.1			17.1	30.0	12.9
	Non HT20 Beam Forming, 6 to 54 Mbps	3	7	14.0	14.1	13.7		18.7	29.0	10.3
	Non HT20 Beam Forming, 6 to 54 Mbps	4	8	14.0	14.1	13.7	15.8	20.5	28.0	7.5
	HT/VHT20, M0 to M7	1	2	14.2				14.2	30.0	15.8
	HT/VHT20, M0 to M7	2	2	14.2	14.4			17.3	30.0	12.7
	HT/VHT20, M8 to M15	2	2	14.2	14.4			17.3	30.0	12.7
	HT/VHT20, M0 to M7	3	2	14.2	14.4	13.9		18.9	30.0	11.1
	HT/VHT20, M8 to M15	3	2	14.2	14.4	13.9		18.9	30.0	11.1
	HT/VHT20, M16 to M23	3	2	14.2	14.4	13.9		18.9	30.0	11.1
	HT/VHT20, M0 to M7	4	2	14.2	14.4	13.9	16.0	20.7	30.0	9.3
	HT/VHT20, M8 to M15	4	2	14.2	14.4	13.9	16.0	20.7	30.0	9.3
	HT/VHT20, M16 to M23	4	2	14.2	14.4	13.9	16.0	20.7	30.0	9.3
	HT/VHT20 Beam Forming, M0 to M7	2	5	14.2	14.4			17.3	30.0	12.7
	HT/VHT20 Beam Forming, M8 to M15	2	2	14.2	14.4			17.3	30.0	12.7
	HT/VHT20 Beam Forming, M0 to M7	3	7	14.2	14.4	13.9		18.9	29.0	10.1
	HT/VHT20 Beam Forming, M8 to M15	3	4	14.2	14.4	13.9		18.9	30.0	11.1
	HT/VHT20 Beam Forming, M16 to M23	3	2	14.2	14.4	13.9		18.9	30.0	11.1
	HT/VHT20 Beam Forming, M0 to M7	4	8	14.2	14.4	13.9	16.0	20.7	28.0	7.3
	HT/VHT20 Beam Forming, M8 to M15	4	5	14.2	14.4	13.9	16.0	20.7	30.0	9.3
	HT/VHT20 Beam Forming, M16 to M23	4	3	14.2	14.4	13.9	16.0	20.7	30.0	9.3
	HT/VHT20 STBC, M0 to M7	2	2	14.2	14.4			17.3	30.0	12.7
	HT/VHT20 STBC, M0 to M7	3	2	14.2	14.4	13.9		18.9	30.0	11.1
	HT/VHT20 STBC, M0 to M7	4	2	14.2	14.4	13.9	16.0	20.7	30.0	9.3
5795	Non HT40, 6 to 54 Mbps	1	2	14.2				14.2	30.0	15.8
	Non HT40, 6 to 54 Mbps	2	2	14.2	14.5			17.4	30.0	12.6
	Non HT40, 6 to 54 Mbps	3	2	14.2	14.5	15.1		19.4	30.0	10.6
	Non HT40, 6 to 54 Mbps	4	2	14.2	14.5	15.1	16.2	21.1	30.0	8.9
	HT/VHT40, M0 to M7	1	2	14.2				14.2	30.0	15.8
	HT/VHT40, M0 to M7	2	2	14.2	13.4			16.8	30.0	13.2
	HT/VHT40, M8 to M15	2	2	14.2	13.4			16.8	30.0	13.2
	HT/VHT40, M0 to M7	3	2	14.2	13.4	13.9		18.6	30.0	11.4
	HT/VHT40, M8 to M15	3	2	14.2	13.4	13.9		18.6	30.0	11.4



HT/VHT40, M16 to M23	3	2	14.2	13.4	13.9		18.6	30.0	11.4
HT/VHT40, M0 to M7	4	2	14.2	13.4	13.9	16.1	20.5	30.0	9.5
HT/VHT40, M8 to M15	4	2	14.2	13.4	13.9	16.1	20.5	30.0	9.5
HT/VHT40, M16 to M23	4	2	14.2	13.4	13.9	16.1	20.5	30.0	9.5
HT/VHT40 Beam Forming, M0 to M7	2	5	14.2	13.4			16.8	30.0	13.2
HT/VHT40 Beam Forming, M8 to M15	2	2	14.2	13.4			16.8	30.0	13.2
HT/VHT40 Beam Forming, M0 to M7	3	7	14.2	13.4	13.9		18.6	29.0	10.4
HT/VHT40 Beam Forming, M8 to M15	3	4	14.2	13.4	13.9		18.6	30.0	11.4
HT/VHT40 Beam Forming, M16 to M23	3	2	14.2	13.4	13.9		18.6	30.0	11.4
HT/VHT40 Beam Forming, M0 to M7	4	8	14.2	13.4	13.9	16.1	20.5	28.0	7.5
HT/VHT40 Beam Forming, M8 to M15	4	5	14.2	13.4	13.9	16.1	20.5	30.0	9.5
HT/VHT40 Beam Forming, M16 to M23	4	3	14.2	13.4	13.9	16.1	20.5	30.0	9.5
HT/VHT40 STBC, M0 to M7	2	2	14.2	13.4			16.8	30.0	13.2
HT/VHT40 STBC, M0 to M7	3	2	14.2	13.4	13.9		18.6	30.0	11.4
HT/VHT40 STBC, M0 to M7	4	2	14.2	13.4	13.9	16.1	20.5	30.0	9.5
<b>5825</b>									
Non HT20, 6 to 54 Mbps	1	2	14.8				14.8	30.0	15.2
Non HT20, 6 to 54 Mbps	2	2	14.8	13.9			17.4	30.0	12.6
Non HT20, 6 to 54 Mbps	3	2	14.8	13.9	13.4		18.8	30.0	11.2
Non HT20, 6 to 54 Mbps	4	2	14.8	13.9	13.4	15.8	20.6	30.0	9.4
Non HT20 Beam Forming, 6 to 54 Mbps	2	5	14.8	13.9			17.4	30.0	12.6
Non HT20 Beam Forming, 6 to 54 Mbps	3	7	14.8	13.9	13.4		18.8	29.0	10.2
Non HT20 Beam Forming, 6 to 54 Mbps	4	8	14.8	13.9	13.4	15.8	20.6	28.0	7.4
HT/VHT20, M0 to M7	1	2	15.0				15.0	30.0	15.0
HT/VHT20, M0 to M7	2	2	15.0	14.1			17.6	30.0	12.4
HT/VHT20, M8 to M15	2	2	15.0	14.1			17.6	30.0	12.4
HT/VHT20, M0 to M7	3	2	15.0	14.1	13.6		19.0	30.0	11.0
HT/VHT20, M8 to M15	3	2	15.0	14.1	13.6		19.0	30.0	11.0
HT/VHT20, M16 to M23	3	2	15.0	14.1	13.6		19.0	30.0	11.0
HT/VHT20, M0 to M7	4	2	15.0	14.1	13.6	16.1	20.8	30.0	9.2
HT/VHT20, M8 to M15	4	2	15.0	14.1	13.6	16.1	20.8	30.0	9.2
HT/VHT20, M16 to M23	4	2	15.0	14.1	13.6	16.1	20.8	30.0	9.2
HT/VHT20 Beam Forming, M0 to M7	2	5	15.0	14.1			17.6	30.0	12.4
HT/VHT20 Beam Forming, M8 to M15	2	2	15.0	14.1			17.6	30.0	12.4
HT/VHT20 Beam Forming, M0 to M7	3	7	15.0	14.1	13.6		19.0	29.0	10.0
HT/VHT20 Beam Forming, M8 to M15	3	4	15.0	14.1	13.6		19.0	30.0	11.0
HT/VHT20 Beam Forming, M16 to M23	3	2	15.0	14.1	13.6		19.0	30.0	11.0
<b>HT/VHT20 Beam Forming, M0 to M7</b>	<b>4</b>	<b>8</b>	<b>15.0</b>	<b>14.1</b>	<b>13.6</b>	<b>16.1</b>	<b>20.8</b>	<b>28.0</b>	<b>7.2</b>
HT/VHT20 Beam Forming, M8 to M15	4	5	15.0	14.1	13.6	16.1	20.8	30.0	9.2
HT/VHT20 Beam Forming, M16 to M23	4	3	15.0	14.1	13.6	16.1	20.8	30.0	9.2
HT/VHT20 STBC, M0 to M7	2	2	15.0	14.1			17.6	30.0	12.4





HT/VHT20 STBC, M0 to M7	3	2	15.0	14.1	13.6		19.0	30.0	11.0
HT/VHT20 STBC, M0 to M7	4	2	15.0	14.1	13.6	16.1	20.8	30.0	9.2



**Peak Output Power, 5825 MHz, HT/VHT20 Beam Forming, M0 to M7**

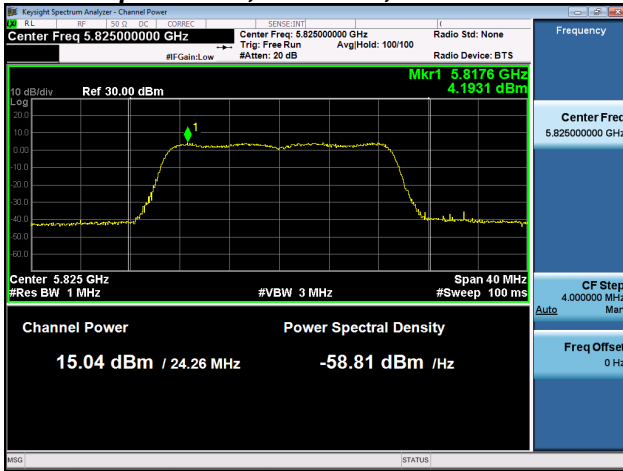

**Antenna A**

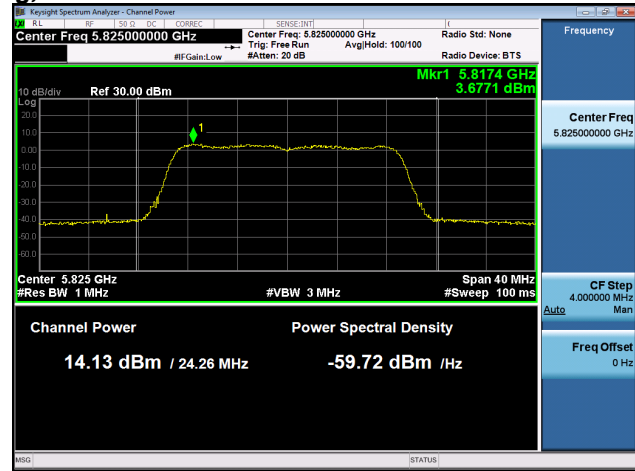

**Antenna B**

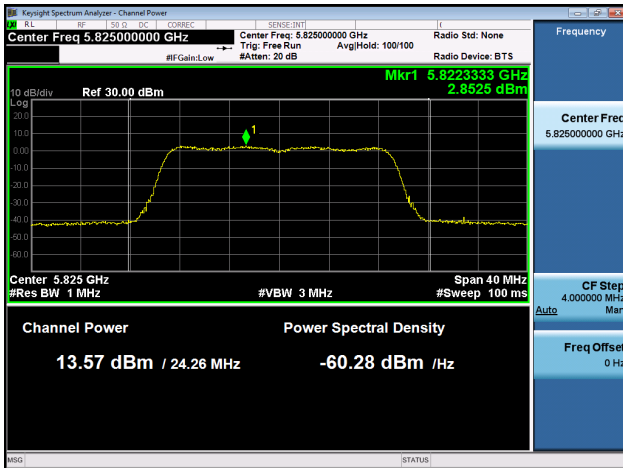

**Antenna C**

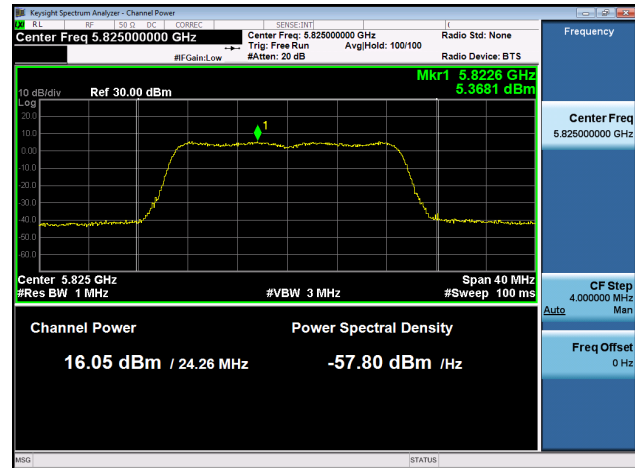

**Antenna D**



## Antenna Gain : 3 dBi

Frequency (MHz)	Mode	Tx Paths	Correlated Antenna Gain (dBi)	Tx 1 Max Power (dBm)	Tx 2 Max Power (dBm)	Tx 3 Max Power (dBm)	Tx 4 Max Power (dBm)	Total Tx Channel Power (dBm)	Limit (dBm)	Margin (dB)
5745	Non HT20, 6 to 54 Mbps	1	3	17.3				17.3	30.0	12.7
	Non HT20, 6 to 54 Mbps	2	3	16.0	14.8			18.5	30.0	11.5
	Non HT20, 6 to 54 Mbps	3	3	14.8	13.7	13.0		18.7	30.0	11.3
	Non HT20, 6 to 54 Mbps	4	3	14.8	13.7	13.0	15.3	20.3	30.0	9.7
	Non HT20 Beam Forming, 6 to 54 Mbps	2	6	12.3	11.4			14.9	30.0	15.1
	Non HT20 Beam Forming, 6 to 54 Mbps	3	8	10.4	9.4	8.7		14.3	28.0	13.7
	Non HT20 Beam Forming, 6 to 54 Mbps	4	9	8.5	7.6	6.8	9.3	14.2	27.0	12.8
	HT/VHT20, M0 to M7	1	3	17.5				17.5	30.0	12.5
	HT/VHT20, M0 to M7	2	3	16.2	15.0			18.7	30.0	11.3
	HT/VHT20, M8 to M15	2	3	16.2	15.0			18.7	30.0	11.3
	HT/VHT20, M0 to M7	3	3	16.2	15.0	14.3		20.0	30.0	10.0
	HT/VHT20, M8 to M15	3	3	16.2	15.0	14.3		20.0	30.0	10.0
	HT/VHT20, M16 to M23	3	3	16.2	15.0	14.3		20.0	30.0	10.0
	HT/VHT20, M0 to M7	4	3	16.2	15.0	14.3	16.7	21.7	30.0	8.3
	HT/VHT20, M8 to M15	4	3	16.2	15.0	14.3	16.7	21.7	30.0	8.3
	HT/VHT20, M16 to M23	4	3	16.2	15.0	14.3	16.7	21.7	30.0	8.3
	HT/VHT20 Beam Forming, M0 to M7	2	6	13.7	12.7			16.2	30.0	13.8
	HT/VHT20 Beam Forming, M8 to M15	2	3	16.2	15.0			18.7	30.0	11.3
	HT/VHT20 Beam Forming, M0 to M7	3	8	10.6	9.6	8.9		14.5	28.0	13.5
	HT/VHT20 Beam Forming, M8 to M15	3	5	13.7	12.7	11.9		17.6	30.0	12.4
	HT/VHT20 Beam Forming, M16 to M23	3	3	16.2	15.0	14.3		20.0	30.0	10.0
	HT/VHT20 Beam Forming, M0 to M7	4	9	8.7	7.7	6.9	9.4	14.3	27.0	12.7
	HT/VHT20 Beam Forming, M8 to M15	4	6	13.7	12.7	11.9	14.3	19.3	30.0	10.7
	HT/VHT20 Beam Forming, M16 to M23	4	4	13.7	12.7	11.9	14.3	19.3	30.0	10.7
	HT/VHT20 STBC, M0 to M7	2	3	16.2	15.0			18.7	30.0	11.3
	HT/VHT20 STBC, M0 to M7	3	3	16.2	15.0	14.3		20.0	30.0	10.0
	HT/VHT20 STBC, M0 to M7	4	3	16.2	15.0	14.3	16.7	21.7	30.0	8.3
	5755	Non HT40, 6 to 54 Mbps	1	3	12.5				12.5	30.0
Non HT40, 6 to 54 Mbps		2	3	12.5	11.5			15.0	30.0	15.0
Non HT40, 6 to 54 Mbps		3	3	6.6	5.4	4.9		10.5	30.0	19.5
Non HT40, 6 to 54 Mbps		4	3	4.7	3.5	3.0	5.6	10.3	30.0	19.7
HT/VHT40, M0 to M7		1	3	15.7				15.7	30.0	14.3



	HT/VHT40, M0 to M7	2	3	11.3	10.3			13.8	30.0	16.2
	HT/VHT40, M8 to M15	2	3	11.3	10.3			13.8	30.0	16.2
	HT/VHT40, M0 to M7	3	3	11.3	10.3	9.6		15.2	30.0	14.8
	HT/VHT40, M8 to M15	3	3	11.3	10.3	9.6		15.2	30.0	14.8
	HT/VHT40, M16 to M23	3	3	11.3	10.3	9.6		15.2	30.0	14.8
	HT/VHT40, M0 to M7	4	3	11.3	10.3	9.6	12.0	16.9	30.0	13.1
	HT/VHT40, M8 to M15	4	3	11.3	10.3	9.6	12.0	16.9	30.0	13.1
	HT/VHT40, M16 to M23	4	3	11.3	10.3	9.6	12.0	16.9	30.0	13.1
	HT/VHT40 Beam Forming, M0 to M7	2	6	10.3	9.4			12.9	30.0	17.1
	HT/VHT40 Beam Forming, M8 to M15	2	3	11.3	10.3			13.8	30.0	16.2
	HT/VHT40 Beam Forming, M0 to M7	3	8	10.3	9.4	8.5		14.2	28.0	13.8
	HT/VHT40 Beam Forming, M8 to M15	3	5	11.3	10.3	9.6		15.2	30.0	14.8
	HT/VHT40 Beam Forming, M16 to M23	3	3	11.3	10.3	9.6		15.2	30.0	14.8
	HT/VHT40 Beam Forming, M0 to M7	4	9	6.3	5.1	4.6	7.2	11.9	27.0	15.1
	HT/VHT40 Beam Forming, M8 to M15	4	6	10.3	9.4	8.5	11.0	15.9	30.0	14.1
	HT/VHT40 Beam Forming, M16 to M23	4	4	11.3	10.3	9.6	12.0	16.9	30.0	13.1
	HT/VHT40 STBC, M0 to M7	2	3	11.3	10.3			13.8	30.0	16.2
	HT/VHT40 STBC, M0 to M7	3	3	11.3	10.3	9.6		15.2	30.0	14.8
	HT/VHT40 STBC, M0 to M7	4	3	11.3	10.3	9.6	12.0	16.9	30.0	13.1
5775	Non HT80, 6 to 54 Mbps	1	3	11.9				11.9	30.0	18.1
	Non HT80, 6 to 54 Mbps	2	3	11.9	11.7			14.8	30.0	15.2
	Non HT80, 6 to 54 Mbps	3	3	10.8	10.6	10.7		15.5	30.0	14.5
	Non HT80, 6 to 54 Mbps	4	3	9.7	9.4	9.5	11.2	16.0	30.0	14.0
	VHT80, M0 to M9 1ss	1	3	13.7				13.7	30.0	16.3
	VHT80, M0 to M9 1ss	2	3	13.7	13.5			16.6	30.0	13.4
	VHT80, M0 to M9 2ss	2	3	13.7	13.5			16.6	30.0	13.4
	VHT80, M0 to M9 1ss	3	3	12.5	12.3	12.4		17.2	30.0	12.8
	VHT80, M0 to M9 2ss	3	3	12.5	12.3	12.4		17.2	30.0	12.8
	VHT80, M0 to M9 3ss	3	3	12.5	12.3	12.4		17.2	30.0	12.8
	VHT80, M0 to M9 1ss	4	3	12.5	12.3	12.4	14.0	18.9	30.0	11.1
	VHT80, M0 to M9 2ss	4	3	12.5	12.3	12.4	14.0	18.9	30.0	11.1
	VHT80, M0 to M9 3ss	4	3	12.5	12.3	12.4	14.0	18.9	30.0	11.1
	VHT80 Beam Forming, M0 to M9 1ss	2	6	11.4	11.2			14.3	30.0	15.7
	VHT80 Beam Forming, M0 to M9 2ss	2	3	13.7	13.5			16.6	30.0	13.4
	VHT80 Beam Forming, M0 to M9 1ss	3	8	10.3	10.0	10.3		15.0	28.0	13.0
	VHT80 Beam Forming, M0 to M9 2ss	3	5	12.5	12.3	12.4		17.2	30.0	12.8
	VHT80 Beam Forming, M0 to M9 3ss	3	3	12.5	12.3	12.4		17.2	30.0	12.8
	VHT80 Beam Forming, M0 to M9 1ss	4	9	8.4	8.0	8.2	9.6	14.6	27.0	12.4
	VHT80 Beam Forming, M0 to M9 2ss	4	6	10.3	10.0	10.3	11.5	16.6	30.0	13.4
VHT80 Beam Forming, M0 to M9 3ss	4	4	11.4	11.2	11.3	12.9	17.8	30.0	12.2	



	VHT80 STBC, M0 to M9 1ss	2	3	13.7	13.5			16.6	30.0	13.4
	VHT80 STBC, M0 to M9 1ss	3	3	12.5	12.3	12.4		17.2	30.0	12.8
	VHT80 STBC, M0 to M9 1ss	4	3	12.5	12.3	12.4	14.0	18.9	30.0	11.1
5785	Non HT20, 6 to 54 Mbps	1	3	14.0				14.0	30.0	16.0
	Non HT20, 6 to 54 Mbps	2	3	14.0	14.1			17.1	30.0	12.9
	Non HT20, 6 to 54 Mbps	3	3	14.0	14.1	13.7		18.7	30.0	11.3
	Non HT20, 6 to 54 Mbps	4	3	14.0	14.1	13.7	15.8	20.5	30.0	9.5
	Non HT20 Beam Forming, 6 to 54 Mbps	2	6	14.0	14.1			17.1	30.0	12.9
	Non HT20 Beam Forming, 6 to 54 Mbps	3	8	14.0	14.1	13.7		18.7	28.0	9.3
	Non HT20 Beam Forming, 6 to 54 Mbps	4	9	14.0	14.1	13.7	15.8	20.5	27.0	6.5
	HT/VHT20, M0 to M7	1	3	14.2				14.2	30.0	15.8
	HT/VHT20, M0 to M7	2	3	14.2	14.4			17.3	30.0	12.7
	HT/VHT20, M8 to M15	2	3	14.2	14.4			17.3	30.0	12.7
	HT/VHT20, M0 to M7	3	3	14.2	14.4	13.9		18.9	30.0	11.1
	HT/VHT20, M8 to M15	3	3	14.2	14.4	13.9		18.9	30.0	11.1
	HT/VHT20, M16 to M23	3	3	14.2	14.4	13.9		18.9	30.0	11.1
	HT/VHT20, M0 to M7	4	3	14.2	14.4	13.9	16.0	20.7	30.0	9.3
	HT/VHT20, M8 to M15	4	3	14.2	14.4	13.9	16.0	20.7	30.0	9.3
	HT/VHT20, M16 to M23	4	3	14.2	14.4	13.9	16.0	20.7	30.0	9.3
	HT/VHT20 Beam Forming, M0 to M7	2	6	14.2	14.4			17.3	30.0	12.7
	HT/VHT20 Beam Forming, M8 to M15	2	3	14.2	14.4			17.3	30.0	12.7
	HT/VHT20 Beam Forming, M0 to M7	3	8	14.2	14.4	13.9		18.9	28.0	9.1
	HT/VHT20 Beam Forming, M8 to M15	3	5	14.2	14.4	13.9		18.9	30.0	11.1
	HT/VHT20 Beam Forming, M16 to M23	3	3	14.2	14.4	13.9		18.9	30.0	11.1
	<b>HT/VHT20 Beam Forming, M0 to M7</b>	<b>4</b>	<b>9</b>	<b>14.2</b>	<b>14.4</b>	<b>13.9</b>	<b>16.0</b>	<b>20.7</b>	<b>27.0</b>	<b>6.3</b>
	HT/VHT20 Beam Forming, M8 to M15	4	6	14.2	14.4	13.9	16.0	20.7	30.0	9.3
	HT/VHT20 Beam Forming, M16 to M23	4	4	14.2	14.4	13.9	16.0	20.7	30.0	9.3
	HT/VHT20 STBC, M0 to M7	2	3	14.2	14.4			17.3	30.0	12.7
	HT/VHT20 STBC, M0 to M7	3	3	14.2	14.4	13.9		18.9	30.0	11.1
	HT/VHT20 STBC, M0 to M7	4	3	14.2	14.4	13.9	16.0	20.7	30.0	9.3
5795	Non HT40, 6 to 54 Mbps	1	3	14.2				14.2	30.0	15.8
	Non HT40, 6 to 54 Mbps	2	3	14.2	14.5			17.4	30.0	12.6
	Non HT40, 6 to 54 Mbps	3	3	14.2	14.5	15.1		19.4	30.0	10.6
	Non HT40, 6 to 54 Mbps	4	3	14.2	14.5	15.1	16.2	21.1	30.0	8.9
	HT/VHT40, M0 to M7	1	3	14.2				14.2	30.0	15.8
	HT/VHT40, M0 to M7	2	3	14.2	13.4			16.8	30.0	13.2
	HT/VHT40, M8 to M15	2	3	14.2	13.4			16.8	30.0	13.2
	HT/VHT40, M0 to M7	3	3	14.2	13.4	13.9		18.6	30.0	11.4
	HT/VHT40, M8 to M15	3	3	14.2	13.4	13.9		18.6	30.0	11.4



	HT/VHT40, M16 to M23	3	3	14.2	13.4	13.9		18.6	30.0	11.4
	HT/VHT40, M0 to M7	4	3	14.2	13.4	13.9	16.1	20.5	30.0	9.5
	HT/VHT40, M8 to M15	4	3	14.2	13.4	13.9	16.1	20.5	30.0	9.5
	HT/VHT40, M16 to M23	4	3	14.2	13.4	13.9	16.1	20.5	30.0	9.5
	HT/VHT40 Beam Forming, M0 to M7	2	6	14.2	13.4			16.8	30.0	13.2
	HT/VHT40 Beam Forming, M8 to M15	2	3	14.2	13.4			16.8	30.0	13.2
	HT/VHT40 Beam Forming, M0 to M7	3	8	14.2	13.4	13.9		18.6	28.0	9.4
	HT/VHT40 Beam Forming, M8 to M15	3	5	14.2	13.4	13.9		18.6	30.0	11.4
	HT/VHT40 Beam Forming, M16 to M23	3	3	14.2	13.4	13.9		18.6	30.0	11.4
	HT/VHT40 Beam Forming, M0 to M7	4	9	14.2	13.4	13.9	16.1	20.5	27.0	6.5
	HT/VHT40 Beam Forming, M8 to M15	4	6	14.2	13.4	13.9	16.1	20.5	30.0	9.5
	HT/VHT40 Beam Forming, M16 to M23	4	4	14.2	13.4	13.9	16.1	20.5	30.0	9.5
	HT/VHT40 STBC, M0 to M7	2	3	14.2	13.4			16.8	30.0	13.2
	HT/VHT40 STBC, M0 to M7	3	3	14.2	13.4	13.9		18.6	30.0	11.4
	HT/VHT40 STBC, M0 to M7	4	3	14.2	13.4	13.9	16.1	20.5	30.0	9.5
5825	Non HT20, 6 to 54 Mbps	1	3	14.8				14.8	30.0	15.2
	Non HT20, 6 to 54 Mbps	2	3	14.8	13.9			17.4	30.0	12.6
	Non HT20, 6 to 54 Mbps	3	3	14.8	13.9	13.4		18.8	30.0	11.2
	Non HT20, 6 to 54 Mbps	4	3	14.8	13.9	13.4	15.8	20.6	30.0	9.4
	Non HT20 Beam Forming, 6 to 54 Mbps	2	6	14.8	13.9			17.4	30.0	12.6
	Non HT20 Beam Forming, 6 to 54 Mbps	3	8	14.8	13.9	13.4		18.8	28.0	9.2
	Non HT20 Beam Forming, 6 to 54 Mbps	4	9	13.6	12.7	13.5	14.6	19.7	27.0	7.3
	HT/VHT20, M0 to M7	1	3	15.0				15.0	30.0	15.0
	HT/VHT20, M0 to M7	2	3	15.0	14.1			17.6	30.0	12.4
	HT/VHT20, M8 to M15	2	3	15.0	14.1			17.6	30.0	12.4
	HT/VHT20, M0 to M7	3	3	15.0	14.1	13.6		19.0	30.0	11.0
	HT/VHT20, M8 to M15	3	3	15.0	14.1	13.6		19.0	30.0	11.0
	HT/VHT20, M16 to M23	3	3	15.0	14.1	13.6		19.0	30.0	11.0
	HT/VHT20, M0 to M7	4	3	15.0	14.1	13.6	16.1	20.8	30.0	9.2
	HT/VHT20, M8 to M15	4	3	15.0	14.1	13.6	16.1	20.8	30.0	9.2
	HT/VHT20, M16 to M23	4	3	15.0	14.1	13.6	16.1	20.8	30.0	9.2
	HT/VHT20 Beam Forming, M0 to M7	2	6	15.0	14.1			17.6	30.0	12.4
	HT/VHT20 Beam Forming, M8 to M15	2	3	15.0	14.1			17.6	30.0	12.4
	HT/VHT20 Beam Forming, M0 to M7	3	8	15.0	14.1	13.6		19.0	28.0	9.0
	HT/VHT20 Beam Forming, M8 to M15	3	5	15.0	14.1	13.6		19.0	30.0	11.0
	HT/VHT20 Beam Forming, M16 to M23	3	3	15.0	14.1	13.6		19.0	30.0	11.0
	HT/VHT20 Beam Forming, M0 to M7	4	9	13.8	13.0	13.6	14.8	19.9	27.0	7.1
HT/VHT20 Beam Forming, M8 to M15	4	6	15.0	14.1	13.6	16.1	20.8	30.0	9.2	
HT/VHT20 Beam Forming, M16 to M23	4	4	15.0	14.1	13.6	16.1	20.8	30.0	9.2	
HT/VHT20 STBC, M0 to M7	2	3	15.0	14.1			17.6	30.0	12.4	



HT/VHT20 STBC, M0 to M7	3	3	15.0	14.1	13.6		19.0	30.0	11.0
HT/VHT20 STBC, M0 to M7	4	3	15.0	14.1	13.6	16.1	20.8	30.0	9.2

**Peak Output Power, 5785 MHz, HT/VHT20 Beam Forming, M0 to M7**

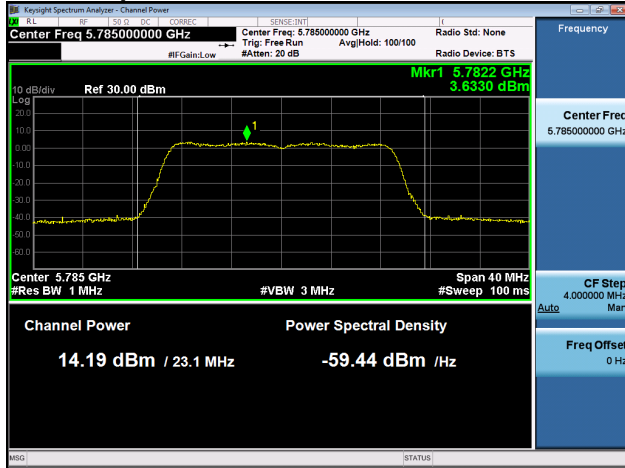

Antenna A

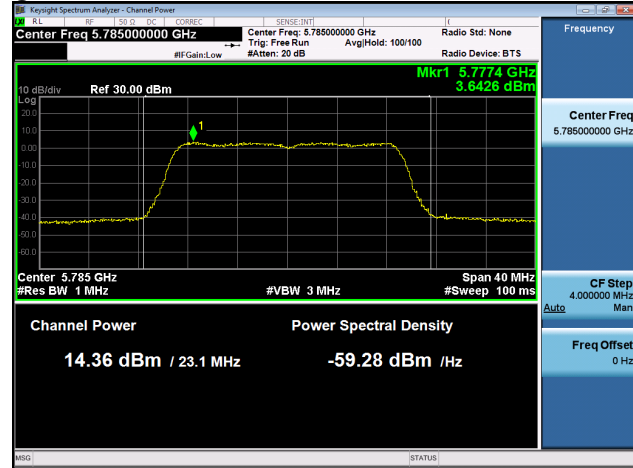

Antenna B

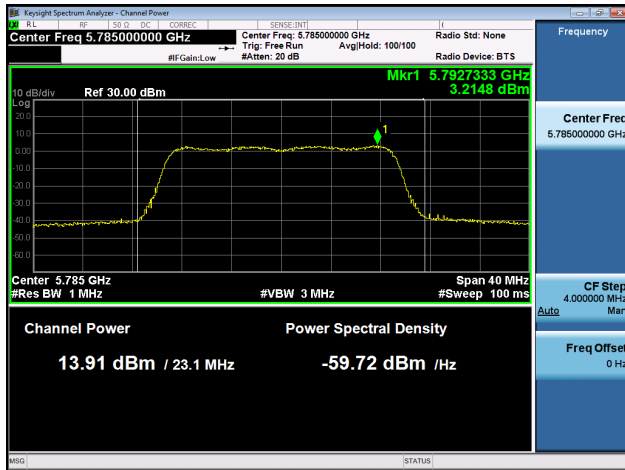

Antenna C

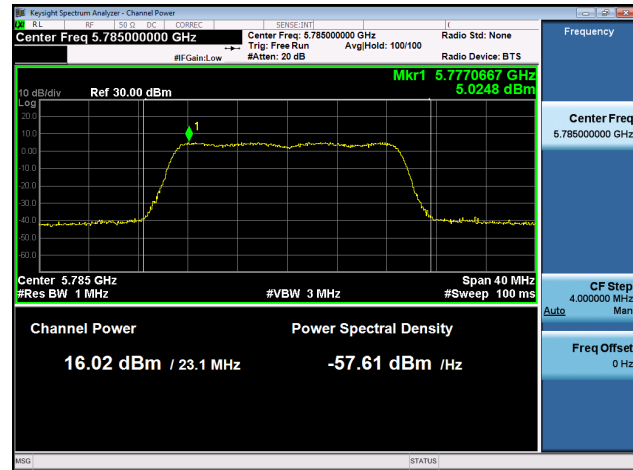

Antenna D



## Antenna Gain : 4 dBi

Frequency (MHz)	Mode	Tx Paths	Correlated Antenna Gain (dBi)	Tx 1 Max Power (dBm)	Tx 2 Max Power (dBm)	Tx 3 Max Power (dBm)	Tx 4 Max Power (dBm)	Total Tx Channel Power (dBm)	Limit (dBm)	Margin (dB)	
5745	Non HT20, 6 to 54 Mbps	1	4	17.3				17.3	30.0	12.7	
	Non HT20, 6 to 54 Mbps	2	4	14.8	13.7			17.3	30.0	12.7	
	Non HT20, 6 to 54 Mbps	3	4	14.8	13.7	13.0		18.7	30.0	11.3	
	Non HT20, 6 to 54 Mbps	4	4	13.6	12.5	11.8	14.2	19.1	30.0	10.9	
	Non HT20 Beam Forming, 6 to 54 Mbps	2	7	11.3	10.5			13.9	29.0	15.1	
	Non HT20 Beam Forming, 6 to 54 Mbps	3	9	9.4	8.5	7.7		13.4	27.0	13.6	
	Non HT20 Beam Forming, 6 to 54 Mbps	4	10	6.5	5.5	4.7	7.3	12.1	26.0	13.9	
	HT/VHT20, M0 to M7	1	4	16.2				16.2	30.0	13.8	
	HT/VHT20, M0 to M7	2	4	14.9	13.8			17.4	30.0	12.6	
	HT/VHT20, M8 to M15	2	4	14.9	13.8			17.4	30.0	12.6	
	HT/VHT20, M0 to M7	3	4	14.9	13.8	13.1		18.8	30.0	11.2	
	HT/VHT20, M8 to M15	3	4	14.9	13.8	13.1		18.8	30.0	11.2	
	HT/VHT20, M16 to M23	3	4	14.9	13.8	13.1		18.8	30.0	11.2	
	HT/VHT20, M0 to M7	4	4	13.7	12.7	11.9	14.3	19.3	30.0	10.7	
	HT/VHT20, M8 to M15	4	4	13.7	12.7	11.9	14.3	19.3	30.0	10.7	
	HT/VHT20, M16 to M23	4	4	13.7	12.7	11.9	14.3	19.3	30.0	10.7	
	HT/VHT20 Beam Forming, M0 to M7	2	7	13.7	12.7			16.2	29.0	12.8	
	HT/VHT20 Beam Forming, M8 to M15	2	4	14.9	13.8			17.4	30.0	12.6	
	HT/VHT20 Beam Forming, M0 to M7	3	9	9.7	8.7	7.8		13.6	27.0	13.4	
	HT/VHT20 Beam Forming, M8 to M15	3	6	13.7	12.7	11.9		17.6	30.0	12.4	
	HT/VHT20 Beam Forming, M16 to M23	3	4	14.9	13.8	13.1		18.8	30.0	11.2	
	HT/VHT20 Beam Forming, M0 to M7	4	10	7.7	6.8	6.0	8.5	13.4	26.0	12.6	
	HT/VHT20 Beam Forming, M8 to M15	4	7	11.5	10.7	10.0	12.3	17.2	29.0	11.8	
	HT/VHT20 Beam Forming, M16 to M23	4	5	13.7	12.7	11.9	14.3	19.3	30.0	10.7	
	HT/VHT20 STBC, M0 to M7	2	4	14.9	13.8			17.4	30.0	12.6	
	HT/VHT20 STBC, M0 to M7	3	4	14.9	13.8	13.1		18.8	30.0	11.2	
	HT/VHT20 STBC, M0 to M7	4	4	13.7	12.7	11.9	14.3	19.3	30.0	10.7	
	5755	Non HT40, 6 to 54 Mbps	1	4	12.5				12.5	30.0	17.5
		Non HT40, 6 to 54 Mbps	2	4	9.7	8.7			12.2	30.0	17.8
		Non HT40, 6 to 54 Mbps	3	4	4.7	3.5	3.0		8.6	30.0	21.4
Non HT40, 6 to 54 Mbps		4	4	4.7	3.5	3.0	5.6	10.3	30.0	19.7	
HT/VHT40, M0 to M7		1	4	14.5				14.5	30.0	15.5	





	HT/VHT40, M0 to M7	2	4	11.3	10.3			13.8	30.0	16.2
	HT/VHT40, M8 to M15	2	4	11.3	10.3			13.8	30.0	16.2
	HT/VHT40, M0 to M7	3	4	11.3	10.3	9.6		15.2	30.0	14.8
	HT/VHT40, M8 to M15	3	4	11.3	10.3	9.6		15.2	30.0	14.8
	HT/VHT40, M16 to M23	3	4	11.3	10.3	9.6		15.2	30.0	14.8
	HT/VHT40, M0 to M7	4	4	11.3	10.3	9.6	12.0	16.9	30.0	13.1
	HT/VHT40, M8 to M15	4	4	11.3	10.3	9.6	12.0	16.9	30.0	13.1
	HT/VHT40, M16 to M23	4	4	11.3	10.3	9.6	12.0	16.9	30.0	13.1
	HT/VHT40 Beam Forming, M0 to M7	2	7	10.3	9.4			12.9	29.0	16.1
	HT/VHT40 Beam Forming, M8 to M15	2	4	11.3	10.3			13.8	30.0	16.2
	HT/VHT40 Beam Forming, M0 to M7	3	9	6.3	5.1	4.6		10.2	27.0	16.8
	HT/VHT40 Beam Forming, M8 to M15	3	6	10.3	9.4	8.5		14.2	30.0	15.8
	HT/VHT40 Beam Forming, M16 to M23	3	4	11.3	10.3	9.6		15.2	30.0	14.8
	HT/VHT40 Beam Forming, M0 to M7	4	10	5.3	4.2	3.7	6.0	10.9	26.0	15.1
	HT/VHT40 Beam Forming, M8 to M15	4	7	10.3	9.4	8.5	11.0	15.9	29.0	13.1
	HT/VHT40 Beam Forming, M16 to M23	4	5	11.3	10.3	9.6	12.0	16.9	30.0	13.1
	HT/VHT40 STBC, M0 to M7	2	4	11.3	10.3			13.8	30.0	16.2
	HT/VHT40 STBC, M0 to M7	3	4	11.3	10.3	9.6		15.2	30.0	14.8
	HT/VHT40 STBC, M0 to M7	4	4	11.3	10.3	9.6	12.0	16.9	30.0	13.1
5775	Non HT80, 6 to 54 Mbps	1	4	11.9				11.9	30.0	18.1
	Non HT80, 6 to 54 Mbps	2	4	11.9	11.7			14.8	30.0	15.2
	Non HT80, 6 to 54 Mbps	3	4	9.7	9.4	9.5		14.3	30.0	15.7
	Non HT80, 6 to 54 Mbps	4	4	8.9	7.4	7.6	10.2	14.7	30.0	15.3
	VHT80, M0 to M9 1ss	1	4	13.7				13.7	30.0	16.3
	VHT80, M0 to M9 1ss	2	4	12.5	12.3			15.4	30.0	14.6
	VHT80, M0 to M9 2ss	2	4	12.5	12.3			15.4	30.0	14.6
	VHT80, M0 to M9 1ss	3	4	12.5	12.3	12.4		17.2	30.0	12.8
	VHT80, M0 to M9 2ss	3	4	12.5	12.3	12.4		17.2	30.0	12.8
	VHT80, M0 to M9 3ss	3	4	12.5	12.3	12.4		17.2	30.0	12.8
	VHT80, M0 to M9 1ss	4	4	11.4	11.2	11.3	12.9	17.8	30.0	12.2
	VHT80, M0 to M9 2ss	4	4	11.4	11.2	11.3	12.9	17.8	30.0	12.2
	VHT80, M0 to M9 3ss	4	4	11.4	11.2	11.3	12.9	17.8	30.0	12.2
	VHT80 Beam Forming, M0 to M9 1ss	2	7	11.4	11.2			14.3	29.0	14.7
	VHT80 Beam Forming, M0 to M9 2ss	2	4	12.5	12.3			15.4	30.0	14.6
	VHT80 Beam Forming, M0 to M9 1ss	3	9	8.4	8.0	8.2		13.0	27.0	14.0
	VHT80 Beam Forming, M0 to M9 2ss	3	6	10.3	10.0	10.3		15.0	30.0	15.0
	VHT80 Beam Forming, M0 to M9 3ss	3	4	12.5	12.3	12.4		17.2	30.0	12.8
	VHT80 Beam Forming, M0 to M9 1ss	4	10	6.6	6.1	6.3	7.7	12.7	26.0	13.3
	VHT80 Beam Forming, M0 to M9 2ss	4	7	10.3	10.0	10.3	11.5	16.6	29.0	12.4
VHT80 Beam Forming, M0 to M9 3ss	4	5	10.3	10.0	10.3	11.5	16.6	30.0	13.4	



	VHT80 STBC, M0 to M9 1ss	2	4	12.5	12.3			15.4	30.0	14.6
	VHT80 STBC, M0 to M9 1ss	3	4	12.5	12.3	12.4		17.2	30.0	12.8
	VHT80 STBC, M0 to M9 1ss	4	4	11.4	11.2	11.3	12.9	17.8	30.0	12.2
5785	Non HT20, 6 to 54 Mbps	1	4	14.0				14.0	30.0	16.0
	Non HT20, 6 to 54 Mbps	2	4	14.0	14.1			17.1	30.0	12.9
	Non HT20, 6 to 54 Mbps	3	4	14.0	14.1	13.7		18.7	30.0	11.3
	Non HT20, 6 to 54 Mbps	4	4	14.0	14.1	13.7	15.8	20.5	30.0	9.5
	Non HT20 Beam Forming, 6 to 54 Mbps	2	7	14.0	14.1			17.1	29.0	11.9
	Non HT20 Beam Forming, 6 to 54 Mbps	3	9	14.0	14.1	13.7		18.7	27.0	8.3
	Non HT20 Beam Forming, 6 to 54 Mbps	4	10	14.0	14.1	13.7	15.8	20.5	26.0	5.5
	HT/VHT20, M0 to M7	1	4	14.2				14.2	30.0	15.8
	HT/VHT20, M0 to M7	2	4	14.2	14.4			17.3	30.0	12.7
	HT/VHT20, M8 to M15	2	4	14.2	14.4			17.3	30.0	12.7
	HT/VHT20, M0 to M7	3	4	14.2	14.4	13.9		18.9	30.0	11.1
	HT/VHT20, M8 to M15	3	4	14.2	14.4	13.9		18.9	30.0	11.1
	HT/VHT20, M16 to M23	3	4	14.2	14.4	13.9		18.9	30.0	11.1
	HT/VHT20, M0 to M7	4	4	14.2	14.4	13.9	16.0	20.7	30.0	9.3
	HT/VHT20, M8 to M15	4	4	14.2	14.4	13.9	16.0	20.7	30.0	9.3
	HT/VHT20, M16 to M23	4	4	14.2	14.4	13.9	16.0	20.7	30.0	9.3
	HT/VHT20 Beam Forming, M0 to M7	2	7	14.2	14.4			17.3	29.0	11.7
	HT/VHT20 Beam Forming, M8 to M15	2	4	14.2	14.4			17.3	30.0	12.7
	HT/VHT20 Beam Forming, M0 to M7	3	9	14.2	14.4	13.9		18.9	27.0	8.1
	HT/VHT20 Beam Forming, M8 to M15	3	6	14.2	14.4	13.9		18.9	30.0	11.1
	HT/VHT20 Beam Forming, M16 to M23	3	4	14.2	14.4	13.9		18.9	30.0	11.1
	<b>HT/VHT20 Beam Forming, M0 to M7</b>	<b>4</b>	<b>10</b>	<b>14.2</b>	<b>14.4</b>	<b>13.9</b>	<b>16.0</b>	<b>20.7</b>	<b>26.0</b>	<b>5.3</b>
	HT/VHT20 Beam Forming, M8 to M15	4	7	14.2	14.4	13.9	16.0	20.7	29.0	8.3
	HT/VHT20 Beam Forming, M16 to M23	4	5	14.2	14.4	13.9	16.0	20.7	30.0	9.3
	HT/VHT20 STBC, M0 to M7	2	4	14.2	14.4			17.3	30.0	12.7
	HT/VHT20 STBC, M0 to M7	3	4	14.2	14.4	13.9		18.9	30.0	11.1
	HT/VHT20 STBC, M0 to M7	4	4	14.2	14.4	13.9	16.0	20.7	30.0	9.3
5795	Non HT40, 6 to 54 Mbps	1	4	14.2				14.2	30.0	15.8
	Non HT40, 6 to 54 Mbps	2	4	14.2	14.5			17.4	30.0	12.6
	Non HT40, 6 to 54 Mbps	3	4	14.2	14.5	15.1		19.4	30.0	10.6
	Non HT40, 6 to 54 Mbps	4	4	14.2	14.5	15.1	16.2	21.1	30.0	8.9
	HT/VHT40, M0 to M7	1	4	14.2				14.2	30.0	15.8
	HT/VHT40, M0 to M7	2	4	14.2	13.4			16.8	30.0	13.2
	HT/VHT40, M8 to M15	2	4	14.2	13.4			16.8	30.0	13.2
	HT/VHT40, M0 to M7	3	4	14.2	13.4	13.9		18.6	30.0	11.4
	HT/VHT40, M8 to M15	3	4	14.2	13.4	13.9		18.6	30.0	11.4



	HT/VHT40, M16 to M23	3	4	14.2	13.4	13.9		18.6	30.0	11.4
	HT/VHT40, M0 to M7	4	4	14.2	13.4	13.9	16.1	20.5	30.0	9.5
	HT/VHT40, M8 to M15	4	4	14.2	13.4	13.9	16.1	20.5	30.0	9.5
	HT/VHT40, M16 to M23	4	4	14.2	13.4	13.9	16.1	20.5	30.0	9.5
	HT/VHT40 Beam Forming, M0 to M7	2	7	14.2	13.4			16.8	29.0	12.2
	HT/VHT40 Beam Forming, M8 to M15	2	4	14.2	13.4			16.8	30.0	13.2
	HT/VHT40 Beam Forming, M0 to M7	3	9	14.2	13.4	13.9		18.6	27.0	8.4
	HT/VHT40 Beam Forming, M8 to M15	3	6	14.2	13.4	13.9		18.6	30.0	11.4
	HT/VHT40 Beam Forming, M16 to M23	3	4	14.2	13.4	13.9		18.6	30.0	11.4
	HT/VHT40 Beam Forming, M0 to M7	4	10	14.2	13.4	13.9	16.1	20.5	26.0	5.5
	HT/VHT40 Beam Forming, M8 to M15	4	7	14.2	13.4	13.9	16.1	20.5	29.0	8.5
	HT/VHT40 Beam Forming, M16 to M23	4	5	14.2	13.4	13.9	16.1	20.5	30.0	9.5
	HT/VHT40 STBC, M0 to M7	2	4	14.2	13.4			16.8	30.0	13.2
	HT/VHT40 STBC, M0 to M7	3	4	14.2	13.4	13.9		18.6	30.0	11.4
	HT/VHT40 STBC, M0 to M7	4	4	14.2	13.4	13.9	16.1	20.5	30.0	9.5
5825	Non HT20, 6 to 54 Mbps	1	4	14.8				14.8	30.0	15.2
	Non HT20, 6 to 54 Mbps	2	4	14.8	13.9			17.4	30.0	12.6
	Non HT20, 6 to 54 Mbps	3	4	14.8	13.9	13.4		18.8	30.0	11.2
	Non HT20, 6 to 54 Mbps	4	4	14.8	13.9	13.4	15.8	20.6	30.0	9.4
	Non HT20 Beam Forming, 6 to 54 Mbps	2	7	14.8	13.9			17.4	29.0	11.6
	Non HT20 Beam Forming, 6 to 54 Mbps	3	9	14.8	13.9	13.4		18.8	27.0	8.2
	Non HT20 Beam Forming, 6 to 54 Mbps	4	10	12.3	11.7	12.2	13.5	18.5	26.0	7.5
	HT/VHT20, M0 to M7	1	4	15.0				15.0	30.0	15.0
	HT/VHT20, M0 to M7	2	4	15.0	14.1			17.6	30.0	12.4
	HT/VHT20, M8 to M15	2	4	15.0	14.1			17.6	30.0	12.4
	HT/VHT20, M0 to M7	3	4	15.0	14.1	13.6		19.0	30.0	11.0
	HT/VHT20, M8 to M15	3	4	15.0	14.1	13.6		19.0	30.0	11.0
	HT/VHT20, M16 to M23	3	4	15.0	14.1	13.6		19.0	30.0	11.0
	HT/VHT20, M0 to M7	4	4	15.0	14.1	13.6	16.1	20.8	30.0	9.2
	HT/VHT20, M8 to M15	4	4	15.0	14.1	13.6	16.1	20.8	30.0	9.2
	HT/VHT20, M16 to M23	4	4	15.0	14.1	13.6	16.1	20.8	30.0	9.2
	HT/VHT20 Beam Forming, M0 to M7	2	7	15.0	14.1			17.6	29.0	11.4
	HT/VHT20 Beam Forming, M8 to M15	2	4	15.0	14.1			17.6	30.0	12.4
	HT/VHT20 Beam Forming, M0 to M7	3	9	15.0	14.1	13.6		19.0	27.0	8.0
	HT/VHT20 Beam Forming, M8 to M15	3	6	15.0	14.1	13.6		19.0	30.0	11.0
	HT/VHT20 Beam Forming, M16 to M23	3	4	15.0	14.1	13.6		19.0	30.0	11.0
	HT/VHT20 Beam Forming, M0 to M7	4	10	12.5	11.9	12.5	13.6	18.7	26.0	7.3
HT/VHT20 Beam Forming, M8 to M15	4	7	15.0	14.1	13.6	16.1	20.8	29.0	8.2	
HT/VHT20 Beam Forming, M16 to M23	4	5	15.0	14.1	13.6	16.1	20.8	30.0	9.2	
HT/VHT20 STBC, M0 to M7	2	4	15.0	14.1			17.6	30.0	12.4	



HT/VHT20 STBC, M0 to M7	3	4	15.0	14.1	13.6		19.0	30.0	11.0
HT/VHT20 STBC, M0 to M7	4	4	15.0	14.1	13.6	16.1	20.8	30.0	9.2



**Peak Output Power, 5785 MHz, HT/VHT20 Beam Forming, M0 to M7**

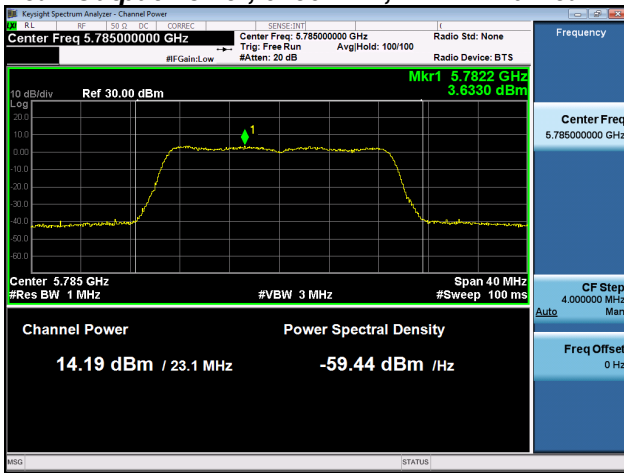

**Antenna A**

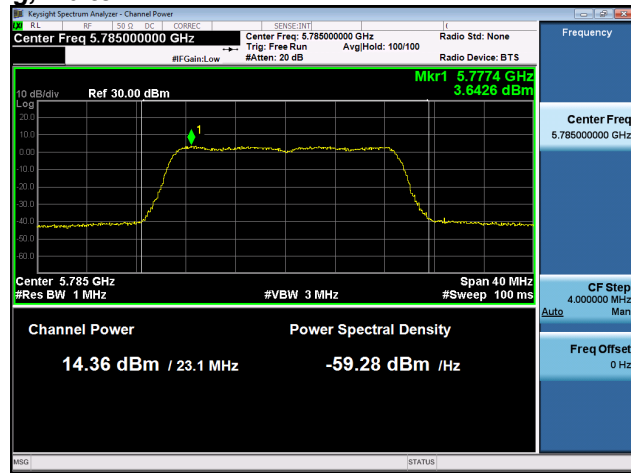

**Antenna B**

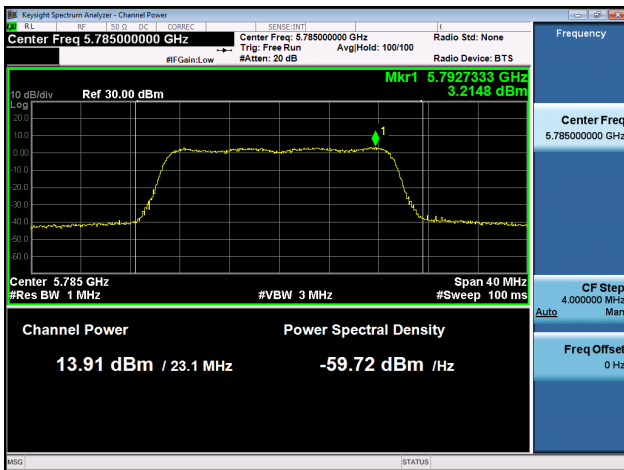

**Antenna C**

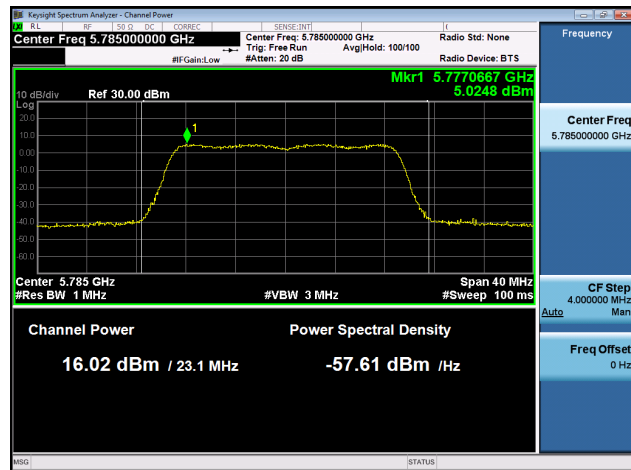

**Antenna D**



## Antenna Gain : 5 dBi

Frequency (MHz)	Mode	Tx Paths	Correlated Antenna Gain (dBi)	Tx 1 Max Power (dBm)	Tx 2 Max Power (dBm)	Tx 3 Max Power (dBm)	Tx 4 Max Power (dBm)	Total Tx Channel Power (dBm)	Limit (dBm)	Margin (dB)	
5745	Non HT20, 6 to 54 Mbps	1	5	16.0				16.0	30.0	14.0	
	Non HT20, 6 to 54 Mbps	2	5	13.6	12.5			16.1	30.0	13.9	
	Non HT20, 6 to 54 Mbps	3	5	13.6	12.5	11.8		17.5	30.0	12.5	
	Non HT20, 6 to 54 Mbps	4	5	12.3	11.4	10.7	13.1	18.0	30.0	12.0	
	Non HT20 Beam Forming, 6 to 54 Mbps	2	8	10.4	9.4			12.9	28.0	15.1	
	Non HT20 Beam Forming, 6 to 54 Mbps	3	10	7.6	6.6	5.8		11.5	26.0	14.5	
	Non HT20 Beam Forming, 6 to 54 Mbps	4	11	6.5	5.5	4.7	7.3	12.1	25.0	12.9	
	HT/VHT20, M0 to M7	1	5	16.2				16.2	30.0	13.8	
	HT/VHT20, M0 to M7	2	5	13.7	12.7			16.2	30.0	13.8	
	HT/VHT20, M8 to M15	2	5	13.7	12.7			16.2	30.0	13.8	
	HT/VHT20, M0 to M7	3	5	13.7	12.7	11.9		17.6	30.0	12.4	
	HT/VHT20, M8 to M15	3	5	13.7	12.7	11.9		17.6	30.0	12.4	
	HT/VHT20, M16 to M23	3	5	13.7	12.7	11.9		17.6	30.0	12.4	
	HT/VHT20, M0 to M7	4	5	13.7	12.7	11.9	14.3	19.3	30.0	10.7	
	HT/VHT20, M8 to M15	4	5	13.7	12.7	11.9	14.3	19.3	30.0	10.7	
	HT/VHT20, M16 to M23	4	5	13.7	12.7	11.9	14.3	19.3	30.0	10.7	
	HT/VHT20 Beam Forming, M0 to M7	2	8	10.6	9.6			13.1	28.0	14.9	
	HT/VHT20 Beam Forming, M8 to M15	2	5	13.7	12.7			16.2	30.0	13.8	
	HT/VHT20 Beam Forming, M0 to M7	3	10	8.7	7.7	6.9		12.6	26.0	13.4	
	HT/VHT20 Beam Forming, M8 to M15	3	7	13.7	12.7	11.9		17.6	29.0	11.4	
	HT/VHT20 Beam Forming, M16 to M23	3	5	13.7	12.7	11.9		17.6	30.0	12.4	
	HT/VHT20 Beam Forming, M0 to M7	4	11	6.6	5.6	4.8	7.4	12.2	25.0	12.8	
	HT/VHT20 Beam Forming, M8 to M15	4	8	10.6	9.6	8.9	11.4	16.2	28.0	11.8	
	HT/VHT20 Beam Forming, M16 to M23	4	6	13.7	12.7	11.9	14.3	19.3	30.0	10.7	
	HT/VHT20 STBC, M0 to M7	2	5	13.7	12.7			16.2	30.0	13.8	
	HT/VHT20 STBC, M0 to M7	3	5	13.7	12.7	11.9		17.6	30.0	12.4	
	HT/VHT20 STBC, M0 to M7	4	5	13.7	12.7	11.9	14.3	19.3	30.0	10.7	
	5755	Non HT40, 6 to 54 Mbps	1	5	12.5				12.5	30.0	17.5
		Non HT40, 6 to 54 Mbps	2	5	9.7	8.7			12.2	30.0	17.8
		Non HT40, 6 to 54 Mbps	3	5	4.7	3.5	3.0		8.6	30.0	21.4
Non HT40, 6 to 54 Mbps		4	5	4.7	3.5	3.0	5.6	10.3	30.0	19.7	
HT/VHT40, M0 to M7		1	5	14.5				14.5	30.0	15.5	



	HT/VHT40, M0 to M7	2	5	11.3	10.3			13.8	30.0	16.2
	HT/VHT40, M8 to M15	2	5	11.3	10.3			13.8	30.0	16.2
	HT/VHT40, M0 to M7	3	5	11.3	10.3	9.6		15.2	30.0	14.8
	HT/VHT40, M8 to M15	3	5	11.3	10.3	9.6		15.2	30.0	14.8
	HT/VHT40, M16 to M23	3	5	11.3	10.3	9.6		15.2	30.0	14.8
	HT/VHT40, M0 to M7	4	5	11.3	10.3	9.6	12.0	16.9	30.0	13.1
	HT/VHT40, M8 to M15	4	5	11.3	10.3	9.6	12.0	16.9	30.0	13.1
	HT/VHT40, M16 to M23	4	5	11.3	10.3	9.6	12.0	16.9	30.0	13.1
	HT/VHT40 Beam Forming, M0 to M7	2	8	10.3	9.4			12.9	28.0	15.1
	HT/VHT40 Beam Forming, M8 to M15	2	5	11.3	10.3			13.8	30.0	16.2
	HT/VHT40 Beam Forming, M0 to M7	3	10	5.3	4.2	3.7		9.2	26.0	16.8
	HT/VHT40 Beam Forming, M8 to M15	3	7	10.3	9.4	8.5		14.2	29.0	14.8
	HT/VHT40 Beam Forming, M16 to M23	3	5	11.3	10.3	9.6		15.2	30.0	14.8
	HT/VHT40 Beam Forming, M0 to M7	4	11	4.3	3.2	2.8	5.1	10.0	25.0	15.0
	HT/VHT40 Beam Forming, M8 to M15	4	8	6.3	5.1	4.6	7.2	11.9	28.0	16.1
	HT/VHT40 Beam Forming, M16 to M23	4	6	10.3	9.4	8.5	11.0	15.9	30.0	14.1
	HT/VHT40 STBC, M0 to M7	2	5	11.3	10.3			13.8	30.0	16.2
	HT/VHT40 STBC, M0 to M7	3	5	11.3	10.3	9.6		15.2	30.0	14.8
	HT/VHT40 STBC, M0 to M7	4	5	11.3	10.3	9.6	12.0	16.9	30.0	13.1
5775	Non HT80, 6 to 54 Mbps	1	5	11.9				11.9	30.0	18.1
	Non HT80, 6 to 54 Mbps	2	5	11.9	11.7			14.8	30.0	15.2
	Non HT80, 6 to 54 Mbps	3	5	9.7	9.4	9.5		14.3	30.0	15.7
	Non HT80, 6 to 54 Mbps	4	5	8.9	7.4	7.6	10.2	14.7	30.0	15.3
	VHT80, M0 to M9 1ss	1	5	13.7				13.7	30.0	16.3
	VHT80, M0 to M9 1ss	2	5	12.5	12.3			15.4	30.0	14.6
	VHT80, M0 to M9 2ss	2	5	12.5	12.3			15.4	30.0	14.6
	VHT80, M0 to M9 1ss	3	5	12.5	12.3	12.4		17.2	30.0	12.8
	VHT80, M0 to M9 2ss	3	5	12.5	12.3	12.4		17.2	30.0	12.8
	VHT80, M0 to M9 3ss	3	5	12.5	12.3	12.4		17.2	30.0	12.8
	VHT80, M0 to M9 1ss	4	5	10.3	10.0	10.3	11.5	16.6	30.0	13.4
	VHT80, M0 to M9 2ss	4	5	10.3	10.0	10.3	11.5	16.6	30.0	13.4
	VHT80, M0 to M9 3ss	4	5	10.3	10.0	10.3	11.5	16.6	30.0	13.4
	VHT80 Beam Forming, M0 to M9 1ss	2	8	10.3	10.0			13.2	28.0	14.8
	VHT80 Beam Forming, M0 to M9 2ss	2	5	12.5	12.3			15.4	30.0	14.6
	VHT80 Beam Forming, M0 to M9 1ss	3	10	8.4	8.0	8.2		13.0	26.0	13.0
	VHT80 Beam Forming, M0 to M9 2ss	3	7	10.3	10.0	10.3		15.0	29.0	14.0
	VHT80 Beam Forming, M0 to M9 3ss	3	5	12.5	12.3	12.4		17.2	30.0	12.8
	VHT80 Beam Forming, M0 to M9 1ss	4	11	5.7	5.2	5.4	6.8	11.8	25.0	13.2
	VHT80 Beam Forming, M0 to M9 2ss	4	8	10.3	10.0	10.3	11.5	16.6	28.0	11.4
VHT80 Beam Forming, M0 to M9 3ss	4	6	10.3	10.0	10.3	11.5	16.6	30.0	13.4	



	VHT80 STBC, M0 to M9 1ss	2	5	12.5	12.3			15.4	30.0	14.6
	VHT80 STBC, M0 to M9 1ss	3	5	12.5	12.3	12.4		17.2	30.0	12.8
	VHT80 STBC, M0 to M9 1ss	4	5	10.3	10.0	10.3	11.5	16.6	30.0	13.4
5785	Non HT20, 6 to 54 Mbps	1	5	14.0				14.0	30.0	16.0
	Non HT20, 6 to 54 Mbps	2	5	14.0	14.1			17.1	30.0	12.9
	Non HT20, 6 to 54 Mbps	3	5	14.0	14.1	13.7		18.7	30.0	11.3
	Non HT20, 6 to 54 Mbps	4	5	14.0	14.1	13.7	15.8	20.5	30.0	9.5
	Non HT20 Beam Forming, 6 to 54 Mbps	2	8	14.0	14.1			17.1	28.0	10.9
	Non HT20 Beam Forming, 6 to 54 Mbps	3	10	14.0	14.1	13.7		18.7	26.0	7.3
	Non HT20 Beam Forming, 6 to 54 Mbps	4	11	14.0	14.1	13.7	15.8	20.5	25.0	4.5
	HT/VHT20, M0 to M7	1	5	14.2				14.2	30.0	15.8
	HT/VHT20, M0 to M7	2	5	14.2	14.4			17.3	30.0	12.7
	HT/VHT20, M8 to M15	2	5	14.2	14.4			17.3	30.0	12.7
	HT/VHT20, M0 to M7	3	5	14.2	14.4	13.9		18.9	30.0	11.1
	HT/VHT20, M8 to M15	3	5	14.2	14.4	13.9		18.9	30.0	11.1
	HT/VHT20, M16 to M23	3	5	14.2	14.4	13.9		18.9	30.0	11.1
	HT/VHT20, M0 to M7	4	5	14.2	14.4	13.9	16.0	20.7	30.0	9.3
	HT/VHT20, M8 to M15	4	5	14.2	14.4	13.9	16.0	20.7	30.0	9.3
	HT/VHT20, M16 to M23	4	5	14.2	14.4	13.9	16.0	20.7	30.0	9.3
	HT/VHT20 Beam Forming, M0 to M7	2	8	14.2	14.4			17.3	28.0	10.7
	HT/VHT20 Beam Forming, M8 to M15	2	5	14.2	14.4			17.3	30.0	12.7
	HT/VHT20 Beam Forming, M0 to M7	3	10	14.2	14.4	13.9		18.9	26.0	7.1
	HT/VHT20 Beam Forming, M8 to M15	3	7	14.2	14.4	13.9		18.9	29.0	10.1
	HT/VHT20 Beam Forming, M16 to M23	3	5	14.2	14.4	13.9		18.9	30.0	11.1
	<b>HT/VHT20 Beam Forming, M0 to M7</b>	<b>4</b>	<b>11</b>	<b>14.2</b>	<b>14.4</b>	<b>13.9</b>	<b>16.0</b>	<b>20.7</b>	<b>25.0</b>	<b>4.3</b>
	HT/VHT20 Beam Forming, M8 to M15	4	8	14.2	14.4	13.9	16.0	20.7	28.0	7.3
	HT/VHT20 Beam Forming, M16 to M23	4	6	14.2	14.4	13.9	16.0	20.7	30.0	9.3
	HT/VHT20 STBC, M0 to M7	2	5	14.2	14.4			17.3	30.0	12.7
	HT/VHT20 STBC, M0 to M7	3	5	14.2	14.4	13.9		18.9	30.0	11.1
HT/VHT20 STBC, M0 to M7	4	5	14.2	14.4	13.9	16.0	20.7	30.0	9.3	
5795	Non HT40, 6 to 54 Mbps	1	5	14.2				14.2	30.0	15.8
	Non HT40, 6 to 54 Mbps	2	5	14.2	14.5			17.4	30.0	12.6
	Non HT40, 6 to 54 Mbps	3	5	14.2	14.5	15.1		19.4	30.0	10.6
	Non HT40, 6 to 54 Mbps	4	5	14.2	14.5	15.1	16.2	21.1	30.0	8.9
	HT/VHT40, M0 to M7	1	5	14.2				14.2	30.0	15.8
	HT/VHT40, M0 to M7	2	5	14.2	13.4			16.8	30.0	13.2
	HT/VHT40, M8 to M15	2	5	14.2	13.4			16.8	30.0	13.2
	HT/VHT40, M0 to M7	3	5	14.2	13.4	13.9		18.6	30.0	11.4
	HT/VHT40, M8 to M15	3	5	14.2	13.4	13.9		18.6	30.0	11.4





	HT/VHT40, M16 to M23	3	5	14.2	13.4	13.9		18.6	30.0	11.4
	HT/VHT40, M0 to M7	4	5	14.2	13.4	13.9	16.1	20.5	30.0	9.5
	HT/VHT40, M8 to M15	4	5	14.2	13.4	13.9	16.1	20.5	30.0	9.5
	HT/VHT40, M16 to M23	4	5	14.2	13.4	13.9	16.1	20.5	30.0	9.5
	HT/VHT40 Beam Forming, M0 to M7	2	8	14.2	13.4			16.8	28.0	11.2
	HT/VHT40 Beam Forming, M8 to M15	2	5	14.2	13.4			16.8	30.0	13.2
	HT/VHT40 Beam Forming, M0 to M7	3	10	14.2	13.4	13.9		18.6	26.0	7.4
	HT/VHT40 Beam Forming, M8 to M15	3	7	14.2	13.4	13.9		18.6	29.0	10.4
	HT/VHT40 Beam Forming, M16 to M23	3	5	14.2	13.4	13.9		18.6	30.0	11.4
	HT/VHT40 Beam Forming, M0 to M7	4	11	14.2	13.4	13.9	16.1	20.5	25.0	4.5
	HT/VHT40 Beam Forming, M8 to M15	4	8	14.2	13.4	13.9	16.1	20.5	28.0	7.5
	HT/VHT40 Beam Forming, M16 to M23	4	6	14.2	13.4	13.9	16.1	20.5	30.0	9.5
	HT/VHT40 STBC, M0 to M7	2	5	14.2	13.4			16.8	30.0	13.2
	HT/VHT40 STBC, M0 to M7	3	5	14.2	13.4	13.9		18.6	30.0	11.4
	HT/VHT40 STBC, M0 to M7	4	5	14.2	13.4	13.9	16.1	20.5	30.0	9.5
5825	Non HT20, 6 to 54 Mbps	1	5	14.8				14.8	30.0	15.2
	Non HT20, 6 to 54 Mbps	2	5	14.8	13.9			17.4	30.0	12.6
	Non HT20, 6 to 54 Mbps	3	5	14.8	13.9	13.4		18.8	30.0	11.2
	Non HT20, 6 to 54 Mbps	4	5	14.8	13.9	13.4	15.8	20.6	30.0	9.4
	Non HT20 Beam Forming, 6 to 54 Mbps	2	8	14.8	13.9			17.4	28.0	10.6
	Non HT20 Beam Forming, 6 to 54 Mbps	3	10	14.8	13.9	13.4		18.8	26.0	7.2
	Non HT20 Beam Forming, 6 to 54 Mbps	4	11	11.0	10.5	11.0	12.2	17.2	25.0	7.8
	HT/VHT20, M0 to M7	1	5	15.0				15.0	30.0	15.0
	HT/VHT20, M0 to M7	2	5	15.0	14.1			17.6	30.0	12.4
	HT/VHT20, M8 to M15	2	5	15.0	14.1			17.6	30.0	12.4
	HT/VHT20, M0 to M7	3	5	15.0	14.1	13.6		19.0	30.0	11.0
	HT/VHT20, M8 to M15	3	5	15.0	14.1	13.6		19.0	30.0	11.0
	HT/VHT20, M16 to M23	3	5	15.0	14.1	13.6		19.0	30.0	11.0
	HT/VHT20, M0 to M7	4	5	15.0	14.1	13.6	16.1	20.8	30.0	9.2
	HT/VHT20, M8 to M15	4	5	15.0	14.1	13.6	16.1	20.8	30.0	9.2
	HT/VHT20, M16 to M23	4	5	15.0	14.1	13.6	16.1	20.8	30.0	9.2
	HT/VHT20 Beam Forming, M0 to M7	2	8	15.0	14.1			17.6	28.0	10.4
	HT/VHT20 Beam Forming, M8 to M15	2	5	15.0	14.1			17.6	30.0	12.4
	HT/VHT20 Beam Forming, M0 to M7	3	10	15.0	14.1	13.6		19.0	26.0	7.0
	HT/VHT20 Beam Forming, M8 to M15	3	7	15.0	14.1	13.6		19.0	29.0	10.0
	HT/VHT20 Beam Forming, M16 to M23	3	5	15.0	14.1	13.6		19.0	30.0	11.0
	HT/VHT20 Beam Forming, M0 to M7	4	11	11.2	10.7	11.3	12.4	17.5	25.0	7.5
	HT/VHT20 Beam Forming, M8 to M15	4	8	15.0	14.1	13.6	16.1	20.8	28.0	7.2
HT/VHT20 Beam Forming, M16 to M23	4	6	15.0	14.1	13.6	16.1	20.8	30.0	9.2	
HT/VHT20 STBC, M0 to M7	2	5	15.0	14.1			17.6	30.0	12.4	



HT/VHT20 STBC, M0 to M7	3	5	15.0	14.1	13.6		19.0	30.0	11.0
HT/VHT20 STBC, M0 to M7	4	5	15.0	14.1	13.6	16.1	20.8	30.0	9.2



**Peak Output Power, 5785 MHz, HT/VHT20 Beam Forming, M0 to M7**

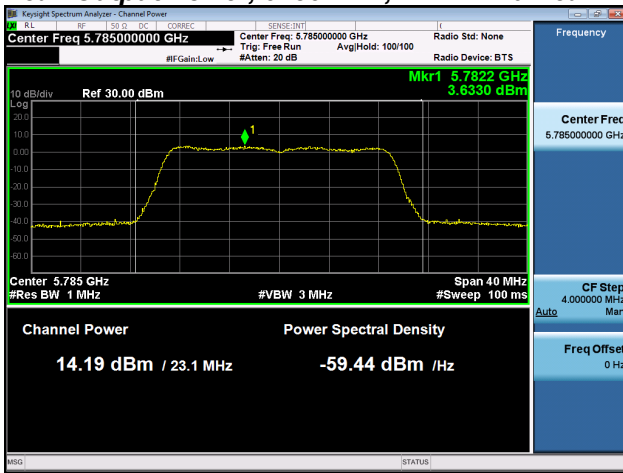

**Antenna A**

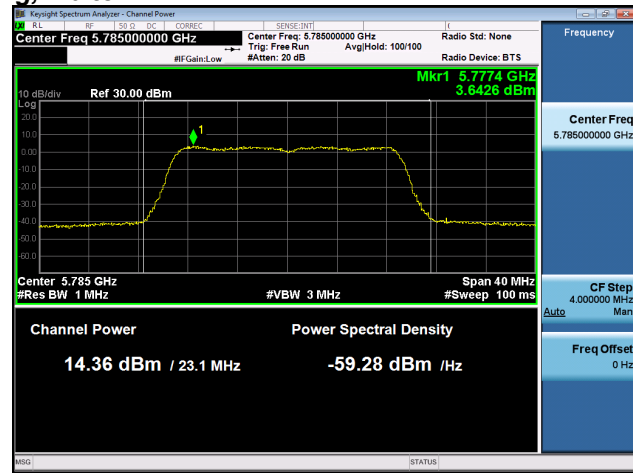

**Antenna B**

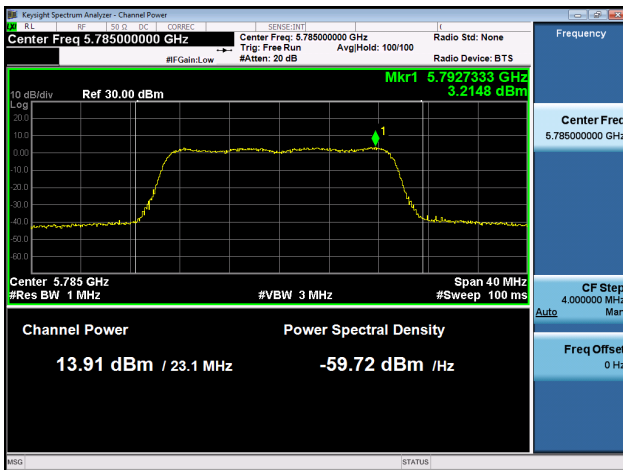

**Antenna C**

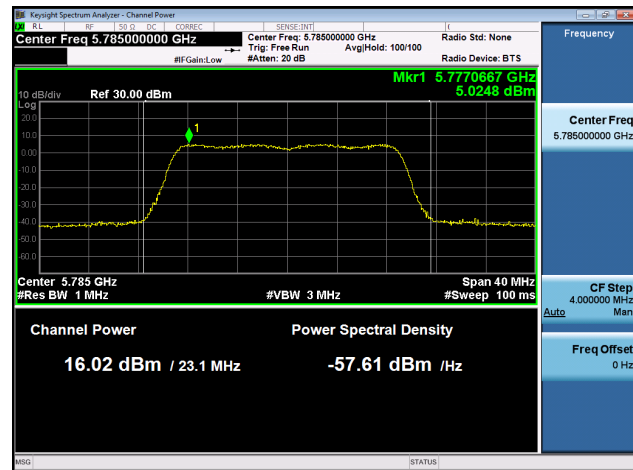

**Antenna D**



## Antenna Gain : 6 dBi

Frequency (MHz)	Mode	Tx Paths	Correlated Antenna Gain (dBi)	Tx 1 Max Power (dBm)	Tx 2 Max Power (dBm)	Tx 3 Max Power (dBm)	Tx 4 Max Power (dBm)	Total Tx Channel Power (dBm)	Limit (dBm)	Margin (dB)	
5745	Non HT20, 6 to 54 Mbps	1	6	16.0				16.0	30.0	14.0	
	Non HT20, 6 to 54 Mbps	2	6	12.3	11.4			14.9	30.0	15.1	
	Non HT20, 6 to 54 Mbps	3	6	12.3	11.4	10.7		16.3	30.0	13.7	
	Non HT20, 6 to 54 Mbps	4	6	11.3	10.5	9.8	12.1	17.0	30.0	13.0	
	Non HT20 Beam Forming, 6 to 54 Mbps	2	9	9.4	8.5			12.0	27.0	15.0	
	Non HT20 Beam Forming, 6 to 54 Mbps	3	11	7.6	6.6	5.8		11.5	25.0	13.5	
	Non HT20 Beam Forming, 6 to 54 Mbps	4	12	6.5	5.5	4.7	7.3	12.1	24.0	11.9	
	HT/VHT20, M0 to M7	1	6	16.2				16.2	30.0	13.8	
	HT/VHT20, M0 to M7	2	6	13.7	12.7			16.2	30.0	13.8	
	HT/VHT20, M8 to M15	2	6	13.7	12.7			16.2	30.0	13.8	
	HT/VHT20, M0 to M7	3	6	13.7	12.7	11.9		17.6	30.0	12.4	
	HT/VHT20, M8 to M15	3	6	13.7	12.7	11.9		17.6	30.0	12.4	
	HT/VHT20, M16 to M23	3	6	13.7	12.7	11.9		17.6	30.0	12.4	
	HT/VHT20, M0 to M7	4	6	13.7	12.7	11.9	14.3	19.3	30.0	10.7	
	HT/VHT20, M8 to M15	4	6	13.7	12.7	11.9	14.3	19.3	30.0	10.7	
	HT/VHT20, M16 to M23	4	6	13.7	12.7	11.9	14.3	19.3	30.0	10.7	
	HT/VHT20 Beam Forming, M0 to M7	2	9	9.7	8.7			12.2	27.0	14.8	
	HT/VHT20 Beam Forming, M8 to M15	2	6	13.7	12.7			16.2	30.0	13.8	
	HT/VHT20 Beam Forming, M0 to M7	3	11	7.7	6.8	6.0		11.7	25.0	13.3	
	HT/VHT20 Beam Forming, M8 to M15	3	8	10.6	9.6	8.9		14.5	28.0	13.5	
	HT/VHT20 Beam Forming, M16 to M23	3	6	13.7	12.7	11.9		17.6	30.0	12.4	
	HT/VHT20 Beam Forming, M0 to M7	4	12	5.7	4.6	3.9	6.4	11.3	24.0	12.7	
	HT/VHT20 Beam Forming, M8 to M15	4	9	8.7	7.7	6.9	9.4	14.3	27.0	12.7	
	HT/VHT20 Beam Forming, M16 to M23	4	7	11.5	10.7	10.0	12.3	17.2	29.0	11.8	
	HT/VHT20 STBC, M0 to M7	2	6	13.7	12.7			16.2	30.0	13.8	
	HT/VHT20 STBC, M0 to M7	3	6	13.7	12.7	11.9		17.6	30.0	12.4	
	HT/VHT20 STBC, M0 to M7	4	6	13.7	12.7	11.9	14.3	19.3	30.0	10.7	
	5755	Non HT40, 6 to 54 Mbps	1	6	12.5				12.5	30.0	17.5
		Non HT40, 6 to 54 Mbps	2	6	6.6	5.4			9.1	30.0	20.9
		Non HT40, 6 to 54 Mbps	3	6	3.8	2.6	2.1		7.7	30.0	22.3
Non HT40, 6 to 54 Mbps		4	6	3.8	2.6	2.1	4.7	9.4	30.0	20.6	
HT/VHT40, M0 to M7		1	6	14.5				14.5	30.0	15.5	



	HT/VHT40, M0 to M7	2	6	10.3	9.4			12.9	30.0	17.1
	HT/VHT40, M8 to M15	2	6	10.3	9.4			12.9	30.0	17.1
	HT/VHT40, M0 to M7	3	6	10.3	9.4	8.5		14.2	30.0	15.8
	HT/VHT40, M8 to M15	3	6	10.3	9.4	8.5		14.2	30.0	15.8
	HT/VHT40, M16 to M23	3	6	10.3	9.4	8.5		14.2	30.0	15.8
	HT/VHT40, M0 to M7	4	6	10.3	9.4	8.5	11.0	15.9	30.0	14.1
	HT/VHT40, M8 to M15	4	6	10.3	9.4	8.5	11.0	15.9	30.0	14.1
	HT/VHT40, M16 to M23	4	6	10.3	9.4	8.5	11.0	15.9	30.0	14.1
	HT/VHT40 Beam Forming, M0 to M7	2	9	10.3	9.4			12.9	27.0	14.1
	HT/VHT40 Beam Forming, M8 to M15	2	6	10.3	9.4			12.9	30.0	17.1
	HT/VHT40 Beam Forming, M0 to M7	3	11	4.3	3.2	2.8		8.3	25.0	16.7
	HT/VHT40 Beam Forming, M8 to M15	3	8	10.3	9.4	8.5		14.2	28.0	13.8
	HT/VHT40 Beam Forming, M16 to M23	3	6	10.3	9.4	8.5		14.2	30.0	15.8
	HT/VHT40 Beam Forming, M0 to M7	4	12	4.3	3.2	2.8	5.1	10.0	24.0	14.0
	HT/VHT40 Beam Forming, M8 to M15	4	9	6.3	5.1	4.6	7.2	11.9	27.0	15.1
	HT/VHT40 Beam Forming, M16 to M23	4	7	10.3	9.4	8.5	11.0	15.9	29.0	13.1
	HT/VHT40 STBC, M0 to M7	2	6	10.3	9.4			12.9	30.0	17.1
	HT/VHT40 STBC, M0 to M7	3	6	10.3	9.4	8.5		14.2	30.0	15.8
	HT/VHT40 STBC, M0 to M7	4	6	10.3	9.4	8.5	11.0	15.9	30.0	14.1
5775	Non HT80, 6 to 54 Mbps	1	6	11.9				11.9	30.0	18.1
	Non HT80, 6 to 54 Mbps	2	6	11.9	11.7			14.8	30.0	15.2
	Non HT80, 6 to 54 Mbps	3	6	9.7	9.4	9.5		14.3	30.0	15.7
	Non HT80, 6 to 54 Mbps	4	6	8.9	7.4	7.6	10.2	14.7	30.0	15.3
	VHT80, M0 to M9 1ss	1	6	13.7				13.7	30.0	16.3
	VHT80, M0 to M9 1ss	2	6	11.4	11.2			14.3	30.0	15.7
	VHT80, M0 to M9 2ss	2	6	11.4	11.2			14.3	30.0	15.7
	VHT80, M0 to M9 1ss	3	6	10.3	10.0	10.3		15.0	30.0	15.0
	VHT80, M0 to M9 2ss	3	6	10.3	10.0	10.3		15.0	30.0	15.0
	VHT80, M0 to M9 3ss	3	6	10.3	10.0	10.3		15.0	30.0	15.0
	VHT80, M0 to M9 1ss	4	6	10.3	10.0	10.3	11.5	16.6	30.0	13.4
	VHT80, M0 to M9 2ss	4	6	10.3	10.0	10.3	11.5	16.6	30.0	13.4
	VHT80, M0 to M9 3ss	4	6	10.3	10.0	10.3	11.5	16.6	30.0	13.4
	VHT80 Beam Forming, M0 to M9 1ss	2	9	10.3	10.0			13.2	27.0	13.8
	VHT80 Beam Forming, M0 to M9 2ss	2	6	11.4	11.2			14.3	30.0	15.7
	VHT80 Beam Forming, M0 to M9 1ss	3	11	6.6	6.1	6.3		11.1	25.0	13.9
	VHT80 Beam Forming, M0 to M9 2ss	3	8	10.3	10.0	10.3		15.0	28.0	13.0
	VHT80 Beam Forming, M0 to M9 3ss	3	6	10.3	10.0	10.3		15.0	30.0	15.0
	VHT80 Beam Forming, M0 to M9 1ss	4	12	4.4	4.1	4.3	5.4	10.6	24.0	13.4
	VHT80 Beam Forming, M0 to M9 2ss	4	9	8.4	8.0	8.2	9.6	14.6	27.0	12.4
VHT80 Beam Forming, M0 to M9 3ss	4	7	10.3	10.0	10.3	11.5	16.6	29.0	12.4	



	VHT80 STBC, M0 to M9 1ss	2	6	11.4	11.2			14.3	30.0	15.7
	VHT80 STBC, M0 to M9 1ss	3	6	10.3	10.0	10.3		15.0	30.0	15.0
	VHT80 STBC, M0 to M9 1ss	4	6	10.3	10.0	10.3	11.5	16.6	30.0	13.4
5785	Non HT20, 6 to 54 Mbps	1	6	14.0				14.0	30.0	16.0
	Non HT20, 6 to 54 Mbps	2	6	14.0	14.1			17.1	30.0	12.9
	Non HT20, 6 to 54 Mbps	3	6	14.0	14.1	13.7		18.7	30.0	11.3
	Non HT20, 6 to 54 Mbps	4	6	14.0	14.1	13.7	15.8	20.5	30.0	9.5
	Non HT20 Beam Forming, 6 to 54 Mbps	2	9	14.0	14.1			17.1	27.0	9.9
	Non HT20 Beam Forming, 6 to 54 Mbps	3	11	14.0	14.1	13.7		18.7	25.0	6.3
	Non HT20 Beam Forming, 6 to 54 Mbps	4	12	14.0	14.1	13.7	15.8	20.5	24.0	3.5
	HT/VHT20, M0 to M7	1	6	14.2				14.2	30.0	15.8
	HT/VHT20, M0 to M7	2	6	14.2	14.4			17.3	30.0	12.7
	HT/VHT20, M8 to M15	2	6	14.2	14.4			17.3	30.0	12.7
	HT/VHT20, M0 to M7	3	6	14.2	14.4	13.9		18.9	30.0	11.1
	HT/VHT20, M8 to M15	3	6	14.2	14.4	13.9		18.9	30.0	11.1
	HT/VHT20, M16 to M23	3	6	14.2	14.4	13.9		18.9	30.0	11.1
	HT/VHT20, M0 to M7	4	6	14.2	14.4	13.9	16.0	20.7	30.0	9.3
	HT/VHT20, M8 to M15	4	6	14.2	14.4	13.9	16.0	20.7	30.0	9.3
	HT/VHT20, M16 to M23	4	6	14.2	14.4	13.9	16.0	20.7	30.0	9.3
	HT/VHT20 Beam Forming, M0 to M7	2	9	14.2	14.4			17.3	27.0	9.7
	HT/VHT20 Beam Forming, M8 to M15	2	6	14.2	14.4			17.3	30.0	12.7
	HT/VHT20 Beam Forming, M0 to M7	3	11	14.2	14.4	13.9		18.9	25.0	6.1
	HT/VHT20 Beam Forming, M8 to M15	3	8	14.2	14.4	13.9		18.9	28.0	9.1
	HT/VHT20 Beam Forming, M16 to M23	3	6	14.2	14.4	13.9		18.9	30.0	11.1
	<b>HT/VHT20 Beam Forming, M0 to M7</b>	<b>4</b>	<b>12</b>	<b>14.2</b>	<b>14.4</b>	<b>13.9</b>	<b>16.0</b>	<b>20.7</b>	<b>24.0</b>	<b>3.3</b>
	HT/VHT20 Beam Forming, M8 to M15	4	9	14.2	14.4	13.9	16.0	20.7	27.0	6.3
	HT/VHT20 Beam Forming, M16 to M23	4	7	14.2	14.4	13.9	16.0	20.7	29.0	8.3
	HT/VHT20 STBC, M0 to M7	2	6	14.2	14.4			17.3	30.0	12.7
	HT/VHT20 STBC, M0 to M7	3	6	14.2	14.4	13.9		18.9	30.0	11.1
HT/VHT20 STBC, M0 to M7	4	6	14.2	14.4	13.9	16.0	20.7	30.0	9.3	
5795	Non HT40, 6 to 54 Mbps	1	6	14.2				14.2	30.0	15.8
	Non HT40, 6 to 54 Mbps	2	6	14.2	14.5			17.4	30.0	12.6
	Non HT40, 6 to 54 Mbps	3	6	14.2	14.5	15.1		19.4	30.0	10.6
	Non HT40, 6 to 54 Mbps	4	6	14.2	14.5	15.1	16.2	21.1	30.0	8.9
	HT/VHT40, M0 to M7	1	6	14.2				14.2	30.0	15.8
	HT/VHT40, M0 to M7	2	6	14.2	13.4			16.8	30.0	13.2
	HT/VHT40, M8 to M15	2	6	14.2	13.4			16.8	30.0	13.2
	HT/VHT40, M0 to M7	3	6	14.2	13.4	13.9		18.6	30.0	11.4
	HT/VHT40, M8 to M15	3	6	14.2	13.4	13.9		18.6	30.0	11.4



	HT/VHT40, M16 to M23	3	6	14.2	13.4	13.9		18.6	30.0	11.4
	HT/VHT40, M0 to M7	4	6	14.2	13.4	13.9	16.1	20.5	30.0	9.5
	HT/VHT40, M8 to M15	4	6	14.2	13.4	13.9	16.1	20.5	30.0	9.5
	HT/VHT40, M16 to M23	4	6	14.2	13.4	13.9	16.1	20.5	30.0	9.5
	HT/VHT40 Beam Forming, M0 to M7	2	9	14.2	13.4			16.8	27.0	10.2
	HT/VHT40 Beam Forming, M8 to M15	2	6	14.2	13.4			16.8	30.0	13.2
	HT/VHT40 Beam Forming, M0 to M7	3	11	14.2	13.4	13.9		18.6	25.0	6.4
	HT/VHT40 Beam Forming, M8 to M15	3	8	14.2	13.4	13.9		18.6	28.0	9.4
	HT/VHT40 Beam Forming, M16 to M23	3	6	14.2	13.4	13.9		18.6	30.0	11.4
	HT/VHT40 Beam Forming, M0 to M7	4	12	14.2	13.4	13.9	16.1	20.5	24.0	3.5
	HT/VHT40 Beam Forming, M8 to M15	4	9	14.2	13.4	13.9	16.1	20.5	27.0	6.5
	HT/VHT40 Beam Forming, M16 to M23	4	7	14.2	13.4	13.9	16.1	20.5	29.0	8.5
	HT/VHT40 STBC, M0 to M7	2	6	14.2	13.4			16.8	30.0	13.2
	HT/VHT40 STBC, M0 to M7	3	6	14.2	13.4	13.9		18.6	30.0	11.4
	HT/VHT40 STBC, M0 to M7	4	6	14.2	13.4	13.9	16.1	20.5	30.0	9.5
5825	Non HT20, 6 to 54 Mbps	1	6	14.8				14.8	30.0	15.2
	Non HT20, 6 to 54 Mbps	2	6	14.8	13.9			17.4	30.0	12.6
	Non HT20, 6 to 54 Mbps	3	6	14.8	13.9	13.4		18.8	30.0	11.2
	Non HT20, 6 to 54 Mbps	4	6	14.8	13.9	13.4	15.8	20.6	30.0	9.4
	Non HT20 Beam Forming, 6 to 54 Mbps	2	9	14.8	13.9			17.4	27.0	9.6
	Non HT20 Beam Forming, 6 to 54 Mbps	3	11	13.6	12.7	13.5		18.1	25.0	6.9
	Non HT20 Beam Forming, 6 to 54 Mbps	4	12	9.7	9.4	10.0	11.2	16.2	24.0	7.8
	HT/VHT20, M0 to M7	1	6	15.0				15.0	30.0	15.0
	HT/VHT20, M0 to M7	2	6	15.0	14.1			17.6	30.0	12.4
	HT/VHT20, M8 to M15	2	6	15.0	14.1			17.6	30.0	12.4
	HT/VHT20, M0 to M7	3	6	15.0	14.1	13.6		19.0	30.0	11.0
	HT/VHT20, M8 to M15	3	6	15.0	14.1	13.6		19.0	30.0	11.0
	HT/VHT20, M16 to M23	3	6	15.0	14.1	13.6		19.0	30.0	11.0
	HT/VHT20, M0 to M7	4	6	15.0	14.1	13.6	16.1	20.8	30.0	9.2
	HT/VHT20, M8 to M15	4	6	15.0	14.1	13.6	16.1	20.8	30.0	9.2
	HT/VHT20, M16 to M23	4	6	15.0	14.1	13.6	16.1	20.8	30.0	9.2
	HT/VHT20 Beam Forming, M0 to M7	2	9	15.0	14.1			17.6	27.0	9.4
	HT/VHT20 Beam Forming, M8 to M15	2	6	15.0	14.1			17.6	30.0	12.4
	HT/VHT20 Beam Forming, M0 to M7	3	11	12.5	11.9	12.5		17.1	25.0	7.9
	HT/VHT20 Beam Forming, M8 to M15	3	8	15.0	14.1	13.6		19.0	28.0	9.0
HT/VHT20 Beam Forming, M16 to M23	3	6	15.0	14.1	13.6		19.0	30.0	11.0	
HT/VHT20 Beam Forming, M0 to M7	4	12	10.0	9.6	10.3	11.4	16.4	24.0	7.6	
HT/VHT20 Beam Forming, M8 to M15	4	9	13.8	13.0	13.6	14.8	19.9	27.0	7.1	
HT/VHT20 Beam Forming, M16 to M23	4	7	15.0	14.1	13.6	16.1	20.8	29.0	8.2	
HT/VHT20 STBC, M0 to M7	2	6	15.0	14.1			17.6	30.0	12.4	



HT/VHT20 STBC, M0 to M7	3	6	15.0	14.1	13.6		19.0	30.0	11.0
HT/VHT20 STBC, M0 to M7	4	6	15.0	14.1	13.6	16.1	20.8	30.0	9.2





**Peak Output Power, 5785 MHz, HT/VHT20 Beam Forming, M0 to M7**

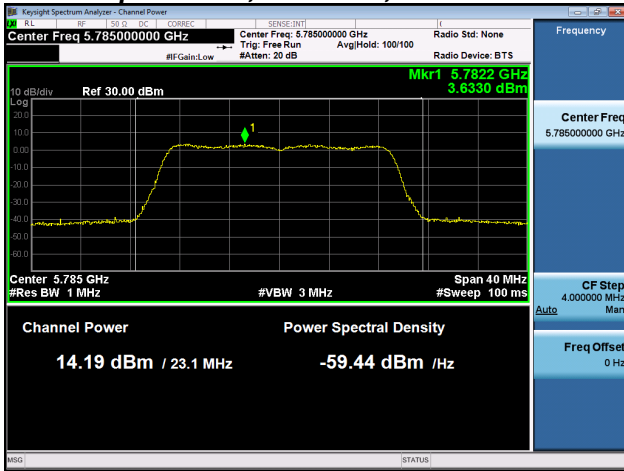

**Antenna A**

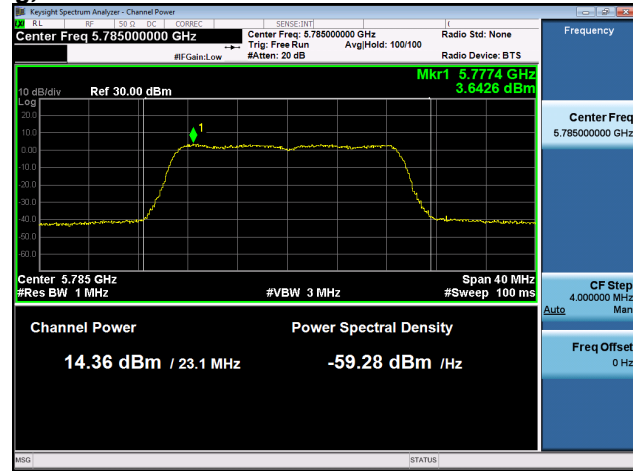

**Antenna B**

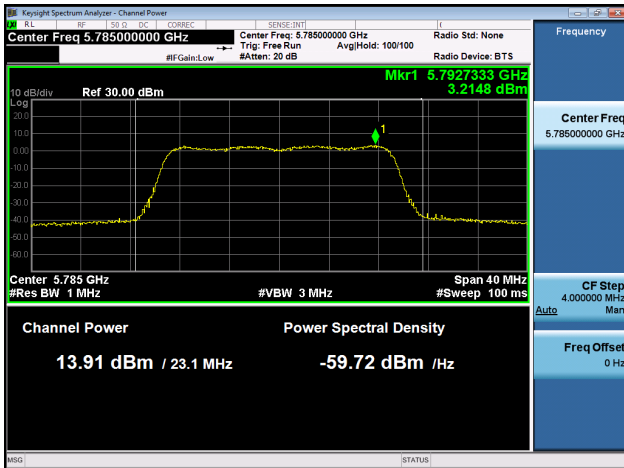

**Antenna C**

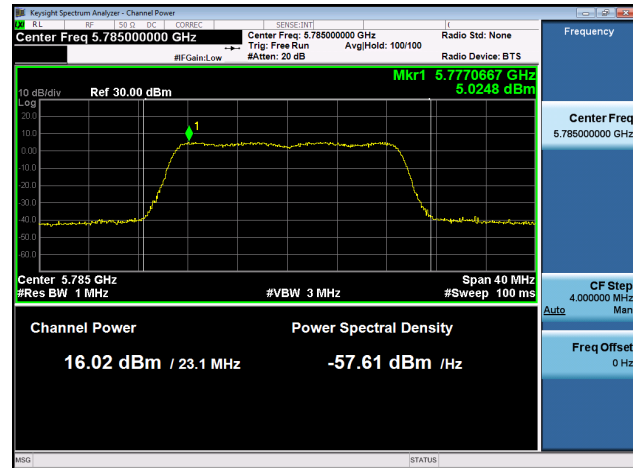

**Antenna D**



## Antenna Gain : 8 dBi

Frequency (MHz)	Mode	Tx Paths	Correlated Antenna Gain (dBi)	Tx 1 Max Power (dBm)	Tx 2 Max Power (dBm)	Tx 3 Max Power (dBm)	Tx 4 Max Power (dBm)	Total Tx Channel Power (dBm)	Limit (dBm)	Margin (dB)	
5745	Non HT20, 6 to 54 Mbps	1	8	13.6				13.6	28.0	14.4	
	Non HT20, 6 to 54 Mbps	2	8	10.4	9.4			12.9	28.0	15.1	
	Non HT20, 6 to 54 Mbps	3	8	10.4	9.4	8.7		14.3	28.0	13.7	
	Non HT20, 6 to 54 Mbps	4	8	10.4	9.4	8.7	11.2	16.0	28.0	12.0	
	Non HT20 Beam Forming, 6 to 54 Mbps	2	11	7.6	6.6			10.1	25.0	14.9	
	Non HT20 Beam Forming, 6 to 54 Mbps	3	13	6.5	5.5	4.7		10.4	23.0	12.6	
	Non HT20 Beam Forming, 6 to 54 Mbps	4	14	4.7	3.5	2.6	5.3	10.2	22.0	11.8	
	HT/VHT20, M0 to M7	1	8	13.7				13.7	28.0	14.3	
	HT/VHT20, M0 to M7	2	8	10.6	9.6			13.1	28.0	14.9	
	HT/VHT20, M8 to M15	2	8	10.6	9.6			13.1	28.0	14.9	
	HT/VHT20, M0 to M7	3	8	10.6	9.6	8.9		14.5	28.0	13.5	
	HT/VHT20, M8 to M15	3	8	10.6	9.6	8.9		14.5	28.0	13.5	
	HT/VHT20, M16 to M23	3	8	10.6	9.6	8.9		14.5	28.0	13.5	
	HT/VHT20, M0 to M7	4	8	10.6	9.6	8.9	11.4	16.2	28.0	11.8	
	HT/VHT20, M8 to M15	4	8	10.6	9.6	8.9	11.4	16.2	28.0	11.8	
	HT/VHT20, M16 to M23	4	8	10.6	9.6	8.9	11.4	16.2	28.0	11.8	
	HT/VHT20 Beam Forming, M0 to M7	2	11	7.7	6.8			10.3	25.0	14.7	
	HT/VHT20 Beam Forming, M8 to M15	2	8	10.6	9.6			13.1	28.0	14.9	
	HT/VHT20 Beam Forming, M0 to M7	3	13	5.7	4.6	3.9		9.6	23.0	13.4	
	HT/VHT20 Beam Forming, M8 to M15	3	10	8.7	7.7	6.9		12.6	26.0	13.4	
	HT/VHT20 Beam Forming, M16 to M23	3	8	10.6	9.6	8.9		14.5	28.0	13.5	
	HT/VHT20 Beam Forming, M0 to M7	4	14	4.8	3.6	2.7	5.4	10.3	22.0	11.7	
	HT/VHT20 Beam Forming, M8 to M15	4	11	6.6	5.6	4.8	7.4	12.2	25.0	12.8	
	HT/VHT20 Beam Forming, M16 to M23	4	9	8.7	7.7	6.9	9.4	14.3	27.0	12.7	
	HT/VHT20 STBC, M0 to M7	2	8	10.6	9.6			13.1	28.0	14.9	
	HT/VHT20 STBC, M0 to M7	3	8	10.6	9.6	8.9		14.5	28.0	13.5	
	HT/VHT20 STBC, M0 to M7	4	8	10.6	9.6	8.9	11.4	16.2	28.0	11.8	
	5755	Non HT40, 6 to 54 Mbps	1	8	9.7				9.7	28.0	18.3
		Non HT40, 6 to 54 Mbps	2	8	3.8	2.6			6.3	28.0	21.7
		Non HT40, 6 to 54 Mbps	3	8	2.7	1.7	1.2		6.7	28.0	21.3
Non HT40, 6 to 54 Mbps		4	8	2.7	1.7	1.2	3.5	8.4	28.0	19.6	
HT/VHT40, M0 to M7		1	8	10.3				10.3	28.0	17.7	



	HT/VHT40, M0 to M7	2	8	10.3	9.4			12.9	28.0	15.1
	HT/VHT40, M8 to M15	2	8	10.3	9.4			12.9	28.0	15.1
	HT/VHT40, M0 to M7	3	8	10.3	9.4	8.5		14.2	28.0	13.8
	HT/VHT40, M8 to M15	3	8	10.3	9.4	8.5		14.2	28.0	13.8
	HT/VHT40, M16 to M23	3	8	10.3	9.4	8.5		14.2	28.0	13.8
	HT/VHT40, M0 to M7	4	8	6.3	5.1	4.6	7.2	11.9	28.0	16.1
	HT/VHT40, M8 to M15	4	8	6.3	5.1	4.6	7.2	11.9	28.0	16.1
	HT/VHT40, M16 to M23	4	8	6.3	5.1	4.6	7.2	11.9	28.0	16.1
	HT/VHT40 Beam Forming, M0 to M7	2	11	4.3	3.2			6.8	25.0	18.2
	HT/VHT40 Beam Forming, M8 to M15	2	8	10.3	9.4			12.9	28.0	15.1
	HT/VHT40 Beam Forming, M0 to M7	3	13	4.3	3.2	2.8		8.3	23.0	14.7
	HT/VHT40 Beam Forming, M8 to M15	3	10	5.3	4.2	3.7		9.2	26.0	16.8
	HT/VHT40 Beam Forming, M16 to M23	3	8	10.3	9.4	8.5		14.2	28.0	13.8
	HT/VHT40 Beam Forming, M0 to M7	4	14	3.3	2.2	1.6	4.1	8.9	22.0	13.1
	HT/VHT40 Beam Forming, M8 to M15	4	11	4.3	3.2	2.8	5.1	10.0	25.0	15.0
	HT/VHT40 Beam Forming, M16 to M23	4	9	6.3	5.1	4.6	7.2	11.9	27.0	15.1
	HT/VHT40 STBC, M0 to M7	2	8	10.3	9.4			12.9	28.0	15.1
	HT/VHT40 STBC, M0 to M7	3	8	10.3	9.4	8.5		14.2	28.0	13.8
	HT/VHT40 STBC, M0 to M7	4	8	6.3	5.1	4.6	7.2	11.9	28.0	16.1
5775	Non HT80, 6 to 54 Mbps	1	8	11.9				11.9	28.0	16.1
	Non HT80, 6 to 54 Mbps	2	8	9.7	9.4			12.6	28.0	15.4
	Non HT80, 6 to 54 Mbps	3	8	9.8	8.3	8.6		13.7	28.0	14.3
	Non HT80, 6 to 54 Mbps	4	8	5.1	4.8	5.1	6.3	11.4	28.0	16.6
	VHT80, M0 to M9 1ss	1	8	11.4				11.4	28.0	16.6
	VHT80, M0 to M9 1ss	2	8	10.3	10.0			13.2	28.0	14.8
	VHT80, M0 to M9 2ss	2	8	10.3	10.0			13.2	28.0	14.8
	VHT80, M0 to M9 1ss	3	8	10.3	10.0	10.3		15.0	28.0	13.0
	VHT80, M0 to M9 2ss	3	8	10.3	10.0	10.3		15.0	28.0	13.0
	VHT80, M0 to M9 3ss	3	8	10.3	10.0	10.3		15.0	28.0	13.0
	VHT80, M0 to M9 1ss	4	8	10.3	10.0	10.3	11.5	16.6	28.0	11.4
	VHT80, M0 to M9 2ss	4	8	10.3	10.0	10.3	11.5	16.6	28.0	11.4
	VHT80, M0 to M9 3ss	4	8	10.3	10.0	10.3	11.5	16.6	28.0	11.4
	VHT80 Beam Forming, M0 to M9 1ss	2	11	8.4	8.0			11.2	25.0	13.8
	VHT80 Beam Forming, M0 to M9 2ss	2	8	10.3	10.0			13.2	28.0	14.8
	VHT80 Beam Forming, M0 to M9 1ss	3	13	3.5	3.1	3.3		8.1	23.0	14.9
	VHT80 Beam Forming, M0 to M9 2ss	3	10	8.4	8.0	8.2		13.0	26.0	13.0
	VHT80 Beam Forming, M0 to M9 3ss	3	8	10.3	10.0	10.3		15.0	28.0	13.0
	VHT80 Beam Forming, M0 to M9 1ss	4	14	3.5	3.1	3.3	4.5	9.7	22.0	12.3
	VHT80 Beam Forming, M0 to M9 2ss	4	11	5.7	5.2	5.4	6.8	11.8	25.0	13.2
VHT80 Beam Forming, M0 to M9 3ss	4	9	8.4	8.0	8.2	9.6	14.6	27.0	12.4	



	VHT80 STBC, M0 to M9 1ss	2	8	10.3	10.0			13.2	28.0	14.8
	VHT80 STBC, M0 to M9 1ss	3	8	10.3	10.0	10.3		15.0	28.0	13.0
	VHT80 STBC, M0 to M9 1ss	4	8	10.3	10.0	10.3	11.5	16.6	28.0	11.4
5785	Non HT20, 6 to 54 Mbps	1	8	14.0				14.0	28.0	14.0
	Non HT20, 6 to 54 Mbps	2	8	14.0	14.1			17.1	28.0	10.9
	Non HT20, 6 to 54 Mbps	3	8	14.0	14.1	13.7		18.7	28.0	9.3
	Non HT20, 6 to 54 Mbps	4	8	14.0	14.1	13.7	15.8	20.5	28.0	7.5
	Non HT20 Beam Forming, 6 to 54 Mbps	2	11	14.0	14.1			17.1	25.0	7.9
	Non HT20 Beam Forming, 6 to 54 Mbps	3	13	14.0	14.1	13.7		18.7	23.0	4.3
	Non HT20 Beam Forming, 6 to 54 Mbps	4	14	12.7	13.0	13.7	14.6	19.6	22.0	2.4
	HT/VHT20, M0 to M7	1	8	14.2				14.2	28.0	13.8
	HT/VHT20, M0 to M7	2	8	14.2	14.4			17.3	28.0	10.7
	HT/VHT20, M8 to M15	2	8	14.2	14.4			17.3	28.0	10.7
	HT/VHT20, M0 to M7	3	8	14.2	14.4	13.9		18.9	28.0	9.1
	HT/VHT20, M8 to M15	3	8	14.2	14.4	13.9		18.9	28.0	9.1
	HT/VHT20, M16 to M23	3	8	14.2	14.4	13.9		18.9	28.0	9.1
	HT/VHT20, M0 to M7	4	8	14.2	14.4	13.9	16.0	20.7	28.0	7.3
	HT/VHT20, M8 to M15	4	8	14.2	14.4	13.9	16.0	20.7	28.0	7.3
	HT/VHT20, M16 to M23	4	8	14.2	14.4	13.9	16.0	20.7	28.0	7.3
	HT/VHT20 Beam Forming, M0 to M7	2	11	14.2	14.4			17.3	25.0	7.7
	HT/VHT20 Beam Forming, M8 to M15	2	8	14.2	14.4			17.3	28.0	10.7
	HT/VHT20 Beam Forming, M0 to M7	3	13	14.2	14.4	13.9		18.9	23.0	4.1
	HT/VHT20 Beam Forming, M8 to M15	3	10	14.2	14.4	13.9		18.9	26.0	7.1
	HT/VHT20 Beam Forming, M16 to M23	3	8	14.2	14.4	13.9		18.9	28.0	9.1
	<b>HT/VHT20 Beam Forming, M0 to M7</b>	<b>4</b>	<b>14</b>	<b>12.9</b>	<b>13.2</b>	<b>13.9</b>	<b>14.7</b>	<b>19.8</b>	<b>22.0</b>	<b>2.2</b>
	HT/VHT20 Beam Forming, M8 to M15	4	11	14.2	14.4	13.9	16.0	20.7	25.0	4.3
	HT/VHT20 Beam Forming, M16 to M23	4	9	14.2	14.4	13.9	16.0	20.7	27.0	6.3
	HT/VHT20 STBC, M0 to M7	2	8	14.2	14.4			17.3	28.0	10.7
	HT/VHT20 STBC, M0 to M7	3	8	14.2	14.4	13.9		18.9	28.0	9.1
HT/VHT20 STBC, M0 to M7	4	8	14.2	14.4	13.9	16.0	20.7	28.0	7.3	
5795	Non HT40, 6 to 54 Mbps	1	8	14.2				14.2	28.0	13.8
	Non HT40, 6 to 54 Mbps	2	8	14.2	14.5			17.4	28.0	10.6
	Non HT40, 6 to 54 Mbps	3	8	14.2	14.5	15.1		19.4	28.0	8.6
	Non HT40, 6 to 54 Mbps	4	8	14.2	14.5	15.1	16.2	21.1	28.0	6.9
	HT/VHT40, M0 to M7	1	8	14.2				14.2	28.0	13.8
	HT/VHT40, M0 to M7	2	8	14.2	13.4			16.8	28.0	11.2
	HT/VHT40, M8 to M15	2	8	14.2	13.4			16.8	28.0	11.2
	HT/VHT40, M0 to M7	3	8	14.2	13.4	13.9		18.6	28.0	9.4
	HT/VHT40, M8 to M15	3	8	14.2	13.4	13.9		18.6	28.0	9.4



	HT/VHT40, M16 to M23	3	8	14.2	13.4	13.9		18.6	28.0	9.4
	HT/VHT40, M0 to M7	4	8	14.2	13.4	13.9	16.1	20.5	28.0	7.5
	HT/VHT40, M8 to M15	4	8	14.2	13.4	13.9	16.1	20.5	28.0	7.5
	HT/VHT40, M16 to M23	4	8	14.2	13.4	13.9	16.1	20.5	28.0	7.5
	HT/VHT40 Beam Forming, M0 to M7	2	11	14.2	13.4			16.8	25.0	8.2
	HT/VHT40 Beam Forming, M8 to M15	2	8	14.2	13.4			16.8	28.0	11.2
	HT/VHT40 Beam Forming, M0 to M7	3	13	14.2	13.4	13.9		18.6	23.0	4.4
	HT/VHT40 Beam Forming, M8 to M15	3	10	14.2	13.4	13.9		18.6	26.0	7.4
	HT/VHT40 Beam Forming, M16 to M23	3	8	14.2	13.4	13.9		18.6	28.0	9.4
	HT/VHT40 Beam Forming, M0 to M7	4	14	11.9	12.3	12.9	13.7	18.8	22.0	3.2
	HT/VHT40 Beam Forming, M8 to M15	4	11	14.2	13.4	13.9	16.1	20.5	25.0	4.5
	HT/VHT40 Beam Forming, M16 to M23	4	9	14.2	13.4	13.9	16.1	20.5	27.0	6.5
	HT/VHT40 STBC, M0 to M7	2	8	14.2	13.4			16.8	28.0	11.2
	HT/VHT40 STBC, M0 to M7	3	8	14.2	13.4	13.9		18.6	28.0	9.4
	HT/VHT40 STBC, M0 to M7	4	8	14.2	13.4	13.9	16.1	20.5	28.0	7.5
5825	Non HT20, 6 to 54 Mbps	1	8	14.8				14.8	28.0	13.2
	Non HT20, 6 to 54 Mbps	2	8	14.8	13.9			17.4	28.0	10.6
	Non HT20, 6 to 54 Mbps	3	8	14.8	13.9	13.4		18.8	28.0	9.2
	Non HT20, 6 to 54 Mbps	4	8	14.8	13.9	13.4	15.8	20.6	28.0	7.4
	Non HT20 Beam Forming, 6 to 54 Mbps	2	11	14.8	13.9			17.4	25.0	7.6
	Non HT20 Beam Forming, 6 to 54 Mbps	3	13	11.0	10.5	11.0		15.6	23.0	7.4
	Non HT20 Beam Forming, 6 to 54 Mbps	4	14	7.7	7.3	7.9	9.2	14.1	22.0	7.9
	HT/VHT20, M0 to M7	1	8	15.0				15.0	28.0	13.0
	HT/VHT20, M0 to M7	2	8	15.0	14.1			17.6	28.0	10.4
	HT/VHT20, M8 to M15	2	8	15.0	14.1			17.6	28.0	10.4
	HT/VHT20, M0 to M7	3	8	15.0	14.1	13.6		19.0	28.0	9.0
	HT/VHT20, M8 to M15	3	8	15.0	14.1	13.6		19.0	28.0	9.0
	HT/VHT20, M16 to M23	3	8	15.0	14.1	13.6		19.0	28.0	9.0
	HT/VHT20, M0 to M7	4	8	15.0	14.1	13.6	16.1	20.8	28.0	7.2
	HT/VHT20, M8 to M15	4	8	15.0	14.1	13.6	16.1	20.8	28.0	7.2
	HT/VHT20, M16 to M23	4	8	15.0	14.1	13.6	16.1	20.8	28.0	7.2
	HT/VHT20 Beam Forming, M0 to M7	2	11	15.0	14.1			17.6	25.0	7.4
	HT/VHT20 Beam Forming, M8 to M15	2	8	15.0	14.1			17.6	28.0	10.4
	HT/VHT20 Beam Forming, M0 to M7	3	13	11.2	10.7	11.3		15.8	23.0	7.2
	HT/VHT20 Beam Forming, M8 to M15	3	10	15.0	14.1	13.6		19.0	26.0	7.0
HT/VHT20 Beam Forming, M16 to M23	3	8	15.0	14.1	13.6		19.0	28.0	9.0	
HT/VHT20 Beam Forming, M0 to M7	4	14	8.9	8.7	9.4	10.4	15.4	22.0	6.6	
HT/VHT20 Beam Forming, M8 to M15	4	11	11.2	10.7	11.3	12.4	17.5	25.0	7.5	
HT/VHT20 Beam Forming, M16 to M23	4	9	13.8	13.0	13.6	14.8	19.9	27.0	7.1	
HT/VHT20 STBC, M0 to M7	2	8	15.0	14.1			17.6	28.0	10.4	



HT/VHT20 STBC, M0 to M7	3	8	15.0	14.1	13.6		19.0	28.0	9.0
HT/VHT20 STBC, M0 to M7	4	8	15.0	14.1	13.6	16.1	20.8	28.0	7.2



**Peak Output Power, 5785 MHz, HT/VHT20 Beam Forming, M0 to M7**

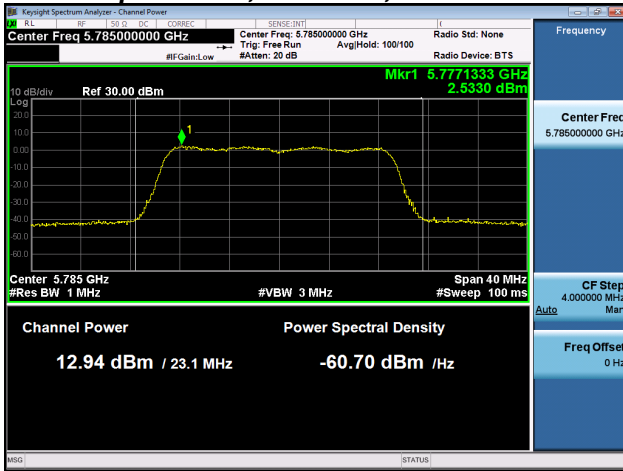

**Antenna A**

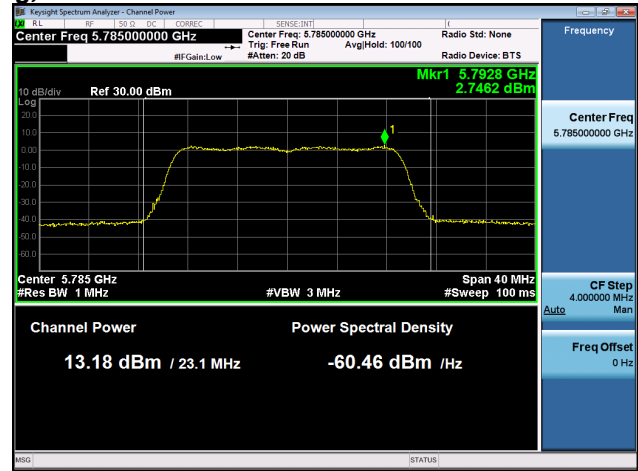

**Antenna B**

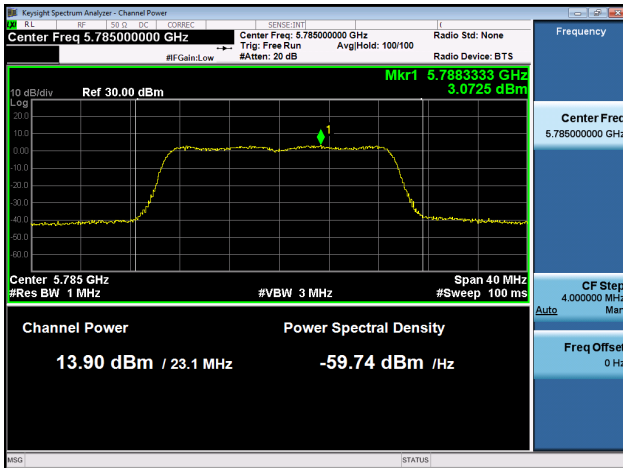

**Antenna C**

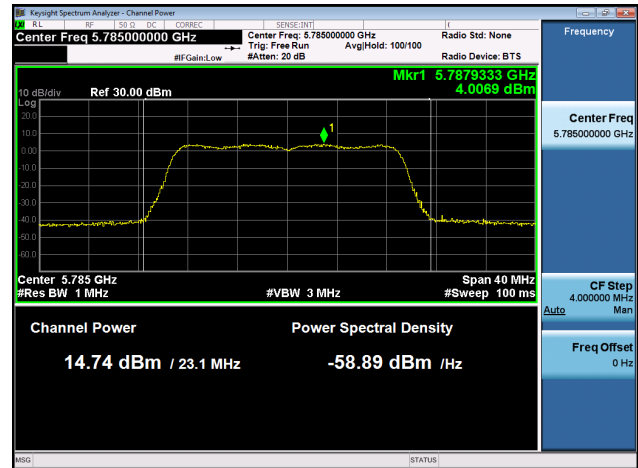

**Antenna D**



## Antenna Gain : 13 dBi

Frequency (MHz)	Mode	Tx Paths	Correlated Antenna Gain (dBi)	Tx 1 Max Power (dBm)	Tx 2 Max Power (dBm)	Tx 3 Max Power (dBm)	Tx 4 Max Power (dBm)	Total Tx Channel Power (dBm)	Limit (dBm)	Margin (dB)
5745	Non HT20, 6 to 54 Mbps	1	13	8.5				8.5	30.0	21.5
	Non HT20, 6 to 54 Mbps	2	13	6.5	5.5			9.0	30.0	21.0
	Non HT20, 6 to 54 Mbps	3	13	6.5	5.5	4.7		10.4	30.0	19.6
	Non HT20, 6 to 54 Mbps	4	13	5.5	4.5	3.7	6.2	11.1	30.0	18.9
	Non HT20 Beam Forming, 6 to 54 Mbps	2	13	6.5	5.5			9.0	30.0	21.0
	Non HT20 Beam Forming, 6 to 54 Mbps	3	16	3.8	2.5	1.6		7.5	30.0	22.5
	Non HT20 Beam Forming, 6 to 54 Mbps	4	16	3.8	2.5	1.6	4.5	9.3	30.0	20.7
	HT/VHT20, M0 to M7	1	13	8.7				8.7	30.0	21.3
	HT/VHT20, M0 to M7	2	13	5.7	4.6			8.2	30.0	21.8
	HT/VHT20, M8 to M15	2	13	5.7	4.6			8.2	30.0	21.8
	HT/VHT20, M0 to M7	3	13	5.7	4.6	3.9		9.6	30.0	20.4
	HT/VHT20, M8 to M15	3	13	5.7	4.6	3.9		9.6	30.0	20.4
	HT/VHT20, M16 to M23	3	13	5.7	4.6	3.9		9.6	30.0	20.4
	HT/VHT20, M0 to M7	4	13	5.7	4.6	3.9	6.4	11.3	30.0	18.7
	HT/VHT20, M8 to M15	4	13	5.7	4.6	3.9	6.4	11.3	30.0	18.7
	HT/VHT20, M16 to M23	4	13	5.7	4.6	3.9	6.4	11.3	30.0	18.7
	HT/VHT20 Beam Forming, M0 to M7	2	13	5.7	4.6			8.2	30.0	21.8
	HT/VHT20 Beam Forming, M8 to M15	2	13	5.7	4.6			8.2	30.0	21.8
	HT/VHT20 Beam Forming, M0 to M7	3	16	4.8	3.6	2.7		8.6	30.0	21.4
	HT/VHT20 Beam Forming, M8 to M15	3	13	5.7	4.6	3.9		9.6	30.0	20.4
	HT/VHT20 Beam Forming, M16 to M23	3	13	5.7	4.6	3.9		9.6	30.0	20.4
	HT/VHT20 Beam Forming, M0 to M7	4	16	3.9	2.7	1.8	4.5	9.4	30.0	20.6
	HT/VHT20 Beam Forming, M8 to M15	4	13	5.7	4.6	3.9	6.4	11.3	30.0	18.7
	HT/VHT20 Beam Forming, M16 to M23	4	13	5.7	4.6	3.9	6.4	11.3	30.0	18.7
	HT/VHT20 STBC, M0 to M7	2	13	5.7	4.6			8.2	30.0	21.8
	HT/VHT20 STBC, M0 to M7	3	13	5.7	4.6	3.9		9.6	30.0	20.4
	HT/VHT20 STBC, M0 to M7	4	13	5.7	4.6	3.9	6.4	11.3	30.0	18.7
	5755	Non HT40, 6 to 54 Mbps	1	13	2.7				2.7	30.0
Non HT40, 6 to 54 Mbps		2	13	-0.4	-1.5			2.1	30.0	27.9
Non HT40, 6 to 54 Mbps		3	13	-2.4	-3.5	-4.1		1.5	30.0	28.5
Non HT40, 6 to 54 Mbps		4	13	-2.4	-3.5	-4.1	-1.6	3.2	30.0	26.8
HT/VHT40, M0 to M7		1	13	4.3				4.3	30.0	25.7





	HT/VHT40, M0 to M7	2	13	4.3	3.2			6.8	30.0	23.2
	HT/VHT40, M8 to M15	2	13	4.3	3.2			6.8	30.0	23.2
	HT/VHT40, M0 to M7	3	13	4.3	3.2	2.8		8.3	30.0	21.7
	HT/VHT40, M8 to M15	3	13	4.3	3.2	2.8		8.3	30.0	21.7
	HT/VHT40, M16 to M23	3	13	4.3	3.2	2.8		8.3	30.0	21.7
	HT/VHT40, M0 to M7	4	13	3.3	2.2	1.6	4.1	8.9	30.0	21.1
	HT/VHT40, M8 to M15	4	13	3.3	2.2	1.6	4.1	8.9	30.0	21.1
	HT/VHT40, M16 to M23	4	13	3.3	2.2	1.6	4.1	8.9	30.0	21.1
	HT/VHT40 Beam Forming, M0 to M7	2	13	4.3	3.2			6.8	30.0	23.2
	HT/VHT40 Beam Forming, M8 to M15	2	13	4.3	3.2			6.8	30.0	23.2
	HT/VHT40 Beam Forming, M0 to M7	3	16	2.4	1.2	0.6		6.2	30.0	23.8
	HT/VHT40 Beam Forming, M8 to M15	3	13	4.3	3.2	2.8		8.3	30.0	21.7
	HT/VHT40 Beam Forming, M16 to M23	3	13	4.3	3.2	2.8		8.3	30.0	21.7
	HT/VHT40 Beam Forming, M0 to M7	4	16	1.5	0.3	-0.3	2.2	7.1	30.0	22.9
	HT/VHT40 Beam Forming, M8 to M15	4	13	3.3	2.2	1.6	4.1	8.9	30.0	21.1
	HT/VHT40 Beam Forming, M16 to M23	4	13	3.3	2.2	1.6	4.1	8.9	30.0	21.1
	HT/VHT40 STBC, M0 to M7	2	13	4.3	3.2			6.8	30.0	23.2
	HT/VHT40 STBC, M0 to M7	3	13	4.3	3.2	2.8		8.3	30.0	21.7
	HT/VHT40 STBC, M0 to M7	4	13	3.3	2.2	1.6	4.1	8.9	30.0	21.1
5775	Non HT80, 6 to 54 Mbps	1	13	6.0				6.0	30.0	24.0
	Non HT80, 6 to 54 Mbps	2	13	6.0	5.7			8.9	30.0	21.1
	Non HT80, 6 to 54 Mbps	3	13	3.1	2.7	3.1		7.7	30.0	22.3
	Non HT80, 6 to 54 Mbps	4	13	3.1	2.7	3.1	4.2	9.3	30.0	20.7
	VHT80, M0 to M9 1ss	1	13	8.4				8.4	30.0	21.6
	VHT80, M0 to M9 1ss	2	13	4.4	4.1			7.3	30.0	22.7
	VHT80, M0 to M9 2ss	2	13	4.4	4.1			7.3	30.0	22.7
	VHT80, M0 to M9 1ss	3	13	3.5	3.1	3.3		8.1	30.0	21.9
	VHT80, M0 to M9 2ss	3	13	3.5	3.1	3.3		8.1	30.0	21.9
	VHT80, M0 to M9 3ss	3	13	3.5	3.1	3.3		8.1	30.0	21.9
	VHT80, M0 to M9 1ss	4	13	3.5	3.1	3.3	4.5	9.7	30.0	20.3
	VHT80, M0 to M9 2ss	4	13	3.5	3.1	3.3	4.5	9.7	30.0	20.3
	VHT80, M0 to M9 3ss	4	13	3.5	3.1	3.3	4.5	9.7	30.0	20.3
	VHT80 Beam Forming, M0 to M9 1ss	2	13	4.4	4.1			7.3	30.0	22.7
	VHT80 Beam Forming, M0 to M9 2ss	2	13	4.4	4.1			7.3	30.0	22.7
	VHT80 Beam Forming, M0 to M9 1ss	3	13	3.5	3.1	3.3		8.1	30.0	21.9
	VHT80 Beam Forming, M0 to M9 2ss	3	13	3.5	3.1	3.3		8.1	30.0	21.9
	VHT80 Beam Forming, M0 to M9 3ss	3	13	3.5	3.1	3.3		8.1	30.0	21.9
	VHT80 Beam Forming, M0 to M9 1ss	4	13	3.5	3.1	3.3	4.5	9.7	30.0	20.3
	VHT80 Beam Forming, M0 to M9 2ss	4	13	3.5	3.1	3.3	4.5	9.7	30.0	20.3
VHT80 Beam Forming, M0 to M9 3ss	4	13	3.5	3.1	3.3	4.5	9.7	30.0	20.3	



	VHT80 STBC, M0 to M9 1ss	2	13	4.4	4.1			7.3	30.0	22.7
	VHT80 STBC, M0 to M9 1ss	3	13	3.5	3.1	3.3		8.1	30.0	21.9
	VHT80 STBC, M0 to M9 1ss	4	13	3.5	3.1	3.3	4.5	9.7	30.0	20.3
5785	Non HT20, 6 to 54 Mbps	1	13	14.0				14.0	30.0	16.0
	Non HT20, 6 to 54 Mbps	2	13	14.0	14.1			17.1	30.0	12.9
	Non HT20, 6 to 54 Mbps	3	13	14.0	14.1	13.7		18.7	30.0	11.3
	Non HT20, 6 to 54 Mbps	4	13	14.0	14.1	13.7	15.8	20.5	30.0	9.5
	Non HT20 Beam Forming, 6 to 54 Mbps	2	13	14.0	14.1			17.1	30.0	12.9
	Non HT20 Beam Forming, 6 to 54 Mbps	3	16	8.9	9.7	10.4		14.5	30.0	15.5
	Non HT20 Beam Forming, 6 to 54 Mbps	4	16	6.9	7.6	8.3	9.1	14.1	30.0	15.9
	HT/VHT20, M0 to M7	1	13	14.2				14.2	30.0	15.8
	HT/VHT20, M0 to M7	2	13	14.2	14.4			17.3	30.0	12.7
	HT/VHT20, M8 to M15	2	13	14.2	14.4			17.3	30.0	12.7
	HT/VHT20, M0 to M7	3	13	14.2	14.4	13.9		18.9	30.0	11.1
	HT/VHT20, M8 to M15	3	13	14.2	14.4	13.9		18.9	30.0	11.1
	HT/VHT20, M16 to M23	3	13	14.2	14.4	13.9		18.9	30.0	11.1
	<b>HT/VHT20, M0 to M7</b>	<b>4</b>	<b>13</b>	<b>14.2</b>	<b>14.4</b>	<b>13.9</b>	<b>16.0</b>	<b>20.7</b>	<b>30.0</b>	<b>9.3</b>
	HT/VHT20, M8 to M15	4	13	14.2	14.4	13.9	16.0	20.7	30.0	9.3
	HT/VHT20, M16 to M23	4	13	14.2	14.4	13.9	16.0	20.7	30.0	9.3
	HT/VHT20 Beam Forming, M0 to M7	2	13	14.2	14.4			17.3	30.0	12.7
	HT/VHT20 Beam Forming, M8 to M15	2	13	14.2	14.4			17.3	30.0	12.7
	HT/VHT20 Beam Forming, M0 to M7	3	16	9.1	9.8	10.5		14.6	30.0	15.4
	HT/VHT20 Beam Forming, M8 to M15	3	13	12.9	13.2	13.9		18.1	30.0	11.9
	HT/VHT20 Beam Forming, M16 to M23	3	13	14.2	14.4	13.9		18.9	30.0	11.1
	HT/VHT20 Beam Forming, M0 to M7	4	16	7.1	7.8	8.5	9.3	14.3	30.0	15.7
	HT/VHT20 Beam Forming, M8 to M15	4	13	10.3	10.9	11.5	12.4	17.4	30.0	12.6
	HT/VHT20 Beam Forming, M16 to M23	4	13	12.9	13.2	13.9	14.7	19.8	30.0	10.2
	HT/VHT20 STBC, M0 to M7	2	13	14.2	14.4			17.3	30.0	12.7
	HT/VHT20 STBC, M0 to M7	3	13	14.2	14.4	13.9		18.9	30.0	11.1
HT/VHT20 STBC, M0 to M7	4	13	14.2	14.4	13.9	16.0	20.7	30.0	9.3	
5795	Non HT40, 6 to 54 Mbps	1	13	13.0				13.0	30.0	17.0
	Non HT40, 6 to 54 Mbps	2	13	13.0	13.4			16.2	30.0	13.8
	Non HT40, 6 to 54 Mbps	3	13	13.0	13.4	13.9		18.2	30.0	11.8
	Non HT40, 6 to 54 Mbps	4	13	13.0	13.4	13.9	15.0	19.9	30.0	10.1
	HT/VHT40, M0 to M7	1	13	14.2				14.2	30.0	15.8
	HT/VHT40, M0 to M7	2	13	14.2	13.4			16.8	30.0	13.2
	HT/VHT40, M8 to M15	2	13	14.2	13.4			16.8	30.0	13.2
	HT/VHT40, M0 to M7	3	13	14.2	13.4	13.9		18.6	30.0	11.4
	HT/VHT40, M8 to M15	3	13	14.2	13.4	13.9		18.6	30.0	11.4



	HT/VHT40, M16 to M23	3	13	14.2	13.4	13.9		18.6	30.0	11.4
	HT/VHT40, M0 to M7	4	13	14.2	13.4	13.9	16.1	20.5	30.0	9.5
	HT/VHT40, M8 to M15	4	13	14.2	13.4	13.9	16.1	20.5	30.0	9.5
	HT/VHT40, M16 to M23	4	13	14.2	13.4	13.9	16.1	20.5	30.0	9.5
	HT/VHT40 Beam Forming, M0 to M7	2	13	14.2	13.4			16.8	30.0	13.2
	HT/VHT40 Beam Forming, M8 to M15	2	13	14.2	13.4			16.8	30.0	13.2
	HT/VHT40 Beam Forming, M0 to M7	3	16	9.6	10.2	10.7		15.0	30.0	15.0
	HT/VHT40 Beam Forming, M8 to M15	3	13	11.9	12.3	12.9		17.2	30.0	12.8
	HT/VHT40 Beam Forming, M16 to M23	3	13	14.2	13.4	13.9		18.6	30.0	11.4
	HT/VHT40 Beam Forming, M0 to M7	4	16	7.6	8.3	8.7	9.6	14.6	30.0	15.4
	HT/VHT40 Beam Forming, M8 to M15	4	13	10.8	11.2	11.8	12.5	17.6	30.0	12.4
	HT/VHT40 Beam Forming, M16 to M23	4	13	11.9	12.3	12.9	13.7	18.8	30.0	11.2
	HT/VHT40 STBC, M0 to M7	2	13	14.2	13.4			16.8	30.0	13.2
	HT/VHT40 STBC, M0 to M7	3	13	14.2	13.4	13.9		18.6	30.0	11.4
	HT/VHT40 STBC, M0 to M7	4	13	14.2	13.4	13.9	16.1	20.5	30.0	9.5
5825	Non HT20, 6 to 54 Mbps	1	13	14.8				14.8	30.0	15.2
	Non HT20, 6 to 54 Mbps	2	13	13.6	12.7			16.2	30.0	13.8
	Non HT20, 6 to 54 Mbps	3	13	11.0	10.5	11.0		15.6	30.0	14.4
	Non HT20, 6 to 54 Mbps	4	13	9.7	9.4	10.0	11.2	16.2	30.0	13.8
	Non HT20 Beam Forming, 6 to 54 Mbps	2	13	13.6	12.7			16.2	30.0	13.8
	Non HT20 Beam Forming, 6 to 54 Mbps	3	16	7.7	7.3	7.9		12.4	30.0	17.6
	Non HT20 Beam Forming, 6 to 54 Mbps	4	16	6.8	6.4	7.0	8.2	13.2	30.0	16.8
	HT/VHT20, M0 to M7	1	13	15.0				15.0	30.0	15.0
	HT/VHT20, M0 to M7	2	13	12.5	11.9			15.2	30.0	14.8
	HT/VHT20, M8 to M15	2	13	12.5	11.9			15.2	30.0	14.8
	HT/VHT20, M0 to M7	3	13	11.2	10.7	11.3		15.8	30.0	14.2
	HT/VHT20, M8 to M15	3	13	11.2	10.7	11.3		15.8	30.0	14.2
	HT/VHT20, M16 to M23	3	13	11.2	10.7	11.3		15.8	30.0	14.2
	HT/VHT20, M0 to M7	4	13	10.0	9.6	10.3	11.4	16.4	30.0	13.6
	HT/VHT20, M8 to M15	4	13	10.0	9.6	10.3	11.4	16.4	30.0	13.6
	HT/VHT20, M16 to M23	4	13	10.0	9.6	10.3	11.4	16.4	30.0	13.6
	HT/VHT20 Beam Forming, M0 to M7	2	13	12.5	11.9			15.2	30.0	14.8
	HT/VHT20 Beam Forming, M8 to M15	2	13	12.5	11.9			15.2	30.0	14.8
	HT/VHT20 Beam Forming, M0 to M7	3	16	8.0	7.6	8.2		12.7	30.0	17.3
	HT/VHT20 Beam Forming, M8 to M15	3	13	11.2	10.7	11.3		15.8	30.0	14.2
HT/VHT20 Beam Forming, M16 to M23	3	13	11.2	10.7	11.3		15.8	30.0	14.2	
HT/VHT20 Beam Forming, M0 to M7	4	16	6.1	5.8	6.2	7.5	12.5	30.0	17.5	
HT/VHT20 Beam Forming, M8 to M15	4	13	10.0	9.6	10.3	11.4	16.4	30.0	13.6	
HT/VHT20 Beam Forming, M16 to M23	4	13	10.0	9.6	10.3	11.4	16.4	30.0	13.6	
HT/VHT20 STBC, M0 to M7	2	13	12.5	11.9			15.2	30.0	14.8	



HT/VHT20 STBC, M0 to M7	3	13	11.2	10.7	11.3		15.8	30.0	14.2
HT/VHT20 STBC, M0 to M7	4	13	10.0	9.6	10.3	11.4	16.4	30.0	13.6

**Peak Output Power, 5785 MHz, HT/VHT20, M0 to M7**

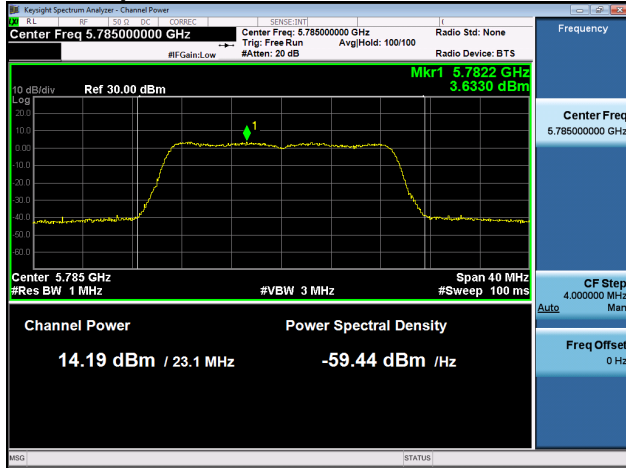

**Antenna A**

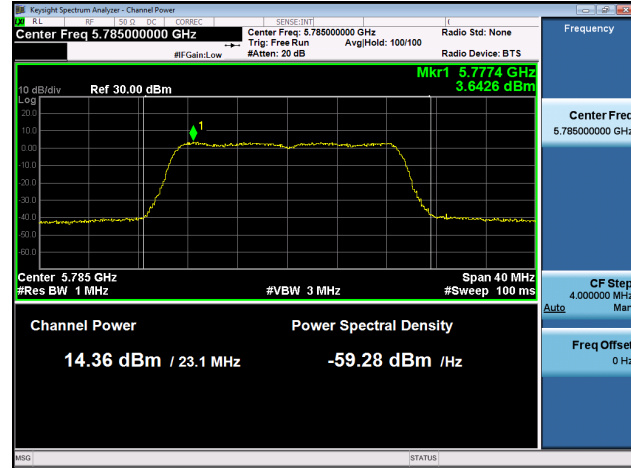

**Antenna B**

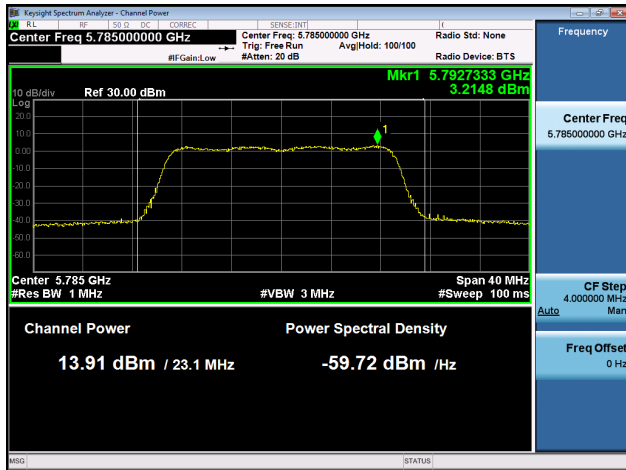

**Antenna C**

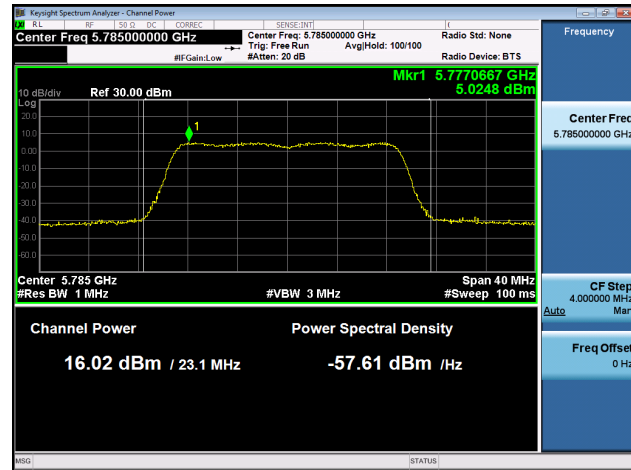

**Antenna D**



## A.4 Power Spectral Density

### 15.407

The power spectral density shall not exceed 30 dBm in any 500 kHz band. If transmitting antennas of directional gain greater than 6 dBi are used, both the maximum conducted output power and the power spectral density shall be reduced by the amount in dB that the directional gain of the antenna exceeds 6 dBi.

#### Test Procedure

Ref. KDB 789033 D02 General UNII Test Procedures New Rules v01

<b>Power Spectral Density</b>
Test Procedure
<ol style="list-style-type: none"> <li>1. Connect the antenna port(s) to the spectrum analyzer input.</li> <li>2. Set the radio in the continuous transmitting mode at full power</li> <li>3. Configure Spectrum analyzer as per test parameters below and Peak search marker</li> <li>4. Capture graphs and record pertinent measurement data.</li> </ol>

Ref. KDB 789033 D02 v01 section F.5

<b>Power Spectral Density</b>
Test parameters
Span = >1.5 times the OBW RBW = 500 kHz. VBW $\geq$ 3 x RBW Sweep = 10s Detector = Peak Trace = Single Sweep Marker = Peak Search

The "Measure and add 10 log(N) dB technique", where N is the number of outputs, is used for measuring in-band Power Spectral Density. With this technique, spectrum measurements are performed at each output of the device, and the quantity 10 log(4) (or 6dB) is added to the worst case spectrum value before comparing to the emission limit. (ANSI C63.10 2013 section 14.3.2.3)

System Number	Description	Samples	System under test	Support equipment
1	EUT	S01	<input checked="" type="checkbox"/>	<input type="checkbox"/>
	Support	S02	<input type="checkbox"/>	<input checked="" type="checkbox"/>

<b>Tested By :</b> Jose Aguirre	<b>Date of testing:</b> 01-Jan-16 - 29-Feb-16
<b>Test Result : PASS</b>	

See Appendix C for list of test equipment



## Antenna Gain : 2 dBi

Frequency (MHz)	Mode	Tx Paths	Correlated Antenna Gain (dBi)	Tx 1 PSD (dBm/MHz)	Tx 2 PSD (dBm/MHz)	Tx 3 PSD (dBm/MHz)	Tx 4 PSD (dBm/MHz)	Total PSD (dBm/500MHz)	Limit (dBm/500MHz)	Margin (dB)
5745	Non HT20, 6 to 54 Mbps	1	2	3.8				3.8	30.0	26.2
	Non HT20, 6 to 54 Mbps	2	5	2.7	1.6			5.2	30.0	24.8
	Non HT20, 6 to 54 Mbps	3	7	2.0	1.2	-0.2		5.9	29.0	23.1
	Non HT20, 6 to 54 Mbps	4	8	2.0	1.2	-0.2	1.8	7.3	28.0	20.7
	Non HT20 Beam Forming, 6 to 54 Mbps	2	5	0.4	-0.6			2.9	30.0	27.1
	Non HT20 Beam Forming, 6 to 54 Mbps	3	7	-2.1	-2.5	-3.2		2.2	29.0	26.8
	Non HT20 Beam Forming, 6 to 54 Mbps	4	8	-2.8	-3.9	-4.7	-2.3	2.7	28.0	25.3
	HT/VHT20, M0 to M7	1	2	4.1				4.1	30.0	25.9
	HT/VHT20, M0 to M7	2	5	3.0	1.7			5.4	30.0	24.6
	HT/VHT20, M8 to M15	2	2	3.0	1.7			5.4	30.0	24.6
	HT/VHT20, M0 to M7	3	7	3.0	1.7	0.8		6.7	29.0	22.3
	HT/VHT20, M8 to M15	3	4	3.0	1.7	0.8		6.7	30.0	23.3
	HT/VHT20, M16 to M23	3	2	3.0	1.7	0.8		6.7	30.0	23.3
	<b>HT/VHT20, M0 to M7</b>	<b>4</b>	<b>8</b>	<b>3.0</b>	<b>1.7</b>	<b>0.8</b>	<b>3.6</b>	<b>8.4</b>	<b>28.0</b>	<b>19.6</b>
	HT/VHT20, M8 to M15	4	5	3.0	1.7	0.8	3.6	8.4	30.0	21.6
	HT/VHT20, M16 to M23	4	3	3.0	1.7	0.8	3.6	8.4	30.0	21.6
	HT/VHT20 Beam Forming, M0 to M7	2	5	0.1	-0.4			2.9	30.0	27.1
	HT/VHT20 Beam Forming, M8 to M15	2	2	3.0	1.7			5.4	30.0	24.6
	HT/VHT20 Beam Forming, M0 to M7	3	7	0.1	-0.4	-1.0		4.4	29.0	24.6
	HT/VHT20 Beam Forming, M8 to M15	3	4	1.5	0.9	-0.2		5.6	30.0	24.4
	HT/VHT20 Beam Forming, M16 to M23	3	2	3.0	1.7	0.8		6.7	30.0	23.3
	HT/VHT20 Beam Forming, M0 to M7	4	8	-3.0	-3.8	-4.3	-2.2	2.8	28.0	25.2
	HT/VHT20 Beam Forming, M8 to M15	4	5	0.1	-0.4	-1.0	0.8	5.9	30.0	24.1
	HT/VHT20 Beam Forming, M16 to M23	4	3	3.0	1.7	0.8	3.6	8.4	30.0	21.6
	HT/VHT20 STBC, M0 to M7	2	2	3.0	1.7			5.4	30.0	24.6
	HT/VHT20 STBC, M0 to M7	3	4	3.0	1.7	0.8		6.7	30.0	23.3
	HT/VHT20 STBC, M0 to M7	4	5	3.0	1.7	0.8	3.6	8.4	30.0	21.6
	5755	Non HT40, 6 to 54 Mbps	1	2	-2.9				-2.9	30.0
Non HT40, 6 to 54 Mbps		2	5	-2.9	-4.5			-0.6	30.0	30.6
Non HT40, 6 to 54 Mbps		3	7	-5.8	-6.9	-7.9		-2.0	29.0	31.0
Non HT40, 6 to 54 Mbps		4	8	-10.5	-12.2	-13.0	-10.2	-5.3	28.0	33.3
HT/VHT40, M0 to M7		1	2	0.2				0.2	30.0	29.8



	HT/VHT40, M0 to M7	2	5	-1.1	-2.5			1.3	30.0	28.7
	HT/VHT40, M8 to M15	2	2	-1.1	-2.5			1.3	30.0	28.7
	HT/VHT40, M0 to M7	3	7	-1.1	-2.5	-3.7		2.5	29.0	26.5
	HT/VHT40, M8 to M15	3	4	-1.1	-2.5	-3.7		2.5	30.0	27.5
	HT/VHT40, M16 to M23	3	2	-1.1	-2.5	-3.7		2.5	30.0	27.5
	HT/VHT40, M0 to M7	4	8	-1.1	-2.5	-3.7	-1.1	4.1	28.0	23.9
	HT/VHT40, M8 to M15	4	5	-1.1	-2.5	-3.7	-1.1	4.1	30.0	25.9
	HT/VHT40, M16 to M23	4	3	-1.1	-2.5	-3.7	-1.1	4.1	30.0	25.9
	HT/VHT40 Beam Forming, M0 to M7	2	5	-4.6	-5.4			-2.0	30.0	32.0
	HT/VHT40 Beam Forming, M8 to M15	2	2	-1.1	-2.5			1.3	30.0	28.7
	HT/VHT40 Beam Forming, M0 to M7	3	7	-5.7	-6.5	-7.9		-1.8	29.0	30.8
	HT/VHT40 Beam Forming, M8 to M15	3	4	-4.6	-5.4	-6.9		-0.8	30.0	30.8
	HT/VHT40 Beam Forming, M16 to M23	3	2	-1.1	-2.5	-3.7		2.5	30.0	27.5
	HT/VHT40 Beam Forming, M0 to M7	4	8	-9.5	-11.1	-11.3	-8.6	-4.0	28.0	32.0
	HT/VHT40 Beam Forming, M8 to M15	4	5	-4.6	-5.4	-6.9	-4.4	0.8	30.0	29.2
	HT/VHT40 Beam Forming, M16 to M23	4	3	-4.6	-5.4	-6.9	-4.4	0.8	30.0	29.2
	HT/VHT40 STBC, M0 to M7	2	2	-1.1	-2.5			1.3	30.0	28.7
	HT/VHT40 STBC, M0 to M7	3	4	-1.1	-2.5	-3.7		2.5	30.0	27.5
	HT/VHT40 STBC, M0 to M7	4	5	-1.1	-2.5	-3.7	-1.1	4.1	30.0	25.9
5775	Non HT80, 6 to 54 Mbps	1	2	-5.6				-5.6	30.0	35.6
	Non HT80, 6 to 54 Mbps	2	5	-5.6	-7.2			-3.3	30.0	33.3
	Non HT80, 6 to 54 Mbps	3	7	-7.3	-8.4	-9.0		-3.4	29.0	32.4
	Non HT80, 6 to 54 Mbps	4	8	-8.4	-9.7	-9.9	-7.5	-2.7	28.0	30.7
	VHT80, M0 to M9 1ss	1	2	-3.8				-3.8	30.0	33.8
	VHT80, M0 to M9 1ss	2	5	-4.7	-5.7			-2.2	30.0	32.2
	VHT80, M0 to M9 2ss	2	2	-4.7	-5.7			-2.2	30.0	32.2
	VHT80, M0 to M9 1ss	3	7	-5.9	-7.0	-7.5		-2.0	29.0	31.0
	VHT80, M0 to M9 2ss	3	4	-5.9	-7.0	-7.5		-2.0	30.0	32.0
	VHT80, M0 to M9 3ss	3	2	-5.9	-7.0	-7.5		-2.0	30.0	32.0
	VHT80, M0 to M9 1ss	4	8	-5.9	-7.0	-7.5	-5.2	-0.3	28.0	28.3
	VHT80, M0 to M9 2ss	4	5	-5.9	-7.0	-7.5	-5.2	-0.3	30.0	30.3
	VHT80, M0 to M9 3ss	4	3	-5.9	-7.0	-7.5	-5.2	-0.3	30.0	30.3
	VHT80 Beam Forming, M0 to M9 1ss	2	5	-5.9	-7.0			-3.4	30.0	33.4
	VHT80 Beam Forming, M0 to M9 2ss	2	2	-4.7	-5.7			-2.2	30.0	32.2
	VHT80 Beam Forming, M0 to M9 1ss	3	7	-8.4	-8.9	-10.0		-4.3	29.0	33.3
	VHT80 Beam Forming, M0 to M9 2ss	3	4	-5.9	-7.0	-7.5		-2.0	30.0	32.0
	VHT80 Beam Forming, M0 to M9 3ss	3	2	-5.9	-7.0	-7.5		-2.0	30.0	32.0
	VHT80 Beam Forming, M0 to M9 1ss	4	8	-8.4	-8.9	-10.0	-7.8	-2.7	28.0	30.7
	VHT80 Beam Forming, M0 to M9 2ss	4	5	-8.4	-8.9	-10.0	-7.8	-2.7	30.0	32.7
VHT80 Beam Forming, M0 to M9 3ss	4	3	-5.9	-7.0	-7.5	-5.2	-0.3	30.0	30.3	



	VHT80 STBC, M0 to M9 1ss	2	2	-4.7	-5.7			-2.2	30.0	32.2
	VHT80 STBC, M0 to M9 1ss	3	2	-5.9	-7.0	-7.5		-2.0	30.0	32.0
	VHT80 STBC, M0 to M9 1ss	4	2	-5.9	-7.0	-7.5	-5.2	-0.3	30.0	30.3
5785	Non HT20, 6 to 54 Mbps	1	2	0.7				0.7	30.0	29.3
	Non HT20, 6 to 54 Mbps	2	5	0.7	0.5			3.6	30.0	26.4
	Non HT20, 6 to 54 Mbps	3	7	0.7	0.5	0.7		5.4	29.0	23.6
	Non HT20, 6 to 54 Mbps	4	8	0.7	0.5	0.7	2.3	7.1	28.0	20.9
	Non HT20 Beam Forming, 6 to 54 Mbps	2	5	0.7	0.5			3.6	30.0	26.4
	Non HT20 Beam Forming, 6 to 54 Mbps	3	7	0.7	0.5	0.7		5.4	29.0	23.6
	Non HT20 Beam Forming, 6 to 54 Mbps	4	8	0.7	0.5	0.7	2.3	7.1	28.0	20.9
	HT/VHT20, M0 to M7	1	2	0.9				0.9	30.0	29.1
	HT/VHT20, M0 to M7	2	5	0.9	0.7			3.8	30.0	26.2
	HT/VHT20, M8 to M15	2	2	0.9	0.7			3.8	30.0	26.2
	HT/VHT20, M0 to M7	3	7	0.9	0.7	0.3		5.4	29.0	23.6
	HT/VHT20, M8 to M15	3	4	0.9	0.7	0.3		5.4	30.0	24.6
	HT/VHT20, M16 to M23	3	2	0.9	0.7	0.3		5.4	30.0	24.6
	HT/VHT20, M0 to M7	4	8	0.9	0.7	0.3	2.4	7.2	28.0	20.8
	HT/VHT20, M8 to M15	4	5	0.9	0.7	0.3	2.4	7.2	30.0	22.8
	HT/VHT20, M16 to M23	4	3	0.9	0.7	0.3	2.4	7.2	30.0	22.8
	HT/VHT20 Beam Forming, M0 to M7	2	5	0.9	0.7			3.8	30.0	26.2
	HT/VHT20 Beam Forming, M8 to M15	2	2	0.9	0.7			3.8	30.0	26.2
	HT/VHT20 Beam Forming, M0 to M7	3	7	0.9	0.7	0.3		5.4	29.0	23.6
	HT/VHT20 Beam Forming, M8 to M15	3	4	0.9	0.7	0.3		5.4	30.0	24.6
	HT/VHT20 Beam Forming, M16 to M23	3	2	0.9	0.7	0.3		5.4	30.0	24.6
	HT/VHT20 Beam Forming, M0 to M7	4	8	0.9	0.7	0.3	2.4	7.2	28.0	20.8
	HT/VHT20 Beam Forming, M8 to M15	4	5	0.9	0.7	0.3	2.4	7.2	30.0	22.8
	HT/VHT20 Beam Forming, M16 to M23	4	3	0.9	0.7	0.3	2.4	7.2	30.0	22.8
	HT/VHT20 STBC, M0 to M7	2	2	0.9	0.7			3.8	30.0	26.2
	HT/VHT20 STBC, M0 to M7	3	4	0.9	0.7	0.3		5.4	30.0	24.6
	HT/VHT20 STBC, M0 to M7	4	5	0.9	0.7	0.3	2.4	7.2	30.0	22.8
5795	Non HT40, 6 to 54 Mbps	1	2	-2.3				-2.3	30.0	32.3
	Non HT40, 6 to 54 Mbps	2	5	-2.3	-1.9			0.9	30.0	29.1
	Non HT40, 6 to 54 Mbps	3	7	-2.3	-1.9	-1.5		2.9	29.0	26.1
	Non HT40, 6 to 54 Mbps	4	8	-2.3	-1.9	-1.5	-0.3	4.6	28.0	23.4
	HT/VHT40, M0 to M7	1	2	-2.5				-2.5	30.0	32.5
	HT/VHT40, M0 to M7	2	5	-2.5	-3.2			0.2	30.0	29.8
	HT/VHT40, M8 to M15	2	2	-2.5	-3.2			0.2	30.0	29.8
	HT/VHT40, M0 to M7	3	7	-2.5	-3.2	-2.7		2.0	29.0	27.0
	HT/VHT40, M8 to M15	3	4	-2.5	-3.2	-2.7		2.0	30.0	28.0





	HT/VHT40, M16 to M23	3	2	-2.5	-3.2	-2.7		2.0	30.0	28.0
	HT/VHT40, M0 to M7	4	8	-2.5	-3.2	-2.7	-0.6	3.9	28.0	24.1
	HT/VHT40, M8 to M15	4	5	-2.5	-3.2	-2.7	-0.6	3.9	30.0	26.1
	HT/VHT40, M16 to M23	4	3	-2.5	-3.2	-2.7	-0.6	3.9	30.0	26.1
	HT/VHT40 Beam Forming, M0 to M7	2	5	-2.5	-3.2			0.2	30.0	29.8
	HT/VHT40 Beam Forming, M8 to M15	2	2	-2.5	-3.2			0.2	30.0	29.8
	HT/VHT40 Beam Forming, M0 to M7	3	7	-2.5	-3.2	-2.7		2.0	29.0	27.0
	HT/VHT40 Beam Forming, M8 to M15	3	4	-2.5	-3.2	-2.7		2.0	30.0	28.0
	HT/VHT40 Beam Forming, M16 to M23	3	2	-2.5	-3.2	-2.7		2.0	30.0	28.0
	HT/VHT40 Beam Forming, M0 to M7	4	8	-2.5	-3.2	-2.7	-0.6	3.9	28.0	24.1
	HT/VHT40 Beam Forming, M8 to M15	4	5	-2.5	-3.2	-2.7	-0.6	3.9	30.0	26.1
	HT/VHT40 Beam Forming, M16 to M23	4	3	-2.5	-3.2	-2.7	-0.6	3.9	30.0	26.1
	HT/VHT40 STBC, M0 to M7	2	2	-2.5	-3.2			0.2	30.0	29.8
	HT/VHT40 STBC, M0 to M7	3	4	-2.5	-3.2	-2.7		2.0	30.0	28.0
	HT/VHT40 STBC, M0 to M7	4	5	-2.5	-3.2	-2.7	-0.6	3.9	30.0	26.1
	Non HT20, 6 to 54 Mbps	1	2	1.6				1.6	30.0	28.4
	Non HT20, 6 to 54 Mbps	2	5	1.6	0.6			4.1	30.0	25.9
	Non HT20, 6 to 54 Mbps	3	7	1.6	0.6	0.0		5.6	29.0	23.4
	Non HT20, 6 to 54 Mbps	4	8	1.6	0.6	0.0	2.3	7.2	28.0	20.8
	Non HT20 Beam Forming, 6 to 54 Mbps	2	5	1.6	0.6			4.1	30.0	25.9
	Non HT20 Beam Forming, 6 to 54 Mbps	3	7	1.6	0.6	0.0		5.6	29.0	23.4
	Non HT20 Beam Forming, 6 to 54 Mbps	4	8	1.6	0.6	0.0	2.3	7.2	28.0	20.8
	HT/VHT20, M0 to M7	1	2	1.5				1.5	30.0	28.5
	HT/VHT20, M0 to M7	2	5	1.5	0.8			4.2	30.0	25.8
	HT/VHT20, M8 to M15	2	2	1.5	0.8			4.2	30.0	25.8
	HT/VHT20, M0 to M7	3	7	1.5	0.8	0.0		5.6	29.0	23.4
	HT/VHT20, M8 to M15	3	4	1.5	0.8	0.0		5.6	30.0	24.4
	HT/VHT20, M16 to M23	3	2	1.5	0.8	0.0		5.6	30.0	24.4
	HT/VHT20, M0 to M7	4	8	1.5	0.8	0.0	2.4	7.3	28.0	20.7
	HT/VHT20, M8 to M15	4	5	1.5	0.8	0.0	2.4	7.3	30.0	22.7
	HT/VHT20, M16 to M23	4	3	1.5	0.8	0.0	2.4	7.3	30.0	22.7
	HT/VHT20 Beam Forming, M0 to M7	2	5	1.5	0.8			4.2	30.0	25.8
	HT/VHT20 Beam Forming, M8 to M15	2	2	1.5	0.8			4.2	30.0	25.8
	HT/VHT20 Beam Forming, M0 to M7	3	7	1.5	0.8	0.0		5.6	29.0	23.4
	HT/VHT20 Beam Forming, M8 to M15	3	4	1.5	0.8	0.0		5.6	30.0	24.4
	HT/VHT20 Beam Forming, M16 to M23	3	2	1.5	0.8	0.0		5.6	30.0	24.4
	HT/VHT20 Beam Forming, M0 to M7	4	8	1.5	0.8	0.0	2.4	7.3	28.0	20.7
	HT/VHT20 Beam Forming, M8 to M15	4	5	1.5	0.8	0.0	2.4	7.3	30.0	22.7
	HT/VHT20 Beam Forming, M16 to M23	4	3	1.5	0.8	0.0	2.4	7.3	30.0	22.7
	HT/VHT20 STBC, M0 to M7	2	2	1.5	0.8			4.2	30.0	25.8



HT/VHT20 STBC, M0 to M7	3	4	1.5	0.8	0.0		5.6	30.0	24.4
HT/VHT20 STBC, M0 to M7	4	5	1.5	0.8	0.0	2.4	7.3	30.0	22.7



**Power Spectral Density, 5745 MHz, HT/VHT20, M0 to M7**

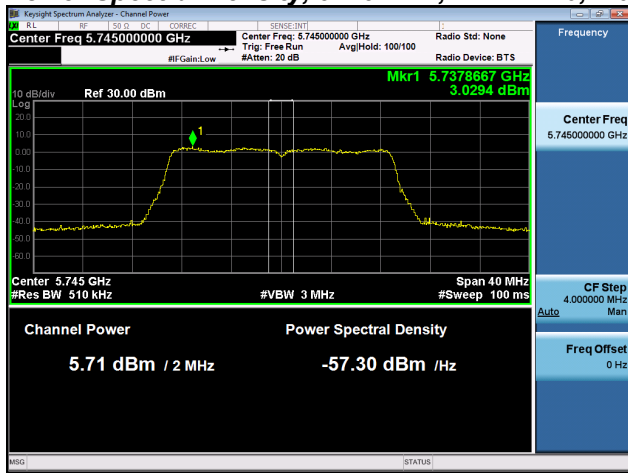

**Antenna A**

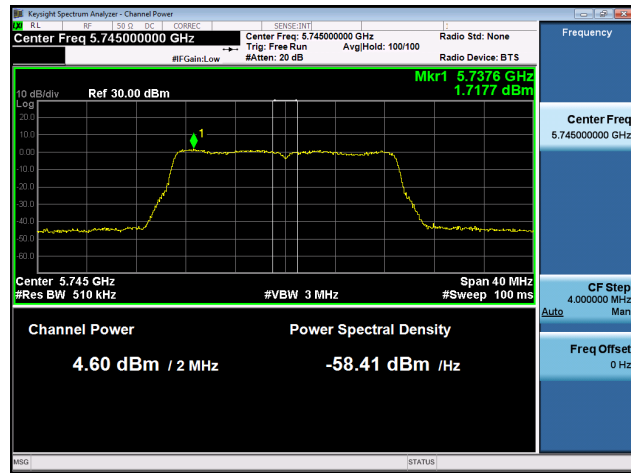

**Antenna B**

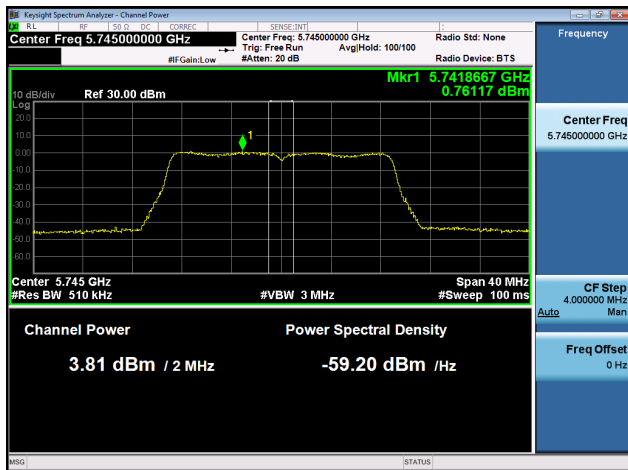

**Antenna C**

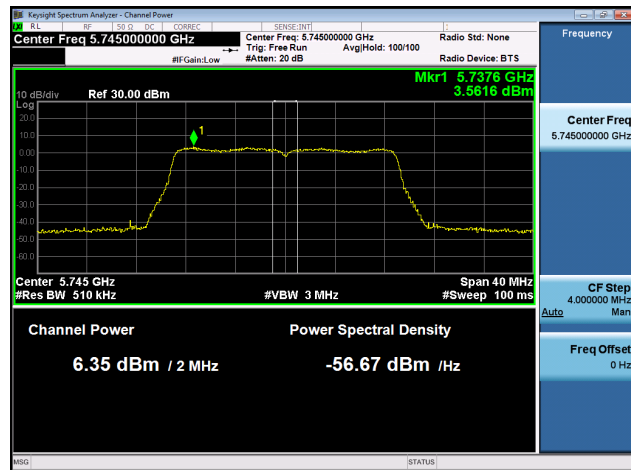

**Antenna D**



## Antenna Gain : 3 dBi

Frequency (MHz)	Mode	Tx Paths	Correlated Antenna Gain (dBi)	Tx 1 PSD (dBm/MHz)	Tx 2 PSD (dBm/MHz)	Tx 3 PSD (dBm/MHz)	Tx 4 PSD (dBm/MHz)	Total PSD (dBm/500MHz)	Limit (dBm/500MHz)	Margin (dB)
5745	Non HT20, 6 to 54 Mbps	1	3	3.8				3.8	30.0	26.2
	Non HT20, 6 to 54 Mbps	2	6	2.7	1.6			5.2	30.0	24.8
	Non HT20, 6 to 54 Mbps	3	8	2.0	1.2	-0.2		5.9	28.0	22.1
	Non HT20, 6 to 54 Mbps	4	9	2.0	1.2	-0.2	1.8	7.3	27.0	19.7
	Non HT20 Beam Forming, 6 to 54 Mbps	2	6	-1.0	-1.6			1.7	30.0	28.3
	Non HT20 Beam Forming, 6 to 54 Mbps	3	8	-2.8	-3.9	-4.7		1.0	28.0	27.0
	Non HT20 Beam Forming, 6 to 54 Mbps	4	9	-4.6	-5.7	-6.4	-3.8	1.0	27.0	26.0
	HT/VHT20, M0 to M7	1	3	4.1				4.1	30.0	25.9
	HT/VHT20, M0 to M7	2	6	3.0	1.7			5.4	30.0	24.6
	HT/VHT20, M8 to M15	2	3	3.0	1.7			5.4	30.0	24.6
	HT/VHT20, M0 to M7	3	8	3.0	1.7	0.8		6.7	28.0	21.3
	HT/VHT20, M8 to M15	3	5	3.0	1.7	0.8		6.7	30.0	23.3
	HT/VHT20, M16 to M23	3	3	3.0	1.7	0.8		6.7	30.0	23.3
	<b>HT/VHT20, M0 to M7</b>	<b>4</b>	<b>9</b>	<b>3.0</b>	<b>1.7</b>	<b>0.8</b>	<b>3.6</b>	<b>8.4</b>	<b>27.0</b>	<b>18.6</b>
	HT/VHT20, M8 to M15	4	6	3.0	1.7	0.8	3.6	8.4	30.0	21.6
	HT/VHT20, M16 to M23	4	4	3.0	1.7	0.8	3.6	8.4	30.0	21.6
	HT/VHT20 Beam Forming, M0 to M7	2	6	0.1	-0.4			2.9	30.0	27.1
	HT/VHT20 Beam Forming, M8 to M15	2	3	3.0	1.7			5.4	30.0	24.6
	HT/VHT20 Beam Forming, M0 to M7	3	8	-3.0	-3.8	-4.3		1.1	28.0	26.9
	HT/VHT20 Beam Forming, M8 to M15	3	5	0.1	-0.4	-1.0		4.4	30.0	25.6
	HT/VHT20 Beam Forming, M16 to M23	3	3	3.0	1.7	0.8		6.7	30.0	23.3
	HT/VHT20 Beam Forming, M0 to M7	4	9	-4.6	-5.4	-6.6	-4.4	0.9	27.0	26.1
	HT/VHT20 Beam Forming, M8 to M15	4	6	0.1	-0.4	-1.0	0.8	5.9	30.0	24.1
	HT/VHT20 Beam Forming, M16 to M23	4	4	0.1	-0.4	-1.0	0.8	5.9	30.0	24.1
	HT/VHT20 STBC, M0 to M7	2	3	3.0	1.7			5.4	30.0	24.6
	HT/VHT20 STBC, M0 to M7	3	5	3.0	1.7	0.8		6.7	30.0	23.3
	HT/VHT20 STBC, M0 to M7	4	6	3.0	1.7	0.8	3.6	8.4	30.0	21.6
	5755	Non HT40, 6 to 54 Mbps	1	3	-2.9				-2.9	30.0
Non HT40, 6 to 54 Mbps		2	6	-2.9	-4.5			-0.6	30.0	30.6
Non HT40, 6 to 54 Mbps		3	8	-9.1	-10.1	-11.2		-5.3	28.0	33.3
Non HT40, 6 to 54 Mbps		4	9	-10.5	-12.2	-13.0	-10.2	-5.3	27.0	32.3
HT/VHT40, M0 to M7		1	3	0.2				0.2	30.0	29.8



	HT/VHT40, M0 to M7	2	6	-4.6	-5.4			-2.0	30.0	32.0
	HT/VHT40, M8 to M15	2	3	-4.6	-5.4			-2.0	30.0	32.0
	HT/VHT40, M0 to M7	3	8	-4.6	-5.4	-6.9		-0.8	28.0	28.8
	HT/VHT40, M8 to M15	3	5	-4.6	-5.4	-6.9		-0.8	30.0	30.8
	HT/VHT40, M16 to M23	3	3	-4.6	-5.4	-6.9		-0.8	30.0	30.8
	HT/VHT40, M0 to M7	4	9	-4.6	-5.4	-6.9	-4.4	0.8	27.0	26.2
	HT/VHT40, M8 to M15	4	6	-4.6	-5.4	-6.9	-4.4	0.8	30.0	29.2
	HT/VHT40, M16 to M23	4	4	-4.6	-5.4	-6.9	-4.4	0.8	30.0	29.2
	HT/VHT40 Beam Forming, M0 to M7	2	6	-5.7	-6.5			-3.1	30.0	33.1
	HT/VHT40 Beam Forming, M8 to M15	2	3	-4.6	-5.4			-2.0	30.0	32.0
	HT/VHT40 Beam Forming, M0 to M7	3	8	-5.7	-6.5	-7.9		-1.8	28.0	29.8
	HT/VHT40 Beam Forming, M8 to M15	3	5	-4.6	-5.4	-6.9		-0.8	30.0	30.8
	HT/VHT40 Beam Forming, M16 to M23	3	3	-4.6	-5.4	-6.9		-0.8	30.0	30.8
	HT/VHT40 Beam Forming, M0 to M7	4	9	-9.5	-11.1	-11.3	-8.6	-4.0	27.0	31.0
	HT/VHT40 Beam Forming, M8 to M15	4	6	-5.7	-6.5	-7.9	-4.8	-0.1	30.0	30.1
	HT/VHT40 Beam Forming, M16 to M23	4	4	-4.6	-5.4	-6.9	-4.4	0.8	30.0	29.2
	HT/VHT40 STBC, M0 to M7	2	3	-4.6	-5.4			-2.0	30.0	32.0
	HT/VHT40 STBC, M0 to M7	3	5	-4.6	-5.4	-6.9		-0.8	30.0	30.8
	HT/VHT40 STBC, M0 to M7	4	6	-4.6	-5.4	-6.9	-4.4	0.8	30.0	29.2
5775	Non HT80, 6 to 54 Mbps	1	3	-5.6				-5.6	30.0	35.6
	Non HT80, 6 to 54 Mbps	2	6	-5.6	-7.2			-3.3	30.0	33.3
	Non HT80, 6 to 54 Mbps	3	8	-7.3	-8.4	-9.0		-3.4	28.0	31.4
	Non HT80, 6 to 54 Mbps	4	9	-8.4	-9.7	-9.9	-7.5	-2.7	27.0	29.7
	VHT80, M0 to M9 1ss	1	3	-4.7				-4.7	30.0	34.7
	VHT80, M0 to M9 1ss	2	6	-4.7	-5.7			-2.2	30.0	32.2
	VHT80, M0 to M9 2ss	2	3	-4.7	-5.7			-2.2	30.0	32.2
	VHT80, M0 to M9 1ss	3	8	-5.9	-7.0	-7.5		-2.0	28.0	30.0
	VHT80, M0 to M9 2ss	3	5	-5.9	-7.0	-7.5		-2.0	30.0	32.0
	VHT80, M0 to M9 3ss	3	3	-5.9	-7.0	-7.5		-2.0	30.0	32.0
	VHT80, M0 to M9 1ss	4	9	-5.9	-7.0	-7.5	-5.2	-0.3	27.0	27.3
	VHT80, M0 to M9 2ss	4	6	-5.9	-7.0	-7.5	-5.2	-0.3	30.0	30.3
	VHT80, M0 to M9 3ss	4	4	-5.9	-7.0	-7.5	-5.2	-0.3	30.0	30.3
	VHT80 Beam Forming, M0 to M9 1ss	2	6	-7.0	-8.4			-4.6	30.0	34.6
	VHT80 Beam Forming, M0 to M9 2ss	2	3	-4.7	-5.7			-2.2	30.0	32.2
	VHT80 Beam Forming, M0 to M9 1ss	3	8	-8.4	-8.9	-10.0		-4.3	28.0	32.3
	VHT80 Beam Forming, M0 to M9 2ss	3	5	-5.9	-7.0	-7.5		-2.0	30.0	32.0
	VHT80 Beam Forming, M0 to M9 3ss	3	3	-5.9	-7.0	-7.5		-2.0	30.0	32.0
	VHT80 Beam Forming, M0 to M9 1ss	4	9	-10.0	-11.3	-11.9	-9.7	-4.6	27.0	31.6
	VHT80 Beam Forming, M0 to M9 2ss	4	6	-8.4	-8.9	-10.0	-7.8	-2.7	30.0	32.7
VHT80 Beam Forming, M0 to M9 3ss	4	4	-7.0	-8.4	-8.7	-6.4	-1.5	30.0	31.5	



	VHT80 STBC, M0 to M9 1ss	2	3	-4.7	-5.7			-2.2	30.0	32.2
	VHT80 STBC, M0 to M9 1ss	3	3	-5.9	-7.0	-7.5		-2.0	30.0	32.0
	VHT80 STBC, M0 to M9 1ss	4	3	-5.9	-7.0	-7.5	-5.2	-0.3	30.0	30.3
5785	Non HT20, 6 to 54 Mbps	1	3	0.7				0.7	30.0	29.3
	Non HT20, 6 to 54 Mbps	2	6	0.7	0.5			3.6	30.0	26.4
	Non HT20, 6 to 54 Mbps	3	8	0.7	0.5	0.7		5.4	28.0	22.6
	Non HT20, 6 to 54 Mbps	4	9	0.7	0.5	0.7	2.3	7.1	27.0	19.9
	Non HT20 Beam Forming, 6 to 54 Mbps	2	6	0.7	0.5			3.6	30.0	26.4
	Non HT20 Beam Forming, 6 to 54 Mbps	3	8	0.7	0.5	0.7		5.4	28.0	22.6
	Non HT20 Beam Forming, 6 to 54 Mbps	4	9	0.7	0.5	0.7	2.3	7.1	27.0	19.9
	HT/VHT20, M0 to M7	1	3	0.9				0.9	30.0	29.1
	HT/VHT20, M0 to M7	2	6	0.9	0.7			3.8	30.0	26.2
	HT/VHT20, M8 to M15	2	3	0.9	0.7			3.8	30.0	26.2
	HT/VHT20, M0 to M7	3	8	0.9	0.7	0.3		5.4	28.0	22.6
	HT/VHT20, M8 to M15	3	5	0.9	0.7	0.3		5.4	30.0	24.6
	HT/VHT20, M16 to M23	3	3	0.9	0.7	0.3		5.4	30.0	24.6
	HT/VHT20, M0 to M7	4	9	0.9	0.7	0.3	2.4	7.2	27.0	19.8
	HT/VHT20, M8 to M15	4	6	0.9	0.7	0.3	2.4	7.2	30.0	22.8
	HT/VHT20, M16 to M23	4	4	0.9	0.7	0.3	2.4	7.2	30.0	22.8
	HT/VHT20 Beam Forming, M0 to M7	2	6	0.9	0.7			3.8	30.0	26.2
	HT/VHT20 Beam Forming, M8 to M15	2	3	0.9	0.7			3.8	30.0	26.2
	HT/VHT20 Beam Forming, M0 to M7	3	8	0.9	0.7	0.3		5.4	28.0	22.6
	HT/VHT20 Beam Forming, M8 to M15	3	5	0.9	0.7	0.3		5.4	30.0	24.6
	HT/VHT20 Beam Forming, M16 to M23	3	3	0.9	0.7	0.3		5.4	30.0	24.6
	HT/VHT20 Beam Forming, M0 to M7	4	9	0.9	0.7	0.3	2.4	7.2	27.0	19.8
	HT/VHT20 Beam Forming, M8 to M15	4	6	0.9	0.7	0.3	2.4	7.2	30.0	22.8
	HT/VHT20 Beam Forming, M16 to M23	4	4	0.9	0.7	0.3	2.4	7.2	30.0	22.8
	HT/VHT20 STBC, M0 to M7	2	3	0.9	0.7			3.8	30.0	26.2
	HT/VHT20 STBC, M0 to M7	3	5	0.9	0.7	0.3		5.4	30.0	24.6
	HT/VHT20 STBC, M0 to M7	4	6	0.9	0.7	0.3	2.4	7.2	30.0	22.8
5795	Non HT40, 6 to 54 Mbps	1	3	-2.3				-2.3	30.0	32.3
	Non HT40, 6 to 54 Mbps	2	6	-2.3	-1.9			0.9	30.0	29.1
	Non HT40, 6 to 54 Mbps	3	8	-2.3	-1.9	-1.5		2.9	28.0	25.1
	Non HT40, 6 to 54 Mbps	4	9	-2.3	-1.9	-1.5	-0.3	4.6	27.0	22.4
	HT/VHT40, M0 to M7	1	3	-2.5				-2.5	30.0	32.5
	HT/VHT40, M0 to M7	2	6	-2.5	-3.2			0.2	30.0	29.8
	HT/VHT40, M8 to M15	2	3	-2.5	-3.2			0.2	30.0	29.8
	HT/VHT40, M0 to M7	3	8	-2.5	-3.2	-2.7		2.0	28.0	26.0
	HT/VHT40, M8 to M15	3	5	-2.5	-3.2	-2.7		2.0	30.0	28.0



	HT/VHT40, M16 to M23	3	3	-2.5	-3.2	-2.7		2.0	30.0	28.0
	HT/VHT40, M0 to M7	4	9	-2.5	-3.2	-2.7	-0.6	3.9	27.0	23.1
	HT/VHT40, M8 to M15	4	6	-2.5	-3.2	-2.7	-0.6	3.9	30.0	26.1
	HT/VHT40, M16 to M23	4	4	-2.5	-3.2	-2.7	-0.6	3.9	30.0	26.1
	HT/VHT40 Beam Forming, M0 to M7	2	6	-2.5	-3.2			0.2	30.0	29.8
	HT/VHT40 Beam Forming, M8 to M15	2	3	-2.5	-3.2			0.2	30.0	29.8
	HT/VHT40 Beam Forming, M0 to M7	3	8	-2.5	-3.2	-2.7		2.0	28.0	26.0
	HT/VHT40 Beam Forming, M8 to M15	3	5	-2.5	-3.2	-2.7		2.0	30.0	28.0
	HT/VHT40 Beam Forming, M16 to M23	3	3	-2.5	-3.2	-2.7		2.0	30.0	28.0
	HT/VHT40 Beam Forming, M0 to M7	4	9	-2.5	-3.2	-2.7	-0.6	3.9	27.0	23.1
	HT/VHT40 Beam Forming, M8 to M15	4	6	-2.5	-3.2	-2.7	-0.6	3.9	30.0	26.1
	HT/VHT40 Beam Forming, M16 to M23	4	4	-2.5	-3.2	-2.7	-0.6	3.9	30.0	26.1
	HT/VHT40 STBC, M0 to M7	2	3	-2.5	-3.2			0.2	30.0	29.8
	HT/VHT40 STBC, M0 to M7	3	5	-2.5	-3.2	-2.7		2.0	30.0	28.0
	HT/VHT40 STBC, M0 to M7	4	6	-2.5	-3.2	-2.7	-0.6	3.9	30.0	26.1
	Non HT20, 6 to 54 Mbps	1	3	1.6				1.6	30.0	28.4
	Non HT20, 6 to 54 Mbps	2	6	1.6	0.6			4.1	30.0	25.9
	Non HT20, 6 to 54 Mbps	3	8	1.6	0.6	0.0		5.6	28.0	22.4
	Non HT20, 6 to 54 Mbps	4	9	1.6	0.6	0.0	2.3	7.2	27.0	19.8
	Non HT20 Beam Forming, 6 to 54 Mbps	2	6	1.6	0.6			4.1	30.0	25.9
	Non HT20 Beam Forming, 6 to 54 Mbps	3	8	1.6	0.6	0.0		5.6	28.0	22.4
	Non HT20 Beam Forming, 6 to 54 Mbps	4	9	0.2	-0.5	0.3	1.1	6.3	27.0	20.7
	HT/VHT20, M0 to M7	1	3	1.5				1.5	30.0	28.5
	HT/VHT20, M0 to M7	2	6	1.5	0.8			4.2	30.0	25.8
	HT/VHT20, M8 to M15	2	3	1.5	0.8			4.2	30.0	25.8
	HT/VHT20, M0 to M7	3	8	1.5	0.8	0.0		5.6	28.0	22.4
	HT/VHT20, M8 to M15	3	5	1.5	0.8	0.0		5.6	30.0	24.4
	HT/VHT20, M16 to M23	3	3	1.5	0.8	0.0		5.6	30.0	24.4
	HT/VHT20, M0 to M7	4	9	1.5	0.8	0.0	2.4	7.3	27.0	19.7
	HT/VHT20, M8 to M15	4	6	1.5	0.8	0.0	2.4	7.3	30.0	22.7
	HT/VHT20, M16 to M23	4	4	1.5	0.8	0.0	2.4	7.3	30.0	22.7
	HT/VHT20 Beam Forming, M0 to M7	2	6	1.5	0.8			4.2	30.0	25.8
	HT/VHT20 Beam Forming, M8 to M15	2	3	1.5	0.8			4.2	30.0	25.8
	HT/VHT20 Beam Forming, M0 to M7	3	8	1.5	0.8	0.0		5.6	28.0	22.4
	HT/VHT20 Beam Forming, M8 to M15	3	5	1.5	0.8	0.0		5.6	30.0	24.4
	HT/VHT20 Beam Forming, M16 to M23	3	3	1.5	0.8	0.0		5.6	30.0	24.4
	HT/VHT20 Beam Forming, M0 to M7	4	9	0.3	-0.6	0.1	1.3	6.3	27.0	20.7
	HT/VHT20 Beam Forming, M8 to M15	4	6	1.5	0.8	0.0	2.4	7.3	30.0	22.7
	HT/VHT20 Beam Forming, M16 to M23	4	4	1.5	0.8	0.0	2.4	7.3	30.0	22.7
	HT/VHT20 STBC, M0 to M7	2	3	1.5	0.8			4.2	30.0	25.8



HT/VHT20 STBC, M0 to M7	3	5	1.5	0.8	0.0		5.6	30.0	24.4
HT/VHT20 STBC, M0 to M7	4	6	1.5	0.8	0.0	2.4	7.3	30.0	22.7

**Power Spectral Density, 5745 MHz, HT/VHT20, M0 to M7**

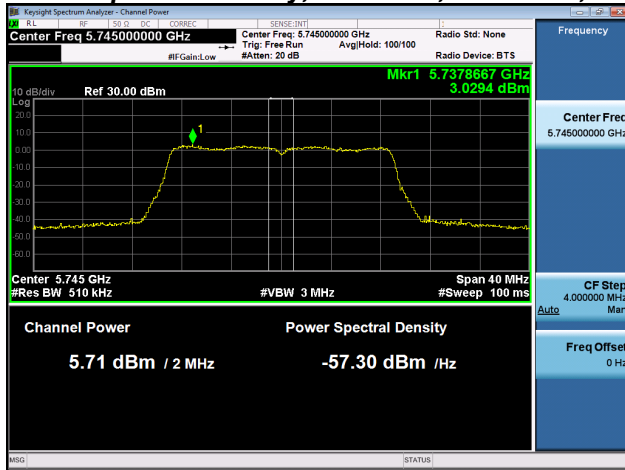

**Antenna A**

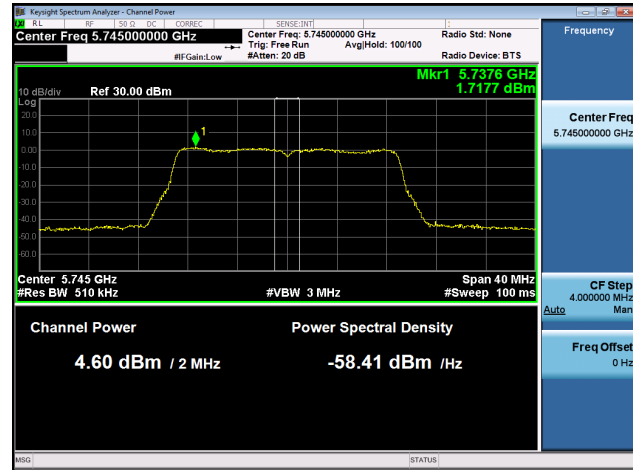

**Antenna B**

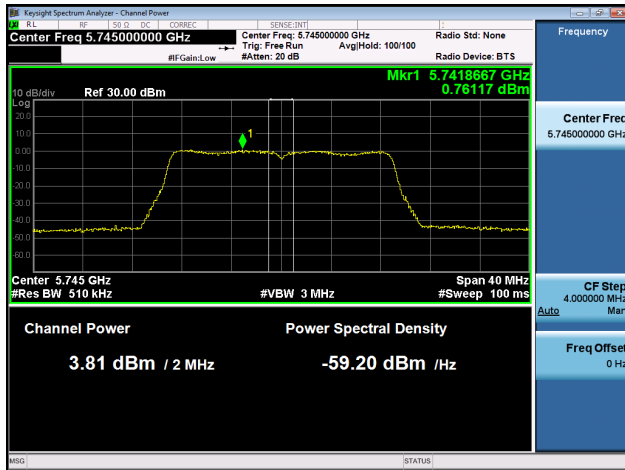

**Antenna C**



**Antenna D**





## Antenna Gain : 4 dBi

Frequency (MHz)	Mode	Tx Paths	Correlated Antenna Gain (dBi)	Tx 1 PSD (dBm/MHz)	Tx 2 PSD (dBm/MHz)	Tx 3 PSD (dBm/MHz)	Tx 4 PSD (dBm/MHz)	Total PSD (dBm/500MHz)	Limit (dBm/500MHz)	Margin (dB)
5745	Non HT20, 6 to 54 Mbps	1	4	3.8				3.8	30.0	26.2
	Non HT20, 6 to 54 Mbps	2	7	2.0	1.2			4.6	29.0	24.4
	Non HT20, 6 to 54 Mbps	3	9	2.0	1.2	-0.2		5.9	27.0	21.1
	Non HT20, 6 to 54 Mbps	4	10	0.4	-0.6	-1.1	0.7	5.9	26.0	20.1
	Non HT20 Beam Forming, 6 to 54 Mbps	2	7	-2.1	-2.5			0.7	29.0	28.3
	Non HT20 Beam Forming, 6 to 54 Mbps	3	9	-3.9	-4.6	-5.4		0.2	27.0	26.8
	Non HT20 Beam Forming, 6 to 54 Mbps	4	10	-6.5	-7.8	-8.7	-6.1	-1.1	26.0	27.1
	HT/VHT20, M0 to M7	1	4	3.0				3.0	30.0	27.0
	HT/VHT20, M0 to M7	2	7	1.5	0.9			4.2	29.0	24.8
	HT/VHT20, M8 to M15	2	4	1.5	0.9			4.2	30.0	25.8
	HT/VHT20, M0 to M7	3	9	1.5	0.9	-0.2		5.6	27.0	21.4
	HT/VHT20, M8 to M15	3	6	1.5	0.9	-0.2		5.6	30.0	24.4
	HT/VHT20, M16 to M23	3	4	1.5	0.9	-0.2		5.6	30.0	24.4
	HT/VHT20, M0 to M7	4	10	0.1	-0.4	-1.0	0.8	5.9	26.0	20.1
	HT/VHT20, M8 to M15	4	7	0.1	-0.4	-1.0	0.8	5.9	29.0	23.1
	HT/VHT20, M16 to M23	4	5	0.1	-0.4	-1.0	0.8	5.9	30.0	24.1
	HT/VHT20 Beam Forming, M0 to M7	2	7	0.1	-0.4			2.9	29.0	26.1
	HT/VHT20 Beam Forming, M8 to M15	2	4	1.5	0.9			4.2	30.0	25.8
	HT/VHT20 Beam Forming, M0 to M7	3	9	-3.8	-4.7	-5.6		0.1	27.0	26.9
	HT/VHT20 Beam Forming, M8 to M15	3	6	0.1	-0.4	-1.0		4.4	30.0	25.6
	HT/VHT20 Beam Forming, M16 to M23	3	4	1.5	0.9	-0.2		5.6	30.0	24.4
	HT/VHT20 Beam Forming, M0 to M7	4	10	-6.0	-6.5	-7.5	-5.2	-0.2	26.0	26.2
	HT/VHT20 Beam Forming, M8 to M15	4	7	-1.8	-2.7	-3.6	-1.1	3.8	29.0	25.2
	HT/VHT20 Beam Forming, M16 to M23	4	5	0.1	-0.4	-1.0	0.8	5.9	30.0	24.1
	HT/VHT20 STBC, M0 to M7	2	4	1.5	0.9			4.2	30.0	25.8
	HT/VHT20 STBC, M0 to M7	3	6	1.5	0.9	-0.2		5.6	30.0	24.4
	HT/VHT20 STBC, M0 to M7	4	7	0.1	-0.4	-1.0	0.8	5.9	29.0	23.1
	5755	Non HT40, 6 to 54 Mbps	1	4	-2.9				-2.9	30.0
Non HT40, 6 to 54 Mbps		2	7	-5.8	-6.9			-3.3	29.0	32.3
Non HT40, 6 to 54 Mbps		3	9	-10.5	-12.2	-13.0		-7.0	27.0	34.0
Non HT40, 6 to 54 Mbps		4	10	-10.5	-12.2	-13.0	-10.2	-5.3	26.0	31.3
HT/VHT40, M0 to M7		1	4	-1.1				-1.1	30.0	31.1



	HT/VHT40, M0 to M7	2	7	-4.6	-5.4			-2.0	29.0	31.0
	HT/VHT40, M8 to M15	2	4	-4.6	-5.4			-2.0	30.0	32.0
	HT/VHT40, M0 to M7	3	9	-4.6	-5.4	-6.9		-0.8	27.0	27.8
	HT/VHT40, M8 to M15	3	6	-4.6	-5.4	-6.9		-0.8	30.0	30.8
	HT/VHT40, M16 to M23	3	4	-4.6	-5.4	-6.9		-0.8	30.0	30.8
	HT/VHT40, M0 to M7	4	10	-4.6	-5.4	-6.9	-4.4	0.8	26.0	25.2
	HT/VHT40, M8 to M15	4	7	-4.6	-5.4	-6.9	-4.4	0.8	29.0	28.2
	HT/VHT40, M16 to M23	4	5	-4.6	-5.4	-6.9	-4.4	0.8	30.0	29.2
	HT/VHT40 Beam Forming, M0 to M7	2	7	-5.7	-6.5			-3.1	29.0	32.1
	HT/VHT40 Beam Forming, M8 to M15	2	4	-4.6	-5.4			-2.0	30.0	32.0
	HT/VHT40 Beam Forming, M0 to M7	3	9	-9.5	-11.1	-11.3		-5.8	27.0	32.8
	HT/VHT40 Beam Forming, M8 to M15	3	6	-5.7	-6.5	-7.9		-1.8	30.0	31.8
	HT/VHT40 Beam Forming, M16 to M23	3	4	-4.6	-5.4	-6.9		-0.8	30.0	30.8
	HT/VHT40 Beam Forming, M0 to M7	4	10	-10.6	-12.1	-12.5	-10.2	-5.2	26.0	31.2
	HT/VHT40 Beam Forming, M8 to M15	4	7	-5.7	-6.5	-7.9	-4.8	-0.1	29.0	29.1
	HT/VHT40 Beam Forming, M16 to M23	4	5	-4.6	-5.4	-6.9	-4.4	0.8	30.0	29.2
	HT/VHT40 STBC, M0 to M7	2	4	-4.6	-5.4			-2.0	30.0	32.0
	HT/VHT40 STBC, M0 to M7	3	6	-4.6	-5.4	-6.9		-0.8	30.0	30.8
	HT/VHT40 STBC, M0 to M7	4	7	-4.6	-5.4	-6.9	-4.4	0.8	29.0	28.2
5775	Non HT80, 6 to 54 Mbps	1	4	-5.6				-5.6	30.0	35.6
	Non HT80, 6 to 54 Mbps	2	7	-5.6	-7.2			-3.3	29.0	32.3
	Non HT80, 6 to 54 Mbps	3	9	-8.4	-9.7	-9.9		-4.5	27.0	31.5
	Non HT80, 6 to 54 Mbps	4	10	-8.9	-11.5	-12.0	-8.8	-4.0	26.0	30.0
	VHT80, M0 to M9 1ss	1	4	-4.7				-4.7	30.0	34.7
	VHT80, M0 to M9 1ss	2	7	-5.9	-7.0			-3.4	29.0	32.4
	VHT80, M0 to M9 2ss	2	4	-5.9	-7.0			-3.4	30.0	33.4
	VHT80, M0 to M9 1ss	3	9	-5.9	-7.0	-7.5		-2.0	27.0	29.0
	VHT80, M0 to M9 2ss	3	6	-5.9	-7.0	-7.5		-2.0	30.0	32.0
	VHT80, M0 to M9 3ss	3	4	-5.9	-7.0	-7.5		-2.0	30.0	32.0
	VHT80, M0 to M9 1ss	4	10	-7.0	-8.4	-8.7	-6.4	-1.5	26.0	27.5
	VHT80, M0 to M9 2ss	4	7	-7.0	-8.4	-8.7	-6.4	-1.5	29.0	30.5
	VHT80, M0 to M9 3ss	4	5	-7.0	-8.4	-8.7	-6.4	-1.5	30.0	31.5
	VHT80 Beam Forming, M0 to M9 1ss	2	7	-7.0	-8.4			-4.6	29.0	33.6
	VHT80 Beam Forming, M0 to M9 2ss	2	4	-5.9	-7.0			-3.4	30.0	33.4
	VHT80 Beam Forming, M0 to M9 1ss	3	9	-10.0	-11.3	-11.9		-6.2	27.0	33.2
	VHT80 Beam Forming, M0 to M9 2ss	3	6	-8.4	-8.9	-10.0		-4.3	30.0	34.3
	VHT80 Beam Forming, M0 to M9 3ss	3	4	-5.9	-7.0	-7.5		-2.0	30.0	32.0
	VHT80 Beam Forming, M0 to M9 1ss	4	10	-12.0	-13.4	-14.0	-11.4	-6.6	26.0	32.6
	VHT80 Beam Forming, M0 to M9 2ss	4	7	-8.4	-8.9	-10.0	-7.8	-2.7	29.0	31.7
VHT80 Beam Forming, M0 to M9 3ss	4	5	-8.4	-8.9	-10.0	-7.8	-2.7	30.0	32.7	



	VHT80 STBC, M0 to M9 1ss	2	4	-5.9	-7.0			-3.4	30.0	33.4
	VHT80 STBC, M0 to M9 1ss	3	4	-5.9	-7.0	-7.5		-2.0	30.0	32.0
	VHT80 STBC, M0 to M9 1ss	4	4	-7.0	-8.4	-8.7	-6.4	-1.5	30.0	31.5
5785	Non HT20, 6 to 54 Mbps	1	4	0.7				0.7	30.0	29.3
	Non HT20, 6 to 54 Mbps	2	7	0.7	0.5			3.6	29.0	25.4
	Non HT20, 6 to 54 Mbps	3	9	0.7	0.5	0.7		5.4	27.0	21.6
	Non HT20, 6 to 54 Mbps	4	10	0.7	0.5	0.7	2.3	7.1	26.0	18.9
	Non HT20 Beam Forming, 6 to 54 Mbps	2	7	0.7	0.5			3.6	29.0	25.4
	Non HT20 Beam Forming, 6 to 54 Mbps	3	9	0.7	0.5	0.7		5.4	27.0	21.6
	Non HT20 Beam Forming, 6 to 54 Mbps	4	10	0.7	0.5	0.7	2.3	7.1	26.0	18.9
	HT/VHT20, M0 to M7	1	4	0.9				0.9	30.0	29.1
	HT/VHT20, M0 to M7	2	7	0.9	0.7			3.8	29.0	25.2
	HT/VHT20, M8 to M15	2	4	0.9	0.7			3.8	30.0	26.2
	HT/VHT20, M0 to M7	3	9	0.9	0.7	0.3		5.4	27.0	21.6
	HT/VHT20, M8 to M15	3	6	0.9	0.7	0.3		5.4	30.0	24.6
	HT/VHT20, M16 to M23	3	4	0.9	0.7	0.3		5.4	30.0	24.6
	HT/VHT20, M0 to M7	4	10	0.9	0.7	0.3	2.4	7.2	26.0	18.8
	HT/VHT20, M8 to M15	4	7	0.9	0.7	0.3	2.4	7.2	29.0	21.8
	HT/VHT20, M16 to M23	4	5	0.9	0.7	0.3	2.4	7.2	30.0	22.8
	HT/VHT20 Beam Forming, M0 to M7	2	7	0.9	0.7			3.8	29.0	25.2
	HT/VHT20 Beam Forming, M8 to M15	2	4	0.9	0.7			3.8	30.0	26.2
	HT/VHT20 Beam Forming, M0 to M7	3	9	0.9	0.7	0.3		5.4	27.0	21.6
	HT/VHT20 Beam Forming, M8 to M15	3	6	0.9	0.7	0.3		5.4	30.0	24.6
	HT/VHT20 Beam Forming, M16 to M23	3	4	0.9	0.7	0.3		5.4	30.0	24.6
	HT/VHT20 Beam Forming, M0 to M7	4	10	0.9	0.7	0.3	2.4	7.2	26.0	18.8
	HT/VHT20 Beam Forming, M8 to M15	4	7	0.9	0.7	0.3	2.4	7.2	29.0	21.8
	HT/VHT20 Beam Forming, M16 to M23	4	5	0.9	0.7	0.3	2.4	7.2	30.0	22.8
	HT/VHT20 STBC, M0 to M7	2	4	0.9	0.7			3.8	30.0	26.2
	HT/VHT20 STBC, M0 to M7	3	6	0.9	0.7	0.3		5.4	30.0	24.6
	HT/VHT20 STBC, M0 to M7	4	7	0.9	0.7	0.3	2.4	7.2	29.0	21.8
5795	Non HT40, 6 to 54 Mbps	1	4	-2.3				-2.3	30.0	32.3
	Non HT40, 6 to 54 Mbps	2	7	-2.3	-1.9			0.9	29.0	28.1
	Non HT40, 6 to 54 Mbps	3	9	-2.3	-1.9	-1.5		2.9	27.0	24.1
	Non HT40, 6 to 54 Mbps	4	10	-2.3	-1.9	-1.5	-0.3	4.6	26.0	21.4
	HT/VHT40, M0 to M7	1	4	-2.5				-2.5	30.0	32.5
	HT/VHT40, M0 to M7	2	7	-2.5	-3.2			0.2	29.0	28.8
	HT/VHT40, M8 to M15	2	4	-2.5	-3.2			0.2	30.0	29.8
	HT/VHT40, M0 to M7	3	9	-2.5	-3.2	-2.7		2.0	27.0	25.0
	HT/VHT40, M8 to M15	3	6	-2.5	-3.2	-2.7		2.0	30.0	28.0



	HT/VHT40, M16 to M23	3	4	-2.5	-3.2	-2.7		2.0	30.0	28.0
	HT/VHT40, M0 to M7	4	10	-2.5	-3.2	-2.7	-0.6	3.9	26.0	22.1
	HT/VHT40, M8 to M15	4	7	-2.5	-3.2	-2.7	-0.6	3.9	29.0	25.1
	HT/VHT40, M16 to M23	4	5	-2.5	-3.2	-2.7	-0.6	3.9	30.0	26.1
	HT/VHT40 Beam Forming, M0 to M7	2	7	-2.5	-3.2			0.2	29.0	28.8
	HT/VHT40 Beam Forming, M8 to M15	2	4	-2.5	-3.2			0.2	30.0	29.8
	HT/VHT40 Beam Forming, M0 to M7	3	9	-2.5	-3.2	-2.7		2.0	27.0	25.0
	HT/VHT40 Beam Forming, M8 to M15	3	6	-2.5	-3.2	-2.7		2.0	30.0	28.0
	HT/VHT40 Beam Forming, M16 to M23	3	4	-2.5	-3.2	-2.7		2.0	30.0	28.0
	HT/VHT40 Beam Forming, M0 to M7	4	10	-2.5	-3.2	-2.7	-0.6	3.9	26.0	22.1
	HT/VHT40 Beam Forming, M8 to M15	4	7	-2.5	-3.2	-2.7	-0.6	3.9	29.0	25.1
	HT/VHT40 Beam Forming, M16 to M23	4	5	-2.5	-3.2	-2.7	-0.6	3.9	30.0	26.1
	HT/VHT40 STBC, M0 to M7	2	4	-2.5	-3.2			0.2	30.0	29.8
	HT/VHT40 STBC, M0 to M7	3	6	-2.5	-3.2	-2.7		2.0	30.0	28.0
	HT/VHT40 STBC, M0 to M7	4	7	-2.5	-3.2	-2.7	-0.6	3.9	29.0	25.1
	Non HT20, 6 to 54 Mbps	1	4	1.6				1.6	30.0	28.4
	Non HT20, 6 to 54 Mbps	2	7	1.6	0.6			4.1	29.0	24.9
	Non HT20, 6 to 54 Mbps	3	9	1.6	0.6	0.0		5.6	27.0	21.4
	Non HT20, 6 to 54 Mbps	4	10	1.6	0.6	0.0	2.3	7.2	26.0	18.8
	Non HT20 Beam Forming, 6 to 54 Mbps	2	7	1.6	0.6			4.1	29.0	24.9
	Non HT20 Beam Forming, 6 to 54 Mbps	3	9	1.6	0.6	0.0		5.6	27.0	21.4
	Non HT20 Beam Forming, 6 to 54 Mbps	4	10	-1.1	-1.5	-1.1	0.2	5.2	26.0	20.8
	HT/VHT20, M0 to M7	1	4	1.5				1.5	30.0	28.5
	HT/VHT20, M0 to M7	2	7	1.5	0.8			4.2	29.0	24.8
	HT/VHT20, M8 to M15	2	4	1.5	0.8			4.2	30.0	25.8
	HT/VHT20, M0 to M7	3	9	1.5	0.8	0.0		5.6	27.0	21.4
	HT/VHT20, M8 to M15	3	6	1.5	0.8	0.0		5.6	30.0	24.4
	HT/VHT20, M16 to M23	3	4	1.5	0.8	0.0		5.6	30.0	24.4
	<b>HT/VHT20, M0 to M7</b>	<b>4</b>	<b>10</b>	<b>1.5</b>	<b>0.8</b>	<b>0.0</b>	<b>2.4</b>	<b>7.3</b>	<b>26.0</b>	<b>18.7</b>
	HT/VHT20, M8 to M15	4	7	1.5	0.8	0.0	2.4	7.3	29.0	21.7
	HT/VHT20, M16 to M23	4	5	1.5	0.8	0.0	2.4	7.3	30.0	22.7
	HT/VHT20 Beam Forming, M0 to M7	2	7	1.5	0.8			4.2	29.0	24.8
	HT/VHT20 Beam Forming, M8 to M15	2	4	1.5	0.8			4.2	30.0	25.8
	HT/VHT20 Beam Forming, M0 to M7	3	9	1.5	0.8	0.0		5.6	27.0	21.4
	HT/VHT20 Beam Forming, M8 to M15	3	6	1.5	0.8	0.0		5.6	30.0	24.4
	HT/VHT20 Beam Forming, M16 to M23	3	4	1.5	0.8	0.0		5.6	30.0	24.4
	HT/VHT20 Beam Forming, M0 to M7	4	10	-0.9	-1.6	-0.8	-0.1	5.2	26.0	20.8
	HT/VHT20 Beam Forming, M8 to M15	4	7	1.5	0.8	0.0	2.4	7.3	29.0	21.7
	HT/VHT20 Beam Forming, M16 to M23	4	5	1.5	0.8	0.0	2.4	7.3	30.0	22.7
	HT/VHT20 STBC, M0 to M7	2	4	1.5	0.8			4.2	30.0	25.8



HT/VHT20 STBC, M0 to M7	3	6	1.5	0.8	0.0		5.6	30.0	24.4
HT/VHT20 STBC, M0 to M7	4	7	1.5	0.8	0.0	2.4	7.3	29.0	21.7



**Power Spectral Density, 5825 MHz, HT/VHT20, M0 to M7**

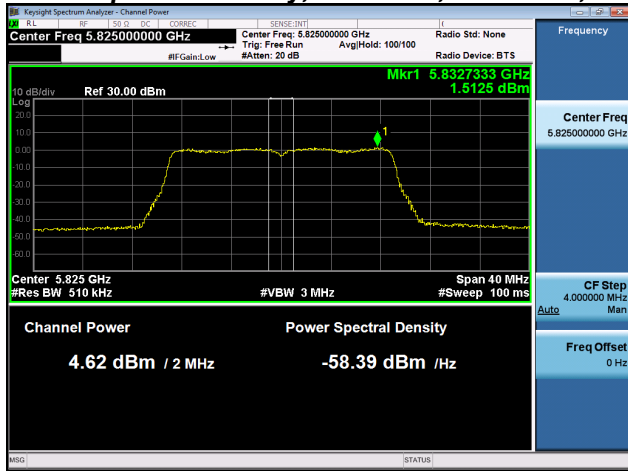

**Antenna A**

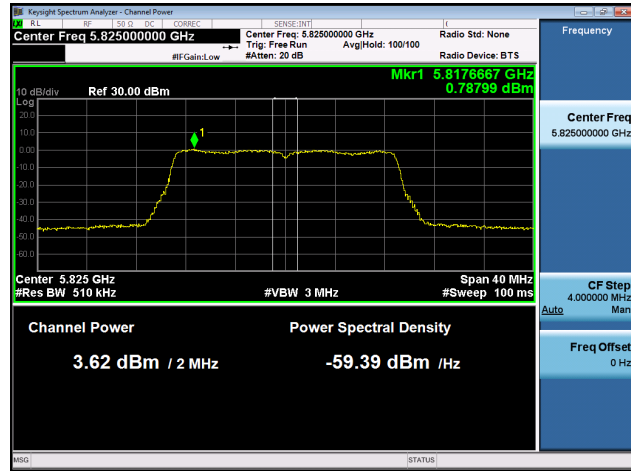

**Antenna B**

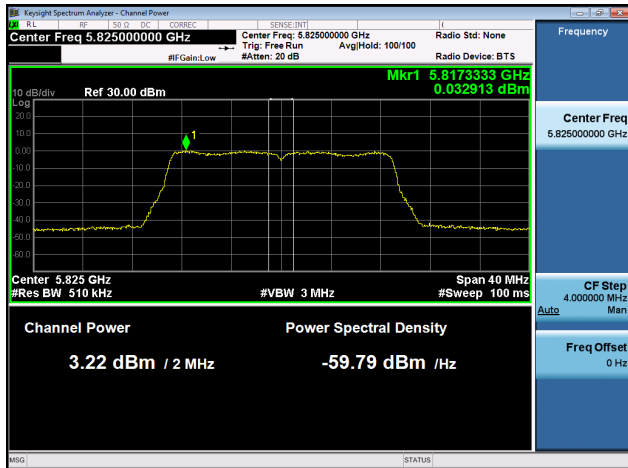

**Antenna C**

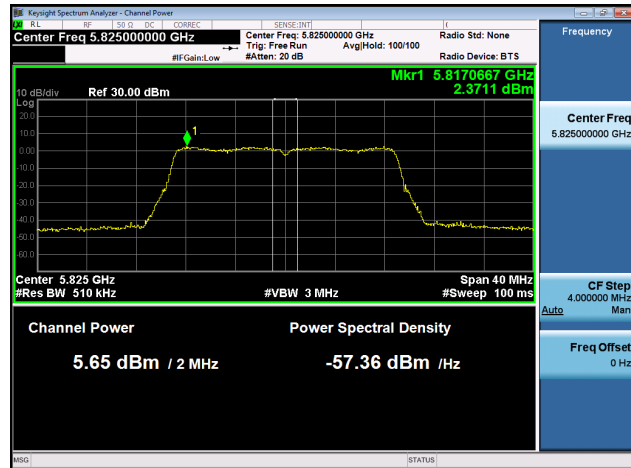

**Antenna D**



## Antenna Gain : 5 dBi

Frequency (MHz)	Mode	Tx Paths	Correlated Antenna Gain (dBi)	Tx 1 PSD (dBm/MHz)	Tx 2 PSD (dBm/MHz)	Tx 3 PSD (dBm/MHz)	Tx 4 PSD (dBm/MHz)	Total PSD (dBm/500MHz)	Limit (dBm/500MHz)	Margin (dB)
5745	Non HT20, 6 to 54 Mbps	1	5	2.7				2.7	30.0	27.3
	Non HT20, 6 to 54 Mbps	2	8	0.4	-0.6			2.9	28.0	25.1
	Non HT20, 6 to 54 Mbps	3	10	0.4	-0.6	-1.1		4.4	26.0	21.6
	Non HT20, 6 to 54 Mbps	4	11	-1.0	-1.6	-2.5	-0.1	4.8	25.0	20.2
	Non HT20 Beam Forming, 6 to 54 Mbps	2	8	-2.8	-3.9			-0.3	28.0	28.3
	Non HT20 Beam Forming, 6 to 54 Mbps	3	10	-5.8	-6.3	-7.3		-1.7	26.0	27.7
	Non HT20 Beam Forming, 6 to 54 Mbps	4	11	-6.5	-7.8	-8.7	-6.1	-1.1	25.0	26.1
	HT/VHT20, M0 to M7	1	5	3.0				3.0	30.0	27.0
	HT/VHT20, M0 to M7	2	8	0.1	-0.4			2.9	28.0	25.1
	HT/VHT20, M8 to M15	2	5	0.1	-0.4			2.9	30.0	27.1
	HT/VHT20, M0 to M7	3	10	0.1	-0.4	-1.0		4.4	26.0	21.6
	HT/VHT20, M8 to M15	3	7	0.1	-0.4	-1.0		4.4	29.0	24.6
	HT/VHT20, M16 to M23	3	5	0.1	-0.4	-1.0		4.4	30.0	25.6
	HT/VHT20, M0 to M7	4	11	0.1	-0.4	-1.0	0.8	5.9	25.0	19.1
	HT/VHT20, M8 to M15	4	8	0.1	-0.4	-1.0	0.8	5.9	28.0	22.1
	HT/VHT20, M16 to M23	4	6	0.1	-0.4	-1.0	0.8	5.9	30.0	24.1
	HT/VHT20 Beam Forming, M0 to M7	2	8	-3.0	-3.8			-0.4	28.0	28.4
	HT/VHT20 Beam Forming, M8 to M15	2	5	0.1	-0.4			2.9	30.0	27.1
	HT/VHT20 Beam Forming, M0 to M7	3	10	-4.6	-5.4	-6.6		-0.7	26.0	26.7
	HT/VHT20 Beam Forming, M8 to M15	3	7	0.1	-0.4	-1.0		4.4	29.0	24.6
	HT/VHT20 Beam Forming, M16 to M23	3	5	0.1	-0.4	-1.0		4.4	30.0	25.6
	HT/VHT20 Beam Forming, M0 to M7	4	11	-6.5	-7.5	-8.7	-6.0	-1.0	25.0	26.0
	HT/VHT20 Beam Forming, M8 to M15	4	8	-3.0	-3.8	-4.3	-2.2	2.8	28.0	25.2
	HT/VHT20 Beam Forming, M16 to M23	4	6	0.1	-0.4	-1.0	0.8	5.9	30.0	24.1
	HT/VHT20 STBC, M0 to M7	2	5	0.1	-0.4			2.9	30.0	27.1
	HT/VHT20 STBC, M0 to M7	3	7	0.1	-0.4	-1.0		4.4	29.0	24.6
	HT/VHT20 STBC, M0 to M7	4	8	0.1	-0.4	-1.0	0.8	5.9	28.0	22.1
	5755	Non HT40, 6 to 54 Mbps	1	5	-2.9				-2.9	30.0
Non HT40, 6 to 54 Mbps		2	8	-5.8	-6.9			-3.3	28.0	31.3
Non HT40, 6 to 54 Mbps		3	10	-10.5	-12.2	-13.0		-7.0	26.0	33.0
Non HT40, 6 to 54 Mbps		4	11	-10.5	-12.2	-13.0	-10.2	-5.3	25.0	30.3
HT/VHT40, M0 to M7		1	5	-1.1				-1.1	30.0	31.1



	HT/VHT40, M0 to M7	2	8	-4.6	-5.4			-2.0	28.0	30.0
	HT/VHT40, M8 to M15	2	5	-4.6	-5.4			-2.0	30.0	32.0
	HT/VHT40, M0 to M7	3	10	-4.6	-5.4	-6.9		-0.8	26.0	26.8
	HT/VHT40, M8 to M15	3	7	-4.6	-5.4	-6.9		-0.8	29.0	29.8
	HT/VHT40, M16 to M23	3	5	-4.6	-5.4	-6.9		-0.8	30.0	30.8
	HT/VHT40, M0 to M7	4	11	-4.6	-5.4	-6.9	-4.4	0.8	25.0	24.2
	HT/VHT40, M8 to M15	4	8	-4.6	-5.4	-6.9	-4.4	0.8	28.0	27.2
	HT/VHT40, M16 to M23	4	6	-4.6	-5.4	-6.9	-4.4	0.8	30.0	29.2
	HT/VHT40 Beam Forming, M0 to M7	2	8	-5.7	-6.5			-3.1	28.0	31.1
	HT/VHT40 Beam Forming, M8 to M15	2	5	-4.6	-5.4			-2.0	30.0	32.0
	HT/VHT40 Beam Forming, M0 to M7	3	10	-10.6	-12.1	-12.5		-6.9	26.0	32.9
	HT/VHT40 Beam Forming, M8 to M15	3	7	-5.7	-6.5	-7.9		-1.8	29.0	30.8
	HT/VHT40 Beam Forming, M16 to M23	3	5	-4.6	-5.4	-6.9		-0.8	30.0	30.8
	HT/VHT40 Beam Forming, M0 to M7	4	11	-11.8	-12.7	-13.9	-11.3	-6.3	25.0	31.3
	HT/VHT40 Beam Forming, M8 to M15	4	8	-9.5	-11.1	-11.3	-8.6	-4.0	28.0	32.0
	HT/VHT40 Beam Forming, M16 to M23	4	6	-5.7	-6.5	-7.9	-4.8	-0.1	30.0	30.1
	HT/VHT40 STBC, M0 to M7	2	5	-4.6	-5.4			-2.0	30.0	32.0
	HT/VHT40 STBC, M0 to M7	3	7	-4.6	-5.4	-6.9		-0.8	29.0	29.8
	HT/VHT40 STBC, M0 to M7	4	8	-4.6	-5.4	-6.9	-4.4	0.8	28.0	27.2
5775	Non HT80, 6 to 54 Mbps	1	5	-5.6				-5.6	30.0	35.6
	Non HT80, 6 to 54 Mbps	2	8	-5.6	-7.2			-3.3	28.0	31.3
	Non HT80, 6 to 54 Mbps	3	10	-8.4	-9.7	-9.9		-4.5	26.0	30.5
	Non HT80, 6 to 54 Mbps	4	11	-8.9	-11.5	-12.0	-8.8	-4.0	25.0	29.0
	VHT80, M0 to M9 1ss	1	5	-4.7				-4.7	30.0	34.7
	VHT80, M0 to M9 1ss	2	8	-5.9	-7.0			-3.4	28.0	31.4
	VHT80, M0 to M9 2ss	2	5	-5.9	-7.0			-3.4	30.0	33.4
	VHT80, M0 to M9 1ss	3	10	-5.9	-7.0	-7.5		-2.0	26.0	28.0
	VHT80, M0 to M9 2ss	3	7	-5.9	-7.0	-7.5		-2.0	29.0	31.0
	VHT80, M0 to M9 3ss	3	5	-5.9	-7.0	-7.5		-2.0	30.0	32.0
	VHT80, M0 to M9 1ss	4	11	-8.4	-8.9	-10.0	-7.8	-2.7	25.0	27.7
	VHT80, M0 to M9 2ss	4	8	-8.4	-8.9	-10.0	-7.8	-2.7	28.0	30.7
	VHT80, M0 to M9 3ss	4	6	-8.4	-8.9	-10.0	-7.8	-2.7	30.0	32.7
	VHT80 Beam Forming, M0 to M9 1ss	2	8	-8.4	-8.9			-5.6	28.0	33.6
	VHT80 Beam Forming, M0 to M9 2ss	2	5	-5.9	-7.0			-3.4	30.0	33.4
	VHT80 Beam Forming, M0 to M9 1ss	3	10	-10.0	-11.3	-11.9		-6.2	26.0	32.2
	VHT80 Beam Forming, M0 to M9 2ss	3	7	-8.4	-8.9	-10.0		-4.3	29.0	33.3
	VHT80 Beam Forming, M0 to M9 3ss	3	5	-5.9	-7.0	-7.5		-2.0	30.0	32.0
	VHT80 Beam Forming, M0 to M9 1ss	4	11	-13.0	-14.3	-14.9	-12.5	-7.5	25.0	32.5
	VHT80 Beam Forming, M0 to M9 2ss	4	8	-8.4	-8.9	-10.0	-7.8	-2.7	28.0	30.7
VHT80 Beam Forming, M0 to M9 3ss	4	6	-8.4	-8.9	-10.0	-7.8	-2.7	30.0	32.7	





	VHT80 STBC, M0 to M9 1ss	2	5	-5.9	-7.0			-3.4	30.0	33.4
	VHT80 STBC, M0 to M9 1ss	3	5	-5.9	-7.0	-7.5		-2.0	30.0	32.0
	VHT80 STBC, M0 to M9 1ss	4	5	-8.4	-8.9	-10.0	-7.8	-2.7	30.0	32.7
5785	Non HT20, 6 to 54 Mbps	1	5	0.7				0.7	30.0	29.3
	Non HT20, 6 to 54 Mbps	2	8	0.7	0.5			3.6	28.0	24.4
	Non HT20, 6 to 54 Mbps	3	10	0.7	0.5	0.7		5.4	26.0	20.6
	Non HT20, 6 to 54 Mbps	4	11	0.7	0.5	0.7	2.3	7.1	25.0	17.9
	Non HT20 Beam Forming, 6 to 54 Mbps	2	8	0.7	0.5			3.6	28.0	24.4
	Non HT20 Beam Forming, 6 to 54 Mbps	3	10	0.7	0.5	0.7		5.4	26.0	20.6
	Non HT20 Beam Forming, 6 to 54 Mbps	4	11	0.7	0.5	0.7	2.3	7.1	25.0	17.9
	HT/VHT20, M0 to M7	1	5	0.9				0.9	30.0	29.1
	HT/VHT20, M0 to M7	2	8	0.9	0.7			3.8	28.0	24.2
	HT/VHT20, M8 to M15	2	5	0.9	0.7			3.8	30.0	26.2
	HT/VHT20, M0 to M7	3	10	0.9	0.7	0.3		5.4	26.0	20.6
	HT/VHT20, M8 to M15	3	7	0.9	0.7	0.3		5.4	29.0	23.6
	HT/VHT20, M16 to M23	3	5	0.9	0.7	0.3		5.4	30.0	24.6
	HT/VHT20, M0 to M7	4	11	0.9	0.7	0.3	2.4	7.2	25.0	17.8
	HT/VHT20, M8 to M15	4	8	0.9	0.7	0.3	2.4	7.2	28.0	20.8
	HT/VHT20, M16 to M23	4	6	0.9	0.7	0.3	2.4	7.2	30.0	22.8
	HT/VHT20 Beam Forming, M0 to M7	2	8	0.9	0.7			3.8	28.0	24.2
	HT/VHT20 Beam Forming, M8 to M15	2	5	0.9	0.7			3.8	30.0	26.2
	HT/VHT20 Beam Forming, M0 to M7	3	10	0.9	0.7	0.3		5.4	26.0	20.6
	HT/VHT20 Beam Forming, M8 to M15	3	7	0.9	0.7	0.3		5.4	29.0	23.6
	HT/VHT20 Beam Forming, M16 to M23	3	5	0.9	0.7	0.3		5.4	30.0	24.6
	HT/VHT20 Beam Forming, M0 to M7	4	11	0.9	0.7	0.3	2.4	7.2	25.0	17.8
	HT/VHT20 Beam Forming, M8 to M15	4	8	0.9	0.7	0.3	2.4	7.2	28.0	20.8
	HT/VHT20 Beam Forming, M16 to M23	4	6	0.9	0.7	0.3	2.4	7.2	30.0	22.8
	HT/VHT20 STBC, M0 to M7	2	5	0.9	0.7			3.8	30.0	26.2
	HT/VHT20 STBC, M0 to M7	3	7	0.9	0.7	0.3		5.4	29.0	23.6
	HT/VHT20 STBC, M0 to M7	4	8	0.9	0.7	0.3	2.4	7.2	28.0	20.8
	5795	Non HT40, 6 to 54 Mbps	1	5	-2.3				-2.3	30.0
Non HT40, 6 to 54 Mbps		2	8	-2.3	-1.9			0.9	28.0	27.1
Non HT40, 6 to 54 Mbps		3	10	-2.3	-1.9	-1.5		2.9	26.0	23.1
Non HT40, 6 to 54 Mbps		4	11	-2.3	-1.9	-1.5	-0.3	4.6	25.0	20.4
HT/VHT40, M0 to M7		1	5	-2.5				-2.5	30.0	32.5
HT/VHT40, M0 to M7		2	8	-2.5	-3.2			0.2	28.0	27.8
HT/VHT40, M8 to M15		2	5	-2.5	-3.2			0.2	30.0	29.8
HT/VHT40, M0 to M7		3	10	-2.5	-3.2	-2.7		2.0	26.0	24.0
HT/VHT40, M8 to M15		3	7	-2.5	-3.2	-2.7		2.0	29.0	27.0



	HT/VHT40, M16 to M23	3	5	-2.5	-3.2	-2.7		2.0	30.0	28.0
	HT/VHT40, M0 to M7	4	11	-2.5	-3.2	-2.7	-0.6	3.9	25.0	21.1
	HT/VHT40, M8 to M15	4	8	-2.5	-3.2	-2.7	-0.6	3.9	28.0	24.1
	HT/VHT40, M16 to M23	4	6	-2.5	-3.2	-2.7	-0.6	3.9	30.0	26.1
	HT/VHT40 Beam Forming, M0 to M7	2	8	-2.5	-3.2			0.2	28.0	27.8
	HT/VHT40 Beam Forming, M8 to M15	2	5	-2.5	-3.2			0.2	30.0	29.8
	HT/VHT40 Beam Forming, M0 to M7	3	10	-2.5	-3.2	-2.7		2.0	26.0	24.0
	HT/VHT40 Beam Forming, M8 to M15	3	7	-2.5	-3.2	-2.7		2.0	29.0	27.0
	HT/VHT40 Beam Forming, M16 to M23	3	5	-2.5	-3.2	-2.7		2.0	30.0	28.0
	HT/VHT40 Beam Forming, M0 to M7	4	11	-2.5	-3.2	-2.7	-0.6	3.9	25.0	21.1
	HT/VHT40 Beam Forming, M8 to M15	4	8	-2.5	-3.2	-2.7	-0.6	3.9	28.0	24.1
	HT/VHT40 Beam Forming, M16 to M23	4	6	-2.5	-3.2	-2.7	-0.6	3.9	30.0	26.1
	HT/VHT40 STBC, M0 to M7	2	5	-2.5	-3.2			0.2	30.0	29.8
	HT/VHT40 STBC, M0 to M7	3	7	-2.5	-3.2	-2.7		2.0	29.0	27.0
	HT/VHT40 STBC, M0 to M7	4	8	-2.5	-3.2	-2.7	-0.6	3.9	28.0	24.1
	Non HT20, 6 to 54 Mbps	1	5	1.6				1.6	30.0	28.4
	Non HT20, 6 to 54 Mbps	2	8	1.6	0.6			4.1	28.0	23.9
	Non HT20, 6 to 54 Mbps	3	10	1.6	0.6	0.0		5.6	26.0	20.4
	Non HT20, 6 to 54 Mbps	4	11	1.6	0.6	0.0	2.3	7.2	25.0	17.8
	Non HT20 Beam Forming, 6 to 54 Mbps	2	8	1.6	0.6			4.1	28.0	23.9
	Non HT20 Beam Forming, 6 to 54 Mbps	3	10	1.6	0.6	0.0		5.6	26.0	20.4
	Non HT20 Beam Forming, 6 to 54 Mbps	4	11	-1.6	-3.0	-2.4	-1.1	4.1	25.0	20.9
	HT/VHT20, M0 to M7	1	5	1.5				1.5	30.0	28.5
	HT/VHT20, M0 to M7	2	8	1.5	0.8			4.2	28.0	23.8
	HT/VHT20, M8 to M15	2	5	1.5	0.8			4.2	30.0	25.8
	HT/VHT20, M0 to M7	3	10	1.5	0.8	0.0		5.6	26.0	20.4
	HT/VHT20, M8 to M15	3	7	1.5	0.8	0.0		5.6	29.0	23.4
	HT/VHT20, M16 to M23	3	5	1.5	0.8	0.0		5.6	30.0	24.4
	<b>HT/VHT20, M0 to M7</b>	<b>4</b>	<b>11</b>	<b>1.5</b>	<b>0.8</b>	<b>0.0</b>	<b>2.4</b>	<b>7.3</b>	<b>25.0</b>	<b>17.7</b>
	HT/VHT20, M8 to M15	4	8	1.5	0.8	0.0	2.4	7.3	28.0	20.7
	HT/VHT20, M16 to M23	4	6	1.5	0.8	0.0	2.4	7.3	30.0	22.7
	HT/VHT20 Beam Forming, M0 to M7	2	8	1.5	0.8			4.2	28.0	23.8
	HT/VHT20 Beam Forming, M8 to M15	2	5	1.5	0.8			4.2	30.0	25.8
	HT/VHT20 Beam Forming, M0 to M7	3	10	1.5	0.8	0.0		5.6	26.0	20.4
	HT/VHT20 Beam Forming, M8 to M15	3	7	1.5	0.8	0.0		5.6	29.0	23.4
	HT/VHT20 Beam Forming, M16 to M23	3	5	1.5	0.8	0.0		5.6	30.0	24.4
	HT/VHT20 Beam Forming, M0 to M7	4	11	-2.4	-2.8	-2.5	-1.3	3.8	25.0	21.2
	HT/VHT20 Beam Forming, M8 to M15	4	8	1.5	0.8	0.0	2.4	7.3	28.0	20.7
	HT/VHT20 Beam Forming, M16 to M23	4	6	1.5	0.8	0.0	2.4	7.3	30.0	22.7
	HT/VHT20 STBC, M0 to M7	2	5	1.5	0.8			4.2	30.0	25.8



HT/VHT20 STBC, M0 to M7	3	7	1.5	0.8	0.0		5.6	29.0	23.4
HT/VHT20 STBC, M0 to M7	4	8	1.5	0.8	0.0	2.4	7.3	28.0	20.7



**Power Spectral Density, 5825 MHz, HT/VHT20, M0 to M7**

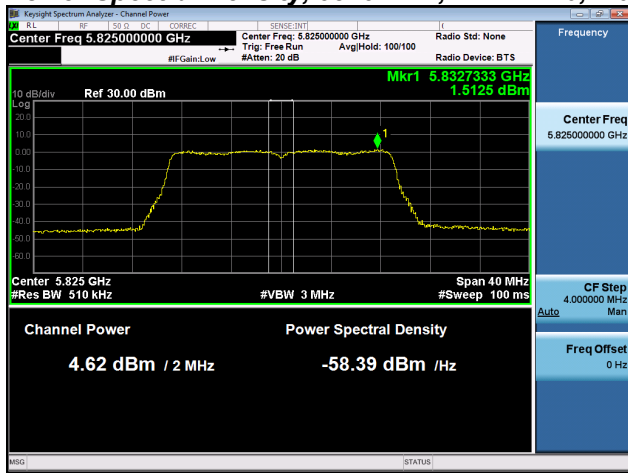

**Antenna A**

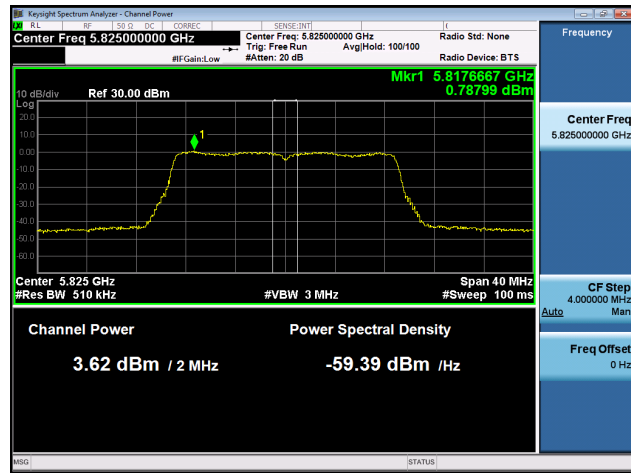

**Antenna B**

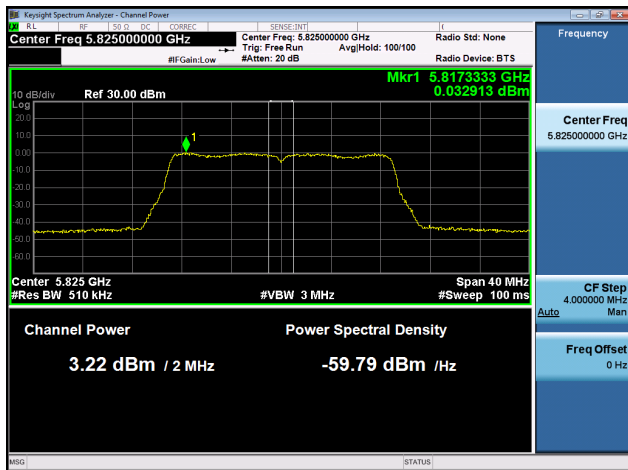

**Antenna C**

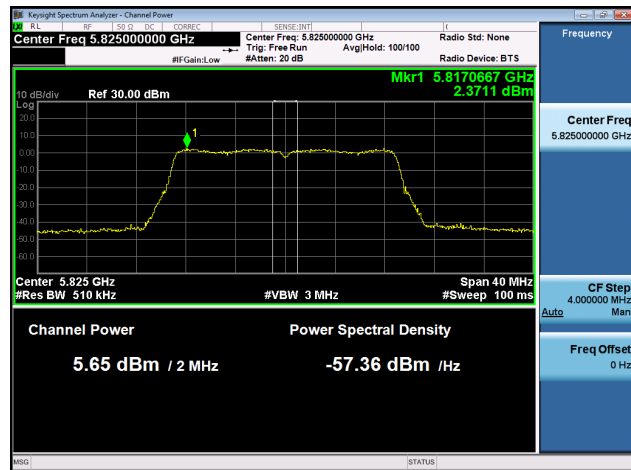

**Antenna D**



## Antenna Gain : 6 dBi

Frequency (MHz)	Mode	Tx Paths	Correlated Antenna Gain (dBi)	Tx 1 PSD (dBm/MHz)	Tx 2 PSD (dBm/MHz)	Tx 3 PSD (dBm/MHz)	Tx 4 PSD (dBm/MHz)	Total PSD (dBm/500MHz)	Limit (dBm/500MHz)	Margin (dB)
5745	Non HT20, 6 to 54 Mbps	1	6	2.7				2.7	30.0	27.3
	Non HT20, 6 to 54 Mbps	2	9	-1.0	-1.6			1.7	27.0	25.3
	Non HT20, 6 to 54 Mbps	3	11	-1.0	-1.6	-2.5		3.1	25.0	21.9
	Non HT20, 6 to 54 Mbps	4	12	-2.1	-2.5	-3.2	-1.4	3.8	24.0	20.2
	Non HT20 Beam Forming, 6 to 54 Mbps	2	9	-3.9	-4.6			-1.2	27.0	28.2
	Non HT20 Beam Forming, 6 to 54 Mbps	3	11	-5.8	-6.3	-7.3		-1.7	25.0	26.7
	Non HT20 Beam Forming, 6 to 54 Mbps	4	12	-6.5	-7.8	-8.7	-6.1	-1.1	24.0	25.1
	HT/VHT20, M0 to M7	1	6	3.0				3.0	30.0	27.0
	HT/VHT20, M0 to M7	2	9	0.1	-0.4			2.9	27.0	24.1
	HT/VHT20, M8 to M15	2	6	0.1	-0.4			2.9	30.0	27.1
	HT/VHT20, M0 to M7	3	11	0.1	-0.4	-1.0		4.4	25.0	20.6
	HT/VHT20, M8 to M15	3	8	0.1	-0.4	-1.0		4.4	28.0	23.6
	HT/VHT20, M16 to M23	3	6	0.1	-0.4	-1.0		4.4	30.0	25.6
	HT/VHT20, M0 to M7	4	12	0.1	-0.4	-1.0	0.8	5.9	24.0	18.1
	HT/VHT20, M8 to M15	4	9	0.1	-0.4	-1.0	0.8	5.9	27.0	21.1
	HT/VHT20, M16 to M23	4	7	0.1	-0.4	-1.0	0.8	5.9	29.0	23.1
	HT/VHT20 Beam Forming, M0 to M7	2	9	-3.8	-4.7			-1.2	27.0	28.2
	HT/VHT20 Beam Forming, M8 to M15	2	6	0.1	-0.4			2.9	30.0	27.1
	HT/VHT20 Beam Forming, M0 to M7	3	11	-6.0	-6.5	-7.5		-1.9	25.0	26.9
	HT/VHT20 Beam Forming, M8 to M15	3	8	-3.0	-3.8	-4.3		1.1	28.0	26.9
	HT/VHT20 Beam Forming, M16 to M23	3	6	0.1	-0.4	-1.0		4.4	30.0	25.6
	HT/VHT20 Beam Forming, M0 to M7	4	12	-7.8	-8.5	-9.5	-7.3	-2.2	24.0	26.2
	HT/VHT20 Beam Forming, M8 to M15	4	9	-4.6	-5.4	-6.6	-4.4	0.9	27.0	26.1
	HT/VHT20 Beam Forming, M16 to M23	4	7	-1.8	-2.7	-3.6	-1.1	3.8	29.0	25.2
	HT/VHT20 STBC, M0 to M7	2	6	0.1	-0.4			2.9	30.0	27.1
	HT/VHT20 STBC, M0 to M7	3	8	0.1	-0.4	-1.0		4.4	28.0	23.6
	HT/VHT20 STBC, M0 to M7	4	9	0.1	-0.4	-1.0	0.8	5.9	27.0	21.1
	5755	Non HT40, 6 to 54 Mbps	1	6	-2.9				-2.9	30.0
Non HT40, 6 to 54 Mbps		2	9	-9.1	-10.1			-6.6	27.0	33.6
Non HT40, 6 to 54 Mbps		3	11	-12.0	-12.9	-13.5		-8.0	25.0	33.0
Non HT40, 6 to 54 Mbps		4	12	-12.0	-12.9	-13.5	-10.7	-6.1	24.0	30.1
HT/VHT40, M0 to M7		1	6	-1.1				-1.1	30.0	31.1



	HT/VHT40, M0 to M7	2	9	-5.7	-6.5			-3.1	27.0	30.1
	HT/VHT40, M8 to M15	2	6	-5.7	-6.5			-3.1	30.0	33.1
	HT/VHT40, M0 to M7	3	11	-5.7	-6.5	-7.9		-1.8	25.0	26.8
	HT/VHT40, M8 to M15	3	8	-5.7	-6.5	-7.9		-1.8	28.0	29.8
	HT/VHT40, M16 to M23	3	6	-5.7	-6.5	-7.9		-1.8	30.0	31.8
	HT/VHT40, M0 to M7	4	12	-5.7	-6.5	-7.9	-4.8	-0.1	24.0	24.1
	HT/VHT40, M8 to M15	4	9	-5.7	-6.5	-7.9	-4.8	-0.1	27.0	27.1
	HT/VHT40, M16 to M23	4	7	-5.7	-6.5	-7.9	-4.8	-0.1	29.0	29.1
	HT/VHT40 Beam Forming, M0 to M7	2	9	-5.7	-6.5			-3.1	27.0	30.1
	HT/VHT40 Beam Forming, M8 to M15	2	6	-5.7	-6.5			-3.1	30.0	33.1
	HT/VHT40 Beam Forming, M0 to M7	3	11	-11.8	-12.7	-13.9		-7.9	25.0	32.9
	HT/VHT40 Beam Forming, M8 to M15	3	8	-5.7	-6.5	-7.9		-1.8	28.0	29.8
	HT/VHT40 Beam Forming, M16 to M23	3	6	-5.7	-6.5	-7.9		-1.8	30.0	31.8
	HT/VHT40 Beam Forming, M0 to M7	4	12	-11.8	-12.7	-13.9	-11.3	-6.3	24.0	30.3
	HT/VHT40 Beam Forming, M8 to M15	4	9	-9.5	-11.1	-11.3	-8.6	-4.0	27.0	31.0
	HT/VHT40 Beam Forming, M16 to M23	4	7	-5.7	-6.5	-7.9	-4.8	-0.1	29.0	29.1
	HT/VHT40 STBC, M0 to M7	2	6	-5.7	-6.5			-3.1	30.0	33.1
	HT/VHT40 STBC, M0 to M7	3	8	-5.7	-6.5	-7.9		-1.8	28.0	29.8
	HT/VHT40 STBC, M0 to M7	4	9	-5.7	-6.5	-7.9	-4.8	-0.1	27.0	27.1
5775	Non HT80, 6 to 54 Mbps	1	6	-5.6				-5.6	30.0	35.6
	Non HT80, 6 to 54 Mbps	2	9	-5.6	-7.2			-3.3	27.0	30.3
	Non HT80, 6 to 54 Mbps	3	11	-8.4	-9.7	-9.9		-4.5	25.0	29.5
	Non HT80, 6 to 54 Mbps	4	12	-8.9	-11.5	-12.0	-8.8	-4.0	24.0	28.0
	VHT80, M0 to M9 1ss	1	6	-4.7				-4.7	30.0	34.7
	VHT80, M0 to M9 1ss	2	9	-7.0	-8.4			-4.6	27.0	31.6
	VHT80, M0 to M9 2ss	2	6	-7.0	-8.4			-4.6	30.0	34.6
	VHT80, M0 to M9 1ss	3	11	-8.4	-8.9	-10.0		-4.3	25.0	29.3
	VHT80, M0 to M9 2ss	3	8	-8.4	-8.9	-10.0		-4.3	28.0	32.3
	VHT80, M0 to M9 3ss	3	6	-8.4	-8.9	-10.0		-4.3	30.0	34.3
	VHT80, M0 to M9 1ss	4	12	-8.4	-8.9	-10.0	-7.8	-2.7	24.0	26.7
	VHT80, M0 to M9 2ss	4	9	-8.4	-8.9	-10.0	-7.8	-2.7	27.0	29.7
	VHT80, M0 to M9 3ss	4	7	-8.4	-8.9	-10.0	-7.8	-2.7	29.0	31.7
	VHT80 Beam Forming, M0 to M9 1ss	2	9	-8.4	-8.9			-5.6	27.0	32.6
	VHT80 Beam Forming, M0 to M9 2ss	2	6	-7.0	-8.4			-4.6	30.0	34.6
	VHT80 Beam Forming, M0 to M9 1ss	3	11	-12.0	-13.4	-14.0		-8.3	25.0	33.3
	VHT80 Beam Forming, M0 to M9 2ss	3	8	-8.4	-8.9	-10.0		-4.3	28.0	32.3
	VHT80 Beam Forming, M0 to M9 3ss	3	6	-8.4	-8.9	-10.0		-4.3	30.0	34.3
	VHT80 Beam Forming, M0 to M9 1ss	4	12	-13.9	-15.4	-15.9	-13.6	-8.6	24.0	32.6
	VHT80 Beam Forming, M0 to M9 2ss	4	9	-10.0	-11.3	-11.9	-9.7	-4.6	27.0	31.6
VHT80 Beam Forming, M0 to M9 3ss	4	7	-8.4	-8.9	-10.0	-7.8	-2.7	29.0	31.7	



	VHT80 STBC, M0 to M9 1ss	2	6	-7.0	-8.4			-4.6	30.0	34.6
	VHT80 STBC, M0 to M9 1ss	3	6	-8.4	-8.9	-10.0		-4.3	30.0	34.3
	VHT80 STBC, M0 to M9 1ss	4	6	-8.4	-8.9	-10.0	-7.8	-2.7	30.0	32.7
5785	Non HT20, 6 to 54 Mbps	1	6	0.7				0.7	30.0	29.3
	Non HT20, 6 to 54 Mbps	2	9	0.7	0.5			3.6	27.0	23.4
	Non HT20, 6 to 54 Mbps	3	11	0.7	0.5	0.7		5.4	25.0	19.6
	Non HT20, 6 to 54 Mbps	4	12	0.7	0.5	0.7	2.3	7.1	24.0	16.9
	Non HT20 Beam Forming, 6 to 54 Mbps	2	9	0.7	0.5			3.6	27.0	23.4
	Non HT20 Beam Forming, 6 to 54 Mbps	3	11	0.7	0.5	0.7		5.4	25.0	19.6
	Non HT20 Beam Forming, 6 to 54 Mbps	4	12	0.7	0.5	0.7	2.3	7.1	24.0	16.9
	HT/VHT20, M0 to M7	1	6	0.9				0.9	30.0	29.1
	HT/VHT20, M0 to M7	2	9	0.9	0.7			3.8	27.0	23.2
	HT/VHT20, M8 to M15	2	6	0.9	0.7			3.8	30.0	26.2
	HT/VHT20, M0 to M7	3	11	0.9	0.7	0.3		5.4	25.0	19.6
	HT/VHT20, M8 to M15	3	8	0.9	0.7	0.3		5.4	28.0	22.6
	HT/VHT20, M16 to M23	3	6	0.9	0.7	0.3		5.4	30.0	24.6
	HT/VHT20, M0 to M7	4	12	0.9	0.7	0.3	2.4	7.2	24.0	16.8
	HT/VHT20, M8 to M15	4	9	0.9	0.7	0.3	2.4	7.2	27.0	19.8
	HT/VHT20, M16 to M23	4	7	0.9	0.7	0.3	2.4	7.2	29.0	21.8
	HT/VHT20 Beam Forming, M0 to M7	2	9	0.9	0.7			3.8	27.0	23.2
	HT/VHT20 Beam Forming, M8 to M15	2	6	0.9	0.7			3.8	30.0	26.2
	HT/VHT20 Beam Forming, M0 to M7	3	11	0.9	0.7	0.3		5.4	25.0	19.6
	HT/VHT20 Beam Forming, M8 to M15	3	8	0.9	0.7	0.3		5.4	28.0	22.6
	HT/VHT20 Beam Forming, M16 to M23	3	6	0.9	0.7	0.3		5.4	30.0	24.6
	HT/VHT20 Beam Forming, M0 to M7	4	12	0.9	0.7	0.3	2.4	7.2	24.0	16.8
	HT/VHT20 Beam Forming, M8 to M15	4	9	0.9	0.7	0.3	2.4	7.2	27.0	19.8
	HT/VHT20 Beam Forming, M16 to M23	4	7	0.9	0.7	0.3	2.4	7.2	29.0	21.8
	HT/VHT20 STBC, M0 to M7	2	6	0.9	0.7			3.8	30.0	26.2
	HT/VHT20 STBC, M0 to M7	3	8	0.9	0.7	0.3		5.4	28.0	22.6
	HT/VHT20 STBC, M0 to M7	4	9	0.9	0.7	0.3	2.4	7.2	27.0	19.8
	5795	Non HT40, 6 to 54 Mbps	1	6	-2.3				-2.3	30.0
Non HT40, 6 to 54 Mbps		2	9	-2.3	-1.9			0.9	27.0	26.1
Non HT40, 6 to 54 Mbps		3	11	-2.3	-1.9	-1.5		2.9	25.0	22.1
Non HT40, 6 to 54 Mbps		4	12	-2.3	-1.9	-1.5	-0.3	4.6	24.0	19.4
HT/VHT40, M0 to M7		1	6	-2.5				-2.5	30.0	32.5
HT/VHT40, M0 to M7		2	9	-2.5	-3.2			0.2	27.0	26.8
HT/VHT40, M8 to M15		2	6	-2.5	-3.2			0.2	30.0	29.8
HT/VHT40, M0 to M7		3	11	-2.5	-3.2	-2.7		2.0	25.0	23.0
HT/VHT40, M8 to M15		3	8	-2.5	-3.2	-2.7		2.0	28.0	26.0



	HT/VHT40, M16 to M23	3	6	-2.5	-3.2	-2.7		2.0	30.0	28.0
	HT/VHT40, M0 to M7	4	12	-2.5	-3.2	-2.7	-0.6	3.9	24.0	20.1
	HT/VHT40, M8 to M15	4	9	-2.5	-3.2	-2.7	-0.6	3.9	27.0	23.1
	HT/VHT40, M16 to M23	4	7	-2.5	-3.2	-2.7	-0.6	3.9	29.0	25.1
	HT/VHT40 Beam Forming, M0 to M7	2	9	-2.5	-3.2			0.2	27.0	26.8
	HT/VHT40 Beam Forming, M8 to M15	2	6	-2.5	-3.2			0.2	30.0	29.8
	HT/VHT40 Beam Forming, M0 to M7	3	11	-2.5	-3.2	-2.7		2.0	25.0	23.0
	HT/VHT40 Beam Forming, M8 to M15	3	8	-2.5	-3.2	-2.7		2.0	28.0	26.0
	HT/VHT40 Beam Forming, M16 to M23	3	6	-2.5	-3.2	-2.7		2.0	30.0	28.0
	HT/VHT40 Beam Forming, M0 to M7	4	12	-2.5	-3.2	-2.7	-0.6	3.9	24.0	20.1
	HT/VHT40 Beam Forming, M8 to M15	4	9	-2.5	-3.2	-2.7	-0.6	3.9	27.0	23.1
	HT/VHT40 Beam Forming, M16 to M23	4	7	-2.5	-3.2	-2.7	-0.6	3.9	29.0	25.1
	HT/VHT40 STBC, M0 to M7	2	6	-2.5	-3.2			0.2	30.0	29.8
	HT/VHT40 STBC, M0 to M7	3	8	-2.5	-3.2	-2.7		2.0	28.0	26.0
	HT/VHT40 STBC, M0 to M7	4	9	-2.5	-3.2	-2.7	-0.6	3.9	27.0	23.1
	Non HT20, 6 to 54 Mbps	1	6	1.6				1.6	30.0	28.4
	Non HT20, 6 to 54 Mbps	2	9	1.6	0.6			4.1	27.0	22.9
	Non HT20, 6 to 54 Mbps	3	11	1.6	0.6	0.0		5.6	25.0	19.4
	Non HT20, 6 to 54 Mbps	4	12	1.6	0.6	0.0	2.3	7.2	24.0	16.8
	Non HT20 Beam Forming, 6 to 54 Mbps	2	9	1.6	0.6			4.1	27.0	22.9
	Non HT20 Beam Forming, 6 to 54 Mbps	3	11	0.2	-0.5	0.3		4.8	25.0	20.2
	Non HT20 Beam Forming, 6 to 54 Mbps	4	12	-3.4	-3.7	-3.2	-2.0	3.0	24.0	21.0
	HT/VHT20, M0 to M7	1	6	1.5				1.5	30.0	28.5
	HT/VHT20, M0 to M7	2	9	1.5	0.8			4.2	27.0	22.8
	HT/VHT20, M8 to M15	2	6	1.5	0.8			4.2	30.0	25.8
	HT/VHT20, M0 to M7	3	11	1.5	0.8	0.0		5.6	25.0	19.4
	HT/VHT20, M8 to M15	3	8	1.5	0.8	0.0		5.6	28.0	22.4
	HT/VHT20, M16 to M23	3	6	1.5	0.8	0.0		5.6	30.0	24.4
	<b>HT/VHT20, M0 to M7</b>	<b>4</b>	<b>12</b>	<b>1.5</b>	<b>0.8</b>	<b>0.0</b>	<b>2.4</b>	<b>7.3</b>	<b>24.0</b>	<b>16.7</b>
	HT/VHT20, M8 to M15	4	9	1.5	0.8	0.0	2.4	7.3	27.0	19.7
	HT/VHT20, M16 to M23	4	7	1.5	0.8	0.0	2.4	7.3	29.0	21.7
	HT/VHT20 Beam Forming, M0 to M7	2	9	1.5	0.8			4.2	27.0	22.8
	HT/VHT20 Beam Forming, M8 to M15	2	6	1.5	0.8			4.2	30.0	25.8
	HT/VHT20 Beam Forming, M0 to M7	3	11	-0.9	-1.6	-0.8		3.7	25.0	21.3
	HT/VHT20 Beam Forming, M8 to M15	3	8	1.5	0.8	0.0		5.6	28.0	22.4
	HT/VHT20 Beam Forming, M16 to M23	3	6	1.5	0.8	0.0		5.6	30.0	24.4
	HT/VHT20 Beam Forming, M0 to M7	4	12	-3.7	-4.0	-3.4	-2.1	2.8	24.0	21.2
	HT/VHT20 Beam Forming, M8 to M15	4	9	0.3	-0.6	0.1	1.3	6.3	27.0	20.7
	HT/VHT20 Beam Forming, M16 to M23	4	7	1.5	0.8	0.0	2.4	7.3	29.0	21.7
	HT/VHT20 STBC, M0 to M7	2	6	1.5	0.8			4.2	30.0	25.8





HT/VHT20 STBC, M0 to M7	3	8	1.5	0.8	0.0		5.6	28.0	22.4
HT/VHT20 STBC, M0 to M7	4	9	1.5	0.8	0.0	2.4	7.3	27.0	19.7



**Power Spectral Density, 5825 MHz, HT/VHT20, M0 to M7**

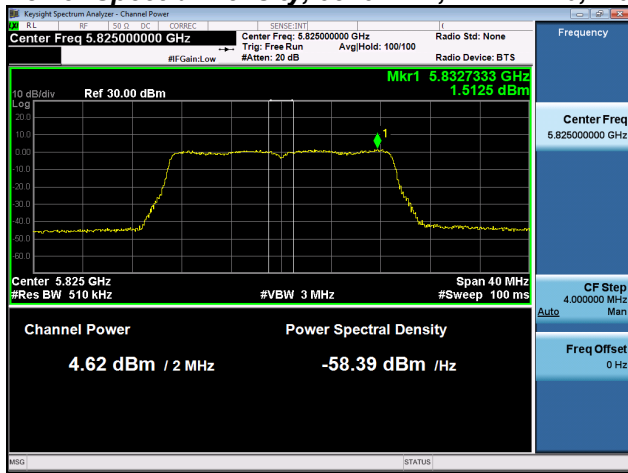

**Antenna A**

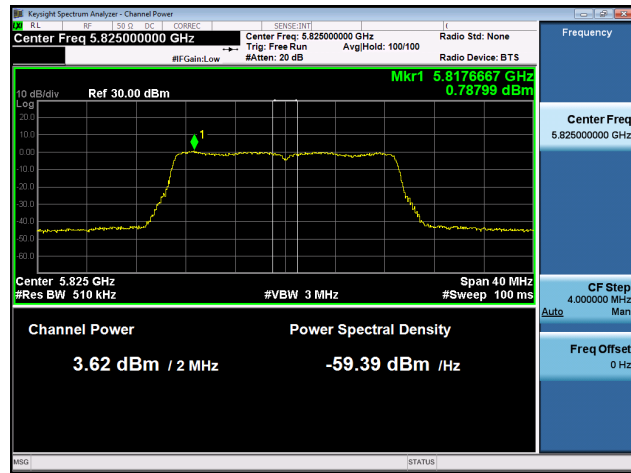

**Antenna B**

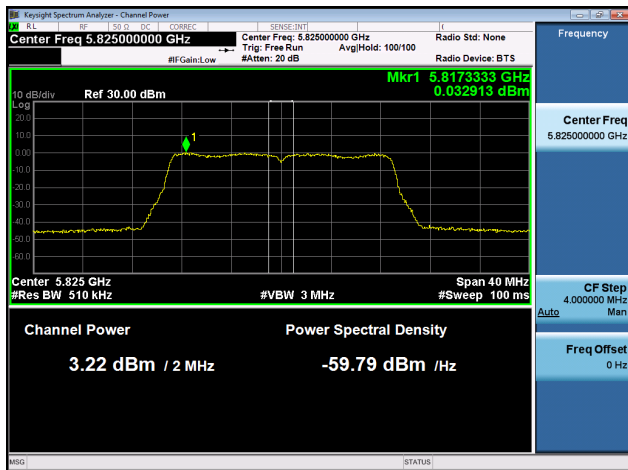

**Antenna C**

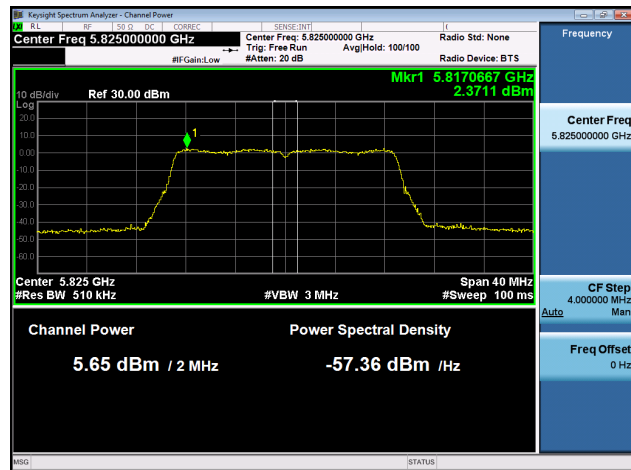

**Antenna D**



## Antenna Gain : 8 dBi

Frequency (MHz)	Mode	Tx Paths	Correlated Antenna Gain (dBi)	Tx 1 PSD (dBm/MHz)	Tx 2 PSD (dBm/MHz)	Tx 3 PSD (dBm/MHz)	Tx 4 PSD (dBm/MHz)	Total PSD (dBm/500MHz)	Limit (dBm/500MHz)	Margin (dB)
5745	Non HT20, 6 to 54 Mbps	1	8	0.4				0.4	28.0	27.6
	Non HT20, 6 to 54 Mbps	2	11	-2.8	-3.9			-0.3	25.0	25.3
	Non HT20, 6 to 54 Mbps	3	13	-2.8	-3.9	-4.7		1.0	23.0	22.0
	Non HT20, 6 to 54 Mbps	4	14	-2.8	-3.9	-4.7	-2.3	2.7	22.0	19.3
	Non HT20 Beam Forming, 6 to 54 Mbps	2	11	-5.8	-6.3			-3.0	25.0	28.0
	Non HT20 Beam Forming, 6 to 54 Mbps	3	13	-6.5	-7.8	-8.7		-2.8	23.0	25.8
	Non HT20 Beam Forming, 6 to 54 Mbps	4	14	-8.6	-9.7	-10.7	-8.0	-3.1	22.0	25.1
	HT/VHT20, M0 to M7	1	8	0.1				0.1	28.0	27.9
	HT/VHT20, M0 to M7	2	11	-3.0	-3.8			-0.4	25.0	25.4
	HT/VHT20, M8 to M15	2	8	-3.0	-3.8			-0.4	28.0	28.4
	HT/VHT20, M0 to M7	3	13	-3.0	-3.8	-4.3		1.1	23.0	21.9
	HT/VHT20, M8 to M15	3	10	-3.0	-3.8	-4.3		1.1	26.0	24.9
	HT/VHT20, M16 to M23	3	8	-3.0	-3.8	-4.3		1.1	28.0	26.9
	HT/VHT20, M0 to M7	4	14	-3.0	-3.8	-4.3	-2.2	2.8	22.0	19.2
	HT/VHT20, M8 to M15	4	11	-3.0	-3.8	-4.3	-2.2	2.8	25.0	22.2
	HT/VHT20, M16 to M23	4	9	-3.0	-3.8	-4.3	-2.2	2.8	27.0	24.2
	HT/VHT20 Beam Forming, M0 to M7	2	11	-6.0	-6.5			-3.2	25.0	28.2
	HT/VHT20 Beam Forming, M8 to M15	2	8	-3.0	-3.8			-0.4	28.0	28.4
	HT/VHT20 Beam Forming, M0 to M7	3	13	-7.8	-8.5	-9.5		-3.8	23.0	26.8
	HT/VHT20 Beam Forming, M8 to M15	3	10	-4.6	-5.4	-6.6		-0.7	26.0	26.7
	HT/VHT20 Beam Forming, M16 to M23	3	8	-3.0	-3.8	-4.3		1.1	28.0	26.9
	HT/VHT20 Beam Forming, M0 to M7	4	14	-8.6	-9.8	-10.9	-8.3	-3.3	22.0	25.3
	HT/VHT20 Beam Forming, M8 to M15	4	11	-6.5	-7.5	-8.7	-6.0	-1.0	25.0	26.0
	HT/VHT20 Beam Forming, M16 to M23	4	9	-4.6	-5.4	-6.6	-4.4	0.9	27.0	26.1
	HT/VHT20 STBC, M0 to M7	2	8	-3.0	-3.8			-0.4	28.0	28.4
	HT/VHT20 STBC, M0 to M7	3	10	-3.0	-3.8	-4.3		1.1	26.0	24.9
	HT/VHT20 STBC, M0 to M7	4	11	-3.0	-3.8	-4.3	-2.2	2.8	25.0	22.2
	5755	Non HT40, 6 to 54 Mbps	1	8	-5.8				-5.8	28.0
Non HT40, 6 to 54 Mbps		2	11	-12.0	-12.9			-9.4	25.0	34.4
Non HT40, 6 to 54 Mbps		3	13	-12.7	-13.9	-15.0		-9.0	23.0	32.0
Non HT40, 6 to 54 Mbps		4	14	-12.7	-13.9	-15.0	-12.3	-7.3	22.0	29.3
HT/VHT40, M0 to M7		1	8	-5.7				-5.7	28.0	33.7



	HT/VHT40, M0 to M7	2	11	-5.7	-6.5			-3.1	25.0	28.1
	HT/VHT40, M8 to M15	2	8	-5.7	-6.5			-3.1	28.0	31.1
	HT/VHT40, M0 to M7	3	13	-5.7	-6.5	-7.9		-1.8	23.0	24.8
	HT/VHT40, M8 to M15	3	10	-5.7	-6.5	-7.9		-1.8	26.0	27.8
	HT/VHT40, M16 to M23	3	8	-5.7	-6.5	-7.9		-1.8	28.0	29.8
	HT/VHT40, M0 to M7	4	14	-9.5	-11.1	-11.3	-8.6	-4.0	22.0	26.0
	HT/VHT40, M8 to M15	4	11	-9.5	-11.1	-11.3	-8.6	-4.0	25.0	29.0
	HT/VHT40, M16 to M23	4	9	-9.5	-11.1	-11.3	-8.6	-4.0	27.0	31.0
	HT/VHT40 Beam Forming, M0 to M7	2	11	-11.8	-12.7			-9.2	25.0	34.2
	HT/VHT40 Beam Forming, M8 to M15	2	8	-5.7	-6.5			-3.1	28.0	31.1
	HT/VHT40 Beam Forming, M0 to M7	3	13	-11.8	-12.7	-13.9		-7.9	23.0	30.9
	HT/VHT40 Beam Forming, M8 to M15	3	10	-10.6	-12.1	-12.5		-6.9	26.0	32.9
	HT/VHT40 Beam Forming, M16 to M23	3	8	-5.7	-6.5	-7.9		-1.8	28.0	29.8
	HT/VHT40 Beam Forming, M0 to M7	4	14	-12.5	-13.5	-14.6	-12.0	-7.0	22.0	29.0
	HT/VHT40 Beam Forming, M8 to M15	4	11	-11.8	-12.7	-13.9	-11.3	-6.3	25.0	31.3
	HT/VHT40 Beam Forming, M16 to M23	4	9	-9.5	-11.1	-11.3	-8.6	-4.0	27.0	31.0
	HT/VHT40 STBC, M0 to M7	2	8	-5.7	-6.5			-3.1	28.0	31.1
	HT/VHT40 STBC, M0 to M7	3	10	-5.7	-6.5	-7.9		-1.8	26.0	27.8
	HT/VHT40 STBC, M0 to M7	4	11	-9.5	-11.1	-11.3	-8.6	-4.0	25.0	29.0
5775	Non HT80, 6 to 54 Mbps	1	8	-5.6				-5.6	28.0	33.6
	Non HT80, 6 to 54 Mbps	2	11	-8.4	-9.7			-6.0	25.0	31.0
	Non HT80, 6 to 54 Mbps	3	13	-8.2	-10.2	-11.1		-4.9	23.0	27.9
	Non HT80, 6 to 54 Mbps	4	14	-13.1	-13.8	-14.5	-12.5	-7.4	22.0	29.4
	VHT80, M0 to M9 1ss	1	8	-7.0				-7.0	28.0	35.0
	VHT80, M0 to M9 1ss	2	11	-8.4	-8.9			-5.6	25.0	30.6
	VHT80, M0 to M9 2ss	2	8	-8.4	-8.9			-5.6	28.0	33.6
	VHT80, M0 to M9 1ss	3	13	-8.4	-8.9	-10.0		-4.3	23.0	27.3
	VHT80, M0 to M9 2ss	3	10	-8.4	-8.9	-10.0		-4.3	26.0	30.3
	VHT80, M0 to M9 3ss	3	8	-8.4	-8.9	-10.0		-4.3	28.0	32.3
	VHT80, M0 to M9 1ss	4	14	-8.4	-8.9	-10.0	-7.8	-2.7	22.0	24.7
	VHT80, M0 to M9 2ss	4	11	-8.4	-8.9	-10.0	-7.8	-2.7	25.0	27.7
	VHT80, M0 to M9 3ss	4	9	-8.4	-8.9	-10.0	-7.8	-2.7	27.0	29.7
	VHT80 Beam Forming, M0 to M9 1ss	2	11	-10.0	-11.3			-7.6	25.0	32.6
	VHT80 Beam Forming, M0 to M9 2ss	2	8	-8.4	-8.9			-5.6	28.0	33.6
	VHT80 Beam Forming, M0 to M9 1ss	3	13	-15.0	-16.5	-16.9		-11.3	23.0	34.3
	VHT80 Beam Forming, M0 to M9 2ss	3	10	-10.0	-11.3	-11.9		-6.2	26.0	32.2
	VHT80 Beam Forming, M0 to M9 3ss	3	8	-8.4	-8.9	-10.0		-4.3	28.0	32.3
	VHT80 Beam Forming, M0 to M9 1ss	4	14	-15.0	-16.5	-16.9	-14.4	-9.6	22.0	31.6
	VHT80 Beam Forming, M0 to M9 2ss	4	11	-13.0	-14.3	-14.9	-12.5	-7.5	25.0	32.5
VHT80 Beam Forming, M0 to M9 3ss	4	9	-10.0	-11.3	-11.9	-9.7	-4.6	27.0	31.6	



	VHT80 STBC, M0 to M9 1ss	2	8	-8.4	-8.9			-5.6	28.0	33.6
	VHT80 STBC, M0 to M9 1ss	3	8	-8.4	-8.9	-10.0		-4.3	28.0	32.3
	VHT80 STBC, M0 to M9 1ss	4	8	-8.4	-8.9	-10.0	-7.8	-2.7	28.0	30.7
5785	Non HT20, 6 to 54 Mbps	1	8	0.7				0.7	28.0	27.3
	Non HT20, 6 to 54 Mbps	2	11	0.7	0.5			3.6	25.0	21.4
	Non HT20, 6 to 54 Mbps	3	13	0.7	0.5	0.7		5.4	23.0	17.6
	Non HT20, 6 to 54 Mbps	4	14	0.7	0.5	0.7	2.3	7.1	22.0	14.9
	Non HT20 Beam Forming, 6 to 54 Mbps	2	11	0.7	0.5			3.6	25.0	21.4
	Non HT20 Beam Forming, 6 to 54 Mbps	3	13	0.7	0.5	0.7		5.4	23.0	17.6
	Non HT20 Beam Forming, 6 to 54 Mbps	4	14	-0.5	-0.5	0.2	1.5	6.3	22.0	15.7
	HT/VHT20, M0 to M7	1	8	0.9				0.9	28.0	27.1
	HT/VHT20, M0 to M7	2	11	0.9	0.7			3.8	25.0	21.2
	HT/VHT20, M8 to M15	2	8	0.9	0.7			3.8	28.0	24.2
	HT/VHT20, M0 to M7	3	13	0.9	0.7	0.3		5.4	23.0	17.6
	HT/VHT20, M8 to M15	3	10	0.9	0.7	0.3		5.4	26.0	20.6
	HT/VHT20, M16 to M23	3	8	0.9	0.7	0.3		5.4	28.0	22.6
	HT/VHT20, M0 to M7	4	14	0.9	0.7	0.3	2.4	7.2	22.0	14.8
	HT/VHT20, M8 to M15	4	11	0.9	0.7	0.3	2.4	7.2	25.0	17.8
	HT/VHT20, M16 to M23	4	9	0.9	0.7	0.3	2.4	7.2	27.0	19.8
	HT/VHT20 Beam Forming, M0 to M7	2	11	0.9	0.7			3.8	25.0	21.2
	HT/VHT20 Beam Forming, M8 to M15	2	8	0.9	0.7			3.8	28.0	24.2
	HT/VHT20 Beam Forming, M0 to M7	3	13	0.9	0.7	0.3		5.4	23.0	17.6
	HT/VHT20 Beam Forming, M8 to M15	3	10	0.9	0.7	0.3		5.4	26.0	20.6
	HT/VHT20 Beam Forming, M16 to M23	3	8	0.9	0.7	0.3		5.4	28.0	22.6
	HT/VHT20 Beam Forming, M0 to M7	4	14	-0.5	-0.4	0.5	1.2	6.3	22.0	15.7
	HT/VHT20 Beam Forming, M8 to M15	4	11	0.9	0.7	0.3	2.4	7.2	25.0	17.8
	HT/VHT20 Beam Forming, M16 to M23	4	9	0.9	0.7	0.3	2.4	7.2	27.0	19.8
	HT/VHT20 STBC, M0 to M7	2	8	0.9	0.7			3.8	28.0	24.2
	HT/VHT20 STBC, M0 to M7	3	10	0.9	0.7	0.3		5.4	26.0	20.6
	HT/VHT20 STBC, M0 to M7	4	11	0.9	0.7	0.3	2.4	7.2	25.0	17.8
	5795	Non HT40, 6 to 54 Mbps	1	8	-2.3				-2.3	28.0
Non HT40, 6 to 54 Mbps		2	11	-2.3	-1.9			0.9	25.0	24.1
Non HT40, 6 to 54 Mbps		3	13	-2.3	-1.9	-1.5		2.9	23.0	20.1
Non HT40, 6 to 54 Mbps		4	14	-2.3	-1.9	-1.5	-0.3	4.6	22.0	17.4
HT/VHT40, M0 to M7		1	8	-2.5				-2.5	28.0	30.5
HT/VHT40, M0 to M7		2	11	-2.5	-3.2			0.2	25.0	24.8
HT/VHT40, M8 to M15		2	8	-2.5	-3.2			0.2	28.0	27.8
HT/VHT40, M0 to M7		3	13	-2.5	-3.2	-2.7		2.0	23.0	21.0
HT/VHT40, M8 to M15		3	10	-2.5	-3.2	-2.7		2.0	26.0	24.0



	HT/VHT40, M16 to M23	3	8	-2.5	-3.2	-2.7		2.0	28.0	26.0
	HT/VHT40, M0 to M7	4	14	-2.5	-3.2	-2.7	-0.6	3.9	22.0	18.1
	HT/VHT40, M8 to M15	4	11	-2.5	-3.2	-2.7	-0.6	3.9	25.0	21.1
	HT/VHT40, M16 to M23	4	9	-2.5	-3.2	-2.7	-0.6	3.9	27.0	23.1
	HT/VHT40 Beam Forming, M0 to M7	2	11	-2.5	-3.2			0.2	25.0	24.8
	HT/VHT40 Beam Forming, M8 to M15	2	8	-2.5	-3.2			0.2	28.0	27.8
	HT/VHT40 Beam Forming, M0 to M7	3	13	-2.5	-3.2	-2.7		2.0	23.0	21.0
	HT/VHT40 Beam Forming, M8 to M15	3	10	-2.5	-3.2	-2.7		2.0	26.0	24.0
	HT/VHT40 Beam Forming, M16 to M23	3	8	-2.5	-3.2	-2.7		2.0	28.0	26.0
	HT/VHT40 Beam Forming, M0 to M7	4	14	-4.7	-4.2	-3.7	-3.1	2.1	22.0	19.9
	HT/VHT40 Beam Forming, M8 to M15	4	11	-2.5	-3.2	-2.7	-0.6	3.9	25.0	21.1
	HT/VHT40 Beam Forming, M16 to M23	4	9	-2.5	-3.2	-2.7	-0.6	3.9	27.0	23.1
	HT/VHT40 STBC, M0 to M7	2	8	-2.5	-3.2			0.2	28.0	27.8
	HT/VHT40 STBC, M0 to M7	3	10	-2.5	-3.2	-2.7		2.0	26.0	24.0
	HT/VHT40 STBC, M0 to M7	4	11	-2.5	-3.2	-2.7	-0.6	3.9	25.0	21.1
	Non HT20, 6 to 54 Mbps	1	8	1.6				1.6	28.0	26.4
	Non HT20, 6 to 54 Mbps	2	11	1.6	0.6			4.1	25.0	20.9
	Non HT20, 6 to 54 Mbps	3	13	1.6	0.6	0.0		5.6	23.0	17.4
	Non HT20, 6 to 54 Mbps	4	14	1.6	0.6	0.0	2.3	7.2	22.0	14.8
	Non HT20 Beam Forming, 6 to 54 Mbps	2	11	1.6	0.6			4.1	25.0	20.9
	Non HT20 Beam Forming, 6 to 54 Mbps	3	13	-1.6	-3.0	-2.4		2.5	23.0	20.5
	Non HT20 Beam Forming, 6 to 54 Mbps	4	14	-5.3	-5.6	-5.3	-4.4	0.9	22.0	21.1
	HT/VHT20, M0 to M7	1	8	1.5				1.5	28.0	26.5
	HT/VHT20, M0 to M7	2	11	1.5	0.8			4.2	25.0	20.8
	HT/VHT20, M8 to M15	2	8	1.5	0.8			4.2	28.0	23.8
	HT/VHT20, M0 to M7	3	13	1.5	0.8	0.0		5.6	23.0	17.4
	HT/VHT20, M8 to M15	3	10	1.5	0.8	0.0		5.6	26.0	20.4
	HT/VHT20, M16 to M23	3	8	1.5	0.8	0.0		5.6	28.0	22.4
	<b>HT/VHT20, M0 to M7</b>	<b>4</b>	<b>14</b>	<b>1.5</b>	<b>0.8</b>	<b>0.0</b>	<b>2.4</b>	<b>7.3</b>	<b>22.0</b>	<b>14.7</b>
	HT/VHT20, M8 to M15	4	11	1.5	0.8	0.0	2.4	7.3	25.0	17.7
	HT/VHT20, M16 to M23	4	9	1.5	0.8	0.0	2.4	7.3	27.0	19.7
	HT/VHT20 Beam Forming, M0 to M7	2	11	1.5	0.8			4.2	25.0	20.8
	HT/VHT20 Beam Forming, M8 to M15	2	8	1.5	0.8			4.2	28.0	23.8
	HT/VHT20 Beam Forming, M0 to M7	3	13	-2.4	-2.8	-2.5		2.2	23.0	20.8
	HT/VHT20 Beam Forming, M8 to M15	3	10	1.5	0.8	0.0		5.6	26.0	20.4
	HT/VHT20 Beam Forming, M16 to M23	3	8	1.5	0.8	0.0		5.6	28.0	22.4
	HT/VHT20 Beam Forming, M0 to M7	4	14	-4.7	-4.3	-4.0	-3.4	1.9	22.0	20.1
	HT/VHT20 Beam Forming, M8 to M15	4	11	-2.4	-2.8	-2.5	-1.3	3.8	25.0	21.2
	HT/VHT20 Beam Forming, M16 to M23	4	9	0.3	-0.6	0.1	1.3	6.3	27.0	20.7
	HT/VHT20 STBC, M0 to M7	2	8	1.5	0.8			4.2	28.0	23.8



HT/VHT20 STBC, M0 to M7	3	10	1.5	0.8	0.0		5.6	26.0	20.4
HT/VHT20 STBC, M0 to M7	4	11	1.5	0.8	0.0	2.4	7.3	25.0	17.7

**Power Spectral Density, 5825 MHz, HT/VHT20, M0 to M7**

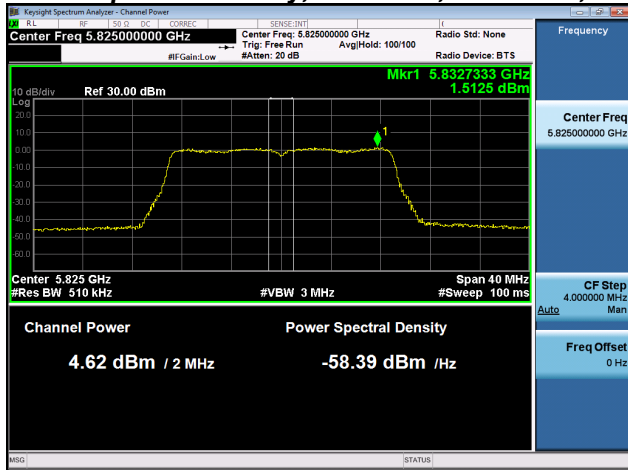

**Antenna A**

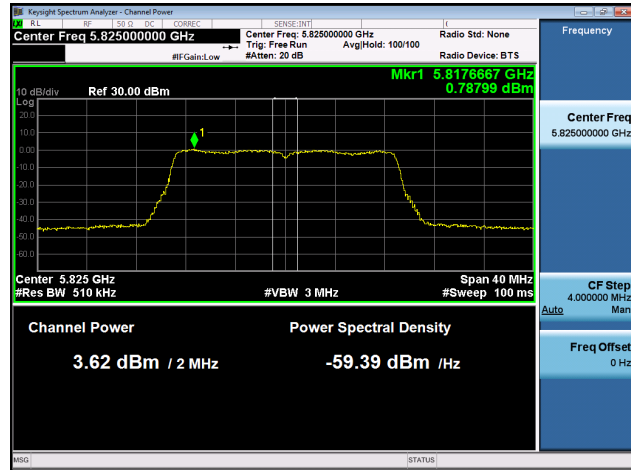

**Antenna B**

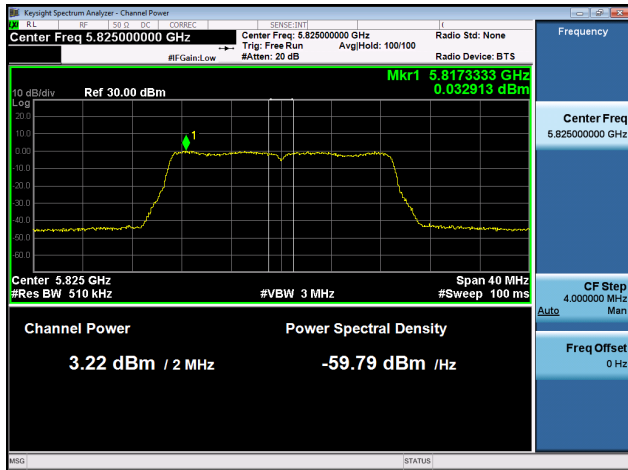

**Antenna C**

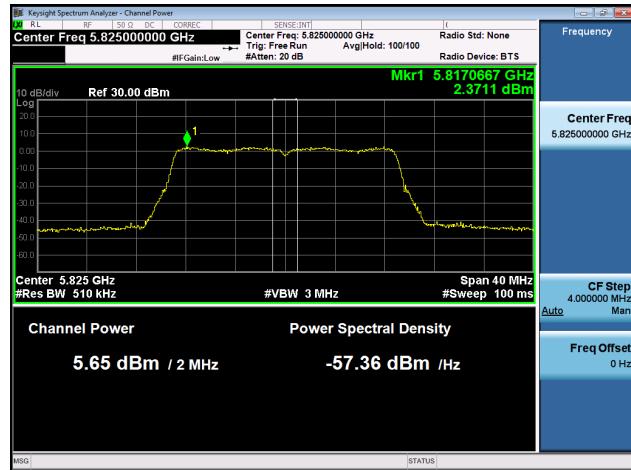

**Antenna D**



## Antenna Gain : 13 dBi

Frequency (MHz)	Mode	Tx Paths	Correlated Antenna Gain (dBi)	Tx 1 PSD (dBm/MHz)	Tx 2 PSD (dBm/MHz)	Tx 3 PSD (dBm/MHz)	Tx 4 PSD (dBm/MHz)	Total PSD (dBm/500MHz)	Limit (dBm/500MHz)	Margin (dB)
5745	Non HT20, 6 to 54 Mbps	1	13	-4.6				-4.6	30.0	34.6
	Non HT20, 6 to 54 Mbps	2	16	-6.5	-7.8			-4.1	30.0	34.1
	Non HT20, 6 to 54 Mbps	3	18	-6.5	-7.8	-8.7		-2.8	30.0	32.8
	Non HT20, 6 to 54 Mbps	4	19	-7.6	-8.9	-9.5	-7.2	-2.2	30.0	32.2
	Non HT20 Beam Forming, 6 to 54 Mbps	2	16	-6.5	-7.8			-4.1	30.0	34.1
	Non HT20 Beam Forming, 6 to 54 Mbps	3	18	-9.5	-10.7	-11.7		-5.8	30.0	35.8
	Non HT20 Beam Forming, 6 to 54 Mbps	4	19	-9.5	-10.7	-11.7	-8.9	-4.0	30.0	34.0
	HT/VHT20, M0 to M7	1	13	-4.6				-4.6	30.0	34.6
	HT/VHT20, M0 to M7	2	16	-7.8	-8.5			-5.1	30.0	35.1
	HT/VHT20, M8 to M15	2	13	-7.8	-8.5			-5.1	30.0	35.1
	HT/VHT20, M0 to M7	3	18	-7.8	-8.5	-9.5		-3.8	30.0	33.8
	HT/VHT20, M8 to M15	3	15	-7.8	-8.5	-9.5		-3.8	30.0	33.8
	HT/VHT20, M16 to M23	3	13	-7.8	-8.5	-9.5		-3.8	30.0	33.8
	HT/VHT20, M0 to M7	4	19	-7.8	-8.5	-9.5	-7.3	-2.2	30.0	32.2
	HT/VHT20, M8 to M15	4	16	-7.8	-8.5	-9.5	-7.3	-2.2	30.0	32.2
	HT/VHT20, M16 to M23	4	14	-7.8	-8.5	-9.5	-7.3	-2.2	30.0	32.2
	HT/VHT20 Beam Forming, M0 to M7	2	16	-7.8	-8.5			-5.1	30.0	35.1
	HT/VHT20 Beam Forming, M8 to M15	2	13	-7.8	-8.5			-5.1	30.0	35.1
	HT/VHT20 Beam Forming, M0 to M7	3	18	-8.6	-9.8	-10.9		-4.9	30.0	34.9
	HT/VHT20 Beam Forming, M8 to M15	3	15	-7.8	-8.5	-9.5		-3.8	30.0	33.8
	HT/VHT20 Beam Forming, M16 to M23	3	13	-7.8	-8.5	-9.5		-3.8	30.0	33.8
	HT/VHT20 Beam Forming, M0 to M7	4	19	-9.5	-10.5	-11.4	-9.1	-4.0	30.0	34.0
	HT/VHT20 Beam Forming, M8 to M15	4	16	-7.8	-8.5	-9.5	-7.3	-2.2	30.0	32.2
	HT/VHT20 Beam Forming, M16 to M23	4	14	-7.8	-8.5	-9.5	-7.3	-2.2	30.0	32.2
	HT/VHT20 STBC, M0 to M7	2	13	-7.8	-8.5			-5.1	30.0	35.1
	HT/VHT20 STBC, M0 to M7	3	15	-7.8	-8.5	-9.5		-3.8	30.0	33.8
	HT/VHT20 STBC, M0 to M7	4	16	-7.8	-8.5	-9.5	-7.3	-2.2	30.0	32.2
	5755	Non HT40, 6 to 54 Mbps	1	13	-12.7				-12.7	30.0
Non HT40, 6 to 54 Mbps		2	16	-16.0	-17.2			-13.5	30.0	43.5
Non HT40, 6 to 54 Mbps		3	18	-18.0	-19.1	-19.6		-14.1	30.0	44.1
Non HT40, 6 to 54 Mbps		4	19	-18.0	-19.1	-19.6	-17.5	-12.4	30.0	42.4
HT/VHT40, M0 to M7		1	13	-11.8				-11.8	30.0	41.8





	HT/VHT40, M0 to M7	2	16	-11.8	-12.7			-9.2	30.0	39.2
	HT/VHT40, M8 to M15	2	13	-11.8	-12.7			-9.2	30.0	39.2
	HT/VHT40, M0 to M7	3	18	-11.8	-12.7	-13.9		-7.9	30.0	37.9
	HT/VHT40, M8 to M15	3	15	-11.8	-12.7	-13.9		-7.9	30.0	37.9
	HT/VHT40, M16 to M23	3	13	-11.8	-12.7	-13.9		-7.9	30.0	37.9
	HT/VHT40, M0 to M7	4	19	-12.5	-13.5	-14.6	-12.0	-7.0	30.0	37.0
	HT/VHT40, M8 to M15	4	16	-12.5	-13.5	-14.6	-12.0	-7.0	30.0	37.0
	HT/VHT40, M16 to M23	4	14	-12.5	-13.5	-14.6	-12.0	-7.0	30.0	37.0
	HT/VHT40 Beam Forming, M0 to M7	2	16	-11.8	-12.7			-9.2	30.0	39.2
	HT/VHT40 Beam Forming, M8 to M15	2	13	-11.8	-12.7			-9.2	30.0	39.2
	HT/VHT40 Beam Forming, M0 to M7	3	18	-13.4	-14.4	-15.5		-9.6	30.0	39.6
	HT/VHT40 Beam Forming, M8 to M15	3	15	-11.8	-12.7	-13.9		-7.9	30.0	37.9
	HT/VHT40 Beam Forming, M16 to M23	3	13	-11.8	-12.7	-13.9		-7.9	30.0	37.9
	HT/VHT40 Beam Forming, M0 to M7	4	19	-14.5	-15.8	-16.3	-13.7	-8.9	30.0	38.9
	HT/VHT40 Beam Forming, M8 to M15	4	16	-12.5	-13.5	-14.6	-12.0	-7.0	30.0	37.0
	HT/VHT40 Beam Forming, M16 to M23	4	14	-12.5	-13.5	-14.6	-12.0	-7.0	30.0	37.0
	HT/VHT40 STBC, M0 to M7	2	13	-11.8	-12.7			-9.2	30.0	39.2
	HT/VHT40 STBC, M0 to M7	3	15	-11.8	-12.7	-13.9		-7.9	30.0	37.9
	HT/VHT40 STBC, M0 to M7	4	16	-12.5	-13.5	-14.6	-12.0	-7.0	30.0	37.0
5775	Non HT80, 6 to 54 Mbps	1	13	-12.0				-12.0	30.0	42.0
	Non HT80, 6 to 54 Mbps	2	13	-12.0	-13.1			-9.5	30.0	39.5
	Non HT80, 6 to 54 Mbps	3	13	-14.8	-16.4	-16.6		-11.1	30.0	41.1
	Non HT80, 6 to 54 Mbps	4	13	-14.8	-16.4	-16.6	-14.3	-9.4	30.0	39.4
	VHT80, M0 to M9 1ss	1	13	-10.0				-10.0	30.0	40.0
	VHT80, M0 to M9 1ss	2	13	-13.9	-15.4			-11.6	30.0	41.6
	VHT80, M0 to M9 2ss	2	13	-13.9	-15.4			-11.6	30.0	41.6
	VHT80, M0 to M9 1ss	3	13	-15.0	-16.5	-16.9		-11.3	30.0	41.3
	VHT80, M0 to M9 2ss	3	13	-15.0	-16.5	-16.9		-11.3	30.0	41.3
	VHT80, M0 to M9 3ss	3	13	-15.0	-16.5	-16.9		-11.3	30.0	41.3
	VHT80, M0 to M9 1ss	4	13	-15.0	-16.5	-16.9	-14.4	-9.6	30.0	39.6
	VHT80, M0 to M9 2ss	4	13	-15.0	-16.5	-16.9	-14.4	-9.6	30.0	39.6
	VHT80, M0 to M9 3ss	4	13	-15.0	-16.5	-16.9	-14.4	-9.6	30.0	39.6
	VHT80 Beam Forming, M0 to M9 1ss	2	13	-13.9	-15.4			-11.6	30.0	41.6
	VHT80 Beam Forming, M0 to M9 2ss	2	13	-13.9	-15.4			-11.6	30.0	41.6
	VHT80 Beam Forming, M0 to M9 1ss	3	13	-15.0	-16.5	-16.9		-11.3	30.0	41.3
	VHT80 Beam Forming, M0 to M9 2ss	3	13	-15.0	-16.5	-16.9		-11.3	30.0	41.3
	VHT80 Beam Forming, M0 to M9 3ss	3	13	-15.0	-16.5	-16.9		-11.3	30.0	41.3
	VHT80 Beam Forming, M0 to M9 1ss	4	13	-15.0	-16.5	-16.9	-14.4	-9.6	30.0	39.6
	VHT80 Beam Forming, M0 to M9 2ss	4	13	-15.0	-16.5	-16.9	-14.4	-9.6	30.0	39.6
VHT80 Beam Forming, M0 to M9 3ss	4	13	-15.0	-16.5	-16.9	-14.4	-9.6	30.0	39.6	



	VHT80 STBC, M0 to M9 1ss	2	13	-13.9	-15.4			-11.6	30.0	41.6
	VHT80 STBC, M0 to M9 1ss	3	13	-15.0	-16.5	-16.9		-11.3	30.0	41.3
	VHT80 STBC, M0 to M9 1ss	4	13	-15.0	-16.5	-16.9	-14.4	-9.6	30.0	39.6
5785	Non HT20, 6 to 54 Mbps	1	13	0.7				0.7	30.0	29.3
	Non HT20, 6 to 54 Mbps	2	16	0.7	0.5			3.6	30.0	26.4
	Non HT20, 6 to 54 Mbps	3	18	0.7	0.5	0.7		5.4	30.0	24.6
	Non HT20, 6 to 54 Mbps	4	19	0.7	0.5	0.7	2.3	7.1	30.0	22.9
	Non HT20 Beam Forming, 6 to 54 Mbps	2	16	0.7	0.5			3.6	30.0	26.4
	Non HT20 Beam Forming, 6 to 54 Mbps	3	18	-4.1	-3.5	-2.7		1.4	30.0	28.6
	Non HT20 Beam Forming, 6 to 54 Mbps	4	19	-6.4	-5.4	-5.0	-4.3	0.8	30.0	29.2
	HT/VHT20, M0 to M7	1	13	0.9				0.9	30.0	29.1
	HT/VHT20, M0 to M7	2	16	0.9	0.7			3.8	30.0	26.2
	HT/VHT20, M8 to M15	2	13	0.9	0.7			3.8	30.0	26.2
	HT/VHT20, M0 to M7	3	18	0.9	0.7	0.3		5.4	30.0	24.6
	HT/VHT20, M8 to M15	3	15	0.9	0.7	0.3		5.4	30.0	24.6
	HT/VHT20, M16 to M23	3	13	0.9	0.7	0.3		5.4	30.0	24.6
	<b>HT/VHT20, M0 to M7</b>	<b>4</b>	<b>19</b>	<b>0.9</b>	<b>0.7</b>	<b>0.3</b>	<b>2.4</b>	<b>7.2</b>	<b>30.0</b>	<b>22.8</b>
	HT/VHT20, M8 to M15	4	16	0.9	0.7	0.3	2.4	7.2	30.0	22.8
	HT/VHT20, M16 to M23	4	14	0.9	0.7	0.3	2.4	7.2	30.0	22.8
	HT/VHT20 Beam Forming, M0 to M7	2	16	0.9	0.7			3.8	30.0	26.2
	HT/VHT20 Beam Forming, M8 to M15	2	13	0.9	0.7			3.8	30.0	26.2
	HT/VHT20 Beam Forming, M0 to M7	3	18	-4.5	-3.9	-3.0		1.0	30.0	29.0
	HT/VHT20 Beam Forming, M8 to M15	3	15	-0.5	-0.4	0.5		4.7	30.0	25.3
	HT/VHT20 Beam Forming, M16 to M23	3	13	0.9	0.7	0.3		5.4	30.0	24.6
	HT/VHT20 Beam Forming, M0 to M7	4	19	-6.0	-5.7	-5.2	-4.3	0.8	30.0	29.2
	HT/VHT20 Beam Forming, M8 to M15	4	16	-2.8	-2.5	-2.1	-1.0	4.0	30.0	26.0
	HT/VHT20 Beam Forming, M16 to M23	4	14	-0.5	-0.4	0.5	1.2	6.3	30.0	23.7
	HT/VHT20 STBC, M0 to M7	2	13	0.9	0.7			3.8	30.0	26.2
	HT/VHT20 STBC, M0 to M7	3	15	0.9	0.7	0.3		5.4	30.0	24.6
	HT/VHT20 STBC, M0 to M7	4	16	0.9	0.7	0.3	2.4	7.2	30.0	22.8
5795	Non HT40, 6 to 54 Mbps	1	13	-3.3				-3.3	30.0	33.3
	Non HT40, 6 to 54 Mbps	2	16	-3.3	-2.9			-0.1	30.0	30.1
	Non HT40, 6 to 54 Mbps	3	18	-3.3	-2.9	-2.1		2.0	30.0	28.0
	Non HT40, 6 to 54 Mbps	4	19	-3.3	-2.9	-2.1	-1.4	3.7	30.0	26.3
	HT/VHT40, M0 to M7	1	13	-2.5				-2.5	30.0	32.5
	HT/VHT40, M0 to M7	2	16	-2.5	-3.2			0.2	30.0	29.8
	HT/VHT40, M8 to M15	2	13	-2.5	-3.2			0.2	30.0	29.8
	HT/VHT40, M0 to M7	3	18	-2.5	-3.2	-2.7		2.0	30.0	28.0
	HT/VHT40, M8 to M15	3	15	-2.5	-3.2	-2.7		2.0	30.0	28.0



	HT/VHT40, M16 to M23	3	13	-2.5	-3.2	-2.7		2.0	30.0	28.0
	HT/VHT40, M0 to M7	4	19	-2.5	-3.2	-2.7	-0.6	3.9	30.0	26.1
	HT/VHT40, M8 to M15	4	16	-2.5	-3.2	-2.7	-0.6	3.9	30.0	26.1
	HT/VHT40, M16 to M23	4	14	-2.5	-3.2	-2.7	-0.6	3.9	30.0	26.1
	HT/VHT40 Beam Forming, M0 to M7	2	16	-2.5	-3.2			0.2	30.0	29.8
	HT/VHT40 Beam Forming, M8 to M15	2	13	-2.5	-3.2			0.2	30.0	29.8
	HT/VHT40 Beam Forming, M0 to M7	3	18	-7.0	-6.4	-6.1		-1.7	30.0	31.7
	HT/VHT40 Beam Forming, M8 to M15	3	15	-4.7	-4.2	-3.7		0.6	30.0	29.4
	HT/VHT40 Beam Forming, M16 to M23	3	13	-2.5	-3.2	-2.7		2.0	30.0	28.0
	HT/VHT40 Beam Forming, M0 to M7	4	19	-8.7	-8.3	-7.8	-6.9	-1.9	30.0	31.9
	HT/VHT40 Beam Forming, M8 to M15	4	16	-5.7	-5.7	-4.7	-4.0	1.1	30.0	28.9
	HT/VHT40 Beam Forming, M16 to M23	4	14	-4.7	-4.2	-3.7	-3.1	2.1	30.0	27.9
	HT/VHT40 STBC, M0 to M7	2	13	-2.5	-3.2			0.2	30.0	29.8
	HT/VHT40 STBC, M0 to M7	3	15	-2.5	-3.2	-2.7		2.0	30.0	28.0
	HT/VHT40 STBC, M0 to M7	4	16	-2.5	-3.2	-2.7	-0.6	3.9	30.0	26.1
5825	Non HT20, 6 to 54 Mbps	1	13	1.6				1.6	30.0	28.4
	Non HT20, 6 to 54 Mbps	2	16	0.2	-0.5			2.9	30.0	27.1
	Non HT20, 6 to 54 Mbps	3	18	-1.6	-3.0	-2.4		2.5	30.0	27.5
	Non HT20, 6 to 54 Mbps	4	19	-3.4	-3.7	-3.2	-2.0	3.0	30.0	27.0
	Non HT20 Beam Forming, 6 to 54 Mbps	2	16	0.2	-0.5			2.9	30.0	27.1
	Non HT20 Beam Forming, 6 to 54 Mbps	3	18	-5.3	-5.6	-5.3		-0.6	30.0	30.6
	Non HT20 Beam Forming, 6 to 54 Mbps	4	19	-6.5	-7.1	-6.4	-5.3	-0.3	30.0	30.3
	HT/VHT20, M0 to M7	1	13	1.5				1.5	30.0	28.5
	HT/VHT20, M0 to M7	2	16	-0.9	-1.6			1.8	30.0	28.2
	HT/VHT20, M8 to M15	2	13	-0.9	-1.6			1.8	30.0	28.2
	HT/VHT20, M0 to M7	3	18	-2.4	-2.8	-2.5		2.2	30.0	27.8
	HT/VHT20, M8 to M15	3	15	-2.4	-2.8	-2.5		2.2	30.0	27.8
	HT/VHT20, M16 to M23	3	13	-2.4	-2.8	-2.5		2.2	30.0	27.8
	HT/VHT20, M0 to M7	4	19	-3.7	-4.0	-3.4	-2.1	2.8	30.0	27.2
	HT/VHT20, M8 to M15	4	16	-3.7	-4.0	-3.4	-2.1	2.8	30.0	27.2
	HT/VHT20, M16 to M23	4	14	-3.7	-4.0	-3.4	-2.1	2.8	30.0	27.2
	HT/VHT20 Beam Forming, M0 to M7	2	16	-0.9	-1.6			1.8	30.0	28.2
	HT/VHT20 Beam Forming, M8 to M15	2	13	-0.9	-1.6			1.8	30.0	28.2
	HT/VHT20 Beam Forming, M0 to M7	3	18	-5.5	-5.9	-5.4		-0.8	30.0	30.8
	HT/VHT20 Beam Forming, M8 to M15	3	15	-2.4	-2.8	-2.5		2.2	30.0	27.8
	HT/VHT20 Beam Forming, M16 to M23	3	13	-2.4	-2.8	-2.5		2.2	30.0	27.8
	HT/VHT20 Beam Forming, M0 to M7	4	19	-7.5	-7.6	-7.4	-6.4	-1.2	30.0	31.2
	HT/VHT20 Beam Forming, M8 to M15	4	16	-3.7	-4.0	-3.4	-2.1	2.8	30.0	27.2
HT/VHT20 Beam Forming, M16 to M23	4	14	-3.7	-4.0	-3.4	-2.1	2.8	30.0	27.2	
HT/VHT20 STBC, M0 to M7	2	13	-0.9	-1.6			1.8	30.0	28.2	



HT/VHT20 STBC, M0 to M7	3	15	-2.4	-2.8	-2.5		2.2	30.0	27.8
HT/VHT20 STBC, M0 to M7	4	16	-3.7	-4.0	-3.4	-2.1	2.8	30.0	27.2



**Power Spectral Density, 5785 MHz, HT/VHT20, M0 to M7**

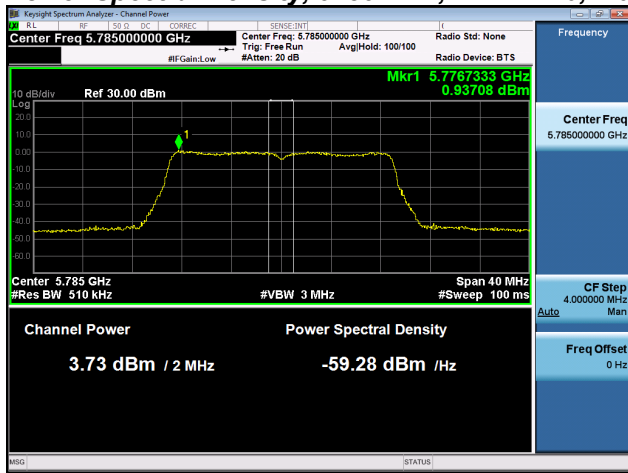

**Antenna A**

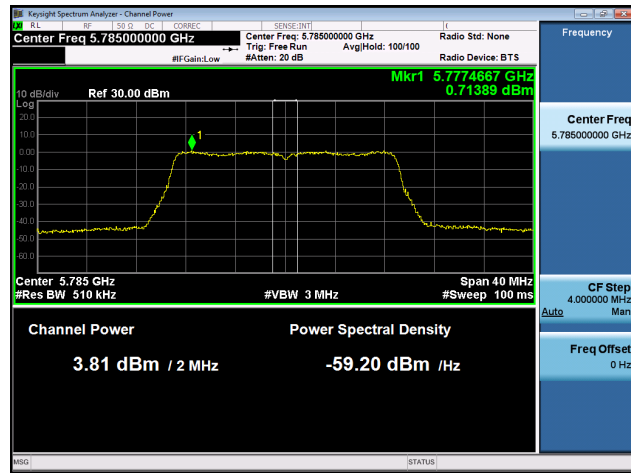

**Antenna B**

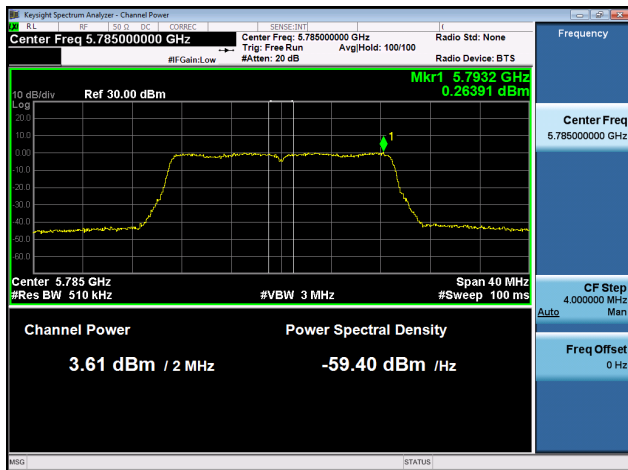

**Antenna C**

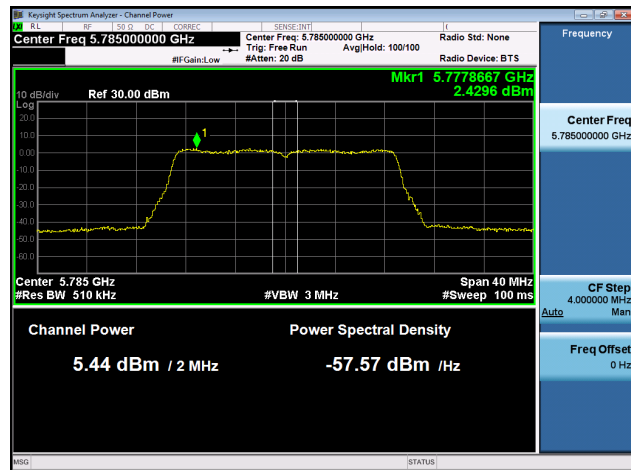

**Antenna D**



## A.5 Conducted Spurious Emissions

**15.407 (b) Undesirable emission limits.** Except as shown in paragraph (b) (7) of this section, the maximum emissions outside of the frequency bands of operation shall be attenuated in accordance with the following limits:

- (4) For transmitters operating in the 5.725-5.85 GHz band: All emissions within the frequency range from the band edge to 10 MHz above or below the band edge shall not exceed an e.i.r.p. of -17 dBm/MHz; for frequencies 10 MHz or greater above or below the band edge, emissions shall not exceed an e.i.r.p. of -27 dBm/MHz.
- (6) Unwanted emissions below 1 GHz must comply with the general field strength limits set forth in §15.209.
- (7) The provisions of §15.205 apply to intentional radiators operating under this section.

### Test Procedure

Ref. KDB 789033 D02 General UNII Test Procedures New Rules v01r01  
ANSI C63.10: 2013

Conducted Spurious Emissions
Test Procedure
1. Connect the antenna port(s) to the spectrum analyzer input. 2. Place the radio in continuous transmit mode. Use the procedures in KDB 789033 D02 General UNII Test Procedures New Rules v01r01 to substitute conducted measurements in place of radiated measurements. 3. Configure Spectrum analyzer as per test parameters below (be sure to enter all losses between the transmitter output and the spectrum analyzer). 4. Record the marker waveform peak to spur difference. Also measure any emissions in the restricted bands. 5. The "measure-and-sum technique" is used for measuring in-band transmit power of a device. In the measure-and-sum approach, the conducted emission level is measured at each antenna port. The measured results at the various antenna ports are then summed mathematically to determine the total emission level from the device. Summing is performed in linear power units. The worst case output is recorded. 6. Capture graphs and record pertinent measurement data.

Ref. KDB 789033 D02 General UNII Test Procedures New Rules v01r01  
ANSI C63.10: 2013 section 12.7.7.3 (average) & 12.7.6 (peak)

Conducted Spurious Emissions
Test parameters
Span = 30MHz to 18GHz / 18GHz to 40GHz RBW = 1 MHz VBW ≥ 3 x RBW for Peak, 1kHz for Average Sweep = Auto couple Detector = Peak Trace = Max Hold.

System Number	Description	Samples	System under test	Support equipment
1	EUT	S01	<input checked="" type="checkbox"/>	<input type="checkbox"/>
	Support	S02	<input type="checkbox"/>	<input checked="" type="checkbox"/>

<b>Tested By :</b> Jose Aguirre	<b>Date of testing:</b> 01-Jan-16 - 29-Feb-16
<b>Test Result : PASS</b>	

See Appendix C for list of test equipment



**Conducted Spurious Emission results below represent the worst case for all antenna gain**

Frequency (MHz)	Mode	Tx Paths	Correlated Antenna Gain (dBi)	Tx 1 Spur Power (dBm)	Tx 2 Spur Power (dBm)	Tx 3 Spur Power (dBm)	Tx 4 Spur Power (dBm)	Total Conducted Spur (dBm)	Limit (dBm)	Margin (dB)
5745	Non HT20, 6 to 54 Mbps	1	13	-69.2				-56.2	-41.25	15.0
	Non HT20, 6 to 54 Mbps	2	13	-69.2	-68.8			-53.0	-41.25	11.7
	Non HT20, 6 to 54 Mbps	3	13	-69.2	-68.8	-66.6		-50.3	-41.25	9.0
	Non HT20, 6 to 54 Mbps	4	13	-69.2	-68.8	-66.6	-68.6	-49.2	-41.25	7.9
	Non HT20 Beam Forming, 6 to 54 Mbps	2	13	-69.2	-68.8			-53.0	-41.25	11.7
	Non HT20 Beam Forming, 6 to 54 Mbps	3	16	-69.2	-68.8	-66.6		-47.3	-41.25	6.0
	<b>Non HT20 Beam Forming, 6 to 54 Mbps</b>	<b>4</b>	<b>16</b>	<b>-69.2</b>	<b>-68.8</b>	<b>-66.6</b>	<b>-68.6</b>	<b>-46.2</b>	<b>-41.25</b>	<b>4.9</b>
	HT/VHT20, M0 to M7	1	13	-69.1				-56.1	-41.25	14.9
	HT/VHT20, M0 to M7	2	13	-69.1	-68.7			-52.9	-41.25	11.6
	HT/VHT20, M8 to M15	2	13	-69.1	-68.7			-52.9	-41.25	11.6
	HT/VHT20, M0 to M7	3	13	-69.1	-68.7	-69.1		-51.2	-41.25	9.9
	HT/VHT20, M8 to M15	3	13	-69.1	-68.7	-69.1		-51.2	-41.25	9.9
	HT/VHT20, M16 to M23	3	13	-69.1	-68.7	-69.1		-51.2	-41.25	9.9
	HT/VHT20, M0 to M7	4	13	-69.1	-68.7	-69.1	-68.9	-49.9	-41.25	8.7
	HT/VHT20, M8 to M15	4	13	-69.1	-68.7	-69.1	-68.9	-49.9	-41.25	8.7
	HT/VHT20, M16 to M23	4	13	-69.1	-68.7	-69.1	-68.9	-49.9	-41.25	8.7
	HT/VHT20 Beam Forming, M0 to M7	2	13	-69.1	-68.7			-52.9	-41.25	11.6
	HT/VHT20 Beam Forming, M8 to M15	2	13	-69.1	-68.7			-52.9	-41.25	11.6
	HT/VHT20 Beam Forming, M0 to M7	3	16	-69.1	-68.7	-69.1		-48.2	-41.25	6.9
	HT/VHT20 Beam Forming, M8 to M15	3	13	-69.1	-68.7	-69.1		-51.2	-41.25	9.9
	HT/VHT20 Beam Forming, M16 to M23	3	13	-69.1	-68.7	-69.1		-51.2	-41.25	9.9
	HT/VHT20 Beam Forming, M0 to M7	4	16	-69.1	-68.7	-69.1	-68.9	-46.9	-41.25	5.7
	HT/VHT20 Beam Forming, M8 to M15	4	13	-69.1	-68.7	-69.1	-68.9	-49.9	-41.25	8.7
	HT/VHT20 Beam Forming, M16 to M23	4	13	-69.1	-68.7	-69.1	-68.9	-49.9	-41.25	8.7
	HT/VHT20 STBC, M0 to M7	2	13	-69.1	-68.7			-52.9	-41.25	11.6
	HT/VHT20 STBC, M0 to M7	3	13	-69.1	-68.7	-69.1		-51.2	-41.25	9.9
	HT/VHT20 STBC, M0 to M7	4	13	-69.1	-68.7	-69.1	-68.9	-49.9	-41.25	8.7
	5755	Non HT40, 6 to 54 Mbps	1	13	-69.1				-56.1	-41.25
Non HT40, 6 to 54 Mbps		2	13	-69.1	-69.1			-53.1	-41.25	11.8
Non HT40, 6 to 54 Mbps		3	13	-69.1	-69.1	-69.3		-51.4	-41.25	10.1
Non HT40, 6 to 54 Mbps		4	13	-69.1	-69.1	-69.3	-69.2	-50.2	-41.25	8.9