



**Test Report**  
**AIR-AP3802P-B-K9**  
**AIR-AP3802P-UXK9**

**FCC ID: LDK102101**

Cisco Aironet 802.11ac Dual Band Access Points

**5470-5725 MHz**

**XOR Radio**

**Against the following Specifications:**

**CFR47 Part 15.407**

**Cisco Systems**

170 West Tasman Drive

San Jose, CA 95134

	
<b>Author:</b> Jose Aguirre <b>Tested By</b>	<b>Approved By:</b> Jim Nicholson <b>Title:</b> Technical Leader, Engineering <b>Revision:</b> 1

This report replaces any previously entered test report under EDCS – **1552573**. This test report has been electronically authorized and archived using the CISCO Engineering Document Control system.



This test report has been electronically authorized and archived using the CISCO Engineering Document Control system.

**SECTION 1: OVERVIEW .....4**

**SECTION2: ASSESSMENT INFORMATION .....5**

    2.1 GENERAL .....5

    2.2 DATE OF TESTING.....7

    2.3 REPORT ISSUE DATE .....7

    2.4 TESTING FACILITIES .....7

    2.5 EQUIPMENT ASSESSED (EUT).....7

    2.6 EUT DESCRIPTION .....8

**SECTION 3: RESULT SUMMARY .....12**

    3.1 RESULTS SUMMARY TABLE .....12

**SECTION 4: SAMPLE DETAILS.....13**

**APPENDIX A: EMISSION TEST RESULTS.....14**

    CONDUCTED TEST SETUP DIAGRAM.....14

    TARGET MAXIMUM CHANNEL POWER .....14

    ANTENNA GAIN : 2 DBI .....14

    ANTENNA GAIN : 3 DBI .....15

    ANTENNA GAIN : 4 DBI .....16

    ANTENNA GAIN : 5 DBI .....17

    ANTENNA GAIN : 6 DBI .....18

    ANTENNA GAIN : 8 DBI .....19

    ANTENNA GAIN : 13 DBI.....20

    A.1 99% AND 26dB BANDWIDTH .....21

    A.2 MAXIMUM CONDUCTED OUTPUT POWER/ POWER SPECTRAL DENSITY .....35

    ANTENNA GAIN : 2 DBI .....38

    ANTENNA GAIN : 3 DBI .....56

    ANTENNA GAIN : 4 DBI .....74

    ANTENNA GAIN : 5 DBI .....92

    ANTENNA GAIN : 6 DBI .....110

    ANTENNA GAIN : 8 DBI .....128

    ANTENNA GAIN : 13 DBI.....146

    A.3 CONDUCTED SPURIOUS EMISSIONS.....164

    A.4 CONDUCTED BANDEDGE.....184

    ANTENNA GAIN : 2 DBI .....185

    ANTENNA GAIN : 3 DBI .....193

    ANTENNA GAIN : 4 DBI .....201

    ANTENNA GAIN : 5 DBI .....209

    ANTENNA GAIN : 6 DBI .....217

    ANTENNA GAIN : 8 DBI .....225

    ANTENNA GAIN : 13 DBI.....233

**APPENDIX B: EMISSION TEST RESULTS.....240**

    RADIATED EMISSION SETUP DIAGRAM-BELOW 1G.....240



RADIATED EMISSION SETUP DIAGRAM-ABOVE 1G .....	240
B.1 RADIATED SPURIOUS EMISSIONS .....	241
B.2 RADIATED EMISSIONS 30MHZ TO 1GHZ .....	256
B.3 AC CONDUCTED EMISSIONS .....	258
<b>APPENDIX C: LIST OF TEST EQUIPMENT USED TO PERFORM THE TEST.....</b>	<b>264</b>
<b>APPENDIX E: ABBREVIATION KEY AND DEFINITIONS .....</b>	<b>266</b>



**Section 1: Overview**

The samples were assessed against the tests detailed in section 3 under the requirements of the following specifications:

<b>Specifications:</b>
CFR47 Part 15.407

Measurements were made in accordance with

- ANSI C63.10:2013
- KDB 789033 D02 General UNII Test Procedures New Rules v01r01
- KDB 662911 D01 Multiple Transmitter Output v02r01



## Section2: Assessment Information

### 2.1 General

This report contains an assessment of an apparatus against Electromagnetic Compatibility Standards based upon tests carried out on the samples submitted. The testing was performed by and for the use of Cisco systems Inc:

With regard to this assessment, the following points should be noted:

- a) The results contained in this report relate only to the items tested and were obtained in the period between the date of the initial assessment and the date of issue of the report. Manufactured products will not necessarily give identical results due to production and measurement tolerances.
- b) The apparatus was set up and exercised using the configuration and modes of operation defined in this report only.
- c) Where relevant, the apparatus was only assessed using the susceptibility criteria defined in this report and the Test Assessment Plan (TAP).
- d) All testing was performed under the following environmental conditions:

Temperature	15°C to 35°C (54°F to 95°F)
Atmospheric Pressure	860mbar to 1060mbar (25.4" to 31.3")
Humidity	10% to 75*%
- e) All AC testing was performed at one or more of the following supply voltages:  
110V 60 Hz (+/-20%)

### Units of Measurement

The units of measurements defined in the appendices are reported in specific terms, which are test dependent. Where radiated measurements are concerned these are defined at a particular distance. Basic voltage measurements are defined in units of [dBuV]

As an example, the basic calculation for all measurements is as follows:

$$\text{Emission level [dBuV]} = \text{Indicated voltage level [dBuV]} + \text{Cable Loss [dB]} + \text{Other correction factors [dB]}$$

The combinations of correction factors are dependent upon the exact test configurations [see test equipment lists for further details] and may include:-

Antenna Factors, Pre Amplifier Gain, LISN Loss, Pulse Limiter Loss and Filter Insertion Loss

Note: to convert the results from dBuV/m to uV/m use the following formula:-

$$\text{Level in uV/m} = \text{Common Antilogarithm } [(X \text{ dBuV/m})/20] = Y \text{ uV/m}$$



Measurement Uncertainty Values

voltage and power measurements	± 2 dB
conducted EIRP measurements	± 1.4 dB
radiated measurements	± 3.2 dB
frequency measurements	± 2.4 10 <sup>-7</sup>
temperature measurements	± 0.54°
humidity measurements	± 2.3%
DC and low frequency measurements	± 2.5%

Where relevant measurement uncertainty levels have been estimated for tests performed on the apparatus. This uncertainty represents an expanded uncertainty expressed at approximately the 95% confidence level using a coverage factor of k=2.

Radiated emissions (expanded uncertainty, confidence interval 95%)

30 MHz - 300 MHz	+/- 3.8 dB
300 MHz - 1000 MHz	+/- 4.3 dB
1 GHz - 10 GHz	+/- 4.0 dB
10 GHz - 18GHz	+/- 8.2 dB
18GHz - 26.5GHz	+/- 4.1 dB
26.5GHz - 40GHz	+/- 3.9 dB

Conducted emissions (expanded uncertainty, confidence interval 95%)

30 MHz – 40GHz	+/- 0.38 dB
----------------	-------------

A product is considered to comply with a requirement if the nominal measured value is below the limit line. The product is considered to not be in compliance in case the nominal measured value is above the limit line.

**This report must not be reproduced except in full, without written approval of Cisco Systems.**

**2.2 Date of testing**

01-Jan-16 - 03-Mar-16

**2.3 Report Issue Date**

28-March-2016

Cisco uses an electronic system to issue, store and control the revision of test reports. This system is called the Engineering Document Control System (EDCS). The actual report issue date is embedded into the original file on EDCS. Any copies of this report, either electronic or paper, that are not on EDCS must be considered uncontrolled.

**2.4 Testing facilities**

This assessment was performed by:

**Testing Laboratory**

Cisco Systems, Inc.,  
125 West Tasman Drive  
San Jose, CA 95134, USA

**Registration Numbers for Industry Canada**

<b>Cisco System Site</b>	<b>Address</b>	<b>Site Identifier</b>
Building P, 10m Chamber	125 West Tasman Dr San Jose, CA 95134	Company #: 2461N-2
Building P, 5m Chamber	125 West Tasman Dr San Jose, CA 95134	Company #: 2461N-1
Building I, 5m Chamber	285 W. Tasman Drive San Jose, California 95134	Company #: 2461M-1

**Test Engineers**

Jose Aguirre

**2.5 Equipment Assessed (EUT)**

AIR-AP3802P-B-K9



## 2.6 EUT Description

The Cisco Aironet 802.11ac Radio supports the following modes of operation. The modes are further defined in the radio Theory of Operation. The modes included in this report represent the worst case data for all modes.

- 802.11n/ac - Non HT20, One Antenna, 6 to 54 Mbps
- 802.11n/ac - Non HT20, Two Antennas, 6 to 54 Mbps
- 802.11n/ac - Non HT20, Three Antennas, 6 to 54 Mbps
- 802.11n/ac - Non HT20, Four Antennas, 6 to 54 Mbps
  
- 802.11n/ac - Non HT20 Beam Forming, Two Antennas, 6 to 54 Mbps
- 802.11n/ac - Non HT20 Beam Forming, Three Antennas, 6 to 54 Mbps
- 802.11n/ac - Non HT20 Beam Forming, Four Antennas, 6 to 54 Mbps
  
- 802.11n/ac - HT/VHT20, One Antenna, M0 to M7
- 802.11n/ac - HT/VHT20, Two Antennas, M0 to M7
- 802.11n/ac - HT/VHT20, Two Antennas, M8 to M15
- 802.11n/ac - HT/VHT20, Three Antennas, M0 to M7
- 802.11n/ac - HT/VHT20, Three Antennas, M8 to M15
- 802.11n/ac - HT/VHT20, Three Antennas, M16 to M23
- 802.11n/ac - HT/VHT20, Four Antennas, M0 to M7
- 802.11n/ac - HT/VHT20, Four Antennas, M8 to M15
- 802.11n/ac - HT/VHT20, Four Antennas, M16 to M23
  
- 802.11n/ac - HT/VHT20 Beam Forming, Two Antennas, M0 to M7
- 802.11n/ac - HT/VHT20 Beam Forming, Two Antennas, M8 to M15
- 802.11n/ac - HT/VHT20 Beam Forming, Three Antennas, M0 to M7
- 802.11n/ac - HT/VHT20 Beam Forming, Three Antennas, M8 to M15
- 802.11n/ac - HT/VHT20 Beam Forming, Three Antennas, M16 to M23
- 802.11n/ac - HT/VHT20 Beam Forming, Four Antennas, M0 to M7
- 802.11n/ac - HT/VHT20 Beam Forming, Four Antennas, M8 to M15
- 802.11n/ac - HT/VHT20 Beam Forming, Four Antennas, M16 to M23
  
- 802.11n/ac - HT/VHT20 STBC, Two Antennas, M0 to M7
- 802.11n/ac - HT/VHT20 STBC, Three Antennas, M0 to M7
- 802.11n/ac - HT/VHT20 STBC, Four Antennas, M0 to M7
  
- 802.11n/ac - Non HT40 Duplicate, One Antenna, 6 to 54 Mbps
- 802.11n/ac - Non HT40 Duplicate, Two Antennas, 6 to 54 Mbps
- 802.11n/ac - Non HT40 Duplicate, Three Antennas, 6 to 54 Mbps
- 802.11n/ac - Non HT40 Duplicate, Four Antennas, 6 to 54 Mbps
  
- 802.11n/ac - HT/VHT40, One Antenna, M0 to M7
- 802.11n/ac - HT/VHT40, Two Antennas, M0 to M7
- 802.11n/ac - HT/VHT40, Two Antennas, M8 to M15
- 802.11n/ac - HT/VHT40, Three Antennas, M0 to M7
- 802.11n/ac - HT/VHT40, Three Antennas, M8 to M15
- 802.11n/ac - HT/VHT40, Three Antennas, M16 to M23
- 802.11n/ac - HT/VHT40, Four Antennas, M0 to M7
- 802.11n/ac - HT/VHT40, Four Antennas, M8 to M15
- 802.11n/ac - HT/VHT40, Four Antennas, M16 to M23
  
- 802.11n/ac - HT/VHT40 Beam Forming, Two Antennas, M0 to M7





802.11n/ac - HT/VHT40 Beam Forming, Two Antennas, M8 to M15  
802.11n/ac - HT/VHT40 Beam Forming, Three Antennas, M0 to M7  
802.11n/ac - HT/VHT40 Beam Forming, Three Antennas, M8 to M15  
802.11n/ac - HT/VHT40 Beam Forming, Three Antennas, M16 to M23  
802.11n/ac - HT/VHT40 Beam Forming, Four Antennas, M0 to M7  
802.11n/ac - HT/VHT40 Beam Forming, Four Antennas, M8 to M15  
802.11n/ac - HT/VHT40 Beam Forming, Four Antennas, M16 to M23

802.11n/ac - HT/VHT40 STBC, Two Antennas, M0 to M7  
802.11n/ac - HT/VHT40 STBC, Three Antennas, M0 to M7  
802.11n/ac - HT/VHT40 STBC, Four Antennas, M0 to M7

802.11n/ac - Non HT80 Duplicate, One Antenna, 6 to 54 Mbps  
802.11n/ac - Non HT80 Duplicate, Two Antennas, 6 to 54 Mbps  
802.11n/ac - Non HT80 Duplicate, Three Antennas, 6 to 54 Mbps  
802.11n/ac - Non HT80 Duplicate, Four Antennas, 6 to 54 Mbps

802.11ac - VHT80, One Antenna, M0 to M9 1ss  
802.11ac - VHT80, Two Antennas, M0 to M9 1ss  
802.11ac - VHT80, Two Antennas, M0 to M9 2ss  
802.11ac - VHT80, Three Antennas, M0 to M9 1ss  
802.11ac - VHT80, Three Antennas, M0 to M9 2ss  
802.11ac - VHT80, Three Antennas, M0 to M9 3ss  
802.11ac - VHT80, Four Antennas, M0 to M9 1ss  
802.11ac - VHT80, Four Antennas, M0 to M9 2ss  
802.11ac - VHT80, Four Antennas, M0 to M9 3ss

802.11ac - VHT80 Beam Forming, Two Antennas, M0 to M9 1ss  
802.11ac - VHT80 Beam Forming, Two Antennas, M0 to M9 2ss  
802.11ac - VHT80 Beam Forming, Three Antennas, M0 to M9 1ss  
802.11ac - VHT80 Beam Forming, Three Antennas, M0 to M9 2ss  
802.11ac - VHT80 Beam Forming, Three Antennas, M0 to M9 3ss  
802.11ac - VHT80 Beam Forming, Four Antennas, M0 to M9 1ss  
802.11ac - VHT80 Beam Forming, Four Antennas, M0 to M9 2ss  
802.11ac - VHT80 Beam Forming, Four Antennas, M0 to M9 3ss

802.11ac - VHT80 STBC, Two Antennas, M0 to M9 1ss  
802.11ac - VHT80 STBC, Three Antennas, M0 to M9 1ss  
802.11ac - VHT80 STBC, Four Antennas, M0 to M9 1ss

802.11n/ac - Non HT160, One Antenna, 6 to 54 Mbps  
802.11n/ac - Non HT160, Two Antennas, 6 to 54 Mbps  
802.11n/ac - Non HT160, Three Antennas, 6 to 54 Mbps  
802.11n/ac - Non HT160, Four Antennas, 6 to 54 Mbps

802.11ac - VHT160, One Antenna, M0 to M9 1ss  
802.11ac - VHT160, Two Antennas, M0 to M9 1ss  
802.11ac - VHT160, Two Antennas, M0 to M9 2ss  
802.11ac - VHT160, Three Antennas, M0 to M9 1ss  
802.11ac - VHT160, Three Antennas, M0 to M9 2ss  
802.11ac - VHT160, Three Antennas, M0 to M9 3ss  
802.11ac - VHT160, Four Antennas, M0 to M9 1ss  
802.11ac - VHT160, Four Antennas, M0 to M9 2ss  
802.11ac - VHT160, Four Antennas, M0 to M9 3ss

802.11ac - VHT160 Beam Forming, Two Antennas, M0 to M9 1ss  
802.11ac - VHT160 Beam Forming, Two Antennas, M0 to M9 2ss  
802.11ac - VHT160 Beam Forming, Three Antennas, M0 to M9 1ss  
802.11ac - VHT160 Beam Forming, Three Antennas, M0 to M9 2ss



802.11ac - VHT160 Beam Forming, Three Antennas, M0 to M9 3ss  
802.11ac - VHT160 Beam Forming, Four Antennas, M0 to M9 1ss  
802.11ac - VHT160 Beam Forming, Four Antennas, M0 to M9 2ss  
802.11ac - VHT160 Beam Forming, Four Antennas, M0 to M9 3ss

802.11ac - VHT160 STBC, Two Antennas, M0 to M9 1ss  
802.11ac - VHT160 STBC, Three Antennas, M0 to M9 1ss  
802.11ac - VHT160 STBC, Four Antennas, M0 to M9 1ss



The following antennas are supported by this product series.  
The data included in this report represent the worst case data for all antennas.

Frequency	Part Number	Antenna Type	Antenna Gain (dBi)	Model	Antenna Gain >30 degrees (dBi)
<b>2.4 GHz</b>	AIR-ANT24020V-R	Omni	2	3800P	NA
	AIR-ANT2452V-R	Diversity Omni-directional	5.2	3800P	NA
	AIR-ANT2430V-R	MIMO 3-Element Omni	3	3800P	NA
	AIR-ANT2440NV-R	MIMO Wall-Mount Omni Antenna	4	3800P	NA
	AIR-ANT2460NP-R	MIMO 3-Element Patch	6	3800P	NA
<b>5 GHz</b>	AIR-ANT5140V-R	MIMO 3-Element Omni	4	3800P	Indoor Only
	AIR-ANT5140NV-R	MIMO Wall-Mount Omni Antenna	4	3800P	-8
	AIR-ANT5145V-R	Diversity Omni-directional	4.5	3800P	Indoor Only
	AIR-ANT5160NP-R	MIMO 3-Element Patch	6	3800P	3
<b>2.4 / 5 GHz</b>	AIR-ANT2451V-R	Omni	2 / 3	3800P	Indoor Only
	AIR-ANT2451NV-R	Omni	3 / 4	3800P	Indoor Only
	AIR-ANT2524DB-R	Dual-resonant black dipole	2 / 4	3800P	Indoor Only
	AIR-ANT2524DW-R	Dual-resonant white dipole	2 / 4	3800P	Indoor Only
	AIR-ANT2524DG-R	Dual-resonant gray dipole	2 / 4	3800P	Indoor Only
	AIR-ANT2524V4C-R	Dual-resonant ceiling mount omni (4-pack)	2 / 4	3800P	Indoor Only
	AIR-ANT2535SDW-R	Dual-resonant "stubby" monopole	3 / 5	3800P	Indoor Only
	AIR-ANT2544V4M-R	Dual-resonant omni (4-pack)	4 / 4	3800P	Indoor Only
	AIR-ANT2566P4W-R	Dual-resonant "directional" antenna (4-pack)	6 / 6	3800P	3
	AIR-ANT2566D4M-R	Dual-Band Polarization-Diverse Directional Array	6 / 6	3800P	3
	AIR-ANT2513P4M-N	Dual-resonant cross-pol "directional" antenna (4-pack)	13 / 13	3800P	-7
	AIR-ANT25-LOC-02	Directional HL / Directional WiFi	3 / 4	3800P	
	AIR-ANT25-LOC-03	Linear HL / Omni WiFi	0 / 1	3800P	
	AIR-ANT25-LOC-04	Omni HL / Omni WiFi	0 / 1	3800P	

### Section 3: Result Summary

#### 3.1 Results Summary Table

##### Conducted emissions

Basic Standard	Technical Requirements / Details	Result
FCC 15.407	<p><b>99% &amp; 26 dB Bandwidth:</b> The 99% occupied bandwidth is the frequency bandwidth such that, below its lower and above its upper frequency limits, the mean powers are each equal to 0.5% of the total mean power of the given emission. There is no limit for 99% OBW.</p> <p>The 26 dB emission is the width of the emission that is constrained by the frequencies associated with the two outermost amplitude points (upper and lower frequencies) that are attenuated by 26 dB relative to the maximum level measured in the fundamental emission.</p>	Pass
FCC 15.407	<p><b>Output Power:</b> <b>15.407</b> (2) For the 5.25-5.35 GHz and 5.47-5.725 GHz bands, the maximum conducted output power over the frequency bands of operation shall not exceed the lesser of 250 mW or 11 dBm + 10 log B, where B is the 26 dB emission bandwidth in megahertz. In addition, the maximum power spectral density shall not exceed 11 dBm in any 1 megahertz band. If transmitting antennas of directional gain greater than 6 dBi are used, both the maximum conducted output power and the maximum power spectral density shall be reduced by the amount in dB that the directional gain of the antenna exceeds 6 dBi.</p>	Pass
FCC 15.407	<p><b>Power Spectral Density:</b> <b>15.407</b> The maximum power spectral density shall not exceed 17 dBm in any 1 megahertz band. If transmitting antennas of directional gain greater than 6 dBi are used, both the maximum conducted output power and the maximum power spectral density shall be reduced by the amount in dB that the directional gain of the antenna exceeds 6 dBi.</p>	Pass
FCC 15.407	<p><b>Conducted Spurious Emissions / Band-Edge:</b> <b>15.407</b> (3) For transmitters operating in the 5.47-5.725 GHz band: All emissions outside of the 5.47-5.725 GHz band shall not exceed an e.i.r.p. of -27 dBm/MHz.</p>	Pass
FCC 15.407 FCC 15.209 FCC 15.205	<p><b>Restricted band:</b> Unwanted emissions falling within the restricted bands, as defined in FCC 15.205 (a) must also comply with the radiated emission limits specified in FCC 15.209 (a).</p>	Pass

##### Radiated Emissions (General requirements)

Basic Standard	Technical Requirements / Details	Result
FCC 15.209 FCC 15.205	<p><b>TX Spurious Emissions:</b> Except as provided elsewhere in this subpart, the emissions from an intentional radiator shall not exceed the field strength levels specified in the filed strength limits table in this section.</p>	Pass
FCC 15.207	<p><b>AC conducted Emissions:</b> Except when the requirements applicable to a given device state otherwise, for any radio apparatus equipped to operate from the public utility AC power supply, either directly or indirectly (such as with a battery charger), the radio frequency voltage of emissions conducted back onto the AC power lines in the frequency range of 0.15 MHz to 30 MHz shall not exceed the limits shown in the table in these sections. The more stringent limit applies at the frequency range boundaries.</p>	Pass

\* MPE calculation is recorded in a separate report



## Section 4: Sample Details

Note: Each sample was evaluated to ensure that its condition was suitable to be used as a test sample prior to the commencement of testing.

### 4.1 Sample Details

Sample No.	Equipment Details	Manufacturer	Hardware Rev.	Firmware Rev.	Software Rev.	Serial Number
S01	AIR-AP3802P-B-K9	Cisco Systems	01	Linux ver 3.14.33	U-boot	FOC1945132D
S02*	PWR-CUBE-B 341-100460-001	Delta	A0	NA	NA	Engineering sample

(\*) S02 are support equipment Power supplies for EUT S01

### 4.2 System Details

System #	Description	Samples
1	AIR-AP3802P-B-K9	S01
2	PWR-CUBE-B	S02

### 4.3 Mode of Operation Details

Mode#	Description	Comments
1	Continuous Transmitting	Continuous Transmitting $\geq 98\%$ duty cycle

All measurements were made in accordance with

- ANSI C63.10:2013
- KDB 789033 D02 General UNII Test Procedures New Rules v01r01
- KDB 662911 D01 Multiple Transmitter Output v02r01



**Appendix A: Emission Test Results**

**Conducted Test Setup Diagram**

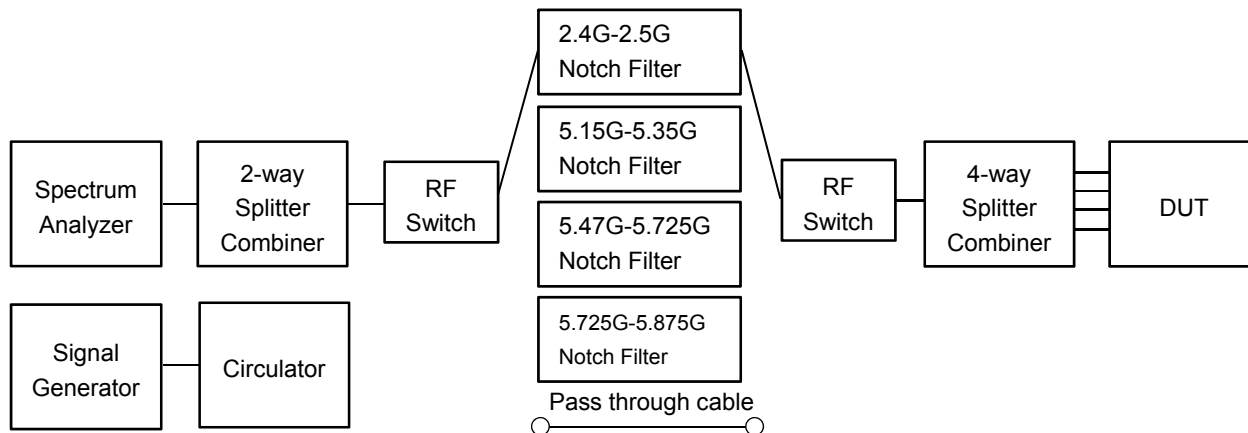

**Target Maximum Channel Power**

The following table details the maximum supported Total Channel Power for all operating modes.

**Antenna Gain : 2 dBi**

Operating Mode	Maximum Channel Power (dBm)		
	Frequency (MHz)		
	5570		
Non HT160, 6 to 54 Mbps	17		
VHT160, M0 to M9, M0 to M9 1-1ss	21		
VHT160 Beam Forming, M0 to M9, M0 to M9 1-1ss	21		
VHT160 STBC, M0 to M9 1ss	21		
	5500	5560	5660
Non HT20, 6 to 54 Mbps	20	20	20
Non HT20 Beam Forming, 6 to 54 Mbps	20	20	20
HT/VHT20, M0 to M23	21	22	21
HT/VHT20 Beam Forming, M0 to M23	21	22	21
HT/VHT20 STBC, M0 to M7	21	22	21
	5510	5670	5710
Non HT40, 6 to 54 Mbps	16	23	22
HT/VHT40, M0 to M23	20	23	22
HT/VHT40 Beam Forming, M0 to M23	20	23	22
HT/VHT40 STBC, M0 to M7	20	23	22
	5530	5690	
Non HT80, 6 to 54 Mbps	19	22	
VHT80, M0 to M9, M0 to M9 1-1ss	21	22	
VHT80 Beam Forming, M0 to M9, M0 to M9 1-1ss	21	22	
VHT80 STBC, M0 to M9 1ss	21	22	



**Antenna Gain : 3 dBi**

Operating Mode	Maximum Channel Power (dBm)		
	Frequency (MHz)		
	5570		
Non HT160, 6 to 54 Mbps	17		
VHT160, M0 to M9, M0 to M9 1-1ss	21		
VHT160 Beam Forming, M0 to M9, M0 to M9 1-1ss	21		
VHT160 STBC, M0 to M9 1ss	21		
	5500	5560	5660
Non HT20, 6 to 54 Mbps	20	19	20
Non HT20 Beam Forming, 6 to 54 Mbps	20	19	20
HT/VHT20, M0 to M23	21	22	21
HT/VHT20 Beam Forming, M0 to M23	21	22	21
HT/VHT20 STBC, M0 to M7	21	22	21
	5510	5670	5710
Non HT40, 6 to 54 Mbps	16	22	21
HT/VHT40, M0 to M23	20	23	22
HT/VHT40 Beam Forming, M0 to M23	20	23	22
HT/VHT40 STBC, M0 to M7	20	23	22
	5530	5690	
Non HT80, 6 to 54 Mbps	18	22	
VHT80, M0 to M9, M0 to M9 1-1ss	21	22	
VHT80 Beam Forming, M0 to M9, M0 to M9 1-1ss	20	22	
VHT80 STBC, M0 to M9 1ss	21	22	



**Antenna Gain : 4 dBi**

Operating Mode	Maximum Channel Power (dBm)		
	Frequency (MHz)		
	5570		
Non HT160, 6 to 54 Mbps	17		
VHT160, M0 to M9, M0 to M9 1-1ss	21		
VHT160 Beam Forming, M0 to M9, M0 to M9 1-1ss	21		
VHT160 STBC, M0 to M9 1ss	21		
	5500	5560	5660
Non HT20, 6 to 54 Mbps	20	19	20
Non HT20 Beam Forming, 6 to 54 Mbps	20	19	20
HT/VHT20, M0 to M23	21	22	21
HT/VHT20 Beam Forming, M0 to M23	21	22	21
HT/VHT20 STBC, M0 to M7	21	21	21
	5510	5670	5710
Non HT40, 6 to 54 Mbps	15	21	21
HT/VHT40, M0 to M23	19	23	22
HT/VHT40 Beam Forming, M0 to M23	19	23	22
HT/VHT40 STBC, M0 to M7	19	23	22
	5530	5690	
Non HT80, 6 to 54 Mbps	18	22	
VHT80, M0 to M9, M0 to M9 1-1ss	20	22	
VHT80 Beam Forming, M0 to M9, M0 to M9 1-1ss	20	22	
VHT80 STBC, M0 to M9 1ss	20	22	





**Antenna Gain : 5 dBi**

Operating Mode	Maximum Channel Power (dBm)		
	Frequency (MHz)		
	5570		
Non HT160, 6 to 54 Mbps	17		
VHT160, M0 to M9, M0 to M9 1-1ss	21		
VHT160 Beam Forming, M0 to M9, M0 to M9 1-1ss	20		
VHT160 STBC, M0 to M9 1ss	21		
	5500	5560	5660
Non HT20, 6 to 54 Mbps	19	18	19
Non HT20 Beam Forming, 6 to 54 Mbps	18	18	19
HT/VHT20, M0 to M23	21	22	21
HT/VHT20 Beam Forming, M0 to M23	21	22	21
HT/VHT20 STBC, M0 to M7	21	20	21
	5510	5670	5710
Non HT40, 6 to 54 Mbps	14	21	20
HT/VHT40, M0 to M23	17	23	22
HT/VHT40 Beam Forming, M0 to M23	17	23	22
HT/VHT40 STBC, M0 to M7	17	22	22
	5530	5690	
Non HT80, 6 to 54 Mbps	17	22	
VHT80, M0 to M9, M0 to M9 1-1ss	20	22	
VHT80 Beam Forming, M0 to M9, M0 to M9 1-1ss	19	22	
VHT80 STBC, M0 to M9 1ss	20	22	



**Antenna Gain : 6 dBi**

Operating Mode	Maximum Channel Power (dBm)		
	Frequency (MHz)		
	5570		
Non HT160, 6 to 54 Mbps	17		
VHT160, M0 to M9, M0 to M9 1-1ss	19		
VHT160 Beam Forming, M0 to M9, M0 to M9 1-1ss	18		
VHT160 STBC, M0 to M9 1ss	19		
	5500	5560	5660
Non HT20, 6 to 54 Mbps	18	18	18
Non HT20 Beam Forming, 6 to 54 Mbps	17	18	18
HT/VHT20, M0 to M23	21	21	21
HT/VHT20 Beam Forming, M0 to M23	21	21	21
HT/VHT20 STBC, M0 to M7	21	20	21
	5510	5670	5710
Non HT40, 6 to 54 Mbps	12	21	20
HT/VHT40, M0 to M23	17	23	22
HT/VHT40 Beam Forming, M0 to M23	17	23	22
HT/VHT40 STBC, M0 to M7	17	22	21
	5530	5690	
Non HT80, 6 to 54 Mbps	17	21	
VHT80, M0 to M9, M0 to M9 1-1ss	19	22	
VHT80 Beam Forming, M0 to M9, M0 to M9 1-1ss	19	22	
VHT80 STBC, M0 to M9 1ss	19	22	



**Antenna Gain : 8 dBi**

Operating Mode	Maximum Channel Power (dBm)		
	Frequency (MHz)		
	5570		
Non HT160, 6 to 54 Mbps	12		
VHT160, M0 to M9, M0 to M9 1-1ss	17		
VHT160 Beam Forming, M0 to M9, M0 to M9 1-1ss	17		
VHT160 STBC, M0 to M9 1ss	17		
	5500	5560	5660
Non HT20, 6 to 54 Mbps	16	16	17
Non HT20 Beam Forming, 6 to 54 Mbps	15	16	16
HT/VHT20, M0 to M23	18	20	19
HT/VHT20 Beam Forming, M0 to M23	18	20	19
HT/VHT20 STBC, M0 to M7	18	20	19
	5510	5670	5710
Non HT40, 6 to 54 Mbps	11	19	20
HT/VHT40, M0 to M23	15	22	21
HT/VHT40 Beam Forming, M0 to M23	14	22	21
HT/VHT40 STBC, M0 to M7	15	20	20
	5530	5690	
Non HT80, 6 to 54 Mbps	14	20	
VHT80, M0 to M9, M0 to M9 1-1ss	19	22	
VHT80 Beam Forming, M0 to M9, M0 to M9 1-1ss	18	21	
VHT80 STBC, M0 to M9 1ss	19	22	



**Antenna Gain : 13 dBi**

Operating Mode	Maximum Channel Power (dBm)		
	Frequency (MHz)		
	5570		
Non HT160, 6 to 54 Mbps	9		
VHT160, M0 to M9, M0 to M9 1-1ss	14		
VHT160 Beam Forming, M0 to M9, M0 to M9 1-1ss	14		
VHT160 STBC, M0 to M9 1ss	14		
	<b>5500</b>	<b>5560</b>	<b>5660</b>
Non HT20, 6 to 54 Mbps	12	14	14
Non HT20 Beam Forming, 6 to 54 Mbps	11	11	10
HT/VHT20, M0 to M23	13	14	14
HT/VHT20 Beam Forming, M0 to M23	13	14	14
HT/VHT20 STBC, M0 to M7	13	14	14
	<b>5510</b>	<b>5670</b>	<b>5710</b>
Non HT40, 6 to 54 Mbps	6	17	16
HT/VHT40, M0 to M23	10	17	16
HT/VHT40 Beam Forming, M0 to M23	10	16	16
HT/VHT40 STBC, M0 to M7	10	16	16
	<b>5530</b>	<b>5690</b>	
Non HT80, 6 to 54 Mbps	11	16	
VHT80, M0 to M9, M0 to M9 1-1ss	14	17	
VHT80 Beam Forming, M0 to M9, M0 to M9 1-1ss	14	17	
VHT80 STBC, M0 to M9 1ss	14	17	

## A.1 99% and 26dB Bandwidth

**FCC 15.407** The 99% occupied bandwidth is the frequency bandwidth such that, below its lower and above its upper frequency limits, the mean powers are each equal to 0.5% of the total mean power of the given emission. There is no limit for 99% OBW.

The 26 dB emission is the width of the emission that is constrained by the frequencies associated with the two outermost amplitude points (upper and lower frequencies) that are attenuated by 26 dB relative to the maximum level measured in the fundamental emission.

### KDB 644545 D03 v01 section D1b

**Band-crossing emissions:** For an emission that crosses the boundary between two adjacent U-NII bands, the boundary frequency between the bands serves as one edge for defining the portion of the EBW that falls within a particular U-NII band. However, the -26 dB points are measured relative to the highest point on the contiguous segment—regardless of which band contains that highest point (Figure4).

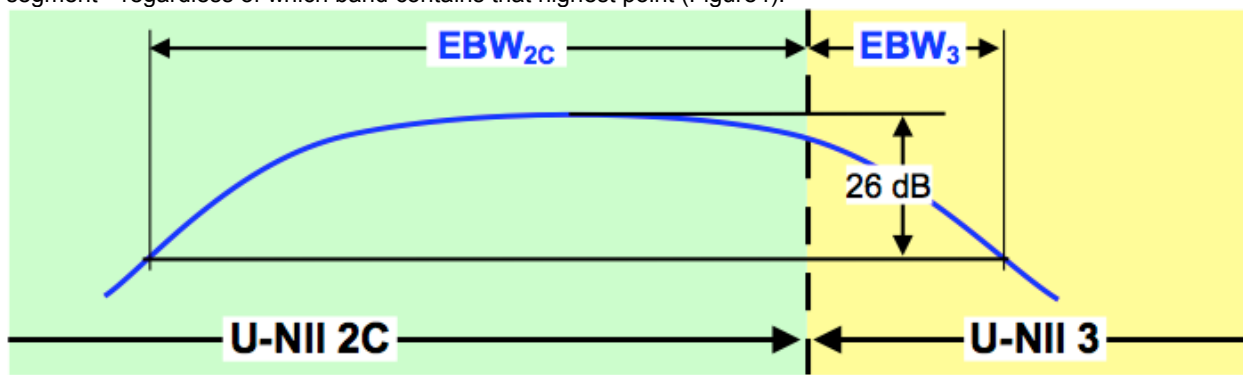

**Figure 4. Emission Bandwidth (EBW) within a Band for Band-Crossing Signals**

### Test Procedure

Ref. ANSI C63.10: 2013 Section 6.9.3  
 KDB 644545 D03 v01  
 KDB 789033 D02 General UNII Test Procedures New Rules v01r01  
 KDB 662911

#### 99% BW and EBW (-26dB)

Test Procedure

1. Set the radio in the continuous transmitting mode.
2. Allow the trace to stabilize.
3. Setting the x-dB bandwidth mode to -26dB and OBW power function to 99% within the measurement set up function.
4. Select the automatic OBW measurement function of an instrument to perform bandwidth measurement.
5. Capture graphs and record pertinent measurement data.

Ref. ANSI C63.10: 2013 Section 6.9.3

#### 99% BW and EBW (-26dB)

Test parameters

X dB BW = -26dB (using the OBW function of the spectrum analyzer)  
 OBW = 99% (using the OBW function of the spectrum analyzer)  
 Span = 1.5 x to 5.0 times OBW  
 RBW = approx. 1% to 5% of the OBW  
 VBW ≥ 3 x RBW



Detector = Peak or where practical sample shall be used  
Trace = Max. Hold

System Number	Description	Samples	System under test	Support equipment
1	EUT	S01	<input checked="" type="checkbox"/>	<input type="checkbox"/>
	Support	S02	<input type="checkbox"/>	<input checked="" type="checkbox"/>

<b>Tested By :</b> Jose Aguirre	<b>Date of testing:</b> 01-Jan-16 - 03-Mar-16
<b>Test Result : PASS</b>	

See Appendix C for list of test equipment



Frequency (MHz)	Mode	Data Rate (Mbps)	26dB BW (MHz)	99% BW (MHz)
5500	Non HT20, 6 to 54 Mbps	6	24.1	18.0
	HT/VHT20, M0 to M23	m0	23.9	18.3
5510	Non HT40, 6 to 54 Mbps	6	49.6	37.1
	HT/VHT40, M0 to M23	m0	42.7	36.7
5530	Non HT80, 6 to 54 Mbps	6	83.2	76.6
	VHT80, M0 to M9, M0 to M9 1-1ss	m0x1	85.5	76.8
5570	Non HT160, 6 to 54 Mbps	6	164.4	156.0
	VHT160, M0 to M9, M0 to M9 1-1ss	m0x1	164.9	155.6
5560	Non HT20, 6 to 54 Mbps	6	24.0	18.0
	HT/VHT20, M0 to M23	m0	23.0	18.3
5660	Non HT20, 6 to 54 Mbps	6	23.7	18.0
	HT/VHT20, M0 to M23	m0	22.1	18.3
5670	Non HT40, 6 to 54 Mbps	6	56.0	37.3
	HT/VHT40, M0 to M23	m0	43.0	36.6
5690	Non HT80, 6 to 54 Mbps	6	97.5	76.7
	VHT80, M0 to M9, M0 to M9 1-1ss	m0x1	84.5	76.7
5700	Non HT20, 6 to 54 Mbps	6	24.0	18.0
	HT/VHT20, M0 to M23	m0	22.9	18.3
5710	Non HT40, 6 to 54 Mbps	6	76.0	37.9
	HT/VHT40, M0 to M23	m0	43.9	36.7
5720	Non HT20, 6 to 54 Mbps	6	23.9	18.0
	HT/VHT20, M0 to M23	m0	22.5	18.3



**26dB / 99% Bandwidth, 5500 MHz, Non HT20, 6 to 54 Mbps**

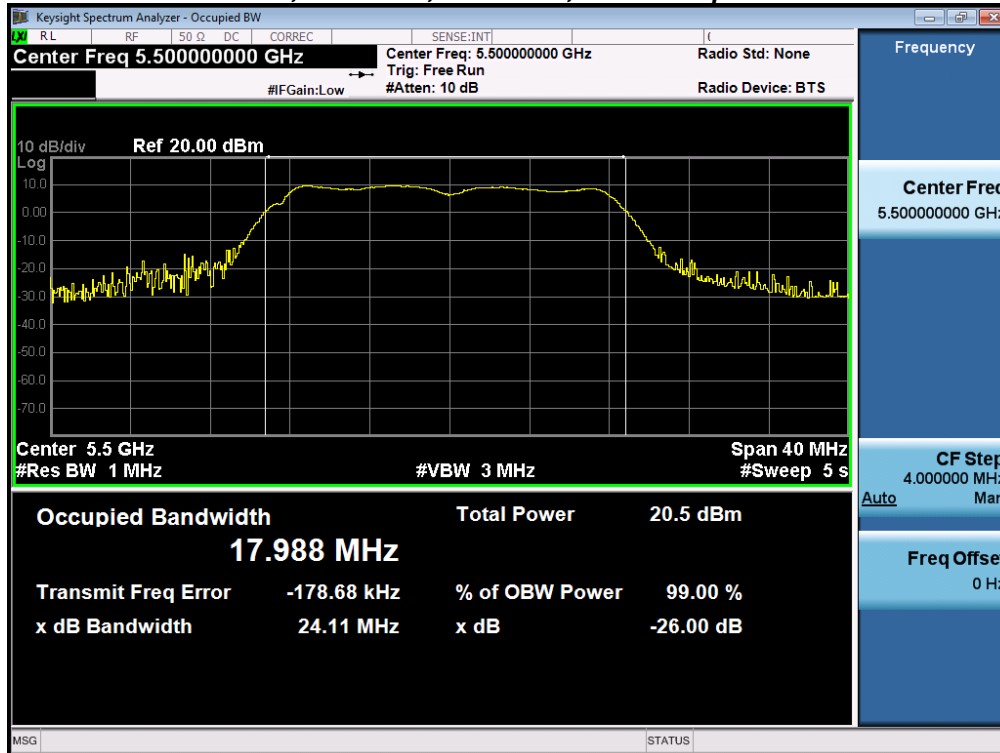

**26dB / 99% Bandwidth, 5500 MHz, HT/VHT20, M0 to M23**

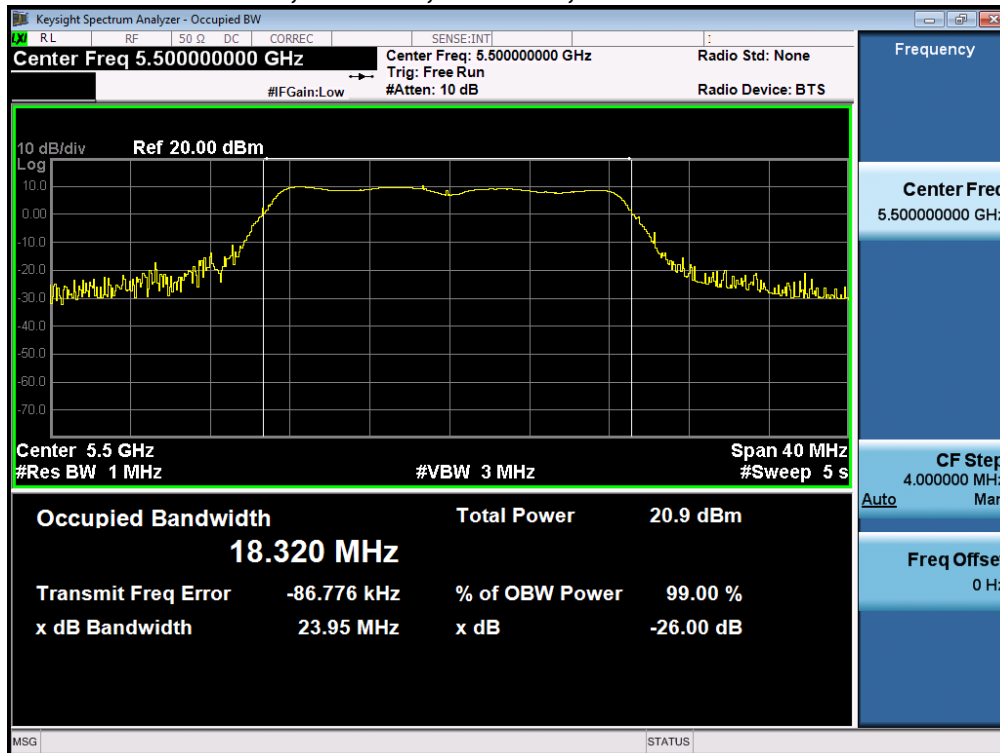





**26dB / 99% Bandwidth, 5510 MHz, Non HT40, 6 to 54 Mbps**

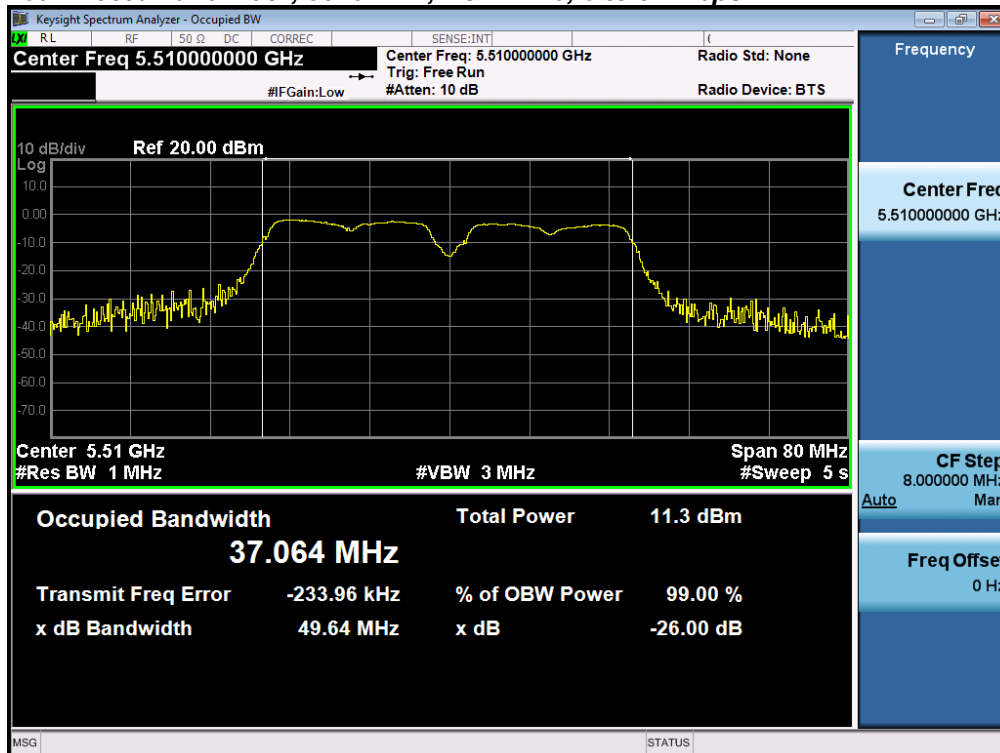

**26dB / 99% Bandwidth, 5510 MHz, HT/VHT40, M0 to M23**

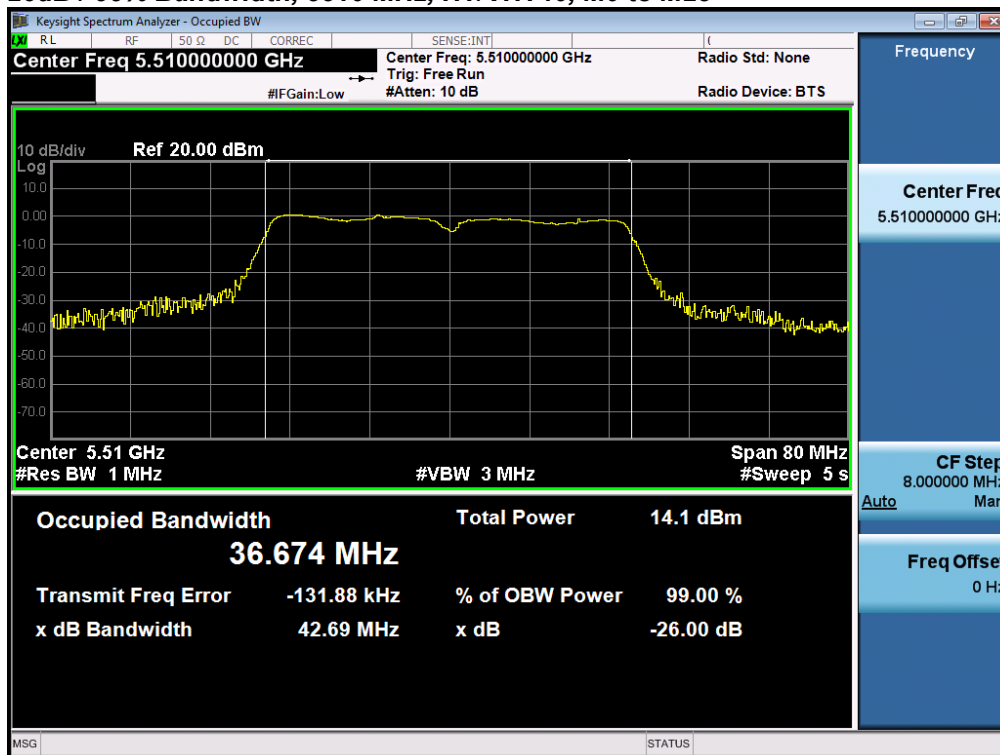



**26dB / 99% Bandwidth, 5530 MHz, Non HT80, 6 to 54 Mbps**

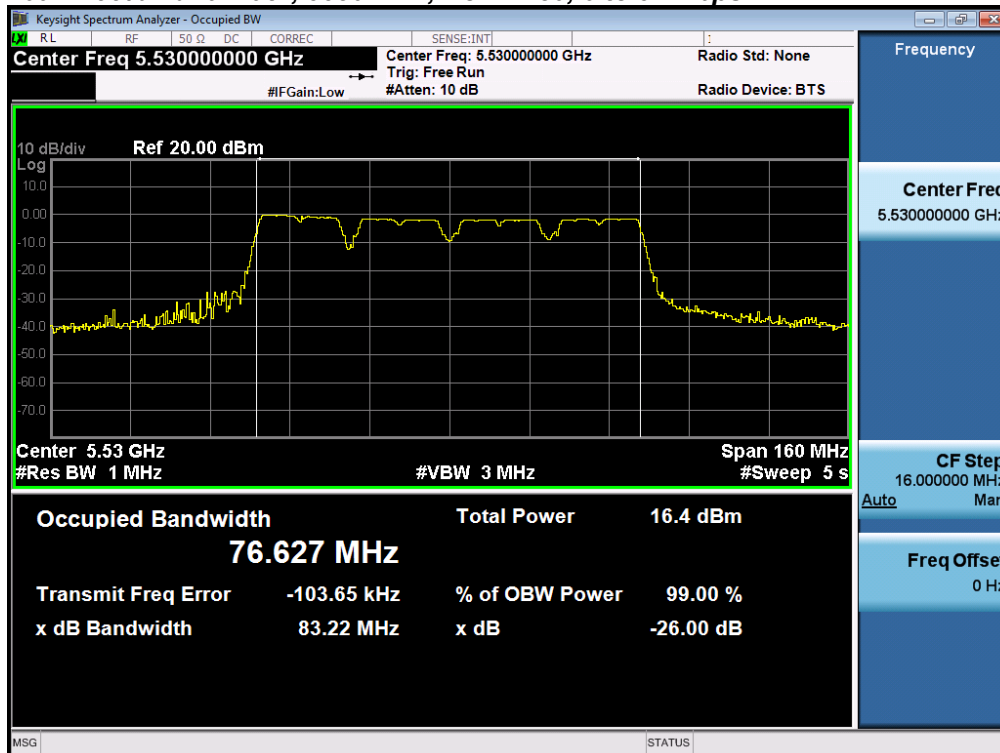

**26dB / 99% Bandwidth, 5530 MHz, VHT80, M0 to M9, M0 to M9 1-1ss**





**26dB / 99% Bandwidth, 5570 MHz, Non HT160, 6 to 54 Mbps**

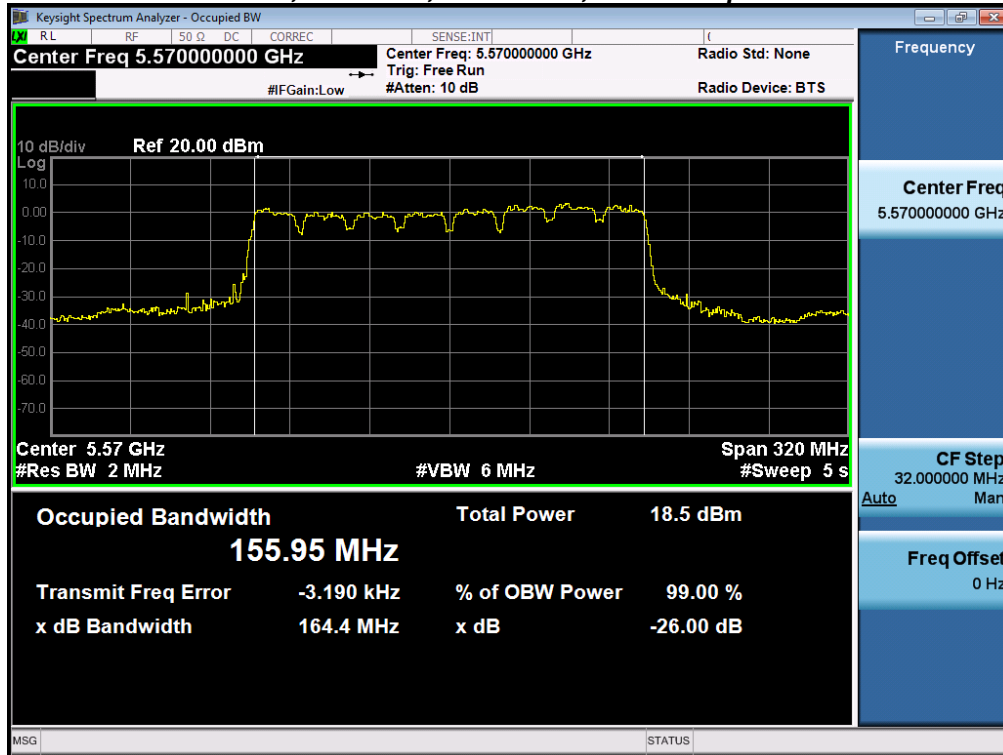

**26dB / 99% Bandwidth, 5570 MHz, VHT160, M0 to M9, M0 to M9 1-1ss**

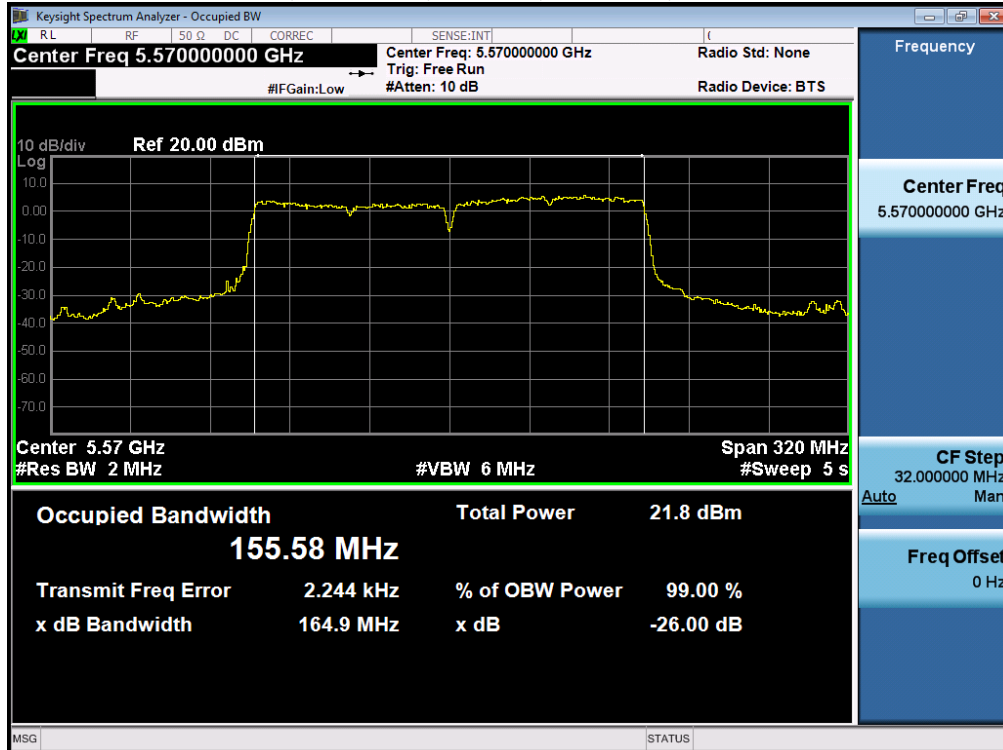



**26dB / 99% Bandwidth, 5560 MHz, Non HT20, 6 to 54 Mbps**

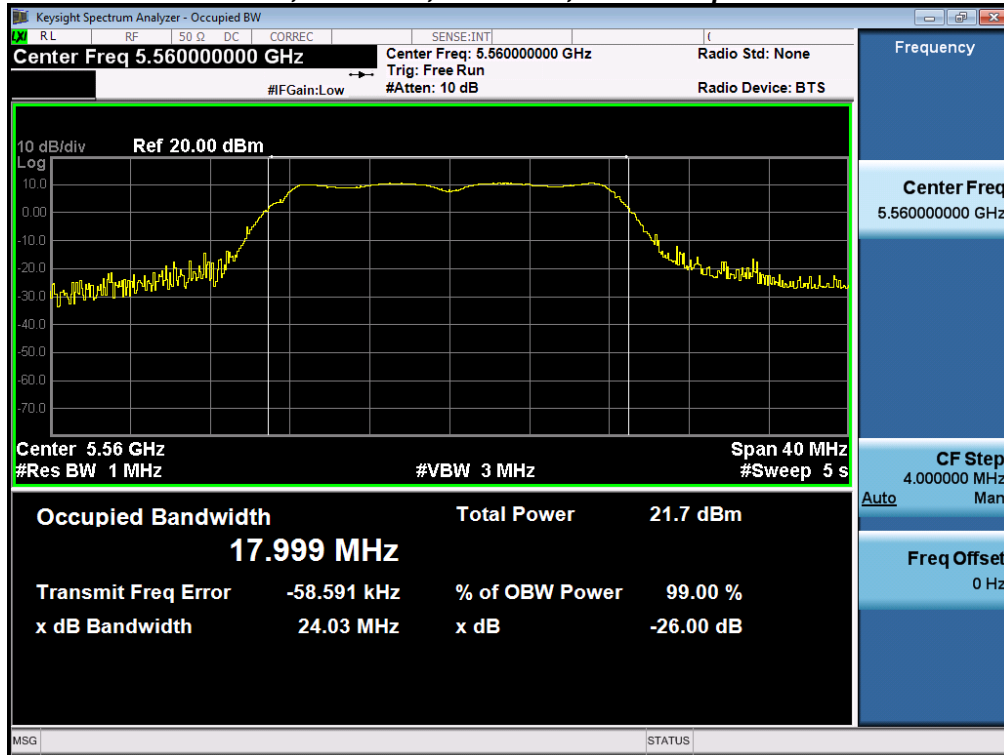

**26dB / 99% Bandwidth, 5560 MHz, HT/VHT20, M0 to M23**

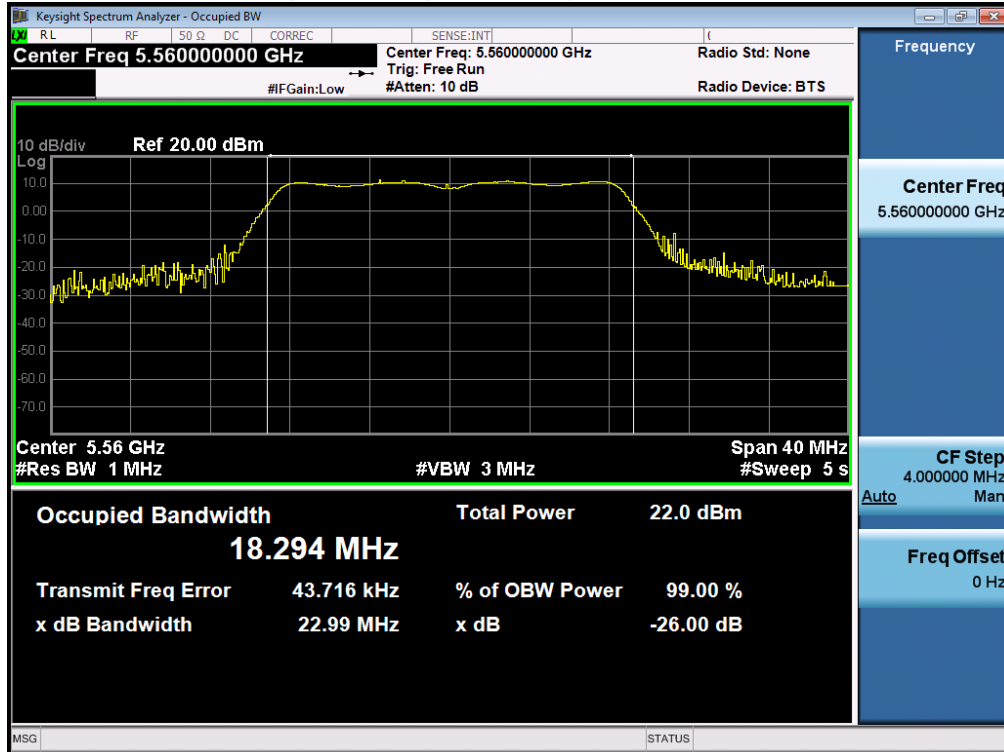



**26dB / 99% Bandwidth, 5660 MHz, Non HT20, 6 to 54 Mbps**

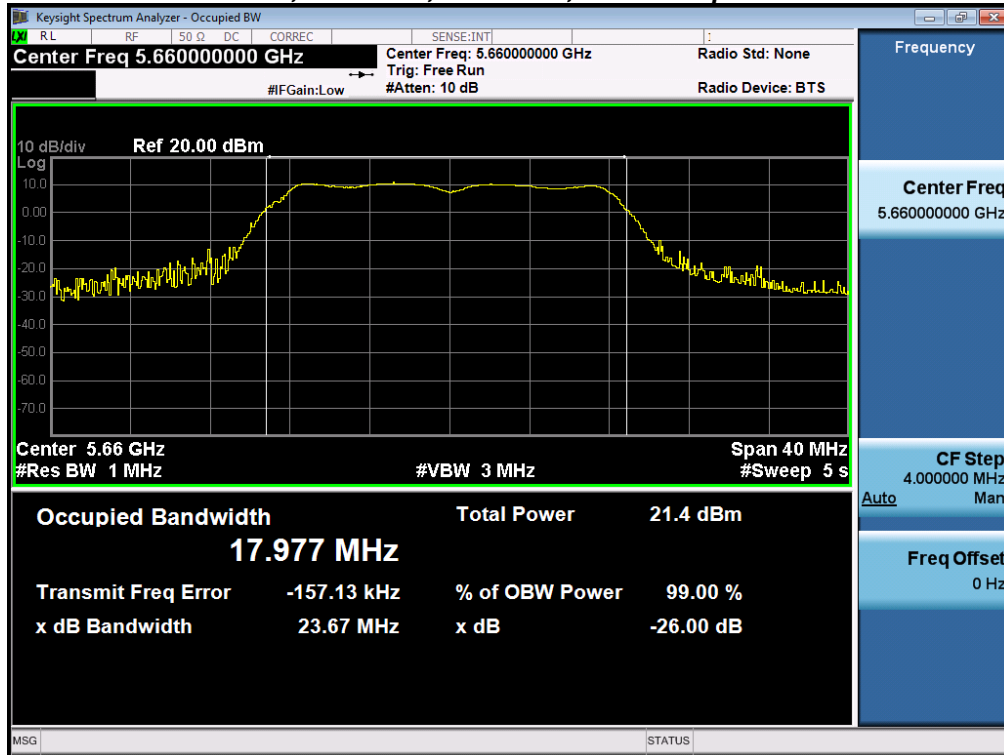

**26dB / 99% Bandwidth, 5660 MHz, HT/VHT20, M0 to M23**

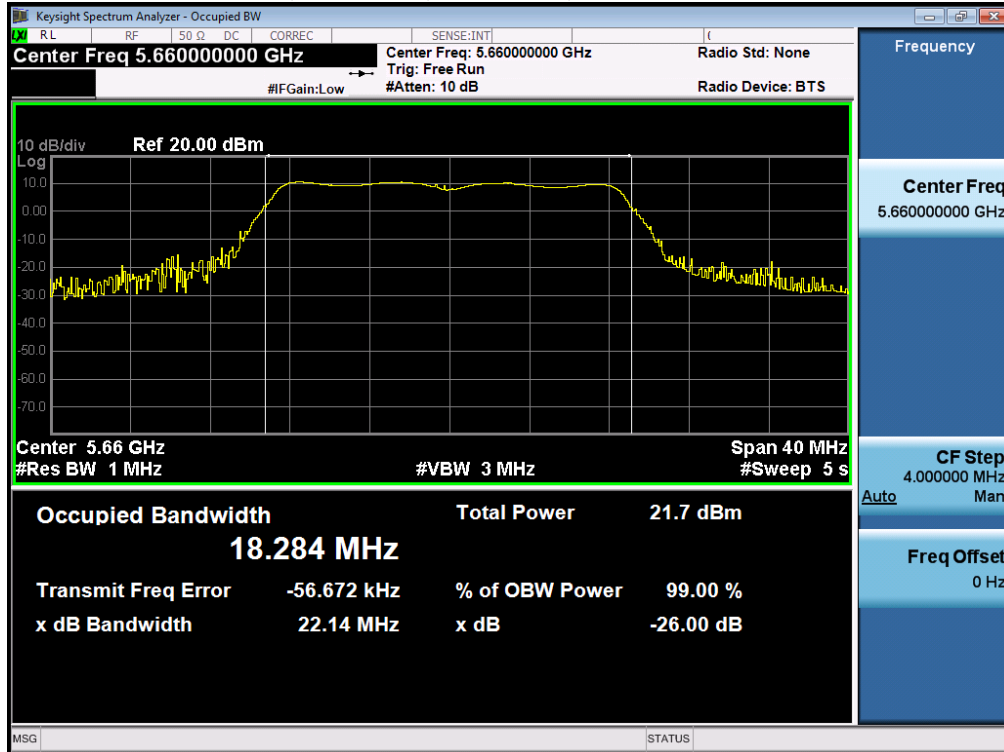



**26dB / 99% Bandwidth, 5670 MHz, Non HT40, 6 to 54 Mbps**

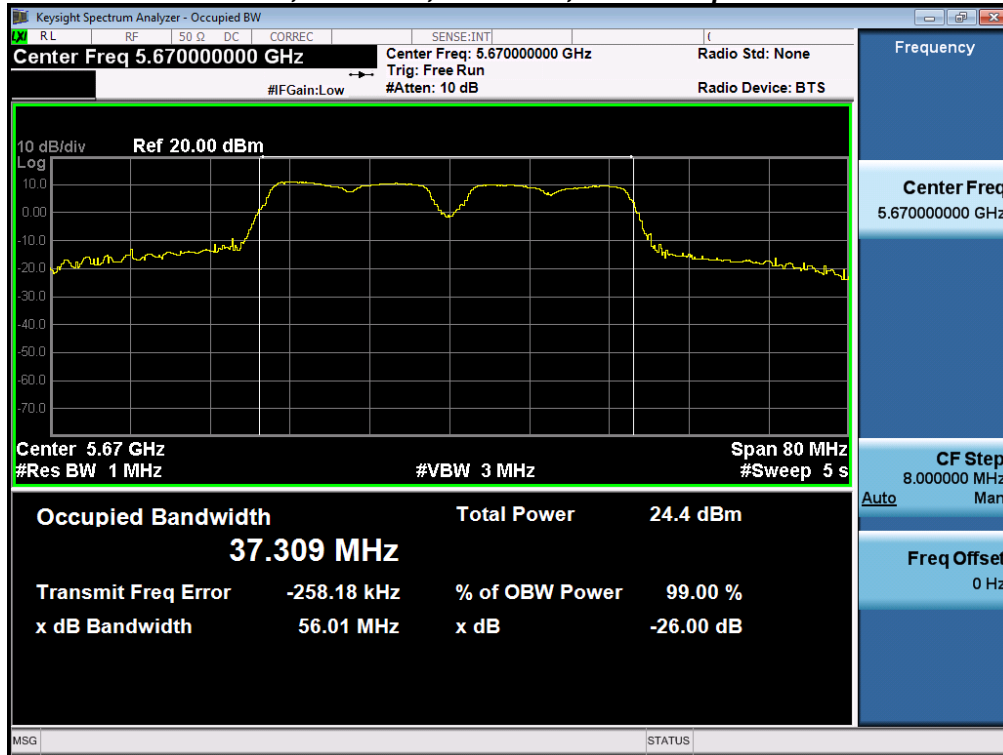

**26dB / 99% Bandwidth, 5670 MHz, HT/VHT40, M0 to M23**

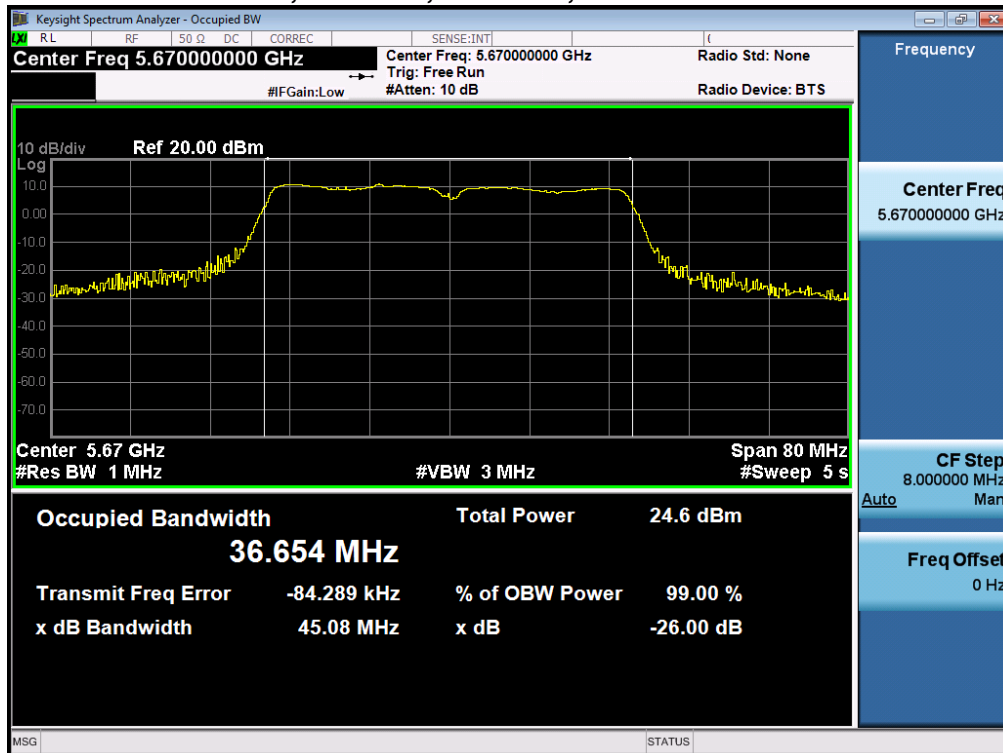



**26dB / 99% Bandwidth, 5690 MHz, Non HT80, 6 to 54 Mbps**

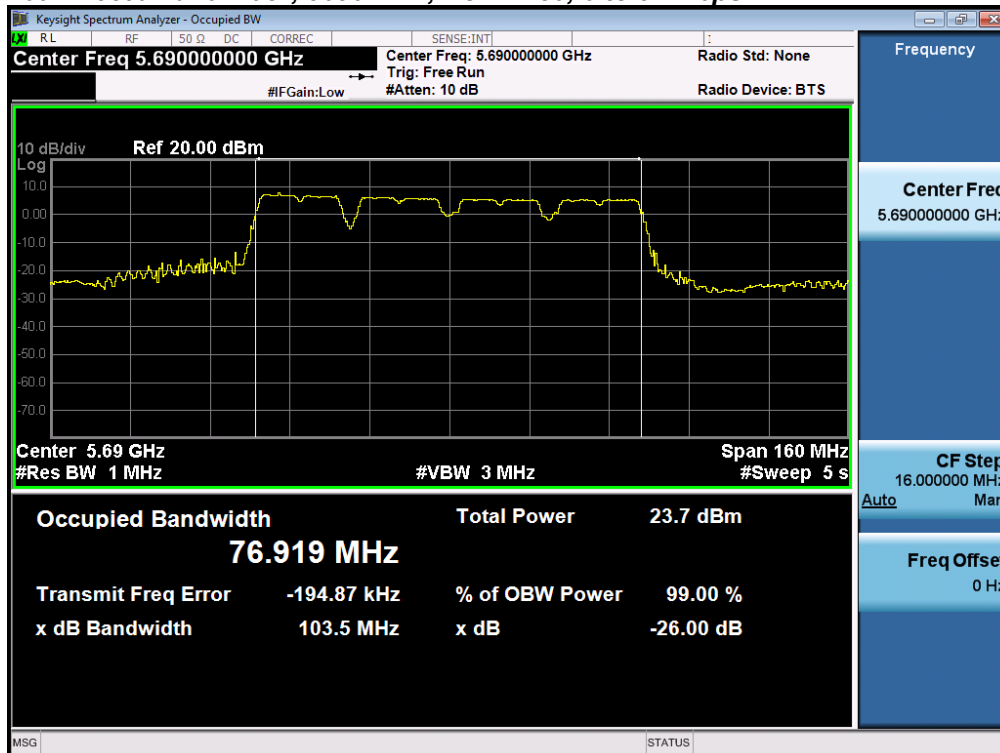

**26dB / 99% Bandwidth, 5690 MHz, VHT80, M0 to M9, M0 to M9 1-1ss**

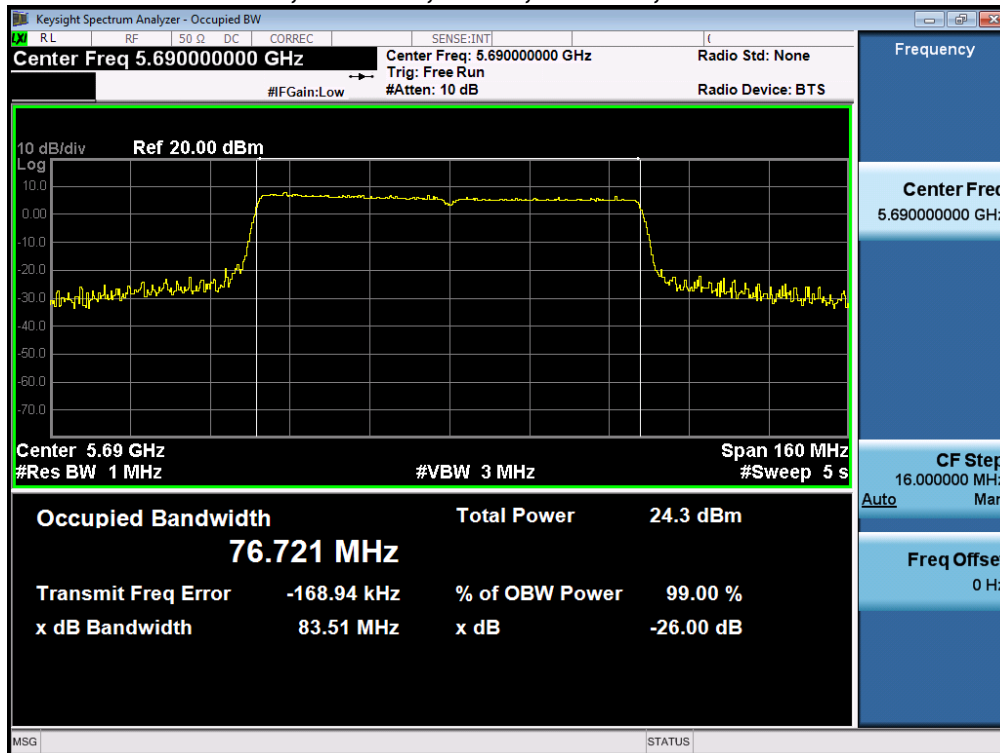



**26dB / 99% Bandwidth, 5700 MHz, Non HT20, 6 to 54 Mbps**

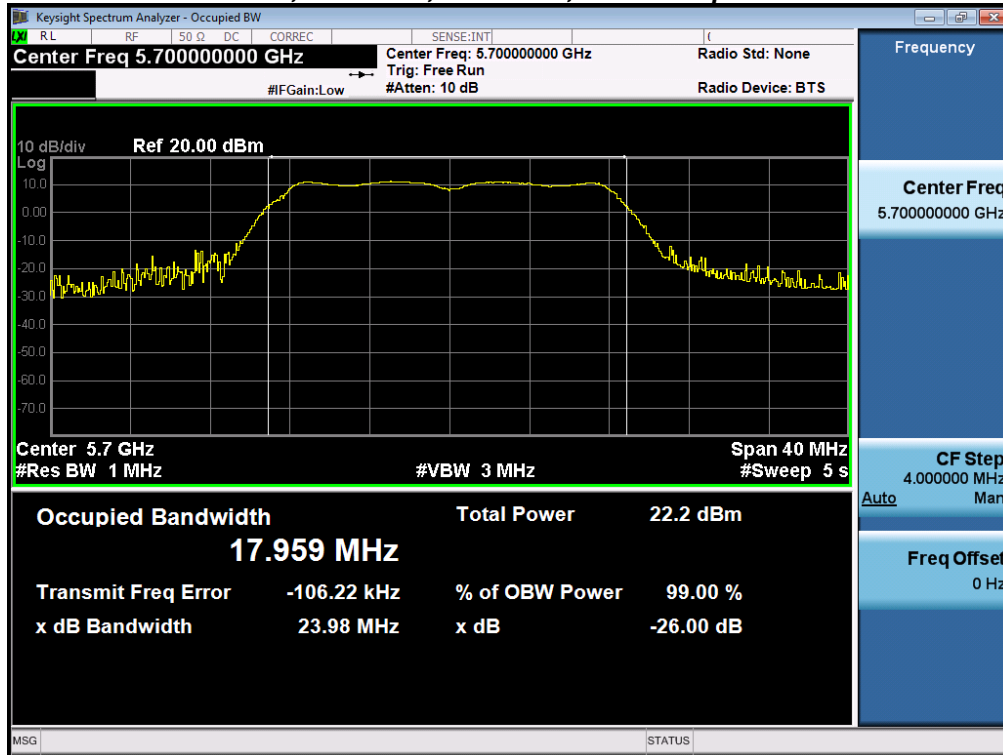

**26dB / 99% Bandwidth, 5700 MHz, HT/VHT20, M0 to M23**

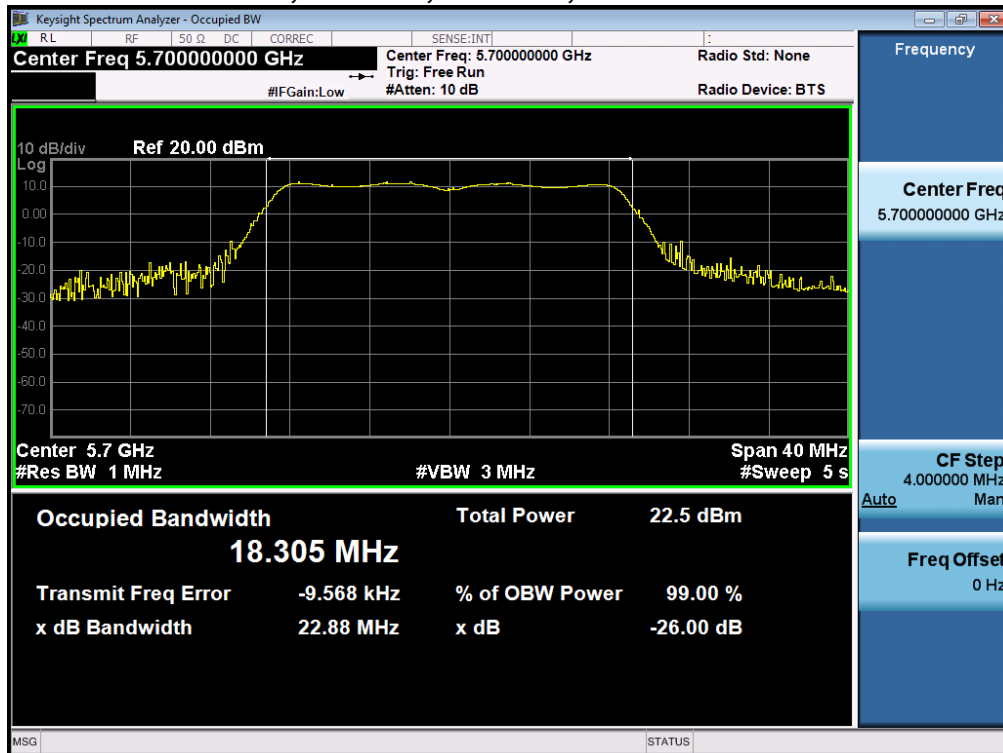





**26dB / 99% Bandwidth, 5710 MHz, Non HT40, 6 to 54 Mbps**

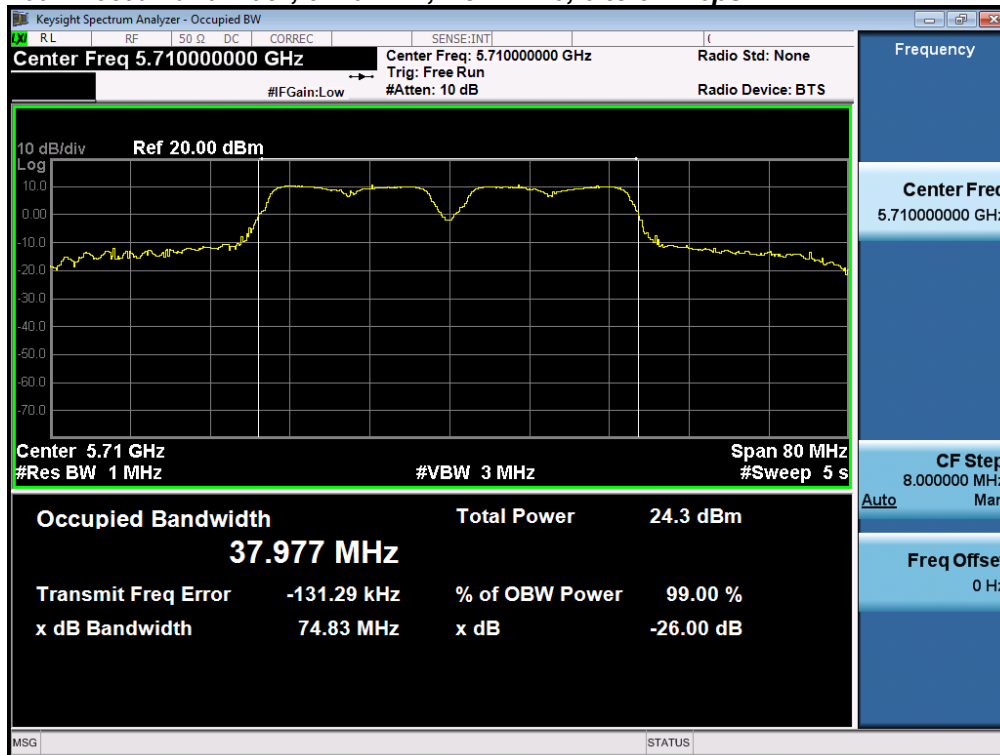

**26dB / 99% Bandwidth, 5710 MHz, HT/VHT40, M0 to M23**

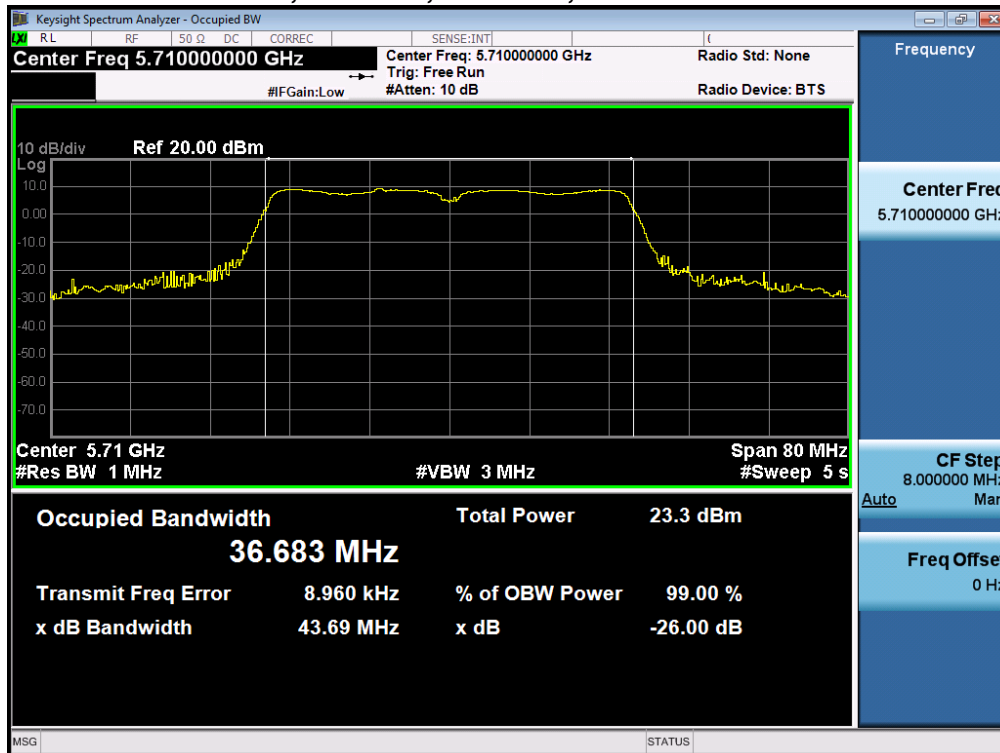



**26dB / 99% Bandwidth, 5720 MHz, Non HT20, 6 to 54 Mbps**

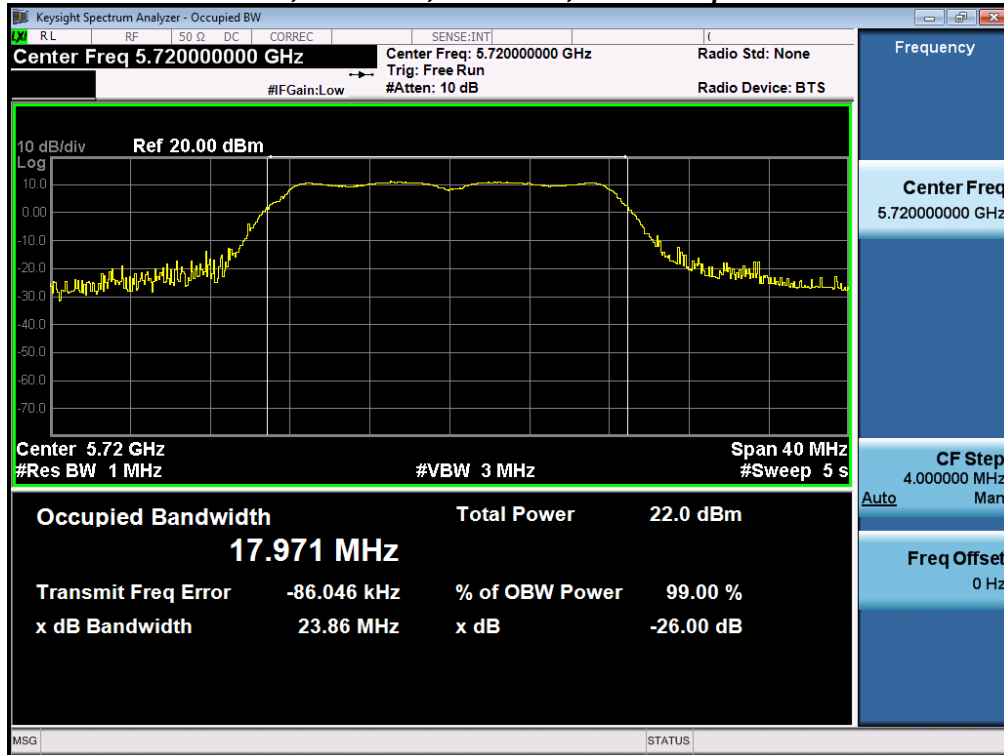

**26dB / 99% Bandwidth, 5720 MHz, HT/VHT20, M0 to M23**

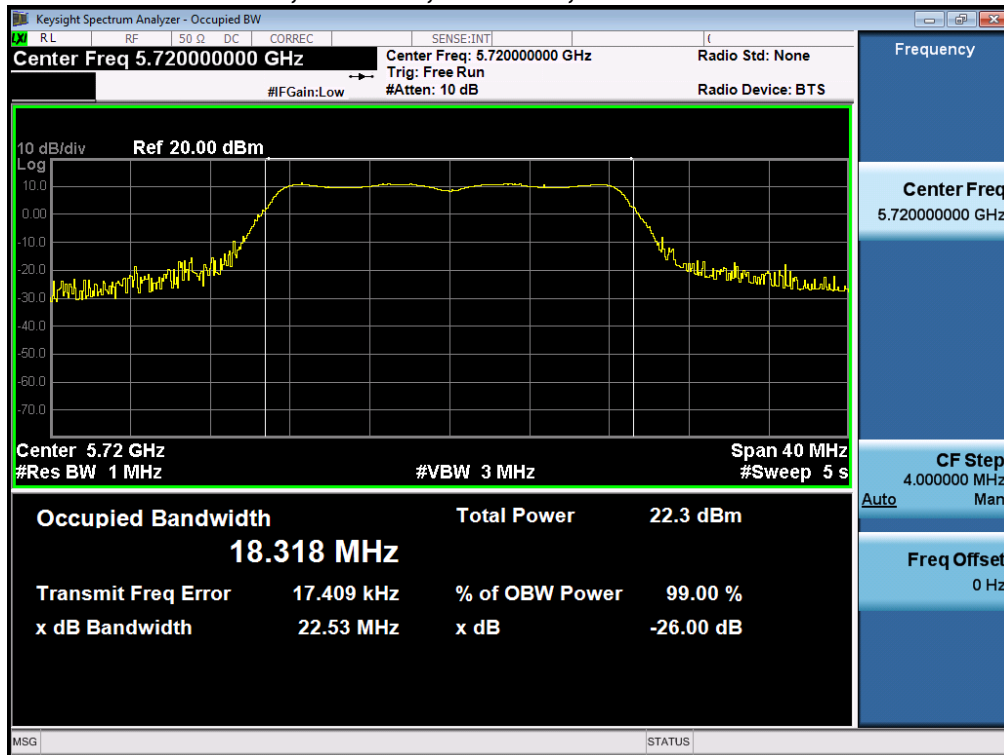

## A.2 Maximum Conducted Output Power/ Power Spectral Density

**15.407 (2)** For the 5.25-5.35 GHz and 5.47-5.725 GHz bands, the maximum conducted output power over the frequency bands of operation shall not exceed the lesser of 250 mW or  $11 \text{ dBm} + 10 \log B$ , where B is the 26 dB emission bandwidth in megahertz. In addition, the maximum power spectral density shall not exceed 11 dBm in any 1 megahertz band. If transmitting antennas of directional gain greater than 6 dBi are used, both the maximum conducted output power and the maximum power spectral density shall be reduced by the amount in dB that the directional gain of the antenna exceeds 6 dBi.

**15.407 a (3)** For the band 5.725-5.85 GHz, the maximum conducted output power over the frequency band of operation shall not exceed 1 W. If transmitting antennas of directional gain greater than 6 dBi are used, both the maximum conducted output power and the maximum power spectral density shall be reduced by the amount in dB that the directional gain of the antenna exceeds 6 dBi. However, fixed point-to-point U-NII devices operating in this band may employ transmitting antennas with directional gain greater than 6 dBi without any corresponding reduction in transmitter conducted power. Fixed, point-to-point operations exclude the use of point-to-multipoint systems, omnidirectional applications, and multiple collocated transmitters transmitting the same information. The operator of the U-NII device, or if the equipment is professionally installed, the installer, is responsible for ensuring that systems employing high gain directional antennas are used exclusively for fixed, point-to-point operations.

The power spectral density shall not exceed 30 dBm in any 500 kHz band. If transmitting antennas of directional gain greater than 6 dBi are used, both the maximum conducted output power and the power spectral density shall be reduced by the amount in dB that the directional gain of the antenna exceeds 6 dBi.

### KDB 644545 D03 (section F.2.b.ii)

When measuring the portion of the maximum conducted output power within a single U-NII band, the power shall be integrated across only the portion of the EBW that falls within that band. That is, if an EBW extends across the boundary between two adjacent bands, the boundary frequency between the bands serves as one edge of the frequency range to be integrated. Integration across an entire U-NII band without regard to 26 dB points is also acceptable for determining conducted output power within that band.

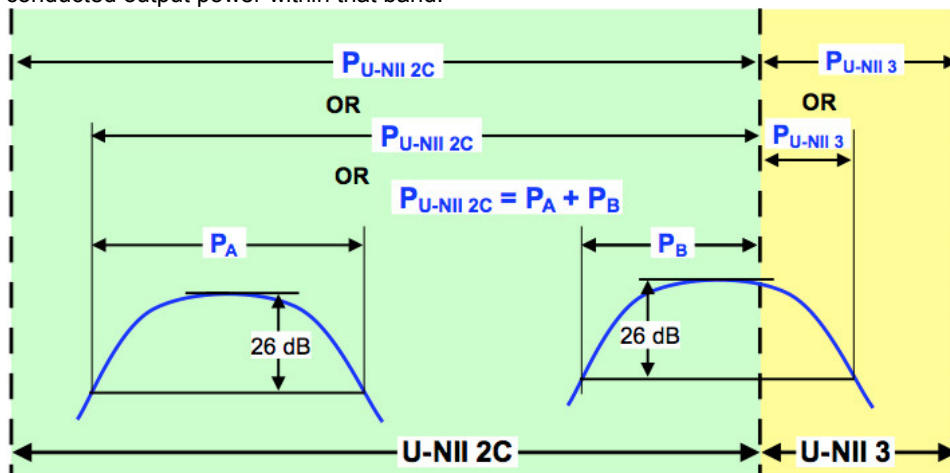

**Conducted output power within a U-NII band:** Integrate over the band, or integrate over a span including the 26 dB EBWs of transmission segments within the band, or integrate over 26 dB EBW of each transmission segment in the band and sum.

**Figure 5. Conducted Output Power Measurement Examples**

The “measure-and-sum technique” is used for measuring in-band transmit power of a device. In the measure-and-sum approach, the conducted emission level is measured at each antenna port. The measured results at the various antenna ports are then summed mathematically to determine the total emission level from the device. Summing is performed in linear power units. (ANSI C63.10: 2013, section 14.3.2.2)



**Test Procedure**

**Ref.** KDB 789033 D02 General UNII Test Procedures New Rules v01r01  
 ANSI C63.10: 2013  
 KDB 644545 D03 v01

<b>Output Power</b>
Test Procedure
<ol style="list-style-type: none"> <li>1. Set the radio in the continuous transmitting mode at full power</li> <li>2. Compute power by integrating the spectrum across the EBW (or alternatively entire 99% OBW) of the signal using the instrument's band power measurement function. The integration shall be performed using the spectrum analyzer band-power measurement function with band limits set equal to the EBW or the OBW band edges.</li> <li>3. Capture graphs and record pertinent measurement data.</li> </ol>

**Ref.** KDB 789033 D02 General UNII Test Procedures New Rules v01r01  
 ANSI C63.10: 2013 section 12.3.2.2 Method SA-1

<b>Output Power</b>
Test parameters
Span = >1.5 times the OBW RBW = 1MHz VBW ≥ 3 x RBW Sweep = Auto couple Detector = sample Trace = Trace Average 100

The “measure-and-sum technique” is used for measuring in-band transmit power of a device. In the measure-and-sum approach, the conducted emission level is measured at each antenna port. The measured results at the various antenna ports are then summed mathematically to determine the total emission level from the device. Summing is performed in linear power units. (See ANSI C63.10 section 14.3.2.2)

<b>Power Spectral Density (UNII 2C band)</b>	<b>Power Spectral Density (UNII 3 band)</b>
Test parameters	Test parameters
ANSI C63.10: 2013 , sec12.3.2.2 Method SA-1	KDB 789033 D02 v01 section F.5
Span = >1.5 times the OBW	Span = >1.5 times the OBW
RBW = 1MHz	RBW = 500 kHz.
VBW ≥ 3 x RBW	VBW ≥ 3 x RBW
Sweep = Auto couple	Sweep = 10s
Detector = Sample	Detector = Peak
Trace = Trace Average 100	Trace = Single Sweep
Marker = Peak Search	Marker = Peak Search

The “Measure and add 10 log(N) dB technique”, where N is the number of outputs, is used for measuring in-band Power Spectral Density. With this technique, spectrum measurements are performed at each output of the device, and the quantity 10 log(4) (or 6dB) is added to the worst case spectrum value before comparing to the emission limit. (ANSI C63.10 2013 section 14.3.2.3)

<b>System Number</b>	<b>Description</b>	<b>Samples</b>	<b>System under test</b>	<b>Support equipment</b>
1	EUT	S01	<input checked="" type="checkbox"/>	<input type="checkbox"/>
	Support	S02	<input type="checkbox"/>	<input checked="" type="checkbox"/>



<b>Tested By :</b> Jose Aguirre	<b>Date of testing:</b> 01-Jan-16 - 03-Mar-16
<b>Test Result : PASS</b>	

See Appendix C for list of test equipment



Antenna Gain : 2 dBi

Frequency (MHz)	Mode	Tx Paths	Correlated Antenna Gain (dBi)	Tx 1 Max Power (dBm)	Tx 2 Max Power (dBm)	Tx 3 Max Power (dBm)	Tx 4 Max Power (dBm)	Total Tx Channel Power (dBm)	Limit (dBm)	Margin (dB)
5500	Non HT20, 6 to 54 Mbps	1	2	16.0				16.0	23.6	7.6
	Non HT20, 6 to 54 Mbps	2	2	16.0	17.3			19.7	23.6	3.9
	Non HT20, 6 to 54 Mbps	3	2	15.8	16.1	15.0		20.4	23.6	3.2
	Non HT20, 6 to 54 Mbps	4	2	13.4	13.7	12.5	12.0	19.0	23.6	4.6
	Non HT20 Beam Forming, 6 to 54 Mbps	2	5	16.0	17.3			19.7	23.6	3.9
	Non HT20 Beam Forming, 6 to 54 Mbps	3	7	14.6	14.9	13.8		19.2	22.6	3.4
	Non HT20 Beam Forming, 6 to 54 Mbps	4	8	12.5	12.7	11.5	11.1	18.0	21.6	3.6
	HT/VHT20, M0 to M7	1	2	17.4				17.4	23.6	6.2
	HT/VHT20, M0 to M7	2	2	17.4	17.6			20.5	23.6	3.1
	HT/VHT20, M8 to M15	2	2	17.4	17.6			20.5	23.6	3.1
	HT/VHT20, M0 to M7	3	2	14.8	15.2	14.0		19.5	23.6	4.1
	HT/VHT20, M8 to M15	3	2	16.1	16.4	15.2		20.7	23.6	2.9
	HT/VHT20, M16 to M23	3	2	16.1	16.4	15.2		20.7	23.6	2.9
	HT/VHT20, M0 to M7	4	2	13.6	13.9	12.7	12.2	19.2	23.6	4.4
	HT/VHT20, M8 to M15	4	2	14.8	15.2	14.0	13.4	20.4	23.6	3.2
	HT/VHT20, M16 to M23	4	2	14.8	15.2	14.0	13.4	20.4	23.6	3.2
	HT/VHT20 Beam Forming, M0 to M7	2	5	17.4	17.6			20.5	23.6	3.1
	HT/VHT20 Beam Forming, M8 to M15	2	2	17.4	17.6			20.5	23.6	3.1
	HT/VHT20 Beam Forming, M0 to M7	3	7	14.8	15.2	14.0		19.5	22.6	3.1
	HT/VHT20 Beam Forming, M8 to M15	3	4	16.1	16.4	15.2		20.7	23.6	2.9
	HT/VHT20 Beam Forming, M16 to M23	3	2	16.1	16.4	15.2		20.7	23.6	2.9
	HT/VHT20 Beam Forming, M0 to M7	4	8	12.7	13.0	11.7	11.3	18.3	21.6	3.3
	HT/VHT20 Beam Forming, M8 to M15	4	5	14.8	15.2	14.0	13.4	20.4	23.6	3.2
	HT/VHT20 Beam Forming, M16 to M23	4	3	14.8	15.2	14.0	13.4	20.4	23.6	3.2
	HT/VHT20 STBC, M0 to M7	2	2	17.4	17.6			20.5	23.6	3.1
	HT/VHT20 STBC, M0 to M7	3	2	16.1	16.4	15.2		20.7	23.6	2.9
	HT/VHT20 STBC, M0 to M7	4	2	14.8	15.2	14.0	13.4	20.4	23.6	3.2
	5510	Non HT40, 6 to 54 Mbps	1	2	13.1				13.1	24.0
Non HT40, 6 to 54 Mbps		2	2	11.5	9.0			13.4	24.0	10.6
Non HT40, 6 to 54 Mbps		3	2	11.5	9.0	8.3		14.6	24.0	9.4
Non HT40, 6 to 54 Mbps		4	2	11.5	9.0	8.3	9.6	15.8	24.0	8.2
HT/VHT40, M0 to M7		1	2	16.7				16.7	24.0	7.3



	HT/VHT40, M0 to M7	2	2	16.7	16.8			19.8	24.0	4.2
	HT/VHT40, M8 to M15	2	2	16.7	16.8			19.8	24.0	4.2
	HT/VHT40, M0 to M7	3	2	15.4	15.6	15.1		20.1	24.0	3.9
	HT/VHT40, M8 to M15	3	2	15.4	15.6	15.1		20.1	24.0	3.9
	HT/VHT40, M16 to M23	3	2	15.4	15.6	15.1		20.1	24.0	3.9
	HT/VHT40, M0 to M7	4	2	14.2	14.5	13.9	13.1	20.0	24.0	4.0
	HT/VHT40, M8 to M15	4	2	14.2	14.5	13.9	13.1	20.0	24.0	4.0
	HT/VHT40, M16 to M23	4	2	14.2	14.5	13.9	13.1	20.0	24.0	4.0
	HT/VHT40 Beam Forming, M0 to M7	2	5	12.9	13.3			16.1	24.0	7.9
	HT/VHT40 Beam Forming, M8 to M15	2	2	16.7	16.8			19.8	24.0	4.2
	HT/VHT40 Beam Forming, M0 to M7	3	7	12.3	9.6	9.0		15.3	23.0	7.7
	HT/VHT40 Beam Forming, M8 to M15	3	4	14.2	14.5	13.9		19.0	24.0	5.0
	HT/VHT40 Beam Forming, M16 to M23	3	2	15.4	15.6	15.1		20.1	24.0	3.9
	HT/VHT40 Beam Forming, M0 to M7	4	8	10.3	7.8	7.0	8.4	14.6	22.0	7.4
	HT/VHT40 Beam Forming, M8 to M15	4	5	12.3	9.6	9.0	10.3	16.5	24.0	7.5
	HT/VHT40 Beam Forming, M16 to M23	4	3	14.2	14.5	13.9	13.1	20.0	24.0	4.0
	HT/VHT40 STBC, M0 to M7	2	2	16.7	16.8			19.8	24.0	4.2
	HT/VHT40 STBC, M0 to M7	3	2	15.4	15.6	15.1		20.1	24.0	3.9
	HT/VHT40 STBC, M0 to M7	4	2	14.2	14.5	13.9	13.1	20.0	24.0	4.0
5530	Non HT80, 6 to 54 Mbps	1	2	14.5				14.5	24.0	9.5
	Non HT80, 6 to 54 Mbps	2	2	13.4	13.7			16.6	24.0	7.4
	Non HT80, 6 to 54 Mbps	3	2	13.4	13.7	13.6		18.3	24.0	5.7
	Non HT80, 6 to 54 Mbps	4	2	13.4	13.7	13.6	13.0	19.5	24.0	4.5
	VHT80, M0 to M9 1ss	1	2	16.3				16.3	24.0	7.7
	VHT80, M0 to M9 1ss	2	2	15.1	15.3			18.2	24.0	5.8
	VHT80, M0 to M9 2ss	2	2	15.1	15.3			18.2	24.0	5.8
	VHT80, M0 to M9 1ss	3	2	15.1	15.3	15.3		20.0	24.0	4.0
	VHT80, M0 to M9 2ss	3	2	15.1	15.3	15.3		20.0	24.0	4.0
	VHT80, M0 to M9 3ss	3	2	15.1	15.3	15.3		20.0	24.0	4.0
	VHT80, M0 to M9 1ss	4	2	15.0	15.4	15.3	14.6	21.1	24.0	2.9
	VHT80, M0 to M9 2ss	4	2	15.0	15.4	15.3	14.6	21.1	24.0	2.9
	VHT80, M0 to M9 3ss	4	2	15.0	15.4	15.3	14.6	21.1	24.0	2.9
	VHT80 Beam Forming, M0 to M9 1ss	2	5	15.1	15.3			18.2	24.0	5.8
	VHT80 Beam Forming, M0 to M9 2ss	2	2	15.1	15.3			18.2	24.0	5.8
	VHT80 Beam Forming, M0 to M9 1ss	3	7	13.9	14.2	14.0		18.8	23.0	4.2
	VHT80 Beam Forming, M0 to M9 2ss	3	4	15.1	15.3	15.3		20.0	24.0	4.0
	VHT80 Beam Forming, M0 to M9 3ss	3	2	15.1	15.3	15.3		20.0	24.0	4.0
	VHT80 Beam Forming, M0 to M9 1ss	4	8	12.7	13.0	13.0	12.5	18.8	22.0	3.2
	VHT80 Beam Forming, M0 to M9 2ss	4	5	13.9	14.2	14.0	13.5	19.9	24.0	4.1
VHT80 Beam Forming, M0 to M9 3ss	4	3	15.0	15.4	15.3	14.6	21.1	24.0	2.9	



	VHT80 STBC, M0 to M9 1ss	2	2	15.1	15.3			18.2	24.0	5.8
	VHT80 STBC, M0 to M9 1ss	3	2	15.1	15.3	15.3		20.0	24.0	4.0
	VHT80 STBC, M0 to M9 1ss	4	2	15.0	15.4	15.3	14.6	21.1	24.0	2.9
5570	Non HT160, 6 to 54 Mbps	1	2	13.4				13.4	24.0	10.6
	Non HT160, 6 to 54 Mbps	2	2	11.2	11.6			14.4	24.0	9.6
	Non HT160, 6 to 54 Mbps	3	2	11.2	11.6	11.0		16.0	24.0	8.0
	Non HT160, 6 to 54 Mbps	4	2	11.2	11.6	11.0	11.1	17.3	24.0	6.7
	VHT160, M0 to M9 1ss	1	2	17.2				17.2	24.0	6.8
	VHT160, M0 to M9 1ss	2	2	16.0	16.3			19.2	24.0	4.8
	VHT160, M0 to M9 2ss	2	2	16.0	16.3			19.2	24.0	4.8
	VHT160, M0 to M9 1ss	3	2	16.0	16.3	15.8		20.8	24.0	3.2
	VHT160, M0 to M9 2ss	3	2	16.0	16.3	15.8		20.8	24.0	3.2
	VHT160, M0 to M9 3ss	3	2	16.0	16.3	15.8		20.8	24.0	3.2
	VHT160, M0 to M9 1ss	4	2	14.8	15.2	14.7	14.8	20.9	24.0	3.1
	VHT160, M0 to M9 2ss	4	2	14.8	15.2	14.7	14.8	20.9	24.0	3.1
	VHT160, M0 to M9 3ss	4	2	14.8	15.2	14.7	14.8	20.9	24.0	3.1
	VHT160 Beam Forming, M0 to M9 1ss	2	5	14.8	15.2			18.0	24.0	6.0
	VHT160 Beam Forming, M0 to M9 2ss	2	2	16.0	16.3			19.2	24.0	4.8
	VHT160 Beam Forming, M0 to M9 1ss	3	7	11.8	12.3	11.7		16.7	23.0	6.3
	VHT160 Beam Forming, M0 to M9 2ss	3	4	14.8	15.2	14.7		19.7	24.0	4.3
	VHT160 Beam Forming, M0 to M9 3ss	3	2	16.0	16.3	15.8		20.8	24.0	3.2
	VHT160 Beam Forming, M0 to M9 1ss	4	8	11.0	9.8	8.5	8.6	15.6	22.0	6.4
	VHT160 Beam Forming, M0 to M9 2ss	4	5	14.8	15.2	14.7	14.8	20.9	24.0	3.1
	VHT160 Beam Forming, M0 to M9 3ss	4	3	14.8	15.2	14.7	14.8	20.9	24.0	3.1
VHT160 STBC, M0 to M9 1ss	2	2	16.0	16.3			19.2	24.0	4.8	
VHT160 STBC, M0 to M9 1ss	3	2	16.0	16.3	15.8		20.8	24.0	3.2	
VHT160 STBC, M0 to M9 1ss	4	2	14.8	15.2	14.7	14.8	20.9	24.0	3.1	
5560	Non HT20, 6 to 54 Mbps	1	2	16.2				16.2	23.6	7.4
	Non HT20, 6 to 54 Mbps	2	2	16.2	16.5			19.4	23.6	4.2
	Non HT20, 6 to 54 Mbps	3	2	15.1	15.3	15.5		20.1	23.6	3.5
	Non HT20, 6 to 54 Mbps	4	2	12.7	13.0	13.1	13.6	19.1	23.6	4.5
	Non HT20 Beam Forming, 6 to 54 Mbps	2	5	16.2	16.5			19.4	23.6	4.2
	Non HT20 Beam Forming, 6 to 54 Mbps	3	7	15.1	15.3	15.5		20.1	22.6	2.5
	Non HT20 Beam Forming, 6 to 54 Mbps	4	8	12.7	13.0	13.1	13.6	19.1	21.6	2.5
	HT/VHT20, M0 to M7	1	2	16.4				16.4	23.6	7.2
	HT/VHT20, M0 to M7	2	2	16.4	16.7			19.6	23.6	4.0
	HT/VHT20, M8 to M15	2	2	16.4	16.7			19.6	23.6	4.0
	HT/VHT20, M0 to M7	3	2	15.3	15.5	15.7		20.3	23.6	3.3
	HT/VHT20, M8 to M15	3	2	16.4	16.7	16.9		21.4	23.6	2.2





	HT/VHT20, M16 to M23	3	2	16.4	16.7	16.9		21.4	23.6	2.2
	HT/VHT20, M0 to M7	4	2	12.9	13.1	13.3	13.8	19.3	23.6	4.3
	HT/VHT20, M8 to M15	4	2	15.2	15.5	15.7	16.1	21.7	23.6	1.9
	HT/VHT20, M16 to M23	4	2	15.2	15.5	15.7	16.1	21.7	23.6	1.9
	HT/VHT20 Beam Forming, M0 to M7	2	5	16.4	16.7			19.6	23.6	4.0
	HT/VHT20 Beam Forming, M8 to M15	2	2	16.4	16.7			19.6	23.6	4.0
	HT/VHT20 Beam Forming, M0 to M7	3	7	15.3	15.5	15.7		20.3	22.6	2.3
	HT/VHT20 Beam Forming, M8 to M15	3	4	16.4	16.7	16.9		21.4	23.6	2.2
	HT/VHT20 Beam Forming, M16 to M23	3	2	16.4	16.7	16.9		21.4	23.6	2.2
	HT/VHT20 Beam Forming, M0 to M7	4	8	12.9	13.1	13.3	13.8	19.3	21.6	2.3
	HT/VHT20 Beam Forming, M8 to M15	4	5	15.2	15.5	15.7	16.1	21.7	23.6	1.9
	HT/VHT20 Beam Forming, M16 to M23	4	3	15.2	15.5	15.7	16.1	21.7	23.6	1.9
	HT/VHT20 STBC, M0 to M7	2	2	16.4	16.7			19.6	23.6	4.0
	HT/VHT20 STBC, M0 to M7	3	2	16.4	16.7	16.9		21.4	23.6	2.2
	HT/VHT20 STBC, M0 to M7	4	2	15.2	15.5	15.7	16.1	21.7	23.6	1.9
5660	Non HT20, 6 to 54 Mbps	1	2	17.1				17.1	23.6	6.5
	Non HT20, 6 to 54 Mbps	2	2	17.1	17.6			20.4	23.6	3.2
	Non HT20, 6 to 54 Mbps	3	2	14.8	15.4	15.5		20.0	23.5	3.5
	Non HT20, 6 to 54 Mbps	4	2	12.7	13.2	13.3	12.5	19.0	23.5	4.5
	Non HT20 Beam Forming, 6 to 54 Mbps	2	5	17.1	17.6			20.4	23.6	3.2
	Non HT20 Beam Forming, 6 to 54 Mbps	3	7	14.8	15.4	15.5		20.0	22.5	2.5
	Non HT20 Beam Forming, 6 to 54 Mbps	4	8	12.7	13.2	13.3	12.5	19.0	21.5	2.5
	HT/VHT20, M0 to M7	1	2	17.3				17.3	23.6	6.3
	HT/VHT20, M0 to M7	2	2	17.3	17.7			20.5	23.6	3.1
	HT/VHT20, M8 to M15	2	2	17.3	17.7			20.5	23.6	3.1
	HT/VHT20, M0 to M7	3	2	14.9	15.5	15.6		20.1	23.6	3.5
	HT/VHT20, M8 to M15	3	2	16.1	16.6	16.7		21.2	23.6	2.4
	HT/VHT20, M16 to M23	3	2	16.1	16.6	16.7		21.2	23.6	2.4
	HT/VHT20, M0 to M7	4	2	12.7	13.3	13.3	12.7	19.0	23.6	4.6
	HT/VHT20, M8 to M15	4	2	14.9	15.5	15.6	14.7	21.2	23.6	2.4
	HT/VHT20, M16 to M23	4	2	14.9	15.5	15.6	14.7	21.2	23.6	2.4
	HT/VHT20 Beam Forming, M0 to M7	2	5	17.3	17.7			20.5	23.6	3.1
	HT/VHT20 Beam Forming, M8 to M15	2	2	17.3	17.7			20.5	23.6	3.1
	HT/VHT20 Beam Forming, M0 to M7	3	7	14.9	15.5	15.6		20.1	22.6	2.5
	HT/VHT20 Beam Forming, M8 to M15	3	4	16.1	16.6	16.7		21.2	23.6	2.4
	HT/VHT20 Beam Forming, M16 to M23	3	2	16.1	16.6	16.7		21.2	23.6	2.4
	HT/VHT20 Beam Forming, M0 to M7	4	8	12.7	13.3	13.3	12.7	19.0	21.6	2.6
	HT/VHT20 Beam Forming, M8 to M15	4	5	14.9	15.5	15.6	14.7	21.2	23.6	2.4
	HT/VHT20 Beam Forming, M16 to M23	4	3	14.9	15.5	15.6	14.7	21.2	23.6	2.4
HT/VHT20 STBC, M0 to M7	2	2	17.3	17.7			20.5	23.6	3.1	



	HT/VHT20 STBC, M0 to M7	3	2	16.1	16.6	16.7		21.2	23.6	2.4
	HT/VHT20 STBC, M0 to M7	4	2	14.9	15.5	15.6	14.7	21.2	23.6	2.4
5670	Non HT40, 6 to 54 Mbps	1	2	17.7				17.7	24.0	6.3
	Non HT40, 6 to 54 Mbps	2	2	17.7	18.1			20.9	24.0	3.1
	Non HT40, 6 to 54 Mbps	3	2	17.7	18.1	18.4		22.8	24.0	1.2
	Non HT40, 6 to 54 Mbps	4	2	15.5	15.9	16.1	15.7	21.8	24.0	2.2
	HT/VHT40, M0 to M7	1	2	16.6				16.6	24.0	7.4
	HT/VHT40, M0 to M7	2	2	16.6	17.0			19.8	24.0	4.2
	HT/VHT40, M8 to M15	2	2	16.6	17.0			19.8	24.0	4.2
	HT/VHT40, M0 to M7	3	2	16.6	17.0	17.3		21.7	24.0	2.3
	HT/VHT40, M8 to M15	3	2	16.6	17.0	17.3		21.7	24.0	2.3
	HT/VHT40, M16 to M23	3	2	16.6	17.0	17.3		21.7	24.0	2.3
	HT/VHT40, M0 to M7	4	2	15.4	15.8	16.1	16.9	22.1	24.0	1.9
	HT/VHT40, M8 to M15	4	2	16.6	17.0	17.3	16.8	23.0	24.0	1.0
	HT/VHT40, M16 to M23	4	2	16.6	17.0	17.3	16.8	23.0	24.0	1.0
	HT/VHT40 Beam Forming, M0 to M7	2	5	16.6	17.0			19.8	24.0	4.2
	HT/VHT40 Beam Forming, M8 to M15	2	2	16.6	17.0			19.8	24.0	4.2
	HT/VHT40 Beam Forming, M0 to M7	3	7	16.6	17.0	17.3		21.7	23.0	1.3
	HT/VHT40 Beam Forming, M8 to M15	3	4	16.6	17.0	17.3		21.7	24.0	2.3
	HT/VHT40 Beam Forming, M16 to M23	3	2	16.6	17.0	17.3		21.7	24.0	2.3
	<b>HT/VHT40 Beam Forming, M0 to M7</b>	<b>4</b>	<b>8</b>	<b>15.4</b>	<b>15.9</b>	<b>16.2</b>	<b>15.8</b>	<b>21.9</b>	<b>22.0</b>	<b>0.1</b>
	HT/VHT40 Beam Forming, M8 to M15	4	5	16.6	17.0	17.3	16.8	23.0	24.0	1.0
	HT/VHT40 Beam Forming, M16 to M23	4	3	16.6	17.0	17.3	16.8	23.0	24.0	1.0
HT/VHT40 STBC, M0 to M7	2	2	16.6	17.0			19.8	24.0	4.2	
HT/VHT40 STBC, M0 to M7	3	2	16.6	17.0	17.3		21.7	24.0	2.3	
HT/VHT40 STBC, M0 to M7	4	2	16.6	17.0	17.3	16.8	23.0	24.0	1.0	
5690	Non HT80, 6 to 54 Mbps	1	2	15.7				15.7	24.0	8.3
	Non HT80, 6 to 54 Mbps	2	2	15.7	16.2			19.0	24.0	5.0
	Non HT80, 6 to 54 Mbps	3	2	15.7	16.2	16.1		20.8	24.0	3.2
	Non HT80, 6 to 54 Mbps	4	2	15.7	16.2	16.1	16.5	22.2	24.0	1.8
	VHT80, M0 to M9 1ss	1	2	15.9				15.9	24.0	8.1
	VHT80, M0 to M9 1ss	2	2	15.9	16.4			19.2	24.0	4.8
	VHT80, M0 to M9 2ss	2	2	15.9	16.4			19.2	24.0	4.8
	VHT80, M0 to M9 1ss	3	2	15.9	16.4	16.3		21.0	24.0	3.0
	VHT80, M0 to M9 2ss	3	2	15.9	16.4	16.3		21.0	24.0	3.0
	VHT80, M0 to M9 3ss	3	2	15.9	16.4	16.3		21.0	24.0	3.0
	VHT80, M0 to M9 1ss	4	2	15.9	16.4	16.3	16.7	22.4	24.0	1.6
	VHT80, M0 to M9 2ss	4	2	15.9	16.4	16.3	16.7	22.4	24.0	1.6
	VHT80, M0 to M9 3ss	4	2	15.9	16.4	16.3	16.7	22.4	24.0	1.6



	VHT80 Beam Forming, M0 to M9 1ss	2	5	15.9	16.4			19.2	24.0	4.8
	VHT80 Beam Forming, M0 to M9 2ss	2	2	15.9	16.4			19.2	24.0	4.8
	VHT80 Beam Forming, M0 to M9 1ss	3	7	15.9	16.4	16.3		21.0	23.0	2.0
	VHT80 Beam Forming, M0 to M9 2ss	3	4	15.9	16.4	16.3		21.0	24.0	3.0
	VHT80 Beam Forming, M0 to M9 3ss	3	2	15.9	16.4	16.3		21.0	24.0	3.0
	VHT80 Beam Forming, M0 to M9 1ss	4	8	14.8	15.3	15.1	16.8	21.6	22.0	0.4
	VHT80 Beam Forming, M0 to M9 2ss	4	5	15.9	16.4	16.3	16.7	22.4	24.0	1.6
	VHT80 Beam Forming, M0 to M9 3ss	4	3	15.9	16.4	16.3	16.7	22.4	24.0	1.6
	VHT80 STBC, M0 to M9 1ss	2	2	15.9	16.4			19.2	24.0	4.8
	VHT80 STBC, M0 to M9 1ss	3	2	15.9	16.4	16.3		21.0	24.0	3.0
	VHT80 STBC, M0 to M9 1ss	4	2	15.9	16.4	16.3	16.7	22.4	24.0	1.6
5700	Non HT20, 6 to 54 Mbps	1	2	15.4				15.4	23.6	8.2
	Non HT20, 6 to 54 Mbps	2	2	15.4	15.8			18.6	23.6	5.0
	Non HT20, 6 to 54 Mbps	3	2	15.4	15.8	15.6		20.4	23.6	3.2
	Non HT20, 6 to 54 Mbps	4	2	12.0	12.5	12.1	13.6	18.6	23.6	5.0
	Non HT20 Beam Forming, 6 to 54 Mbps	2	5	15.4	15.8			18.6	23.6	5.0
	Non HT20 Beam Forming, 6 to 54 Mbps	3	7	15.4	15.8	15.6		20.4	22.6	2.2
	Non HT20 Beam Forming, 6 to 54 Mbps	4	8	12.0	12.5	12.1	13.6	18.6	21.6	3.0
	HT/VHT20, M0 to M7	1	2	15.6				15.6	23.6	8.0
	HT/VHT20, M0 to M7	2	2	15.6	16.0			18.8	23.6	4.8
	HT/VHT20, M8 to M15	2	2	15.6	16.0			18.8	23.6	4.8
	HT/VHT20, M0 to M7	3	2	15.6	16.0	15.7		20.5	23.6	3.1
	HT/VHT20, M8 to M15	3	2	15.6	16.0	15.7		20.5	23.6	3.1
	HT/VHT20, M16 to M23	3	2	15.6	16.0	15.7		20.5	23.6	3.1
	HT/VHT20, M0 to M7	4	2	12.2	12.7	12.4	13.8	18.8	23.6	4.8
	HT/VHT20, M8 to M15	4	2	14.5	14.9	14.6	17.3	21.5	23.6	2.1
	HT/VHT20, M16 to M23	4	2	14.5	14.9	14.6	17.3	21.5	23.6	2.1
	HT/VHT20 Beam Forming, M0 to M7	2	5	15.6	16.0			18.8	23.6	4.8
	HT/VHT20 Beam Forming, M8 to M15	2	2	15.6	16.0			18.8	23.6	4.8
	HT/VHT20 Beam Forming, M0 to M7	3	7	15.6	16.0	15.7		20.5	22.6	2.1
	HT/VHT20 Beam Forming, M8 to M15	3	4	15.6	16.0	15.7		20.5	23.6	3.1
	HT/VHT20 Beam Forming, M16 to M23	3	2	15.6	16.0	15.7		20.5	23.6	3.1
	HT/VHT20 Beam Forming, M0 to M7	4	8	12.2	12.7	12.4	13.8	18.8	21.6	2.8
	HT/VHT20 Beam Forming, M8 to M15	4	5	14.5	14.9	14.6	17.3	21.5	23.6	2.1
	HT/VHT20 Beam Forming, M16 to M23	4	3	14.5	14.9	14.6	17.3	21.5	23.6	2.1
	HT/VHT20 STBC, M0 to M7	2	2	15.6	16.0			18.8	23.6	4.8
	HT/VHT20 STBC, M0 to M7	3	2	15.6	16.0	15.7		20.5	23.6	3.1
HT/VHT20 STBC, M0 to M7	4	2	14.5	14.9	14.6	17.3	21.5	23.6	2.1	



5710	Non HT40, 6 to 54 Mbps	1	2	16.3				16.3	24.0	7.7
	Non HT40, 6 to 54 Mbps	2	2	16.3	16.7			19.5	24.0	4.5
	Non HT40, 6 to 54 Mbps	3	2	16.3	16.7	16.2		21.2	24.0	2.8
	Non HT40, 6 to 54 Mbps	4	2	15.2	15.7	15.1	17.0	21.8	24.0	2.2
	HT/VHT40, M0 to M7	1	2	15.2				15.2	24.0	8.8
	HT/VHT40, M0 to M7	2	2	15.2	15.7			18.5	24.0	5.5
	HT/VHT40, M8 to M15	2	2	15.2	15.7			18.5	24.0	5.5
	HT/VHT40, M0 to M7	3	2	15.2	15.7	15.1		20.1	24.0	3.9
	HT/VHT40, M8 to M15	3	2	15.2	15.7	15.1		20.1	24.0	3.9
	HT/VHT40, M16 to M23	3	2	15.2	15.7	15.1		20.1	24.0	3.9
	HT/VHT40, M0 to M7	4	2	15.2	15.7	15.1	17.0	21.8	24.0	2.2
	HT/VHT40, M8 to M15	4	2	15.2	15.7	15.1	17.0	21.8	24.0	2.2
	HT/VHT40, M16 to M23	4	2	15.2	15.7	15.1	17.0	21.8	24.0	2.2
	HT/VHT40 Beam Forming, M0 to M7	2	5	15.2	15.7			18.5	24.0	5.5
	HT/VHT40 Beam Forming, M8 to M15	2	2	15.2	15.7			18.5	24.0	5.5
	HT/VHT40 Beam Forming, M0 to M7	3	7	15.2	15.7	15.1		20.1	23.0	2.9
	HT/VHT40 Beam Forming, M8 to M15	3	4	15.2	15.7	15.1		20.1	24.0	3.9
	HT/VHT40 Beam Forming, M16 to M23	3	2	15.2	15.7	15.1		20.1	24.0	3.9
	HT/VHT40 Beam Forming, M0 to M7	4	8	14.1	14.5	14.0	17.1	21.1	22.0	0.9
	HT/VHT40 Beam Forming, M8 to M15	4	5	15.2	15.7	15.1	17.0	21.8	24.0	2.2
HT/VHT40 Beam Forming, M16 to M23	4	3	15.2	15.7	15.1	17.0	21.8	24.0	2.2	
HT/VHT40 STBC, M0 to M7	2	2	15.2	15.7			18.5	24.0	5.5	
HT/VHT40 STBC, M0 to M7	3	2	15.2	15.7	15.1		20.1	24.0	3.9	
HT/VHT40 STBC, M0 to M7	4	2	15.2	15.7	15.1	17.0	21.8	24.0	2.2	
5720	Non HT20, 6 to 54 Mbps	1	2	15.2				15.2	23.6	8.4
	Non HT20, 6 to 54 Mbps	2	2	15.2	15.8			18.5	23.6	5.1
	Non HT20, 6 to 54 Mbps	3	2	15.2	15.8	14.8		20.1	23.6	3.5
	Non HT20, 6 to 54 Mbps	4	2	13.0	13.7	12.7	14.8	19.6	23.5	3.9
	Non HT20 Beam Forming, 6 to 54 Mbps	2	5	15.2	15.8			18.5	23.6	5.1
	Non HT20 Beam Forming, 6 to 54 Mbps	3	7	15.2	15.8	14.8		20.1	22.6	2.5
	Non HT20 Beam Forming, 6 to 54 Mbps	4	8	13.0	13.7	12.7	14.8	19.6	21.5	1.9
	HT/VHT20, M0 to M7	1	2	15.3				15.3	23.6	8.3
	HT/VHT20, M0 to M7	2	2	15.3	16.0			18.7	23.6	4.9
	HT/VHT20, M8 to M15	2	2	15.3	16.0			18.7	23.6	4.9
	HT/VHT20, M0 to M7	3	2	15.3	16.0	15.0		20.2	23.6	3.4
	HT/VHT20, M8 to M15	3	2	15.3	16.0	15.0		20.2	23.6	3.4
	HT/VHT20, M16 to M23	3	2	15.3	16.0	15.0		20.2	23.6	3.4
	HT/VHT20, M0 to M7	4	2	13.1	13.7	12.8	14.9	19.7	23.6	3.9
	HT/VHT20, M8 to M15	4	2	14.2	14.8	13.9	17.3	21.3	23.6	2.3



HT/VHT20, M16 to M23	4	2	14.2	14.8	13.9	17.3	21.3	23.6	2.3
HT/VHT20 Beam Forming, M0 to M7	2	5	15.3	16.0			18.7	23.6	4.9
HT/VHT20 Beam Forming, M8 to M15	2	2	15.3	16.0			18.7	23.6	4.9
HT/VHT20 Beam Forming, M0 to M7	3	7	15.3	16.0	15.0		20.2	22.6	2.4
HT/VHT20 Beam Forming, M8 to M15	3	4	15.3	16.0	15.0		20.2	23.6	3.4
HT/VHT20 Beam Forming, M16 to M23	3	2	15.3	16.0	15.0		20.2	23.6	3.4
HT/VHT20 Beam Forming, M0 to M7	4	8	13.1	13.7	12.8	14.9	19.7	21.6	1.9
HT/VHT20 Beam Forming, M8 to M15	4	5	14.2	14.8	13.9	17.3	21.3	23.6	2.3
HT/VHT20 Beam Forming, M16 to M23	4	3	14.2	14.8	13.9	17.3	21.3	23.6	2.3
HT/VHT20 STBC, M0 to M7	2	2	15.3	16.0			18.7	23.6	4.9
HT/VHT20 STBC, M0 to M7	3	2	15.3	16.0	15.0		20.2	23.6	3.4
HT/VHT20 STBC, M0 to M7	4	2	14.2	14.8	13.9	17.3	21.3	23.6	2.3



Frequency (MHz)	Mode	Tx Paths	Correlated Antenna Gain (dBi)	Tx 1 PSD (dBm/MHz)	Tx 2 PSD (dBm/MHz)	Tx 3 PSD (dBm/MHz)	Tx 4 PSD (dBm/MHz)	Total PSD (dBm/MHz)	Limit (dBm/MHz)	Margin (dB)
5500	Non HT20, 6 to 54 Mbps	1	2	5.5				5.5	11.0	5.5
	Non HT20, 6 to 54 Mbps	2	5	5.5	7.1			9.4	11.0	1.6
	<b>Non HT20, 6 to 54 Mbps</b>	<b>3</b>	<b>7</b>	<b>5.2</b>	<b>5.9</b>	<b>4.3</b>		<b>10.0</b>	<b>10.0</b>	<b>0.0</b>
	Non HT20, 6 to 54 Mbps	4	8	3.0	3.3	1.9	1.4	8.5	9.0	0.5
	Non HT20 Beam Forming, 6 to 54 Mbps	2	5	5.5	7.1			9.4	11.0	1.6
	Non HT20 Beam Forming, 6 to 54 Mbps	3	7	4.1	4.3	3.3		8.7	10.0	1.3
	Non HT20 Beam Forming, 6 to 54 Mbps	4	8	2.2	2.2	0.9	0.7	7.6	9.0	1.4
	HT/VHT20, M0 to M7	1	2	7.1				7.1	11.0	3.9
	HT/VHT20, M0 to M7	2	5	7.1	7.5			10.3	11.0	0.7
	HT/VHT20, M8 to M15	2	2	7.1	7.5			10.3	11.0	0.7
	HT/VHT20, M0 to M7	3	7	4.0	4.5	3.4		8.8	10.0	1.2
	HT/VHT20, M8 to M15	3	4	5.6	5.8	4.3		10.1	11.0	0.9
	HT/VHT20, M16 to M23	3	2	5.6	5.8	4.3		10.1	11.0	0.9
	HT/VHT20, M0 to M7	4	8	2.8	3.2	2.3	1.3	8.5	9.0	0.5
	HT/VHT20, M8 to M15	4	5	4.0	4.5	3.4	2.5	9.7	11.0	1.3
	HT/VHT20, M16 to M23	4	3	4.0	4.5	3.4	2.5	9.7	11.0	1.3
	HT/VHT20 Beam Forming, M0 to M7	2	5	7.1	7.5			10.3	11.0	0.7
	HT/VHT20 Beam Forming, M8 to M15	2	2	7.1	7.5			10.3	11.0	0.7
	HT/VHT20 Beam Forming, M0 to M7	3	7	4.0	4.5	3.4		8.8	10.0	1.2
	HT/VHT20 Beam Forming, M8 to M15	3	4	5.6	5.8	4.3		10.1	11.0	0.9
	HT/VHT20 Beam Forming, M16 to M23	3	2	5.6	5.8	4.3		10.1	11.0	0.9
	HT/VHT20 Beam Forming, M0 to M7	4	8	2.0	2.9	1.0	0.8	7.8	9.0	1.2
	HT/VHT20 Beam Forming, M8 to M15	4	5	4.0	4.5	3.4	2.5	9.7	11.0	1.3
	HT/VHT20 Beam Forming, M16 to M23	4	3	4.0	4.5	3.4	2.5	9.7	11.0	1.3
	HT/VHT20 STBC, M0 to M7	2	2	7.1	7.5			10.3	11.0	0.7
	HT/VHT20 STBC, M0 to M7	3	4	5.6	5.8	4.3		10.1	11.0	0.9
	HT/VHT20 STBC, M0 to M7	4	5	4.0	4.5	3.4	2.5	9.7	11.0	1.3
	5510	Non HT40, 6 to 54 Mbps	1	2	0.3				0.3	11.0
Non HT40, 6 to 54 Mbps		2	5	-1.6	-4.6			0.2	11.0	10.8
Non HT40, 6 to 54 Mbps		3	7	-1.6	-4.6	-5.0		1.3	10.0	8.7
Non HT40, 6 to 54 Mbps		4	8	-1.6	-4.6	-5.0	-3.2	2.6	9.0	6.4
HT/VHT40, M0 to M7		1	2	3.6				3.6	11.0	7.4
HT/VHT40, M0 to M7		2	5	3.6	3.6			6.6	11.0	4.4



	HT/VHT40, M8 to M15	2	2	3.6	3.6			6.6	11.0	4.4
	HT/VHT40, M0 to M7	3	7	2.5	2.7	1.6		7.1	10.0	2.9
	HT/VHT40, M8 to M15	3	4	2.5	2.7	1.6		7.1	11.0	3.9
	HT/VHT40, M16 to M23	3	2	2.5	2.7	1.6		7.1	11.0	3.9
	HT/VHT40, M0 to M7	4	8	0.8	1.4	0.1	-0.4	6.5	9.0	2.5
	HT/VHT40, M8 to M15	4	5	0.8	1.4	0.1	-0.4	6.5	11.0	4.5
	HT/VHT40, M16 to M23	4	3	0.8	1.4	0.1	-0.4	6.5	11.0	4.5
	HT/VHT40 Beam Forming, M0 to M7	2	5	0.0	0.1			3.1	11.0	7.9
	HT/VHT40 Beam Forming, M8 to M15	2	2	3.6	3.6			6.6	11.0	4.4
	HT/VHT40 Beam Forming, M0 to M7	3	7	-0.9	-4.2	-4.6		1.9	10.0	8.1
	HT/VHT40 Beam Forming, M8 to M15	3	4	0.8	1.4	0.1		5.6	11.0	5.4
	HT/VHT40 Beam Forming, M16 to M23	3	2	2.5	2.7	1.6		7.1	11.0	3.9
	HT/VHT40 Beam Forming, M0 to M7	4	8	-3.0	-6.2	-7.0	-4.9	1.0	9.0	8.0
	HT/VHT40 Beam Forming, M8 to M15	4	5	-0.9	-4.2	-4.6	-3.2	3.1	11.0	7.9
	HT/VHT40 Beam Forming, M16 to M23	4	3	0.8	1.4	0.1	-0.4	6.5	11.0	4.5
	HT/VHT40 STBC, M0 to M7	2	2	3.6	3.6			6.6	11.0	4.4
	HT/VHT40 STBC, M0 to M7	3	4	2.5	2.7	1.6		7.1	11.0	3.9
	HT/VHT40 STBC, M0 to M7	4	5	0.8	1.4	0.1	-0.4	6.5	11.0	4.5
5530	Non HT80, 6 to 54 Mbps	1	2	-1.8				-1.8	11.0	12.8
	Non HT80, 6 to 54 Mbps	2	5	-2.7	-2.9			0.2	11.0	10.8
	Non HT80, 6 to 54 Mbps	3	7	-2.7	-2.9	-3.2		1.8	10.0	8.2
	Non HT80, 6 to 54 Mbps	4	8	-2.7	-2.9	-3.2	-3.3	3.0	9.0	6.0
	VHT80, M0 to M9 1ss	1	2	-0.5				-0.5	11.0	11.5
	VHT80, M0 to M9 1ss	2	5	-1.8	-1.4			1.4	11.0	9.6
	VHT80, M0 to M9 2ss	2	2	-1.8	-1.4			1.4	11.0	9.6
	VHT80, M0 to M9 1ss	3	7	-1.8	-1.4	-2.1		3.0	10.0	7.0
	VHT80, M0 to M9 2ss	3	4	-1.8	-1.4	-2.1		3.0	11.0	8.0
	VHT80, M0 to M9 3ss	3	2	-1.8	-1.4	-2.1		3.0	11.0	8.0
	VHT80, M0 to M9 1ss	4	8	-1.9	-1.4	-2.0	-1.8	4.3	9.0	4.7
	VHT80, M0 to M9 2ss	4	5	-1.9	-1.4	-2.0	-1.8	4.3	11.0	6.7
	VHT80, M0 to M9 3ss	4	3	-1.9	-1.4	-2.0	-1.8	4.3	11.0	6.7
	VHT80 Beam Forming, M0 to M9 1ss	2	5	-1.8	-1.4			1.4	11.0	9.6
	VHT80 Beam Forming, M0 to M9 2ss	2	2	-1.8	-1.4			1.4	11.0	9.6
	VHT80 Beam Forming, M0 to M9 1ss	3	7	-2.8	-2.6	-2.9		2.0	10.0	8.0
	VHT80 Beam Forming, M0 to M9 2ss	3	4	-1.8	-1.4	-2.1		3.0	11.0	8.0
	VHT80 Beam Forming, M0 to M9 3ss	3	2	-1.8	-1.4	-2.1		3.0	11.0	8.0
	VHT80 Beam Forming, M0 to M9 1ss	4	8	-4.2	-3.4	-4.2	-3.9	2.1	9.0	6.9
	VHT80 Beam Forming, M0 to M9 2ss	4	5	-2.8	-2.6	-2.9	-2.6	3.3	11.0	7.7
VHT80 Beam Forming, M0 to M9 3ss	4	3	-1.9	-1.4	-2.0	-1.8	4.3	11.0	6.7	
VHT80 STBC, M0 to M9 1ss	2	2	-1.8	-1.4			1.4	11.0	9.6	



	VHT80 STBC, M0 to M9 1ss	3	2	-1.8	-1.4	-2.1		3.0	11.0	8.0
	VHT80 STBC, M0 to M9 1ss	4	2	-1.9	-1.4	-2.0	-1.8	4.3	11.0	6.7
5570	Non HT160, 6 to 54 Mbps	1	2	-5.3				-5.3	11.0	16.3
	Non HT160, 6 to 54 Mbps	2	5	-7.4	-6.7			-4.0	11.0	15.0
	Non HT160, 6 to 54 Mbps	3	7	-7.4	-6.7	-8.2		-2.6	10.0	12.6
	Non HT160, 6 to 54 Mbps	4	8	-7.4	-6.7	-8.2	-7.9	-1.5	9.0	10.5
	VHT160, M0 to M9 1ss	1	2	-1.8				-1.8	11.0	12.8
	VHT160, M0 to M9 1ss	2	5	-2.6	-2.6			0.4	11.0	10.6
	VHT160, M0 to M9 2ss	2	2	-2.6	-2.6			0.4	11.0	10.6
	VHT160, M0 to M9 1ss	3	7	-2.6	-2.6	-3.9		1.8	10.0	8.2
	VHT160, M0 to M9 2ss	3	4	-2.6	-2.6	-3.9		1.8	11.0	9.2
	VHT160, M0 to M9 3ss	3	2	-2.6	-2.6	-3.9		1.8	11.0	9.2
	VHT160, M0 to M9 1ss	4	8	-4.1	-3.7	-4.9	-4.4	1.8	9.0	7.2
	VHT160, M0 to M9 2ss	4	5	-4.1	-3.7	-4.9	-4.4	1.8	11.0	9.2
	VHT160, M0 to M9 3ss	4	3	-4.1	-3.7	-4.9	-4.4	1.8	11.0	9.2
	VHT160 Beam Forming, M0 to M9 1ss	2	5	-4.1	-3.7			-0.9	11.0	11.9
	VHT160 Beam Forming, M0 to M9 2ss	2	2	-2.6	-2.6			0.4	11.0	10.6
	VHT160 Beam Forming, M0 to M9 1ss	3	7	-7.1	-6.7	-8.0		-2.5	10.0	12.5
	VHT160 Beam Forming, M0 to M9 2ss	3	4	-4.1	-3.7	-4.9		0.6	11.0	10.4
	VHT160 Beam Forming, M0 to M9 3ss	3	2	-2.6	-2.6	-3.9		1.8	11.0	9.2
	VHT160 Beam Forming, M0 to M9 1ss	4	8	-7.7	-10.4	-11.3	-10.2	-3.7	9.0	12.7
	VHT160 Beam Forming, M0 to M9 2ss	4	5	-4.1	-3.7	-4.9	-4.4	1.8	11.0	9.2
	VHT160 Beam Forming, M0 to M9 3ss	4	3	-4.1	-3.7	-4.9	-4.4	1.8	11.0	9.2
VHT160 STBC, M0 to M9 1ss	2	2	-2.6	-2.6			0.4	11.0	10.6	
VHT160 STBC, M0 to M9 1ss	3	2	-2.6	-2.6	-3.9		1.8	11.0	9.2	
VHT160 STBC, M0 to M9 1ss	4	2	-4.1	-3.7	-4.9	-4.4	1.8	11.0	9.2	
5560	Non HT20, 6 to 54 Mbps	1	2	5.8				5.8	11.0	5.2
	Non HT20, 6 to 54 Mbps	2	5	5.8	6.5			9.2	11.0	1.8
	Non HT20, 6 to 54 Mbps	3	7	4.8	4.8	5.0		9.6	10.0	0.4
	Non HT20, 6 to 54 Mbps	4	8	2.2	2.5	2.5	3.0	8.6	9.0	0.4
	Non HT20 Beam Forming, 6 to 54 Mbps	2	5	5.8	6.5			9.2	11.0	1.8
	Non HT20 Beam Forming, 6 to 54 Mbps	3	7	4.8	4.8	5.0		9.6	10.0	0.4
	Non HT20 Beam Forming, 6 to 54 Mbps	4	8	2.2	2.5	2.5	3.0	8.6	9.0	0.4
	HT/VHT20, M0 to M7	1	2	5.6				5.6	11.0	5.4
	HT/VHT20, M0 to M7	2	5	5.6	6.0			8.8	11.0	2.2
	HT/VHT20, M8 to M15	2	2	5.6	6.0			8.8	11.0	2.2
	HT/VHT20, M0 to M7	3	7	5.0	4.8	4.8		9.6	10.0	0.4
	HT/VHT20, M8 to M15	3	4	5.6	6.0	6.1		10.7	11.0	0.3
	HT/VHT20, M16 to M23	3	2	5.6	6.0	6.1		10.7	11.0	0.3





	HT/VHT20, M0 to M7	4	8	2.7	2.4	2.5	3.0	8.7	9.0	0.3
	HT/VHT20, M8 to M15	4	5	4.3	5.0	5.0	5.4	11.0	11.0	0.0
	HT/VHT20, M16 to M23	4	3	4.3	5.0	5.0	5.4	11.0	11.0	0.0
	HT/VHT20 Beam Forming, M0 to M7	2	5	5.6	6.0			8.8	11.0	2.2
	HT/VHT20 Beam Forming, M8 to M15	2	2	5.6	6.0			8.8	11.0	2.2
	HT/VHT20 Beam Forming, M0 to M7	3	7	5.0	4.8	4.8		9.6	10.0	0.4
	HT/VHT20 Beam Forming, M8 to M15	3	4	5.6	6.0	6.1		10.7	11.0	0.3
	HT/VHT20 Beam Forming, M16 to M23	3	2	5.6	6.0	6.1		10.7	11.0	0.3
	HT/VHT20 Beam Forming, M0 to M7	4	8	2.7	2.4	2.5	3.0	8.7	9.0	0.3
	HT/VHT20 Beam Forming, M8 to M15	4	5	4.3	5.0	5.0	5.4	11.0	11.0	0.0
	HT/VHT20 Beam Forming, M16 to M23	4	3	4.3	5.0	5.0	5.4	11.0	11.0	0.0
	HT/VHT20 STBC, M0 to M7	2	2	5.6	6.0			8.8	11.0	2.2
	HT/VHT20 STBC, M0 to M7	3	4	5.6	6.0	6.1		10.7	11.0	0.3
	HT/VHT20 STBC, M0 to M7	4	5	4.3	5.0	5.0	5.4	11.0	11.0	0.0
5660	Non HT20, 6 to 54 Mbps	1	2	6.8				6.8	11.0	4.2
	Non HT20, 6 to 54 Mbps	2	5	6.8	6.9			9.9	11.0	1.1
	Non HT20, 6 to 54 Mbps	3	7	4.5	4.9	4.8		9.5	10.0	0.5
	Non HT20, 6 to 54 Mbps	4	8	2.4	2.8	2.8	2.0	8.5	9.0	0.5
	Non HT20 Beam Forming, 6 to 54 Mbps	2	5	6.8	6.9			9.9	11.0	1.1
	Non HT20 Beam Forming, 6 to 54 Mbps	3	7	4.5	4.9	4.8		9.5	10.0	0.5
	Non HT20 Beam Forming, 6 to 54 Mbps	4	8	2.4	2.8	2.8	2.0	8.5	9.0	0.5
	HT/VHT20, M0 to M7	1	2	6.5				6.5	11.0	4.5
	HT/VHT20, M0 to M7	2	5	6.5	7.0			9.8	11.0	1.2
	HT/VHT20, M8 to M15	2	2	6.5	7.0			9.8	11.0	1.2
	HT/VHT20, M0 to M7	3	7	4.3	4.7	4.5		9.3	10.0	0.7
	HT/VHT20, M8 to M15	3	4	5.3	5.8	5.8		10.4	11.0	0.6
	HT/VHT20, M16 to M23	3	2	5.3	5.8	5.8		10.4	11.0	0.6
	HT/VHT20, M0 to M7	4	8	1.9	2.8	2.8	1.9	8.4	9.0	0.6
	HT/VHT20, M8 to M15	4	5	4.3	4.7	4.5	3.9	10.4	11.0	0.6
	HT/VHT20, M16 to M23	4	3	4.3	4.7	4.5	3.9	10.4	11.0	0.6
	HT/VHT20 Beam Forming, M0 to M7	2	5	6.5	7.0			9.8	11.0	1.2
	HT/VHT20 Beam Forming, M8 to M15	2	2	6.5	7.0			9.8	11.0	1.2
	HT/VHT20 Beam Forming, M0 to M7	3	7	4.3	4.7	4.5		9.3	10.0	0.7
	HT/VHT20 Beam Forming, M8 to M15	3	4	5.3	5.8	5.8		10.4	11.0	0.6
	HT/VHT20 Beam Forming, M16 to M23	3	2	5.3	5.8	5.8		10.4	11.0	0.6
	HT/VHT20 Beam Forming, M0 to M7	4	8	1.9	2.8	2.8	1.9	8.4	9.0	0.6
HT/VHT20 Beam Forming, M8 to M15	4	5	4.3	4.7	4.5	3.9	10.4	11.0	0.6	
HT/VHT20 Beam Forming, M16 to M23	4	3	4.3	4.7	4.5	3.9	10.4	11.0	0.6	
HT/VHT20 STBC, M0 to M7	2	2	6.5	7.0			9.8	11.0	1.2	
HT/VHT20 STBC, M0 to M7	3	4	5.3	5.8	5.8		10.4	11.0	0.6	



	HT/VHT20 STBC, M0 to M7	4	5	4.3	4.7	4.5	3.9	10.4	11.0	0.6
5670	Non HT40, 6 to 54 Mbps	1	2	4.8				4.8	11.0	6.2
	Non HT40, 6 to 54 Mbps	2	5	4.8	4.9			7.9	11.0	3.1
	Non HT40, 6 to 54 Mbps	3	7	4.8	4.9	5.2		9.7	10.0	0.3
	Non HT40, 6 to 54 Mbps	4	8	2.3	2.9	2.8	2.2	8.6	9.0	0.4
	HT/VHT40, M0 to M7	1	2	3.7				3.7	11.0	7.3
	HT/VHT40, M0 to M7	2	5	3.7	3.9			6.8	11.0	4.2
	HT/VHT40, M8 to M15	2	2	3.7	3.9			6.8	11.0	4.2
	HT/VHT40, M0 to M7	3	7	3.7	3.9	3.9		8.6	10.0	1.4
	HT/VHT40, M8 to M15	3	4	3.7	3.9	3.9		8.6	11.0	2.4
	HT/VHT40, M16 to M23	3	2	3.7	3.9	3.9		8.6	11.0	2.4
	HT/VHT40, M0 to M7	4	8	1.9	2.7	2.5	3.0	8.6	9.0	0.4
	HT/VHT40, M8 to M15	4	5	3.7	3.9	3.9	3.3	9.7	11.0	1.3
	HT/VHT40, M16 to M23	4	3	3.7	3.9	3.9	3.3	9.7	11.0	1.3
	HT/VHT40 Beam Forming, M0 to M7	2	5	3.7	3.9			6.8	11.0	4.2
	HT/VHT40 Beam Forming, M8 to M15	2	2	3.7	3.9			6.8	11.0	4.2
	HT/VHT40 Beam Forming, M0 to M7	3	7	3.7	3.9	3.9		8.6	10.0	1.4
	HT/VHT40 Beam Forming, M8 to M15	3	4	3.7	3.9	3.9		8.6	11.0	2.4
	HT/VHT40 Beam Forming, M16 to M23	3	2	3.7	3.9	3.9		8.6	11.0	2.4
	HT/VHT40 Beam Forming, M0 to M7	4	8	2.3	2.5	2.6	2.2	8.4	9.0	0.6
	HT/VHT40 Beam Forming, M8 to M15	4	5	3.7	3.9	3.9	3.3	9.7	11.0	1.3
HT/VHT40 Beam Forming, M16 to M23	4	3	3.7	3.9	3.9	3.3	9.7	11.0	1.3	
HT/VHT40 STBC, M0 to M7	2	2	3.7	3.9			6.8	11.0	4.2	
HT/VHT40 STBC, M0 to M7	3	4	3.7	3.9	3.9		8.6	11.0	2.4	
HT/VHT40 STBC, M0 to M7	4	5	3.7	3.9	3.9	3.3	9.7	11.0	1.3	
5690	Non HT80, 6 to 54 Mbps	1	2	-0.8				-0.8	11.0	11.8
	Non HT80, 6 to 54 Mbps	2	5	-0.8	-0.1			2.6	11.0	8.4
	Non HT80, 6 to 54 Mbps	3	7	-0.8	-0.1	0.2		4.6	10.0	5.4
	Non HT80, 6 to 54 Mbps	4	8	-0.8	-0.1	0.2	-0.3	5.8	9.0	3.2
	VHT80, M0 to M9 1ss	1	2	-0.5				-0.5	11.0	11.5
	VHT80, M0 to M9 1ss	2	5	-0.5	-0.3			2.6	11.0	8.4
	VHT80, M0 to M9 2ss	2	2	-0.5	-0.3			2.6	11.0	8.4
	VHT80, M0 to M9 1ss	3	7	-0.5	-0.3	-0.3		4.4	10.0	5.6
	VHT80, M0 to M9 2ss	3	4	-0.5	-0.3	-0.3		4.4	11.0	6.6
	VHT80, M0 to M9 3ss	3	2	-0.5	-0.3	-0.3		4.4	11.0	6.6
	VHT80, M0 to M9 1ss	4	8	-0.5	-0.3	-0.3	-0.7	5.6	9.0	3.4
	VHT80, M0 to M9 2ss	4	5	-0.5	-0.3	-0.3	-0.7	5.6	11.0	5.4
	VHT80, M0 to M9 3ss	4	3	-0.5	-0.3	-0.3	-0.7	5.6	11.0	5.4
	VHT80 Beam Forming, M0 to M9 1ss	2	5	-0.5	-0.3			2.6	11.0	8.4



	VHT80 Beam Forming, M0 to M9 2ss	2	2	-0.5	-0.3			2.6	11.0	8.4
	VHT80 Beam Forming, M0 to M9 1ss	3	7	-0.5	-0.3	-0.3		4.4	10.0	5.6
	VHT80 Beam Forming, M0 to M9 2ss	3	4	-0.5	-0.3	-0.3		4.4	11.0	6.6
	VHT80 Beam Forming, M0 to M9 3ss	3	2	-0.5	-0.3	-0.3		4.4	11.0	6.6
	VHT80 Beam Forming, M0 to M9 1ss	4	8	-1.8	-1.5	-1.4	-0.8	4.7	9.0	4.3
	VHT80 Beam Forming, M0 to M9 2ss	4	5	-0.5	-0.3	-0.3	-0.7	5.6	11.0	5.4
	VHT80 Beam Forming, M0 to M9 3ss	4	3	-0.5	-0.3	-0.3	-0.7	5.6	11.0	5.4
	VHT80 STBC, M0 to M9 1ss	2	2	-0.5	-0.3			2.6	11.0	8.4
	VHT80 STBC, M0 to M9 1ss	3	2	-0.5	-0.3	-0.3		4.4	11.0	6.6
	VHT80 STBC, M0 to M9 1ss	4	2	-0.5	-0.3	-0.3	-0.7	5.6	11.0	5.4
5700	Non HT20, 6 to 54 Mbps	1	2	4.7				4.7	11.0	6.3
	Non HT20, 6 to 54 Mbps	2	5	4.7	5.1			7.9	11.0	3.1
	Non HT20, 6 to 54 Mbps	3	7	4.7	5.1	5.2		9.8	10.0	0.2
	Non HT20, 6 to 54 Mbps	4	8	1.3	1.9	1.6	3.1	8.1	9.0	0.9
	Non HT20 Beam Forming, 6 to 54 Mbps	2	5	4.7	5.1			7.9	11.0	3.1
	Non HT20 Beam Forming, 6 to 54 Mbps	3	7	4.7	5.1	5.2		9.8	10.0	0.2
	Non HT20 Beam Forming, 6 to 54 Mbps	4	8	1.3	1.9	1.6	3.1	8.1	9.0	0.9
	HT/VHT20, M0 to M7	1	2	4.6				4.6	11.0	6.4
	HT/VHT20, M0 to M7	2	5	4.6	5.1			7.9	11.0	3.1
	HT/VHT20, M8 to M15	2	2	4.6	5.1			7.9	11.0	3.1
	HT/VHT20, M0 to M7	3	7	4.6	5.1	5.3		9.8	10.0	0.2
	HT/VHT20, M8 to M15	3	4	4.6	5.1	5.3		9.8	11.0	1.2
	HT/VHT20, M16 to M23	3	2	4.6	5.1	5.3		9.8	11.0	1.2
	HT/VHT20, M0 to M7	4	8	1.5	1.7	1.9	3.0	8.1	9.0	0.9
	HT/VHT20, M8 to M15	4	5	3.7	4.0	4.0	6.3	10.7	11.0	0.3
	HT/VHT20, M16 to M23	4	3	3.7	4.0	4.0	6.3	10.7	11.0	0.3
	HT/VHT20 Beam Forming, M0 to M7	2	5	4.6	5.1			7.9	11.0	3.1
	HT/VHT20 Beam Forming, M8 to M15	2	2	4.6	5.1			7.9	11.0	3.1
	HT/VHT20 Beam Forming, M0 to M7	3	7	4.6	5.1	5.3		9.8	10.0	0.2
	HT/VHT20 Beam Forming, M8 to M15	3	4	4.6	5.1	5.3		9.8	11.0	1.2
	HT/VHT20 Beam Forming, M16 to M23	3	2	4.6	5.1	5.3		9.8	11.0	1.2
	HT/VHT20 Beam Forming, M0 to M7	4	8	1.5	1.7	1.9	3.0	8.1	9.0	0.9
	HT/VHT20 Beam Forming, M8 to M15	4	5	3.7	4.0	4.0	6.3	10.7	11.0	0.3
	HT/VHT20 Beam Forming, M16 to M23	4	3	3.7	4.0	4.0	6.3	10.7	11.0	0.3
	HT/VHT20 STBC, M0 to M7	2	2	4.6	5.1			7.9	11.0	3.1
	HT/VHT20 STBC, M0 to M7	3	4	4.6	5.1	5.3		9.8	11.0	1.2
	HT/VHT20 STBC, M0 to M7	4	5	3.7	4.0	4.0	6.3	10.7	11.0	0.3



5710	Non HT40, 6 to 54 Mbps	1	2	2.9				2.9	11.0	8.1
	Non HT40, 6 to 54 Mbps	2	5	2.9	3.0			6.0	11.0	5.0
	Non HT40, 6 to 54 Mbps	3	7	2.9	3.0	3.0		7.7	10.0	2.3
	Non HT40, 6 to 54 Mbps	4	8	1.9	2.1	2.3	3.5	8.5	9.0	0.5
	HT/VHT40, M0 to M7	1	2	1.3				1.3	11.0	9.7
	HT/VHT40, M0 to M7	2	5	1.3	1.9			4.6	11.0	6.4
	HT/VHT40, M8 to M15	2	2	1.3	1.9			4.6	11.0	6.4
	HT/VHT40, M0 to M7	3	7	1.3	1.9	1.8		6.4	10.0	3.6
	HT/VHT40, M8 to M15	3	4	1.3	1.9	1.8		6.4	11.0	4.6
	HT/VHT40, M16 to M23	3	2	1.3	1.9	1.8		6.4	11.0	4.6
	HT/VHT40, M0 to M7	4	8	1.3	1.9	1.8	3.2	8.1	9.0	0.9
	HT/VHT40, M8 to M15	4	5	1.3	1.9	1.8	3.2	8.1	11.0	2.9
	HT/VHT40, M16 to M23	4	3	1.3	1.9	1.8	3.2	8.1	11.0	2.9
	HT/VHT40 Beam Forming, M0 to M7	2	5	1.3	1.9			4.6	11.0	6.4
	HT/VHT40 Beam Forming, M8 to M15	2	2	1.3	1.9			4.6	11.0	6.4
	HT/VHT40 Beam Forming, M0 to M7	3	7	1.3	1.9	1.8		6.4	10.0	3.6
	HT/VHT40 Beam Forming, M8 to M15	3	4	1.3	1.9	1.8		6.4	11.0	4.6
	HT/VHT40 Beam Forming, M16 to M23	3	2	1.3	1.9	1.8		6.4	11.0	4.6
	HT/VHT40 Beam Forming, M0 to M7	4	8	0.2	1.3	0.6	3.2	7.5	9.0	1.5
	HT/VHT40 Beam Forming, M8 to M15	4	5	1.3	1.9	1.8	3.2	8.1	11.0	2.9
HT/VHT40 Beam Forming, M16 to M23	4	3	1.3	1.9	1.8	3.2	8.1	11.0	2.9	
HT/VHT40 STBC, M0 to M7	2	2	1.3	1.9			4.6	11.0	6.4	
HT/VHT40 STBC, M0 to M7	3	4	1.3	1.9	1.8		6.4	11.0	4.6	
HT/VHT40 STBC, M0 to M7	4	5	1.3	1.9	1.8	3.2	8.1	11.0	2.9	
5720	Non HT20, 6 to 54 Mbps	1	2	4.5				4.5	11.0	6.5
	Non HT20, 6 to 54 Mbps	2	5	4.5	5.6			8.1	11.0	2.9
	Non HT20, 6 to 54 Mbps	3	7	4.5	5.6	4.1		9.6	10.0	0.4
	Non HT20, 6 to 54 Mbps	4	8	2.4	3.0	2.0	4.1	9.0	9.0	0.0
	Non HT20 Beam Forming, 6 to 54 Mbps	2	5	4.5	5.6			8.1	11.0	2.9
	Non HT20 Beam Forming, 6 to 54 Mbps	3	7	4.5	5.6	4.1		9.6	10.0	0.4
	Non HT20 Beam Forming, 6 to 54 Mbps	4	8	2.4	3.0	2.0	4.1	9.0	9.0	0.0
	HT/VHT20, M0 to M7	1	2	4.4				4.4	11.0	6.6
	HT/VHT20, M0 to M7	2	5	4.4	5.3			7.9	11.0	3.1
	HT/VHT20, M8 to M15	2	2	4.4	5.3			7.9	11.0	3.1
	HT/VHT20, M0 to M7	3	7	4.4	5.3	4.2		9.4	10.0	0.6
	HT/VHT20, M8 to M15	3	4	4.4	5.3	4.2		9.4	11.0	1.6
	HT/VHT20, M16 to M23	3	2	4.4	5.3	4.2		9.4	11.0	1.6
	HT/VHT20, M0 to M7	4	8	2.2	3.1	2.2	4.1	9.0	9.0	0.0
HT/VHT20, M8 to M15	4	5	3.6	3.9	3.0	6.3	10.4	11.0	0.6	
HT/VHT20, M16 to M23	4	3	3.6	3.9	3.0	6.3	10.4	11.0	0.6	



HT/VHT20 Beam Forming, M0 to M7	2	5	4.4	5.3			7.9	11.0	3.1
HT/VHT20 Beam Forming, M8 to M15	2	2	4.4	5.3			7.9	11.0	3.1
HT/VHT20 Beam Forming, M0 to M7	3	7	4.4	5.3	4.2		9.4	10.0	0.6
HT/VHT20 Beam Forming, M8 to M15	3	4	4.4	5.3	4.2		9.4	11.0	1.6
HT/VHT20 Beam Forming, M16 to M23	3	2	4.4	5.3	4.2		9.4	11.0	1.6
HT/VHT20 Beam Forming, M0 to M7	4	8	2.2	3.1	2.2	4.1	9.0	9.0	0.0
HT/VHT20 Beam Forming, M8 to M15	4	5	3.6	3.9	3.0	6.3	10.4	11.0	0.6
HT/VHT20 Beam Forming, M16 to M23	4	3	3.6	3.9	3.0	6.3	10.4	11.0	0.6
HT/VHT20 STBC, M0 to M7	2	2	4.4	5.3			7.9	11.0	3.1
HT/VHT20 STBC, M0 to M7	3	4	4.4	5.3	4.2		9.4	11.0	1.6
HT/VHT20 STBC, M0 to M7	4	5	3.6	3.9	3.0	6.3	10.4	11.0	0.6



**Peak Output Power, 5670 MHz, HT/VHT40 Beam Forming, M0 to M7**



**Antenna A**

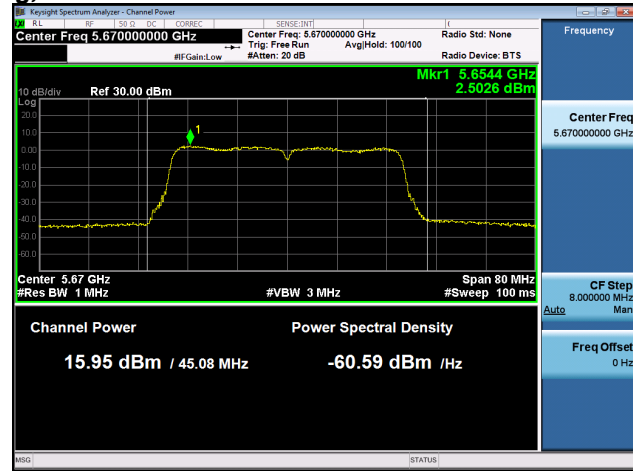

**Antenna B**

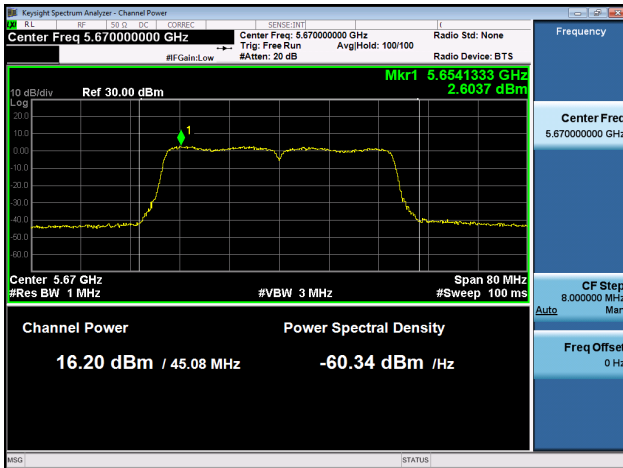

**Antenna C**

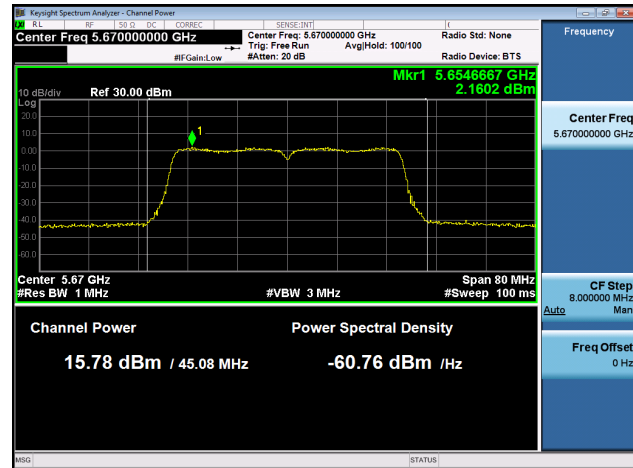

**Antenna D**



**Power Spectral Density, 5720 MHz, HT/VHT20, M0 to M7**

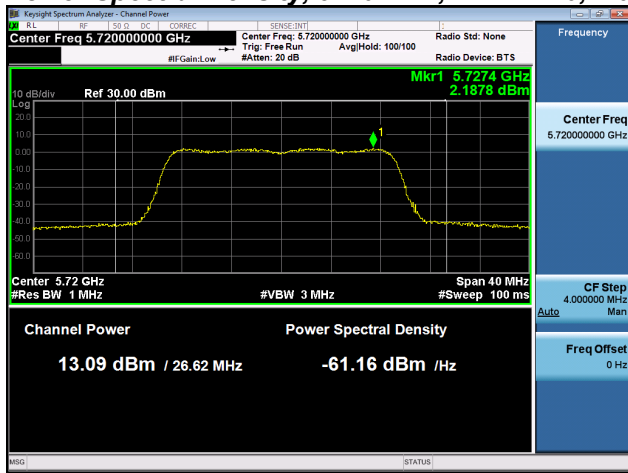

**Antenna A**

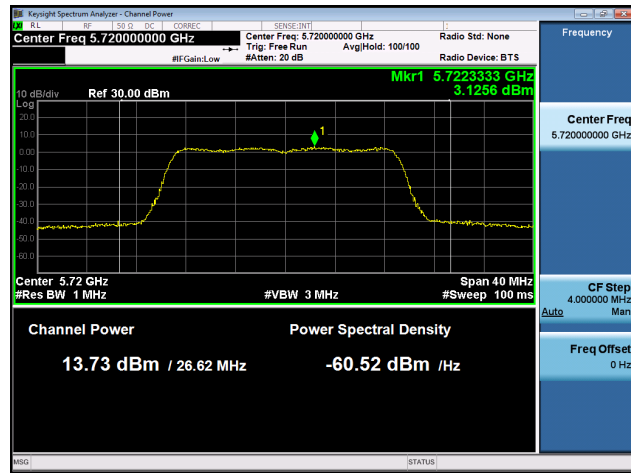

**Antenna B**

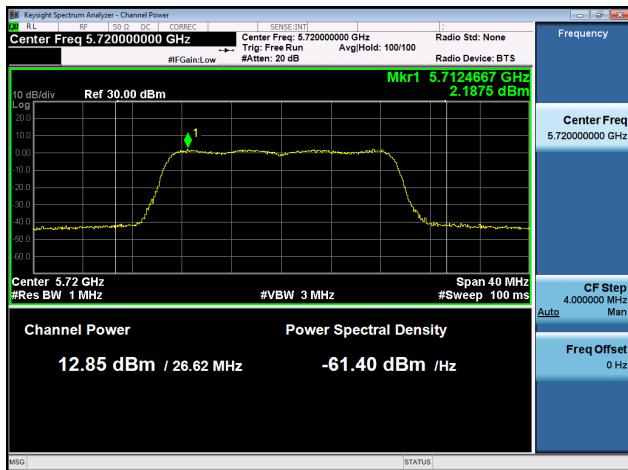

**Antenna C**

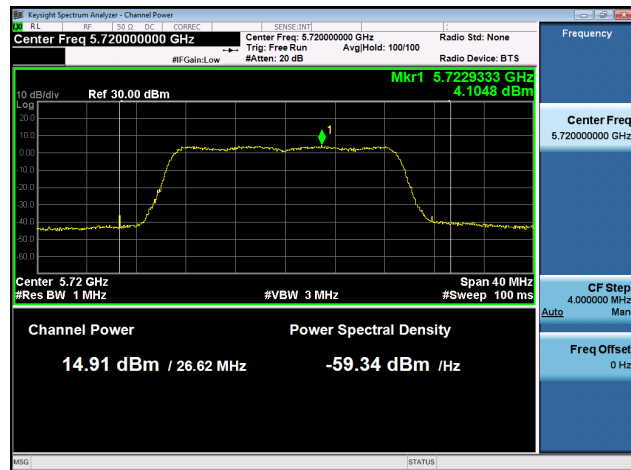

**Antenna D**



Antenna Gain : 3 dBi

Frequency (MHz)	Mode	Tx Paths	Correlated Antenna Gain (dBi)	Tx 1 Max Power (dBm)	Tx 2 Max Power (dBm)	Tx 3 Max Power (dBm)	Tx 4 Max Power (dBm)	Total Tx Channel Power (dBm)	Limit (dBm)	Margin (dB)
5500	Non HT20, 6 to 54 Mbps	1	3	16.0				16.0	23.6	7.6
	Non HT20, 6 to 54 Mbps	2	3	16.0	17.3			19.7	23.6	3.9
	Non HT20, 6 to 54 Mbps	3	3	14.6	14.9	13.8		19.2	23.6	4.4
	Non HT20, 6 to 54 Mbps	4	3	12.5	12.7	11.5	11.1	18.0	23.6	5.6
	Non HT20 Beam Forming, 6 to 54 Mbps	2	6	16.0	17.3			19.7	23.6	3.9
	Non HT20 Beam Forming, 6 to 54 Mbps	3	8	13.4	13.7	12.5		18.0	21.6	3.6
	Non HT20 Beam Forming, 6 to 54 Mbps	4	9	11.5	11.8	10.6	10.1	17.1	20.6	3.5
	HT/VHT20, M0 to M7	1	3	17.4				17.4	23.6	6.2
	HT/VHT20, M0 to M7	2	3	17.4	17.6			20.5	23.6	3.1
	HT/VHT20, M8 to M15	2	3	17.4	17.6			20.5	23.6	3.1
	HT/VHT20, M0 to M7	3	3	14.8	15.2	14.0		19.5	23.6	4.1
	HT/VHT20, M8 to M15	3	3	16.1	16.4	15.2		20.7	23.6	2.9
	HT/VHT20, M16 to M23	3	3	16.1	16.4	15.2		20.7	23.6	2.9
	HT/VHT20, M0 to M7	4	3	12.7	13.0	11.7	11.3	18.3	23.6	5.3
	HT/VHT20, M8 to M15	4	3	14.8	15.2	14.0	13.4	20.4	23.6	3.2
	HT/VHT20, M16 to M23	4	3	14.8	15.2	14.0	13.4	20.4	23.6	3.2
	HT/VHT20 Beam Forming, M0 to M7	2	6	17.4	17.6			20.5	23.6	3.1
	HT/VHT20 Beam Forming, M8 to M15	2	3	17.4	17.6			20.5	23.6	3.1
	HT/VHT20 Beam Forming, M0 to M7	3	8	13.6	13.9	12.7		18.2	21.6	3.4
	HT/VHT20 Beam Forming, M8 to M15	3	5	16.1	16.4	15.2		20.7	23.6	2.9
	HT/VHT20 Beam Forming, M16 to M23	3	3	16.1	16.4	15.2		20.7	23.6	2.9
	HT/VHT20 Beam Forming, M0 to M7	4	9	11.7	12.0	10.8	10.3	17.3	20.6	3.3
	HT/VHT20 Beam Forming, M8 to M15	4	6	14.8	15.2	14.0	13.4	20.4	23.6	3.2
	HT/VHT20 Beam Forming, M16 to M23	4	4	14.8	15.2	14.0	13.4	20.4	23.6	3.2
	HT/VHT20 STBC, M0 to M7	2	3	17.4	17.6			20.5	23.6	3.1
	HT/VHT20 STBC, M0 to M7	3	3	16.1	16.4	15.2		20.7	23.6	2.9
	HT/VHT20 STBC, M0 to M7	4	3	14.8	15.2	14.0	13.4	20.4	23.6	3.2
	5510	Non HT40, 6 to 54 Mbps	1	3	13.6				13.6	24.0
Non HT40, 6 to 54 Mbps		2	3	11.5	9.0			13.4	24.0	10.6
Non HT40, 6 to 54 Mbps		3	3	11.5	9.0	8.3		14.6	24.0	9.4
Non HT40, 6 to 54 Mbps		4	3	11.5	9.0	8.3	9.6	15.8	24.0	8.2
HT/VHT40, M0 to M7		1	3	16.7				16.7	24.0	7.3





	HT/VHT40, M0 to M7	2	3	15.4	15.6			18.5	24.0	5.5
	HT/VHT40, M8 to M15	2	3	15.4	15.6			18.5	24.0	5.5
	HT/VHT40, M0 to M7	3	3	15.4	15.6	15.1		20.1	24.0	3.9
	HT/VHT40, M8 to M15	3	3	15.4	15.6	15.1		20.1	24.0	3.9
	HT/VHT40, M16 to M23	3	3	15.4	15.6	15.1		20.1	24.0	3.9
	HT/VHT40, M0 to M7	4	3	14.2	14.5	13.9	13.1	20.0	24.0	4.0
	HT/VHT40, M8 to M15	4	3	14.2	14.5	13.9	13.1	20.0	24.0	4.0
	HT/VHT40, M16 to M23	4	3	14.2	14.5	13.9	13.1	20.0	24.0	4.0
	HT/VHT40 Beam Forming, M0 to M7	2	6	11.0	11.4			14.2	24.0	9.8
	HT/VHT40 Beam Forming, M8 to M15	2	3	15.4	15.6			18.5	24.0	5.5
	HT/VHT40 Beam Forming, M0 to M7	3	8	11.3	8.7	8.0		14.3	22.0	7.7
	HT/VHT40 Beam Forming, M8 to M15	3	5	11.0	11.4	10.9		15.9	24.0	8.1
	HT/VHT40 Beam Forming, M16 to M23	3	3	15.4	15.6	15.1		20.1	24.0	3.9
	HT/VHT40 Beam Forming, M0 to M7	4	9	8.4	5.5	5.1	6.1	12.5	21.0	8.5
	HT/VHT40 Beam Forming, M8 to M15	4	6	12.3	9.6	9.0	10.3	16.5	24.0	7.5
	HT/VHT40 Beam Forming, M16 to M23	4	4	11.0	11.4	10.9	10.1	16.9	24.0	7.1
	HT/VHT40 STBC, M0 to M7	2	3	15.4	15.6			18.5	24.0	5.5
	HT/VHT40 STBC, M0 to M7	3	3	15.4	15.6	15.1		20.1	24.0	3.9
	HT/VHT40 STBC, M0 to M7	4	3	14.2	14.5	13.9	13.1	20.0	24.0	4.0
5530	Non HT80, 6 to 54 Mbps	1	3	14.5				14.5	24.0	9.5
	Non HT80, 6 to 54 Mbps	2	3	13.4	13.7			16.6	24.0	7.4
	Non HT80, 6 to 54 Mbps	3	3	13.4	13.7	13.6		18.3	24.0	5.7
	Non HT80, 6 to 54 Mbps	4	3	12.3	12.5	12.4	11.8	18.3	24.0	5.7
	VHT80, M0 to M9 1ss	1	3	15.1				15.1	24.0	8.9
	VHT80, M0 to M9 1ss	2	3	15.1	15.3			18.2	24.0	5.8
	VHT80, M0 to M9 2ss	2	3	15.1	15.3			18.2	24.0	5.8
	VHT80, M0 to M9 1ss	3	3	15.1	15.3	15.3		20.0	24.0	4.0
	VHT80, M0 to M9 2ss	3	3	15.1	15.3	15.3		20.0	24.0	4.0
	VHT80, M0 to M9 3ss	3	3	15.1	15.3	15.3		20.0	24.0	4.0
	VHT80, M0 to M9 1ss	4	3	15.0	15.4	15.3	14.6	21.1	24.0	2.9
	VHT80, M0 to M9 2ss	4	3	15.0	15.4	15.3	14.6	21.1	24.0	2.9
	VHT80, M0 to M9 3ss	4	3	15.0	15.4	15.3	14.6	21.1	24.0	2.9
	VHT80 Beam Forming, M0 to M9 1ss	2	6	15.1	15.3			18.2	24.0	5.8
	VHT80 Beam Forming, M0 to M9 2ss	2	3	15.1	15.3			18.2	24.0	5.8
	VHT80 Beam Forming, M0 to M9 1ss	3	8	12.7	13.0	13.0		17.7	22.0	4.3
	VHT80 Beam Forming, M0 to M9 2ss	3	5	13.9	14.2	14.0		18.8	24.0	5.2
	VHT80 Beam Forming, M0 to M9 3ss	3	3	15.1	15.3	15.3		20.0	24.0	4.0
	VHT80 Beam Forming, M0 to M9 1ss	4	9	10.8	11.1	11.1	10.6	16.9	21.0	4.1
	VHT80 Beam Forming, M0 to M9 2ss	4	6	12.7	13.0	13.0	12.5	18.8	24.0	5.2
VHT80 Beam Forming, M0 to M9 3ss	4	4	13.9	14.2	14.0	13.5	19.9	24.0	4.1	



	VHT80 STBC, M0 to M9 1ss	2	3	15.1	15.3			18.2	24.0	5.8
	VHT80 STBC, M0 to M9 1ss	3	3	15.1	15.3	15.3		20.0	24.0	4.0
	VHT80 STBC, M0 to M9 1ss	4	3	15.0	15.4	15.3	14.6	21.1	24.0	2.9
5570	Non HT160, 6 to 54 Mbps	1	3	13.4				13.4	24.0	10.6
	Non HT160, 6 to 54 Mbps	2	3	11.2	11.6			14.4	24.0	9.6
	Non HT160, 6 to 54 Mbps	3	3	11.2	11.6	11.0		16.0	24.0	8.0
	Non HT160, 6 to 54 Mbps	4	3	11.2	11.6	11.0	11.1	17.3	24.0	6.7
	VHT160, M0 to M9 1ss	1	3	16.0				16.0	24.0	8.0
	VHT160, M0 to M9 1ss	2	3	16.0	16.3			19.2	24.0	4.8
	VHT160, M0 to M9 2ss	2	3	16.0	16.3			19.2	24.0	4.8
	VHT160, M0 to M9 1ss	3	3	14.8	15.2	14.7		19.7	24.0	4.3
	VHT160, M0 to M9 2ss	3	3	14.8	15.2	14.7		19.7	24.0	4.3
	VHT160, M0 to M9 3ss	3	3	14.8	15.2	14.7		19.7	24.0	4.3
	VHT160, M0 to M9 1ss	4	3	14.8	15.2	14.7	14.8	20.9	24.0	3.1
	VHT160, M0 to M9 2ss	4	3	14.8	15.2	14.7	14.8	20.9	24.0	3.1
	VHT160, M0 to M9 3ss	4	3	14.8	15.2	14.7	14.8	20.9	24.0	3.1
	VHT160 Beam Forming, M0 to M9 1ss	2	6	14.8	15.2			18.0	24.0	6.0
	VHT160 Beam Forming, M0 to M9 2ss	2	3	16.0	16.3			19.2	24.0	4.8
	VHT160 Beam Forming, M0 to M9 1ss	3	8	11.8	12.3	11.7		16.7	22.0	5.3
	VHT160 Beam Forming, M0 to M9 2ss	3	5	14.8	15.2	14.7		19.7	24.0	4.3
	VHT160 Beam Forming, M0 to M9 3ss	3	3	14.8	15.2	14.7		19.7	24.0	4.3
	VHT160 Beam Forming, M0 to M9 1ss	4	9	11.0	9.8	8.5	8.6	15.6	21.0	5.4
	VHT160 Beam Forming, M0 to M9 2ss	4	6	12.7	13.2	12.7	12.8	18.9	24.0	5.1
	VHT160 Beam Forming, M0 to M9 3ss	4	4	14.8	15.2	14.7	14.8	20.9	24.0	3.1
VHT160 STBC, M0 to M9 1ss	2	3	16.0	16.3			19.2	24.0	4.8	
VHT160 STBC, M0 to M9 1ss	3	3	14.8	15.2	14.7		19.7	24.0	4.3	
VHT160 STBC, M0 to M9 1ss	4	3	14.8	15.2	14.7	14.8	20.9	24.0	3.1	
5560	Non HT20, 6 to 54 Mbps	1	3	16.2				16.2	23.6	7.4
	Non HT20, 6 to 54 Mbps	2	3	16.2	16.5			19.4	23.6	4.2
	Non HT20, 6 to 54 Mbps	3	3	13.9	14.2	14.4		18.9	23.6	4.7
	Non HT20, 6 to 54 Mbps	4	3	11.7	12.0	12.2	12.7	18.2	23.6	5.4
	Non HT20 Beam Forming, 6 to 54 Mbps	2	6	16.2	16.5			19.4	23.6	4.2
	Non HT20 Beam Forming, 6 to 54 Mbps	3	8	13.9	14.2	14.4		18.9	21.6	2.7
	Non HT20 Beam Forming, 6 to 54 Mbps	4	9	11.7	12.0	12.2	12.7	18.2	20.6	2.4
	HT/VHT20, M0 to M7	1	3	16.4				16.4	23.6	7.2
	HT/VHT20, M0 to M7	2	3	16.4	16.7			19.6	23.6	4.0
	HT/VHT20, M8 to M15	2	3	16.4	16.7			19.6	23.6	4.0
	HT/VHT20, M0 to M7	3	3	14.0	14.4	14.6		19.1	23.6	4.5
	HT/VHT20, M8 to M15	3	3	16.4	16.7	16.9		21.4	23.6	2.2



	HT/VHT20, M16 to M23	3	3	16.4	16.7	16.9		21.4	23.6	2.2
	HT/VHT20, M0 to M7	4	3	11.9	12.2	12.3	12.9	18.4	23.6	5.2
	HT/VHT20, M8 to M15	4	3	15.2	15.5	15.7	16.1	21.7	23.6	1.9
	HT/VHT20, M16 to M23	4	3	15.2	15.5	15.7	16.1	21.7	23.6	1.9
	HT/VHT20 Beam Forming, M0 to M7	2	6	16.4	16.7			19.6	23.6	4.0
	HT/VHT20 Beam Forming, M8 to M15	2	3	16.4	16.7			19.6	23.6	4.0
	HT/VHT20 Beam Forming, M0 to M7	3	8	14.0	14.4	14.6		19.1	21.6	2.5
	HT/VHT20 Beam Forming, M8 to M15	3	5	16.4	16.7	16.9		21.4	23.6	2.2
	HT/VHT20 Beam Forming, M16 to M23	3	3	16.4	16.7	16.9		21.4	23.6	2.2
	HT/VHT20 Beam Forming, M0 to M7	4	9	11.9	12.2	12.3	12.9	18.4	20.6	2.2
	HT/VHT20 Beam Forming, M8 to M15	4	6	15.2	15.5	15.7	16.1	21.7	23.6	1.9
	HT/VHT20 Beam Forming, M16 to M23	4	4	15.2	15.5	15.7	16.1	21.7	23.6	1.9
	HT/VHT20 STBC, M0 to M7	2	3	16.4	16.7			19.6	23.6	4.0
	HT/VHT20 STBC, M0 to M7	3	3	16.4	16.7	16.9		21.4	23.6	2.2
	HT/VHT20 STBC, M0 to M7	4	3	15.2	15.5	15.7	16.1	21.7	23.6	1.9
5660	Non HT20, 6 to 54 Mbps	1	3	17.1				17.1	23.6	6.5
	Non HT20, 6 to 54 Mbps	2	3	17.1	17.6			20.4	23.6	3.2
	Non HT20, 6 to 54 Mbps	3	3	13.6	14.2	14.3		18.8	23.5	4.7
	Non HT20, 6 to 54 Mbps	4	3	11.7	12.3	12.3	11.6	18.0	23.6	5.6
	Non HT20 Beam Forming, 6 to 54 Mbps	2	6	17.1	17.6			20.4	23.6	3.2
	Non HT20 Beam Forming, 6 to 54 Mbps	3	8	13.6	14.2	14.3		18.8	21.5	2.7
	Non HT20 Beam Forming, 6 to 54 Mbps	4	9	11.7	12.3	12.3	11.6	18.0	20.6	2.6
	HT/VHT20, M0 to M7	1	3	17.3				17.3	23.6	6.3
	HT/VHT20, M0 to M7	2	3	17.3	17.7			20.5	23.6	3.1
	HT/VHT20, M8 to M15	2	3	17.3	17.7			20.5	23.6	3.1
	HT/VHT20, M0 to M7	3	3	13.7	14.3	14.3		18.9	23.6	4.7
	HT/VHT20, M8 to M15	3	3	16.1	16.6	16.7		21.2	23.6	2.4
	HT/VHT20, M16 to M23	3	3	16.1	16.6	16.7		21.2	23.6	2.4
	HT/VHT20, M0 to M7	4	3	11.8	12.3	12.5	11.7	18.1	23.6	5.5
	HT/VHT20, M8 to M15	4	3	14.9	15.5	15.6	14.7	21.2	23.6	2.4
	HT/VHT20, M16 to M23	4	3	14.9	15.5	15.6	14.7	21.2	23.6	2.4
	HT/VHT20 Beam Forming, M0 to M7	2	6	17.3	17.7			20.5	23.6	3.1
	HT/VHT20 Beam Forming, M8 to M15	2	3	17.3	17.7			20.5	23.6	3.1
	HT/VHT20 Beam Forming, M0 to M7	3	8	13.7	14.3	14.3		18.9	21.6	2.7
	HT/VHT20 Beam Forming, M8 to M15	3	5	16.1	16.6	16.7		21.2	23.6	2.4
	HT/VHT20 Beam Forming, M16 to M23	3	3	16.1	16.6	16.7		21.2	23.6	2.4
	HT/VHT20 Beam Forming, M0 to M7	4	9	11.8	12.3	12.5	11.7	18.1	20.6	2.5
	HT/VHT20 Beam Forming, M8 to M15	4	6	14.9	15.5	15.6	14.7	21.2	23.6	2.4
	HT/VHT20 Beam Forming, M16 to M23	4	4	14.9	15.5	15.6	14.7	21.2	23.6	2.4
HT/VHT20 STBC, M0 to M7	2	3	17.3	17.7			20.5	23.6	3.1	



	HT/VHT20 STBC, M0 to M7	3	3	16.1	16.6	16.7		21.2	23.6	2.4
	HT/VHT20 STBC, M0 to M7	4	3	14.9	15.5	15.6	14.7	21.2	23.6	2.4
5670	Non HT40, 6 to 54 Mbps	1	3	17.7				17.7	24.0	6.3
	Non HT40, 6 to 54 Mbps	2	3	17.7	18.1			20.9	24.0	3.1
	Non HT40, 6 to 54 Mbps	3	3	16.6	17.0	17.2		21.7	24.0	2.3
	Non HT40, 6 to 54 Mbps	4	3	14.3	14.7	15.0	14.5	20.7	24.0	3.3
	HT/VHT40, M0 to M7	1	3	16.6				16.6	24.0	7.4
	HT/VHT40, M0 to M7	2	3	16.6	17.0			19.8	24.0	4.2
	HT/VHT40, M8 to M15	2	3	16.6	17.0			19.8	24.0	4.2
	HT/VHT40, M0 to M7	3	3	16.6	17.0	17.3		21.7	24.0	2.3
	HT/VHT40, M8 to M15	3	3	16.6	17.0	17.3		21.7	24.0	2.3
	HT/VHT40, M16 to M23	3	3	16.6	17.0	17.3		21.7	24.0	2.3
	HT/VHT40, M0 to M7	4	3	14.2	14.8	15.1	14.6	20.7	24.0	3.3
	HT/VHT40, M8 to M15	4	3	16.6	17.0	17.3	16.8	23.0	24.0	1.0
	HT/VHT40, M16 to M23	4	3	16.6	17.0	17.3	16.8	23.0	24.0	1.0
	HT/VHT40 Beam Forming, M0 to M7	2	6	16.6	17.0			19.8	24.0	4.2
	HT/VHT40 Beam Forming, M8 to M15	2	3	16.6	17.0			19.8	24.0	4.2
	<b>HT/VHT40 Beam Forming, M0 to M7</b>	<b>3</b>	<b>8</b>	<b>16.6</b>	<b>17.0</b>	<b>17.3</b>		<b>21.7</b>	<b>22.0</b>	<b>0.3</b>
	HT/VHT40 Beam Forming, M8 to M15	3	5	16.6	17.0	17.3		21.7	24.0	2.3
	HT/VHT40 Beam Forming, M16 to M23	3	3	16.6	17.0	17.3		21.7	24.0	2.3
	HT/VHT40 Beam Forming, M0 to M7	4	9	14.2	14.8	15.1	14.6	20.7	21.0	0.3
	HT/VHT40 Beam Forming, M8 to M15	4	6	16.6	17.0	17.3	16.8	23.0	24.0	1.0
	HT/VHT40 Beam Forming, M16 to M23	4	4	16.6	17.0	17.3	16.8	23.0	24.0	1.0
HT/VHT40 STBC, M0 to M7	2	3	16.6	17.0			19.8	24.0	4.2	
HT/VHT40 STBC, M0 to M7	3	3	16.6	17.0	17.3		21.7	24.0	2.3	
HT/VHT40 STBC, M0 to M7	4	3	16.6	17.0	17.3	16.8	23.0	24.0	1.0	
5690	Non HT80, 6 to 54 Mbps	1	3	15.7				15.7	24.0	8.3
	Non HT80, 6 to 54 Mbps	2	3	15.7	16.2			19.0	24.0	5.0
	Non HT80, 6 to 54 Mbps	3	3	15.7	16.2	16.1		20.8	24.0	3.2
	Non HT80, 6 to 54 Mbps	4	3	15.7	16.2	16.1	16.5	22.2	24.0	1.8
	VHT80, M0 to M9 1ss	1	3	15.9				15.9	24.0	8.1
	VHT80, M0 to M9 1ss	2	3	15.9	16.4			19.2	24.0	4.8
	VHT80, M0 to M9 2ss	2	3	15.9	16.4			19.2	24.0	4.8
	VHT80, M0 to M9 1ss	3	3	15.9	16.4	16.3		21.0	24.0	3.0
	VHT80, M0 to M9 2ss	3	3	15.9	16.4	16.3		21.0	24.0	3.0
	VHT80, M0 to M9 3ss	3	3	15.9	16.4	16.3		21.0	24.0	3.0
	VHT80, M0 to M9 1ss	4	3	15.9	16.4	16.3	16.7	22.4	24.0	1.6
	VHT80, M0 to M9 2ss	4	3	15.9	16.4	16.3	16.7	22.4	24.0	1.6
	VHT80, M0 to M9 3ss	4	3	15.9	16.4	16.3	16.7	22.4	24.0	1.6



	VHT80 Beam Forming, M0 to M9 1ss	2	6	15.9	16.4			19.2	24.0	4.8
	VHT80 Beam Forming, M0 to M9 2ss	2	3	15.9	16.4			19.2	24.0	4.8
	VHT80 Beam Forming, M0 to M9 1ss	3	8	15.9	16.4	16.3		21.0	22.0	1.0
	VHT80 Beam Forming, M0 to M9 2ss	3	5	15.9	16.4	16.3		21.0	24.0	3.0
	VHT80 Beam Forming, M0 to M9 3ss	3	3	15.9	16.4	16.3		21.0	24.0	3.0
	VHT80 Beam Forming, M0 to M9 1ss	4	9	13.7	14.2	14.1	14.5	20.2	21.0	0.8
	VHT80 Beam Forming, M0 to M9 2ss	4	6	15.9	16.4	16.3	16.7	22.4	24.0	1.6
	VHT80 Beam Forming, M0 to M9 3ss	4	4	15.9	16.4	16.3	16.7	22.4	24.0	1.6
	VHT80 STBC, M0 to M9 1ss	2	3	15.9	16.4			19.2	24.0	4.8
	VHT80 STBC, M0 to M9 1ss	3	3	15.9	16.4	16.3		21.0	24.0	3.0
	VHT80 STBC, M0 to M9 1ss	4	3	15.9	16.4	16.3	16.7	22.4	24.0	1.6
5700	Non HT20, 6 to 54 Mbps	1	3	15.4				15.4	23.6	8.2
	Non HT20, 6 to 54 Mbps	2	3	15.4	15.8			18.6	23.6	5.0
	Non HT20, 6 to 54 Mbps	3	3	14.3	14.7	14.4		19.2	23.6	4.4
	Non HT20, 6 to 54 Mbps	4	3	11.0	11.5	11.2	12.6	17.6	23.6	6.0
	Non HT20 Beam Forming, 6 to 54 Mbps	2	6	15.4	15.8			18.6	23.6	5.0
	Non HT20 Beam Forming, 6 to 54 Mbps	3	8	14.3	14.7	14.4		19.2	21.6	2.4
	Non HT20 Beam Forming, 6 to 54 Mbps	4	9	11.0	11.5	11.2	12.6	17.6	20.6	3.0
	HT/VHT20, M0 to M7	1	3	15.6				15.6	23.6	8.0
	HT/VHT20, M0 to M7	2	3	15.6	16.0			18.8	23.6	4.8
	HT/VHT20, M8 to M15	2	3	15.6	16.0			18.8	23.6	4.8
	HT/VHT20, M0 to M7	3	3	14.5	14.9	14.6		19.4	23.6	4.2
	HT/VHT20, M8 to M15	3	3	15.6	16.0	15.7		20.5	23.6	3.1
	HT/VHT20, M16 to M23	3	3	15.6	16.0	15.7		20.5	23.6	3.1
	HT/VHT20, M0 to M7	4	3	11.2	11.8	11.4	12.8	17.9	23.6	5.7
	HT/VHT20, M8 to M15	4	3	14.5	14.9	14.6	17.3	21.5	23.6	2.1
	HT/VHT20, M16 to M23	4	3	14.5	14.9	14.6	17.3	21.5	23.6	2.1
	HT/VHT20 Beam Forming, M0 to M7	2	6	15.6	16.0			18.8	23.6	4.8
	HT/VHT20 Beam Forming, M8 to M15	2	3	15.6	16.0			18.8	23.6	4.8
	HT/VHT20 Beam Forming, M0 to M7	3	8	14.5	14.9	14.6		19.4	21.6	2.2
	HT/VHT20 Beam Forming, M8 to M15	3	5	15.6	16.0	15.7		20.5	23.6	3.1
	HT/VHT20 Beam Forming, M16 to M23	3	3	15.6	16.0	15.7		20.5	23.6	3.1
	HT/VHT20 Beam Forming, M0 to M7	4	9	11.2	11.8	11.4	12.8	17.9	20.6	2.7
	HT/VHT20 Beam Forming, M8 to M15	4	6	14.5	14.9	14.6	17.3	21.5	23.6	2.1
	HT/VHT20 Beam Forming, M16 to M23	4	4	14.5	14.9	14.6	17.3	21.5	23.6	2.1
	HT/VHT20 STBC, M0 to M7	2	3	15.6	16.0			18.8	23.6	4.8
HT/VHT20 STBC, M0 to M7	3	3	15.6	16.0	15.7		20.5	23.6	3.1	
HT/VHT20 STBC, M0 to M7	4	3	14.5	14.9	14.6	17.3	21.5	23.6	2.1	



5710	Non HT40, 6 to 54 Mbps	1	3	16.3				16.3	24.0	7.7
	Non HT40, 6 to 54 Mbps	2	3	16.3	16.7			19.5	24.0	4.5
	Non HT40, 6 to 54 Mbps	3	3	16.3	16.7	16.2		21.2	24.0	2.8
	Non HT40, 6 to 54 Mbps	4	3	14.1	14.6	14.1	15.9	20.8	24.0	3.2
	HT/VHT40, M0 to M7	1	3	15.2				15.2	24.0	8.8
	HT/VHT40, M0 to M7	2	3	15.2	15.7			18.5	24.0	5.5
	HT/VHT40, M8 to M15	2	3	15.2	15.7			18.5	24.0	5.5
	HT/VHT40, M0 to M7	3	3	15.2	15.7	15.1		20.1	24.0	3.9
	HT/VHT40, M8 to M15	3	3	15.2	15.7	15.1		20.1	24.0	3.9
	HT/VHT40, M16 to M23	3	3	15.2	15.7	15.1		20.1	24.0	3.9
	HT/VHT40, M0 to M7	4	3	14.1	14.5	14.0	17.1	21.1	24.0	2.9
	HT/VHT40, M8 to M15	4	3	15.2	15.7	15.1	17.0	21.8	24.0	2.2
	HT/VHT40, M16 to M23	4	3	15.2	15.7	15.1	17.0	21.8	24.0	2.2
	HT/VHT40 Beam Forming, M0 to M7	2	6	15.2	15.7			18.5	24.0	5.5
	HT/VHT40 Beam Forming, M8 to M15	2	3	15.2	15.7			18.5	24.0	5.5
	HT/VHT40 Beam Forming, M0 to M7	3	8	15.2	15.7	15.1		20.1	22.0	1.9
	HT/VHT40 Beam Forming, M8 to M15	3	5	15.2	15.7	15.1		20.1	24.0	3.9
	HT/VHT40 Beam Forming, M16 to M23	3	3	15.2	15.7	15.1		20.1	24.0	3.9
	HT/VHT40 Beam Forming, M0 to M7	4	9	14.1	14.6	14.0	15.9	20.7	21.0	0.3
	HT/VHT40 Beam Forming, M8 to M15	4	6	15.2	15.7	15.1	17.0	21.8	24.0	2.2
HT/VHT40 Beam Forming, M16 to M23	4	4	15.2	15.7	15.1	17.0	21.8	24.0	2.2	
HT/VHT40 STBC, M0 to M7	2	3	15.2	15.7			18.5	24.0	5.5	
HT/VHT40 STBC, M0 to M7	3	3	15.2	15.7	15.1		20.1	24.0	3.9	
HT/VHT40 STBC, M0 to M7	4	3	15.2	15.7	15.1	17.0	21.8	24.0	2.2	
5720	Non HT20, 6 to 54 Mbps	1	3	15.2				15.2	23.6	8.4
	Non HT20, 6 to 54 Mbps	2	3	15.2	15.8			18.5	23.6	5.1
	Non HT20, 6 to 54 Mbps	3	3	14.1	14.7	13.7		19.0	23.6	4.6
	Non HT20, 6 to 54 Mbps	4	3	11.8	12.4	11.4	13.6	18.4	23.6	5.2
	Non HT20 Beam Forming, 6 to 54 Mbps	2	6	15.2	15.8			18.5	23.6	5.1
	Non HT20 Beam Forming, 6 to 54 Mbps	3	8	14.1	14.7	13.7		19.0	21.6	2.6
	Non HT20 Beam Forming, 6 to 54 Mbps	4	9	11.8	12.4	11.4	13.6	18.4	20.6	2.2
	HT/VHT20, M0 to M7	1	3	15.3				15.3	23.6	8.3
	HT/VHT20, M0 to M7	2	3	15.3	16.0			18.7	23.6	4.9
	HT/VHT20, M8 to M15	2	3	15.3	16.0			18.7	23.6	4.9
	HT/VHT20, M0 to M7	3	3	14.2	14.8	13.9		19.1	23.6	4.5
	HT/VHT20, M8 to M15	3	3	15.3	16.0	15.0		20.2	23.6	3.4
	HT/VHT20, M16 to M23	3	3	15.3	16.0	15.0		20.2	23.6	3.4
	HT/VHT20, M0 to M7	4	3	12.0	12.6	11.5	13.8	18.6	23.6	5.0
HT/VHT20, M8 to M15	4	3	14.2	14.8	13.9	17.3	21.3	23.6	2.3	



HT/VHT20, M16 to M23	4	3	14.2	14.8	13.9	17.3	21.3	23.6	2.3
HT/VHT20 Beam Forming, M0 to M7	2	6	15.3	16.0			18.7	23.6	4.9
HT/VHT20 Beam Forming, M8 to M15	2	3	15.3	16.0			18.7	23.6	4.9
HT/VHT20 Beam Forming, M0 to M7	3	8	14.2	14.8	13.9		19.1	21.6	2.5
HT/VHT20 Beam Forming, M8 to M15	3	5	15.3	16.0	15.0		20.2	23.6	3.4
HT/VHT20 Beam Forming, M16 to M23	3	3	15.3	16.0	15.0		20.2	23.6	3.4
HT/VHT20 Beam Forming, M0 to M7	4	9	12.0	12.6	11.5	13.8	18.6	20.6	2.0
HT/VHT20 Beam Forming, M8 to M15	4	6	14.2	14.8	13.9	17.3	21.3	23.6	2.3
HT/VHT20 Beam Forming, M16 to M23	4	4	14.2	14.8	13.9	17.3	21.3	23.6	2.3
HT/VHT20 STBC, M0 to M7	2	3	15.3	16.0			18.7	23.6	4.9
HT/VHT20 STBC, M0 to M7	3	3	15.3	16.0	15.0		20.2	23.6	3.4
HT/VHT20 STBC, M0 to M7	4	3	14.2	14.8	13.9	17.3	21.3	23.6	2.3



Frequency (MHz)	Mode	Tx Paths	Correlated Antenna Gain (dBi)	Tx 1 PSD (dBm/MHz)	Tx 2 PSD (dBm/MHz)	Tx 3 PSD (dBm/MHz)	Tx 4 PSD (dBm/MHz)	Total PSD (dBm/MHz)	Limit (dBm/MHz)	Margin (dB)
5500	Non HT20, 6 to 54 Mbps	1	3	5.5				5.5	11.0	5.5
	Non HT20, 6 to 54 Mbps	2	6	5.5	7.1			9.4	11.0	1.6
	Non HT20, 6 to 54 Mbps	3	8	4.1	4.3	3.3		8.7	9.0	0.3
	Non HT20, 6 to 54 Mbps	4	9	2.2	2.2	0.9	0.7	7.6	8.0	0.4
	Non HT20 Beam Forming, 6 to 54 Mbps	2	6	5.5	7.1			9.4	11.0	1.6
	Non HT20 Beam Forming, 6 to 54 Mbps	3	8	3.0	3.3	1.9		7.5	9.0	1.5
	Non HT20 Beam Forming, 6 to 54 Mbps	4	9	1.4	1.4	0.1	-0.3	6.7	8.0	1.3
	HT/VHT20, M0 to M7	1	3	7.1				7.1	11.0	3.9
	HT/VHT20, M0 to M7	2	6	7.1	7.5			10.3	11.0	0.7
	HT/VHT20, M8 to M15	2	3	7.1	7.5			10.3	11.0	0.7
	HT/VHT20, M0 to M7	3	8	4.0	4.5	3.4		8.8	9.0	0.2
	HT/VHT20, M8 to M15	3	5	5.6	5.8	4.3		10.1	11.0	0.9
	HT/VHT20, M16 to M23	3	3	5.6	5.8	4.3		10.1	11.0	0.9
	HT/VHT20, M0 to M7	4	9	2.0	2.9	1.0	0.8	7.8	8.0	0.2
	HT/VHT20, M8 to M15	4	6	4.0	4.5	3.4	2.5	9.7	11.0	1.3
	HT/VHT20, M16 to M23	4	4	4.0	4.5	3.4	2.5	9.7	11.0	1.3
	HT/VHT20 Beam Forming, M0 to M7	2	6	7.1	7.5			10.3	11.0	0.7
	HT/VHT20 Beam Forming, M8 to M15	2	3	7.1	7.5			10.3	11.0	0.7
	HT/VHT20 Beam Forming, M0 to M7	3	8	2.8	3.2	2.3		7.6	9.0	1.4
	HT/VHT20 Beam Forming, M8 to M15	3	5	5.6	5.8	4.3		10.1	11.0	0.9
	HT/VHT20 Beam Forming, M16 to M23	3	3	5.6	5.8	4.3		10.1	11.0	0.9
	HT/VHT20 Beam Forming, M0 to M7	4	9	1.2	1.6	-0.1	-0.5	6.7	8.0	1.3
	HT/VHT20 Beam Forming, M8 to M15	4	6	4.0	4.5	3.4	2.5	9.7	11.0	1.3
	HT/VHT20 Beam Forming, M16 to M23	4	4	4.0	4.5	3.4	2.5	9.7	11.0	1.3
	HT/VHT20 STBC, M0 to M7	2	3	7.1	7.5			10.3	11.0	0.7
	HT/VHT20 STBC, M0 to M7	3	5	5.6	5.8	4.3		10.1	11.0	0.9
HT/VHT20 STBC, M0 to M7	4	6	4.0	4.5	3.4	2.5	9.7	11.0	1.3	
5510	Non HT40, 6 to 54 Mbps	1	3	0.5				0.5	11.0	10.5
	Non HT40, 6 to 54 Mbps	2	6	-1.6	-4.6			0.2	11.0	10.8
	Non HT40, 6 to 54 Mbps	3	8	-1.6	-4.6	-5.0		1.3	9.0	7.7
	Non HT40, 6 to 54 Mbps	4	9	-1.6	-4.6	-5.0	-3.2	2.6	8.0	5.4
	HT/VHT40, M0 to M7	1	3	3.6				3.6	11.0	7.4
	HT/VHT40, M0 to M7	2	6	2.5	2.7			5.6	11.0	5.4





	HT/VHT40, M8 to M15	2	3	2.5	2.7			5.6	11.0	5.4
	HT/VHT40, M0 to M7	3	8	2.5	2.7	1.6		7.1	9.0	1.9
	HT/VHT40, M8 to M15	3	5	2.5	2.7	1.6		7.1	11.0	3.9
	HT/VHT40, M16 to M23	3	3	2.5	2.7	1.6		7.1	11.0	3.9
	HT/VHT40, M0 to M7	4	9	0.8	1.4	0.1	-0.4	6.5	8.0	1.5
	HT/VHT40, M8 to M15	4	6	0.8	1.4	0.1	-0.4	6.5	11.0	4.5
	HT/VHT40, M16 to M23	4	4	0.8	1.4	0.1	-0.4	6.5	11.0	4.5
	HT/VHT40 Beam Forming, M0 to M7	2	6	-2.1	-1.7			1.1	11.0	9.9
	HT/VHT40 Beam Forming, M8 to M15	2	3	2.5	2.7			5.6	11.0	5.4
	HT/VHT40 Beam Forming, M0 to M7	3	8	-2.0	-5.1	-5.8		0.8	9.0	8.2
	HT/VHT40 Beam Forming, M8 to M15	3	5	-2.1	-1.7	-3.0		2.5	11.0	8.5
	HT/VHT40 Beam Forming, M16 to M23	3	3	2.5	2.7	1.6		7.1	11.0	3.9
	HT/VHT40 Beam Forming, M0 to M7	4	9	-4.9	-8.2	-8.6	-7.0	-0.9	8.0	8.9
	HT/VHT40 Beam Forming, M8 to M15	4	6	-0.9	-4.2	-4.6	-3.2	3.1	11.0	7.9
	HT/VHT40 Beam Forming, M16 to M23	4	4	-2.1	-1.7	-3.0	-3.7	3.5	11.0	7.5
	HT/VHT40 STBC, M0 to M7	2	3	2.5	2.7			5.6	11.0	5.4
	HT/VHT40 STBC, M0 to M7	3	5	2.5	2.7	1.6		7.1	11.0	3.9
	HT/VHT40 STBC, M0 to M7	4	6	0.8	1.4	0.1	-0.4	6.5	11.0	4.5
5530	Non HT80, 6 to 54 Mbps	1	3	-1.8				-1.8	11.0	12.8
	Non HT80, 6 to 54 Mbps	2	6	-2.7	-2.9			0.2	11.0	10.8
	Non HT80, 6 to 54 Mbps	3	8	-2.7	-2.9	-3.2		1.8	9.0	7.2
	Non HT80, 6 to 54 Mbps	4	9	-4.0	-3.6	-4.4	-4.3	2.0	8.0	6.0
	VHT80, M0 to M9 1ss	1	3	-1.8				-1.8	11.0	12.8
	VHT80, M0 to M9 1ss	2	6	-1.8	-1.4			1.4	11.0	9.6
	VHT80, M0 to M9 2ss	2	3	-1.8	-1.4			1.4	11.0	9.6
	VHT80, M0 to M9 1ss	3	8	-1.8	-1.4	-2.1		3.0	9.0	6.0
	VHT80, M0 to M9 2ss	3	5	-1.8	-1.4	-2.1		3.0	11.0	8.0
	VHT80, M0 to M9 3ss	3	3	-1.8	-1.4	-2.1		3.0	11.0	8.0
	VHT80, M0 to M9 1ss	4	9	-1.9	-1.4	-2.0	-1.8	4.3	8.0	3.7
	VHT80, M0 to M9 2ss	4	6	-1.9	-1.4	-2.0	-1.8	4.3	11.0	6.7
	VHT80, M0 to M9 3ss	4	4	-1.9	-1.4	-2.0	-1.8	4.3	11.0	6.7
	VHT80 Beam Forming, M0 to M9 1ss	2	6	-1.8	-1.4			1.4	11.0	9.6
	VHT80 Beam Forming, M0 to M9 2ss	2	3	-1.8	-1.4			1.4	11.0	9.6
	VHT80 Beam Forming, M0 to M9 1ss	3	8	-4.2	-3.4	-4.2		0.9	9.0	8.1
	VHT80 Beam Forming, M0 to M9 2ss	3	5	-2.8	-2.6	-2.9		2.0	11.0	9.0
	VHT80 Beam Forming, M0 to M9 3ss	3	3	-1.8	-1.4	-2.1		3.0	11.0	8.0
	VHT80 Beam Forming, M0 to M9 1ss	4	9	-5.3	-5.7	-6.1	-6.2	0.2	8.0	7.8
	VHT80 Beam Forming, M0 to M9 2ss	4	6	-4.2	-3.4	-4.2	-3.9	2.1	11.0	8.9
VHT80 Beam Forming, M0 to M9 3ss	4	4	-2.8	-2.6	-2.9	-2.6	3.3	11.0	7.7	
VHT80 STBC, M0 to M9 1ss	2	3	-1.8	-1.4			1.4	11.0	9.6	



	VHT80 STBC, M0 to M9 1ss	3	3	-1.8	-1.4	-2.1		3.0	11.0	8.0
	VHT80 STBC, M0 to M9 1ss	4	3	-1.9	-1.4	-2.0	-1.8	4.3	11.0	6.7
5570	Non HT160, 6 to 54 Mbps	1	3	-5.3				-5.3	11.0	16.3
	Non HT160, 6 to 54 Mbps	2	6	-7.4	-6.7			-4.0	11.0	15.0
	Non HT160, 6 to 54 Mbps	3	8	-7.4	-6.7	-8.2		-2.6	9.0	11.6
	Non HT160, 6 to 54 Mbps	4	9	-7.4	-6.7	-8.2	-7.9	-1.5	8.0	9.5
	VHT160, M0 to M9 1ss	1	3	-2.6				-2.6	11.0	13.6
	VHT160, M0 to M9 1ss	2	6	-2.6	-2.6			0.4	11.0	10.6
	VHT160, M0 to M9 2ss	2	3	-2.6	-2.6			0.4	11.0	10.6
	VHT160, M0 to M9 1ss	3	8	-4.1	-3.7	-4.9		0.6	9.0	8.4
	VHT160, M0 to M9 2ss	3	5	-4.1	-3.7	-4.9		0.6	11.0	10.4
	VHT160, M0 to M9 3ss	3	3	-4.1	-3.7	-4.9		0.6	11.0	10.4
	VHT160, M0 to M9 1ss	4	9	-4.1	-3.7	-4.9	-4.4	1.8	8.0	6.2
	VHT160, M0 to M9 2ss	4	6	-4.1	-3.7	-4.9	-4.4	1.8	11.0	9.2
	VHT160, M0 to M9 3ss	4	4	-4.1	-3.7	-4.9	-4.4	1.8	11.0	9.2
	VHT160 Beam Forming, M0 to M9 1ss	2	6	-4.1	-3.7			-0.9	11.0	11.9
	VHT160 Beam Forming, M0 to M9 2ss	2	3	-2.6	-2.6			0.4	11.0	10.6
	VHT160 Beam Forming, M0 to M9 1ss	3	8	-7.1	-6.7	-8.0		-2.5	9.0	11.5
	VHT160 Beam Forming, M0 to M9 2ss	3	5	-4.1	-3.7	-4.9		0.6	11.0	10.4
	VHT160 Beam Forming, M0 to M9 3ss	3	3	-4.1	-3.7	-4.9		0.6	11.0	10.4
	VHT160 Beam Forming, M0 to M9 1ss	4	9	-7.7	-10.4	-11.3	-10.2	-3.7	8.0	11.7
	VHT160 Beam Forming, M0 to M9 2ss	4	6	-6.5	-6.0	-6.9	-6.4	-0.4	11.0	11.4
	VHT160 Beam Forming, M0 to M9 3ss	4	4	-4.1	-3.7	-4.9	-4.4	1.8	11.0	9.2
VHT160 STBC, M0 to M9 1ss	2	3	-2.6	-2.6			0.4	11.0	10.6	
VHT160 STBC, M0 to M9 1ss	3	3	-4.1	-3.7	-4.9		0.6	11.0	10.4	
VHT160 STBC, M0 to M9 1ss	4	3	-4.1	-3.7	-4.9	-4.4	1.8	11.0	9.2	
5560	Non HT20, 6 to 54 Mbps	1	3	5.8				5.8	11.0	5.2
	Non HT20, 6 to 54 Mbps	2	6	5.8	6.5			9.2	11.0	1.8
	Non HT20, 6 to 54 Mbps	3	8	3.1	3.6	3.7		8.2	9.0	0.8
	Non HT20, 6 to 54 Mbps	4	9	1.0	1.6	1.4	2.0	7.5	8.0	0.5
	Non HT20 Beam Forming, 6 to 54 Mbps	2	6	5.8	6.5			9.2	11.0	1.8
	Non HT20 Beam Forming, 6 to 54 Mbps	3	8	3.1	3.6	3.7		8.2	9.0	0.8
	Non HT20 Beam Forming, 6 to 54 Mbps	4	9	1.0	1.6	1.4	2.0	7.5	8.0	0.5
	HT/VHT20, M0 to M7	1	3	5.6				5.6	11.0	5.4
	HT/VHT20, M0 to M7	2	6	5.6	6.0			8.8	11.0	2.2
	HT/VHT20, M8 to M15	2	3	5.6	6.0			8.8	11.0	2.2
	HT/VHT20, M0 to M7	3	8	3.3	3.5	3.7		8.3	9.0	0.7
	HT/VHT20, M8 to M15	3	5	5.6	6.0	6.1		10.7	11.0	0.3
	HT/VHT20, M16 to M23	3	3	5.6	6.0	6.1		10.7	11.0	0.3



	HT/VHT20, M0 to M7	4	9	1.2	1.6	1.6	2.1	7.7	8.0	0.3
	<b>HT/VHT20, M8 to M15</b>	<b>4</b>	<b>6</b>	<b>4.3</b>	<b>5.0</b>	<b>5.0</b>	<b>5.4</b>	<b>11.0</b>	<b>11.0</b>	<b>0.0</b>
	HT/VHT20, M16 to M23	4	4	4.3	5.0	5.0	5.4	11.0	11.0	0.0
	HT/VHT20 Beam Forming, M0 to M7	2	6	5.6	6.0			8.8	11.0	2.2
	HT/VHT20 Beam Forming, M8 to M15	2	3	5.6	6.0			8.8	11.0	2.2
	HT/VHT20 Beam Forming, M0 to M7	3	8	3.3	3.5	3.7		8.3	9.0	0.7
	HT/VHT20 Beam Forming, M8 to M15	3	5	5.6	6.0	6.1		10.7	11.0	0.3
	HT/VHT20 Beam Forming, M16 to M23	3	3	5.6	6.0	6.1		10.7	11.0	0.3
	HT/VHT20 Beam Forming, M0 to M7	4	9	1.2	1.6	1.6	2.1	7.7	8.0	0.3
	HT/VHT20 Beam Forming, M8 to M15	4	6	4.3	5.0	5.0	5.4	11.0	11.0	0.0
	HT/VHT20 Beam Forming, M16 to M23	4	4	4.3	5.0	5.0	5.4	11.0	11.0	0.0
	HT/VHT20 STBC, M0 to M7	2	3	5.6	6.0			8.8	11.0	2.2
	HT/VHT20 STBC, M0 to M7	3	5	5.6	6.0	6.1		10.7	11.0	0.3
	HT/VHT20 STBC, M0 to M7	4	6	4.3	5.0	5.0	5.4	11.0	11.0	0.0
5660	Non HT20, 6 to 54 Mbps	1	3	6.8				6.8	11.0	4.2
	Non HT20, 6 to 54 Mbps	2	6	6.8	6.9			9.9	11.0	1.1
	Non HT20, 6 to 54 Mbps	3	8	3.4	3.5	3.7		8.3	9.0	0.7
	Non HT20, 6 to 54 Mbps	4	9	1.0	1.9	2.0	1.0	7.5	8.0	0.5
	Non HT20 Beam Forming, 6 to 54 Mbps	2	6	6.8	6.9			9.9	11.0	1.1
	Non HT20 Beam Forming, 6 to 54 Mbps	3	8	3.4	3.5	3.7		8.3	9.0	0.7
	Non HT20 Beam Forming, 6 to 54 Mbps	4	9	1.0	1.9	2.0	1.0	7.5	8.0	0.5
	HT/VHT20, M0 to M7	1	3	6.5				6.5	11.0	4.5
	HT/VHT20, M0 to M7	2	6	6.5	7.0			9.8	11.0	1.2
	HT/VHT20, M8 to M15	2	3	6.5	7.0			9.8	11.0	1.2
	HT/VHT20, M0 to M7	3	8	3.1	3.6	3.6		8.2	9.0	0.8
	HT/VHT20, M8 to M15	3	5	5.3	5.8	5.8		10.4	11.0	0.6
	HT/VHT20, M16 to M23	3	3	5.3	5.8	5.8		10.4	11.0	0.6
	HT/VHT20, M0 to M7	4	9	1.5	1.8	1.7	1.0	7.5	8.0	0.5
	HT/VHT20, M8 to M15	4	6	4.3	4.7	4.5	3.9	10.4	11.0	0.6
	HT/VHT20, M16 to M23	4	4	4.3	4.7	4.5	3.9	10.4	11.0	0.6
	HT/VHT20 Beam Forming, M0 to M7	2	6	6.5	7.0			9.8	11.0	1.2
	HT/VHT20 Beam Forming, M8 to M15	2	3	6.5	7.0			9.8	11.0	1.2
	HT/VHT20 Beam Forming, M0 to M7	3	8	3.1	3.6	3.6		8.2	9.0	0.8
	HT/VHT20 Beam Forming, M8 to M15	3	5	5.3	5.8	5.8		10.4	11.0	0.6
HT/VHT20 Beam Forming, M16 to M23	3	3	5.3	5.8	5.8		10.4	11.0	0.6	
HT/VHT20 Beam Forming, M0 to M7	4	9	1.5	1.8	1.7	1.0	7.5	8.0	0.5	
HT/VHT20 Beam Forming, M8 to M15	4	6	4.3	4.7	4.5	3.9	10.4	11.0	0.6	
HT/VHT20 Beam Forming, M16 to M23	4	4	4.3	4.7	4.5	3.9	10.4	11.0	0.6	
HT/VHT20 STBC, M0 to M7	2	3	6.5	7.0			9.8	11.0	1.2	
HT/VHT20 STBC, M0 to M7	3	5	5.3	5.8	5.8		10.4	11.0	0.6	



	HT/VHT20 STBC, M0 to M7	4	6	4.3	4.7	4.5	3.9	10.4	11.0	0.6
5670	Non HT40, 6 to 54 Mbps	1	3	4.8				4.8	11.0	6.2
	Non HT40, 6 to 54 Mbps	2	6	4.8	4.9			7.9	11.0	3.1
	Non HT40, 6 to 54 Mbps	3	8	3.6	4.2	4.3		8.8	9.0	0.2
	Non HT40, 6 to 54 Mbps	4	9	1.3	1.7	1.9	1.0	7.5	8.0	0.5
	HT/VHT40, M0 to M7	1	3	3.7				3.7	11.0	7.3
	HT/VHT40, M0 to M7	2	6	3.7	3.9			6.8	11.0	4.2
	HT/VHT40, M8 to M15	2	3	3.7	3.9			6.8	11.0	4.2
	HT/VHT40, M0 to M7	3	8	3.7	3.9	3.9		8.6	9.0	0.4
	HT/VHT40, M8 to M15	3	5	3.7	3.9	3.9		8.6	11.0	2.4
	HT/VHT40, M16 to M23	3	3	3.7	3.9	3.9		8.6	11.0	2.4
	HT/VHT40, M0 to M7	4	9	1.0	1.5	1.7	0.9	7.3	8.0	0.7
	HT/VHT40, M8 to M15	4	6	3.7	3.9	3.9	3.3	9.7	11.0	1.3
	HT/VHT40, M16 to M23	4	4	3.7	3.9	3.9	3.3	9.7	11.0	1.3
	HT/VHT40 Beam Forming, M0 to M7	2	6	3.7	3.9			6.8	11.0	4.2
	HT/VHT40 Beam Forming, M8 to M15	2	3	3.7	3.9			6.8	11.0	4.2
	HT/VHT40 Beam Forming, M0 to M7	3	8	3.7	3.9	3.9		8.6	9.0	0.4
	HT/VHT40 Beam Forming, M8 to M15	3	5	3.7	3.9	3.9		8.6	11.0	2.4
	HT/VHT40 Beam Forming, M16 to M23	3	3	3.7	3.9	3.9		8.6	11.0	2.4
	HT/VHT40 Beam Forming, M0 to M7	4	9	1.0	1.5	1.7	0.9	7.3	8.0	0.7
	HT/VHT40 Beam Forming, M8 to M15	4	6	3.7	3.9	3.9	3.3	9.7	11.0	1.3
HT/VHT40 Beam Forming, M16 to M23	4	4	3.7	3.9	3.9	3.3	9.7	11.0	1.3	
HT/VHT40 STBC, M0 to M7	2	3	3.7	3.9			6.8	11.0	4.2	
HT/VHT40 STBC, M0 to M7	3	5	3.7	3.9	3.9		8.6	11.0	2.4	
HT/VHT40 STBC, M0 to M7	4	6	3.7	3.9	3.9	3.3	9.7	11.0	1.3	
5690	Non HT80, 6 to 54 Mbps	1	3	-0.8				-0.8	11.0	11.8
	Non HT80, 6 to 54 Mbps	2	6	-0.8	-0.1			2.6	11.0	8.4
	Non HT80, 6 to 54 Mbps	3	8	-0.8	-0.1	0.2		4.6	9.0	4.4
	Non HT80, 6 to 54 Mbps	4	9	-0.8	-0.1	0.2	-0.3	5.8	8.0	2.2
	VHT80, M0 to M9 1ss	1	3	-0.5				-0.5	11.0	11.5
	VHT80, M0 to M9 1ss	2	6	-0.5	-0.3			2.6	11.0	8.4
	VHT80, M0 to M9 2ss	2	3	-0.5	-0.3			2.6	11.0	8.4
	VHT80, M0 to M9 1ss	3	8	-0.5	-0.3	-0.3		4.4	9.0	4.6
	VHT80, M0 to M9 2ss	3	5	-0.5	-0.3	-0.3		4.4	11.0	6.6
	VHT80, M0 to M9 3ss	3	3	-0.5	-0.3	-0.3		4.4	11.0	6.6
	VHT80, M0 to M9 1ss	4	9	-0.5	-0.3	-0.3	-0.7	5.6	8.0	2.4
	VHT80, M0 to M9 2ss	4	6	-0.5	-0.3	-0.3	-0.7	5.6	11.0	5.4
	VHT80, M0 to M9 3ss	4	4	-0.5	-0.3	-0.3	-0.7	5.6	11.0	5.4
	VHT80 Beam Forming, M0 to M9 1ss	2	6	-0.5	-0.3			2.6	11.0	8.4



	VHT80 Beam Forming, M0 to M9 2ss	2	3	-0.5	-0.3			2.6	11.0	8.4
	VHT80 Beam Forming, M0 to M9 1ss	3	8	-0.5	-0.3	-0.3		4.4	9.0	4.6
	VHT80 Beam Forming, M0 to M9 2ss	3	5	-0.5	-0.3	-0.3		4.4	11.0	6.6
	VHT80 Beam Forming, M0 to M9 3ss	3	3	-0.5	-0.3	-0.3		4.4	11.0	6.6
	VHT80 Beam Forming, M0 to M9 1ss	4	9	-2.9	-2.6	-2.1	-3.0	3.4	8.0	4.6
	VHT80 Beam Forming, M0 to M9 2ss	4	6	-0.5	-0.3	-0.3	-0.7	5.6	11.0	5.4
	VHT80 Beam Forming, M0 to M9 3ss	4	4	-0.5	-0.3	-0.3	-0.7	5.6	11.0	5.4
	VHT80 STBC, M0 to M9 1ss	2	3	-0.5	-0.3			2.6	11.0	8.4
	VHT80 STBC, M0 to M9 1ss	3	3	-0.5	-0.3	-0.3		4.4	11.0	6.6
	VHT80 STBC, M0 to M9 1ss	4	3	-0.5	-0.3	-0.3	-0.7	5.6	11.0	5.4
5700	Non HT20, 6 to 54 Mbps	1	3	4.7				4.7	11.0	6.3
	Non HT20, 6 to 54 Mbps	2	6	4.7	5.1			7.9	11.0	3.1
	Non HT20, 6 to 54 Mbps	3	8	3.6	4.2	3.7		8.6	9.0	0.4
	Non HT20, 6 to 54 Mbps	4	9	0.2	1.1	0.6	1.9	7.0	8.0	1.0
	Non HT20 Beam Forming, 6 to 54 Mbps	2	6	4.7	5.1			7.9	11.0	3.1
	Non HT20 Beam Forming, 6 to 54 Mbps	3	8	3.6	4.2	3.7		8.6	9.0	0.4
	Non HT20 Beam Forming, 6 to 54 Mbps	4	9	0.2	1.1	0.6	1.9	7.0	8.0	1.0
	HT/VHT20, M0 to M7	1	3	4.6				4.6	11.0	6.4
	HT/VHT20, M0 to M7	2	6	4.6	5.1			7.9	11.0	3.1
	HT/VHT20, M8 to M15	2	3	4.6	5.1			7.9	11.0	3.1
	HT/VHT20, M0 to M7	3	8	3.7	4.0	4.0		8.7	9.0	0.3
	HT/VHT20, M8 to M15	3	5	4.6	5.1	5.3		9.8	11.0	1.2
	HT/VHT20, M16 to M23	3	3	4.6	5.1	5.3		9.8	11.0	1.2
	HT/VHT20, M0 to M7	4	9	0.2	1.0	0.7	1.7	7.0	8.0	1.0
	HT/VHT20, M8 to M15	4	6	3.7	4.0	4.0	6.3	10.7	11.0	0.3
	HT/VHT20, M16 to M23	4	4	3.7	4.0	4.0	6.3	10.7	11.0	0.3
	HT/VHT20 Beam Forming, M0 to M7	2	6	4.6	5.1			7.9	11.0	3.1
	HT/VHT20 Beam Forming, M8 to M15	2	3	4.6	5.1			7.9	11.0	3.1
	HT/VHT20 Beam Forming, M0 to M7	3	8	3.7	4.0	4.0		8.7	9.0	0.3
	HT/VHT20 Beam Forming, M8 to M15	3	5	4.6	5.1	5.3		9.8	11.0	1.2
	HT/VHT20 Beam Forming, M16 to M23	3	3	4.6	5.1	5.3		9.8	11.0	1.2
	HT/VHT20 Beam Forming, M0 to M7	4	9	0.2	1.0	0.7	1.7	7.0	8.0	1.0
	HT/VHT20 Beam Forming, M8 to M15	4	6	3.7	4.0	4.0	6.3	10.7	11.0	0.3
	HT/VHT20 Beam Forming, M16 to M23	4	4	3.7	4.0	4.0	6.3	10.7	11.0	0.3
	HT/VHT20 STBC, M0 to M7	2	3	4.6	5.1			7.9	11.0	3.1
	HT/VHT20 STBC, M0 to M7	3	5	4.6	5.1	5.3		9.8	11.0	1.2
	HT/VHT20 STBC, M0 to M7	4	6	3.7	4.0	4.0	6.3	10.7	11.0	0.3



5710	Non HT40, 6 to 54 Mbps	1	3	2.9				2.9	11.0	8.1
	Non HT40, 6 to 54 Mbps	2	6	2.9	3.0			6.0	11.0	5.0
	Non HT40, 6 to 54 Mbps	3	8	2.9	3.0	3.0		7.7	9.0	1.3
	Non HT40, 6 to 54 Mbps	4	9	0.9	1.1	1.4	2.3	7.5	8.0	0.5
	HT/VHT40, M0 to M7	1	3	1.3				1.3	11.0	9.7
	HT/VHT40, M0 to M7	2	6	1.3	1.9			4.6	11.0	6.4
	HT/VHT40, M8 to M15	2	3	1.3	1.9			4.6	11.0	6.4
	HT/VHT40, M0 to M7	3	8	1.3	1.9	1.8		6.4	9.0	2.6
	HT/VHT40, M8 to M15	3	5	1.3	1.9	1.8		6.4	11.0	4.6
	HT/VHT40, M16 to M23	3	3	1.3	1.9	1.8		6.4	11.0	4.6
	HT/VHT40, M0 to M7	4	9	0.2	1.3	0.6	3.2	7.5	8.0	0.5
	HT/VHT40, M8 to M15	4	6	1.3	1.9	1.8	3.2	8.1	11.0	2.9
	HT/VHT40, M16 to M23	4	4	1.3	1.9	1.8	3.2	8.1	11.0	2.9
	HT/VHT40 Beam Forming, M0 to M7	2	6	1.3	1.9			4.6	11.0	6.4
	HT/VHT40 Beam Forming, M8 to M15	2	3	1.3	1.9			4.6	11.0	6.4
	HT/VHT40 Beam Forming, M0 to M7	3	8	1.3	1.9	1.8		6.4	9.0	2.6
	HT/VHT40 Beam Forming, M8 to M15	3	5	1.3	1.9	1.8		6.4	11.0	4.6
	HT/VHT40 Beam Forming, M16 to M23	3	3	1.3	1.9	1.8		6.4	11.0	4.6
	HT/VHT40 Beam Forming, M0 to M7	4	9	0.2	0.8	0.4	2.0	6.9	8.0	1.1
	HT/VHT40 Beam Forming, M8 to M15	4	6	1.3	1.9	1.8	3.2	8.1	11.0	2.9
HT/VHT40 Beam Forming, M16 to M23	4	4	1.3	1.9	1.8	3.2	8.1	11.0	2.9	
HT/VHT40 STBC, M0 to M7	2	3	1.3	1.9			4.6	11.0	6.4	
HT/VHT40 STBC, M0 to M7	3	5	1.3	1.9	1.8		6.4	11.0	4.6	
HT/VHT40 STBC, M0 to M7	4	6	1.3	1.9	1.8	3.2	8.1	11.0	2.9	
5720	Non HT20, 6 to 54 Mbps	1	3	4.5				4.5	11.0	6.5
	Non HT20, 6 to 54 Mbps	2	6	4.5	5.6			8.1	11.0	2.9
	Non HT20, 6 to 54 Mbps	3	8	3.4	4.1	3.2		8.4	9.0	0.6
	Non HT20, 6 to 54 Mbps	4	9	1.3	1.7	0.9	3.1	7.9	8.0	0.1
	Non HT20 Beam Forming, 6 to 54 Mbps	2	6	4.5	5.6			8.1	11.0	2.9
	Non HT20 Beam Forming, 6 to 54 Mbps	3	8	3.4	4.1	3.2		8.4	9.0	0.6
	Non HT20 Beam Forming, 6 to 54 Mbps	4	9	1.3	1.7	0.9	3.1	7.9	8.0	0.1
	HT/VHT20, M0 to M7	1	3	4.4				4.4	11.0	6.6
	HT/VHT20, M0 to M7	2	6	4.4	5.3			7.9	11.0	3.1
	HT/VHT20, M8 to M15	2	3	4.4	5.3			7.9	11.0	3.1
	HT/VHT20, M0 to M7	3	8	3.6	3.9	3.0		8.3	9.0	0.7
	HT/VHT20, M8 to M15	3	5	4.4	5.3	4.2		9.4	11.0	1.6
	HT/VHT20, M16 to M23	3	3	4.4	5.3	4.2		9.4	11.0	1.6
	HT/VHT20, M0 to M7	4	9	1.3	1.5	0.5	3.0	7.7	8.0	0.3
HT/VHT20, M8 to M15	4	6	3.6	3.9	3.0	6.3	10.4	11.0	0.6	
HT/VHT20, M16 to M23	4	4	3.6	3.9	3.0	6.3	10.4	11.0	0.6	



HT/VHT20 Beam Forming, M0 to M7	2	6	4.4	5.3			7.9	11.0	3.1
HT/VHT20 Beam Forming, M8 to M15	2	3	4.4	5.3			7.9	11.0	3.1
HT/VHT20 Beam Forming, M0 to M7	3	8	3.6	3.9	3.0		8.3	9.0	0.7
HT/VHT20 Beam Forming, M8 to M15	3	5	4.4	5.3	4.2		9.4	11.0	1.6
HT/VHT20 Beam Forming, M16 to M23	3	3	4.4	5.3	4.2		9.4	11.0	1.6
HT/VHT20 Beam Forming, M0 to M7	4	9	1.3	1.5	0.5	3.0	7.7	8.0	0.3
HT/VHT20 Beam Forming, M8 to M15	4	6	3.6	3.9	3.0	6.3	10.4	11.0	0.6
HT/VHT20 Beam Forming, M16 to M23	4	4	3.6	3.9	3.0	6.3	10.4	11.0	0.6
HT/VHT20 STBC, M0 to M7	2	3	4.4	5.3			7.9	11.0	3.1
HT/VHT20 STBC, M0 to M7	3	5	4.4	5.3	4.2		9.4	11.0	1.6
HT/VHT20 STBC, M0 to M7	4	6	3.6	3.9	3.0	6.3	10.4	11.0	0.6



**Peak Output Power, 5670 MHz, HT/VHT40 Beam Forming, M0 to M7**

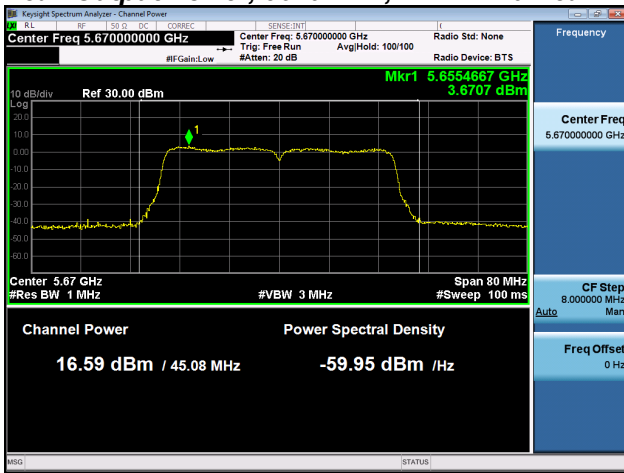

**Antenna A**

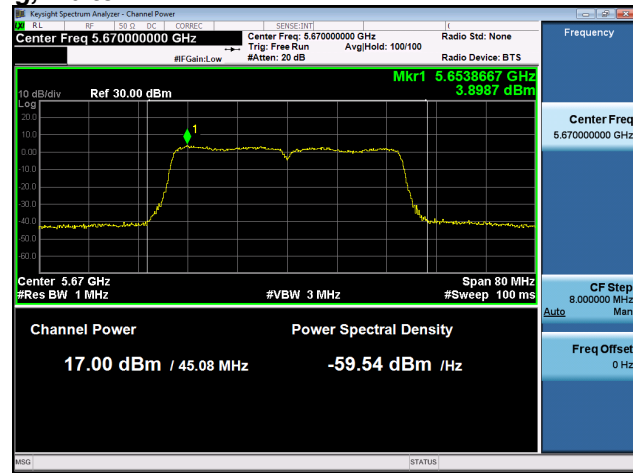

**Antenna B**

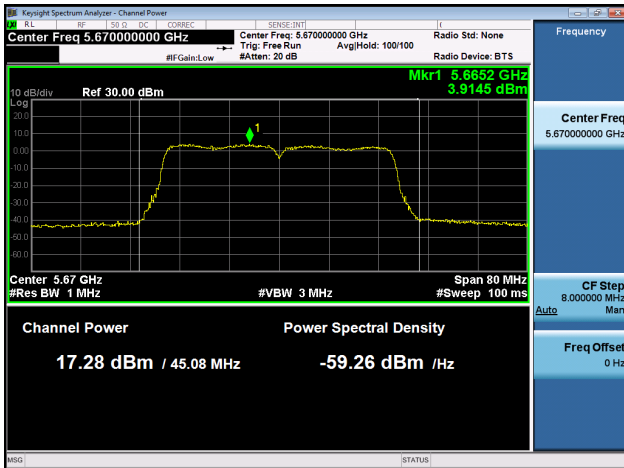

**Antenna C**





**Power Spectral Density, 5560 MHz, HT/VHT20, M8 to M15**

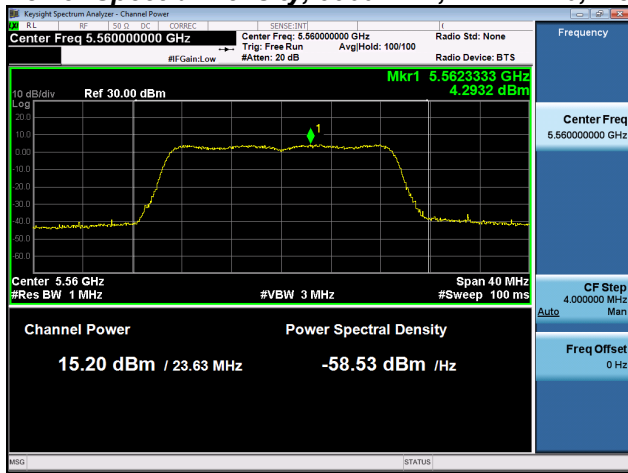

**Antenna A**

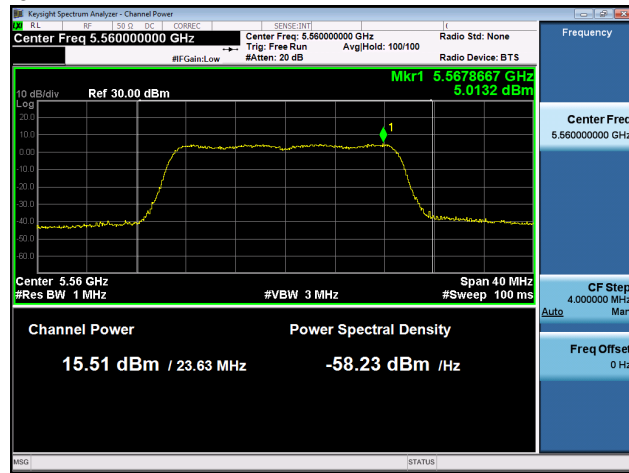

**Antenna B**

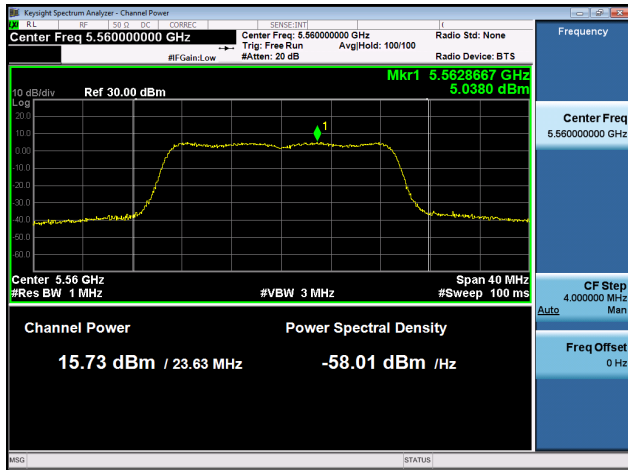

**Antenna C**

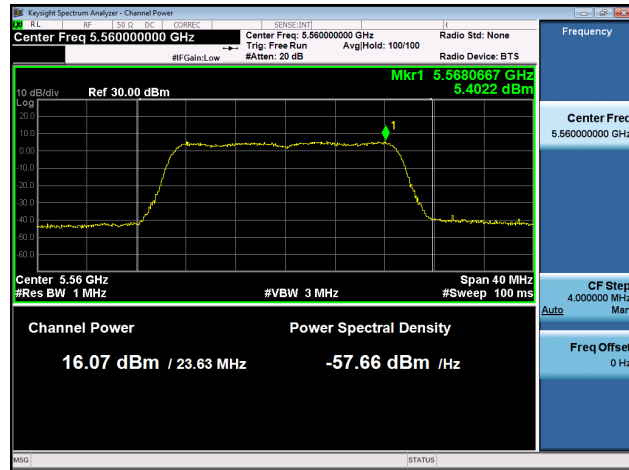

**Antenna D**



**Antenna Gain : 4 dBi**

Frequency (MHz)	Mode	Tx Paths	Correlated Antenna Gain (dBi)	Tx 1 Max Power (dBm)	Tx 2 Max Power (dBm)	Tx 3 Max Power (dBm)	Tx 4 Max Power (dBm)	Total Tx Channel Power (dBm)	Limit (dBm)	Margin (dB)
5500	Non HT20, 6 to 54 Mbps	1	4	16.0				16.0	23.6	7.6
	Non HT20, 6 to 54 Mbps	2	4	16.0	17.3			19.7	23.6	3.9
	Non HT20, 6 to 54 Mbps	3	4	13.4	13.7	12.5		18.0	23.6	5.6
	Non HT20, 6 to 54 Mbps	4	4	11.5	11.8	10.6	10.1	17.1	23.6	6.5
	Non HT20 Beam Forming, 6 to 54 Mbps	2	7	16.0	17.3			19.7	22.6	2.9
	Non HT20 Beam Forming, 6 to 54 Mbps	3	9	12.5	12.7	11.5		17.0	20.6	3.6
	Non HT20 Beam Forming, 6 to 54 Mbps	4	10	12.1	8.2	8.2	9.7	15.9	19.6	3.7
	HT/VHT20, M0 to M7	1	4	17.4				17.4	23.6	6.2
	HT/VHT20, M0 to M7	2	4	16.1	16.4			19.3	23.6	4.3
	HT/VHT20, M8 to M15	2	4	17.4	17.6			20.5	23.6	3.1
	HT/VHT20, M0 to M7	3	4	13.6	13.9	12.7		18.2	23.6	5.4
	HT/VHT20, M8 to M15	3	4	16.1	16.4	15.2		20.7	23.6	2.9
	HT/VHT20, M16 to M23	3	4	16.1	16.4	15.2		20.7	23.6	2.9
	HT/VHT20, M0 to M7	4	4	11.7	12.0	10.8	10.3	17.3	23.6	6.3
	HT/VHT20, M8 to M15	4	4	14.8	15.2	14.0	13.4	20.4	23.6	3.2
	HT/VHT20, M16 to M23	4	4	14.8	15.2	14.0	13.4	20.4	23.6	3.2
	HT/VHT20 Beam Forming, M0 to M7	2	7	16.1	16.4			19.3	22.6	3.3
	HT/VHT20 Beam Forming, M8 to M15	2	4	17.4	17.6			20.5	23.6	3.1
	HT/VHT20 Beam Forming, M0 to M7	3	9	12.7	13.0	11.7		17.3	20.6	3.3
	HT/VHT20 Beam Forming, M8 to M15	3	6	16.1	16.4	15.2		20.7	23.6	2.9
	HT/VHT20 Beam Forming, M16 to M23	3	4	16.1	16.4	15.2		20.7	23.6	2.9
	HT/VHT20 Beam Forming, M0 to M7	4	10	12.1	8.3	8.4	9.8	16.0	19.6	3.6
	HT/VHT20 Beam Forming, M8 to M15	4	7	13.6	13.9	12.7	12.2	19.2	22.6	3.4
	HT/VHT20 Beam Forming, M16 to M23	4	5	14.8	15.2	14.0	13.4	20.4	23.6	3.2
	HT/VHT20 STBC, M0 to M7	2	4	17.4	17.6			20.5	23.6	3.1
	HT/VHT20 STBC, M0 to M7	3	4	16.1	16.4	15.2		20.7	23.6	2.9
	HT/VHT20 STBC, M0 to M7	4	4	14.8	15.2	14.0	13.4	20.4	23.6	3.2
	5510	Non HT40, 6 to 54 Mbps	1	4	13.6				13.6	24.0
Non HT40, 6 to 54 Mbps		2	4	11.5	9.0			13.4	24.0	10.6
Non HT40, 6 to 54 Mbps		3	4	11.5	9.0	8.3		14.6	24.0	9.4
Non HT40, 6 to 54 Mbps		4	4	9.6	6.8	6.3	7.4	13.7	24.0	10.3
HT/VHT40, M0 to M7		1	4	16.7				16.7	24.0	7.3



	HT/VHT40, M0 to M7	2	4	14.2	14.5			17.4	24.0	6.6
	HT/VHT40, M8 to M15	2	4	14.2	14.5			17.4	24.0	6.6
	HT/VHT40, M0 to M7	3	4	14.2	14.5	13.9		19.0	24.0	5.0
	HT/VHT40, M8 to M15	3	4	14.2	14.5	13.9		19.0	24.0	5.0
	HT/VHT40, M16 to M23	3	4	14.2	14.5	13.9		19.0	24.0	5.0
	HT/VHT40, M0 to M7	4	4	11.0	11.4	10.9	10.1	16.9	24.0	7.1
	HT/VHT40, M8 to M15	4	4	11.0	11.4	10.9	10.1	16.9	24.0	7.1
	HT/VHT40, M16 to M23	4	4	11.0	11.4	10.9	10.1	16.9	24.0	7.1
	HT/VHT40 Beam Forming, M0 to M7	2	7	12.3	9.6			14.2	23.0	8.8
	HT/VHT40 Beam Forming, M8 to M15	2	4	14.2	14.5			17.4	24.0	6.6
	HT/VHT40 Beam Forming, M0 to M7	3	9	8.4	5.5	5.1		11.4	21.0	9.6
	HT/VHT40 Beam Forming, M8 to M15	3	6	11.0	11.4	10.9		15.9	24.0	8.1
	HT/VHT40 Beam Forming, M16 to M23	3	4	14.2	14.5	13.9		19.0	24.0	5.0
	HT/VHT40 Beam Forming, M0 to M7	4	10	8.4	5.5	5.1	6.1	12.5	20.0	7.5
	HT/VHT40 Beam Forming, M8 to M15	4	7	12.3	9.6	9.0	10.3	16.5	23.0	6.5
	HT/VHT40 Beam Forming, M16 to M23	4	5	12.3	9.6	9.0	10.3	16.5	24.0	7.5
	HT/VHT40 STBC, M0 to M7	2	4	14.2	14.5			17.4	24.0	6.6
	HT/VHT40 STBC, M0 to M7	3	4	14.2	14.5	13.9		19.0	24.0	5.0
	HT/VHT40 STBC, M0 to M7	4	4	11.0	11.4	10.9	10.1	16.9	24.0	7.1
530	Non HT80, 6 to 54 Mbps	1	4	14.5				14.5	24.0	9.5
	Non HT80, 6 to 54 Mbps	2	4	13.4	13.7			16.6	24.0	7.4
	Non HT80, 6 to 54 Mbps	3	4	13.4	13.7	13.6		18.3	24.0	5.7
	Non HT80, 6 to 54 Mbps	4	4	12.3	12.5	12.4	11.8	18.3	24.0	5.7
	VHT80, M0 to M9 1ss	1	4	15.1				15.1	24.0	8.9
	VHT80, M0 to M9 1ss	2	4	15.1	15.3			18.2	24.0	5.8
	VHT80, M0 to M9 2ss	2	4	15.1	15.3			18.2	24.0	5.8
	VHT80, M0 to M9 1ss	3	4	15.1	15.3	15.3		20.0	24.0	4.0
	VHT80, M0 to M9 2ss	3	4	15.1	15.3	15.3		20.0	24.0	4.0
	VHT80, M0 to M9 3ss	3	4	15.1	15.3	15.3		20.0	24.0	4.0
	VHT80, M0 to M9 1ss	4	4	13.9	14.2	14.0	13.5	19.9	24.0	4.1
	VHT80, M0 to M9 2ss	4	4	13.9	14.2	14.0	13.5	19.9	24.0	4.1
	VHT80, M0 to M9 3ss	4	4	13.9	14.2	14.0	13.5	19.9	24.0	4.1
	VHT80 Beam Forming, M0 to M9 1ss	2	7	13.9	14.2			17.1	23.0	5.9
	VHT80 Beam Forming, M0 to M9 2ss	2	4	15.1	15.3			18.2	24.0	5.8
	VHT80 Beam Forming, M0 to M9 1ss	3	9	12.7	13.0	13.0		17.7	21.0	3.3
	VHT80 Beam Forming, M0 to M9 2ss	3	6	13.9	14.2	14.0		18.8	24.0	5.2
	VHT80 Beam Forming, M0 to M9 3ss	3	4	15.1	15.3	15.3		20.0	24.0	4.0
	VHT80 Beam Forming, M0 to M9 1ss	4	10	11.6	10.0	9.0	9.0	16.1	20.0	3.9
	VHT80 Beam Forming, M0 to M9 2ss	4	7	12.7	13.0	13.0	12.5	18.8	23.0	4.2
VHT80 Beam Forming, M0 to M9 3ss	4	5	13.9	14.2	14.0	13.5	19.9	24.0	4.1	



	VHT80 STBC, M0 to M9 1ss	2	4	15.1	15.3			18.2	24.0	5.8
	VHT80 STBC, M0 to M9 1ss	3	4	15.1	15.3	15.3		20.0	24.0	4.0
	VHT80 STBC, M0 to M9 1ss	4	4	13.9	14.2	14.0	13.5	19.9	24.0	4.1
5570	Non HT160, 6 to 54 Mbps	1	4	13.4				13.4	24.0	10.6
	Non HT160, 6 to 54 Mbps	2	4	11.2	11.6			14.4	24.0	9.6
	Non HT160, 6 to 54 Mbps	3	4	11.2	11.6	11.0		16.0	24.0	8.0
	Non HT160, 6 to 54 Mbps	4	4	11.2	11.6	11.0	11.1	17.3	24.0	6.7
	VHT160, M0 to M9 1ss	1	4	16.0				16.0	24.0	8.0
	VHT160, M0 to M9 1ss	2	4	16.0	16.3			19.2	24.0	4.8
	VHT160, M0 to M9 2ss	2	4	16.0	16.3			19.2	24.0	4.8
	VHT160, M0 to M9 1ss	3	4	14.8	15.2	14.7		19.7	24.0	4.3
	VHT160, M0 to M9 2ss	3	4	14.8	15.2	14.7		19.7	24.0	4.3
	VHT160, M0 to M9 3ss	3	4	14.8	15.2	14.7		19.7	24.0	4.3
	VHT160, M0 to M9 1ss	4	4	14.8	15.2	14.7	14.8	20.9	24.0	3.1
	VHT160, M0 to M9 2ss	4	4	14.8	15.2	14.7	14.8	20.9	24.0	3.1
	VHT160, M0 to M9 3ss	4	4	14.8	15.2	14.7	14.8	20.9	24.0	3.1
	VHT160 Beam Forming, M0 to M9 1ss	2	7	13.7	14.2			17.0	23.0	6.0
	VHT160 Beam Forming, M0 to M9 2ss	2	4	16.0	16.3			19.2	24.0	4.8
	VHT160 Beam Forming, M0 to M9 1ss	3	9	11.0	9.8	8.5		14.7	21.0	6.3
	VHT160 Beam Forming, M0 to M9 2ss	3	6	12.7	13.2	12.7		17.6	24.0	6.4
	VHT160 Beam Forming, M0 to M9 3ss	3	4	14.8	15.2	14.7		19.7	24.0	4.3
	VHT160 Beam Forming, M0 to M9 1ss	4	10	11.0	9.8	8.5	8.6	15.6	20.0	4.4
	VHT160 Beam Forming, M0 to M9 2ss	4	7	11.8	12.3	11.7	11.8	17.9	23.0	5.1
	VHT160 Beam Forming, M0 to M9 3ss	4	5	14.8	15.2	14.7	14.8	20.9	24.0	3.1
	VHT160 STBC, M0 to M9 1ss	2	4	16.0	16.3			19.2	24.0	4.8
VHT160 STBC, M0 to M9 1ss	3	4	14.8	15.2	14.7		19.7	24.0	4.3	
VHT160 STBC, M0 to M9 1ss	4	4	14.8	15.2	14.7	14.8	20.9	24.0	3.1	
5560	Non HT20, 6 to 54 Mbps	1	4	16.2				16.2	23.6	7.4
	Non HT20, 6 to 54 Mbps	2	4	16.2	16.5			19.4	23.6	4.2
	Non HT20, 6 to 54 Mbps	3	4	12.7	13.0	13.1		17.7	23.6	5.9
	Non HT20, 6 to 54 Mbps	4	4	10.8	11.1	11.2	11.7	17.2	23.6	6.4
	Non HT20 Beam Forming, 6 to 54 Mbps	2	7	16.2	16.5			19.4	22.6	3.2
	Non HT20 Beam Forming, 6 to 54 Mbps	3	9	12.7	13.0	13.1		17.7	20.6	2.9
	Non HT20 Beam Forming, 6 to 54 Mbps	4	10	10.8	11.1	11.2	11.7	17.2	19.6	2.4
	HT/VHT20, M0 to M7	1	4	16.4				16.4	23.6	7.2
	HT/VHT20, M0 to M7	2	4	16.4	16.7			19.6	23.6	4.0
	HT/VHT20, M8 to M15	2	4	16.4	16.7			19.6	23.6	4.0
	HT/VHT20, M0 to M7	3	4	12.9	13.1	13.3		17.9	23.6	5.7
	HT/VHT20, M8 to M15	3	4	16.4	16.7	16.9		21.4	23.6	2.2



	HT/VHT20, M16 to M23	3	4	16.4	16.7	16.9		21.4	23.6	2.2
	HT/VHT20, M0 to M7	4	4	10.9	11.3	11.4	11.9	17.4	23.6	6.2
	HT/VHT20, M8 to M15	4	4	14.0	14.4	14.6	14.9	20.5	23.6	3.1
	HT/VHT20, M16 to M23	4	4	15.2	15.5	15.7	16.1	21.7	23.6	1.9
	HT/VHT20 Beam Forming, M0 to M7	2	7	16.4	16.7			19.6	22.6	3.0
	HT/VHT20 Beam Forming, M8 to M15	2	4	16.4	16.7			19.6	23.6	4.0
	HT/VHT20 Beam Forming, M0 to M7	3	9	12.9	13.1	13.3		17.9	20.6	2.7
	HT/VHT20 Beam Forming, M8 to M15	3	6	16.4	16.7	16.9		21.4	23.6	2.2
	HT/VHT20 Beam Forming, M16 to M23	3	4	16.4	16.7	16.9		21.4	23.6	2.2
	HT/VHT20 Beam Forming, M0 to M7	4	10	10.9	11.3	11.4	11.9	17.4	19.6	2.2
	HT/VHT20 Beam Forming, M8 to M15	4	7	14.0	14.4	14.6	14.9	20.5	22.6	2.1
	HT/VHT20 Beam Forming, M16 to M23	4	5	15.2	15.5	15.7	16.1	21.7	23.6	1.9
	HT/VHT20 STBC, M0 to M7	2	4	16.4	16.7			19.6	23.6	4.0
	HT/VHT20 STBC, M0 to M7	3	4	16.4	16.7	16.9		21.4	23.6	2.2
	HT/VHT20 STBC, M0 to M7	4	4	14.0	14.4	14.6	14.9	20.5	23.6	3.1
5660	Non HT20, 6 to 54 Mbps	1	4	17.1				17.1	23.6	6.5
	Non HT20, 6 to 54 Mbps	2	4	17.1	17.6			20.4	23.6	3.2
	Non HT20, 6 to 54 Mbps	3	4	12.7	13.2	13.3		17.8	23.5	5.7
	Non HT20, 6 to 54 Mbps	4	4	11.1	9.6	9.7	9.3	16.0	23.5	7.5
	Non HT20 Beam Forming, 6 to 54 Mbps	2	7	17.1	17.6			20.4	22.6	2.2
	Non HT20 Beam Forming, 6 to 54 Mbps	3	9	12.7	13.2	13.3		17.8	20.5	2.7
	Non HT20 Beam Forming, 6 to 54 Mbps	4	10	11.1	9.6	9.7	9.3	16.0	19.5	3.5
	HT/VHT20, M0 to M7	1	4	17.3				17.3	23.6	6.3
	HT/VHT20, M0 to M7	2	4	17.3	17.7			20.5	23.6	3.1
	HT/VHT20, M8 to M15	2	4	17.3	17.7			20.5	23.6	3.1
	HT/VHT20, M0 to M7	3	4	12.7	13.3	13.3		17.9	23.6	5.7
	HT/VHT20, M8 to M15	3	4	16.1	16.6	16.7		21.2	23.6	2.4
	HT/VHT20, M16 to M23	3	4	16.1	16.6	16.7		21.2	23.6	2.4
	HT/VHT20, M0 to M7	4	4	11.3	9.8	9.9	9.5	16.2	23.6	7.4
	HT/VHT20, M8 to M15	4	4	13.7	14.3	14.3	13.5	20.0	23.6	3.6
	HT/VHT20, M16 to M23	4	4	14.9	15.5	15.6	14.7	21.2	23.6	2.4
	HT/VHT20 Beam Forming, M0 to M7	2	7	17.3	17.7			20.5	22.6	2.1
	HT/VHT20 Beam Forming, M8 to M15	2	4	17.3	17.7			20.5	23.6	3.1
	HT/VHT20 Beam Forming, M0 to M7	3	9	12.7	13.3	13.3		17.9	20.6	2.7
	HT/VHT20 Beam Forming, M8 to M15	3	6	16.1	16.6	16.7		21.2	23.6	2.4
	HT/VHT20 Beam Forming, M16 to M23	3	4	16.1	16.6	16.7		21.2	23.6	2.4
	HT/VHT20 Beam Forming, M0 to M7	4	10	11.3	9.8	9.9	9.5	16.2	19.6	3.4
	HT/VHT20 Beam Forming, M8 to M15	4	7	13.7	14.3	14.3	13.5	20.0	22.6	2.6
HT/VHT20 Beam Forming, M16 to M23	4	5	14.9	15.5	15.6	14.7	21.2	23.6	2.4	
HT/VHT20 STBC, M0 to M7	2	4	17.3	17.7			20.5	23.6	3.1	



	HT/VHT20 STBC, M0 to M7	3	4	16.1	16.6	16.7		21.2	23.6	2.4
	HT/VHT20 STBC, M0 to M7	4	4	13.7	14.3	14.3	13.5	20.0	23.6	3.6
5670	Non HT40, 6 to 54 Mbps	1	4	17.7				17.7	24.0	6.3
	Non HT40, 6 to 54 Mbps	2	4	17.7	18.1			20.9	24.0	3.1
	Non HT40, 6 to 54 Mbps	3	4	15.5	15.9	16.1		20.6	24.0	3.4
	Non HT40, 6 to 54 Mbps	4	4	13.1	13.7	14.0	14.6	19.9	24.0	4.1
	HT/VHT40, M0 to M7	1	4	16.6				16.6	24.0	7.4
	HT/VHT40, M0 to M7	2	4	16.6	17.0			19.8	24.0	4.2
	HT/VHT40, M8 to M15	2	4	16.6	17.0			19.8	24.0	4.2
	HT/VHT40, M0 to M7	3	4	15.4	15.8	16.1		20.5	24.0	3.5
	HT/VHT40, M8 to M15	3	4	16.6	17.0	17.3		21.7	24.0	2.3
	HT/VHT40, M16 to M23	3	4	16.6	17.0	17.3		21.7	24.0	2.3
	HT/VHT40, M0 to M7	4	4	13.1	13.8	14.0	13.5	19.6	24.0	4.4
	HT/VHT40, M8 to M15	4	4	16.6	17.0	17.3	16.8	23.0	24.0	1.0
	HT/VHT40, M16 to M23	4	4	16.6	17.0	17.3	16.8	23.0	24.0	1.0
	HT/VHT40 Beam Forming, M0 to M7	2	7	16.6	17.0			19.8	23.0	3.2
	HT/VHT40 Beam Forming, M8 to M15	2	4	16.6	17.0			19.8	24.0	4.2
	HT/VHT40 Beam Forming, M0 to M7	3	9	15.4	15.8	16.1		20.5	21.0	0.5
	HT/VHT40 Beam Forming, M8 to M15	3	6	16.6	17.0	17.3		21.7	24.0	2.3
	HT/VHT40 Beam Forming, M16 to M23	3	4	16.6	17.0	17.3		21.7	24.0	2.3
	HT/VHT40 Beam Forming, M0 to M7	4	10	13.1	13.8	14.0	13.5	19.6	20.0	0.4
	<b>HT/VHT40 Beam Forming, M8 to M15</b>	<b>4</b>	<b>7</b>	<b>16.6</b>	<b>17.0</b>	<b>17.3</b>	<b>16.8</b>	<b>23.0</b>	<b>23.0</b>	<b>0.0</b>
	HT/VHT40 Beam Forming, M16 to M23	4	5	16.6	17.0	17.3	16.8	23.0	24.0	1.0
HT/VHT40 STBC, M0 to M7	2	4	16.6	17.0			19.8	24.0	4.2	
HT/VHT40 STBC, M0 to M7	3	4	16.6	17.0	17.3		21.7	24.0	2.3	
HT/VHT40 STBC, M0 to M7	4	4	16.6	17.0	17.3	16.8	23.0	24.0	1.0	
5690	Non HT80, 6 to 54 Mbps	1	4	15.7				15.7	24.0	8.3
	Non HT80, 6 to 54 Mbps	2	4	15.7	16.2			19.0	24.0	5.0
	Non HT80, 6 to 54 Mbps	3	4	15.7	16.2	16.1		20.8	24.0	3.2
	Non HT80, 6 to 54 Mbps	4	4	15.7	16.2	16.1	16.5	22.2	24.0	1.8
	VHT80, M0 to M9 1ss	1	4	15.9				15.9	24.0	8.1
	VHT80, M0 to M9 1ss	2	4	15.9	16.4			19.2	24.0	4.8
	VHT80, M0 to M9 2ss	2	4	15.9	16.4			19.2	24.0	4.8
	VHT80, M0 to M9 1ss	3	4	15.9	16.4	16.3		21.0	24.0	3.0
	VHT80, M0 to M9 2ss	3	4	15.9	16.4	16.3		21.0	24.0	3.0
	VHT80, M0 to M9 3ss	3	4	15.9	16.4	16.3		21.0	24.0	3.0
	VHT80, M0 to M9 1ss	4	4	15.9	16.4	16.3	16.7	22.4	24.0	1.6
	VHT80, M0 to M9 2ss	4	4	15.9	16.4	16.3	16.7	22.4	24.0	1.6
	VHT80, M0 to M9 3ss	4	4	15.9	16.4	16.3	16.7	22.4	24.0	1.6



	VHT80 Beam Forming, M0 to M9 1ss	2	7	15.9	16.4			19.2	23.0	3.8
	VHT80 Beam Forming, M0 to M9 2ss	2	4	15.9	16.4			19.2	24.0	4.8
	VHT80 Beam Forming, M0 to M9 1ss	3	9	14.8	15.3	15.1		19.8	21.0	1.2
	VHT80 Beam Forming, M0 to M9 2ss	3	6	15.9	16.4	16.3		21.0	24.0	3.0
	VHT80 Beam Forming, M0 to M9 3ss	3	4	15.9	16.4	16.3		21.0	24.0	3.0
	VHT80 Beam Forming, M0 to M9 1ss	4	10	12.5	13.0	13.0	13.5	19.0	20.0	1.0
	VHT80 Beam Forming, M0 to M9 2ss	4	7	15.9	16.4	16.3	16.7	22.4	23.0	0.6
	VHT80 Beam Forming, M0 to M9 3ss	4	5	15.9	16.4	16.3	16.7	22.4	24.0	1.6
	VHT80 STBC, M0 to M9 1ss	2	4	15.9	16.4			19.2	24.0	4.8
	VHT80 STBC, M0 to M9 1ss	3	4	15.9	16.4	16.3		21.0	24.0	3.0
	VHT80 STBC, M0 to M9 1ss	4	4	15.9	16.4	16.3	16.7	22.4	24.0	1.6
5700	Non HT20, 6 to 54 Mbps	1	4	15.4				15.4	23.6	8.2
	Non HT20, 6 to 54 Mbps	2	4	15.4	15.8			18.6	23.6	5.0
	Non HT20, 6 to 54 Mbps	3	4	13.1	13.7	13.4		18.2	23.6	5.4
	Non HT20, 6 to 54 Mbps	4	4	10.0	10.6	10.2	11.6	16.7	23.6	6.9
	Non HT20 Beam Forming, 6 to 54 Mbps	2	7	15.4	15.8			18.6	22.6	4.0
	Non HT20 Beam Forming, 6 to 54 Mbps	3	9	13.1	13.7	13.4		18.2	20.6	2.4
	Non HT20 Beam Forming, 6 to 54 Mbps	4	10	10.0	10.6	10.2	11.6	16.7	19.6	2.9
	HT/VHT20, M0 to M7	1	4	15.6				15.6	23.6	8.0
	HT/VHT20, M0 to M7	2	4	15.6	16.0			18.8	23.6	4.8
	HT/VHT20, M8 to M15	2	4	15.6	16.0			18.8	23.6	4.8
	HT/VHT20, M0 to M7	3	4	13.3	13.9	13.6		18.4	23.6	5.2
	HT/VHT20, M8 to M15	3	4	15.6	16.0	15.7		20.5	23.6	3.1
	HT/VHT20, M16 to M23	3	4	15.6	16.0	15.7		20.5	23.6	3.1
	HT/VHT20, M0 to M7	4	4	11.2	11.8	11.4	12.8	17.9	23.6	5.7
	HT/VHT20, M8 to M15	4	4	13.3	13.9	13.6	14.9	20.0	23.6	3.6
	HT/VHT20, M16 to M23	4	4	14.5	14.9	14.6	17.3	21.5	23.6	2.1
	HT/VHT20 Beam Forming, M0 to M7	2	7	15.6	16.0			18.8	22.6	3.8
	HT/VHT20 Beam Forming, M8 to M15	2	4	15.6	16.0			18.8	23.6	4.8
	HT/VHT20 Beam Forming, M0 to M7	3	9	13.3	13.9	13.6		18.4	20.6	2.2
	HT/VHT20 Beam Forming, M8 to M15	3	6	15.6	16.0	15.7		20.5	23.6	3.1
	HT/VHT20 Beam Forming, M16 to M23	3	4	15.6	16.0	15.7		20.5	23.6	3.1
	HT/VHT20 Beam Forming, M0 to M7	4	10	11.2	11.8	11.4	12.8	17.9	19.6	1.7
	HT/VHT20 Beam Forming, M8 to M15	4	7	13.3	13.9	13.6	14.9	20.0	22.6	2.6
	HT/VHT20 Beam Forming, M16 to M23	4	5	14.5	14.9	14.6	17.3	21.5	23.6	2.1
	HT/VHT20 STBC, M0 to M7	2	4	15.6	16.0			18.8	23.6	4.8
	HT/VHT20 STBC, M0 to M7	3	4	15.6	16.0	15.7		20.5	23.6	3.1
HT/VHT20 STBC, M0 to M7	4	4	13.3	13.9	13.6	14.9	20.0	23.6	3.6	



5710	Non HT40, 6 to 54 Mbps	1	4	16.3				16.3	24.0	7.7
	Non HT40, 6 to 54 Mbps	2	4	16.3	16.7			19.5	24.0	4.5
	Non HT40, 6 to 54 Mbps	3	4	16.3	16.7	16.2		21.2	24.0	2.8
	Non HT40, 6 to 54 Mbps	4	4	13.1	13.5	12.9	14.7	19.6	24.0	4.4
	HT/VHT40, M0 to M7	1	4	15.2				15.2	24.0	8.8
	HT/VHT40, M0 to M7	2	4	15.2	15.7			18.5	24.0	5.5
	HT/VHT40, M8 to M15	2	4	15.2	15.7			18.5	24.0	5.5
	HT/VHT40, M0 to M7	3	4	15.2	15.7	15.1		20.1	24.0	3.9
	HT/VHT40, M8 to M15	3	4	15.2	15.7	15.1		20.1	24.0	3.9
	HT/VHT40, M16 to M23	3	4	15.2	15.7	15.1		20.1	24.0	3.9
	HT/VHT40, M0 to M7	4	4	14.1	14.6	14.0	15.9	20.7	24.0	3.3
	HT/VHT40, M8 to M15	4	4	15.2	15.7	15.1	17.0	21.8	24.0	2.2
	HT/VHT40, M16 to M23	4	4	15.2	15.7	15.1	17.0	21.8	24.0	2.2
	HT/VHT40 Beam Forming, M0 to M7	2	7	15.2	15.7			18.5	23.0	4.5
	HT/VHT40 Beam Forming, M8 to M15	2	4	15.2	15.7			18.5	24.0	5.5
	HT/VHT40 Beam Forming, M0 to M7	3	9	14.1	14.5	14.0		19.0	21.0	2.0
	HT/VHT40 Beam Forming, M8 to M15	3	6	15.2	15.7	15.1		20.1	24.0	3.9
	HT/VHT40 Beam Forming, M16 to M23	3	4	15.2	15.7	15.1		20.1	24.0	3.9
	HT/VHT40 Beam Forming, M0 to M7	4	10	12.9	13.5	13.0	14.8	19.6	20.0	0.4
	HT/VHT40 Beam Forming, M8 to M15	4	7	15.2	15.7	15.1	17.0	21.8	23.0	1.2
HT/VHT40 Beam Forming, M16 to M23	4	5	15.2	15.7	15.1	17.0	21.8	24.0	2.2	
HT/VHT40 STBC, M0 to M7	2	4	15.2	15.7			18.5	24.0	5.5	
HT/VHT40 STBC, M0 to M7	3	4	15.2	15.7	15.1		20.1	24.0	3.9	
HT/VHT40 STBC, M0 to M7	4	4	15.2	15.7	15.1	17.0	21.8	24.0	2.2	
5720	Non HT20, 6 to 54 Mbps	1	4	15.2				15.2	23.6	8.4
	Non HT20, 6 to 54 Mbps	2	4	15.2	15.8			18.5	23.6	5.1
	Non HT20, 6 to 54 Mbps	3	4	13.0	13.7	12.7		17.9	23.5	5.6
	Non HT20, 6 to 54 Mbps	4	4	10.0	10.6	9.6	11.7	16.6	23.6	7.0
	Non HT20 Beam Forming, 6 to 54 Mbps	2	7	15.2	15.8			18.5	22.6	4.1
	Non HT20 Beam Forming, 6 to 54 Mbps	3	9	13.0	13.7	12.7		17.9	20.5	2.6
	Non HT20 Beam Forming, 6 to 54 Mbps	4	10	10.0	10.6	9.6	11.7	16.6	19.6	3.0
	HT/VHT20, M0 to M7	1	4	15.3				15.3	23.6	8.3
	HT/VHT20, M0 to M7	2	4	15.3	16.0			18.7	23.6	4.9
	HT/VHT20, M8 to M15	2	4	15.3	16.0			18.7	23.6	4.9
	HT/VHT20, M0 to M7	3	4	13.1	13.7	12.8		18.0	23.6	5.6
	HT/VHT20, M8 to M15	3	4	15.3	16.0	15.0		20.2	23.6	3.4
	HT/VHT20, M16 to M23	3	4	15.3	16.0	15.0		20.2	23.6	3.4
	HT/VHT20, M0 to M7	4	4	11.0	11.6	10.6	12.8	17.6	23.6	6.0
HT/VHT20, M8 to M15	4	4	13.1	13.7	12.8	14.9	19.7	23.6	3.9	





HT/VHT20, M16 to M23	4	4	14.2	14.8	13.9	17.3	21.3	23.6	2.3
HT/VHT20 Beam Forming, M0 to M7	2	7	15.3	16.0			18.7	22.6	3.9
HT/VHT20 Beam Forming, M8 to M15	2	4	15.3	16.0			18.7	23.6	4.9
HT/VHT20 Beam Forming, M0 to M7	3	9	13.1	13.7	12.8		18.0	20.6	2.6
HT/VHT20 Beam Forming, M8 to M15	3	6	15.3	16.0	15.0		20.2	23.6	3.4
HT/VHT20 Beam Forming, M16 to M23	3	4	15.3	16.0	15.0		20.2	23.6	3.4
HT/VHT20 Beam Forming, M0 to M7	4	10	11.0	11.6	10.6	12.8	17.6	19.6	2.0
HT/VHT20 Beam Forming, M8 to M15	4	7	13.1	13.7	12.8	14.9	19.7	22.6	2.9
HT/VHT20 Beam Forming, M16 to M23	4	5	14.2	14.8	13.9	17.3	21.3	23.6	2.3
HT/VHT20 STBC, M0 to M7	2	4	15.3	16.0			18.7	23.6	4.9
HT/VHT20 STBC, M0 to M7	3	4	15.3	16.0	15.0		20.2	23.6	3.4
HT/VHT20 STBC, M0 to M7	4	4	13.1	13.7	12.8	14.9	19.7	23.6	3.9



Frequency (MHz)	Mode	Tx Paths	Correlated Antenna Gain (dBi)	Tx 1 PSD (dBm/MHz)	Tx 2 PSD (dBm/MHz)	Tx 3 PSD (dBm/MHz)	Tx 4 PSD (dBm/MHz)	Total PSD (dBm/MHz)	Limit (dBm/MHz)	Margin (dB)
5500	Non HT20, 6 to 54 Mbps	1	4	5.5				5.5	11.0	5.5
	Non HT20, 6 to 54 Mbps	2	7	5.5	7.1			9.4	10.0	0.6
	Non HT20, 6 to 54 Mbps	3	9	3.0	3.3	1.9		7.5	8.0	0.5
	Non HT20, 6 to 54 Mbps	4	10	1.4	1.4	0.1	-0.3	6.7	7.0	0.3
	Non HT20 Beam Forming, 6 to 54 Mbps	2	7	5.5	7.1			9.4	10.0	0.6
	Non HT20 Beam Forming, 6 to 54 Mbps	3	9	2.2	2.2	0.9		6.6	8.0	1.4
	Non HT20 Beam Forming, 6 to 54 Mbps	4	10	1.4	-2.2	-2.4	-0.8	5.3	7.0	1.7
	HT/VHT20, M0 to M7	1	4	7.1				7.1	11.0	3.9
	HT/VHT20, M0 to M7	2	7	5.6	5.8			8.7	10.0	1.3
	HT/VHT20, M8 to M15	2	4	7.1	7.5			10.3	11.0	0.7
	HT/VHT20, M0 to M7	3	9	2.8	3.2	2.3		7.6	8.0	0.4
	HT/VHT20, M8 to M15	3	6	5.6	5.8	4.3		10.1	11.0	0.9
	HT/VHT20, M16 to M23	3	4	5.6	5.8	4.3		10.1	11.0	0.9
	HT/VHT20, M0 to M7	4	10	1.2	1.6	-0.1	-0.5	6.7	7.0	0.3
	HT/VHT20, M8 to M15	4	7	4.0	4.5	3.4	2.5	9.7	10.0	0.3
	HT/VHT20, M16 to M23	4	5	4.0	4.5	3.4	2.5	9.7	11.0	1.3
	HT/VHT20 Beam Forming, M0 to M7	2	7	5.6	5.8			8.7	10.0	1.3
	HT/VHT20 Beam Forming, M8 to M15	2	4	7.1	7.5			10.3	11.0	0.7
	HT/VHT20 Beam Forming, M0 to M7	3	9	2.0	2.9	1.0		6.8	8.0	1.2
	HT/VHT20 Beam Forming, M8 to M15	3	6	5.6	5.8	4.3		10.1	11.0	0.9
	HT/VHT20 Beam Forming, M16 to M23	3	4	5.6	5.8	4.3		10.1	11.0	0.9
	HT/VHT20 Beam Forming, M0 to M7	4	10	1.4	-2.6	-2.2	-0.8	5.3	7.0	1.7
	HT/VHT20 Beam Forming, M8 to M15	4	7	2.8	3.2	2.3	1.3	8.5	10.0	1.5
	HT/VHT20 Beam Forming, M16 to M23	4	5	4.0	4.5	3.4	2.5	9.7	11.0	1.3
	HT/VHT20 STBC, M0 to M7	2	4	7.1	7.5			10.3	11.0	0.7
	HT/VHT20 STBC, M0 to M7	3	6	5.6	5.8	4.3		10.1	11.0	0.9
HT/VHT20 STBC, M0 to M7	4	7	4.0	4.5	3.4	2.5	9.7	10.0	0.3	
5510	Non HT40, 6 to 54 Mbps	1	4	0.5				0.5	11.0	10.5
	Non HT40, 6 to 54 Mbps	2	7	-1.6	-4.6			0.2	10.0	9.8
	Non HT40, 6 to 54 Mbps	3	9	-1.6	-4.6	-5.0		1.3	8.0	6.7
	Non HT40, 6 to 54 Mbps	4	10	-3.3	-6.7	-7.1	-5.6	0.6	7.0	6.4
	HT/VHT40, M0 to M7	1	4	3.6				3.6	11.0	7.4
	HT/VHT40, M0 to M7	2	7	0.8	1.4			4.1	10.0	5.9



	HT/VHT40, M8 to M15	2	4	0.8	1.4			4.1	11.0	6.9
	HT/VHT40, M0 to M7	3	9	0.8	1.4	0.1		5.6	8.0	2.4
	HT/VHT40, M8 to M15	3	6	0.8	1.4	0.1		5.6	11.0	5.4
	HT/VHT40, M16 to M23	3	4	0.8	1.4	0.1		5.6	11.0	5.4
	HT/VHT40, M0 to M7	4	10	-2.1	-1.7	-3.0	-3.7	3.5	7.0	3.5
	HT/VHT40, M8 to M15	4	7	-2.1	-1.7	-3.0	-3.7	3.5	10.0	6.5
	HT/VHT40, M16 to M23	4	5	-2.1	-1.7	-3.0	-3.7	3.5	11.0	7.5
	HT/VHT40 Beam Forming, M0 to M7	2	7	-0.9	-4.2			0.8	10.0	9.2
	HT/VHT40 Beam Forming, M8 to M15	2	4	0.8	1.4			4.1	11.0	6.9
	HT/VHT40 Beam Forming, M0 to M7	3	9	-4.9	-8.2	-8.6		-2.1	8.0	10.1
	HT/VHT40 Beam Forming, M8 to M15	3	6	-2.1	-1.7	-3.0		2.5	11.0	8.5
	HT/VHT40 Beam Forming, M16 to M23	3	4	0.8	1.4	0.1		5.6	11.0	5.4
	HT/VHT40 Beam Forming, M0 to M7	4	10	-4.9	-8.2	-8.6	-7.0	-0.9	7.0	7.9
	HT/VHT40 Beam Forming, M8 to M15	4	7	-0.9	-4.2	-4.6	-3.2	3.1	10.0	6.9
	HT/VHT40 Beam Forming, M16 to M23	4	5	-0.9	-4.2	-4.6	-3.2	3.1	11.0	7.9
	HT/VHT40 STBC, M0 to M7	2	4	0.8	1.4			4.1	11.0	6.9
	HT/VHT40 STBC, M0 to M7	3	6	0.8	1.4	0.1		5.6	11.0	5.4
	HT/VHT40 STBC, M0 to M7	4	7	-2.1	-1.7	-3.0	-3.7	3.5	10.0	6.5
5530	Non HT80, 6 to 54 Mbps	1	4	-1.8				-1.8	11.0	12.8
	Non HT80, 6 to 54 Mbps	2	7	-2.7	-2.9			0.2	10.0	9.8
	Non HT80, 6 to 54 Mbps	3	9	-2.7	-2.9	-3.2		1.8	8.0	6.2
	Non HT80, 6 to 54 Mbps	4	10	-4.0	-3.6	-4.4	-4.3	2.0	7.0	5.0
	VHT80, M0 to M9 1ss	1	4	-1.8				-1.8	11.0	12.8
	VHT80, M0 to M9 1ss	2	7	-1.8	-1.4			1.4	10.0	8.6
	VHT80, M0 to M9 2ss	2	4	-1.8	-1.4			1.4	11.0	9.6
	VHT80, M0 to M9 1ss	3	9	-1.8	-1.4	-2.1		3.0	8.0	5.0
	VHT80, M0 to M9 2ss	3	6	-1.8	-1.4	-2.1		3.0	11.0	8.0
	VHT80, M0 to M9 3ss	3	4	-1.8	-1.4	-2.1		3.0	11.0	8.0
	VHT80, M0 to M9 1ss	4	10	-2.8	-2.6	-2.9	-2.6	3.3	7.0	3.7
	VHT80, M0 to M9 2ss	4	7	-2.8	-2.6	-2.9	-2.6	3.3	10.0	6.7
	VHT80, M0 to M9 3ss	4	5	-2.8	-2.6	-2.9	-2.6	3.3	11.0	7.7
	VHT80 Beam Forming, M0 to M9 1ss	2	7	-2.8	-2.6			0.3	10.0	9.7
	VHT80 Beam Forming, M0 to M9 2ss	2	4	-1.8	-1.4			1.4	11.0	9.6
	VHT80 Beam Forming, M0 to M9 1ss	3	9	-4.2	-3.4	-4.2		0.9	8.0	7.1
	VHT80 Beam Forming, M0 to M9 2ss	3	6	-2.8	-2.6	-2.9		2.0	11.0	9.0
	VHT80 Beam Forming, M0 to M9 3ss	3	4	-1.8	-1.4	-2.1		3.0	11.0	8.0
	VHT80 Beam Forming, M0 to M9 1ss	4	10	-4.4	-6.5	-8.4	-7.3	-0.4	7.0	7.4
	VHT80 Beam Forming, M0 to M9 2ss	4	7	-4.2	-3.4	-4.2	-3.9	2.1	10.0	7.9
VHT80 Beam Forming, M0 to M9 3ss	4	5	-2.8	-2.6	-2.9	-2.6	3.3	11.0	7.7	
VHT80 STBC, M0 to M9 1ss	2	4	-1.8	-1.4			1.4	11.0	9.6	



	VHT80 STBC, M0 to M9 1ss	3	4	-1.8	-1.4	-2.1		3.0	11.0	8.0
	VHT80 STBC, M0 to M9 1ss	4	4	-2.8	-2.6	-2.9	-2.6	3.3	11.0	7.7
5570	Non HT160, 6 to 54 Mbps	1	4	-5.3				-5.3	11.0	16.3
	Non HT160, 6 to 54 Mbps	2	7	-7.4	-6.7			-4.0	10.0	14.0
	Non HT160, 6 to 54 Mbps	3	9	-7.4	-6.7	-8.2		-2.6	8.0	10.6
	Non HT160, 6 to 54 Mbps	4	10	-7.4	-6.7	-8.2	-7.9	-1.5	7.0	8.5
	VHT160, M0 to M9 1ss	1	4	-2.6				-2.6	11.0	13.6
	VHT160, M0 to M9 1ss	2	7	-2.6	-2.6			0.4	10.0	9.6
	VHT160, M0 to M9 2ss	2	4	-2.6	-2.6			0.4	11.0	10.6
	VHT160, M0 to M9 1ss	3	9	-4.1	-3.7	-4.9		0.6	8.0	7.4
	VHT160, M0 to M9 2ss	3	6	-4.1	-3.7	-4.9		0.6	11.0	10.4
	VHT160, M0 to M9 3ss	3	4	-4.1	-3.7	-4.9		0.6	11.0	10.4
	VHT160, M0 to M9 1ss	4	10	-4.1	-3.7	-4.9	-4.4	1.8	7.0	5.2
	VHT160, M0 to M9 2ss	4	7	-4.1	-3.7	-4.9	-4.4	1.8	10.0	8.2
	VHT160, M0 to M9 3ss	4	5	-4.1	-3.7	-4.9	-4.4	1.8	11.0	9.2
	VHT160 Beam Forming, M0 to M9 1ss	2	7	-5.4	-4.6			-2.0	10.0	12.0
	VHT160 Beam Forming, M0 to M9 2ss	2	4	-2.6	-2.6			0.4	11.0	10.6
	VHT160 Beam Forming, M0 to M9 1ss	3	9	-7.7	-10.4	-11.3		-4.7	8.0	12.7
	VHT160 Beam Forming, M0 to M9 2ss	3	6	-6.5	-6.0	-6.9		-1.7	11.0	12.7
	VHT160 Beam Forming, M0 to M9 3ss	3	4	-4.1	-3.7	-4.9		0.6	11.0	10.4
	VHT160 Beam Forming, M0 to M9 1ss	4	10	-7.7	-10.4	-11.3	-10.2	-3.7	7.0	10.7
	VHT160 Beam Forming, M0 to M9 2ss	4	7	-7.1	-6.7	-8.0	-7.6	-1.3	10.0	11.3
	VHT160 Beam Forming, M0 to M9 3ss	4	5	-4.1	-3.7	-4.9	-4.4	1.8	11.0	9.2
VHT160 STBC, M0 to M9 1ss	2	4	-2.6	-2.6			0.4	11.0	10.6	
VHT160 STBC, M0 to M9 1ss	3	4	-4.1	-3.7	-4.9		0.6	11.0	10.4	
VHT160 STBC, M0 to M9 1ss	4	4	-4.1	-3.7	-4.9	-4.4	1.8	11.0	9.2	
5560	Non HT20, 6 to 54 Mbps	1	4	5.8				5.8	11.0	5.2
	Non HT20, 6 to 54 Mbps	2	7	5.8	6.5			9.2	10.0	0.8
	Non HT20, 6 to 54 Mbps	3	9	2.2	2.5	2.5		7.2	8.0	0.8
	Non HT20, 6 to 54 Mbps	4	10	0.4	0.6	0.5	1.5	6.8	7.0	0.2
	Non HT20 Beam Forming, 6 to 54 Mbps	2	7	5.8	6.5			9.2	10.0	0.8
	Non HT20 Beam Forming, 6 to 54 Mbps	3	9	2.2	2.5	2.5		7.2	8.0	0.8
	Non HT20 Beam Forming, 6 to 54 Mbps	4	10	0.4	0.6	0.5	1.5	6.8	7.0	0.2
	HT/VHT20, M0 to M7	1	4	5.6				5.6	11.0	5.4
	HT/VHT20, M0 to M7	2	7	5.6	6.0			8.8	10.0	1.2
	HT/VHT20, M8 to M15	2	4	5.6	6.0			8.8	11.0	2.2
	HT/VHT20, M0 to M7	3	9	2.7	2.4	2.5		7.3	8.0	0.7
	HT/VHT20, M8 to M15	3	6	5.6	6.0	6.1		10.7	11.0	0.3
	HT/VHT20, M16 to M23	3	4	5.6	6.0	6.1		10.7	11.0	0.3



	HT/VHT20, M0 to M7	4	10	0.1	0.8	0.5	1.1	6.7	7.0	0.3
	HT/VHT20, M8 to M15	4	7	3.3	3.5	3.7	4.3	9.7	10.0	0.3
	<b>HT/VHT20, M16 to M23</b>	<b>4</b>	<b>5</b>	<b>4.3</b>	<b>5.0</b>	<b>5.0</b>	<b>5.4</b>	<b>11.0</b>	<b>11.0</b>	<b>0.0</b>
	HT/VHT20 Beam Forming, M0 to M7	2	7	5.6	6.0			8.8	10.0	1.2
	HT/VHT20 Beam Forming, M8 to M15	2	4	5.6	6.0			8.8	11.0	2.2
	HT/VHT20 Beam Forming, M0 to M7	3	9	2.7	2.4	2.5		7.3	8.0	0.7
	HT/VHT20 Beam Forming, M8 to M15	3	6	5.6	6.0	6.1		10.7	11.0	0.3
	HT/VHT20 Beam Forming, M16 to M23	3	4	5.6	6.0	6.1		10.7	11.0	0.3
	HT/VHT20 Beam Forming, M0 to M7	4	10	0.1	0.8	0.5	1.1	6.7	7.0	0.3
	HT/VHT20 Beam Forming, M8 to M15	4	7	3.3	3.5	3.7	4.3	9.7	10.0	0.3
	HT/VHT20 Beam Forming, M16 to M23	4	5	4.3	5.0	5.0	5.4	11.0	11.0	0.0
	HT/VHT20 STBC, M0 to M7	2	4	5.6	6.0			8.8	11.0	2.2
	HT/VHT20 STBC, M0 to M7	3	6	5.6	6.0	6.1		10.7	11.0	0.3
	HT/VHT20 STBC, M0 to M7	4	7	3.3	3.5	3.7	4.3	9.7	10.0	0.3
5660	Non HT20, 6 to 54 Mbps	1	4	6.8				6.8	11.0	4.2
	Non HT20, 6 to 54 Mbps	2	7	6.8	6.9			9.9	10.0	0.1
	Non HT20, 6 to 54 Mbps	3	9	2.4	2.8	2.8		7.4	8.0	0.6
	Non HT20, 6 to 54 Mbps	4	10	0.6	-0.8	-0.8	-1.2	5.5	7.0	1.5
	Non HT20 Beam Forming, 6 to 54 Mbps	2	7	6.8	6.9			9.9	10.0	0.1
	Non HT20 Beam Forming, 6 to 54 Mbps	3	9	2.4	2.8	2.8		7.4	8.0	0.6
	Non HT20 Beam Forming, 6 to 54 Mbps	4	10	0.6	-0.8	-0.8	-1.2	5.5	7.0	1.5
	HT/VHT20, M0 to M7	1	4	6.5				6.5	11.0	4.5
	HT/VHT20, M0 to M7	2	7	6.5	7.0			9.8	10.0	0.2
	HT/VHT20, M8 to M15	2	4	6.5	7.0			9.8	11.0	1.2
	HT/VHT20, M0 to M7	3	9	1.9	2.8	2.8		7.3	8.0	0.7
	HT/VHT20, M8 to M15	3	6	5.3	5.8	5.8		10.4	11.0	0.6
	HT/VHT20, M16 to M23	3	4	5.3	5.8	5.8		10.4	11.0	0.6
	HT/VHT20, M0 to M7	4	10	0.4	-0.7	-1.0	-1.2	5.4	7.0	1.6
	HT/VHT20, M8 to M15	4	7	3.1	3.6	3.6	2.8	9.3	10.0	0.7
	HT/VHT20, M16 to M23	4	5	4.3	4.7	4.5	3.9	10.4	11.0	0.6
	HT/VHT20 Beam Forming, M0 to M7	2	7	6.5	7.0			9.8	10.0	0.2
	HT/VHT20 Beam Forming, M8 to M15	2	4	6.5	7.0			9.8	11.0	1.2
	HT/VHT20 Beam Forming, M0 to M7	3	9	1.9	2.8	2.8		7.3	8.0	0.7
	HT/VHT20 Beam Forming, M8 to M15	3	6	5.3	5.8	5.8		10.4	11.0	0.6
	HT/VHT20 Beam Forming, M16 to M23	3	4	5.3	5.8	5.8		10.4	11.0	0.6
	HT/VHT20 Beam Forming, M0 to M7	4	10	0.4	-0.7	-1.0	-1.2	5.4	7.0	1.6
	HT/VHT20 Beam Forming, M8 to M15	4	7	3.1	3.6	3.6	2.8	9.3	10.0	0.7
HT/VHT20 Beam Forming, M16 to M23	4	5	4.3	4.7	4.5	3.9	10.4	11.0	0.6	
HT/VHT20 STBC, M0 to M7	2	4	6.5	7.0			9.8	11.0	1.2	
HT/VHT20 STBC, M0 to M7	3	6	5.3	5.8	5.8		10.4	11.0	0.6	



	HT/VHT20 STBC, M0 to M7	4	7	3.1	3.6	3.6	2.8	9.3	10.0	0.7
5670	Non HT40, 6 to 54 Mbps	1	4	4.8				4.8	11.0	6.2
	Non HT40, 6 to 54 Mbps	2	7	4.8	4.9			7.9	10.0	2.1
	Non HT40, 6 to 54 Mbps	3	9	2.3	2.9	2.8		7.4	8.0	0.6
	Non HT40, 6 to 54 Mbps	4	10	0.1	0.6	0.8	1.0	6.7	7.0	0.3
	HT/VHT40, M0 to M7	1	4	3.7				3.7	11.0	7.3
	HT/VHT40, M0 to M7	2	7	3.7	3.9			6.8	10.0	3.2
	HT/VHT40, M8 to M15	2	4	3.7	3.9			6.8	11.0	4.2
	HT/VHT40, M0 to M7	3	9	1.9	2.7	2.5		7.2	8.0	0.8
	HT/VHT40, M8 to M15	3	6	3.7	3.9	3.9		8.6	11.0	2.4
	HT/VHT40, M16 to M23	3	4	3.7	3.9	3.9		8.6	11.0	2.4
	HT/VHT40, M0 to M7	4	10	-0.4	0.6	0.6	-0.2	6.2	7.0	0.8
	HT/VHT40, M8 to M15	4	7	3.7	3.9	3.9	3.3	9.7	10.0	0.3
	HT/VHT40, M16 to M23	4	5	3.7	3.9	3.9	3.3	9.7	11.0	1.3
	HT/VHT40 Beam Forming, M0 to M7	2	7	3.7	3.9			6.8	10.0	3.2
	HT/VHT40 Beam Forming, M8 to M15	2	4	3.7	3.9			6.8	11.0	4.2
	HT/VHT40 Beam Forming, M0 to M7	3	9	1.9	2.7	2.5		7.2	8.0	0.8
	HT/VHT40 Beam Forming, M8 to M15	3	6	3.7	3.9	3.9		8.6	11.0	2.4
	HT/VHT40 Beam Forming, M16 to M23	3	4	3.7	3.9	3.9		8.6	11.0	2.4
	HT/VHT40 Beam Forming, M0 to M7	4	10	-0.4	0.6	0.6	-0.2	6.2	7.0	0.8
	HT/VHT40 Beam Forming, M8 to M15	4	7	3.7	3.9	3.9	3.3	9.7	10.0	0.3
	HT/VHT40 Beam Forming, M16 to M23	4	5	3.7	3.9	3.9	3.3	9.7	11.0	1.3
HT/VHT40 STBC, M0 to M7	2	4	3.7	3.9			6.8	11.0	4.2	
HT/VHT40 STBC, M0 to M7	3	6	3.7	3.9	3.9		8.6	11.0	2.4	
HT/VHT40 STBC, M0 to M7	4	7	3.7	3.9	3.9	3.3	9.7	10.0	0.3	
5690	Non HT80, 6 to 54 Mbps	1	4	-0.8				-0.8	11.0	11.8
	Non HT80, 6 to 54 Mbps	2	7	-0.8	-0.1			2.6	10.0	7.4
	Non HT80, 6 to 54 Mbps	3	9	-0.8	-0.1	0.2		4.6	8.0	3.4
	Non HT80, 6 to 54 Mbps	4	10	-0.8	-0.1	0.2	-0.3	5.8	7.0	1.2
	VHT80, M0 to M9 1ss	1	4	-0.5				-0.5	11.0	11.5
	VHT80, M0 to M9 1ss	2	7	-0.5	-0.3			2.6	10.0	7.4
	VHT80, M0 to M9 2ss	2	4	-0.5	-0.3			2.6	11.0	8.4
	VHT80, M0 to M9 1ss	3	9	-0.5	-0.3	-0.3		4.4	8.0	3.6
	VHT80, M0 to M9 2ss	3	6	-0.5	-0.3	-0.3		4.4	11.0	6.6
	VHT80, M0 to M9 3ss	3	4	-0.5	-0.3	-0.3		4.4	11.0	6.6
	VHT80, M0 to M9 1ss	4	10	-0.5	-0.3	-0.3	-0.7	5.6	7.0	1.4
	VHT80, M0 to M9 2ss	4	7	-0.5	-0.3	-0.3	-0.7	5.6	10.0	4.4
	VHT80, M0 to M9 3ss	4	5	-0.5	-0.3	-0.3	-0.7	5.6	11.0	5.4
	VHT80 Beam Forming, M0 to M9 1ss	2	7	-0.5	-0.3			2.6	10.0	7.4



	VHT80 Beam Forming, M0 to M9 2ss	2	4	-0.5	-0.3			2.6	11.0	8.4
	VHT80 Beam Forming, M0 to M9 1ss	3	9	-1.8	-1.5	-1.4		3.2	8.0	4.8
	VHT80 Beam Forming, M0 to M9 2ss	3	6	-0.5	-0.3	-0.3		4.4	11.0	6.6
	VHT80 Beam Forming, M0 to M9 3ss	3	4	-0.5	-0.3	-0.3		4.4	11.0	6.6
	VHT80 Beam Forming, M0 to M9 1ss	4	10	-4.0	-4.0	-3.6	-4.0	2.1	7.0	4.9
	VHT80 Beam Forming, M0 to M9 2ss	4	7	-0.5	-0.3	-0.3	-0.7	5.6	10.0	4.4
	VHT80 Beam Forming, M0 to M9 3ss	4	5	-0.5	-0.3	-0.3	-0.7	5.6	11.0	5.4
	VHT80 STBC, M0 to M9 1ss	2	4	-0.5	-0.3			2.6	11.0	8.4
	VHT80 STBC, M0 to M9 1ss	3	4	-0.5	-0.3	-0.3		4.4	11.0	6.6
	VHT80 STBC, M0 to M9 1ss	4	4	-0.5	-0.3	-0.3	-0.7	5.6	11.0	5.4
5700	Non HT20, 6 to 54 Mbps	1	4	4.7				4.7	11.0	6.3
	Non HT20, 6 to 54 Mbps	2	7	4.7	5.1			7.9	10.0	2.1
	Non HT20, 6 to 54 Mbps	3	9	2.6	3.1	2.9		7.6	8.0	0.4
	Non HT20, 6 to 54 Mbps	4	10	-0.1	-0.1	0.0	1.0	6.2	7.0	0.8
	Non HT20 Beam Forming, 6 to 54 Mbps	2	7	4.7	5.1			7.9	10.0	2.1
	Non HT20 Beam Forming, 6 to 54 Mbps	3	9	2.6	3.1	2.9		7.6	8.0	0.4
	Non HT20 Beam Forming, 6 to 54 Mbps	4	10	-0.1	-0.1	0.0	1.0	6.2	7.0	0.8
	HT/VHT20, M0 to M7	1	4	4.6				4.6	11.0	6.4
	HT/VHT20, M0 to M7	2	7	4.6	5.1			7.9	10.0	2.1
	HT/VHT20, M8 to M15	2	4	4.6	5.1			7.9	11.0	3.1
	HT/VHT20, M0 to M7	3	9	2.8	3.1	3.0		7.7	8.0	0.3
	HT/VHT20, M8 to M15	3	6	4.6	5.1	5.3		9.8	11.0	1.2
	HT/VHT20, M16 to M23	3	4	4.6	5.1	5.3		9.8	11.0	1.2
	HT/VHT20, M0 to M7	4	10	0.2	1.0	0.7	1.7	7.0	7.0	0.0
	HT/VHT20, M8 to M15	4	7	2.8	3.1	3.0	3.9	9.2	10.0	0.8
	HT/VHT20, M16 to M23	4	5	3.7	4.0	4.0	6.3	10.7	11.0	0.3
	HT/VHT20 Beam Forming, M0 to M7	2	7	4.6	5.1			7.9	10.0	2.1
	HT/VHT20 Beam Forming, M8 to M15	2	4	4.6	5.1			7.9	11.0	3.1
	HT/VHT20 Beam Forming, M0 to M7	3	9	2.8	3.1	3.0		7.7	8.0	0.3
	HT/VHT20 Beam Forming, M8 to M15	3	6	4.6	5.1	5.3		9.8	11.0	1.2
	HT/VHT20 Beam Forming, M16 to M23	3	4	4.6	5.1	5.3		9.8	11.0	1.2
	HT/VHT20 Beam Forming, M0 to M7	4	10	0.2	1.0	0.7	1.7	7.0	7.0	0.0
	HT/VHT20 Beam Forming, M8 to M15	4	7	2.8	3.1	3.0	3.9	9.2	10.0	0.8
	HT/VHT20 Beam Forming, M16 to M23	4	5	3.7	4.0	4.0	6.3	10.7	11.0	0.3
	HT/VHT20 STBC, M0 to M7	2	4	4.6	5.1			7.9	11.0	3.1
	HT/VHT20 STBC, M0 to M7	3	6	4.6	5.1	5.3		9.8	11.0	1.2
	HT/VHT20 STBC, M0 to M7	4	7	2.8	3.1	3.0	3.9	9.2	10.0	0.8



5710	Non HT40, 6 to 54 Mbps	1	4	2.9				2.9	11.0	8.1
	Non HT40, 6 to 54 Mbps	2	7	2.9	3.0			6.0	10.0	4.0
	Non HT40, 6 to 54 Mbps	3	9	2.9	3.0	3.0		7.7	8.0	0.3
	Non HT40, 6 to 54 Mbps	4	10	-0.4	-0.2	0.2	1.3	6.3	7.0	0.7
	HT/VHT40, M0 to M7	1	4	1.3				1.3	11.0	9.7
	HT/VHT40, M0 to M7	2	7	1.3	1.9			4.6	10.0	5.4
	HT/VHT40, M8 to M15	2	4	1.3	1.9			4.6	11.0	6.4
	HT/VHT40, M0 to M7	3	9	1.3	1.9	1.8		6.4	8.0	1.6
	HT/VHT40, M8 to M15	3	6	1.3	1.9	1.8		6.4	11.0	4.6
	HT/VHT40, M16 to M23	3	4	1.3	1.9	1.8		6.4	11.0	4.6
	HT/VHT40, M0 to M7	4	10	0.2	0.8	0.4	2.0	6.9	7.0	0.1
	HT/VHT40, M8 to M15	4	7	1.3	1.9	1.8	3.2	8.1	10.0	1.9
	HT/VHT40, M16 to M23	4	5	1.3	1.9	1.8	3.2	8.1	11.0	2.9
	HT/VHT40 Beam Forming, M0 to M7	2	7	1.3	1.9			4.6	10.0	5.4
	HT/VHT40 Beam Forming, M8 to M15	2	4	1.3	1.9			4.6	11.0	6.4
	HT/VHT40 Beam Forming, M0 to M7	3	9	0.2	1.3	0.6		5.5	8.0	2.5
	HT/VHT40 Beam Forming, M8 to M15	3	6	1.3	1.9	1.8		6.4	11.0	4.6
	HT/VHT40 Beam Forming, M16 to M23	3	4	1.3	1.9	1.8		6.4	11.0	4.6
	HT/VHT40 Beam Forming, M0 to M7	4	10	-0.7	-0.3	-0.6	1.0	5.9	7.0	1.1
	HT/VHT40 Beam Forming, M8 to M15	4	7	1.3	1.9	1.8	3.2	8.1	10.0	1.9
HT/VHT40 Beam Forming, M16 to M23	4	5	1.3	1.9	1.8	3.2	8.1	11.0	2.9	
HT/VHT40 STBC, M0 to M7	2	4	1.3	1.9			4.6	11.0	6.4	
HT/VHT40 STBC, M0 to M7	3	6	1.3	1.9	1.8		6.4	11.0	4.6	
HT/VHT40 STBC, M0 to M7	4	7	1.3	1.9	1.8	3.2	8.1	10.0	1.9	
5720	Non HT20, 6 to 54 Mbps	1	4	4.5				4.5	11.0	6.5
	Non HT20, 6 to 54 Mbps	2	7	4.5	5.6			8.1	10.0	1.9
	Non HT20, 6 to 54 Mbps	3	9	2.4	3.0	2.0		7.3	8.0	0.7
	Non HT20, 6 to 54 Mbps	4	10	-0.7	0.1	-1.2	1.1	5.9	7.0	1.1
	Non HT20 Beam Forming, 6 to 54 Mbps	2	7	4.5	5.6			8.1	10.0	1.9
	Non HT20 Beam Forming, 6 to 54 Mbps	3	9	2.4	3.0	2.0		7.3	8.0	0.7
	Non HT20 Beam Forming, 6 to 54 Mbps	4	10	-0.7	0.1	-1.2	1.1	5.9	7.0	1.1
	HT/VHT20, M0 to M7	1	4	4.4				4.4	11.0	6.6
	HT/VHT20, M0 to M7	2	7	4.4	5.3			7.9	10.0	2.1
	HT/VHT20, M8 to M15	2	4	4.4	5.3			7.9	11.0	3.1
	HT/VHT20, M0 to M7	3	9	2.2	3.1	2.2		7.3	8.0	0.7
	HT/VHT20, M8 to M15	3	6	4.4	5.3	4.2		9.4	11.0	1.6
	HT/VHT20, M16 to M23	3	4	4.4	5.3	4.2		9.4	11.0	1.6
	HT/VHT20, M0 to M7	4	10	0.3	0.7	-0.2	2.1	6.8	7.0	0.2
	HT/VHT20, M8 to M15	4	7	2.2	3.1	2.2	4.1	9.0	10.0	1.0
HT/VHT20, M16 to M23	4	5	3.6	3.9	3.0	6.3	10.4	11.0	0.6	





HT/VHT20 Beam Forming, M0 to M7	2	7	4.4	5.3			7.9	10.0	2.1
HT/VHT20 Beam Forming, M8 to M15	2	4	4.4	5.3			7.9	11.0	3.1
HT/VHT20 Beam Forming, M0 to M7	3	9	2.2	3.1	2.2		7.3	8.0	0.7
HT/VHT20 Beam Forming, M8 to M15	3	6	4.4	5.3	4.2		9.4	11.0	1.6
HT/VHT20 Beam Forming, M16 to M23	3	4	4.4	5.3	4.2		9.4	11.0	1.6
HT/VHT20 Beam Forming, M0 to M7	4	10	0.3	0.7	-0.2	2.1	6.8	7.0	0.2
HT/VHT20 Beam Forming, M8 to M15	4	7	2.2	3.1	2.2	4.1	9.0	10.0	1.0
HT/VHT20 Beam Forming, M16 to M23	4	5	3.6	3.9	3.0	6.3	10.4	11.0	0.6
HT/VHT20 STBC, M0 to M7	2	4	4.4	5.3			7.9	11.0	3.1
HT/VHT20 STBC, M0 to M7	3	6	4.4	5.3	4.2		9.4	11.0	1.6
HT/VHT20 STBC, M0 to M7	4	7	2.2	3.1	2.2	4.1	9.0	10.0	1.0



**Peak Output Power, 5670 MHz, HT/VHT40 Beam Forming, M8 to M15**

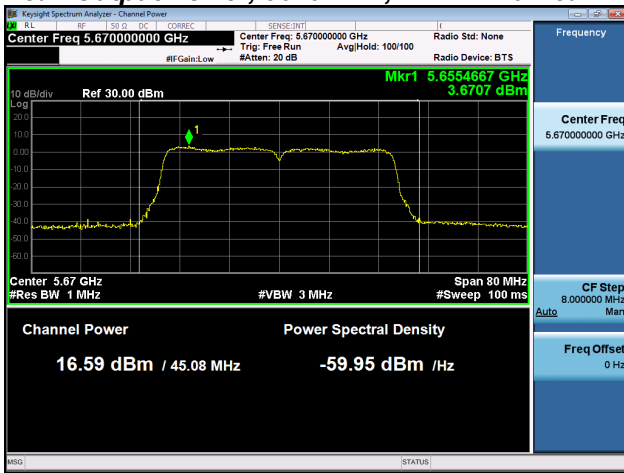

**Antenna A**

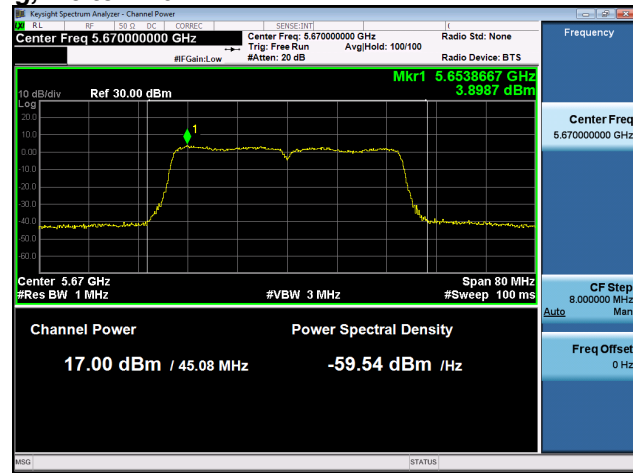

**Antenna B**

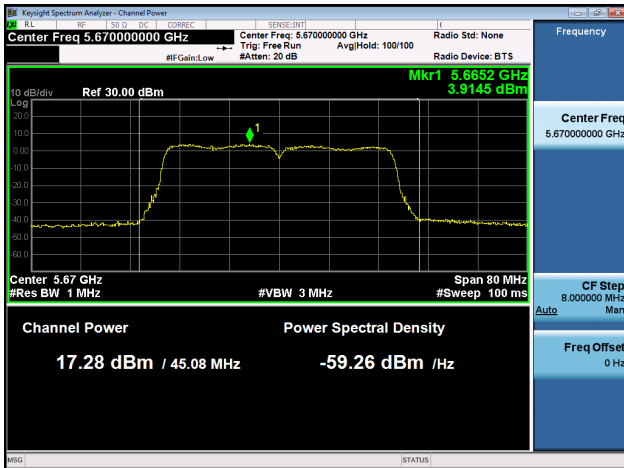

**Antenna C**

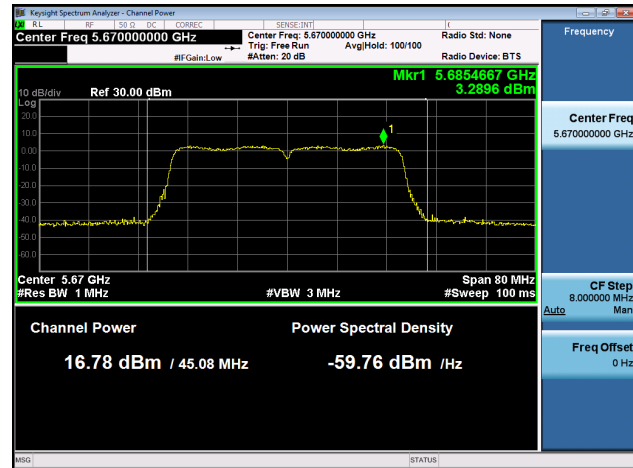

**Antenna D**



**Power Spectral Density, 5560 MHz, HT/VHT20, M16 to M23**

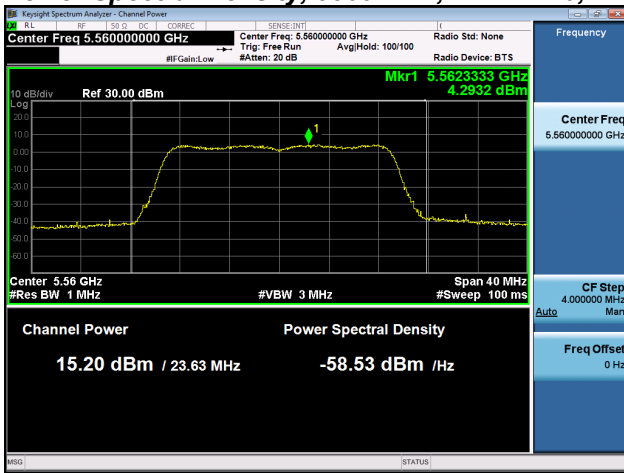

**Antenna A**

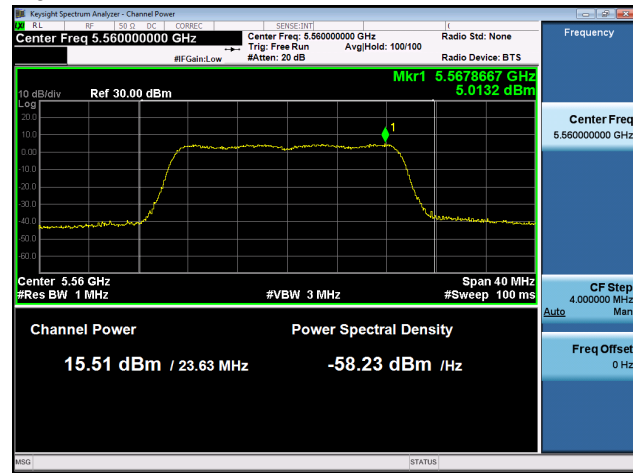

**Antenna B**

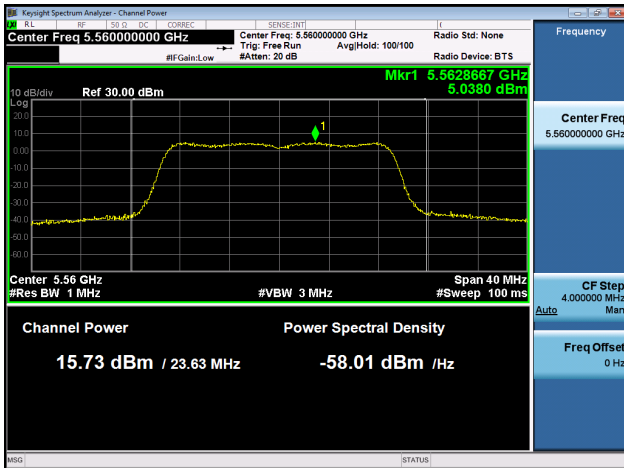

**Antenna C**

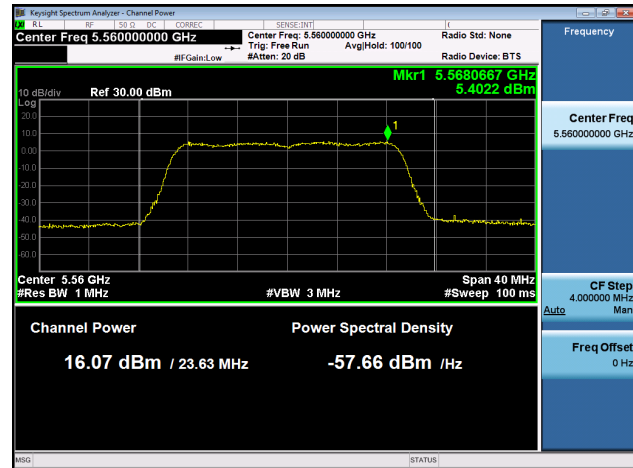

**Antenna D**



Antenna Gain : 5 dBi

Frequency (MHz)	Mode	Tx Paths	Correlated Antenna Gain (dBi)	Tx 1 Max Power (dBm)	Tx 2 Max Power (dBm)	Tx 3 Max Power (dBm)	Tx 4 Max Power (dBm)	Total Tx Channel Power (dBm)	Limit (dBm)	Margin (dB)
5500	Non HT20, 6 to 54 Mbps	1	5	16.0				16.0	23.6	7.6
	Non HT20, 6 to 54 Mbps	2	5	15.9	16.2			19.1	23.6	4.5
	Non HT20, 6 to 54 Mbps	3	5	12.5	12.7	11.5		17.0	23.6	6.6
	Non HT20, 6 to 54 Mbps	4	5	12.1	8.2	8.2	9.7	15.9	23.6	7.7
	Non HT20 Beam Forming, 6 to 54 Mbps	2	8	14.6	14.9			17.8	21.6	3.8
	Non HT20 Beam Forming, 6 to 54 Mbps	3	10	11.5	11.8	10.6		16.1	19.6	3.5
	Non HT20 Beam Forming, 6 to 54 Mbps	4	11	11.1	7.1	7.3	8.8	14.9	18.6	3.7
	HT/VHT20, M0 to M7	1	5	17.4				17.4	23.6	6.2
	HT/VHT20, M0 to M7	2	5	16.1	16.4			19.3	23.6	4.3
	HT/VHT20, M8 to M15	2	5	17.4	17.6			20.5	23.6	3.1
	HT/VHT20, M0 to M7	3	5	12.7	13.0	11.7		17.3	23.6	6.3
	HT/VHT20, M8 to M15	3	5	14.8	15.2	14.0		19.5	23.6	4.1
	HT/VHT20, M16 to M23	3	5	16.1	16.4	15.2		20.7	23.6	2.9
	HT/VHT20, M0 to M7	4	5	12.1	8.3	8.4	9.8	16.0	23.6	7.6
	HT/VHT20, M8 to M15	4	5	13.6	13.9	12.7	12.2	19.2	23.6	4.4
	HT/VHT20, M16 to M23	4	5	14.8	15.2	14.0	13.4	20.4	23.6	3.2
	HT/VHT20 Beam Forming, M0 to M7	2	8	14.8	15.2			18.0	21.6	3.6
	HT/VHT20 Beam Forming, M8 to M15	2	5	17.4	17.6			20.5	23.6	3.1
	HT/VHT20 Beam Forming, M0 to M7	3	10	11.7	12.0	10.8		16.3	19.6	3.3
	HT/VHT20 Beam Forming, M8 to M15	3	7	14.8	15.2	14.0		19.5	22.6	3.1
	HT/VHT20 Beam Forming, M16 to M23	3	5	16.1	16.4	15.2		20.7	23.6	2.9
	HT/VHT20 Beam Forming, M0 to M7	4	11	11.2	7.2	7.4	9.0	15.0	18.6	3.6
	HT/VHT20 Beam Forming, M8 to M15	4	8	12.7	13.0	11.7	11.3	18.3	21.6	3.3
	HT/VHT20 Beam Forming, M16 to M23	4	6	14.8	15.2	14.0	13.4	20.4	23.6	3.2
	HT/VHT20 STBC, M0 to M7	2	5	17.4	17.6			20.5	23.6	3.1
	HT/VHT20 STBC, M0 to M7	3	5	14.8	15.2	14.0		19.5	23.6	4.1
	HT/VHT20 STBC, M0 to M7	4	5	13.6	13.9	12.7	12.2	19.2	23.6	4.4
	5510	Non HT40, 6 to 54 Mbps	1	5	12.6				12.6	24.0
Non HT40, 6 to 54 Mbps		2	5	11.5	9.0			13.4	24.0	10.6
Non HT40, 6 to 54 Mbps		3	5	9.6	6.8	6.3		12.6	24.0	11.4
Non HT40, 6 to 54 Mbps		4	5	9.6	6.8	6.3	7.4	13.7	24.0	10.3
HT/VHT40, M0 to M7		1	5	16.7				16.7	24.0	7.3



	HT/VHT40, M0 to M7	2	5	12.9	13.3			16.1	24.0	7.9
	HT/VHT40, M8 to M15	2	5	12.9	13.3			16.1	24.0	7.9
	HT/VHT40, M0 to M7	3	5	11.0	11.4	10.9		15.9	24.0	8.1
	HT/VHT40, M8 to M15	3	5	11.0	11.4	10.9		15.9	24.0	8.1
	HT/VHT40, M16 to M23	3	5	11.0	11.4	10.9		15.9	24.0	8.1
	HT/VHT40, M0 to M7	4	5	12.3	9.6	9.0	10.3	16.5	24.0	7.5
	HT/VHT40, M8 to M15	4	5	12.3	9.6	9.0	10.3	16.5	24.0	7.5
	HT/VHT40, M16 to M23	4	5	12.3	9.6	9.0	10.3	16.5	24.0	7.5
	HT/VHT40 Beam Forming, M0 to M7	2	8	12.3	9.6			14.2	22.0	7.8
	HT/VHT40 Beam Forming, M8 to M15	2	5	12.9	13.3			16.1	24.0	7.9
	HT/VHT40 Beam Forming, M0 to M7	3	10	8.4	5.5	5.1		11.4	20.0	8.6
	HT/VHT40 Beam Forming, M8 to M15	3	7	12.3	9.6	9.0		15.3	23.0	7.7
	HT/VHT40 Beam Forming, M16 to M23	3	5	11.0	11.4	10.9		15.9	24.0	8.1
	HT/VHT40 Beam Forming, M0 to M7	4	11	7.5	4.5	4.2	5.2	11.6	19.0	7.4
	HT/VHT40 Beam Forming, M8 to M15	4	8	10.3	7.8	7.0	8.4	14.6	22.0	7.4
	HT/VHT40 Beam Forming, M16 to M23	4	6	12.3	9.6	9.0	10.3	16.5	24.0	7.5
	HT/VHT40 STBC, M0 to M7	2	5	12.9	13.3			16.1	24.0	7.9
	HT/VHT40 STBC, M0 to M7	3	5	11.0	11.4	10.9		15.9	24.0	8.1
	HT/VHT40 STBC, M0 to M7	4	5	12.3	9.6	9.0	10.3	16.5	24.0	7.5
5530	Non HT80, 6 to 54 Mbps	1	5	13.4				13.4	24.0	10.6
	Non HT80, 6 to 54 Mbps	2	5	13.4	13.7			16.6	24.0	7.4
	Non HT80, 6 to 54 Mbps	3	5	12.3	12.5	12.4		17.2	24.0	6.8
	Non HT80, 6 to 54 Mbps	4	5	10.2	10.4	10.3	9.9	16.2	24.0	7.8
	VHT80, M0 to M9 1ss	1	5	15.1				15.1	24.0	8.9
	VHT80, M0 to M9 1ss	2	5	15.1	15.3			18.2	24.0	5.8
	VHT80, M0 to M9 2ss	2	5	15.1	15.3			18.2	24.0	5.8
	VHT80, M0 to M9 1ss	3	5	13.9	14.2	14.0		18.8	24.0	5.2
	VHT80, M0 to M9 2ss	3	5	13.9	14.2	14.0		18.8	24.0	5.2
	VHT80, M0 to M9 3ss	3	5	13.9	14.2	14.0		18.8	24.0	5.2
	VHT80, M0 to M9 1ss	4	5	13.9	14.2	14.0	13.5	19.9	24.0	4.1
	VHT80, M0 to M9 2ss	4	5	13.9	14.2	14.0	13.5	19.9	24.0	4.1
	VHT80, M0 to M9 3ss	4	5	13.9	14.2	14.0	13.5	19.9	24.0	4.1
	VHT80 Beam Forming, M0 to M9 1ss	2	8	13.9	14.2			17.1	22.0	4.9
	VHT80 Beam Forming, M0 to M9 2ss	2	5	15.1	15.3			18.2	24.0	5.8
	VHT80 Beam Forming, M0 to M9 1ss	3	10	10.8	11.1	11.1		15.8	20.0	4.2
	VHT80 Beam Forming, M0 to M9 2ss	3	7	13.9	14.2	14.0		18.8	23.0	4.2
	VHT80 Beam Forming, M0 to M9 3ss	3	5	13.9	14.2	14.0		18.8	24.0	5.2
	VHT80 Beam Forming, M0 to M9 1ss	4	11	11.6	10.0	9.0	9.0	16.1	19.0	2.9
	VHT80 Beam Forming, M0 to M9 2ss	4	8	12.7	13.0	13.0	12.5	18.8	22.0	3.2
VHT80 Beam Forming, M0 to M9 3ss	4	6	12.7	13.0	13.0	12.5	18.8	24.0	5.2	



	VHT80 STBC, M0 to M9 1ss	2	5	15.1	15.3			18.2	24.0	5.8
	VHT80 STBC, M0 to M9 1ss	3	5	13.9	14.2	14.0		18.8	24.0	5.2
	VHT80 STBC, M0 to M9 1ss	4	5	13.9	14.2	14.0	13.5	19.9	24.0	4.1
5570	Non HT160, 6 to 54 Mbps	1	5	13.4				13.4	24.0	10.6
	Non HT160, 6 to 54 Mbps	2	5	11.2	11.6			14.4	24.0	9.6
	Non HT160, 6 to 54 Mbps	3	5	11.2	11.6	11.0		16.0	24.0	8.0
	Non HT160, 6 to 54 Mbps	4	5	11.2	11.6	11.0	11.1	17.3	24.0	6.7
	VHT160, M0 to M9 1ss	1	5	16.0				16.0	24.0	8.0
	VHT160, M0 to M9 1ss	2	5	14.8	15.2			18.0	24.0	6.0
	VHT160, M0 to M9 2ss	2	5	14.8	15.2			18.0	24.0	6.0
	VHT160, M0 to M9 1ss	3	5	14.8	15.2	14.7		19.7	24.0	4.3
	VHT160, M0 to M9 2ss	3	5	14.8	15.2	14.7		19.7	24.0	4.3
	VHT160, M0 to M9 3ss	3	5	14.8	15.2	14.7		19.7	24.0	4.3
	VHT160, M0 to M9 1ss	4	5	14.8	15.2	14.7	14.8	20.9	24.0	3.1
	VHT160, M0 to M9 2ss	4	5	14.8	15.2	14.7	14.8	20.9	24.0	3.1
	VHT160, M0 to M9 3ss	4	5	14.8	15.2	14.7	14.8	20.9	24.0	3.1
	VHT160 Beam Forming, M0 to M9 1ss	2	8	12.7	13.2			16.0	22.0	6.0
	VHT160 Beam Forming, M0 to M9 2ss	2	5	14.8	15.2			18.0	24.0	6.0
	VHT160 Beam Forming, M0 to M9 1ss	3	10	11.0	9.8	8.5		14.7	20.0	5.3
	VHT160 Beam Forming, M0 to M9 2ss	3	7	11.8	12.3	11.7		16.7	23.0	6.3
	VHT160 Beam Forming, M0 to M9 3ss	3	5	14.8	15.2	14.7		19.7	24.0	4.3
	VHT160 Beam Forming, M0 to M9 1ss	4	11	10.1	8.6	7.6	7.7	14.6	19.0	4.4
	VHT160 Beam Forming, M0 to M9 2ss	4	8	11.0	9.8	8.5	8.6	15.6	22.0	6.4
	VHT160 Beam Forming, M0 to M9 3ss	4	6	12.7	13.2	12.7	12.8	18.9	24.0	5.1
VHT160 STBC, M0 to M9 1ss	2	5	14.8	15.2			18.0	24.0	6.0	
VHT160 STBC, M0 to M9 1ss	3	5	14.8	15.2	14.7		19.7	24.0	4.3	
VHT160 STBC, M0 to M9 1ss	4	5	14.8	15.2	14.7	14.8	20.9	24.0	3.1	
5560	Non HT20, 6 to 54 Mbps	1	5	16.2				16.2	23.6	7.4
	Non HT20, 6 to 54 Mbps	2	5	15.1	15.3			18.2	23.6	5.4
	Non HT20, 6 to 54 Mbps	3	5	11.7	12.0	12.2		16.7	23.6	6.9
	Non HT20, 6 to 54 Mbps	4	5	9.8	10.1	10.3	10.7	16.3	23.6	7.3
	Non HT20 Beam Forming, 6 to 54 Mbps	2	8	15.1	15.3			18.2	21.6	3.4
	Non HT20 Beam Forming, 6 to 54 Mbps	3	10	11.7	12.0	12.2		16.7	19.6	2.9
	Non HT20 Beam Forming, 6 to 54 Mbps	4	11	9.8	10.1	10.3	10.7	16.3	18.6	2.3
	HT/VHT20, M0 to M7	1	5	16.4				16.4	23.6	7.2
	HT/VHT20, M0 to M7	2	5	16.4	16.7			19.6	23.6	4.0
	HT/VHT20, M8 to M15	2	5	16.4	16.7			19.6	23.6	4.0
	HT/VHT20, M0 to M7	3	5	11.9	12.2	12.3		16.9	23.6	6.7
	HT/VHT20, M8 to M15	3	5	15.3	15.5	15.7		20.3	23.6	3.3



	HT/VHT20, M16 to M23	3	5	16.4	16.7	16.9		21.4	23.6	2.2
	HT/VHT20, M0 to M7	4	5	10.0	10.3	10.5	10.9	16.5	23.6	7.1
	HT/VHT20, M8 to M15	4	5	12.9	13.1	13.3	13.8	19.3	23.6	4.3
	HT/VHT20, M16 to M23	4	5	15.2	15.5	15.7	16.1	21.7	23.6	1.9
	HT/VHT20 Beam Forming, M0 to M7	2	8	16.4	16.7			19.6	21.6	2.0
	HT/VHT20 Beam Forming, M8 to M15	2	5	16.4	16.7			19.6	23.6	4.0
	HT/VHT20 Beam Forming, M0 to M7	3	10	11.9	12.2	12.3		16.9	19.6	2.7
	HT/VHT20 Beam Forming, M8 to M15	3	7	15.3	15.5	15.7		20.3	22.6	2.3
	HT/VHT20 Beam Forming, M16 to M23	3	5	16.4	16.7	16.9		21.4	23.6	2.2
	HT/VHT20 Beam Forming, M0 to M7	4	11	10.0	10.3	10.5	10.9	16.5	18.6	2.1
	HT/VHT20 Beam Forming, M8 to M15	4	8	12.9	13.1	13.3	13.8	19.3	21.6	2.3
	HT/VHT20 Beam Forming, M16 to M23	4	6	15.2	15.5	15.7	16.1	21.7	23.6	1.9
	HT/VHT20 STBC, M0 to M7	2	5	16.4	16.7			19.6	23.6	4.0
	HT/VHT20 STBC, M0 to M7	3	5	15.3	15.5	15.7		20.3	23.6	3.3
	HT/VHT20 STBC, M0 to M7	4	5	12.9	13.1	13.3	13.8	19.3	23.6	4.3
5660	Non HT20, 6 to 54 Mbps	1	5	17.1				17.1	23.6	6.5
	Non HT20, 6 to 54 Mbps	2	5	15.9	16.4			19.2	23.6	4.4
	Non HT20, 6 to 54 Mbps	3	5	11.7	12.3	12.3		16.9	23.6	6.7
	Non HT20, 6 to 54 Mbps	4	5	11.1	9.6	9.7	9.3	16.0	23.5	7.5
	Non HT20 Beam Forming, 6 to 54 Mbps	2	8	15.9	16.4			19.2	21.6	2.4
	Non HT20 Beam Forming, 6 to 54 Mbps	3	10	11.7	12.3	12.3		16.9	19.6	2.7
	Non HT20 Beam Forming, 6 to 54 Mbps	4	11	11.1	9.6	9.7	9.3	16.0	18.5	2.5
	HT/VHT20, M0 to M7	1	5	17.3				17.3	23.6	6.3
	HT/VHT20, M0 to M7	2	5	16.1	16.6			19.4	23.6	4.2
	HT/VHT20, M8 to M15	2	5	17.3	17.7			20.5	23.6	3.1
	HT/VHT20, M0 to M7	3	5	11.8	12.3	12.5		17.0	23.6	6.6
	HT/VHT20, M8 to M15	3	5	14.9	15.5	15.6		20.1	23.6	3.5
	HT/VHT20, M16 to M23	3	5	16.1	16.6	16.7		21.2	23.6	2.4
	HT/VHT20, M0 to M7	4	5	11.3	9.8	9.9	9.5	16.2	23.6	7.4
	HT/VHT20, M8 to M15	4	5	12.7	13.3	13.3	12.7	19.0	23.6	4.6
	HT/VHT20, M16 to M23	4	5	14.9	15.5	15.6	14.7	21.2	23.6	2.4
	HT/VHT20 Beam Forming, M0 to M7	2	8	16.1	16.6			19.4	21.6	2.2
	HT/VHT20 Beam Forming, M8 to M15	2	5	17.3	17.7			20.5	23.6	3.1
	HT/VHT20 Beam Forming, M0 to M7	3	10	11.8	12.3	12.5		17.0	19.6	2.6
	HT/VHT20 Beam Forming, M8 to M15	3	7	14.9	15.5	15.6		20.1	22.6	2.5
	HT/VHT20 Beam Forming, M16 to M23	3	5	16.1	16.6	16.7		21.2	23.6	2.4
	HT/VHT20 Beam Forming, M0 to M7	4	11	11.3	9.8	9.9	9.5	16.2	18.6	2.4
	HT/VHT20 Beam Forming, M8 to M15	4	8	12.7	13.3	13.3	12.7	19.0	21.6	2.6
	HT/VHT20 Beam Forming, M16 to M23	4	6	14.9	15.5	15.6	14.7	21.2	23.6	2.4
HT/VHT20 STBC, M0 to M7	2	5	17.3	17.7			20.5	23.6	3.1	



	HT/VHT20 STBC, M0 to M7	3	5	14.9	15.5	15.6		20.1	23.6	3.5
	HT/VHT20 STBC, M0 to M7	4	5	12.7	13.3	13.3	12.7	19.0	23.6	4.6
5670	Non HT40, 6 to 54 Mbps	1	5	17.7				17.7	24.0	6.3
	Non HT40, 6 to 54 Mbps	2	5	17.7	18.1			20.9	24.0	3.1
	Non HT40, 6 to 54 Mbps	3	5	14.3	14.7	15.0		19.4	24.0	4.6
	Non HT40, 6 to 54 Mbps	4	5	12.3	13.0	13.3	12.7	18.9	24.0	5.1
	HT/VHT40, M0 to M7	1	5	16.6				16.6	24.0	7.4
	HT/VHT40, M0 to M7	2	5	16.6	17.0			19.8	24.0	4.2
	HT/VHT40, M8 to M15	2	5	16.6	17.0			19.8	24.0	4.2
	HT/VHT40, M0 to M7	3	5	14.2	14.8	15.1		19.5	24.0	4.5
	HT/VHT40, M8 to M15	3	5	16.6	17.0	17.3		21.7	24.0	2.3
	HT/VHT40, M16 to M23	3	5	16.6	17.0	17.3		21.7	24.0	2.3
	HT/VHT40, M0 to M7	4	5	12.1	12.8	13.1	12.5	18.7	24.0	5.3
	HT/VHT40, M8 to M15	4	5	15.4	15.8	16.1	16.9	22.1	24.0	1.9
	HT/VHT40, M16 to M23	4	5	16.6	17.0	17.3	16.8	23.0	24.0	1.0
	HT/VHT40 Beam Forming, M0 to M7	2	8	16.6	17.0			19.8	22.0	2.2
	HT/VHT40 Beam Forming, M8 to M15	2	5	16.6	17.0			19.8	24.0	4.2
	HT/VHT40 Beam Forming, M0 to M7	3	10	14.2	14.8	15.1		19.5	20.0	0.5
	HT/VHT40 Beam Forming, M8 to M15	3	7	16.6	17.0	17.3		21.7	23.0	1.3
	HT/VHT40 Beam Forming, M16 to M23	3	5	16.6	17.0	17.3		21.7	24.0	2.3
	HT/VHT40 Beam Forming, M0 to M7	4	11	12.1	12.8	13.1	12.5	18.7	19.0	0.3
	<b>HT/VHT40 Beam Forming, M8 to M15</b>	<b>4</b>	<b>8</b>	<b>15.4</b>	<b>15.9</b>	<b>16.2</b>	<b>15.8</b>	<b>21.9</b>	<b>22.0</b>	<b>0.1</b>
	HT/VHT40 Beam Forming, M16 to M23	4	6	16.6	17.0	17.3	16.8	23.0	24.0	1.0
HT/VHT40 STBC, M0 to M7	2	5	16.6	17.0			19.8	24.0	4.2	
HT/VHT40 STBC, M0 to M7	3	5	16.6	17.0	17.3		21.7	24.0	2.3	
HT/VHT40 STBC, M0 to M7	4	5	15.4	15.8	16.1	16.9	22.1	24.0	1.9	
5690	Non HT80, 6 to 54 Mbps	1	5	15.7				15.7	24.0	8.3
	Non HT80, 6 to 54 Mbps	2	5	15.7	16.2			19.0	24.0	5.0
	Non HT80, 6 to 54 Mbps	3	5	15.7	16.2	16.1		20.8	24.0	3.2
	Non HT80, 6 to 54 Mbps	4	5	15.7	16.2	16.1	16.5	22.2	24.0	1.8
	VHT80, M0 to M9 1ss	1	5	15.9				15.9	24.0	8.1
	VHT80, M0 to M9 1ss	2	5	15.9	16.4			19.2	24.0	4.8
	VHT80, M0 to M9 2ss	2	5	15.9	16.4			19.2	24.0	4.8
	VHT80, M0 to M9 1ss	3	5	15.9	16.4	16.3		21.0	24.0	3.0
	VHT80, M0 to M9 2ss	3	5	15.9	16.4	16.3		21.0	24.0	3.0
	VHT80, M0 to M9 3ss	3	5	15.9	16.4	16.3		21.0	24.0	3.0
	VHT80, M0 to M9 1ss	4	5	15.9	16.4	16.3	16.7	22.4	24.0	1.6
	VHT80, M0 to M9 2ss	4	5	15.9	16.4	16.3	16.7	22.4	24.0	1.6
	VHT80, M0 to M9 3ss	4	5	15.9	16.4	16.3	16.7	22.4	24.0	1.6





	VHT80 Beam Forming, M0 to M9 1ss	2	8	15.9	16.4			19.2	22.0	2.8
	VHT80 Beam Forming, M0 to M9 2ss	2	5	15.9	16.4			19.2	24.0	4.8
	VHT80 Beam Forming, M0 to M9 1ss	3	10	14.8	15.3	15.2		19.9	20.0	0.1
	VHT80 Beam Forming, M0 to M9 2ss	3	7	15.9	16.4	16.3		21.0	23.0	2.0
	VHT80 Beam Forming, M0 to M9 3ss	3	5	15.9	16.4	16.3		21.0	24.0	3.0
	VHT80 Beam Forming, M0 to M9 1ss	4	11	11.6	12.1	12.1	12.5	18.1	19.0	0.9
	VHT80 Beam Forming, M0 to M9 2ss	4	8	14.8	15.3	15.1	16.8	21.6	22.0	0.4
	VHT80 Beam Forming, M0 to M9 3ss	4	6	15.9	16.4	16.3	16.7	22.4	24.0	1.6
	VHT80 STBC, M0 to M9 1ss	2	5	15.9	16.4			19.2	24.0	4.8
	VHT80 STBC, M0 to M9 1ss	3	5	15.9	16.4	16.3		21.0	24.0	3.0
	VHT80 STBC, M0 to M9 1ss	4	5	15.9	16.4	16.3	16.7	22.4	24.0	1.6
5700	Non HT20, 6 to 54 Mbps	1	5	15.4				15.4	23.6	8.2
	Non HT20, 6 to 54 Mbps	2	5	15.4	15.8			18.6	23.6	5.0
	Non HT20, 6 to 54 Mbps	3	5	12.0	12.5	12.1		17.0	23.6	6.6
	Non HT20, 6 to 54 Mbps	4	5	10.7	10.7	9.6	8.8	16.0	23.6	7.6
	Non HT20 Beam Forming, 6 to 54 Mbps	2	8	15.4	15.8			18.6	21.6	3.0
	Non HT20 Beam Forming, 6 to 54 Mbps	3	10	12.0	12.5	12.1		17.0	19.6	2.6
	Non HT20 Beam Forming, 6 to 54 Mbps	4	11	10.7	10.7	9.6	8.8	16.0	18.6	2.6
	HT/VHT20, M0 to M7	1	5	15.6				15.6	23.6	8.0
	HT/VHT20, M0 to M7	2	5	15.6	16.0			18.8	23.6	4.8
	HT/VHT20, M8 to M15	2	5	15.6	16.0			18.8	23.6	4.8
	HT/VHT20, M0 to M7	3	5	12.2	12.7	12.4		17.2	23.6	6.4
	HT/VHT20, M8 to M15	3	5	15.6	16.0	15.7		20.5	23.6	3.1
	HT/VHT20, M16 to M23	3	5	15.6	16.0	15.7		20.5	23.6	3.1
	HT/VHT20, M0 to M7	4	5	10.9	11.0	9.8	9.0	16.3	23.6	7.3
	HT/VHT20, M8 to M15	4	5	12.2	12.7	12.4	13.8	18.8	23.6	4.8
	HT/VHT20, M16 to M23	4	5	14.5	14.9	14.6	17.3	21.5	23.6	2.1
	HT/VHT20 Beam Forming, M0 to M7	2	8	15.6	16.0			18.8	21.6	2.8
	HT/VHT20 Beam Forming, M8 to M15	2	5	15.6	16.0			18.8	23.6	4.8
	HT/VHT20 Beam Forming, M0 to M7	3	10	12.2	12.7	12.4		17.2	19.6	2.4
	HT/VHT20 Beam Forming, M8 to M15	3	7	15.6	16.0	15.7		20.5	22.6	2.1
	HT/VHT20 Beam Forming, M16 to M23	3	5	15.6	16.0	15.7		20.5	23.6	3.1
	HT/VHT20 Beam Forming, M0 to M7	4	11	10.9	11.0	9.8	9.0	16.3	18.6	2.3
	HT/VHT20 Beam Forming, M8 to M15	4	8	12.2	12.7	12.4	13.8	18.8	21.6	2.8
	HT/VHT20 Beam Forming, M16 to M23	4	6	14.5	14.9	14.6	17.3	21.5	23.6	2.1
	HT/VHT20 STBC, M0 to M7	2	5	15.6	16.0			18.8	23.6	4.8
	HT/VHT20 STBC, M0 to M7	3	5	15.6	16.0	15.7		20.5	23.6	3.1
HT/VHT20 STBC, M0 to M7	4	5	12.2	12.7	12.4	13.8	18.8	23.6	4.8	



5710	Non HT40, 6 to 54 Mbps	1	5	16.3				16.3	24.0	7.7
	Non HT40, 6 to 54 Mbps	2	5	16.3	16.7			19.5	24.0	4.5
	Non HT40, 6 to 54 Mbps	3	5	15.2	15.7	15.1		20.1	24.0	3.9
	Non HT40, 6 to 54 Mbps	4	5	11.8	12.4	11.9	14.8	18.9	24.0	5.1
	HT/VHT40, M0 to M7	1	5	15.2				15.2	24.0	8.8
	HT/VHT40, M0 to M7	2	5	15.2	15.7			18.5	24.0	5.5
	HT/VHT40, M8 to M15	2	5	15.2	15.7			18.5	24.0	5.5
	HT/VHT40, M0 to M7	3	5	15.2	15.7	15.1		20.1	24.0	3.9
	HT/VHT40, M8 to M15	3	5	15.2	15.7	15.1		20.1	24.0	3.9
	HT/VHT40, M16 to M23	3	5	15.2	15.7	15.1		20.1	24.0	3.9
	HT/VHT40, M0 to M7	4	5	12.9	13.5	13.0	14.8	19.6	24.0	4.4
	HT/VHT40, M8 to M15	4	5	15.2	15.7	15.1	17.0	21.8	24.0	2.2
	HT/VHT40, M16 to M23	4	5	15.2	15.7	15.1	17.0	21.8	24.0	2.2
	HT/VHT40 Beam Forming, M0 to M7	2	8	15.2	15.7			18.5	22.0	3.5
	HT/VHT40 Beam Forming, M8 to M15	2	5	15.2	15.7			18.5	24.0	5.5
	HT/VHT40 Beam Forming, M0 to M7	3	10	14.1	14.6	14.0		19.0	20.0	1.0
	HT/VHT40 Beam Forming, M8 to M15	3	7	15.2	15.7	15.1		20.1	23.0	2.9
	HT/VHT40 Beam Forming, M16 to M23	3	5	15.2	15.7	15.1		20.1	24.0	3.9
	HT/VHT40 Beam Forming, M0 to M7	4	11	11.7	12.5	12.0	13.6	18.5	19.0	0.5
	HT/VHT40 Beam Forming, M8 to M15	4	8	14.1	14.5	14.0	17.1	21.1	22.0	0.9
HT/VHT40 Beam Forming, M16 to M23	4	6	15.2	15.7	15.1	17.0	21.8	24.0	2.2	
HT/VHT40 STBC, M0 to M7	2	5	15.2	15.7			18.5	24.0	5.5	
HT/VHT40 STBC, M0 to M7	3	5	15.2	15.7	15.1		20.1	24.0	3.9	
HT/VHT40 STBC, M0 to M7	4	5	15.2	15.7	15.1	17.0	21.8	24.0	2.2	
5720	Non HT20, 6 to 54 Mbps	1	5	15.2				15.2	23.6	8.4
	Non HT20, 6 to 54 Mbps	2	5	15.2	15.8			18.5	23.6	5.1
	Non HT20, 6 to 54 Mbps	3	5	11.8	12.4	11.4		16.7	23.6	6.9
	Non HT20, 6 to 54 Mbps	4	5	10.0	10.6	9.6	11.7	16.6	23.6	7.0
	Non HT20 Beam Forming, 6 to 54 Mbps	2	8	15.2	15.8			18.5	21.6	3.1
	Non HT20 Beam Forming, 6 to 54 Mbps	3	10	11.8	12.4	11.4		16.7	19.6	2.9
	Non HT20 Beam Forming, 6 to 54 Mbps	4	11	10.0	10.6	9.6	11.7	16.6	18.6	2.0
	HT/VHT20, M0 to M7	1	5	15.3				15.3	23.6	8.3
	HT/VHT20, M0 to M7	2	5	15.3	16.0			18.7	23.6	4.9
	HT/VHT20, M8 to M15	2	5	15.3	16.0			18.7	23.6	4.9
	HT/VHT20, M0 to M7	3	5	12.0	12.6	11.5		16.8	23.6	6.8
	HT/VHT20, M8 to M15	3	5	15.3	16.0	15.0		20.2	23.6	3.4
	HT/VHT20, M16 to M23	3	5	15.3	16.0	15.0		20.2	23.6	3.4
	HT/VHT20, M0 to M7	4	5	10.1	10.7	9.7	11.9	16.7	23.6	6.9
	HT/VHT20, M8 to M15	4	5	13.1	13.7	12.8	14.9	19.7	23.6	3.9



HT/VHT20, M16 to M23	4	5	14.2	14.8	13.9	17.3	21.3	23.6	2.3
HT/VHT20 Beam Forming, M0 to M7	2	8	15.3	16.0			18.7	21.6	2.9
HT/VHT20 Beam Forming, M8 to M15	2	5	15.3	16.0			18.7	23.6	4.9
HT/VHT20 Beam Forming, M0 to M7	3	10	12.0	12.6	11.5		16.8	19.6	2.8
HT/VHT20 Beam Forming, M8 to M15	3	7	15.3	16.0	15.0		20.2	22.6	2.4
HT/VHT20 Beam Forming, M16 to M23	3	5	15.3	16.0	15.0		20.2	23.6	3.4
HT/VHT20 Beam Forming, M0 to M7	4	11	10.1	10.7	9.7	11.9	16.7	18.6	1.9
HT/VHT20 Beam Forming, M8 to M15	4	8	13.1	13.7	12.8	14.9	19.7	21.6	1.9
HT/VHT20 Beam Forming, M16 to M23	4	6	14.2	14.8	13.9	17.3	21.3	23.6	2.3
HT/VHT20 STBC, M0 to M7	2	5	15.3	16.0			18.7	23.6	4.9
HT/VHT20 STBC, M0 to M7	3	5	15.3	16.0	15.0		20.2	23.6	3.4
HT/VHT20 STBC, M0 to M7	4	5	13.1	13.7	12.8	14.9	19.7	23.6	3.9



Frequency (MHz)	Mode	Tx Paths	Correlated Antenna Gain (dBi)	Tx 1 PSD (dBm/MHz)	Tx 2 PSD (dBm/MHz)	Tx 3 PSD (dBm/MHz)	Tx 4 PSD (dBm/MHz)	Total PSD (dBm/MHz)	Limit (dBm/MHz)	Margin (dB)
5500	Non HT20, 6 to 54 Mbps	1	5	5.5				5.5	11.0	5.5
	Non HT20, 6 to 54 Mbps	2	8	5.6	5.7			8.7	9.0	0.3
	Non HT20, 6 to 54 Mbps	3	10	2.2	2.2	0.9		6.6	7.0	0.4
	Non HT20, 6 to 54 Mbps	4	11	1.4	-2.2	-2.4	-0.8	5.3	6.0	0.7
	Non HT20 Beam Forming, 6 to 54 Mbps	2	8	4.1	4.3			7.2	9.0	1.8
	Non HT20 Beam Forming, 6 to 54 Mbps	3	10	1.4	1.4	0.1		5.8	7.0	1.2
	Non HT20 Beam Forming, 6 to 54 Mbps	4	11	0.5	-3.2	-3.2	-1.8	4.4	6.0	1.6
	HT/VHT20, M0 to M7	1	5	7.1				7.1	11.0	3.9
	HT/VHT20, M0 to M7	2	8	5.6	5.8			8.7	9.0	0.3
	HT/VHT20, M8 to M15	2	5	7.1	7.5			10.3	11.0	0.7
	HT/VHT20, M0 to M7	3	10	2.0	2.9	1.0		6.8	7.0	0.2
	HT/VHT20, M8 to M15	3	7	4.0	4.5	3.4		8.8	10.0	1.2
	HT/VHT20, M16 to M23	3	5	5.6	5.8	4.3		10.1	11.0	0.9
	HT/VHT20, M0 to M7	4	11	1.4	-2.6	-2.2	-0.8	5.3	6.0	0.7
	HT/VHT20, M8 to M15	4	8	2.8	3.2	2.3	1.3	8.5	9.0	0.5
	HT/VHT20, M16 to M23	4	6	4.0	4.5	3.4	2.5	9.7	11.0	1.3
	HT/VHT20 Beam Forming, M0 to M7	2	8	4.0	4.5			7.3	9.0	1.7
	HT/VHT20 Beam Forming, M8 to M15	2	5	7.1	7.5			10.3	11.0	0.7
	HT/VHT20 Beam Forming, M0 to M7	3	10	1.2	1.6	-0.1		5.7	7.0	1.3
	HT/VHT20 Beam Forming, M8 to M15	3	7	4.0	4.5	3.4		8.8	10.0	1.2
	HT/VHT20 Beam Forming, M16 to M23	3	5	5.6	5.8	4.3		10.1	11.0	0.9
	HT/VHT20 Beam Forming, M0 to M7	4	11	0.3	-3.6	-3.4	-1.7	4.2	6.0	1.8
	HT/VHT20 Beam Forming, M8 to M15	4	8	2.0	2.9	1.0	0.8	7.8	9.0	1.2
	HT/VHT20 Beam Forming, M16 to M23	4	6	4.0	4.5	3.4	2.5	9.7	11.0	1.3
	HT/VHT20 STBC, M0 to M7	2	5	7.1	7.5			10.3	11.0	0.7
	HT/VHT20 STBC, M0 to M7	3	7	4.0	4.5	3.4		8.8	10.0	1.2
HT/VHT20 STBC, M0 to M7	4	8	2.8	3.2	2.3	1.3	8.5	9.0	0.5	
5510	Non HT40, 6 to 54 Mbps	1	5	-0.4				-0.4	11.0	11.4
	Non HT40, 6 to 54 Mbps	2	8	-1.6	-4.6			0.2	9.0	8.8
	Non HT40, 6 to 54 Mbps	3	10	-3.3	-6.7	-7.1		-0.6	7.0	7.6
	Non HT40, 6 to 54 Mbps	4	11	-3.3	-6.7	-7.1	-5.6	0.6	6.0	5.4
	HT/VHT40, M0 to M7	1	5	3.6				3.6	11.0	7.4
	HT/VHT40, M0 to M7	2	8	0.0	0.1			3.1	9.0	5.9



HT/VHT40, M8 to M15	2	5	0.0	0.1				3.1	11.0	7.9
HT/VHT40, M0 to M7	3	10	-2.1	-1.7	-3.0			2.5	7.0	4.5
HT/VHT40, M8 to M15	3	7	-2.1	-1.7	-3.0			2.5	10.0	7.5
HT/VHT40, M16 to M23	3	5	-2.1	-1.7	-3.0			2.5	11.0	8.5
HT/VHT40, M0 to M7	4	11	-0.9	-4.2	-4.6	-3.2		3.1	6.0	2.9
HT/VHT40, M8 to M15	4	8	-0.9	-4.2	-4.6	-3.2		3.1	9.0	5.9
HT/VHT40, M16 to M23	4	6	-0.9	-4.2	-4.6	-3.2		3.1	11.0	7.9
HT/VHT40 Beam Forming, M0 to M7	2	8	-0.9	-4.2				0.8	9.0	8.2
HT/VHT40 Beam Forming, M8 to M15	2	5	0.0	0.1				3.1	11.0	7.9
HT/VHT40 Beam Forming, M0 to M7	3	10	-4.9	-8.2	-8.6			-2.1	7.0	9.1
HT/VHT40 Beam Forming, M8 to M15	3	7	-0.9	-4.2	-4.6			1.9	10.0	8.1
HT/VHT40 Beam Forming, M16 to M23	3	5	-2.1	-1.7	-3.0			2.5	11.0	8.5
HT/VHT40 Beam Forming, M0 to M7	4	11	-6.0	-9.0	-9.5	-8.1	-1.9	6.0	6.0	7.9
HT/VHT40 Beam Forming, M8 to M15	4	8	-3.0	-6.2	-7.0	-4.9	1.0	9.0	9.0	8.0
HT/VHT40 Beam Forming, M16 to M23	4	6	-0.9	-4.2	-4.6	-3.2	3.1	11.0	11.0	7.9
HT/VHT40 STBC, M0 to M7	2	5	0.0	0.1				3.1	11.0	7.9
HT/VHT40 STBC, M0 to M7	3	7	-2.1	-1.7	-3.0			2.5	10.0	7.5
HT/VHT40 STBC, M0 to M7	4	8	-0.9	-4.2	-4.6	-3.2	3.1	9.0	9.0	5.9

Non HT80, 6 to 54 Mbps	1	5	-2.7					-2.7	11.0	13.7
Non HT80, 6 to 54 Mbps	2	8	-2.7	-2.9				0.2	9.0	8.8
Non HT80, 6 to 54 Mbps	3	10	-4.0	-3.6	-4.4			0.8	7.0	6.2
Non HT80, 6 to 54 Mbps	4	11	-6.1	-5.4	-6.4	-6.1	0.0	6.0	6.0	6.0
VHT80, M0 to M9 1ss	1	5	-1.8					-1.8	11.0	12.8
VHT80, M0 to M9 1ss	2	8	-1.8	-1.4				1.4	9.0	7.6
VHT80, M0 to M9 2ss	2	5	-1.8	-1.4				1.4	11.0	9.6
VHT80, M0 to M9 1ss	3	10	-2.8	-2.6	-2.9			2.0	7.0	5.0
VHT80, M0 to M9 2ss	3	7	-2.8	-2.6	-2.9			2.0	10.0	8.0
VHT80, M0 to M9 3ss	3	5	-2.8	-2.6	-2.9			2.0	11.0	9.0
VHT80, M0 to M9 1ss	4	11	-2.8	-2.6	-2.9	-2.6	3.3	6.0	6.0	2.7
VHT80, M0 to M9 2ss	4	8	-2.8	-2.6	-2.9	-2.6	3.3	9.0	9.0	5.7
VHT80, M0 to M9 3ss	4	6	-2.8	-2.6	-2.9	-2.6	3.3	11.0	11.0	7.7
VHT80 Beam Forming, M0 to M9 1ss	2	8	-2.8	-2.6				0.3	9.0	8.7
VHT80 Beam Forming, M0 to M9 2ss	2	5	-1.8	-1.4				1.4	11.0	9.6
VHT80 Beam Forming, M0 to M9 1ss	3	10	-5.3	-5.7	-6.1			-0.9	7.0	7.9
VHT80 Beam Forming, M0 to M9 2ss	3	7	-2.8	-2.6	-2.9			2.0	10.0	8.0
VHT80 Beam Forming, M0 to M9 3ss	3	5	-2.8	-2.6	-2.9			2.0	11.0	9.0
VHT80 Beam Forming, M0 to M9 1ss	4	11	-4.4	-6.5	-8.4	-7.3	-0.4	6.0	6.0	6.4
VHT80 Beam Forming, M0 to M9 2ss	4	8	-4.2	-3.4	-4.2	-3.9	2.1	9.0	9.0	6.9
VHT80 Beam Forming, M0 to M9 3ss	4	6	-4.2	-3.4	-4.2	-3.9	2.1	11.0	11.0	8.9
VHT80 STBC, M0 to M9 1ss	2	5	-1.8	-1.4				1.4	11.0	9.6



	VHT80 STBC, M0 to M9 1ss	3	5	-2.8	-2.6	-2.9		2.0	11.0	9.0
	VHT80 STBC, M0 to M9 1ss	4	5	-2.8	-2.6	-2.9	-2.6	3.3	11.0	7.7
5570	Non HT160, 6 to 54 Mbps	1	5	-5.3				-5.3	11.0	16.3
	Non HT160, 6 to 54 Mbps	2	8	-7.4	-6.7			-4.0	9.0	13.0
	Non HT160, 6 to 54 Mbps	3	10	-7.4	-6.7	-8.2		-2.6	7.0	9.6
	Non HT160, 6 to 54 Mbps	4	11	-7.4	-6.7	-8.2	-7.9	-1.5	6.0	7.5
	VHT160, M0 to M9 1ss	1	5	-2.6				-2.6	11.0	13.6
	VHT160, M0 to M9 1ss	2	8	-4.1	-3.7			-0.9	9.0	9.9
	VHT160, M0 to M9 2ss	2	5	-4.1	-3.7			-0.9	11.0	11.9
	VHT160, M0 to M9 1ss	3	10	-4.1	-3.7	-4.9		0.6	7.0	6.4
	VHT160, M0 to M9 2ss	3	7	-4.1	-3.7	-4.9		0.6	10.0	9.4
	VHT160, M0 to M9 3ss	3	5	-4.1	-3.7	-4.9		0.6	11.0	10.4
	VHT160, M0 to M9 1ss	4	11	-4.1	-3.7	-4.9	-4.4	1.8	6.0	4.2
	VHT160, M0 to M9 2ss	4	8	-4.1	-3.7	-4.9	-4.4	1.8	9.0	7.2
	VHT160, M0 to M9 3ss	4	6	-4.1	-3.7	-4.9	-4.4	1.8	11.0	9.2
	VHT160 Beam Forming, M0 to M9 1ss	2	8	-6.5	-6.0			-3.2	9.0	12.2
	VHT160 Beam Forming, M0 to M9 2ss	2	5	-4.1	-3.7			-0.9	11.0	11.9
	VHT160 Beam Forming, M0 to M9 1ss	3	10	-7.7	-10.4	-11.3		-4.7	7.0	11.7
	VHT160 Beam Forming, M0 to M9 2ss	3	7	-7.1	-6.7	-8.0		-2.5	10.0	12.5
	VHT160 Beam Forming, M0 to M9 3ss	3	5	-4.1	-3.7	-4.9		0.6	11.0	10.4
	VHT160 Beam Forming, M0 to M9 1ss	4	11	-8.6	-11.1	-12.6	-11.3	-4.6	6.0	10.6
	VHT160 Beam Forming, M0 to M9 2ss	4	8	-7.7	-10.4	-11.3	-10.2	-3.7	9.0	12.7
	VHT160 Beam Forming, M0 to M9 3ss	4	6	-6.5	-6.0	-6.9	-6.4	-0.4	11.0	11.4
VHT160 STBC, M0 to M9 1ss	2	5	-4.1	-3.7			-0.9	11.0	11.9	
VHT160 STBC, M0 to M9 1ss	3	5	-4.1	-3.7	-4.9		0.6	11.0	10.4	
VHT160 STBC, M0 to M9 1ss	4	5	-4.1	-3.7	-4.9	-4.4	1.8	11.0	9.2	
5560	Non HT20, 6 to 54 Mbps	1	5	5.8				5.8	11.0	5.2
	Non HT20, 6 to 54 Mbps	2	8	4.8	4.8			7.8	9.0	1.2
	Non HT20, 6 to 54 Mbps	3	10	1.0	1.6	1.4		6.1	7.0	0.9
	Non HT20, 6 to 54 Mbps	4	11	-0.8	-0.4	-0.2	0.1	5.7	6.0	0.3
	Non HT20 Beam Forming, 6 to 54 Mbps	2	8	4.8	4.8			7.8	9.0	1.2
	Non HT20 Beam Forming, 6 to 54 Mbps	3	10	1.0	1.6	1.4		6.1	7.0	0.9
	Non HT20 Beam Forming, 6 to 54 Mbps	4	11	-0.8	-0.4	-0.2	0.1	5.7	6.0	0.3
	HT/VHT20, M0 to M7	1	5	5.6				5.6	11.0	5.4
	HT/VHT20, M0 to M7	2	8	5.6	6.0			8.8	9.0	0.2
	HT/VHT20, M8 to M15	2	5	5.6	6.0			8.8	11.0	2.2
	HT/VHT20, M0 to M7	3	10	1.2	1.6	1.6		6.2	7.0	0.8
	HT/VHT20, M8 to M15	3	7	5.0	4.8	4.8		9.6	10.0	0.4
	HT/VHT20, M16 to M23	3	5	5.6	6.0	6.1		10.7	11.0	0.3



	HT/VHT20, M0 to M7	4	11	-0.7	-0.3	-0.5	0.1	5.7	6.0	0.3	
	HT/VHT20, M8 to M15	4	8	2.7	2.4	2.5	3.0	8.7	9.0	0.3	
	<b>HT/VHT20, M16 to M23</b>	<b>4</b>	<b>6</b>	<b>4.3</b>	<b>5.0</b>	<b>5.0</b>	<b>5.4</b>	<b>11.0</b>	<b>11.0</b>	<b>0.0</b>	
	HT/VHT20 Beam Forming, M0 to M7	2	8	5.6	6.0			8.8	9.0	0.2	
	HT/VHT20 Beam Forming, M8 to M15	2	5	5.6	6.0			8.8	11.0	2.2	
	HT/VHT20 Beam Forming, M0 to M7	3	10	1.2	1.6	1.6		6.2	7.0	0.8	
	HT/VHT20 Beam Forming, M8 to M15	3	7	5.0	4.8	4.8		9.6	10.0	0.4	
	HT/VHT20 Beam Forming, M16 to M23	3	5	5.6	6.0	6.1		10.7	11.0	0.3	
	HT/VHT20 Beam Forming, M0 to M7	4	11	-0.7	-0.3	-0.5	0.1	5.7	6.0	0.3	
	HT/VHT20 Beam Forming, M8 to M15	4	8	2.7	2.4	2.5	3.0	8.7	9.0	0.3	
	HT/VHT20 Beam Forming, M16 to M23	4	6	4.3	5.0	5.0	5.4	11.0	11.0	0.0	
	HT/VHT20 STBC, M0 to M7	2	5	5.6	6.0			8.8	11.0	2.2	
	HT/VHT20 STBC, M0 to M7	3	7	5.0	4.8	4.8		9.6	10.0	0.4	
	HT/VHT20 STBC, M0 to M7	4	8	2.7	2.4	2.5	3.0	8.7	9.0	0.3	
5660	Non HT20, 6 to 54 Mbps	1	5	6.8				6.8	11.0	4.2	
	Non HT20, 6 to 54 Mbps	2	8	5.4	5.8			8.6	9.0	0.4	
	Non HT20, 6 to 54 Mbps	3	10	1.0	1.9	2.0		6.4	7.0	0.6	
	Non HT20, 6 to 54 Mbps	4	11	0.6	-0.8	-0.8	-1.2	5.5	6.0	0.5	
	Non HT20 Beam Forming, 6 to 54 Mbps	2	8	5.4	5.8			8.6	9.0	0.4	
	Non HT20 Beam Forming, 6 to 54 Mbps	3	10	1.0	1.9	2.0		6.4	7.0	0.6	
	Non HT20 Beam Forming, 6 to 54 Mbps	4	11	0.6	-0.8	-0.8	-1.2	5.5	6.0	0.5	
	HT/VHT20, M0 to M7	1	5	6.5				6.5	11.0	4.5	
	HT/VHT20, M0 to M7	2	8	5.3	5.8			8.6	9.0	0.4	
	HT/VHT20, M8 to M15	2	5	6.5	7.0			9.8	11.0	1.2	
	HT/VHT20, M0 to M7	3	10	1.5	1.8	1.7		6.4	7.0	0.6	
	HT/VHT20, M8 to M15	3	7	4.3	4.7	4.5		9.3	10.0	0.7	
	HT/VHT20, M16 to M23	3	5	5.3	5.8	5.8		10.4	11.0	0.6	
	HT/VHT20, M0 to M7	4	11	0.4	-0.7	-1.0	-1.2	5.4	6.0	0.6	
	HT/VHT20, M8 to M15	4	8	1.9	2.8	2.8	1.9	8.4	9.0	0.6	
	HT/VHT20, M16 to M23	4	6	4.3	4.7	4.5	3.9	10.4	11.0	0.6	
	HT/VHT20 Beam Forming, M0 to M7	2	8	5.3	5.8			8.6	9.0	0.4	
	HT/VHT20 Beam Forming, M8 to M15	2	5	6.5	7.0			9.8	11.0	1.2	
	HT/VHT20 Beam Forming, M0 to M7	3	10	1.5	1.8	1.7		6.4	7.0	0.6	
	HT/VHT20 Beam Forming, M8 to M15	3	7	4.3	4.7	4.5		9.3	10.0	0.7	
	HT/VHT20 Beam Forming, M16 to M23	3	5	5.3	5.8	5.8		10.4	11.0	0.6	
	HT/VHT20 Beam Forming, M0 to M7	4	11	0.4	-0.7	-1.0	-1.2	5.4	6.0	0.6	
HT/VHT20 Beam Forming, M8 to M15	4	8	1.9	2.8	2.8	1.9	8.4	9.0	0.6		
HT/VHT20 Beam Forming, M16 to M23	4	6	4.3	4.7	4.5	3.9	10.4	11.0	0.6		
HT/VHT20 STBC, M0 to M7	2	5	6.5	7.0			9.8	11.0	1.2		
HT/VHT20 STBC, M0 to M7	3	7	4.3	4.7	4.5		9.3	10.0	0.7		



	HT/VHT20 STBC, M0 to M7	4	8	1.9	2.8	2.8	1.9	8.4	9.0	0.6
5670	Non HT40, 6 to 54 Mbps	1	5	4.8				4.8	11.0	6.2
	Non HT40, 6 to 54 Mbps	2	8	4.8	4.9			7.9	9.0	1.1
	Non HT40, 6 to 54 Mbps	3	10	1.3	1.7	1.9		6.4	7.0	0.6
	Non HT40, 6 to 54 Mbps	4	11	-0.6	0.0	-0.1	-0.7	5.7	6.0	0.3
	HT/VHT40, M0 to M7	1	5	3.7				3.7	11.0	7.3
	HT/VHT40, M0 to M7	2	8	3.7	3.9			6.8	9.0	2.2
	HT/VHT40, M8 to M15	2	5	3.7	3.9			6.8	11.0	4.2
	HT/VHT40, M0 to M7	3	10	1.0	1.5	1.7		6.2	7.0	0.8
	HT/VHT40, M8 to M15	3	7	3.7	3.9	3.9		8.6	10.0	1.4
	HT/VHT40, M16 to M23	3	5	3.7	3.9	3.9		8.6	11.0	2.4
	HT/VHT40, M0 to M7	4	11	-1.3	-0.6	-0.4	-1.3	5.1	6.0	0.9
	HT/VHT40, M8 to M15	4	8	1.9	2.7	2.5	3.0	8.6	9.0	0.4
	HT/VHT40, M16 to M23	4	6	3.7	3.9	3.9	3.3	9.7	11.0	1.3
	HT/VHT40 Beam Forming, M0 to M7	2	8	3.7	3.9			6.8	9.0	2.2
	HT/VHT40 Beam Forming, M8 to M15	2	5	3.7	3.9			6.8	11.0	4.2
	HT/VHT40 Beam Forming, M0 to M7	3	10	1.0	1.5	1.7		6.2	7.0	0.8
	HT/VHT40 Beam Forming, M8 to M15	3	7	3.7	3.9	3.9		8.6	10.0	1.4
	HT/VHT40 Beam Forming, M16 to M23	3	5	3.7	3.9	3.9		8.6	11.0	2.4
	HT/VHT40 Beam Forming, M0 to M7	4	11	-1.3	-0.6	-0.4	-1.3	5.1	6.0	0.9
	HT/VHT40 Beam Forming, M8 to M15	4	8	2.3	2.5	2.6	2.2	8.4	9.0	0.6
HT/VHT40 Beam Forming, M16 to M23	4	6	3.7	3.9	3.9	3.3	9.7	11.0	1.3	
HT/VHT40 STBC, M0 to M7	2	5	3.7	3.9			6.8	11.0	4.2	
HT/VHT40 STBC, M0 to M7	3	7	3.7	3.9	3.9		8.6	10.0	1.4	
HT/VHT40 STBC, M0 to M7	4	8	1.9	2.7	2.5	3.0	8.6	9.0	0.4	
5690	Non HT80, 6 to 54 Mbps	1	5	-0.8				-0.8	11.0	11.8
	Non HT80, 6 to 54 Mbps	2	8	-0.8	-0.1			2.6	9.0	6.4
	Non HT80, 6 to 54 Mbps	3	10	-0.8	-0.1	0.2		4.6	7.0	2.4
	Non HT80, 6 to 54 Mbps	4	11	-0.8	-0.1	0.2	-0.3	5.8	6.0	0.2
	VHT80, M0 to M9 1ss	1	5	-0.5				-0.5	11.0	11.5
	VHT80, M0 to M9 1ss	2	8	-0.5	-0.3			2.6	9.0	6.4
	VHT80, M0 to M9 2ss	2	5	-0.5	-0.3			2.6	11.0	8.4
	VHT80, M0 to M9 1ss	3	10	-0.5	-0.3	-0.3		4.4	7.0	2.6
	VHT80, M0 to M9 2ss	3	7	-0.5	-0.3	-0.3		4.4	10.0	5.6
	VHT80, M0 to M9 3ss	3	5	-0.5	-0.3	-0.3		4.4	11.0	6.6
	VHT80, M0 to M9 1ss	4	11	-0.5	-0.3	-0.3	-0.7	5.6	6.0	0.4
	VHT80, M0 to M9 2ss	4	8	-0.5	-0.3	-0.3	-0.7	5.6	9.0	3.4
	VHT80, M0 to M9 3ss	4	6	-0.5	-0.3	-0.3	-0.7	5.6	11.0	5.4
	VHT80 Beam Forming, M0 to M9 1ss	2	8	-0.5	-0.3			2.6	9.0	6.4





	VHT80 Beam Forming, M0 to M9 2ss	2	5	-0.5	-0.3			2.6	11.0	8.4
	VHT80 Beam Forming, M0 to M9 1ss	3	10	-1.3	-1.4	-1.2		3.5	7.0	3.5
	VHT80 Beam Forming, M0 to M9 2ss	3	7	-0.5	-0.3	-0.3		4.4	10.0	5.6
	VHT80 Beam Forming, M0 to M9 3ss	3	5	-0.5	-0.3	-0.3		4.4	11.0	6.6
	VHT80 Beam Forming, M0 to M9 1ss	4	11	-5.1	-4.6	-4.2	-4.9	1.3	6.0	4.7
	VHT80 Beam Forming, M0 to M9 2ss	4	8	-1.8	-1.5	-1.4	-0.8	4.7	9.0	4.3
	VHT80 Beam Forming, M0 to M9 3ss	4	6	-0.5	-0.3	-0.3	-0.7	5.6	11.0	5.4
	VHT80 STBC, M0 to M9 1ss	2	5	-0.5	-0.3			2.6	11.0	8.4
	VHT80 STBC, M0 to M9 1ss	3	5	-0.5	-0.3	-0.3		4.4	11.0	6.6
	VHT80 STBC, M0 to M9 1ss	4	5	-0.5	-0.3	-0.3	-0.7	5.6	11.0	5.4
5700	Non HT20, 6 to 54 Mbps	1	5	4.7				4.7	11.0	6.3
	Non HT20, 6 to 54 Mbps	2	8	4.7	5.1			7.9	9.0	1.1
	Non HT20, 6 to 54 Mbps	3	10	1.3	1.9	1.6		6.4	7.0	0.6
	Non HT20, 6 to 54 Mbps	4	11	0.4	0.1	-0.9	-1.7	5.6	6.0	0.4
	Non HT20 Beam Forming, 6 to 54 Mbps	2	8	4.7	5.1			7.9	9.0	1.1
	Non HT20 Beam Forming, 6 to 54 Mbps	3	10	1.3	1.9	1.6		6.4	7.0	0.6
	Non HT20 Beam Forming, 6 to 54 Mbps	4	11	0.4	0.1	-0.9	-1.7	5.6	6.0	0.4
	HT/VHT20, M0 to M7	1	5	4.6				4.6	11.0	6.4
	HT/VHT20, M0 to M7	2	8	4.6	5.1			7.9	9.0	1.1
	HT/VHT20, M8 to M15	2	5	4.6	5.1			7.9	11.0	3.1
	HT/VHT20, M0 to M7	3	10	1.5	1.7	1.9		6.5	7.0	0.5
	HT/VHT20, M8 to M15	3	7	4.6	5.1	5.3		9.8	10.0	0.2
	HT/VHT20, M16 to M23	3	5	4.6	5.1	5.3		9.8	11.0	1.2
	HT/VHT20, M0 to M7	4	11	0.1	0.1	-0.9	-1.6	5.5	6.0	0.5
	HT/VHT20, M8 to M15	4	8	1.5	1.7	1.9	3.0	8.1	9.0	0.9
	HT/VHT20, M16 to M23	4	6	3.7	4.0	4.0	6.3	10.7	11.0	0.3
	HT/VHT20 Beam Forming, M0 to M7	2	8	4.6	5.1			7.9	9.0	1.1
	HT/VHT20 Beam Forming, M8 to M15	2	5	4.6	5.1			7.9	11.0	3.1
	HT/VHT20 Beam Forming, M0 to M7	3	10	1.5	1.7	1.9		6.5	7.0	0.5
	HT/VHT20 Beam Forming, M8 to M15	3	7	4.6	5.1	5.3		9.8	10.0	0.2
	HT/VHT20 Beam Forming, M16 to M23	3	5	4.6	5.1	5.3		9.8	11.0	1.2
	HT/VHT20 Beam Forming, M0 to M7	4	11	0.1	0.1	-0.9	-1.6	5.5	6.0	0.5
	HT/VHT20 Beam Forming, M8 to M15	4	8	1.5	1.7	1.9	3.0	8.1	9.0	0.9
	HT/VHT20 Beam Forming, M16 to M23	4	6	3.7	4.0	4.0	6.3	10.7	11.0	0.3
	HT/VHT20 STBC, M0 to M7	2	5	4.6	5.1			7.9	11.0	3.1
	HT/VHT20 STBC, M0 to M7	3	7	4.6	5.1	5.3		9.8	10.0	0.2
	HT/VHT20 STBC, M0 to M7	4	8	1.5	1.7	1.9	3.0	8.1	9.0	0.9



5710	Non HT40, 6 to 54 Mbps	1	5	2.9				2.9	11.0	8.1
	Non HT40, 6 to 54 Mbps	2	8	2.9	3.0			6.0	9.0	3.0
	Non HT40, 6 to 54 Mbps	3	10	1.9	2.1	2.3		6.9	7.0	0.1
	Non HT40, 6 to 54 Mbps	4	11	-1.3	-1.0	-1.3	1.4	5.6	6.0	0.4
	HT/VHT40, M0 to M7	1	5	1.3				1.3	11.0	9.7
	HT/VHT40, M0 to M7	2	8	1.3	1.9			4.6	9.0	4.4
	HT/VHT40, M8 to M15	2	5	1.3	1.9			4.6	11.0	6.4
	HT/VHT40, M0 to M7	3	10	1.3	1.9	1.8		6.4	7.0	0.6
	HT/VHT40, M8 to M15	3	7	1.3	1.9	1.8		6.4	10.0	3.6
	HT/VHT40, M16 to M23	3	5	1.3	1.9	1.8		6.4	11.0	4.6
	HT/VHT40, M0 to M7	4	11	-0.7	-0.3	-0.6	1.0	5.9	6.0	0.1
	HT/VHT40, M8 to M15	4	8	1.3	1.9	1.8	3.2	8.1	9.0	0.9
	HT/VHT40, M16 to M23	4	6	1.3	1.9	1.8	3.2	8.1	11.0	2.9
	HT/VHT40 Beam Forming, M0 to M7	2	8	1.3	1.9			4.6	9.0	4.4
	HT/VHT40 Beam Forming, M8 to M15	2	5	1.3	1.9			4.6	11.0	6.4
	HT/VHT40 Beam Forming, M0 to M7	3	10	0.2	0.8	0.4		5.2	7.0	1.8
	HT/VHT40 Beam Forming, M8 to M15	3	7	1.3	1.9	1.8		6.4	10.0	3.6
	HT/VHT40 Beam Forming, M16 to M23	3	5	1.3	1.9	1.8		6.4	11.0	4.6
	HT/VHT40 Beam Forming, M0 to M7	4	11	-2.2	-1.3	-1.5	-0.3	4.7	6.0	1.3
	HT/VHT40 Beam Forming, M8 to M15	4	8	0.2	1.3	0.6	3.2	7.5	9.0	1.5
HT/VHT40 Beam Forming, M16 to M23	4	6	1.3	1.9	1.8	3.2	8.1	11.0	2.9	
HT/VHT40 STBC, M0 to M7	2	5	1.3	1.9			4.6	11.0	6.4	
HT/VHT40 STBC, M0 to M7	3	7	1.3	1.9	1.8		6.4	10.0	3.6	
HT/VHT40 STBC, M0 to M7	4	8	1.3	1.9	1.8	3.2	8.1	9.0	0.9	
5720	Non HT20, 6 to 54 Mbps	1	5	4.5				4.5	11.0	6.5
	Non HT20, 6 to 54 Mbps	2	8	4.5	5.6			8.1	9.0	0.9
	Non HT20, 6 to 54 Mbps	3	10	1.3	1.7	0.9		6.1	7.0	0.9
	Non HT20, 6 to 54 Mbps	4	11	-0.7	0.1	-1.2	1.1	5.9	6.0	0.1
	Non HT20 Beam Forming, 6 to 54 Mbps	2	8	4.5	5.6			8.1	9.0	0.9
	Non HT20 Beam Forming, 6 to 54 Mbps	3	10	1.3	1.7	0.9		6.1	7.0	0.9
	Non HT20 Beam Forming, 6 to 54 Mbps	4	11	-0.7	0.1	-1.2	1.1	5.9	6.0	0.1
	HT/VHT20, M0 to M7	1	5	4.4				4.4	11.0	6.6
	HT/VHT20, M0 to M7	2	8	4.4	5.3			7.9	9.0	1.1
	HT/VHT20, M8 to M15	2	5	4.4	5.3			7.9	11.0	3.1
	HT/VHT20, M0 to M7	3	10	1.3	1.5	0.5		5.9	7.0	1.1
	HT/VHT20, M8 to M15	3	7	4.4	5.3	4.2		9.4	10.0	0.6
	HT/VHT20, M16 to M23	3	5	4.4	5.3	4.2		9.4	11.0	1.6
	HT/VHT20, M0 to M7	4	11	-0.6	0.2	-1.1	0.9	5.9	6.0	0.1
	HT/VHT20, M8 to M15	4	8	2.2	3.1	2.2	4.1	9.0	9.0	0.0
HT/VHT20, M16 to M23	4	6	3.6	3.9	3.0	6.3	10.4	11.0	0.6	



HT/VHT20 Beam Forming, M0 to M7	2	8	4.4	5.3			7.9	9.0	1.1
HT/VHT20 Beam Forming, M8 to M15	2	5	4.4	5.3			7.9	11.0	3.1
HT/VHT20 Beam Forming, M0 to M7	3	10	1.3	1.5	0.5		5.9	7.0	1.1
HT/VHT20 Beam Forming, M8 to M15	3	7	4.4	5.3	4.2		9.4	10.0	0.6
HT/VHT20 Beam Forming, M16 to M23	3	5	4.4	5.3	4.2		9.4	11.0	1.6
HT/VHT20 Beam Forming, M0 to M7	4	11	-0.6	0.2	-1.1	0.9	5.9	6.0	0.1
HT/VHT20 Beam Forming, M8 to M15	4	8	2.2	3.1	2.2	4.1	9.0	9.0	0.0
HT/VHT20 Beam Forming, M16 to M23	4	6	3.6	3.9	3.0	6.3	10.4	11.0	0.6
HT/VHT20 STBC, M0 to M7	2	5	4.4	5.3			7.9	11.0	3.1
HT/VHT20 STBC, M0 to M7	3	7	4.4	5.3	4.2		9.4	10.0	0.6
HT/VHT20 STBC, M0 to M7	4	8	2.2	3.1	2.2	4.1	9.0	9.0	0.0



**Peak Output Power, 5690 MHz, VHT80 Beam Forming, M0 to M9 1ss**

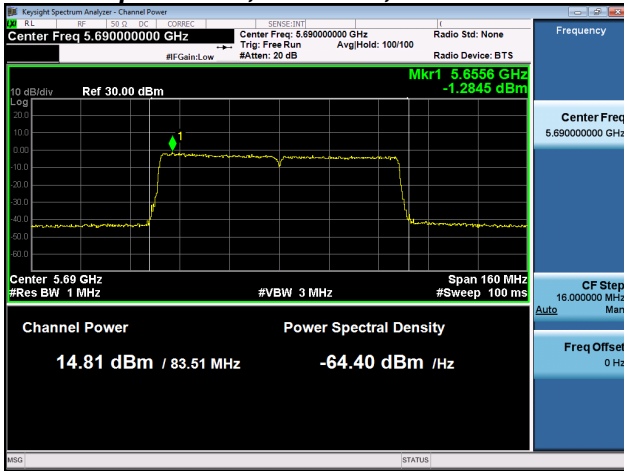

**Antenna A**

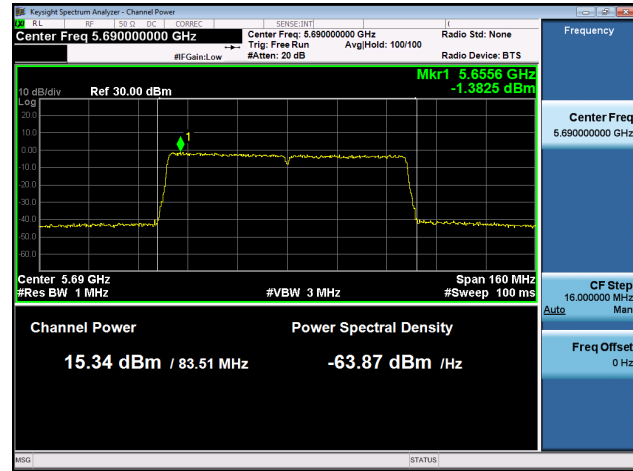

**Antenna B**

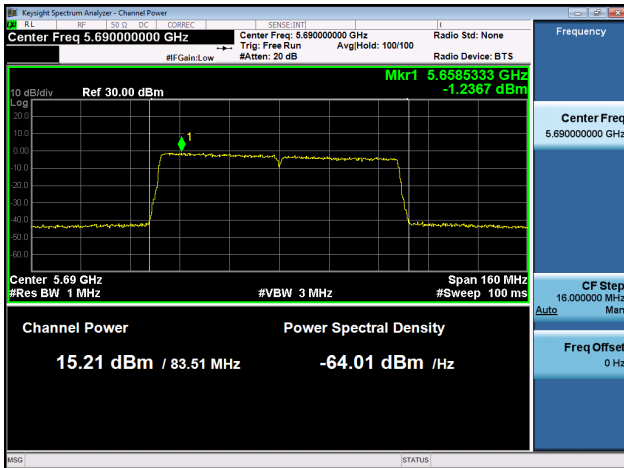

**Antenna C**



**Power Spectral Density, 5720 MHz, HT/VHT20, M8 to M15**

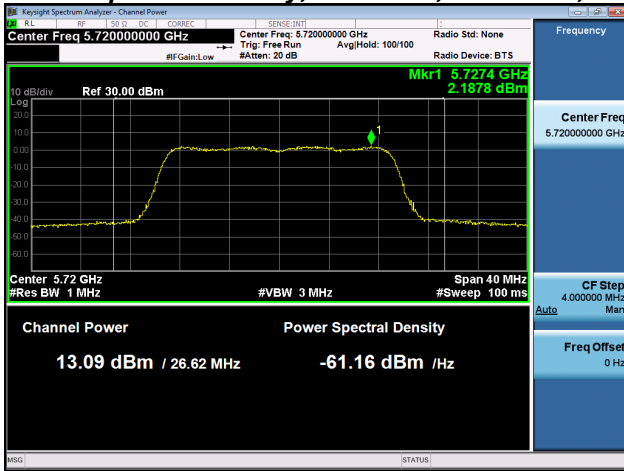

**Antenna A**

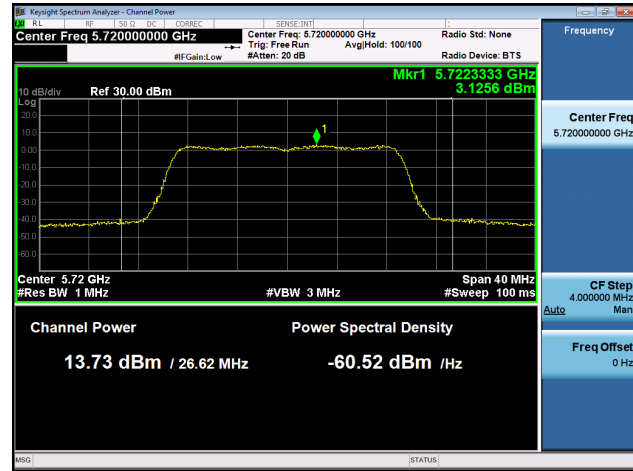

**Antenna B**

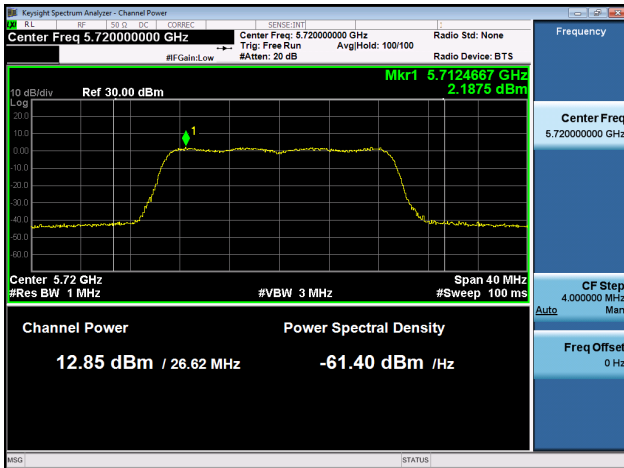

**Antenna C**

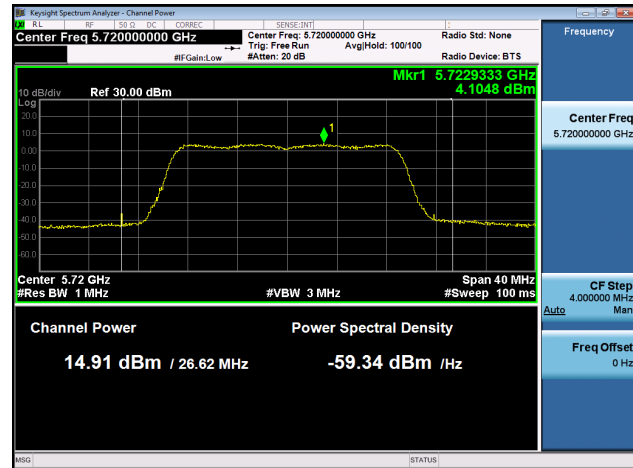

**Antenna D**



**Antenna Gain : 6 dBi**

Frequency (MHz)	Mode	Tx Paths	Correlated Antenna Gain (dBi)	Tx 1 Max Power (dBm)	Tx 2 Max Power (dBm)	Tx 3 Max Power (dBm)	Tx 4 Max Power (dBm)	Total Tx Channel Power (dBm)	Limit (dBm)	Margin (dB)
5500	Non HT20, 6 to 54 Mbps	1	6	16.0				16.0	23.6	7.6
	Non HT20, 6 to 54 Mbps	2	6	14.6	14.9			17.8	23.6	5.8
	Non HT20, 6 to 54 Mbps	3	6	11.5	11.8	10.6		16.1	23.6	7.5
	Non HT20, 6 to 54 Mbps	4	6	11.1	7.1	7.3	8.8	14.9	23.6	8.7
	Non HT20 Beam Forming, 6 to 54 Mbps	2	9	13.4	13.7			16.6	20.6	4.0
	Non HT20 Beam Forming, 6 to 54 Mbps	3	11	12.1	8.2	8.2		14.7	18.6	3.9
	Non HT20 Beam Forming, 6 to 54 Mbps	4	12	9.9	6.2	6.3	7.8	13.8	17.6	3.8
	HT/VHT20, M0 to M7	1	6	17.4				17.4	23.6	6.2
	HT/VHT20, M0 to M7	2	6	14.8	15.2			18.0	23.6	5.6
	HT/VHT20, M8 to M15	2	6	17.4	17.6			20.5	23.6	3.1
	HT/VHT20, M0 to M7	3	6	11.7	12.0	10.8		16.3	23.6	7.3
	HT/VHT20, M8 to M15	3	6	14.8	15.2	14.0		19.5	23.6	4.1
	HT/VHT20, M16 to M23	3	6	16.1	16.4	15.2		20.7	23.6	2.9
	HT/VHT20, M0 to M7	4	6	11.2	7.2	7.4	9.0	15.0	23.6	8.6
	HT/VHT20, M8 to M15	4	6	12.7	13.0	11.7	11.3	18.3	23.6	5.3
	HT/VHT20, M16 to M23	4	6	14.8	15.2	14.0	13.4	20.4	23.6	3.2
	HT/VHT20 Beam Forming, M0 to M7	2	9	13.6	13.9			16.8	20.6	3.8
	HT/VHT20 Beam Forming, M8 to M15	2	6	17.4	17.6			20.5	23.6	3.1
	HT/VHT20 Beam Forming, M0 to M7	3	11	12.1	8.3	8.4		14.8	18.6	3.8
	HT/VHT20 Beam Forming, M8 to M15	3	8	13.6	13.9	12.7		18.2	21.6	3.4
	HT/VHT20 Beam Forming, M16 to M23	3	6	16.1	16.4	15.2		20.7	23.6	2.9
	HT/VHT20 Beam Forming, M0 to M7	4	12	10.0	6.4	6.4	7.9	14.0	17.6	3.6
	HT/VHT20 Beam Forming, M8 to M15	4	9	11.7	12.0	10.8	10.3	17.3	20.6	3.3
	HT/VHT20 Beam Forming, M16 to M23	4	7	13.6	13.9	12.7	12.2	19.2	22.6	3.4
	HT/VHT20 STBC, M0 to M7	2	6	17.4	17.6			20.5	23.6	3.1
	HT/VHT20 STBC, M0 to M7	3	6	14.8	15.2	14.0		19.5	23.6	4.1
	HT/VHT20 STBC, M0 to M7	4	6	12.7	13.0	11.7	11.3	18.3	23.6	5.3
	5510	Non HT40, 6 to 54 Mbps	1	6	11.5				11.5	24.0
Non HT40, 6 to 54 Mbps		2	6	10.6	7.8			12.4	24.0	11.6
Non HT40, 6 to 54 Mbps		3	6	7.7	4.8	4.4		10.7	24.0	13.3
Non HT40, 6 to 54 Mbps		4	6	6.7	3.9	3.5	4.5	10.9	24.0	13.1
HT/VHT40, M0 to M7		1	6	15.3				15.3	24.0	8.7



	HT/VHT40, M0 to M7	2	6	11.0	11.4			14.2	24.0	9.8
	HT/VHT40, M8 to M15	2	6	11.0	11.4			14.2	24.0	9.8
	HT/VHT40, M0 to M7	3	6	11.0	11.4	10.9		15.9	24.0	8.1
	HT/VHT40, M8 to M15	3	6	11.0	11.4	10.9		15.9	24.0	8.1
	HT/VHT40, M16 to M23	3	6	11.0	11.4	10.9		15.9	24.0	8.1
	HT/VHT40, M0 to M7	4	6	12.3	9.6	9.0	10.3	16.5	24.0	7.5
	HT/VHT40, M8 to M15	4	6	12.3	9.6	9.0	10.3	16.5	24.0	7.5
	HT/VHT40, M16 to M23	4	6	12.3	9.6	9.0	10.3	16.5	24.0	7.5
	HT/VHT40 Beam Forming, M0 to M7	2	9	12.3	9.6			14.2	21.0	6.8
	HT/VHT40 Beam Forming, M8 to M15	2	6	11.0	11.4			14.2	24.0	9.8
	HT/VHT40 Beam Forming, M0 to M7	3	11	8.4	5.5	5.1		11.4	19.0	7.6
	HT/VHT40 Beam Forming, M8 to M15	3	8	11.3	8.7	8.0		14.3	22.0	7.7
	HT/VHT40 Beam Forming, M16 to M23	3	6	11.0	11.4	10.9		15.9	24.0	8.1
	HT/VHT40 Beam Forming, M0 to M7	4	12	6.5	3.6	3.2	4.3	10.6	18.0	7.4
	HT/VHT40 Beam Forming, M8 to M15	4	9	8.4	5.5	5.1	6.1	12.5	21.0	8.5
	HT/VHT40 Beam Forming, M16 to M23	4	7	12.3	9.6	9.0	10.3	16.5	23.0	6.5
	HT/VHT40 STBC, M0 to M7	2	6	11.0	11.4			14.2	24.0	9.8
	HT/VHT40 STBC, M0 to M7	3	6	11.0	11.4	10.9		15.9	24.0	8.1
	HT/VHT40 STBC, M0 to M7	4	6	12.3	9.6	9.0	10.3	16.5	24.0	7.5
530	Non HT80, 6 to 54 Mbps	1	6	13.4				13.4	24.0	10.6
	Non HT80, 6 to 54 Mbps	2	6	13.4	13.7			16.6	24.0	7.4
	Non HT80, 6 to 54 Mbps	3	6	10.2	10.4	10.3		15.1	24.0	8.9
	Non HT80, 6 to 54 Mbps	4	6	10.2	10.4	10.3	9.9	16.2	24.0	7.8
	VHT80, M0 to M9 1ss	1	6	15.1				15.1	24.0	8.9
	VHT80, M0 to M9 1ss	2	6	15.1	15.3			18.2	24.0	5.8
	VHT80, M0 to M9 2ss	2	6	15.1	15.3			18.2	24.0	5.8
	VHT80, M0 to M9 1ss	3	6	13.9	14.2	14.0		18.8	24.0	5.2
	VHT80, M0 to M9 2ss	3	6	13.9	14.2	14.0		18.8	24.0	5.2
	VHT80, M0 to M9 3ss	3	6	13.9	14.2	14.0		18.8	24.0	5.2
	VHT80, M0 to M9 1ss	4	6	12.7	13.0	13.0	12.5	18.8	24.0	5.2
	VHT80, M0 to M9 2ss	4	6	12.7	13.0	13.0	12.5	18.8	24.0	5.2
	VHT80, M0 to M9 3ss	4	6	12.7	13.0	13.0	12.5	18.8	24.0	5.2
	VHT80 Beam Forming, M0 to M9 1ss	2	9	12.7	13.0			15.9	21.0	5.1
	VHT80 Beam Forming, M0 to M9 2ss	2	6	15.1	15.3			18.2	24.0	5.8
	VHT80 Beam Forming, M0 to M9 1ss	3	11	11.6	10.0	9.0		15.1	19.0	3.9
	VHT80 Beam Forming, M0 to M9 2ss	3	8	12.7	13.0	13.0		17.7	22.0	4.3
	VHT80 Beam Forming, M0 to M9 3ss	3	6	13.9	14.2	14.0		18.8	24.0	5.2
	VHT80 Beam Forming, M0 to M9 1ss	4	12	10.7	9.0	8.0	8.1	15.1	18.0	2.9
	VHT80 Beam Forming, M0 to M9 2ss	4	9	10.8	11.1	11.1	10.6	16.9	21.0	4.1
VHT80 Beam Forming, M0 to M9 3ss	4	7	12.7	13.0	13.0	12.5	18.8	23.0	4.2	



	VHT80 STBC, M0 to M9 1ss	2	6	15.1	15.3			18.2	24.0	5.8
	VHT80 STBC, M0 to M9 1ss	3	6	13.9	14.2	14.0		18.8	24.0	5.2
	VHT80 STBC, M0 to M9 1ss	4	6	12.7	13.0	13.0	12.5	18.8	24.0	5.2
5570	Non HT160, 6 to 54 Mbps	1	6	12.1				12.1	24.0	11.9
	Non HT160, 6 to 54 Mbps	2	6	11.2	11.6			14.4	24.0	9.6
	Non HT160, 6 to 54 Mbps	3	6	11.2	11.6	11.0		16.0	24.0	8.0
	Non HT160, 6 to 54 Mbps	4	6	11.2	11.6	11.0	11.1	17.3	24.0	6.7
	VHT160, M0 to M9 1ss	1	6	16.0				16.0	24.0	8.0
	VHT160, M0 to M9 1ss	2	6	14.8	15.2			18.0	24.0	6.0
	VHT160, M0 to M9 2ss	2	6	14.8	15.2			18.0	24.0	6.0
	VHT160, M0 to M9 1ss	3	6	12.7	13.2	12.7		17.6	24.0	6.4
	VHT160, M0 to M9 2ss	3	6	12.7	13.2	12.7		17.6	24.0	6.4
	VHT160, M0 to M9 3ss	3	6	12.7	13.2	12.7		17.6	24.0	6.4
	VHT160, M0 to M9 1ss	4	6	12.7	13.2	12.7	12.8	18.9	24.0	5.1
	VHT160, M0 to M9 2ss	4	6	12.7	13.2	12.7	12.8	18.9	24.0	5.1
	VHT160, M0 to M9 3ss	4	6	12.7	13.2	12.7	12.8	18.9	24.0	5.1
	VHT160 Beam Forming, M0 to M9 1ss	2	9	11.8	12.3			15.1	21.0	5.9
	VHT160 Beam Forming, M0 to M9 2ss	2	6	14.8	15.2			18.0	24.0	6.0
	VHT160 Beam Forming, M0 to M9 1ss	3	11	10.1	8.6	7.6		13.7	19.0	5.3
	VHT160 Beam Forming, M0 to M9 2ss	3	8	11.8	12.3	11.7		16.7	22.0	5.3
	VHT160 Beam Forming, M0 to M9 3ss	3	6	12.7	13.2	12.7		17.6	24.0	6.4
	VHT160 Beam Forming, M0 to M9 1ss	4	12	10.1	8.6	7.6	7.7	14.6	18.0	3.4
	VHT160 Beam Forming, M0 to M9 2ss	4	9	11.0	9.8	8.5	8.6	15.6	21.0	5.4
	VHT160 Beam Forming, M0 to M9 3ss	4	7	11.8	12.3	11.7	11.8	17.9	23.0	5.1
VHT160 STBC, M0 to M9 1ss	2	6	14.8	15.2			18.0	24.0	6.0	
VHT160 STBC, M0 to M9 1ss	3	6	12.7	13.2	12.7		17.6	24.0	6.4	
VHT160 STBC, M0 to M9 1ss	4	6	12.7	13.2	12.7	12.8	18.9	24.0	5.1	
5560	Non HT20, 6 to 54 Mbps	1	6	16.2				16.2	23.6	7.4
	Non HT20, 6 to 54 Mbps	2	6	15.1	15.3			18.2	23.6	5.4
	Non HT20, 6 to 54 Mbps	3	6	10.8	11.1	11.2		15.8	23.6	7.8
	Non HT20, 6 to 54 Mbps	4	6	8.8	9.1	9.2	9.7	15.2	23.6	8.4
	Non HT20 Beam Forming, 6 to 54 Mbps	2	9	15.1	15.3			18.2	20.6	2.4
	Non HT20 Beam Forming, 6 to 54 Mbps	3	11	10.8	11.1	11.2		15.8	18.6	2.8
	Non HT20 Beam Forming, 6 to 54 Mbps	4	12	8.8	9.1	9.2	9.7	15.2	17.6	2.4
	HT/VHT20, M0 to M7	1	6	16.4				16.4	23.6	7.2
	HT/VHT20, M0 to M7	2	6	15.3	15.5			18.4	23.6	5.2
	HT/VHT20, M8 to M15	2	6	16.4	16.7			19.6	23.6	4.0
	HT/VHT20, M0 to M7	3	6	10.9	11.3	11.4		16.0	23.6	7.6
	HT/VHT20, M8 to M15	3	6	14.0	14.4	14.6		19.1	23.6	4.5





	HT/VHT20, M16 to M23	3	6	16.4	16.7	16.9		21.4	23.6	2.2
	HT/VHT20, M0 to M7	4	6	9.0	9.3	9.4	9.8	15.4	23.6	8.2
	HT/VHT20, M8 to M15	4	6	11.9	12.2	12.3	12.9	18.4	23.6	5.2
	HT/VHT20, M16 to M23	4	6	14.0	14.4	14.6	14.9	20.5	23.6	3.1
	HT/VHT20 Beam Forming, M0 to M7	2	9	15.3	15.5			18.4	20.6	2.2
	HT/VHT20 Beam Forming, M8 to M15	2	6	16.4	16.7			19.6	23.6	4.0
	HT/VHT20 Beam Forming, M0 to M7	3	11	10.9	11.3	11.4		16.0	18.6	2.6
	HT/VHT20 Beam Forming, M8 to M15	3	8	14.0	14.4	14.6		19.1	21.6	2.5
	HT/VHT20 Beam Forming, M16 to M23	3	6	16.4	16.7	16.9		21.4	23.6	2.2
	HT/VHT20 Beam Forming, M0 to M7	4	12	9.0	9.3	9.4	9.8	15.4	17.6	2.2
	HT/VHT20 Beam Forming, M8 to M15	4	9	11.9	12.2	12.3	12.9	18.4	20.6	2.2
	HT/VHT20 Beam Forming, M16 to M23	4	7	14.0	14.4	14.6	14.9	20.5	22.6	2.1
	HT/VHT20 STBC, M0 to M7	2	6	16.4	16.7			19.6	23.6	4.0
	HT/VHT20 STBC, M0 to M7	3	6	14.0	14.4	14.6		19.1	23.6	4.5
	HT/VHT20 STBC, M0 to M7	4	6	11.9	12.2	12.3	12.9	18.4	23.6	5.2
5660	Non HT20, 6 to 54 Mbps	1	6	17.1				17.1	23.6	6.5
	Non HT20, 6 to 54 Mbps	2	6	14.8	15.4			18.1	23.6	5.5
	Non HT20, 6 to 54 Mbps	3	6	11.1	9.6	9.7		15.0	23.5	8.5
	Non HT20, 6 to 54 Mbps	4	6	10.2	8.6	8.7	8.4	15.1	23.6	8.5
	Non HT20 Beam Forming, 6 to 54 Mbps	2	9	14.8	15.4			18.1	20.6	2.5
	Non HT20 Beam Forming, 6 to 54 Mbps	3	11	11.1	9.6	9.7		15.0	18.5	3.5
	Non HT20 Beam Forming, 6 to 54 Mbps	4	12	10.2	8.6	8.7	8.4	15.1	17.6	2.5
	HT/VHT20, M0 to M7	1	6	17.3				17.3	23.6	6.3
	HT/VHT20, M0 to M7	2	6	14.9	15.5			18.2	23.6	5.4
	HT/VHT20, M8 to M15	2	6	17.3	17.7			20.5	23.6	3.1
	HT/VHT20, M0 to M7	3	6	11.3	9.8	9.9		15.2	23.6	8.4
	HT/VHT20, M8 to M15	3	6	13.7	14.3	14.3		18.9	23.6	4.7
	HT/VHT20, M16 to M23	3	6	16.1	16.6	16.7		21.2	23.6	2.4
	HT/VHT20, M0 to M7	4	6	10.3	8.8	8.7	8.6	15.2	23.6	8.4
	HT/VHT20, M8 to M15	4	6	11.8	12.3	12.5	11.7	18.1	23.6	5.5
	HT/VHT20, M16 to M23	4	6	13.7	14.3	14.3	13.5	20.0	23.6	3.6
	HT/VHT20 Beam Forming, M0 to M7	2	9	14.9	15.5			18.2	20.6	2.4
	HT/VHT20 Beam Forming, M8 to M15	2	6	17.3	17.7			20.5	23.6	3.1
	HT/VHT20 Beam Forming, M0 to M7	3	11	11.3	9.8	9.9		15.2	18.6	3.4
	HT/VHT20 Beam Forming, M8 to M15	3	8	13.7	14.3	14.3		18.9	21.6	2.7
	HT/VHT20 Beam Forming, M16 to M23	3	6	16.1	16.6	16.7		21.2	23.6	2.4
	HT/VHT20 Beam Forming, M0 to M7	4	12	10.3	8.8	8.7	8.6	15.2	17.6	2.4
	HT/VHT20 Beam Forming, M8 to M15	4	9	11.8	12.3	12.5	11.7	18.1	20.6	2.5
	HT/VHT20 Beam Forming, M16 to M23	4	7	13.7	14.3	14.3	13.5	20.0	22.6	2.6
HT/VHT20 STBC, M0 to M7	2	6	17.3	17.7			20.5	23.6	3.1	



	HT/VHT20 STBC, M0 to M7	3	6	13.7	14.3	14.3		18.9	23.6	4.7
	HT/VHT20 STBC, M0 to M7	4	6	11.8	12.3	12.5	11.7	18.1	23.6	5.5
5670	Non HT40, 6 to 54 Mbps	1	6	17.7				17.7	24.0	6.3
	Non HT40, 6 to 54 Mbps	2	6	17.7	18.1			20.9	24.0	3.1
	Non HT40, 6 to 54 Mbps	3	6	13.1	13.7	14.0		18.4	24.0	5.6
	Non HT40, 6 to 54 Mbps	4	6	12.1	11.4	10.7	10.7	17.3	24.0	6.7
	HT/VHT40, M0 to M7	1	6	16.6				16.6	24.0	7.4
	HT/VHT40, M0 to M7	2	6	16.6	17.0			19.8	24.0	4.2
	HT/VHT40, M8 to M15	2	6	16.6	17.0			19.8	24.0	4.2
	HT/VHT40, M0 to M7	3	6	13.1	13.8	14.0		18.4	24.0	5.6
	HT/VHT40, M8 to M15	3	6	16.6	17.0	17.3		21.7	24.0	2.3
	HT/VHT40, M16 to M23	3	6	16.6	17.0	17.3		21.7	24.0	2.3
	HT/VHT40, M0 to M7	4	6	11.1	11.9	12.1	11.6	17.7	24.0	6.3
	HT/VHT40, M8 to M15	4	6	14.2	14.8	15.1	14.6	20.7	24.0	3.3
	HT/VHT40, M16 to M23	4	6	16.6	17.0	17.3	16.8	23.0	24.0	1.0
	HT/VHT40 Beam Forming, M0 to M7	2	9	16.6	17.0			19.8	21.0	1.2
	HT/VHT40 Beam Forming, M8 to M15	2	6	16.6	17.0			19.8	24.0	4.2
	HT/VHT40 Beam Forming, M0 to M7	3	11	13.1	13.8	14.0		18.4	19.0	0.6
	HT/VHT40 Beam Forming, M8 to M15	3	8	16.6	17.0	17.3		21.7	22.0	0.3
	HT/VHT40 Beam Forming, M16 to M23	3	6	16.6	17.0	17.3		21.7	24.0	2.3
	HT/VHT40 Beam Forming, M0 to M7	4	12	11.1	11.9	12.1	11.6	17.7	18.0	0.3
	HT/VHT40 Beam Forming, M8 to M15	4	9	14.2	14.8	15.1	14.6	20.7	21.0	0.3
	<b>HT/VHT40 Beam Forming, M16 to M23</b>	<b>4</b>	<b>7</b>	<b>16.6</b>	<b>17.0</b>	<b>17.3</b>	<b>16.8</b>	<b>23.0</b>	<b>23.0</b>	<b>0.0</b>
HT/VHT40 STBC, M0 to M7	2	6	16.6	17.0			19.8	24.0	4.2	
HT/VHT40 STBC, M0 to M7	3	6	16.6	17.0	17.3		21.7	24.0	2.3	
HT/VHT40 STBC, M0 to M7	4	6	14.2	14.8	15.1	14.6	20.7	24.0	3.3	
5690	Non HT80, 6 to 54 Mbps	1	6	15.7				15.7	24.0	8.3
	Non HT80, 6 to 54 Mbps	2	6	15.7	16.2			19.0	24.0	5.0
	Non HT80, 6 to 54 Mbps	3	6	15.7	16.2	16.1		20.8	24.0	3.2
	Non HT80, 6 to 54 Mbps	4	6	14.6	15.0	15.0	15.0	20.9	24.0	3.1
	VHT80, M0 to M9 1ss	1	6	15.9				15.9	24.0	8.1
	VHT80, M0 to M9 1ss	2	6	15.9	16.4			19.2	24.0	4.8
	VHT80, M0 to M9 2ss	2	6	15.9	16.4			19.2	24.0	4.8
	VHT80, M0 to M9 1ss	3	6	15.9	16.4	16.3		21.0	24.0	3.0
	VHT80, M0 to M9 2ss	3	6	15.9	16.4	16.3		21.0	24.0	3.0
	VHT80, M0 to M9 3ss	3	6	15.9	16.4	16.3		21.0	24.0	3.0
	VHT80, M0 to M9 1ss	4	6	14.8	15.3	15.1	16.8	21.6	24.0	2.4
	VHT80, M0 to M9 2ss	4	6	15.9	16.4	16.3	16.7	22.4	24.0	1.6
	VHT80, M0 to M9 3ss	4	6	15.9	16.4	16.3	16.7	22.4	24.0	1.6



	VHT80 Beam Forming, M0 to M9 1ss	2	9	15.9	16.4			19.2	21.0	1.8
	VHT80 Beam Forming, M0 to M9 2ss	2	6	15.9	16.4			19.2	24.0	4.8
	VHT80 Beam Forming, M0 to M9 1ss	3	11	13.7	14.2	14.1		18.8	19.0	0.2
	VHT80 Beam Forming, M0 to M9 2ss	3	8	15.9	16.4	16.3		21.0	22.0	1.0
	VHT80 Beam Forming, M0 to M9 3ss	3	6	15.9	16.4	16.3		21.0	24.0	3.0
	VHT80 Beam Forming, M0 to M9 1ss	4	12	10.6	11.2	11.1	11.3	17.1	18.0	0.9
	VHT80 Beam Forming, M0 to M9 2ss	4	9	13.7	14.2	14.1	14.5	20.2	21.0	0.8
	VHT80 Beam Forming, M0 to M9 3ss	4	7	15.9	16.4	16.3	16.7	22.4	23.0	0.6
	VHT80 STBC, M0 to M9 1ss	2	6	15.9	16.4			19.2	24.0	4.8
	VHT80 STBC, M0 to M9 1ss	3	6	15.9	16.4	16.3		21.0	24.0	3.0
	VHT80 STBC, M0 to M9 1ss	4	6	15.9	16.4	16.3	16.7	22.4	24.0	1.6
5700	Non HT20, 6 to 54 Mbps	1	6	15.4				15.4	23.6	8.2
	Non HT20, 6 to 54 Mbps	2	6	15.4	15.8			18.6	23.6	5.0
	Non HT20, 6 to 54 Mbps	3	6	11.0	11.5	11.2		16.0	23.6	7.6
	Non HT20, 6 to 54 Mbps	4	6	9.7	9.7	8.5	7.8	15.0	23.6	8.6
	Non HT20 Beam Forming, 6 to 54 Mbps	2	9	15.4	15.8			18.6	20.6	2.0
	Non HT20 Beam Forming, 6 to 54 Mbps	3	11	11.0	11.5	11.2		16.0	18.6	2.6
	Non HT20 Beam Forming, 6 to 54 Mbps	4	12	9.7	9.7	8.5	7.8	15.0	17.6	2.6
	HT/VHT20, M0 to M7	1	6	15.6				15.6	23.6	8.0
	HT/VHT20, M0 to M7	2	6	15.6	16.0			18.8	23.6	4.8
	HT/VHT20, M8 to M15	2	6	15.6	16.0			18.8	23.6	4.8
	HT/VHT20, M0 to M7	3	6	11.2	11.8	11.4		16.2	23.6	7.4
	HT/VHT20, M8 to M15	3	6	14.5	14.9	14.6		19.4	23.6	4.2
	HT/VHT20, M16 to M23	3	6	15.6	16.0	15.7		20.5	23.6	3.1
	HT/VHT20, M0 to M7	4	6	9.9	9.9	8.6	8.1	15.2	23.6	8.4
	HT/VHT20, M8 to M15	4	6	11.2	11.8	11.4	12.8	17.9	23.6	5.7
	HT/VHT20, M16 to M23	4	6	13.3	13.9	13.6	14.9	20.0	23.6	3.6
	HT/VHT20 Beam Forming, M0 to M7	2	9	15.6	16.0			18.8	20.6	1.8
	HT/VHT20 Beam Forming, M8 to M15	2	6	15.6	16.0			18.8	23.6	4.8
	HT/VHT20 Beam Forming, M0 to M7	3	11	11.2	11.8	11.4		16.2	18.6	2.4
	HT/VHT20 Beam Forming, M8 to M15	3	8	14.5	14.9	14.6		19.4	21.6	2.2
	HT/VHT20 Beam Forming, M16 to M23	3	6	15.6	16.0	15.7		20.5	23.6	3.1
	HT/VHT20 Beam Forming, M0 to M7	4	12	9.9	9.9	8.6	8.1	15.2	17.6	2.4
	HT/VHT20 Beam Forming, M8 to M15	4	9	11.2	11.8	11.4	12.8	17.9	20.6	2.7
	HT/VHT20 Beam Forming, M16 to M23	4	7	13.3	13.9	13.6	14.9	20.0	22.6	2.6
	HT/VHT20 STBC, M0 to M7	2	6	15.6	16.0			18.8	23.6	4.8
	HT/VHT20 STBC, M0 to M7	3	6	14.5	14.9	14.6		19.4	23.6	4.2
HT/VHT20 STBC, M0 to M7	4	6	11.2	11.8	11.4	12.8	17.9	23.6	5.7	



5710	Non HT40, 6 to 54 Mbps	1	6	16.3				16.3	24.0	7.7
	Non HT40, 6 to 54 Mbps	2	6	16.3	16.7			19.5	24.0	4.5
	Non HT40, 6 to 54 Mbps	3	6	14.1	14.6	14.1		19.0	24.0	5.0
	Non HT40, 6 to 54 Mbps	4	6	11.1	11.8	11.3	12.9	17.9	24.0	6.1
	HT/VHT40, M0 to M7	1	6	15.2				15.2	24.0	8.8
	HT/VHT40, M0 to M7	2	6	15.2	15.7			18.5	24.0	5.5
	HT/VHT40, M8 to M15	2	6	15.2	15.7			18.5	24.0	5.5
	HT/VHT40, M0 to M7	3	6	14.1	14.5	14.0		19.0	24.0	5.0
	HT/VHT40, M8 to M15	3	6	15.2	15.7	15.1		20.1	24.0	3.9
	HT/VHT40, M16 to M23	3	6	15.2	15.7	15.1		20.1	24.0	3.9
	HT/VHT40, M0 to M7	4	6	11.7	12.5	12.0	13.6	18.5	24.0	5.5
	HT/VHT40, M8 to M15	4	6	14.1	14.5	14.0	17.1	21.1	24.0	2.9
	HT/VHT40, M16 to M23	4	6	15.2	15.7	15.1	17.0	21.8	24.0	2.2
	HT/VHT40 Beam Forming, M0 to M7	2	9	15.2	15.7			18.5	21.0	2.5
	HT/VHT40 Beam Forming, M8 to M15	2	6	15.2	15.7			18.5	24.0	5.5
	HT/VHT40 Beam Forming, M0 to M7	3	11	12.9	13.5	13.0		17.9	19.0	1.1
	HT/VHT40 Beam Forming, M8 to M15	3	8	15.2	15.7	15.1		20.1	22.0	1.9
	HT/VHT40 Beam Forming, M16 to M23	3	6	15.2	15.7	15.1		20.1	24.0	3.9
	HT/VHT40 Beam Forming, M0 to M7	4	12	10.8	11.6	11.1	12.6	17.6	18.0	0.4
	HT/VHT40 Beam Forming, M8 to M15	4	9	14.1	14.6	14.0	15.9	20.7	21.0	0.3
	HT/VHT40 Beam Forming, M16 to M23	4	7	15.2	15.7	15.1	17.0	21.8	23.0	1.2
HT/VHT40 STBC, M0 to M7	2	6	15.2	15.7			18.5	24.0	5.5	
HT/VHT40 STBC, M0 to M7	3	6	15.2	15.7	15.1		20.1	24.0	3.9	
HT/VHT40 STBC, M0 to M7	4	6	14.1	14.5	14.0	17.1	21.1	24.0	2.9	
5720	Non HT20, 6 to 54 Mbps	1	6	15.2				15.2	23.6	8.4
	Non HT20, 6 to 54 Mbps	2	6	14.1	14.7			17.4	23.6	6.2
	Non HT20, 6 to 54 Mbps	3	6	10.9	11.5	10.5		15.8	23.6	7.8
	Non HT20, 6 to 54 Mbps	4	6	9.0	9.6	8.6	10.5	15.5	23.6	8.1
	Non HT20 Beam Forming, 6 to 54 Mbps	2	9	14.1	14.7			17.4	20.6	3.2
	Non HT20 Beam Forming, 6 to 54 Mbps	3	11	10.9	11.5	10.5		15.8	18.6	2.8
	Non HT20 Beam Forming, 6 to 54 Mbps	4	12	9.0	9.6	8.6	10.5	15.5	17.6	2.1
	HT/VHT20, M0 to M7	1	6	15.3				15.3	23.6	8.3
	HT/VHT20, M0 to M7	2	6	15.3	16.0			18.7	23.6	4.9
	HT/VHT20, M8 to M15	2	6	15.3	16.0			18.7	23.6	4.9
	HT/VHT20, M0 to M7	3	6	12.0	12.6	11.5		16.8	23.6	6.8
	HT/VHT20, M8 to M15	3	6	14.2	14.8	13.9		19.1	23.6	4.5
	HT/VHT20, M16 to M23	3	6	15.3	16.0	15.0		20.2	23.6	3.4
	HT/VHT20, M0 to M7	4	6	9.2	9.8	8.7	10.6	15.7	23.6	7.9
HT/VHT20, M8 to M15	4	6	12.0	12.6	11.5	13.8	18.6	23.6	5.0	



HT/VHT20, M16 to M23	4	6	13.1	13.7	12.8	14.9	19.7	23.6	3.9
HT/VHT20 Beam Forming, M0 to M7	2	9	15.3	16.0			18.7	20.6	1.9
HT/VHT20 Beam Forming, M8 to M15	2	6	15.3	16.0			18.7	23.6	4.9
HT/VHT20 Beam Forming, M0 to M7	3	11	12.0	12.6	11.5		16.8	18.6	1.8
HT/VHT20 Beam Forming, M8 to M15	3	8	14.2	14.8	13.9		19.1	21.6	2.5
HT/VHT20 Beam Forming, M16 to M23	3	6	15.3	16.0	15.0		20.2	23.6	3.4
HT/VHT20 Beam Forming, M0 to M7	4	12	9.2	9.8	8.7	10.6	15.7	17.6	1.9
HT/VHT20 Beam Forming, M8 to M15	4	9	12.0	12.6	11.5	13.8	18.6	20.6	2.0
HT/VHT20 Beam Forming, M16 to M23	4	7	13.1	13.7	12.8	14.9	19.7	22.6	2.9
HT/VHT20 STBC, M0 to M7	2	6	15.3	16.0			18.7	23.6	4.9
HT/VHT20 STBC, M0 to M7	3	6	14.2	14.8	13.9		19.1	23.6	4.5
HT/VHT20 STBC, M0 to M7	4	6	12.0	12.6	11.5	13.8	18.6	23.6	5.0



Frequency (MHz)	Mode	Tx Paths	Correlated Antenna Gain (dBi)	Tx 1 PSD (dBm/MHz)	Tx 2 PSD (dBm/MHz)	Tx 3 PSD (dBm/MHz)	Tx 4 PSD (dBm/MHz)	Total PSD (dBm/MHz)	Limit (dBm/MHz)	Margin (dB)
5500	Non HT20, 6 to 54 Mbps	1	6	5.5				5.5	11.0	5.5
	Non HT20, 6 to 54 Mbps	2	9	4.1	4.3			7.2	8.0	0.8
	Non HT20, 6 to 54 Mbps	3	11	1.4	1.4	0.1		5.8	6.0	0.2
	Non HT20, 6 to 54 Mbps	4	12	0.5	-3.2	-3.2	-1.8	4.4	5.0	0.6
	Non HT20 Beam Forming, 6 to 54 Mbps	2	9	3.0	3.3			6.2	8.0	1.8
	Non HT20 Beam Forming, 6 to 54 Mbps	3	11	1.4	-2.2	-2.4		4.1	6.0	1.9
	Non HT20 Beam Forming, 6 to 54 Mbps	4	12	-0.2	-4.3	-4.4	-2.6	3.5	5.0	1.5
	HT/VHT20, M0 to M7	1	6	7.1				7.1	11.0	3.9
	HT/VHT20, M0 to M7	2	9	4.0	4.5			7.3	8.0	0.7
	HT/VHT20, M8 to M15	2	6	7.1	7.5			10.3	11.0	0.7
	HT/VHT20, M0 to M7	3	11	1.2	1.6	-0.1		5.7	6.0	0.3
	HT/VHT20, M8 to M15	3	8	4.0	4.5	3.4		8.8	9.0	0.2
	HT/VHT20, M16 to M23	3	6	5.6	5.8	4.3		10.1	11.0	0.9
	HT/VHT20, M0 to M7	4	12	0.3	-3.6	-3.4	-1.7	4.2	5.0	0.8
	HT/VHT20, M8 to M15	4	9	2.0	2.9	1.0	0.8	7.8	8.0	0.2
	HT/VHT20, M16 to M23	4	7	4.0	4.5	3.4	2.5	9.7	10.0	0.3
	HT/VHT20 Beam Forming, M0 to M7	2	9	2.8	3.2			6.0	8.0	2.0
	HT/VHT20 Beam Forming, M8 to M15	2	6	7.1	7.5			10.3	11.0	0.7
	HT/VHT20 Beam Forming, M0 to M7	3	11	1.4	-2.6	-2.2		4.0	6.0	2.0
	HT/VHT20 Beam Forming, M8 to M15	3	8	2.8	3.2	2.3		7.6	9.0	1.4
	HT/VHT20 Beam Forming, M16 to M23	3	6	5.6	5.8	4.3		10.1	11.0	0.9
	HT/VHT20 Beam Forming, M0 to M7	4	12	-0.9	-4.6	-4.1	-3.0	3.1	5.0	1.9
	HT/VHT20 Beam Forming, M8 to M15	4	9	1.2	1.6	-0.1	-0.5	6.7	8.0	1.3
	HT/VHT20 Beam Forming, M16 to M23	4	7	2.8	3.2	2.3	1.3	8.5	10.0	1.5
	HT/VHT20 STBC, M0 to M7	2	6	7.1	7.5			10.3	11.0	0.7
	HT/VHT20 STBC, M0 to M7	3	8	4.0	4.5	3.4		8.8	9.0	0.2
	HT/VHT20 STBC, M0 to M7	4	9	2.0	2.9	1.0	0.8	7.8	8.0	0.2
5510	Non HT40, 6 to 54 Mbps	1	6	-1.6				-1.6	11.0	12.6
	Non HT40, 6 to 54 Mbps	2	9	-2.5	-5.6			-0.8	8.0	8.8
	Non HT40, 6 to 54 Mbps	3	11	-5.1	-8.6	-8.8		-2.4	6.0	8.4
	Non HT40, 6 to 54 Mbps	4	12	-6.1	-9.5	-9.8	-8.5	-2.2	5.0	7.2
	HT/VHT40, M0 to M7	1	6	2.2				2.2	11.0	8.8
	HT/VHT40, M0 to M7	2	9	-2.1	-1.7			1.1	8.0	6.9



HT/VHT40, M8 to M15	2	6	-2.1	-1.7				1.1	11.0	9.9
HT/VHT40, M0 to M7	3	11	-2.1	-1.7	-3.0			2.5	6.0	3.5
HT/VHT40, M8 to M15	3	8	-2.1	-1.7	-3.0			2.5	9.0	6.5
HT/VHT40, M16 to M23	3	6	-2.1	-1.7	-3.0			2.5	11.0	8.5
HT/VHT40, M0 to M7	4	12	-0.9	-4.2	-4.6	-3.2		3.1	5.0	1.9
HT/VHT40, M8 to M15	4	9	-0.9	-4.2	-4.6	-3.2		3.1	8.0	4.9
HT/VHT40, M16 to M23	4	7	-0.9	-4.2	-4.6	-3.2		3.1	10.0	6.9
HT/VHT40 Beam Forming, M0 to M7	2	9	-0.9	-4.2				0.8	8.0	7.2
HT/VHT40 Beam Forming, M8 to M15	2	6	-2.1	-1.7				1.1	11.0	9.9
HT/VHT40 Beam Forming, M0 to M7	3	11	-4.9	-8.2	-8.6			-2.1	6.0	8.1
HT/VHT40 Beam Forming, M8 to M15	3	8	-2.0	-5.1	-5.8			0.8	9.0	8.2
HT/VHT40 Beam Forming, M16 to M23	3	6	-2.1	-1.7	-3.0			2.5	11.0	8.5
HT/VHT40 Beam Forming, M0 to M7	4	12	-7.0	-10.2	-10.5	-9.2		-3.0	5.0	8.0
HT/VHT40 Beam Forming, M8 to M15	4	9	-4.9	-8.2	-8.6	-7.0		-0.9	8.0	8.9
HT/VHT40 Beam Forming, M16 to M23	4	7	-0.9	-4.2	-4.6	-3.2		3.1	10.0	6.9
HT/VHT40 STBC, M0 to M7	2	6	-2.1	-1.7				1.1	11.0	9.9
HT/VHT40 STBC, M0 to M7	3	8	-2.1	-1.7	-3.0			2.5	9.0	6.5
HT/VHT40 STBC, M0 to M7	4	9	-0.9	-4.2	-4.6	-3.2		3.1	8.0	4.9

Non HT80, 6 to 54 Mbps	1	6	-2.7					-2.7	11.0	13.7
Non HT80, 6 to 54 Mbps	2	9	-2.7	-2.9				0.2	8.0	7.8
Non HT80, 6 to 54 Mbps	3	11	-6.1	-5.4	-6.4			-1.2	6.0	7.2
Non HT80, 6 to 54 Mbps	4	12	-6.1	-5.4	-6.4	-6.1		0.0	5.0	5.0
VHT80, M0 to M9 1ss	1	6	-1.8					-1.8	11.0	12.8
VHT80, M0 to M9 1ss	2	9	-1.8	-1.4				1.4	8.0	6.6
VHT80, M0 to M9 2ss	2	6	-1.8	-1.4				1.4	11.0	9.6
VHT80, M0 to M9 1ss	3	11	-2.8	-2.6	-2.9			2.0	6.0	4.0
VHT80, M0 to M9 2ss	3	8	-2.8	-2.6	-2.9			2.0	9.0	7.0
VHT80, M0 to M9 3ss	3	6	-2.8	-2.6	-2.9			2.0	11.0	9.0
VHT80, M0 to M9 1ss	4	12	-4.2	-3.4	-4.2	-3.9		2.1	5.0	2.9
VHT80, M0 to M9 2ss	4	9	-4.2	-3.4	-4.2	-3.9		2.1	8.0	5.9
VHT80, M0 to M9 3ss	4	7	-4.2	-3.4	-4.2	-3.9		2.1	10.0	7.9
VHT80 Beam Forming, M0 to M9 1ss	2	9	-4.2	-3.4				-0.8	8.0	8.8
VHT80 Beam Forming, M0 to M9 2ss	2	6	-1.8	-1.4				1.4	11.0	9.6
VHT80 Beam Forming, M0 to M9 1ss	3	11	-4.4	-6.5	-8.4			-1.4	6.0	7.4
VHT80 Beam Forming, M0 to M9 2ss	3	8	-4.2	-3.4	-4.2			0.9	9.0	8.1
VHT80 Beam Forming, M0 to M9 3ss	3	6	-2.8	-2.6	-2.9			2.0	11.0	9.0
VHT80 Beam Forming, M0 to M9 1ss	4	12	-5.5	-8.1	-9.3	-8.0		-1.5	5.0	6.5
VHT80 Beam Forming, M0 to M9 2ss	4	9	-5.3	-5.7	-6.1	-6.2		0.2	8.0	7.8
VHT80 Beam Forming, M0 to M9 3ss	4	7	-4.2	-3.4	-4.2	-3.9		2.1	10.0	7.9
VHT80 STBC, M0 to M9 1ss	2	6	-1.8	-1.4				1.4	11.0	9.6



	VHT80 STBC, M0 to M9 1ss	3	6	-2.8	-2.6	-2.9		2.0	11.0	9.0
	VHT80 STBC, M0 to M9 1ss	4	6	-4.2	-3.4	-4.2	-3.9	2.1	11.0	8.9
5570	Non HT160, 6 to 54 Mbps	1	6	-6.5				-6.5	11.0	17.5
	Non HT160, 6 to 54 Mbps	2	9	-7.4	-6.7			-4.0	8.0	12.0
	Non HT160, 6 to 54 Mbps	3	11	-7.4	-6.7	-8.2		-2.6	6.0	8.6
	Non HT160, 6 to 54 Mbps	4	12	-7.4	-6.7	-8.2	-7.9	-1.5	5.0	6.5
	VHT160, M0 to M9 1ss	1	6	-2.6				-2.6	11.0	13.6
	VHT160, M0 to M9 1ss	2	9	-4.1	-3.7			-0.9	8.0	8.9
	VHT160, M0 to M9 2ss	2	6	-4.1	-3.7			-0.9	11.0	11.9
	VHT160, M0 to M9 1ss	3	11	-6.5	-6.0	-6.9		-1.7	6.0	7.7
	VHT160, M0 to M9 2ss	3	8	-6.5	-6.0	-6.9		-1.7	9.0	10.7
	VHT160, M0 to M9 3ss	3	6	-6.5	-6.0	-6.9		-1.7	11.0	12.7
	VHT160, M0 to M9 1ss	4	12	-6.5	-6.0	-6.9	-6.4	-0.4	5.0	5.4
	VHT160, M0 to M9 2ss	4	9	-6.5	-6.0	-6.9	-6.4	-0.4	8.0	8.4
	VHT160, M0 to M9 3ss	4	7	-6.5	-6.0	-6.9	-6.4	-0.4	10.0	10.4
	VHT160 Beam Forming, M0 to M9 1ss	2	9	-7.1	-6.7			-3.9	8.0	11.9
	VHT160 Beam Forming, M0 to M9 2ss	2	6	-4.1	-3.7			-0.9	11.0	11.9
	VHT160 Beam Forming, M0 to M9 1ss	3	11	-8.6	-11.1	-12.6		-5.7	6.0	11.7
	VHT160 Beam Forming, M0 to M9 2ss	3	8	-7.1	-6.7	-8.0		-2.5	9.0	11.5
	VHT160 Beam Forming, M0 to M9 3ss	3	6	-6.5	-6.0	-6.9		-1.7	11.0	12.7
	VHT160 Beam Forming, M0 to M9 1ss	4	12	-8.6	-11.1	-12.6	-11.3	-4.6	5.0	9.6
	VHT160 Beam Forming, M0 to M9 2ss	4	9	-7.7	-10.4	-11.3	-10.2	-3.7	8.0	11.7
	VHT160 Beam Forming, M0 to M9 3ss	4	7	-7.1	-6.7	-8.0	-7.6	-1.3	10.0	11.3
VHT160 STBC, M0 to M9 1ss	2	6	-4.1	-3.7			-0.9	11.0	11.9	
VHT160 STBC, M0 to M9 1ss	3	6	-6.5	-6.0	-6.9		-1.7	11.0	12.7	
VHT160 STBC, M0 to M9 1ss	4	6	-6.5	-6.0	-6.9	-6.4	-0.4	11.0	11.4	
5560	Non HT20, 6 to 54 Mbps	1	6	5.8				5.8	11.0	5.2
	Non HT20, 6 to 54 Mbps	2	9	4.8	4.8			7.8	8.0	0.2
	Non HT20, 6 to 54 Mbps	3	11	0.4	0.6	0.5		5.3	6.0	0.7
	Non HT20, 6 to 54 Mbps	4	12	-1.5	-1.3	-1.5	-0.8	4.8	5.0	0.2
	Non HT20 Beam Forming, 6 to 54 Mbps	2	9	4.8	4.8			7.8	8.0	0.2
	Non HT20 Beam Forming, 6 to 54 Mbps	3	11	0.4	0.6	0.5		5.3	6.0	0.7
	Non HT20 Beam Forming, 6 to 54 Mbps	4	12	-1.5	-1.3	-1.5	-0.8	4.8	5.0	0.2
	HT/VHT20, M0 to M7	1	6	5.6				5.6	11.0	5.4
	<b>HT/VHT20, M0 to M7</b>	<b>2</b>	<b>9</b>	<b>5.0</b>	<b>4.8</b>			<b>7.9</b>	<b>8.0</b>	<b>0.1</b>
	HT/VHT20, M8 to M15	2	6	5.6	6.0			8.8	11.0	2.2
	HT/VHT20, M0 to M7	3	11	0.1	0.8	0.5		5.2	6.0	0.8
	HT/VHT20, M8 to M15	3	8	3.3	3.5	3.7		8.3	9.0	0.7
	HT/VHT20, M16 to M23	3	6	5.6	6.0	6.1		10.7	11.0	0.3





	HT/VHT20, M0 to M7	4	12	-1.5	-1.6	-1.4	-0.2	4.9	5.0	0.1
	HT/VHT20, M8 to M15	4	9	1.2	1.6	1.6	2.1	7.7	8.0	0.3
	HT/VHT20, M16 to M23	4	7	3.3	3.5	3.7	4.3	9.7	10.0	0.3
	HT/VHT20 Beam Forming, M0 to M7	2	9	5.0	4.8			7.9	8.0	0.1
	HT/VHT20 Beam Forming, M8 to M15	2	6	5.6	6.0			8.8	11.0	2.2
	HT/VHT20 Beam Forming, M0 to M7	3	11	0.1	0.8	0.5		5.2	6.0	0.8
	HT/VHT20 Beam Forming, M8 to M15	3	8	3.3	3.5	3.7		8.3	9.0	0.7
	HT/VHT20 Beam Forming, M16 to M23	3	6	5.6	6.0	6.1		10.7	11.0	0.3
	HT/VHT20 Beam Forming, M0 to M7	4	12	-1.5	-1.6	-1.4	-0.2	4.9	5.0	0.1
	HT/VHT20 Beam Forming, M8 to M15	4	9	1.2	1.6	1.6	2.1	7.7	8.0	0.3
	HT/VHT20 Beam Forming, M16 to M23	4	7	3.3	3.5	3.7	4.3	9.7	10.0	0.3
	HT/VHT20 STBC, M0 to M7	2	6	5.6	6.0			8.8	11.0	2.2
	HT/VHT20 STBC, M0 to M7	3	8	3.3	3.5	3.7		8.3	9.0	0.7
	HT/VHT20 STBC, M0 to M7	4	9	1.2	1.6	1.6	2.1	7.7	8.0	0.3
5660	Non HT20, 6 to 54 Mbps	1	6	6.8				6.8	11.0	4.2
	Non HT20, 6 to 54 Mbps	2	9	4.5	4.9			7.7	8.0	0.3
	Non HT20, 6 to 54 Mbps	3	11	0.6	-0.8	-0.8		4.5	6.0	1.5
	Non HT20, 6 to 54 Mbps	4	12	-0.3	-2.0	-1.7	-1.9	4.6	5.0	0.4
	Non HT20 Beam Forming, 6 to 54 Mbps	2	9	4.5	4.9			7.7	8.0	0.3
	Non HT20 Beam Forming, 6 to 54 Mbps	3	11	0.6	-0.8	-0.8		4.5	6.0	1.5
	Non HT20 Beam Forming, 6 to 54 Mbps	4	12	-0.3	-2.0	-1.7	-1.9	4.6	5.0	0.4
	HT/VHT20, M0 to M7	1	6	6.5				6.5	11.0	4.5
	HT/VHT20, M0 to M7	2	9	4.3	4.7			7.5	8.0	0.5
	HT/VHT20, M8 to M15	2	6	6.5	7.0			9.8	11.0	1.2
	HT/VHT20, M0 to M7	3	11	0.4	-0.7	-1.0		4.4	6.0	1.6
	HT/VHT20, M8 to M15	3	8	3.1	3.6	3.6		8.2	9.0	0.8
	HT/VHT20, M16 to M23	3	6	5.3	5.8	5.8		10.4	11.0	0.6
	HT/VHT20, M0 to M7	4	12	-0.5	-1.9	-2.2	-2.1	4.4	5.0	0.6
	HT/VHT20, M8 to M15	4	9	1.5	1.8	1.7	1.0	7.5	8.0	0.5
	HT/VHT20, M16 to M23	4	7	3.1	3.6	3.6	2.8	9.3	10.0	0.7
	HT/VHT20 Beam Forming, M0 to M7	2	9	4.3	4.7			7.5	8.0	0.5
	HT/VHT20 Beam Forming, M8 to M15	2	6	6.5	7.0			9.8	11.0	1.2
	HT/VHT20 Beam Forming, M0 to M7	3	11	0.4	-0.7	-1.0		4.4	6.0	1.6
	HT/VHT20 Beam Forming, M8 to M15	3	8	3.1	3.6	3.6		8.2	9.0	0.8
	HT/VHT20 Beam Forming, M16 to M23	3	6	5.3	5.8	5.8		10.4	11.0	0.6
	HT/VHT20 Beam Forming, M0 to M7	4	12	-0.5	-1.9	-2.2	-2.1	4.4	5.0	0.6
	HT/VHT20 Beam Forming, M8 to M15	4	9	1.5	1.8	1.7	1.0	7.5	8.0	0.5
	HT/VHT20 Beam Forming, M16 to M23	4	7	3.1	3.6	3.6	2.8	9.3	10.0	0.7
HT/VHT20 STBC, M0 to M7	2	6	6.5	7.0			9.8	11.0	1.2	
HT/VHT20 STBC, M0 to M7	3	8	3.1	3.6	3.6		8.2	9.0	0.8	



	HT/VHT20 STBC, M0 to M7	4	9	1.5	1.8	1.7	1.0	7.5	8.0	0.5
5670	Non HT40, 6 to 54 Mbps	1	6	4.8				4.8	11.0	6.2
	Non HT40, 6 to 54 Mbps	2	9	4.8	4.9			7.9	8.0	0.1
	Non HT40, 6 to 54 Mbps	3	11	0.1	0.6	0.8		5.3	6.0	0.7
	Non HT40, 6 to 54 Mbps	4	12	-1.2	-1.8	-2.7	-2.5	4.0	5.0	1.0
	HT/VHT40, M0 to M7	1	6	3.7				3.7	11.0	7.3
	HT/VHT40, M0 to M7	2	9	3.7	3.9			6.8	8.0	1.2
	HT/VHT40, M8 to M15	2	6	3.7	3.9			6.8	11.0	4.2
	HT/VHT40, M0 to M7	3	11	-0.4	0.6	0.6		5.1	6.0	0.9
	HT/VHT40, M8 to M15	3	8	3.7	3.9	3.9		8.6	9.0	0.4
	HT/VHT40, M16 to M23	3	6	3.7	3.9	3.9		8.6	11.0	2.4
	HT/VHT40, M0 to M7	4	12	-2.0	-1.4	-1.3	-2.1	4.3	5.0	0.7
	HT/VHT40, M8 to M15	4	9	1.0	1.5	1.7	0.9	7.3	8.0	0.7
	HT/VHT40, M16 to M23	4	7	3.7	3.9	3.9	3.3	9.7	10.0	0.3
	HT/VHT40 Beam Forming, M0 to M7	2	9	3.7	3.9			6.8	8.0	1.2
	HT/VHT40 Beam Forming, M8 to M15	2	6	3.7	3.9			6.8	11.0	4.2
	HT/VHT40 Beam Forming, M0 to M7	3	11	-0.4	0.6	0.6		5.1	6.0	0.9
	HT/VHT40 Beam Forming, M8 to M15	3	8	3.7	3.9	3.9		8.6	9.0	0.4
	HT/VHT40 Beam Forming, M16 to M23	3	6	3.7	3.9	3.9		8.6	11.0	2.4
	HT/VHT40 Beam Forming, M0 to M7	4	12	-2.0	-1.4	-1.3	-2.1	4.3	5.0	0.7
	HT/VHT40 Beam Forming, M8 to M15	4	9	1.0	1.5	1.7	0.9	7.3	8.0	0.7
	HT/VHT40 Beam Forming, M16 to M23	4	7	3.7	3.9	3.9	3.3	9.7	10.0	0.3
HT/VHT40 STBC, M0 to M7	2	6	3.7	3.9			6.8	11.0	4.2	
HT/VHT40 STBC, M0 to M7	3	8	3.7	3.9	3.9		8.6	9.0	0.4	
HT/VHT40 STBC, M0 to M7	4	9	1.0	1.5	1.7	0.9	7.3	8.0	0.7	
5690	Non HT80, 6 to 54 Mbps	1	6	-0.8				-0.8	11.0	11.8
	Non HT80, 6 to 54 Mbps	2	9	-0.8	-0.1			2.6	8.0	5.4
	Non HT80, 6 to 54 Mbps	3	11	-0.8	-0.1	0.2		4.6	6.0	1.4
	Non HT80, 6 to 54 Mbps	4	12	-1.5	-1.0	-0.8	-2.0	4.7	5.0	0.3
	VHT80, M0 to M9 1ss	1	6	-0.5				-0.5	11.0	11.5
	VHT80, M0 to M9 1ss	2	9	-0.5	-0.3			2.6	8.0	5.4
	VHT80, M0 to M9 2ss	2	6	-0.5	-0.3			2.6	11.0	8.4
	VHT80, M0 to M9 1ss	3	11	-0.5	-0.3	-0.3		4.4	6.0	1.6
	VHT80, M0 to M9 2ss	3	8	-0.5	-0.3	-0.3		4.4	9.0	4.6
	VHT80, M0 to M9 3ss	3	6	-0.5	-0.3	-0.3		4.4	11.0	6.6
	VHT80, M0 to M9 1ss	4	12	-1.8	-1.5	-1.4	-0.8	4.7	5.0	0.3
	VHT80, M0 to M9 2ss	4	9	-0.5	-0.3	-0.3	-0.7	5.6	8.0	2.4
	VHT80, M0 to M9 3ss	4	7	-0.5	-0.3	-0.3	-0.7	5.6	10.0	4.4
	VHT80 Beam Forming, M0 to M9 1ss	2	9	-0.5	-0.3			2.6	8.0	5.4



	VHT80 Beam Forming, M0 to M9 2ss	2	6	-0.5	-0.3			2.6	11.0	8.4
	VHT80 Beam Forming, M0 to M9 1ss	3	11	-2.9	-2.6	-2.1		2.3	6.0	3.7
	VHT80 Beam Forming, M0 to M9 2ss	3	8	-0.5	-0.3	-0.3		4.4	9.0	4.6
	VHT80 Beam Forming, M0 to M9 3ss	3	6	-0.5	-0.3	-0.3		4.4	11.0	6.6
	VHT80 Beam Forming, M0 to M9 1ss	4	12	-6.1	-5.4	-5.5	-6.3	0.2	5.0	4.8
	VHT80 Beam Forming, M0 to M9 2ss	4	9	-2.9	-2.6	-2.1	-3.0	3.4	8.0	4.6
	VHT80 Beam Forming, M0 to M9 3ss	4	7	-0.5	-0.3	-0.3	-0.7	5.6	10.0	4.4
	VHT80 STBC, M0 to M9 1ss	2	6	-0.5	-0.3			2.6	11.0	8.4
	VHT80 STBC, M0 to M9 1ss	3	6	-0.5	-0.3	-0.3		4.4	11.0	6.6
	VHT80 STBC, M0 to M9 1ss	4	6	-0.5	-0.3	-0.3	-0.7	5.6	11.0	5.4
5700	Non HT20, 6 to 54 Mbps	1	6	4.7				4.7	11.0	6.3
	Non HT20, 6 to 54 Mbps	2	9	4.7	5.1			7.9	8.0	0.1
	Non HT20, 6 to 54 Mbps	3	11	0.2	1.1	0.6		5.4	6.0	0.6
	Non HT20, 6 to 54 Mbps	4	12	-0.9	-1.0	-2.0	-2.9	4.4	5.0	0.6
	Non HT20 Beam Forming, 6 to 54 Mbps	2	9	4.7	5.1			7.9	8.0	0.1
	Non HT20 Beam Forming, 6 to 54 Mbps	3	11	0.2	1.1	0.6		5.4	6.0	0.6
	Non HT20 Beam Forming, 6 to 54 Mbps	4	12	-0.9	-1.0	-2.0	-2.9	4.4	5.0	0.6
	HT/VHT20, M0 to M7	1	6	4.6				4.6	11.0	6.4
	HT/VHT20, M0 to M7	2	9	4.6	5.1			7.9	8.0	0.1
	HT/VHT20, M8 to M15	2	6	4.6	5.1			7.9	11.0	3.1
	HT/VHT20, M0 to M7	3	11	0.2	1.0	0.7		5.4	6.0	0.6
	HT/VHT20, M8 to M15	3	8	3.7	4.0	4.0		8.7	9.0	0.3
	HT/VHT20, M16 to M23	3	6	4.6	5.1	5.3		9.8	11.0	1.2
	HT/VHT20, M0 to M7	4	12	-1.0	-0.6	-2.2	-2.7	4.5	5.0	0.5
	HT/VHT20, M8 to M15	4	9	0.2	1.0	0.7	1.7	7.0	8.0	1.0
	HT/VHT20, M16 to M23	4	7	2.8	3.1	3.0	3.9	9.2	10.0	0.8
	HT/VHT20 Beam Forming, M0 to M7	2	9	4.6	5.1			7.9	8.0	0.1
	HT/VHT20 Beam Forming, M8 to M15	2	6	4.6	5.1			7.9	11.0	3.1
	HT/VHT20 Beam Forming, M0 to M7	3	11	0.2	1.0	0.7		5.4	6.0	0.6
	HT/VHT20 Beam Forming, M8 to M15	3	8	3.7	4.0	4.0		8.7	9.0	0.3
	HT/VHT20 Beam Forming, M16 to M23	3	6	4.6	5.1	5.3		9.8	11.0	1.2
	HT/VHT20 Beam Forming, M0 to M7	4	12	-1.0	-0.6	-2.2	-2.7	4.5	5.0	0.5
	HT/VHT20 Beam Forming, M8 to M15	4	9	0.2	1.0	0.7	1.7	7.0	8.0	1.0
	HT/VHT20 Beam Forming, M16 to M23	4	7	2.8	3.1	3.0	3.9	9.2	10.0	0.8
	HT/VHT20 STBC, M0 to M7	2	6	4.6	5.1			7.9	11.0	3.1
	HT/VHT20 STBC, M0 to M7	3	8	3.7	4.0	4.0		8.7	9.0	0.3
HT/VHT20 STBC, M0 to M7	4	9	0.2	1.0	0.7	1.7	7.0	8.0	1.0	



5710	Non HT40, 6 to 54 Mbps	1	6	2.9				2.9	11.0	8.1
	Non HT40, 6 to 54 Mbps	2	9	2.9	3.0			6.0	8.0	2.0
	Non HT40, 6 to 54 Mbps	3	11	0.9	1.1	1.4		5.9	6.0	0.1
	Non HT40, 6 to 54 Mbps	4	12	-2.3	-1.7	-2.0	-0.7	4.4	5.0	0.6
	HT/VHT40, M0 to M7	1	6	1.3				1.3	11.0	9.7
	HT/VHT40, M0 to M7	2	9	1.3	1.9			4.6	8.0	3.4
	HT/VHT40, M8 to M15	2	6	1.3	1.9			4.6	11.0	6.4
	HT/VHT40, M0 to M7	3	11	0.2	1.3	0.6		5.5	6.0	0.5
	HT/VHT40, M8 to M15	3	8	1.3	1.9	1.8		6.4	9.0	2.6
	HT/VHT40, M16 to M23	3	6	1.3	1.9	1.8		6.4	11.0	4.6
	HT/VHT40, M0 to M7	4	12	-2.2	-1.3	-1.5	-0.3	4.7	5.0	0.3
	HT/VHT40, M8 to M15	4	9	0.2	1.3	0.6	3.2	7.5	8.0	0.5
	HT/VHT40, M16 to M23	4	7	1.3	1.9	1.8	3.2	8.1	10.0	1.9
	HT/VHT40 Beam Forming, M0 to M7	2	9	1.3	1.9			4.6	8.0	3.4
	HT/VHT40 Beam Forming, M8 to M15	2	6	1.3	1.9			4.6	11.0	6.4
	HT/VHT40 Beam Forming, M0 to M7	3	11	-0.7	-0.3	-0.6		4.2	6.0	1.8
	HT/VHT40 Beam Forming, M8 to M15	3	8	1.3	1.9	1.8		6.4	9.0	2.6
	HT/VHT40 Beam Forming, M16 to M23	3	6	1.3	1.9	1.8		6.4	11.0	4.6
	HT/VHT40 Beam Forming, M0 to M7	4	12	-2.9	-2.2	-2.2	-1.2	3.9	5.0	1.1
	HT/VHT40 Beam Forming, M8 to M15	4	9	0.2	0.8	0.4	2.0	6.9	8.0	1.1
	HT/VHT40 Beam Forming, M16 to M23	4	7	1.3	1.9	1.8	3.2	8.1	10.0	1.9
HT/VHT40 STBC, M0 to M7	2	6	1.3	1.9			4.6	11.0	6.4	
HT/VHT40 STBC, M0 to M7	3	8	1.3	1.9	1.8		6.4	9.0	2.6	
HT/VHT40 STBC, M0 to M7	4	9	0.2	1.3	0.6	3.2	7.5	8.0	0.5	
5720	Non HT20, 6 to 54 Mbps	1	6	4.5				4.5	11.0	6.5
	Non HT20, 6 to 54 Mbps	2	9	3.4	4.1			6.8	8.0	1.2
	Non HT20, 6 to 54 Mbps	3	11	0.6	1.0	0.1		5.4	6.0	0.6
	Non HT20, 6 to 54 Mbps	4	12	-1.7	-0.7	-2.0	-0.2	4.9	5.0	0.1
	Non HT20 Beam Forming, 6 to 54 Mbps	2	9	3.4	4.1			6.8	8.0	1.2
	Non HT20 Beam Forming, 6 to 54 Mbps	3	11	0.6	1.0	0.1		5.4	6.0	0.6
	Non HT20 Beam Forming, 6 to 54 Mbps	4	12	-1.7	-0.7	-2.0	-0.2	4.9	5.0	0.1
	HT/VHT20, M0 to M7	1	6	4.4				4.4	11.0	6.6
	HT/VHT20, M0 to M7	2	9	4.4	5.3			7.9	8.0	0.1
	HT/VHT20, M8 to M15	2	6	4.4	5.3			7.9	11.0	3.1
	HT/VHT20, M0 to M7	3	11	1.3	1.5	0.5		5.9	6.0	0.1
	HT/VHT20, M8 to M15	3	8	3.6	3.9	3.0		8.3	9.0	0.7
	HT/VHT20, M16 to M23	3	6	4.4	5.3	4.2		9.4	11.0	1.6
	HT/VHT20, M0 to M7	4	12	-1.8	-0.9	-2.2	0.1	4.9	5.0	0.1
	HT/VHT20, M8 to M15	4	9	1.3	1.5	0.5	3.0	7.7	8.0	0.3
HT/VHT20, M16 to M23	4	7	2.2	3.1	2.2	4.1	9.0	10.0	1.0	



HT/VHT20 Beam Forming, M0 to M7	2	9	4.4	5.3			7.9	8.0	0.1
HT/VHT20 Beam Forming, M8 to M15	2	6	4.4	5.3			7.9	11.0	3.1
HT/VHT20 Beam Forming, M0 to M7	3	11	1.3	1.5	0.5		5.9	6.0	0.1
HT/VHT20 Beam Forming, M8 to M15	3	8	3.6	3.9	3.0		8.3	9.0	0.7
HT/VHT20 Beam Forming, M16 to M23	3	6	4.4	5.3	4.2		9.4	11.0	1.6
HT/VHT20 Beam Forming, M0 to M7	4	12	-1.8	-0.9	-2.2	0.1	4.9	5.0	0.1
HT/VHT20 Beam Forming, M8 to M15	4	9	1.3	1.5	0.5	3.0	7.7	8.0	0.3
HT/VHT20 Beam Forming, M16 to M23	4	7	2.2	3.1	2.2	4.1	9.0	10.0	1.0
HT/VHT20 STBC, M0 to M7	2	6	4.4	5.3			7.9	11.0	3.1
HT/VHT20 STBC, M0 to M7	3	8	3.6	3.9	3.0		8.3	9.0	0.7
HT/VHT20 STBC, M0 to M7	4	9	1.3	1.5	0.5	3.0	7.7	8.0	0.3



**Peak Output Power, 5670 MHz, HT/VHT40 Beam Forming, M16 to M23**

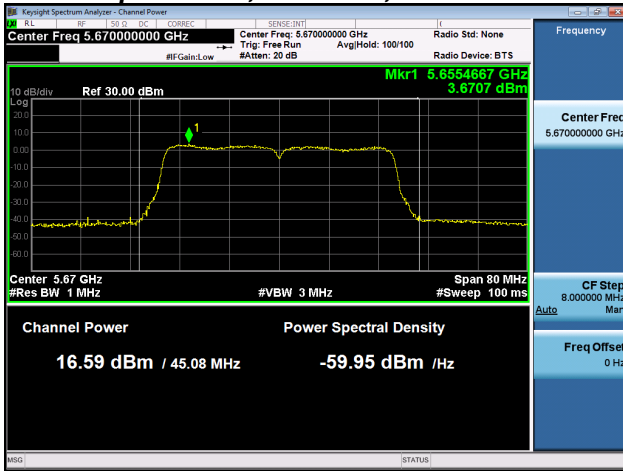

**Antenna A**

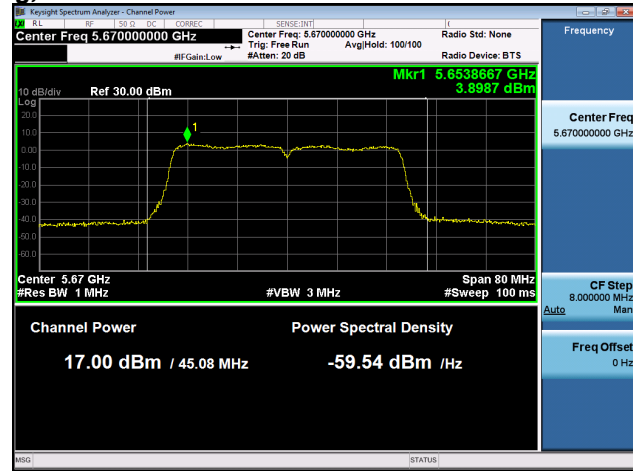

**Antenna B**

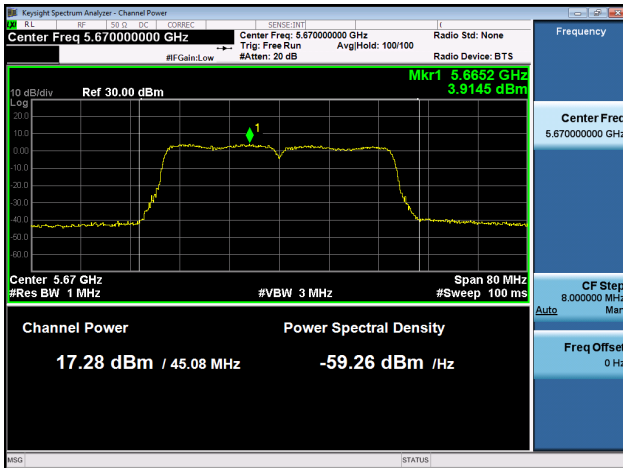

**Antenna C**

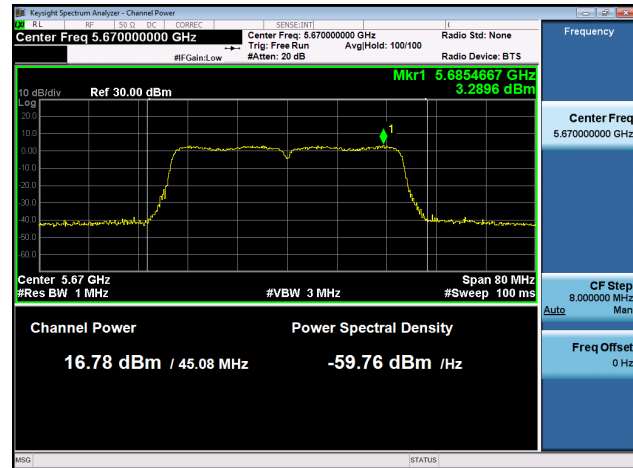

**Antenna D**



**Power Spectral Density, 5720 MHz, Non HT20, 6 to 54 Mbps**

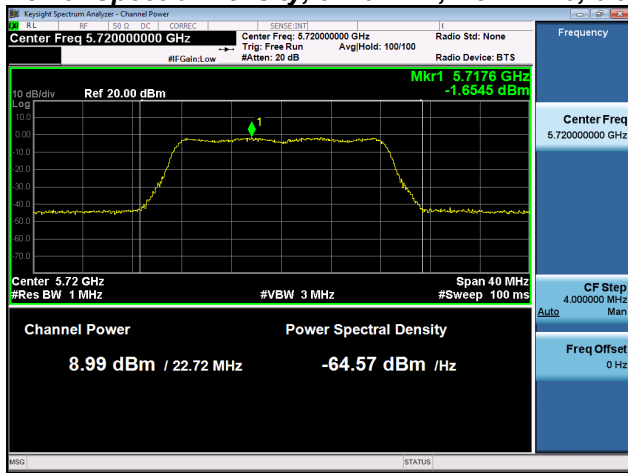

**Antenna A**

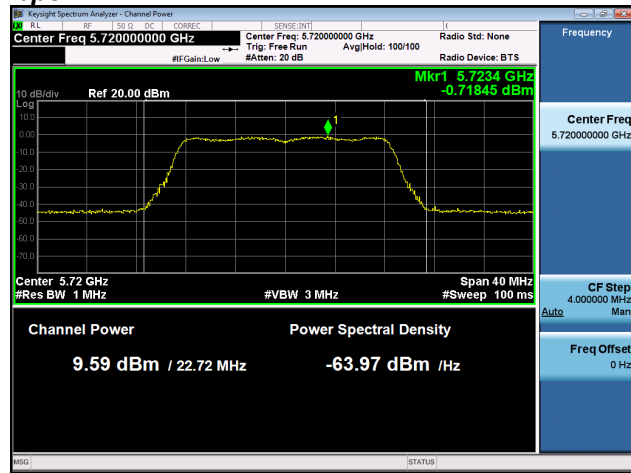

**Antenna B**

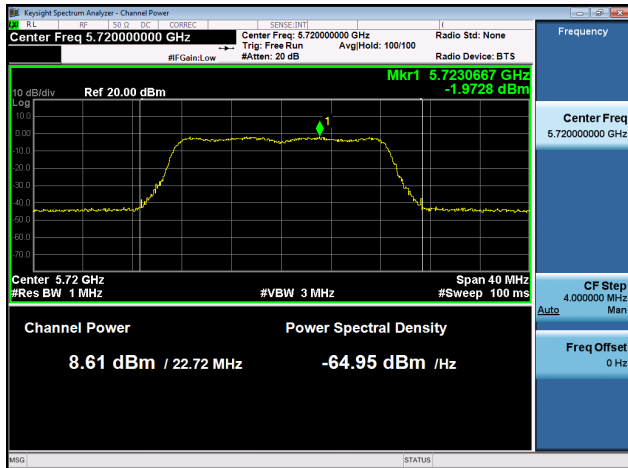

**Antenna C**

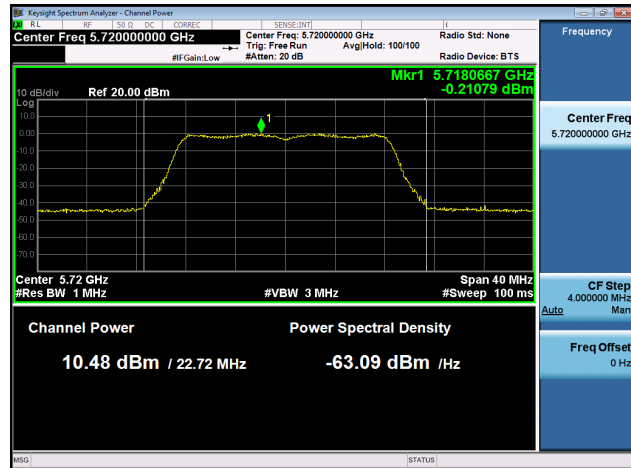

**Antenna D**



**Antenna Gain : 8 dBi**

Frequency (MHz)	Mode	Tx Paths	Correlated Antenna Gain (dBi)	Tx 1 Max Power (dBm)	Tx 2 Max Power (dBm)	Tx 3 Max Power (dBm)	Tx 4 Max Power (dBm)	Total Tx Channel Power (dBm)	Limit (dBm)	Margin (dB)	
5500	Non HT20, 6 to 54 Mbps	1	8	16.0				16.0	21.6	5.6	
	Non HT20, 6 to 54 Mbps	2	8	12.5	12.7			15.6	21.6	6.0	
	Non HT20, 6 to 54 Mbps	3	8	11.1	7.1	7.3		13.7	21.6	7.9	
	Non HT20, 6 to 54 Mbps	4	8	9.0	5.2	5.3	6.8	12.9	21.6	8.7	
	Non HT20 Beam Forming, 6 to 54 Mbps	2	11	11.5	11.8			14.7	18.6	3.9	
	Non HT20 Beam Forming, 6 to 54 Mbps	3	13	9.9	6.2	6.3		12.6	16.6	4.0	
	Non HT20 Beam Forming, 6 to 54 Mbps	4	14	8.0	4.3	4.2	5.8	11.9	15.6	3.7	
	HT/VHT20, M0 to M7	1	8	17.4				17.4	21.6	4.2	
	HT/VHT20, M0 to M7	2	8	12.7	13.0			15.9	21.6	5.7	
	HT/VHT20, M8 to M15	2	8	14.8	15.2			18.0	21.6	3.6	
	HT/VHT20, M0 to M7	3	8	11.2	7.2	7.4		13.8	21.6	7.8	
	HT/VHT20, M8 to M15	3	8	12.7	13.0	11.7		17.3	21.6	4.3	
	HT/VHT20, M16 to M23	3	8	13.6	13.9	12.7		18.2	21.6	3.4	
	HT/VHT20, M0 to M7	4	8	9.1	5.3	5.3	6.9	13.0	21.6	8.6	
	HT/VHT20, M8 to M15	4	8	12.1	8.3	8.4	9.8	16.0	21.6	5.6	
	HT/VHT20, M16 to M23	4	8	12.7	13.0	11.7	11.3	18.3	21.6	3.3	
	HT/VHT20 Beam Forming, M0 to M7	2	11	11.7	12.0			14.9	18.6	3.7	
	HT/VHT20 Beam Forming, M8 to M15	2	8	14.8	15.2			18.0	21.6	3.6	
	HT/VHT20 Beam Forming, M0 to M7	3	13	10.0	6.4	6.4		12.7	16.6	3.9	
	HT/VHT20 Beam Forming, M8 to M15	3	10	11.7	12.0	10.8		16.3	19.6	3.3	
	HT/VHT20 Beam Forming, M16 to M23	3	8	13.6	13.9	12.7		18.2	21.6	3.4	
	HT/VHT20 Beam Forming, M0 to M7	4	14	8.1	4.4	4.4	5.9	12.0	15.6	3.6	
	HT/VHT20 Beam Forming, M8 to M15	4	11	11.2	7.2	7.4	9.0	15.0	18.6	3.6	
	HT/VHT20 Beam Forming, M16 to M23	4	9	11.7	12.0	10.8	10.3	17.3	20.6	3.3	
	HT/VHT20 STBC, M0 to M7	2	8	14.8	15.2			18.0	21.6	3.6	
	HT/VHT20 STBC, M0 to M7	3	8	12.7	13.0	11.7		17.3	21.6	4.3	
	HT/VHT20 STBC, M0 to M7	4	8	12.1	8.3	8.4	9.8	16.0	21.6	5.6	
	5510	Non HT40, 6 to 54 Mbps	1	8	10.6				10.6	22.0	11.4
		Non HT40, 6 to 54 Mbps	2	8	6.7	3.9			8.5	22.0	13.5
		Non HT40, 6 to 54 Mbps	3	8	5.8	2.9	2.5		8.8	22.0	13.2
Non HT40, 6 to 54 Mbps		4	8	4.6	1.9	1.3	2.3	8.7	22.0	13.3	
HT/VHT40, M0 to M7		1	8	14.2				14.2	22.0	7.8	





	HT/VHT40, M0 to M7	2	8	12.3	9.6			14.2	22.0	7.8
	HT/VHT40, M8 to M15	2	8	12.3	9.6			14.2	22.0	7.8
	HT/VHT40, M0 to M7	3	8	11.3	8.7	8.0		14.3	22.0	7.7
	HT/VHT40, M8 to M15	3	8	11.3	8.7	8.0		14.3	22.0	7.7
	HT/VHT40, M16 to M23	3	8	11.3	8.7	8.0		14.3	22.0	7.7
	HT/VHT40, M0 to M7	4	8	10.3	7.8	7.0	8.4	14.6	22.0	7.4
	HT/VHT40, M8 to M15	4	8	10.3	7.8	7.0	8.4	14.6	22.0	7.4
	HT/VHT40, M16 to M23	4	8	10.3	7.8	7.0	8.4	14.6	22.0	7.4
	HT/VHT40 Beam Forming, M0 to M7	2	11	8.4	5.5			10.2	19.0	8.8
	HT/VHT40 Beam Forming, M8 to M15	2	8	12.3	9.6			14.2	22.0	7.8
	HT/VHT40 Beam Forming, M0 to M7	3	13	6.5	3.6	3.2		9.5	17.0	7.5
	HT/VHT40 Beam Forming, M8 to M15	3	10	8.4	5.5	5.1		11.4	20.0	8.6
	HT/VHT40 Beam Forming, M16 to M23	3	8	11.3	8.7	8.0		14.3	22.0	7.7
	HT/VHT40 Beam Forming, M0 to M7	4	14	3.4	0.6	0.1	1.1	7.5	16.0	8.5
	HT/VHT40 Beam Forming, M8 to M15	4	11	7.5	4.5	4.2	5.2	11.6	19.0	7.4
	HT/VHT40 Beam Forming, M16 to M23	4	9	8.4	5.5	5.1	6.1	12.5	21.0	8.5
	HT/VHT40 STBC, M0 to M7	2	8	12.3	9.6			14.2	22.0	7.8
	HT/VHT40 STBC, M0 to M7	3	8	11.3	8.7	8.0		14.3	22.0	7.7
	HT/VHT40 STBC, M0 to M7	4	8	10.3	7.8	7.0	8.4	14.6	22.0	7.4
530	Non HT80, 6 to 54 Mbps	1	8	13.4				13.4	22.0	8.6
	Non HT80, 6 to 54 Mbps	2	8	9.2	9.4			12.3	22.0	9.7
	Non HT80, 6 to 54 Mbps	3	8	10.0	8.4	8.5		13.8	22.0	8.2
	Non HT80, 6 to 54 Mbps	4	8	9.1	8.5	7.5	7.6	14.2	22.0	7.8
	VHT80, M0 to M9 1ss	1	8	15.1				15.1	22.0	6.9
	VHT80, M0 to M9 1ss	2	8	13.9	14.2			17.1	22.0	4.9
	VHT80, M0 to M9 2ss	2	8	13.9	14.2			17.1	22.0	4.9
	VHT80, M0 to M9 1ss	3	8	12.7	13.0	13.0		17.7	22.0	4.3
	VHT80, M0 to M9 2ss	3	8	12.7	13.0	13.0		17.7	22.0	4.3
	VHT80, M0 to M9 3ss	3	8	12.7	13.0	13.0		17.7	22.0	4.3
	VHT80, M0 to M9 1ss	4	8	12.7	13.0	13.0	12.5	18.8	22.0	3.2
	VHT80, M0 to M9 2ss	4	8	12.7	13.0	13.0	12.5	18.8	22.0	3.2
	VHT80, M0 to M9 3ss	4	8	12.7	13.0	13.0	12.5	18.8	22.0	3.2
	VHT80 Beam Forming, M0 to M9 1ss	2	11	10.8	11.1			14.0	19.0	5.0
	VHT80 Beam Forming, M0 to M9 2ss	2	8	13.9	14.2			17.1	22.0	4.9
	VHT80 Beam Forming, M0 to M9 1ss	3	13	10.7	9.0	8.0		14.2	17.0	2.8
	VHT80 Beam Forming, M0 to M9 2ss	3	10	10.8	11.1	11.1		15.8	20.0	4.2
	VHT80 Beam Forming, M0 to M9 3ss	3	8	12.7	13.0	13.0		17.7	22.0	4.3
	VHT80 Beam Forming, M0 to M9 1ss	4	14	8.5	7.0	5.9	6.1	13.0	16.0	3.0
	VHT80 Beam Forming, M0 to M9 2ss	4	11	11.6	10.0	9.0	9.0	16.1	19.0	2.9
VHT80 Beam Forming, M0 to M9 3ss	4	9	10.8	11.1	11.1	10.6	16.9	21.0	4.1	



	VHT80 STBC, M0 to M9 1ss	2	8	13.9	14.2			17.1	22.0	4.9
	VHT80 STBC, M0 to M9 1ss	3	8	12.7	13.0	13.0		17.7	22.0	4.3
	VHT80 STBC, M0 to M9 1ss	4	8	12.7	13.0	13.0	12.5	18.8	22.0	3.2
5570	Non HT160, 6 to 54 Mbps	1	8	12.1				12.1	22.0	9.9
	Non HT160, 6 to 54 Mbps	2	8	5.5	5.2			8.4	22.0	13.6
	Non HT160, 6 to 54 Mbps	3	8	5.5	5.2	4.2		9.8	22.0	12.2
	Non HT160, 6 to 54 Mbps	4	8	5.5	5.2	4.2	4.3	10.9	22.0	11.1
	VHT160, M0 to M9 1ss	1	8	16.0				16.0	22.0	6.0
	VHT160, M0 to M9 1ss	2	8	12.7	13.2			16.0	22.0	6.0
	VHT160, M0 to M9 2ss	2	8	12.7	13.2			16.0	22.0	6.0
	VHT160, M0 to M9 1ss	3	8	11.8	12.3	11.7		16.7	22.0	5.3
	VHT160, M0 to M9 2ss	3	8	11.8	12.3	11.7		16.7	22.0	5.3
	VHT160, M0 to M9 3ss	3	8	11.8	12.3	11.7		16.7	22.0	5.3
	VHT160, M0 to M9 1ss	4	8	11.0	9.8	8.5	8.6	15.6	22.0	6.4
	VHT160, M0 to M9 2ss	4	8	11.0	9.8	8.5	8.6	15.6	22.0	6.4
	VHT160, M0 to M9 3ss	4	8	11.0	9.8	8.5	8.6	15.6	22.0	6.4
	VHT160 Beam Forming, M0 to M9 1ss	2	11	11.0	9.8			13.5	19.0	5.5
	VHT160 Beam Forming, M0 to M9 2ss	2	8	12.7	13.2			16.0	22.0	6.0
	VHT160 Beam Forming, M0 to M9 1ss	3	13	10.1	8.6	7.6		13.7	17.0	3.3
	VHT160 Beam Forming, M0 to M9 2ss	3	10	11.0	9.8	8.5		14.7	20.0	5.3
	VHT160 Beam Forming, M0 to M9 3ss	3	8	11.8	12.3	11.7		16.7	22.0	5.3
	VHT160 Beam Forming, M0 to M9 1ss	4	14	8.0	6.5	5.4	5.7	12.5	16.0	3.5
	VHT160 Beam Forming, M0 to M9 2ss	4	11	10.1	8.6	7.6	7.7	14.6	19.0	4.4
	VHT160 Beam Forming, M0 to M9 3ss	4	9	11.0	9.8	8.5	8.6	15.6	21.0	5.4
VHT160 STBC, M0 to M9 1ss	2	8	12.7	13.2			16.0	22.0	6.0	
VHT160 STBC, M0 to M9 1ss	3	8	11.8	12.3	11.7		16.7	22.0	5.3	
VHT160 STBC, M0 to M9 1ss	4	8	11.0	9.8	8.5	8.6	15.6	22.0	6.4	
5560	Non HT20, 6 to 54 Mbps	1	8	16.2				16.2	21.6	5.4
	Non HT20, 6 to 54 Mbps	2	8	12.7	13.0			15.9	21.6	5.7
	Non HT20, 6 to 54 Mbps	3	8	8.8	9.1	9.2		13.8	21.6	7.8
	Non HT20, 6 to 54 Mbps	4	8	6.6	7.1	7.2	7.5	13.1	21.6	8.5
	Non HT20 Beam Forming, 6 to 54 Mbps	2	11	12.7	13.0			15.9	18.6	2.7
	Non HT20 Beam Forming, 6 to 54 Mbps	3	13	8.8	9.1	9.2		13.8	16.6	2.8
	Non HT20 Beam Forming, 6 to 54 Mbps	4	14	6.6	7.1	7.2	7.5	13.1	15.6	2.5
	HT/VHT20, M0 to M7	1	8	16.4				16.4	21.6	5.2
	HT/VHT20, M0 to M7	2	8	12.9	13.1			16.0	21.6	5.6
	HT/VHT20, M8 to M15	2	8	16.4	16.7			19.6	21.6	2.0
	HT/VHT20, M0 to M7	3	8	9.0	9.3	9.4		14.0	21.6	7.6
	HT/VHT20, M8 to M15	3	8	11.9	12.2	12.3		16.9	21.6	4.7



	HT/VHT20, M16 to M23	3	8	14.0	14.4	14.6		19.1	21.6	2.5
	HT/VHT20, M0 to M7	4	8	6.8	7.3	7.4	7.6	13.3	21.6	8.3
	HT/VHT20, M8 to M15	4	8	10.0	10.3	10.5	10.9	16.5	21.6	5.1
	HT/VHT20, M16 to M23	4	8	11.9	12.2	12.3	12.9	18.4	21.6	3.2
	HT/VHT20 Beam Forming, M0 to M7	2	11	12.9	13.1			16.0	18.6	2.6
	HT/VHT20 Beam Forming, M8 to M15	2	8	16.4	16.7			19.6	21.6	2.0
	HT/VHT20 Beam Forming, M0 to M7	3	13	9.0	9.3	9.4		14.0	16.6	2.6
	HT/VHT20 Beam Forming, M8 to M15	3	10	11.9	12.2	12.3		16.9	19.6	2.7
	HT/VHT20 Beam Forming, M16 to M23	3	8	14.0	14.4	14.6		19.1	21.6	2.5
	HT/VHT20 Beam Forming, M0 to M7	4	14	6.8	7.3	7.4	7.6	13.3	15.6	2.3
	HT/VHT20 Beam Forming, M8 to M15	4	11	10.0	10.3	10.5	10.9	16.5	18.6	2.1
	HT/VHT20 Beam Forming, M16 to M23	4	9	11.9	12.2	12.3	12.9	18.4	20.6	2.2
	HT/VHT20 STBC, M0 to M7	2	8	16.4	16.7			19.6	21.6	2.0
	HT/VHT20 STBC, M0 to M7	3	8	11.9	12.2	12.3		16.9	21.6	4.7
	HT/VHT20 STBC, M0 to M7	4	8	10.0	10.3	10.5	10.9	16.5	21.6	5.1
5660	Non HT20, 6 to 54 Mbps	1	8	17.1				17.1	21.6	4.5
	Non HT20, 6 to 54 Mbps	2	8	12.7	13.2			16.0	21.6	5.6
	Non HT20, 6 to 54 Mbps	3	8	10.2	8.6	8.7		14.0	21.6	7.6
	Non HT20, 6 to 54 Mbps	4	8	8.0	6.5	6.6	6.5	13.0	21.6	8.6
	Non HT20 Beam Forming, 6 to 54 Mbps	2	11	12.7	13.2			16.0	18.6	2.6
	Non HT20 Beam Forming, 6 to 54 Mbps	3	13	10.2	8.6	8.7		14.0	16.6	2.6
	Non HT20 Beam Forming, 6 to 54 Mbps	4	14	8.0	6.5	6.6	6.5	13.0	15.6	2.6
	HT/VHT20, M0 to M7	1	8	17.3				17.3	21.6	4.3
	HT/VHT20, M0 to M7	2	8	12.7	13.3			16.0	21.6	5.6
	HT/VHT20, M8 to M15	2	8	16.1	16.6			19.4	21.6	2.2
	HT/VHT20, M0 to M7	3	8	10.3	8.8	8.7		14.1	21.6	7.5
	HT/VHT20, M8 to M15	3	8	11.8	12.3	12.5		17.0	21.6	4.6
	HT/VHT20, M16 to M23	3	8	13.7	14.3	14.3		18.9	21.6	2.7
	HT/VHT20, M0 to M7	4	8	8.1	6.6	6.8	6.6	13.1	21.6	8.5
	HT/VHT20, M8 to M15	4	8	11.3	9.8	9.9	9.5	16.2	21.6	5.4
	HT/VHT20, M16 to M23	4	8	11.8	12.3	12.5	11.7	18.1	21.6	3.5
	HT/VHT20 Beam Forming, M0 to M7	2	11	12.7	13.3			16.0	18.6	2.6
	HT/VHT20 Beam Forming, M8 to M15	2	8	16.1	16.6			19.4	21.6	2.2
	HT/VHT20 Beam Forming, M0 to M7	3	13	10.3	8.8	8.7		14.1	16.6	2.5
	HT/VHT20 Beam Forming, M8 to M15	3	10	11.8	12.3	12.5		17.0	19.6	2.6
	HT/VHT20 Beam Forming, M16 to M23	3	8	13.7	14.3	14.3		18.9	21.6	2.7
	HT/VHT20 Beam Forming, M0 to M7	4	14	8.1	6.6	6.8	6.6	13.1	15.6	2.5
	HT/VHT20 Beam Forming, M8 to M15	4	11	11.3	9.8	9.9	9.5	16.2	18.6	2.4
HT/VHT20 Beam Forming, M16 to M23	4	9	11.8	12.3	12.5	11.7	18.1	20.6	2.5	
HT/VHT20 STBC, M0 to M7	2	8	16.1	16.6			19.4	21.6	2.2	



	HT/VHT20 STBC, M0 to M7	3	8	11.8	12.3	12.5		17.0	21.6	4.6
	HT/VHT20 STBC, M0 to M7	4	8	11.3	9.8	9.9	9.5	16.2	21.6	5.4
5670	Non HT40, 6 to 54 Mbps	1	8	17.7				17.7	22.0	4.3
	Non HT40, 6 to 54 Mbps	2	8	15.5	15.9			18.7	22.0	3.3
	Non HT40, 6 to 54 Mbps	3	8	12.1	11.4	10.7		16.2	22.0	5.8
	Non HT40, 6 to 54 Mbps	4	8	11.1	10.5	9.8	9.7	16.3	22.0	5.7
	HT/VHT40, M0 to M7	1	8	16.6				16.6	22.0	5.4
	HT/VHT40, M0 to M7	2	8	15.4	15.8			18.6	22.0	3.4
	HT/VHT40, M8 to M15	2	8	16.6	17.0			19.8	22.0	2.2
	HT/VHT40, M0 to M7	3	8	11.1	11.9	12.1		16.5	22.0	5.5
	HT/VHT40, M8 to M15	3	8	14.2	14.8	15.1		19.5	22.0	2.5
	HT/VHT40, M16 to M23	3	8	16.6	17.0	17.3		21.7	22.0	0.3
	HT/VHT40, M0 to M7	4	8	11.0	10.2	9.5	9.3	16.1	22.0	5.9
	HT/VHT40, M8 to M15	4	8	12.1	12.8	13.1	12.5	18.7	22.0	3.3
	HT/VHT40, M16 to M23	4	8	14.2	14.8	15.1	14.6	20.7	22.0	1.3
	HT/VHT40 Beam Forming, M0 to M7	2	11	15.4	15.8			18.6	19.0	0.4
	HT/VHT40 Beam Forming, M8 to M15	2	8	16.6	17.0			19.8	22.0	2.2
	HT/VHT40 Beam Forming, M0 to M7	3	13	11.1	11.9	12.1		16.5	17.0	0.5
	HT/VHT40 Beam Forming, M8 to M15	3	10	14.2	14.8	15.1		19.5	20.0	0.5
	HT/VHT40 Beam Forming, M16 to M23	3	8	16.6	17.0	17.3		21.7	22.0	0.3
	HT/VHT40 Beam Forming, M0 to M7	4	14	9.9	9.3	8.4	8.3	15.0	16.0	1.0
	HT/VHT40 Beam Forming, M8 to M15	4	11	12.1	12.8	13.1	12.5	18.7	19.0	0.3
	HT/VHT40 Beam Forming, M16 to M23	4	9	14.2	14.8	15.1	14.6	20.7	21.0	0.3
HT/VHT40 STBC, M0 to M7	2	8	16.6	17.0			19.8	22.0	2.2	
HT/VHT40 STBC, M0 to M7	3	8	14.2	14.8	15.1		19.5	22.0	2.5	
HT/VHT40 STBC, M0 to M7	4	8	12.1	12.8	13.1	12.5	18.7	22.0	3.3	
5690	Non HT80, 6 to 54 Mbps	1	8	15.7				15.7	22.0	6.3
	Non HT80, 6 to 54 Mbps	2	8	15.7	16.2			19.0	22.0	3.0
	Non HT80, 6 to 54 Mbps	3	8	14.6	15.0	15.0		19.6	22.0	2.4
	Non HT80, 6 to 54 Mbps	4	8	12.0	12.4	12.3	12.6	18.4	22.0	3.6
	VHT80, M0 to M9 1ss	1	8	15.9				15.9	22.0	6.1
	VHT80, M0 to M9 1ss	2	8	15.9	16.4			19.2	22.0	2.8
	VHT80, M0 to M9 2ss	2	8	15.9	16.4			19.2	22.0	2.8
	VHT80, M0 to M9 1ss	3	8	14.8	15.3	15.1		19.8	22.0	2.2
	VHT80, M0 to M9 2ss	3	8	15.9	16.4	16.3		21.0	22.0	1.0
	VHT80, M0 to M9 3ss	3	8	15.9	16.4	16.3		21.0	22.0	1.0
	VHT80, M0 to M9 1ss	4	8	12.5	13.0	13.0	13.5	19.0	22.0	3.0
	VHT80, M0 to M9 2ss	4	8	14.8	15.3	15.1	16.8	21.6	22.0	0.4
	VHT80, M0 to M9 3ss	4	8	14.8	15.3	15.1	16.8	21.6	22.0	0.4



	VHT80 Beam Forming, M0 to M9 1ss	2	11	14.8	15.3			18.1	19.0	0.9
	VHT80 Beam Forming, M0 to M9 2ss	2	8	15.9	16.4			19.2	22.0	2.8
	VHT80 Beam Forming, M0 to M9 1ss	3	13	11.6	12.1	12.1		16.7	17.0	0.3
	<b>VHT80 Beam Forming, M0 to M9 2ss</b>	<b>3</b>	<b>10</b>	<b>14.8</b>	<b>15.3</b>	<b>15.2</b>		<b>19.9</b>	<b>20.0</b>	<b>0.1</b>
	VHT80 Beam Forming, M0 to M9 3ss	3	8	15.9	16.4	16.3		21.0	22.0	1.0
	VHT80 Beam Forming, M0 to M9 1ss	4	14	10.8	10.6	8.9	8.8	15.9	16.0	0.1
	VHT80 Beam Forming, M0 to M9 2ss	4	11	11.6	12.1	12.1	12.5	18.1	19.0	0.9
	VHT80 Beam Forming, M0 to M9 3ss	4	9	13.7	14.2	14.1	14.5	20.2	21.0	0.8
	VHT80 STBC, M0 to M9 1ss	2	8	15.9	16.4			19.2	22.0	2.8
	VHT80 STBC, M0 to M9 1ss	3	8	15.9	16.4	16.3		21.0	22.0	1.0
	VHT80 STBC, M0 to M9 1ss	4	8	14.8	15.3	15.1	16.8	21.6	22.0	0.4
5700	Non HT20, 6 to 54 Mbps	1	8	15.4				15.4	21.6	6.2
	Non HT20, 6 to 54 Mbps	2	8	13.1	13.7			16.4	21.6	5.2
	Non HT20, 6 to 54 Mbps	3	8	9.7	9.7	8.5		14.1	21.6	7.5
	Non HT20, 6 to 54 Mbps	4	8	7.5	7.6	6.5	5.9	13.0	21.6	8.6
	Non HT20 Beam Forming, 6 to 54 Mbps	2	11	13.1	13.7			16.4	18.6	2.2
	Non HT20 Beam Forming, 6 to 54 Mbps	3	13	9.7	9.7	8.5		14.1	16.6	2.5
	Non HT20 Beam Forming, 6 to 54 Mbps	4	14	7.5	7.6	6.5	5.9	13.0	15.6	2.6
	HT/VHT20, M0 to M7	1	8	15.6				15.6	21.6	6.0
	HT/VHT20, M0 to M7	2	8	13.3	13.9			16.6	21.6	5.0
	HT/VHT20, M8 to M15	2	8	15.6	16.0			18.8	21.6	2.8
	HT/VHT20, M0 to M7	3	8	9.9	9.9	8.6		14.3	21.6	7.3
	HT/VHT20, M8 to M15	3	8	12.2	12.7	12.4		17.2	21.6	4.4
	HT/VHT20, M16 to M23	3	8	14.5	14.9	14.6		19.4	21.6	2.2
	HT/VHT20, M0 to M7	4	8	7.7	7.8	6.7	6.1	13.2	21.6	8.4
	HT/VHT20, M8 to M15	4	8	10.9	11.0	9.8	9.0	16.3	21.6	5.3
	HT/VHT20, M16 to M23	4	8	11.2	11.8	11.4	12.8	17.9	21.6	3.7
	HT/VHT20 Beam Forming, M0 to M7	2	11	13.3	13.9			16.6	18.6	2.0
	HT/VHT20 Beam Forming, M8 to M15	2	8	15.6	16.0			18.8	21.6	2.8
	HT/VHT20 Beam Forming, M0 to M7	3	13	9.9	9.9	8.6		14.3	16.6	2.3
	HT/VHT20 Beam Forming, M8 to M15	3	10	12.2	12.7	12.4		17.2	19.6	2.4
	HT/VHT20 Beam Forming, M16 to M23	3	8	14.5	14.9	14.6		19.4	21.6	2.2
	HT/VHT20 Beam Forming, M0 to M7	4	14	7.7	7.8	6.7	6.1	13.2	15.6	2.4
	HT/VHT20 Beam Forming, M8 to M15	4	11	10.9	11.0	9.8	9.0	16.3	18.6	2.3
	HT/VHT20 Beam Forming, M16 to M23	4	9	11.2	11.8	11.4	12.8	17.9	20.6	2.7
	HT/VHT20 STBC, M0 to M7	2	8	15.6	16.0			18.8	21.6	2.8
	HT/VHT20 STBC, M0 to M7	3	8	12.2	12.7	12.4		17.2	21.6	4.4
HT/VHT20 STBC, M0 to M7	4	8	10.9	11.0	9.8	9.0	16.3	21.6	5.3	



5710	Non HT40, 6 to 54 Mbps	1	8	16.3				16.3	22.0	5.7
	Non HT40, 6 to 54 Mbps	2	8	16.3	16.7			19.5	22.0	2.5
	Non HT40, 6 to 54 Mbps	3	8	11.8	12.4	11.9		16.8	22.0	5.2
	Non HT40, 6 to 54 Mbps	4	8	10.8	11.2	9.3	9.4	16.3	22.0	5.7
	HT/VHT40, M0 to M7	1	8	15.2				15.2	22.0	6.8
	HT/VHT40, M0 to M7	2	8	15.2	15.7			18.5	22.0	3.5
	HT/VHT40, M8 to M15	2	8	15.2	15.7			18.5	22.0	3.5
	HT/VHT40, M0 to M7	3	8	11.7	12.5	12.0		16.9	22.0	5.1
	HT/VHT40, M8 to M15	3	8	15.2	15.7	15.1		20.1	22.0	1.9
	HT/VHT40, M16 to M23	3	8	15.2	15.7	15.1		20.1	22.0	1.9
	HT/VHT40, M0 to M7	4	8	10.6	10.9	9.1	9.0	16.0	22.0	6.0
	HT/VHT40, M8 to M15	4	8	12.9	13.5	13.0	14.8	19.6	22.0	2.4
	HT/VHT40, M16 to M23	4	8	14.1	14.5	14.0	17.1	21.1	22.0	0.9
	HT/VHT40 Beam Forming, M0 to M7	2	11	14.1	14.5			17.3	19.0	1.7
	HT/VHT40 Beam Forming, M8 to M15	2	8	15.2	15.7			18.5	22.0	3.5
	HT/VHT40 Beam Forming, M0 to M7	3	13	10.8	11.6	11.1		16.0	17.0	1.0
	HT/VHT40 Beam Forming, M8 to M15	3	10	14.1	14.6	14.0		19.0	20.0	1.0
	HT/VHT40 Beam Forming, M16 to M23	3	8	15.2	15.7	15.1		20.1	22.0	1.9
	HT/VHT40 Beam Forming, M0 to M7	4	14	9.5	10.1	7.9	8.1	15.0	16.0	1.0
	HT/VHT40 Beam Forming, M8 to M15	4	11	11.7	12.5	12.0	13.6	18.5	19.0	0.5
HT/VHT40 Beam Forming, M16 to M23	4	9	14.1	14.6	14.0	15.9	20.7	21.0	0.3	
HT/VHT40 STBC, M0 to M7	2	8	15.2	15.7			18.5	22.0	3.5	
HT/VHT40 STBC, M0 to M7	3	8	15.2	15.7	15.1		20.1	22.0	1.9	
HT/VHT40 STBC, M0 to M7	4	8	12.9	13.5	13.0	14.8	19.6	22.0	2.4	
5720	Non HT20, 6 to 54 Mbps	1	8	15.2				15.2	21.6	6.4
	Non HT20, 6 to 54 Mbps	2	8	13.0	13.7			16.4	21.5	5.1
	Non HT20, 6 to 54 Mbps	3	8	9.0	9.6	8.6		13.9	21.6	7.7
	Non HT20, 6 to 54 Mbps	4	8	7.0	7.6	6.5	8.6	13.5	21.6	8.1
	Non HT20 Beam Forming, 6 to 54 Mbps	2	11	13.0	13.7			16.4	18.5	2.1
	Non HT20 Beam Forming, 6 to 54 Mbps	3	13	9.0	9.6	8.6		13.9	16.6	2.7
	Non HT20 Beam Forming, 6 to 54 Mbps	4	14	7.0	7.6	6.5	8.6	13.5	15.6	2.1
	HT/VHT20, M0 to M7	1	8	15.3				15.3	21.6	6.3
	HT/VHT20, M0 to M7	2	8	13.1	13.7			16.4	21.6	5.2
	HT/VHT20, M8 to M15	2	8	15.3	16.0			18.7	21.6	2.9
	HT/VHT20, M0 to M7	3	8	9.2	9.8	8.7		14.0	21.6	7.6
	HT/VHT20, M8 to M15	3	8	12.0	12.6	11.5		16.8	21.6	4.8
	HT/VHT20, M16 to M23	3	8	14.2	14.8	13.9		19.1	21.6	2.5
	HT/VHT20, M0 to M7	4	8	7.1	7.7	6.7	8.7	13.6	21.6	8.0
HT/VHT20, M8 to M15	4	8	10.1	10.7	9.7	11.9	16.7	21.6	4.9	



HT/VHT20, M16 to M23	4	8	12.0	12.6	11.5	13.8	18.6	21.6	3.0
HT/VHT20 Beam Forming, M0 to M7	2	11	13.1	13.7			16.4	18.6	2.2
HT/VHT20 Beam Forming, M8 to M15	2	8	15.3	16.0			18.7	21.6	2.9
HT/VHT20 Beam Forming, M0 to M7	3	13	9.2	9.8	8.7		14.0	16.6	2.6
HT/VHT20 Beam Forming, M8 to M15	3	10	12.0	12.6	11.5		16.8	19.6	2.8
HT/VHT20 Beam Forming, M16 to M23	3	8	14.2	14.8	13.9		19.1	21.6	2.5
HT/VHT20 Beam Forming, M0 to M7	4	14	7.1	7.7	6.7	8.7	13.6	15.6	2.0
HT/VHT20 Beam Forming, M8 to M15	4	11	10.1	10.7	9.7	11.9	16.7	18.6	1.9
HT/VHT20 Beam Forming, M16 to M23	4	9	12.0	12.6	11.5	13.8	18.6	20.6	2.0
HT/VHT20 STBC, M0 to M7	2	8	15.3	16.0			18.7	21.6	2.9
HT/VHT20 STBC, M0 to M7	3	8	12.0	12.6	11.5		16.8	21.6	4.8
HT/VHT20 STBC, M0 to M7	4	8	10.1	10.7	9.7	11.9	16.7	21.6	4.9



Frequency (MHz)	Mode	Tx Paths	Correlated Antenna Gain (dBi)	Tx 1 PSD (dBm/MHz)	Tx 2 PSD (dBm/MHz)	Tx 3 PSD (dBm/MHz)	Tx 4 PSD (dBm/MHz)	Total PSD (dBm/MHz)	Limit (dBm/MHz)	Margin (dB)
5500	Non HT20, 6 to 54 Mbps	1	8	5.5				5.5	9.0	3.5
	Non HT20, 6 to 54 Mbps	2	11	2.2	2.2			5.2	6.0	0.8
	Non HT20, 6 to 54 Mbps	3	13	0.5	-3.2	-3.2		3.2	4.0	0.8
	Non HT20, 6 to 54 Mbps	4	14	-1.5	-5.3	-5.4	-3.9	2.3	3.0	0.7
	Non HT20 Beam Forming, 6 to 54 Mbps	2	11	1.4	1.4			4.4	6.0	1.6
	Non HT20 Beam Forming, 6 to 54 Mbps	3	13	-0.2	-4.3	-4.4		2.3	4.0	1.7
	Non HT20 Beam Forming, 6 to 54 Mbps	4	14	-2.4	-6.3	-6.2	-4.8	1.4	3.0	1.6
	HT/VHT20, M0 to M7	1	8	7.1				7.1	9.0	1.9
	HT/VHT20, M0 to M7	2	11	2.0	2.9			5.5	6.0	0.5
	HT/VHT20, M8 to M15	2	8	4.0	4.5			7.3	9.0	1.7
	HT/VHT20, M0 to M7	3	13	0.3	-3.6	-3.4		2.9	4.0	1.1
	HT/VHT20, M8 to M15	3	10	2.0	2.9	1.0		6.8	7.0	0.2
	HT/VHT20, M16 to M23	3	8	2.8	3.2	2.3		7.6	9.0	1.4
	HT/VHT20, M0 to M7	4	14	-1.5	-5.5	-5.4	-3.6	2.3	3.0	0.7
	HT/VHT20, M8 to M15	4	11	1.4	-2.6	-2.2	-0.8	5.3	6.0	0.7
	HT/VHT20, M16 to M23	4	9	2.0	2.9	1.0	0.8	7.8	8.0	0.2
	HT/VHT20 Beam Forming, M0 to M7	2	11	1.2	1.6			4.4	6.0	1.6
	HT/VHT20 Beam Forming, M8 to M15	2	8	4.0	4.5			7.3	9.0	1.7
	HT/VHT20 Beam Forming, M0 to M7	3	13	-0.9	-4.6	-4.1		1.9	4.0	2.1
	HT/VHT20 Beam Forming, M8 to M15	3	10	1.2	1.6	-0.1		5.7	7.0	1.3
	HT/VHT20 Beam Forming, M16 to M23	3	8	2.8	3.2	2.3		7.6	9.0	1.4
	HT/VHT20 Beam Forming, M0 to M7	4	14	-2.4	-6.2	-6.4	-4.9	1.4	3.0	1.6
	HT/VHT20 Beam Forming, M8 to M15	4	11	0.3	-3.6	-3.4	-1.7	4.2	6.0	1.8
	HT/VHT20 Beam Forming, M16 to M23	4	9	1.2	1.6	-0.1	-0.5	6.7	8.0	1.3
	HT/VHT20 STBC, M0 to M7	2	8	4.0	4.5			7.3	9.0	1.7
	HT/VHT20 STBC, M0 to M7	3	10	2.0	2.9	1.0		6.8	7.0	0.2
HT/VHT20 STBC, M0 to M7	4	11	1.4	-2.6	-2.2	-0.8	5.3	6.0	0.7	
5510	Non HT40, 6 to 54 Mbps	1	8	-2.5				-2.5	9.0	11.5
	Non HT40, 6 to 54 Mbps	2	11	-6.1	-9.5			-4.5	6.0	10.5
	Non HT40, 6 to 54 Mbps	3	13	-6.9	-10.6	-10.8		-4.3	4.0	8.3
	Non HT40, 6 to 54 Mbps	4	14	-8.3	-11.4	-12.0	-10.5	-4.3	3.0	7.3
	HT/VHT40, M0 to M7	1	8	0.8				0.8	9.0	8.2
	HT/VHT40, M0 to M7	2	11	-0.9	-4.2			0.8	6.0	5.2





	HT/VHT40, M8 to M15	2	8	-0.9	-4.2			0.8	9.0	8.2
	HT/VHT40, M0 to M7	3	13	-2.0	-5.1	-5.8		0.8	4.0	3.2
	HT/VHT40, M8 to M15	3	10	-2.0	-5.1	-5.8		0.8	7.0	6.2
	HT/VHT40, M16 to M23	3	8	-2.0	-5.1	-5.8		0.8	9.0	8.2
	HT/VHT40, M0 to M7	4	14	-3.0	-6.2	-7.0	-4.9	1.0	3.0	2.0
	HT/VHT40, M8 to M15	4	11	-3.0	-6.2	-7.0	-4.9	1.0	6.0	5.0
	HT/VHT40, M16 to M23	4	9	-3.0	-6.2	-7.0	-4.9	1.0	8.0	7.0
	HT/VHT40 Beam Forming, M0 to M7	2	11	-4.9	-8.2			-3.2	6.0	9.2
	HT/VHT40 Beam Forming, M8 to M15	2	8	-0.9	-4.2			0.8	9.0	8.2
	HT/VHT40 Beam Forming, M0 to M7	3	13	-7.0	-10.2	-10.5		-4.2	4.0	8.2
	HT/VHT40 Beam Forming, M8 to M15	3	10	-4.9	-8.2	-8.6		-2.1	7.0	9.1
	HT/VHT40 Beam Forming, M16 to M23	3	8	-2.0	-5.1	-5.8		0.8	9.0	8.2
	HT/VHT40 Beam Forming, M0 to M7	4	14	-10.1	-13.1	-13.7	-12.4	-6.1	3.0	9.1
	HT/VHT40 Beam Forming, M8 to M15	4	11	-6.0	-9.0	-9.5	-8.1	-1.9	6.0	7.9
	HT/VHT40 Beam Forming, M16 to M23	4	9	-4.9	-8.2	-8.6	-7.0	-0.9	8.0	8.9
	HT/VHT40 STBC, M0 to M7	2	8	-0.9	-4.2			0.8	9.0	8.2
	HT/VHT40 STBC, M0 to M7	3	10	-2.0	-5.1	-5.8		0.8	7.0	6.2
	HT/VHT40 STBC, M0 to M7	4	11	-3.0	-6.2	-7.0	-4.9	1.0	6.0	5.0
5530	Non HT80, 6 to 54 Mbps	1	8	-2.7				-2.7	9.0	11.7
	Non HT80, 6 to 54 Mbps	2	11	-7.0	-6.8			-3.9	6.0	9.9
	Non HT80, 6 to 54 Mbps	3	13	-5.2	-8.2	-8.4		-2.2	4.0	6.2
	Non HT80, 6 to 54 Mbps	4	14	-6.8	-7.8	-9.0	-8.3	-1.9	3.0	4.9
	VHT80, M0 to M9 1ss	1	8	-1.8				-1.8	9.0	10.8
	VHT80, M0 to M9 1ss	2	11	-2.8	-2.6			0.3	6.0	5.7
	VHT80, M0 to M9 2ss	2	8	-2.8	-2.6			0.3	9.0	8.7
	VHT80, M0 to M9 1ss	3	13	-4.2	-3.4	-4.2		0.9	4.0	3.1
	VHT80, M0 to M9 2ss	3	10	-4.2	-3.4	-4.2		0.9	7.0	6.1
	VHT80, M0 to M9 3ss	3	8	-4.2	-3.4	-4.2		0.9	9.0	8.1
	VHT80, M0 to M9 1ss	4	14	-4.2	-3.4	-4.2	-3.9	2.1	3.0	0.9
	VHT80, M0 to M9 2ss	4	11	-4.2	-3.4	-4.2	-3.9	2.1	6.0	3.9
	VHT80, M0 to M9 3ss	4	9	-4.2	-3.4	-4.2	-3.9	2.1	8.0	5.9
	VHT80 Beam Forming, M0 to M9 1ss	2	11	-5.3	-5.7			-2.5	6.0	8.5
	VHT80 Beam Forming, M0 to M9 2ss	2	8	-2.8	-2.6			0.3	9.0	8.7
	VHT80 Beam Forming, M0 to M9 1ss	3	13	-5.5	-8.1	-9.3		-2.6	4.0	6.6
	VHT80 Beam Forming, M0 to M9 2ss	3	10	-5.3	-5.7	-6.1		-0.9	7.0	7.9
	VHT80 Beam Forming, M0 to M9 3ss	3	8	-4.2	-3.4	-4.2		0.9	9.0	8.1
	VHT80 Beam Forming, M0 to M9 1ss	4	14	-7.6	-10.2	-11.5	-10.2	-3.6	3.0	6.6
	VHT80 Beam Forming, M0 to M9 2ss	4	11	-4.4	-6.5	-8.4	-7.3	-0.4	6.0	6.4
VHT80 Beam Forming, M0 to M9 3ss	4	9	-5.3	-5.7	-6.1	-6.2	0.2	8.0	7.8	
VHT80 STBC, M0 to M9 1ss	2	8	-2.8	-2.6			0.3	9.0	8.7	



	VHT80 STBC, M0 to M9 1ss	3	8	-4.2	-3.4	-4.2		0.9	9.0	8.1
	VHT80 STBC, M0 to M9 1ss	4	8	-4.2	-3.4	-4.2	-3.9	2.1	9.0	6.9
5570	Non HT160, 6 to 54 Mbps	1	8	-6.5				-6.5	9.0	15.5
	Non HT160, 6 to 54 Mbps	2	11	-12.8	-14.1			-10.4	6.0	16.4
	Non HT160, 6 to 54 Mbps	3	13	-12.8	-14.1	-15.3		-9.2	4.0	13.2
	Non HT160, 6 to 54 Mbps	4	14	-12.8	-14.1	-15.3	-14.4	-8.0	3.0	11.0
	VHT160, M0 to M9 1ss	1	8	-2.6				-2.6	9.0	11.6
	VHT160, M0 to M9 1ss	2	11	-6.5	-6.0			-3.2	6.0	9.2
	VHT160, M0 to M9 2ss	2	8	-6.5	-6.0			-3.2	9.0	12.2
	VHT160, M0 to M9 1ss	3	13	-7.1	-6.7	-8.0		-2.5	4.0	6.5
	VHT160, M0 to M9 2ss	3	10	-7.1	-6.7	-8.0		-2.5	7.0	9.5
	VHT160, M0 to M9 3ss	3	8	-7.1	-6.7	-8.0		-2.5	9.0	11.5
	VHT160, M0 to M9 1ss	4	14	-7.7	-10.4	-11.3	-10.2	-3.7	3.0	6.7
	VHT160, M0 to M9 2ss	4	11	-7.7	-10.4	-11.3	-10.2	-3.7	6.0	9.7
	VHT160, M0 to M9 3ss	4	9	-7.7	-10.4	-11.3	-10.2	-3.7	8.0	11.7
	VHT160 Beam Forming, M0 to M9 1ss	2	11	-7.7	-10.4			-5.8	6.0	11.8
	VHT160 Beam Forming, M0 to M9 2ss	2	8	-6.5	-6.0			-3.2	9.0	12.2
	VHT160 Beam Forming, M0 to M9 1ss	3	13	-8.6	-11.1	-12.6		-5.7	4.0	9.7
	VHT160 Beam Forming, M0 to M9 2ss	3	10	-7.7	-10.4	-11.3		-4.7	7.0	11.7
	VHT160 Beam Forming, M0 to M9 3ss	3	8	-7.1	-6.7	-8.0		-2.5	9.0	11.5
	VHT160 Beam Forming, M0 to M9 1ss	4	14	-10.6	-13.5	-14.7	-12.9	-6.6	3.0	9.6
	VHT160 Beam Forming, M0 to M9 2ss	4	11	-8.6	-11.1	-12.6	-11.3	-4.6	6.0	10.6
VHT160 Beam Forming, M0 to M9 3ss	4	9	-7.7	-10.4	-11.3	-10.2	-3.7	8.0	11.7	
VHT160 STBC, M0 to M9 1ss	2	8	-6.5	-6.0			-3.2	9.0	12.2	
VHT160 STBC, M0 to M9 1ss	3	8	-7.1	-6.7	-8.0		-2.5	9.0	11.5	
VHT160 STBC, M0 to M9 1ss	4	8	-7.7	-10.4	-11.3	-10.2	-3.7	9.0	12.7	
5560	Non HT20, 6 to 54 Mbps	1	8	5.8				5.8	9.0	3.2
	Non HT20, 6 to 54 Mbps	2	11	2.2	2.5			5.4	6.0	0.6
	Non HT20, 6 to 54 Mbps	3	13	-1.5	-1.3	-1.5		3.3	4.0	0.7
	Non HT20, 6 to 54 Mbps	4	14	-3.8	-3.4	-3.4	-3.0	2.6	3.0	0.4
	Non HT20 Beam Forming, 6 to 54 Mbps	2	11	2.2	2.5			5.4	6.0	0.6
	Non HT20 Beam Forming, 6 to 54 Mbps	3	13	-1.5	-1.3	-1.5		3.3	4.0	0.7
	Non HT20 Beam Forming, 6 to 54 Mbps	4	14	-3.8	-3.4	-3.4	-3.0	2.6	3.0	0.4
	HT/VHT20, M0 to M7	1	8	5.6				5.6	9.0	3.4
	HT/VHT20, M0 to M7	2	11	2.7	2.4			5.6	6.0	0.4
	HT/VHT20, M8 to M15	2	8	5.6	6.0			8.8	9.0	0.2
	HT/VHT20, M0 to M7	3	13	-1.5	-1.6	-1.4		3.3	4.0	0.7
	HT/VHT20, M8 to M15	3	10	1.2	1.6	1.6		6.2	7.0	0.8
	HT/VHT20, M16 to M23	3	8	3.3	3.5	3.7		8.3	9.0	0.7



	HT/VHT20, M0 to M7	4	14	-3.9	-3.6	-3.4	-2.9	2.6	3.0	0.4
	HT/VHT20, M8 to M15	4	11	-0.7	-0.3	-0.5	0.1	5.7	6.0	0.3
	HT/VHT20, M16 to M23	4	9	1.2	1.6	1.6	2.1	7.7	8.0	0.3
	HT/VHT20 Beam Forming, M0 to M7	2	11	2.7	2.4			5.6	6.0	0.4
	HT/VHT20 Beam Forming, M8 to M15	2	8	5.6	6.0			8.8	9.0	0.2
	HT/VHT20 Beam Forming, M0 to M7	3	13	-1.5	-1.6	-1.4		3.3	4.0	0.7
	HT/VHT20 Beam Forming, M8 to M15	3	10	1.2	1.6	1.6		6.2	7.0	0.8
	HT/VHT20 Beam Forming, M16 to M23	3	8	3.3	3.5	3.7		8.3	9.0	0.7
	HT/VHT20 Beam Forming, M0 to M7	4	14	-3.9	-3.6	-3.4	-2.9	2.6	3.0	0.4
	HT/VHT20 Beam Forming, M8 to M15	4	11	-0.7	-0.3	-0.5	0.1	5.7	6.0	0.3
	HT/VHT20 Beam Forming, M16 to M23	4	9	1.2	1.6	1.6	2.1	7.7	8.0	0.3
	HT/VHT20 STBC, M0 to M7	2	8	5.6	6.0			8.8	9.0	0.2
	HT/VHT20 STBC, M0 to M7	3	10	1.2	1.6	1.6		6.2	7.0	0.8
	HT/VHT20 STBC, M0 to M7	4	11	-0.7	-0.3	-0.5	0.1	5.7	6.0	0.3
5660	Non HT20, 6 to 54 Mbps	1	8	6.8				6.8	9.0	2.2
	Non HT20, 6 to 54 Mbps	2	11	2.4	2.8			5.6	6.0	0.4
	Non HT20, 6 to 54 Mbps	3	13	-0.3	-2.0	-1.7		3.5	4.0	0.5
	Non HT20, 6 to 54 Mbps	4	14	-2.7	-4.0	-3.9	-4.1	2.4	3.0	0.6
	Non HT20 Beam Forming, 6 to 54 Mbps	2	11	2.4	2.8			5.6	6.0	0.4
	Non HT20 Beam Forming, 6 to 54 Mbps	3	13	-0.3	-2.0	-1.7		3.5	4.0	0.5
	Non HT20 Beam Forming, 6 to 54 Mbps	4	14	-2.7	-4.0	-3.9	-4.1	2.4	3.0	0.6
	HT/VHT20, M0 to M7	1	8	6.5				6.5	9.0	2.5
	HT/VHT20, M0 to M7	2	11	1.9	2.8			5.4	6.0	0.6
	HT/VHT20, M8 to M15	2	8	5.3	5.8			8.6	9.0	0.4
	HT/VHT20, M0 to M7	3	13	-0.5	-1.9	-2.2		3.3	4.0	0.7
	HT/VHT20, M8 to M15	3	10	1.5	1.8	1.7		6.4	7.0	0.6
	HT/VHT20, M16 to M23	3	8	3.1	3.6	3.6		8.2	9.0	0.8
	HT/VHT20, M0 to M7	4	14	-2.9	-4.1	-4.1	-4.2	2.2	3.0	0.8
	HT/VHT20, M8 to M15	4	11	0.4	-0.7	-1.0	-1.2	5.4	6.0	0.6
	HT/VHT20, M16 to M23	4	9	1.5	1.8	1.7	1.0	7.5	8.0	0.5
	HT/VHT20 Beam Forming, M0 to M7	2	11	1.9	2.8			5.4	6.0	0.6
	HT/VHT20 Beam Forming, M8 to M15	2	8	5.3	5.8			8.6	9.0	0.4
	HT/VHT20 Beam Forming, M0 to M7	3	13	-0.5	-1.9	-2.2		3.3	4.0	0.7
	HT/VHT20 Beam Forming, M8 to M15	3	10	1.5	1.8	1.7		6.4	7.0	0.6
	HT/VHT20 Beam Forming, M16 to M23	3	8	3.1	3.6	3.6		8.2	9.0	0.8
	HT/VHT20 Beam Forming, M0 to M7	4	14	-2.9	-4.1	-4.1	-4.2	2.2	3.0	0.8
	HT/VHT20 Beam Forming, M8 to M15	4	11	0.4	-0.7	-1.0	-1.2	5.4	6.0	0.6
	HT/VHT20 Beam Forming, M16 to M23	4	9	1.5	1.8	1.7	1.0	7.5	8.0	0.5
HT/VHT20 STBC, M0 to M7	2	8	5.3	5.8			8.6	9.0	0.4	
HT/VHT20 STBC, M0 to M7	3	10	1.5	1.8	1.7		6.4	7.0	0.6	



	HT/VHT20 STBC, M0 to M7	4	11	0.4	-0.7	-1.0	-1.2	5.4	6.0	0.6
5670	Non HT40, 6 to 54 Mbps	1	8	4.8				4.8	9.0	4.2
	Non HT40, 6 to 54 Mbps	2	11	2.3	2.9			5.6	6.0	0.4
	Non HT40, 6 to 54 Mbps	3	13	-1.2	-1.8	-2.7		2.9	4.0	1.1
	Non HT40, 6 to 54 Mbps	4	14	-2.4	-2.7	-3.4	-4.0	2.9	3.0	0.1
	HT/VHT40, M0 to M7	1	8	3.7				3.7	9.0	5.3
	HT/VHT40, M0 to M7	2	11	1.9	2.7			5.3	6.0	0.7
	HT/VHT40, M8 to M15	2	8	3.7	3.9			6.8	9.0	2.2
	HT/VHT40, M0 to M7	3	13	-2.0	-1.4	-1.3		3.2	4.0	0.8
	HT/VHT40, M8 to M15	3	10	1.0	1.5	1.7		6.2	7.0	0.8
	HT/VHT40, M16 to M23	3	8	3.7	3.9	3.9		8.6	9.0	0.4
	HT/VHT40, M0 to M7	4	14	-2.9	-3.3	-4.3	-4.4	2.3	3.0	0.7
	HT/VHT40, M8 to M15	4	11	-1.3	-0.6	-0.4	-1.3	5.1	6.0	0.9
	HT/VHT40, M16 to M23	4	9	1.0	1.5	1.7	0.9	7.3	8.0	0.7
	HT/VHT40 Beam Forming, M0 to M7	2	11	1.9	2.7			5.3	6.0	0.7
	HT/VHT40 Beam Forming, M8 to M15	2	8	3.7	3.9			6.8	9.0	2.2
	HT/VHT40 Beam Forming, M0 to M7	3	13	-2.0	-1.4	-1.3		3.2	4.0	0.8
	HT/VHT40 Beam Forming, M8 to M15	3	10	1.0	1.5	1.7		6.2	7.0	0.8
	HT/VHT40 Beam Forming, M16 to M23	3	8	3.7	3.9	3.9		8.6	9.0	0.4
	HT/VHT40 Beam Forming, M0 to M7	4	14	-3.8	-4.4	-5.3	-5.2	1.4	3.0	1.6
	HT/VHT40 Beam Forming, M8 to M15	4	11	-1.3	-0.6	-0.4	-1.3	5.1	6.0	0.9
HT/VHT40 Beam Forming, M16 to M23	4	9	1.0	1.5	1.7	0.9	7.3	8.0	0.7	
HT/VHT40 STBC, M0 to M7	2	8	3.7	3.9			6.8	9.0	2.2	
HT/VHT40 STBC, M0 to M7	3	10	1.0	1.5	1.7		6.2	7.0	0.8	
HT/VHT40 STBC, M0 to M7	4	11	-1.3	-0.6	-0.4	-1.3	5.1	6.0	0.9	
5690	Non HT80, 6 to 54 Mbps	1	8	-0.8				-0.8	9.0	9.8
	Non HT80, 6 to 54 Mbps	2	11	-0.8	-0.1			2.6	6.0	3.4
	Non HT80, 6 to 54 Mbps	3	13	-1.5	-1.0	-0.8		3.7	4.0	0.3
	Non HT80, 6 to 54 Mbps	4	14	-4.1	-3.7	-3.8	-4.0	2.1	3.0	0.9
	VHT80, M0 to M9 1ss	1	8	-0.5				-0.5	9.0	9.5
	VHT80, M0 to M9 1ss	2	11	-0.5	-0.3			2.6	6.0	3.4
	VHT80, M0 to M9 2ss	2	8	-0.5	-0.3			2.6	9.0	6.4
	VHT80, M0 to M9 1ss	3	13	-1.8	-1.5	-1.4		3.2	4.0	0.8
	VHT80, M0 to M9 2ss	3	10	-0.5	-0.3	-0.3		4.4	7.0	2.6
	VHT80, M0 to M9 3ss	3	8	-0.5	-0.3	-0.3		4.4	9.0	4.6
	VHT80, M0 to M9 1ss	4	14	-4.0	-4.0	-3.6	-4.0	2.1	3.0	0.9
	VHT80, M0 to M9 2ss	4	11	-1.8	-1.5	-1.4	-0.8	4.7	6.0	1.3
	VHT80, M0 to M9 3ss	4	9	-1.8	-1.5	-1.4	-0.8	4.7	8.0	3.3
	VHT80 Beam Forming, M0 to M9 1ss	2	11	-1.8	-1.5			1.4	6.0	4.6



	VHT80 Beam Forming, M0 to M9 2ss	2	8	-0.5	-0.3			2.6	9.0	6.4
	VHT80 Beam Forming, M0 to M9 1ss	3	13	-5.1	-4.6	-4.2		0.2	4.0	3.8
	VHT80 Beam Forming, M0 to M9 2ss	3	10	-1.3	-1.4	-1.2		3.5	7.0	3.5
	VHT80 Beam Forming, M0 to M9 3ss	3	8	-0.5	-0.3	-0.3		4.4	9.0	4.6
	VHT80 Beam Forming, M0 to M9 1ss	4	14	-6.6	-6.8	-8.1	-8.4	-1.4	3.0	4.4
	VHT80 Beam Forming, M0 to M9 2ss	4	11	-5.1	-4.6	-4.2	-4.9	1.3	6.0	4.7
	VHT80 Beam Forming, M0 to M9 3ss	4	9	-2.9	-2.6	-2.1	-3.0	3.4	8.0	4.6
	VHT80 STBC, M0 to M9 1ss	2	8	-0.5	-0.3			2.6	9.0	6.4
	VHT80 STBC, M0 to M9 1ss	3	8	-0.5	-0.3	-0.3		4.4	9.0	4.6
	VHT80 STBC, M0 to M9 1ss	4	8	-1.8	-1.5	-1.4	-0.8	4.7	9.0	4.3
5700	Non HT20, 6 to 54 Mbps	1	8	4.7				4.7	9.0	4.3
	Non HT20, 6 to 54 Mbps	2	11	2.6	3.1			5.9	6.0	0.1
	Non HT20, 6 to 54 Mbps	3	13	-0.9	-1.0	-2.0		3.5	4.0	0.5
	Non HT20, 6 to 54 Mbps	4	14	-3.0	-3.1	-3.8	-5.0	2.4	3.0	0.6
	Non HT20 Beam Forming, 6 to 54 Mbps	2	11	2.6	3.1			5.9	6.0	0.1
	Non HT20 Beam Forming, 6 to 54 Mbps	3	13	-0.9	-1.0	-2.0		3.5	4.0	0.5
	Non HT20 Beam Forming, 6 to 54 Mbps	4	14	-3.0	-3.1	-3.8	-5.0	2.4	3.0	0.6
	HT/VHT20, M0 to M7	1	8	4.6				4.6	9.0	4.4
	<b>HT/VHT20, M0 to M7</b>	<b>2</b>	<b>11</b>	<b>2.8</b>	<b>3.1</b>			<b>6.0</b>	<b>6.0</b>	<b>0.0</b>
	HT/VHT20, M8 to M15	2	8	4.6	5.1			7.9	9.0	1.1
	HT/VHT20, M0 to M7	3	13	-1.0	-0.6	-2.2		3.6	4.0	0.4
	HT/VHT20, M8 to M15	3	10	1.5	1.7	1.9		6.5	7.0	0.5
	HT/VHT20, M16 to M23	3	8	3.7	4.0	4.0		8.7	9.0	0.3
	HT/VHT20, M0 to M7	4	14	-3.1	-3.0	-3.7	-4.7	2.4	3.0	0.6
	HT/VHT20, M8 to M15	4	11	0.1	0.1	-0.9	-1.6	5.5	6.0	0.5
	HT/VHT20, M16 to M23	4	9	0.2	1.0	0.7	1.7	7.0	8.0	1.0
	HT/VHT20 Beam Forming, M0 to M7	2	11	2.8	3.1			6.0	6.0	0.0
	HT/VHT20 Beam Forming, M8 to M15	2	8	4.6	5.1			7.9	9.0	1.1
	HT/VHT20 Beam Forming, M0 to M7	3	13	-1.0	-0.6	-2.2		3.6	4.0	0.4
	HT/VHT20 Beam Forming, M8 to M15	3	10	1.5	1.7	1.9		6.5	7.0	0.5
	HT/VHT20 Beam Forming, M16 to M23	3	8	3.7	4.0	4.0		8.7	9.0	0.3
	HT/VHT20 Beam Forming, M0 to M7	4	14	-3.1	-3.0	-3.7	-4.7	2.4	3.0	0.6
	HT/VHT20 Beam Forming, M8 to M15	4	11	0.1	0.1	-0.9	-1.6	5.5	6.0	0.5
	HT/VHT20 Beam Forming, M16 to M23	4	9	0.2	1.0	0.7	1.7	7.0	8.0	1.0
	HT/VHT20 STBC, M0 to M7	2	8	4.6	5.1			7.9	9.0	1.1
	HT/VHT20 STBC, M0 to M7	3	10	1.5	1.7	1.9		6.5	7.0	0.5
HT/VHT20 STBC, M0 to M7	4	11	0.1	0.1	-0.9	-1.6	5.5	6.0	0.5	



5710	Non HT40, 6 to 54 Mbps	1	8	2.9				2.9	9.0	6.1
	Non HT40, 6 to 54 Mbps	2	11	2.9	3.0			6.0	6.0	0.0
	Non HT40, 6 to 54 Mbps	3	13	-1.3	-1.0	-1.3		3.6	4.0	0.4
	Non HT40, 6 to 54 Mbps	4	14	-2.6	-2.3	-3.8	-3.8	2.9	3.0	0.1
	HT/VHT40, M0 to M7	1	8	1.3				1.3	9.0	7.7
	HT/VHT40, M0 to M7	2	11	1.3	1.9			4.6	6.0	1.4
	HT/VHT40, M8 to M15	2	8	1.3	1.9			4.6	9.0	4.4
	HT/VHT40, M0 to M7	3	13	-2.2	-1.3	-1.5		3.1	4.0	0.9
	HT/VHT40, M8 to M15	3	10	1.3	1.9	1.8		6.4	7.0	0.6
	HT/VHT40, M16 to M23	3	8	1.3	1.9	1.8		6.4	9.0	2.6
	HT/VHT40, M0 to M7	4	14	-3.1	-3.1	-4.6	-4.5	2.3	3.0	0.7
	HT/VHT40, M8 to M15	4	11	-0.7	-0.3	-0.6	1.0	5.9	6.0	0.1
	HT/VHT40, M16 to M23	4	9	0.2	1.3	0.6	3.2	7.5	8.0	0.5
	HT/VHT40 Beam Forming, M0 to M7	2	11	0.2	1.3			3.8	6.0	2.2
	HT/VHT40 Beam Forming, M8 to M15	2	8	1.3	1.9			4.6	9.0	4.4
	HT/VHT40 Beam Forming, M0 to M7	3	13	-2.9	-2.2	-2.2		2.4	4.0	1.6
	HT/VHT40 Beam Forming, M8 to M15	3	10	0.2	0.8	0.4		5.2	7.0	1.8
	HT/VHT40 Beam Forming, M16 to M23	3	8	1.3	1.9	1.8		6.4	9.0	2.6
	HT/VHT40 Beam Forming, M0 to M7	4	14	-3.7	-3.6	-5.8	-5.8	1.4	3.0	1.6
	HT/VHT40 Beam Forming, M8 to M15	4	11	-2.2	-1.3	-1.5	-0.3	4.7	6.0	1.3
HT/VHT40 Beam Forming, M16 to M23	4	9	0.2	0.8	0.4	2.0	6.9	8.0	1.1	
HT/VHT40 STBC, M0 to M7	2	8	1.3	1.9			4.6	9.0	4.4	
HT/VHT40 STBC, M0 to M7	3	10	1.3	1.9	1.8		6.4	7.0	0.6	
HT/VHT40 STBC, M0 to M7	4	11	-0.7	-0.3	-0.6	1.0	5.9	6.0	0.1	
5720	Non HT20, 6 to 54 Mbps	1	8	4.5				4.5	9.0	4.5
	Non HT20, 6 to 54 Mbps	2	11	2.4	3.0			5.7	6.0	0.3
	Non HT20, 6 to 54 Mbps	3	13	-1.7	-0.7	-2.0		3.3	4.0	0.7
	Non HT20, 6 to 54 Mbps	4	14	-3.4	-3.0	-4.2	-1.9	3.0	3.0	0.0
	Non HT20 Beam Forming, 6 to 54 Mbps	2	11	2.4	3.0			5.7	6.0	0.3
	Non HT20 Beam Forming, 6 to 54 Mbps	3	13	-1.7	-0.7	-2.0		3.3	4.0	0.7
	Non HT20 Beam Forming, 6 to 54 Mbps	4	14	-3.4	-3.0	-4.2	-1.9	3.0	3.0	0.0
	HT/VHT20, M0 to M7	1	8	4.4				4.4	9.0	4.6
	HT/VHT20, M0 to M7	2	11	2.2	3.1			5.7	6.0	0.3
	HT/VHT20, M8 to M15	2	8	4.4	5.3			7.9	9.0	1.1
	HT/VHT20, M0 to M7	3	13	-1.8	-0.9	-2.2		3.2	4.0	0.8
	HT/VHT20, M8 to M15	3	10	1.3	1.5	0.5		5.9	7.0	1.1
	HT/VHT20, M16 to M23	3	8	3.6	3.9	3.0		8.3	9.0	0.7
	HT/VHT20, M0 to M7	4	14	-3.7	-2.9	-4.1	-2.1	2.9	3.0	0.1
	HT/VHT20, M8 to M15	4	11	-0.6	0.2	-1.1	0.9	5.9	6.0	0.1
HT/VHT20, M16 to M23	4	9	1.3	1.5	0.5	3.0	7.7	8.0	0.3	



HT/VHT20 Beam Forming, M0 to M7	2	11	2.2	3.1			5.7	6.0	0.3
HT/VHT20 Beam Forming, M8 to M15	2	8	4.4	5.3			7.9	9.0	1.1
HT/VHT20 Beam Forming, M0 to M7	3	13	-1.8	-0.9	-2.2		3.2	4.0	0.8
HT/VHT20 Beam Forming, M8 to M15	3	10	1.3	1.5	0.5		5.9	7.0	1.1
HT/VHT20 Beam Forming, M16 to M23	3	8	3.6	3.9	3.0		8.3	9.0	0.7
HT/VHT20 Beam Forming, M0 to M7	4	14	-3.7	-2.9	-4.1	-2.1	2.9	3.0	0.1
HT/VHT20 Beam Forming, M8 to M15	4	11	-0.6	0.2	-1.1	0.9	5.9	6.0	0.1
HT/VHT20 Beam Forming, M16 to M23	4	9	1.3	1.5	0.5	3.0	7.7	8.0	0.3
HT/VHT20 STBC, M0 to M7	2	8	4.4	5.3			7.9	9.0	1.1
HT/VHT20 STBC, M0 to M7	3	10	1.3	1.5	0.5		5.9	7.0	1.1
HT/VHT20 STBC, M0 to M7	4	11	-0.6	0.2	-1.1	0.9	5.9	6.0	0.1



**Peak Output Power, 5690 MHz, VHT80 Beam Forming, M0 to M9 1ss**

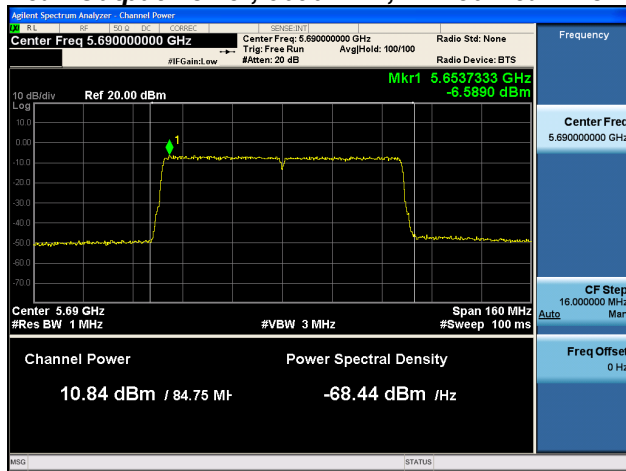

**Antenna A**

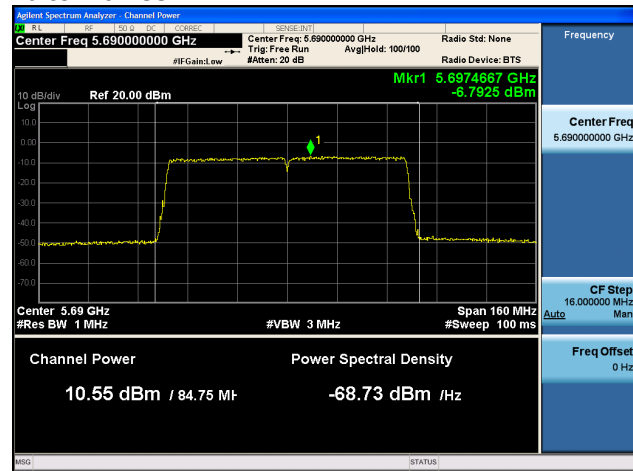

**Antenna B**

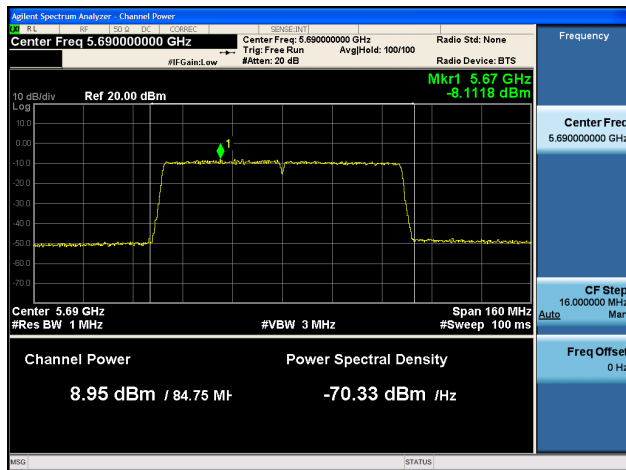

**Antenna C**

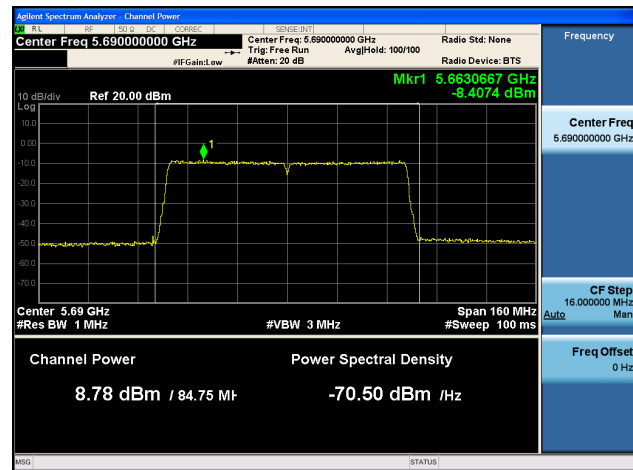

**Antenna D**





**Power Spectral Density, 5720 MHz, Non HT20, 6 to 54 Mbps**

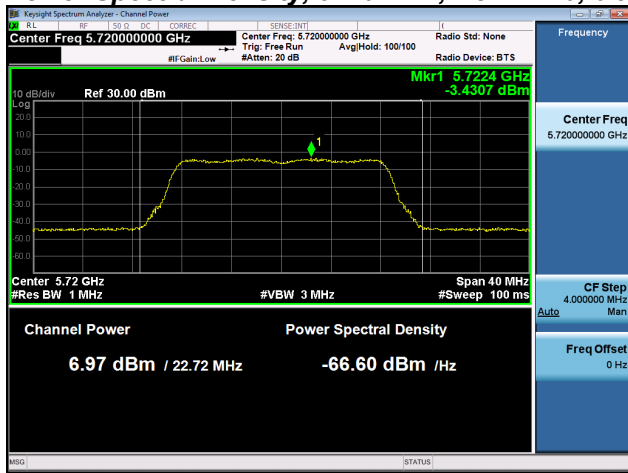

**Antenna A**

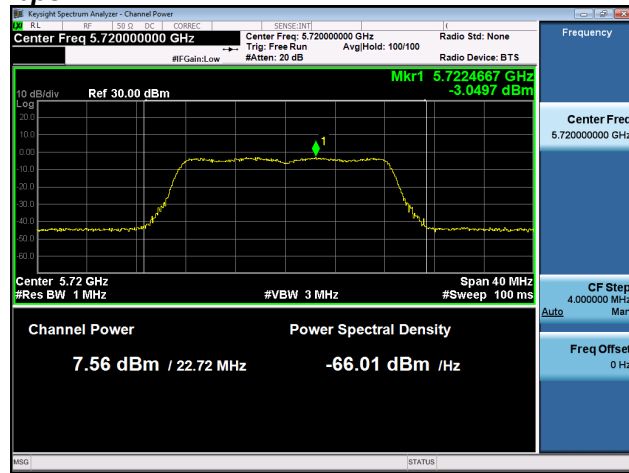

**Antenna B**

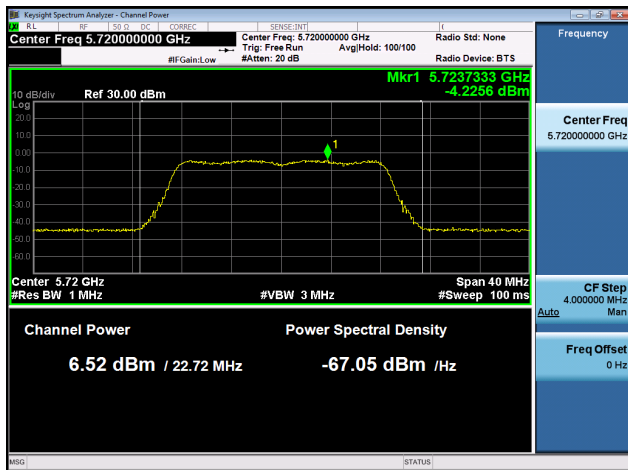

**Antenna C**

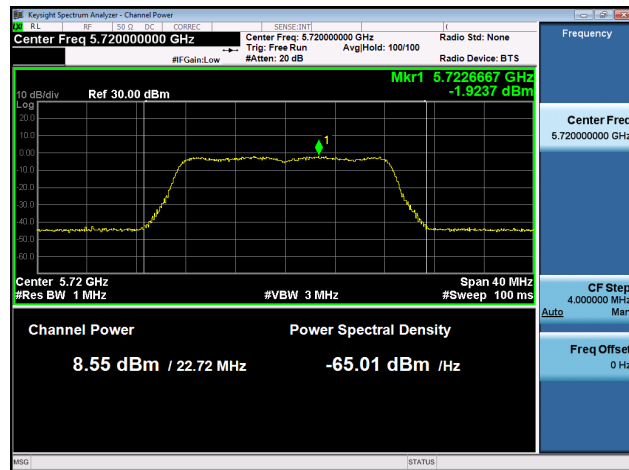

**Antenna D**



Antenna Gain : 13 dBi

Frequency (MHz)	Mode	Tx Paths	Correlated Antenna Gain (dBi)	Tx 1 Max Power (dBm)	Tx 2 Max Power (dBm)	Tx 3 Max Power (dBm)	Tx 4 Max Power (dBm)	Total Tx Channel Power (dBm)	Limit (dBm)	Margin (dB)
5500	Non HT20, 6 to 54 Mbps	1	13	12.5				12.5	16.6	4.1
	Non HT20, 6 to 54 Mbps	2	13	9.0	5.2			10.5	16.6	6.1
	Non HT20, 6 to 54 Mbps	3	13	6.2	2.4	2.1		8.8	16.6	7.8
	Non HT20, 6 to 54 Mbps	4	13	4.0	0.4	0.0	1.7	7.8	16.6	8.8
	Non HT20 Beam Forming, 6 to 54 Mbps	2	13	9.0	5.2			10.5	16.6	6.1
	Non HT20 Beam Forming, 6 to 54 Mbps	3	16	6.2	2.4	2.1		8.8	13.6	4.8
	Non HT20 Beam Forming, 6 to 54 Mbps	4	16	4.0	0.4	0.0	1.7	7.8	13.6	5.8
	HT/VHT20, M0 to M7	1	13	12.7				12.7	16.6	3.9
	HT/VHT20, M0 to M7	2	13	10.0	6.4			11.6	16.6	5.0
	HT/VHT20, M8 to M15	2	13	11.2	7.2			12.7	16.6	3.9
	HT/VHT20, M0 to M7	3	13	6.3	2.5	2.2		8.9	16.6	7.7
	HT/VHT20, M8 to M15	3	13	10.0	6.4	6.4		12.7	16.6	3.9
	HT/VHT20, M16 to M23	3	13	10.0	6.4	6.4		12.7	16.6	3.9
	HT/VHT20, M0 to M7	4	13	4.2	0.5	0.2	1.7	8.0	16.6	8.6
	HT/VHT20, M8 to M15	4	13	7.2	3.4	3.3	4.8	11.0	16.6	5.6
	HT/VHT20, M16 to M23	4	13	9.1	5.3	5.3	6.9	13.0	16.6	3.6
	HT/VHT20 Beam Forming, M0 to M7	2	13	10.0	6.4			11.6	16.6	5.0
	HT/VHT20 Beam Forming, M8 to M15	2	13	11.2	7.2			12.7	16.6	3.9
	HT/VHT20 Beam Forming, M0 to M7	3	16	6.3	2.5	2.2		8.9	13.6	4.7
	HT/VHT20 Beam Forming, M8 to M15	3	13	10.0	6.4	6.4		12.7	16.6	3.9
	HT/VHT20 Beam Forming, M16 to M23	3	13	10.0	6.4	6.4		12.7	16.6	3.9
	HT/VHT20 Beam Forming, M0 to M7	4	16	4.2	0.5	0.2	1.7	8.0	13.6	5.6
	HT/VHT20 Beam Forming, M8 to M15	4	13	7.2	3.4	3.3	4.8	11.0	16.6	5.6
	HT/VHT20 Beam Forming, M16 to M23	4	13	9.1	5.3	5.3	6.9	13.0	16.6	3.6
	HT/VHT20 STBC, M0 to M7	2	13	11.2	7.2			12.7	16.6	3.9
	HT/VHT20 STBC, M0 to M7	3	13	10.0	6.4	6.4		12.7	16.6	3.9
	HT/VHT20 STBC, M0 to M7	4	13	7.2	3.4	3.3	4.8	11.0	16.6	5.6
	5510	Non HT40, 6 to 54 Mbps	1	13	5.8				5.8	17.0
Non HT40, 6 to 54 Mbps		2	13	1.7	-1.2			3.5	17.0	13.5
Non HT40, 6 to 54 Mbps		3	13	1.7	-1.2	-1.8		4.6	17.0	12.4
Non HT40, 6 to 54 Mbps		4	13	-0.1	-3.2	-3.8	-2.4	3.9	17.0	13.1
HT/VHT40, M0 to M7		1	13	8.4				8.4	17.0	8.6



	HT/VHT40, M0 to M7	2	13	8.4	5.5			10.2	17.0	6.8
	HT/VHT40, M8 to M15	2	13	8.4	5.5			10.2	17.0	6.8
	HT/VHT40, M0 to M7	3	13	6.5	3.6	3.2		9.5	17.0	7.5
	HT/VHT40, M8 to M15	3	13	6.5	3.6	3.2		9.5	17.0	7.5
	HT/VHT40, M16 to M23	3	13	6.5	3.6	3.2		9.5	17.0	7.5
	HT/VHT40, M0 to M7	4	13	5.5	2.7	2.2	3.3	9.6	17.0	7.4
	HT/VHT40, M8 to M15	4	13	5.5	2.7	2.2	3.3	9.6	17.0	7.4
	HT/VHT40, M16 to M23	4	13	5.5	2.7	2.2	3.3	9.6	17.0	7.4
	HT/VHT40 Beam Forming, M0 to M7	2	13	8.4	5.5			10.2	17.0	6.8
	HT/VHT40 Beam Forming, M8 to M15	2	13	8.4	5.5			10.2	17.0	6.8
	HT/VHT40 Beam Forming, M0 to M7	3	16	3.4	0.6	0.1		6.4	14.0	7.6
	HT/VHT40 Beam Forming, M8 to M15	3	13	6.5	3.6	3.2		9.5	17.0	7.5
	HT/VHT40 Beam Forming, M16 to M23	3	13	6.5	3.6	3.2		9.5	17.0	7.5
	HT/VHT40 Beam Forming, M0 to M7	4	16	2.4	-0.3	-1.0	0.2	6.5	14.0	7.5
	HT/VHT40 Beam Forming, M8 to M15	4	13	5.5	2.7	2.2	3.3	9.6	17.0	7.4
	HT/VHT40 Beam Forming, M16 to M23	4	13	5.5	2.7	2.2	3.3	9.6	17.0	7.4
	HT/VHT40 STBC, M0 to M7	2	13	8.4	5.5			10.2	17.0	6.8
	HT/VHT40 STBC, M0 to M7	3	13	6.5	3.6	3.2		9.5	17.0	7.5
	HT/VHT40 STBC, M0 to M7	4	13	5.5	2.7	2.2	3.3	9.6	17.0	7.4
5530	Non HT80, 6 to 54 Mbps	1	13	9.1				9.1	17.0	7.9
	Non HT80, 6 to 54 Mbps	2	13	7.0	5.5			9.3	17.0	7.7
	Non HT80, 6 to 54 Mbps	3	13	6.1	4.5	3.6		9.6	17.0	7.4
	Non HT80, 6 to 54 Mbps	4	13	6.1	4.5	3.6	3.7	10.6	17.0	6.4
	VHT80, M0 to M9 1ss	1	13	12.7				12.7	17.0	4.3
	VHT80, M0 to M9 1ss	2	13	11.6	10.0			13.9	17.0	3.1
	VHT80, M0 to M9 2ss	2	13	11.6	10.0			13.9	17.0	3.1
	VHT80, M0 to M9 1ss	3	13	10.7	9.0	8.0		14.2	17.0	2.8
	VHT80, M0 to M9 2ss	3	13	10.7	9.0	8.0		14.2	17.0	2.8
	VHT80, M0 to M9 3ss	3	13	10.7	9.0	8.0		14.2	17.0	2.8
	VHT80, M0 to M9 1ss	4	13	9.8	8.1	7.0	7.3	14.2	17.0	2.8
	VHT80, M0 to M9 2ss	4	13	9.8	8.1	7.0	7.3	14.2	17.0	2.8
	VHT80, M0 to M9 3ss	4	13	9.8	8.1	7.0	7.3	14.2	17.0	2.8
	VHT80 Beam Forming, M0 to M9 1ss	2	13	11.6	10.0			13.9	17.0	3.1
	VHT80 Beam Forming, M0 to M9 2ss	2	13	11.6	10.0			13.9	17.0	3.1
	VHT80 Beam Forming, M0 to M9 1ss	3	13	8.5	7.0	5.9		12.0	17.0	5.0
	VHT80 Beam Forming, M0 to M9 2ss	3	13	10.7	9.0	8.0		14.2	17.0	2.8
	VHT80 Beam Forming, M0 to M9 3ss	3	13	10.7	9.0	8.0		14.2	17.0	2.8
	VHT80 Beam Forming, M0 to M9 1ss	4	13	6.6	4.9	4.0	4.2	11.1	17.0	5.9
	VHT80 Beam Forming, M0 to M9 2ss	4	13	9.8	8.1	7.0	7.3	14.2	17.0	2.8
VHT80 Beam Forming, M0 to M9 3ss	4	13	9.8	8.1	7.0	7.3	14.2	17.0	2.8	



	VHT80 STBC, M0 to M9 1ss	2	13	11.6	10.0			13.9	17.0	3.1
	VHT80 STBC, M0 to M9 1ss	3	13	10.7	9.0	8.0		14.2	17.0	2.8
	VHT80 STBC, M0 to M9 1ss	4	13	9.8	8.1	7.0	7.3	14.2	17.0	2.8
5570	Non HT160, 6 to 54 Mbps	1	13	9.4				9.4	17.0	7.6
	Non HT160, 6 to 54 Mbps	2	13	0.6	-0.7			3.0	17.0	14.0
	Non HT160, 6 to 54 Mbps	3	13	0.6	-0.7	-1.7		4.3	17.0	12.7
	Non HT160, 6 to 54 Mbps	4	13	0.6	-0.7	-1.7	-1.6	5.3	17.0	11.7
	VHT160, M0 to M9 1ss	1	13	11.8				11.8	17.0	5.2
	VHT160, M0 to M9 1ss	2	13	10.1	8.6			12.4	17.0	4.6
	VHT160, M0 to M9 2ss	2	13	10.1	8.6			12.4	17.0	4.6
	VHT160, M0 to M9 1ss	3	13	10.1	8.6	7.6		13.7	17.0	3.3
	VHT160, M0 to M9 2ss	3	13	10.1	8.6	7.6		13.7	17.0	3.3
	VHT160, M0 to M9 3ss	3	13	10.1	8.6	7.6		13.7	17.0	3.3
	VHT160, M0 to M9 1ss	4	13	9.2	7.7	6.6	6.9	13.7	17.0	3.3
	VHT160, M0 to M9 2ss	4	13	9.2	7.7	6.6	6.9	13.7	17.0	3.3
	VHT160, M0 to M9 3ss	4	13	9.2	7.7	6.6	6.9	13.7	17.0	3.3
	VHT160 Beam Forming, M0 to M9 1ss	2	13	10.1	8.6			12.4	17.0	4.6
	VHT160 Beam Forming, M0 to M9 2ss	2	13	10.1	8.6			12.4	17.0	4.6
	VHT160 Beam Forming, M0 to M9 1ss	3	13	8.0	6.5	5.4		11.5	17.0	5.5
	VHT160 Beam Forming, M0 to M9 2ss	3	13	10.1	8.6	7.6		13.7	17.0	3.3
	VHT160 Beam Forming, M0 to M9 3ss	3	13	10.1	8.6	7.6		13.7	17.0	3.3
	VHT160 Beam Forming, M0 to M9 1ss	4	13	6.1	4.6	3.7	3.7	10.7	17.0	6.3
	VHT160 Beam Forming, M0 to M9 2ss	4	13	9.2	7.7	6.6	6.9	13.7	17.0	3.3
	VHT160 Beam Forming, M0 to M9 3ss	4	13	9.2	7.7	6.6	6.9	13.7	17.0	3.3
VHT160 STBC, M0 to M9 1ss	2	13	10.1	8.6			12.4	17.0	4.6	
VHT160 STBC, M0 to M9 1ss	3	13	10.1	8.6	7.6		13.7	17.0	3.3	
VHT160 STBC, M0 to M9 1ss	4	13	9.2	7.7	6.6	6.9	13.7	17.0	3.3	
5560	Non HT20, 6 to 54 Mbps	1	13	13.9				13.9	16.6	2.7
	Non HT20, 6 to 54 Mbps	2	13	7.8	8.2			11.0	16.6	5.6
	Non HT20, 6 to 54 Mbps	3	13	3.8	4.2	4.4		8.9	16.6	7.7
	Non HT20, 6 to 54 Mbps	4	13	1.8	2.2	2.4	2.7	8.3	16.6	8.3
	Non HT20 Beam Forming, 6 to 54 Mbps	2	13	7.8	8.2			11.0	16.6	5.6
	Non HT20 Beam Forming, 6 to 54 Mbps	3	16	3.8	4.2	4.4		8.9	13.6	4.7
	Non HT20 Beam Forming, 6 to 54 Mbps	4	16	1.8	2.2	2.4	2.7	8.3	13.6	5.3
	HT/VHT20, M0 to M7	1	13	14.0				14.0	16.6	2.6
	HT/VHT20, M0 to M7	2	13	8.0	8.3			11.2	16.6	5.4
	HT/VHT20, M8 to M15	2	13	10.9	11.3			14.1	16.6	2.5
	HT/VHT20, M0 to M7	3	13	4.0	4.4	4.5		9.1	16.6	7.5
	HT/VHT20, M8 to M15	3	13	6.8	7.3	7.4		11.9	16.6	4.7



	HT/VHT20, M16 to M23	3	13	9.0	9.3	9.4		14.0	16.6	2.6
	HT/VHT20, M0 to M7	4	13	2.0	2.4	2.6	2.9	8.5	16.6	8.1
	HT/VHT20, M8 to M15	4	13	5.0	5.4	5.5	5.8	11.5	16.6	5.1
	HT/VHT20, M16 to M23	4	13	6.8	7.3	7.4	7.6	13.3	16.6	3.3
	HT/VHT20 Beam Forming, M0 to M7	2	13	8.0	8.3			11.2	16.6	5.4
	HT/VHT20 Beam Forming, M8 to M15	2	13	10.9	11.3			14.1	16.6	2.5
	HT/VHT20 Beam Forming, M0 to M7	3	16	4.0	4.4	4.5		9.1	13.6	4.5
	HT/VHT20 Beam Forming, M8 to M15	3	13	6.8	7.3	7.4		11.9	16.6	4.7
	HT/VHT20 Beam Forming, M16 to M23	3	13	9.0	9.3	9.4		14.0	16.6	2.6
	HT/VHT20 Beam Forming, M0 to M7	4	16	2.0	2.4	2.6	2.9	8.5	13.6	5.1
	HT/VHT20 Beam Forming, M8 to M15	4	13	5.0	5.4	5.5	5.8	11.5	16.6	5.1
	HT/VHT20 Beam Forming, M16 to M23	4	13	6.8	7.3	7.4	7.6	13.3	16.6	3.3
	HT/VHT20 STBC, M0 to M7	2	13	10.9	11.3			14.1	16.6	2.5
	HT/VHT20 STBC, M0 to M7	3	13	6.8	7.3	7.4		11.9	16.6	4.7
	HT/VHT20 STBC, M0 to M7	4	13	5.0	5.4	5.5	5.8	11.5	16.6	5.1
5660	Non HT20, 6 to 54 Mbps	1	13	13.6				13.6	16.6	3.0
	Non HT20, 6 to 54 Mbps	2	13	8.0	6.5			10.3	16.6	6.3
	Non HT20, 6 to 54 Mbps	3	13	5.1	3.6	3.6		8.9	16.6	7.7
	Non HT20, 6 to 54 Mbps	4	13	3.2	1.7	1.5	1.3	8.0	16.6	8.6
	Non HT20 Beam Forming, 6 to 54 Mbps	2	13	8.0	6.5			10.3	16.6	6.3
	Non HT20 Beam Forming, 6 to 54 Mbps	3	16	5.1	3.6	3.6		8.9	13.6	4.7
	Non HT20 Beam Forming, 6 to 54 Mbps	4	16	3.2	1.7	1.5	1.3	8.0	13.6	5.6
	HT/VHT20, M0 to M7	1	13	13.7				13.7	16.6	2.9
	HT/VHT20, M0 to M7	2	13	9.4	7.5			11.6	16.6	5.0
	HT/VHT20, M8 to M15	2	13	11.3	9.8			13.6	16.6	3.0
	HT/VHT20, M0 to M7	3	13	5.2	3.8	3.8		9.1	16.6	7.5
	HT/VHT20, M8 to M15	3	13	8.1	6.6	6.8		12.0	16.6	4.6
	HT/VHT20, M16 to M23	3	13	10.3	8.8	8.7		14.1	16.6	2.5
	HT/VHT20, M0 to M7	4	13	3.3	1.8	1.6	1.4	8.1	16.6	8.5
	HT/VHT20, M8 to M15	4	13	6.1	4.7	4.8	4.5	11.1	16.6	5.5
	HT/VHT20, M16 to M23	4	13	8.1	6.6	6.8	6.6	13.1	16.6	3.5
	HT/VHT20 Beam Forming, M0 to M7	2	13	9.4	7.5			11.6	16.6	5.0
	HT/VHT20 Beam Forming, M8 to M15	2	13	11.3	9.8			13.6	16.6	3.0
	HT/VHT20 Beam Forming, M0 to M7	3	16	5.2	3.8	3.8		9.1	13.6	4.5
	HT/VHT20 Beam Forming, M8 to M15	3	13	8.1	6.6	6.8		12.0	16.6	4.6
	HT/VHT20 Beam Forming, M16 to M23	3	13	10.3	8.8	8.7		14.1	16.6	2.5
	HT/VHT20 Beam Forming, M0 to M7	4	16	3.3	1.8	1.6	1.4	8.1	13.6	5.5
HT/VHT20 Beam Forming, M8 to M15	4	13	6.1	4.7	4.8	4.5	11.1	16.6	5.5	
HT/VHT20 Beam Forming, M16 to M23	4	13	8.1	6.6	6.8	6.6	13.1	16.6	3.5	
HT/VHT20 STBC, M0 to M7	2	13	11.3	9.8			13.6	16.6	3.0	



	HT/VHT20 STBC, M0 to M7	3	13	8.1	6.6	6.8		12.0	16.6	4.6
	HT/VHT20 STBC, M0 to M7	4	13	6.1	4.7	4.8	4.5	11.1	16.6	5.5
5670	Non HT40, 6 to 54 Mbps	1	13	16.6				16.6	17.0	0.4
	Non HT40, 6 to 54 Mbps	2	13	11.1	10.5			13.8	17.0	3.2
	Non HT40, 6 to 54 Mbps	3	13	7.1	6.3	5.8		11.2	17.0	5.8
	Non HT40, 6 to 54 Mbps	4	13	6.1	5.4	4.8	4.5	11.3	17.0	5.7
	HT/VHT40, M0 to M7	1	13	16.6				16.6	17.0	0.4
	HT/VHT40, M0 to M7	2	13	11.0	10.2			13.6	17.0	3.4
	HT/VHT40, M8 to M15	2	13	13.1	13.8			16.5	17.0	0.5
	HT/VHT40, M0 to M7	3	13	7.8	7.0	6.4		11.9	17.0	5.1
	HT/VHT40, M8 to M15	3	13	11.0	10.2	9.5		15.0	17.0	2.0
	HT/VHT40, M16 to M23	3	13	11.1	11.9	12.1		16.5	17.0	0.5
	HT/VHT40, M0 to M7	4	13	5.9	5.1	4.6	4.1	11.0	17.0	6.0
	HT/VHT40, M8 to M15	4	13	8.7	8.2	7.4	7.3	14.0	17.0	3.0
	HT/VHT40, M16 to M23	4	13	11.0	10.2	9.5	9.3	16.1	17.0	0.9
	HT/VHT40 Beam Forming, M0 to M7	2	13	11.0	10.2			13.6	17.0	3.4
	HT/VHT40 Beam Forming, M8 to M15	2	13	13.1	13.8			16.5	17.0	0.5
	HT/VHT40 Beam Forming, M0 to M7	3	16	7.8	7.0	6.4		11.9	14.0	2.1
	HT/VHT40 Beam Forming, M8 to M15	3	13	11.0	10.2	9.5		15.0	17.0	2.0
	HT/VHT40 Beam Forming, M16 to M23	3	13	11.1	11.9	12.1		16.5	17.0	0.5
	HT/VHT40 Beam Forming, M0 to M7	4	16	5.9	5.1	4.6	4.1	11.0	14.0	3.0
	HT/VHT40 Beam Forming, M8 to M15	4	13	8.7	8.2	7.4	7.3	14.0	17.0	3.0
	HT/VHT40 Beam Forming, M16 to M23	4	13	11.0	10.2	9.5	9.3	16.1	17.0	0.9
HT/VHT40 STBC, M0 to M7	2	13	13.1	13.8			16.5	17.0	0.5	
HT/VHT40 STBC, M0 to M7	3	13	11.0	10.2	9.5		15.0	17.0	2.0	
HT/VHT40 STBC, M0 to M7	4	13	8.7	8.2	7.4	7.3	14.0	17.0	3.0	
5690	Non HT80, 6 to 54 Mbps	1	13	15.7				15.7	17.0	1.3
	Non HT80, 6 to 54 Mbps	2	13	12.0	12.4			15.2	17.0	1.8
	Non HT80, 6 to 54 Mbps	3	13	9.9	10.3	10.3		14.9	17.0	2.1
	Non HT80, 6 to 54 Mbps	4	13	9.1	8.7	8.5	8.3	14.7	17.0	2.3
	VHT80, M0 to M9 1ss	1	13	15.9				15.9	17.0	1.1
	<b>VHT80, M0 to M9 1ss</b>	<b>2</b>	<b>13</b>	<b>13.7</b>	<b>14.2</b>			<b>17.0</b>	<b>17.0</b>	<b>0.0</b>
	VHT80, M0 to M9 2ss	2	13	13.7	14.2			17.0	17.0	0.0
	VHT80, M0 to M9 1ss	3	13	11.6	12.1	12.1		16.7	17.0	0.3
	VHT80, M0 to M9 2ss	3	13	11.6	12.1	12.1		16.7	17.0	0.3
	VHT80, M0 to M9 3ss	3	13	11.6	12.1	12.1		16.7	17.0	0.3
	VHT80, M0 to M9 1ss	4	13	10.8	10.6	8.9	8.8	15.9	17.0	1.1
	VHT80, M0 to M9 2ss	4	13	10.8	10.6	8.9	8.8	15.9	17.0	1.1
	VHT80, M0 to M9 3ss	4	13	10.8	10.6	8.9	8.8	15.9	17.0	1.1