

Test Report
AIR-AP3802P-B-K9
AIR-AP3802P-U XK9

Cisco Aironet 802.11ac Dual Band Access Points

FCC ID: LDK102101

5150-5250 MHz

XOR Radio

Against the following Specifications:

CFR47 Part 15.407

Cisco Systems

170 West Tasman Drive
San Jose, CA 95134

	
Author: Jose Aguirre Tested By	Approved By: Jim Nicholson Title: Technical Leader, Engineering Revision: 1

This report replaces any previously entered test report under EDCS – **1552569**. This test report has been electronically authorized and archived using the CISCO Engineering Document Control system.

This test report has been electronically authorized and archived using the CISCO Engineering Document Control system.

SECTION 1: OVERVIEW	4
SECTION 2: ASSESSMENT INFORMATION	5
2.1 GENERAL	5
2.2 DATE OF TESTING.....	7
2.3 REPORT ISSUE DATE	7
2.4 TESTING FACILITIES	7
2.5 EQUIPMENT ASSESSED (EUT).....	7
2.6 EUT DESCRIPTION.....	8
SECTION 3: RESULT SUMMARY	11
3.1 RESULTS SUMMARY TABLE	11
SECTION 4: SAMPLE DETAILS.....	13
APPENDIX A: EMISSION TEST RESULTS.....	14
CONDUCTED TEST SETUP DIAGRAM.....	14
TARGET MAXIMUM CHANNEL POWER	14
ANTENNA GAIN : 2 DBI	14
ANTENNA GAIN : 3 DBI	15
ANTENNA GAIN : 4 DBI	15
ANTENNA GAIN : 5 DBI	16
ANTENNA GAIN : 6 DBI	16
ANTENNA GAIN : 8 DBI	17
ANTENNA GAIN : 13 DBI.....	17
A.1 99% AND 26dB BANDWIDTH	18
A.2 MAXIMUM CONDUCTED OUTPUT POWER/ POWER SPECTRAL DENSITY	26
ANTENNA GAIN : 2 DBI	27
ANTENNA GAIN : 3 DBI	37
ANTENNA GAIN : 4 DBI	47
ANTENNA GAIN : 5 DBI	62
ANTENNA GAIN : 6 DBI	72
ANTENNA GAIN : 8 DBI	86
ANTENNA GAIN : 13 DBI.....	96
A.3 CONDUCTED SPURIOUS EMISSIONS.....	111
A.4 CONDUCTED BAND EDGE	123
ANTENNA GAIN : 2 DBI	124
ANTENNA GAIN : 3 DBI	131
ANTENNA GAIN : 4 DBI	137
ANTENNA GAIN : 5 DBI	143
ANTENNA GAIN : 6 DBI	149
ANTENNA GAIN : 8 DBI	155
ANTENNA GAIN : 13 DBI.....	161
APPENDIX B: EMISSION TEST RESULTS.....	168
RADIATED EMISSION SETUP DIAGRAM-BELOW 1G.....	168
RADIATED EMISSION SETUP DIAGRAM-ABOVE 1G	168



B.1	RADIATED SPURIOUS EMISSIONS	169
B.2	RADIATED EMISSIONS 30MHZ TO 1GHZ.....	182
B.3	AC CONDUCTED EMISSIONS	184
APPENDIX C:	LIST OF TEST EQUIPMENT USED TO PERFORM THE TEST.....	190
APPENDIX E:	ABBREVIATION KEY AND DEFINITIONS	192



Section 1: Overview

The samples were assessed against the tests detailed in section 3 under the requirements of the following specifications:

Specifications:
CFR47 Part 15.407

Measurements were made in accordance with

- ANSI C63.10:2013
- KDB 789033 D02 General UNII Test Procedures New Rules v01r01
- KDB 662911 D01 Multiple Transmitter Output v02r01

Section 2: Assessment Information

2.1 General

This report contains an assessment of an apparatus against Electromagnetic Compatibility Standards based upon tests carried out on the samples submitted. The testing was performed by and for the use of Cisco systems Inc:

With regard to this assessment, the following points should be noted:

- a) The results contained in this report relate only to the items tested and were obtained in the period between the date of the initial assessment and the date of issue of the report. Manufactured products will not necessarily give identical results due to production and measurement tolerances.
- b) The apparatus was set up and exercised using the configuration and modes of operation defined in this report only.
- c) Where relevant, the apparatus was only assessed using the susceptibility criteria defined in this report and the Test Assessment Plan (TAP).
- d) All testing was performed under the following environmental conditions:

Temperature	15°C to 35°C (54°F to 95°F)
Atmospheric Pressure	860mbar to 1060mbar (25.4" to 31.3")
Humidity	10% to 75*%
- e) All AC testing was performed at one or more of the following supply voltages:
110V 60 Hz (+/-20%)

Units of Measurement

The units of measurements defined in the appendices are reported in specific terms, which are test dependent. Where radiated measurements are concerned these are defined at a particular distance. Basic voltage measurements are defined in units of [dBuV]

As an example, the basic calculation for all measurements is as follows:

$$\text{Emission level [dBuV]} = \text{Indicated voltage level [dBuV]} + \text{Cable Loss [dB]} + \text{Other correction factors [dB]}$$

The combinations of correction factors are dependent upon the exact test configurations [see test equipment lists for further details] and may include:-

Antenna Factors, Pre Amplifier Gain, LISN Loss, Pulse Limiter Loss and Filter Insertion Loss..

Note: to convert the results from dBuV/m to uV/m use the following formula:-

$$\text{Level in uV/m} = \text{Common Antilogarithm} [(X \text{ dBuV/m})/20] = Y \text{ uV/m}$$

Measurement Uncertainty Values

voltage and power measurements	± 2 dB
conducted EIRP measurements	± 1.4 dB
radiated measurements	± 3.2 dB
frequency measurements	± 2.4 10 ⁻⁷
temperature measurements	± 0.54°
humidity measurements	± 2.3%
DC and low frequency measurements	± 2.5%

Where relevant measurement uncertainty levels have been estimated for tests performed on the apparatus. This uncertainty represents an expanded uncertainty expressed at approximately the 95% confidence level using a coverage factor of k=2.

Radiated emissions (expanded uncertainty, confidence interval 95%)

30 MHz - 300 MHz	+/- 3.8 dB
300 MHz - 1000 MHz	+/- 4.3 dB
1 GHz - 10 GHz	+/- 4.0 dB
10 GHz - 18GHz	+/- 8.2 dB
18GHz - 26.5GHz	+/- 4.1 dB
26.5GHz - 40GHz	+/- 3.9 dB

Conducted emissions (expanded uncertainty, confidence interval 95%)

30 MHz – 40GHz	+/- 0.38 dB
----------------	-------------

A product is considered to comply with a requirement if the nominal measured value is below the limit line. The product is considered to not be in compliance in case the nominal measured value is above the limit line.

This report must not be reproduced except in full, without written approval of Cisco Systems.

2.2 Date of testing

01-Jan-16 - 29-Feb-16

2.3 Report Issue Date

22-March-2016

Cisco uses an electronic system to issue, store and control the revision of test reports. This system is called the Engineering Document Control System (EDCS). The actual report issue date is embedded into the original file on EDCS. Any copies of this report, either electronic or paper, that are not on EDCS must be considered uncontrolled.

2.4 Testing facilities

This assessment was performed by:

Testing Laboratory

Cisco Systems, Inc.,
125 West Tasman Drive
San Jose, CA 95134, USA

Registration Numbers for Industry Canada

Cisco System Site	Address	Site Identifier
Building P, 10m Chamber	125 West Tasman Dr San Jose, CA 95134	Company #: 2461N-2
Building P, 5m Chamber	125 West Tasman Dr San Jose, CA 95134	Company #: 2461N-1
Building I, 5m Chamber	285 W. Tasman Drive San Jose, California 95134	Company #: 2461M-1

Test Engineers

Jose Aguirre

2.5 Equipment Assessed (EUT)

AIR-AP3802P-B-K9

2.6 EUT Description

The Cisco Aironet 802.11ac Radio supports the following modes of operation. The modes are further defined in the radio Theory of Operation. The modes included in this report represent the worst case data for all modes.

- 802.11n/ac - Non HT20, One Antenna, 6 to 54 Mbps
- 802.11n/ac - Non HT20, Two Antennas, 6 to 54 Mbps
- 802.11n/ac - Non HT20, Three Antennas, 6 to 54 Mbps
- 802.11n/ac - Non HT20, Four Antennas, 6 to 54 Mbps

- 802.11n/ac - Non HT20 Beam Forming, Two Antennas, 6 to 54 Mbps
- 802.11n/ac - Non HT20 Beam Forming, Three Antennas, 6 to 54 Mbps
- 802.11n/ac - Non HT20 Beam Forming, Four Antennas, 6 to 54 Mbps

- 802.11n/ac - HT/VHT20, One Antenna, M0 to M7
- 802.11n/ac - HT/VHT20, Two Antennas, M0 to M7
- 802.11n/ac - HT/VHT20, Two Antennas, M8 to M15
- 802.11n/ac - HT/VHT20, Three Antennas, M0 to M7
- 802.11n/ac - HT/VHT20, Three Antennas, M8 to M15
- 802.11n/ac - HT/VHT20, Three Antennas, M16 to M23
- 802.11n/ac - HT/VHT20, Four Antennas, M0 to M7
- 802.11n/ac - HT/VHT20, Four Antennas, M8 to M15
- 802.11n/ac - HT/VHT20, Four Antennas, M16 to M23

- 802.11n/ac - HT/VHT20 Beam Forming, Two Antennas, M0 to M7
- 802.11n/ac - HT/VHT20 Beam Forming, Two Antennas, M8 to M15
- 802.11n/ac - HT/VHT20 Beam Forming, Three Antennas, M0 to M7
- 802.11n/ac - HT/VHT20 Beam Forming, Three Antennas, M8 to M15
- 802.11n/ac - HT/VHT20 Beam Forming, Three Antennas, M16 to M23
- 802.11n/ac - HT/VHT20 Beam Forming, Four Antennas, M0 to M7
- 802.11n/ac - HT/VHT20 Beam Forming, Four Antennas, M8 to M15
- 802.11n/ac - HT/VHT20 Beam Forming, Four Antennas, M16 to M23

- 802.11n/ac - HT/VHT20 STBC, Two Antennas, M0 to M7
- 802.11n/ac - HT/VHT20 STBC, Three Antennas, M0 to M7
- 802.11n/ac - HT/VHT20 STBC, Four Antennas, M0 to M7

- 802.11n/ac - Non HT40 Duplicate, One Antenna, 6 to 54 Mbps
- 802.11n/ac - Non HT40 Duplicate, Two Antennas, 6 to 54 Mbps
- 802.11n/ac - Non HT40 Duplicate, Three Antennas, 6 to 54 Mbps
- 802.11n/ac - Non HT40 Duplicate, Four Antennas, 6 to 54 Mbps

- 802.11n/ac - HT/VHT40, One Antenna, M0 to M7
- 802.11n/ac - HT/VHT40, Two Antennas, M0 to M7
- 802.11n/ac - HT/VHT40, Two Antennas, M8 to M15
- 802.11n/ac - HT/VHT40, Three Antennas, M0 to M7
- 802.11n/ac - HT/VHT40, Three Antennas, M8 to M15
- 802.11n/ac - HT/VHT40, Three Antennas, M16 to M23
- 802.11n/ac - HT/VHT40, Four Antennas, M0 to M7
- 802.11n/ac - HT/VHT40, Four Antennas, M8 to M15
- 802.11n/ac - HT/VHT40, Four Antennas, M16 to M23

802.11n/ac - HT/VHT40 Beam Forming, Two Antennas, M0 to M7
802.11n/ac - HT/VHT40 Beam Forming, Two Antennas, M8 to M15
802.11n/ac - HT/VHT40 Beam Forming, Three Antennas, M0 to M7
802.11n/ac - HT/VHT40 Beam Forming, Three Antennas, M8 to M15
802.11n/ac - HT/VHT40 Beam Forming, Three Antennas, M16 to M23
802.11n/ac - HT/VHT40 Beam Forming, Four Antennas, M0 to M7
802.11n/ac - HT/VHT40 Beam Forming, Four Antennas, M8 to M15
802.11n/ac - HT/VHT40 Beam Forming, Four Antennas, M16 to M23

802.11n/ac - HT/VHT40 STBC, Two Antennas, M0 to M7
802.11n/ac - HT/VHT40 STBC, Three Antennas, M0 to M7
802.11n/ac - HT/VHT40 STBC, Four Antennas, M0 to M7

802.11n/ac - Non HT80 Duplicate, One Antenna, 6 to 54 Mbps
802.11n/ac - Non HT80 Duplicate, Two Antennas, 6 to 54 Mbps
802.11n/ac - Non HT80 Duplicate, Three Antennas, 6 to 54 Mbps
802.11n/ac - Non HT80 Duplicate, Four Antennas, 6 to 54 Mbps

802.11ac - VHT80, One Antenna, M0 to M9 1ss
802.11ac - VHT80, Two Antennas, M0 to M9 1ss
802.11ac - VHT80, Two Antennas, M0 to M9 2ss
802.11ac - VHT80, Three Antennas, M0 to M9 1ss
802.11ac - VHT80, Three Antennas, M0 to M9 2ss
802.11ac - VHT80, Three Antennas, M0 to M9 3ss
802.11ac - VHT80, Four Antennas, M0 to M9 1ss
802.11ac - VHT80, Four Antennas, M0 to M9 2ss
802.11ac - VHT80, Four Antennas, M0 to M9 3ss

802.11ac - VHT80 Beam Forming, Two Antennas, M0 to M9 1ss
802.11ac - VHT80 Beam Forming, Two Antennas, M0 to M9 2ss
802.11ac - VHT80 Beam Forming, Three Antennas, M0 to M9 1ss
802.11ac - VHT80 Beam Forming, Three Antennas, M0 to M9 2ss
802.11ac - VHT80 Beam Forming, Three Antennas, M0 to M9 3ss
802.11ac - VHT80 Beam Forming, Four Antennas, M0 to M9 1ss
802.11ac - VHT80 Beam Forming, Four Antennas, M0 to M9 2ss
802.11ac - VHT80 Beam Forming, Four Antennas, M0 to M9 3ss

802.11ac - VHT80 STBC, Two Antennas, M0 to M9 1ss
802.11ac - VHT80 STBC, Three Antennas, M0 to M9 1ss
802.11ac - VHT80 STBC, Four Antennas, M0 to M9 1ss

The following antennas are supported by this product series.
The data included in this report represent the worst case data for all antennas.

Frequency	Part Number	Antenna Type	Antenna Gain (dBi)	Model	Antenna Gain >30 degrees (dBi)
2.4 GHz	AIR-ANT24020V-R	Omni	2	3800P	NA
	AIR-ANT2452V-R	Diversity Omni-directional	5.2	3800P	NA
	AIR-ANT2430V-R	MIMO 3-Element Omni	3	3800P	NA
	AIR-ANT2440NV-R	MIMO Wall-Mount Omni Antenna	4	3800P	NA
	AIR-ANT2460NP-R	MIMO 3-Element Patch	6	3800P	NA
5 GHz	AIR-ANT5140V-R	MIMO 3-Element Omni	4	3800P	Indoor Only
	AIR-ANT5140NV-R	MIMO Wall-Mount Omni Antenna	4	3800P	-8
	AIR-ANT5145V-R	Diversity Omni-directional	4.5	3800P	Indoor Only
	AIR-ANT5160NP-R	MIMO 3-Element Patch	6	3800P	3
2.4 / 5 GHz	AIR-ANT2451V-R	Omni	2 / 3	3800P	Indoor Only
	AIR-ANT2451NV-R	Omni	3 / 4	3800P	Indoor Only
	AIR-ANT2524DB-R	Dual-resonant black dipole	2 / 4	3800P	Indoor Only
	AIR-ANT2524DW-R	Dual-resonant white dipole	2 / 4	3800P	Indoor Only
	AIR-ANT2524DG-R	Dual-resonant gray dipole	2 / 4	3800P	Indoor Only
	AIR-ANT2524V4C-R	Dual-resonant ceiling mount omni (4-pack)	2 / 4	3800P	Indoor Only
	AIR-ANT2535SDW-R	Dual-resonant "stubby" monopole	3 / 5	3800P	Indoor Only
	AIR-ANT2544V4M-R	Dual-resonant omni (4-pack)	4 / 4	3800P	Indoor Only
	AIR-ANT2566P4W-R	Dual-resonant "directional" antenna (4-pack)	6 / 6	3800P	3
	AIR-ANT2566D4M-R	Dual-Band Polarization-Diverse Directional Array	6 / 6	3800P	3
	AIR-ANT2513P4M-N	Dual-resonant cross-pol "directional" antenna (4-pack)	13 / 13	3800P	-7
	AIR-ANT25-LOC-02	Directional HL / Directional WiFi	3 / 4	3800P	
	AIR-ANT25-LOC-03	Linear HL / Omni WiFi	0 / 1	3800P	
AIR-ANT25-LOC-04	Omni HL / Omni WiFi	0 / 1	3800P		

Section 3: Result Summary

3.1 Results Summary Table

Conducted emissions

Basic Standard	Technical Requirements / Details	Result
FCC 15.407	<p>99% & 26 dB Bandwidth: The 99% occupied bandwidth is the frequency bandwidth such that, below its lower and above its upper frequency limits, the mean powers are each equal to 0.5% of the total mean power of the given emission. There is no limit for 99% OBW.</p> <p>The 26 dB emission is the width of the emission that is constrained by the frequencies associated with the two outermost amplitude points (upper and lower frequencies) that are attenuated by 26 dB relative to the maximum level measured in the fundamental emission.</p>	Pass
FCC 15.407	<p>Output Power: 15.407: (i) For an outdoor access point operating in the band 5.15-5.25 GHz, the maximum conducted output power over the frequency band of operation shall not exceed 1 W provided the maximum antenna gain does not exceed 6 dBi. If transmitting antennas of directional gain greater than 6 dBi are used, the maximum conducted output power shall be reduced by the amount in dB that the directional gain of the antenna exceeds 6 dBi. The maximum e.i.r.p. at any elevation angle above 30 degrees as measured from the horizon must not exceed 125 mW (21 dBm).</p> <p>(ii) For an indoor access point operating in the band 5.15-5.25 GHz, the maximum conducted output power over the frequency band of operation shall not exceed 1 W provided the maximum antenna gain does not exceed 6 dBi. If transmitting antennas of directional gain greater than 6 dBi are used, the maximum conducted output power shall be reduced by the amount in dB that the directional gain of the antenna exceeds 6 dBi.</p>	Pass
FCC 15.407	<p>Power Spectral Density: 15.407 The maximum power spectral density shall not exceed 17 dBm in any 1 megahertz band. If transmitting antennas of directional gain greater than 6 dBi are used, both the maximum conducted output power and the maximum power spectral density shall be reduced by the amount in dB that the directional gain of the antenna exceeds 6 dBi.</p>	Pass
FCC 15.407	<p>Conducted Spurious Emissions / Band-Edge: For transmitters operating in the 5.15-5.25 GHz band: all emissions outside of the 5.15-5.25 GHz band shall not exceed an EIRP of -27dBm/MHz.</p>	Pass
FCC 15.407 FCC 15.209 FCC 152.05	<p>Restricted band: Unwanted emissions falling within the restricted bands, as defined in FCC 15.205 (a) must also comply with the radiated emission limits specified in FCC 15.209 (a).</p>	Pass

Radiated Emissions (General requirements)

Basic Standard	Technical Requirements / Details	Result
FCC 15.209 FCC 15.205	TX Spurious Emissions: Except as provided elsewhere in this subpart, the emissions from an intentional radiator shall not exceed the field strength levels specified in the filed strength limits table in this section.	Pass
FCC 15.207	AC conducted Emissions: Except when the requirements applicable to a given device state otherwise, for any radio apparatus equipped to operate from the public utility AC power supply, either directly or indirectly (such as with a battery charger), the radio frequency voltage of emissions conducted back onto the AC power lines in the frequency range of 0.15 MHz to 30 MHz shall not exceed the limits shown in the table in these sections. The more stringent limit applies at the frequency range boundaries.	Pass

* MPE calculation is recorded in a separate report

Section 4: Sample Details

Note: Each sample was evaluated to ensure that its condition was suitable to be used as a test sample prior to the commencement of testing.

4.1 Sample Details

Sample No.	Equipment Details	Manufacturer	Hardware Rev.	Firmware Rev.	Software Rev.	Serial Number
S01	AIR-AP3802P-B-K9	Cisco Systems	01	Linux ver 3.14.33	U-boot	FOC1945132D
S02*	PWR-CUBE-B 341-100460-001	Delta	A0	NA	NA	Engineering sample

(*) S02 are support equipment Power supplies for EUT S01

4.2 System Details

System #	Description	Samples
1	AIR-AP3802P-B-K9	S01
2	PWR-CUBE-B	S02

4.3 Mode of Operation Details

Mode#	Description	Comments
1	Continuous Transmitting	Continuous Transmitting $\geq 98\%$ duty cycle

All measurements were made in accordance with

- ANSI C63.10:2013
- KDB 789033 D02 General UNII Test Procedures New Rules v01r01
- KDB 662911 D01 Multiple Transmitter Output V02r01

Appendix A: Emission Test Results

Conducted Test Setup Diagram

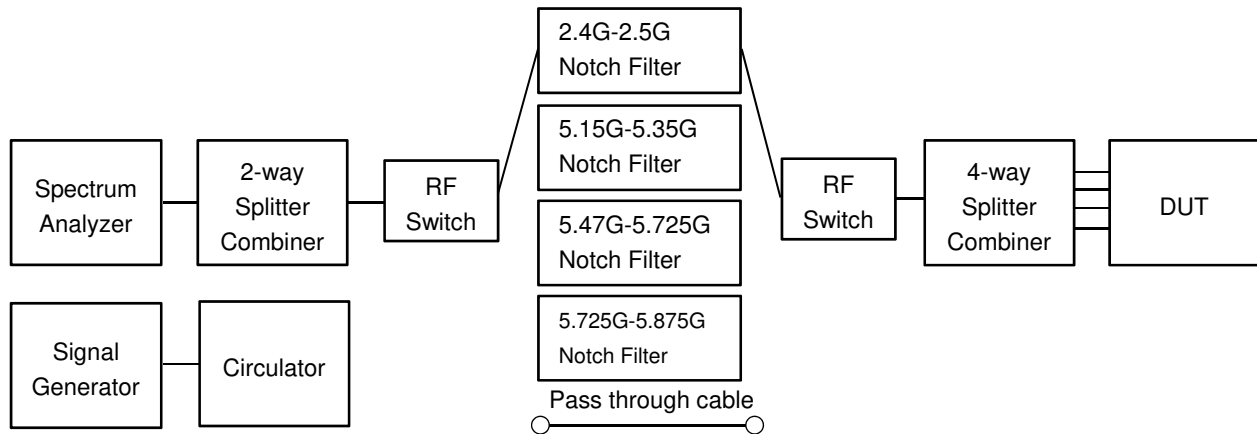

Target Maximum Channel Power

The following table details the maximum supported Total Channel Power for all operating modes.

Antenna Gain : 2 dBi

Operating Mode	Maximum Channel Power (dBm)		
	Frequency (MHz)		
	5180	5220	5240
Non HT20, 6 to 54 Mbps	24	24	24
Non HT20 Beam Forming, 6 to 54 Mbps	23	24	24
HT/VHT20, M0 to M23	24	24	24
HT/VHT20 Beam Forming, M0 to M23	24	24	24
HT/VHT20 STBC, M0 to M7	24	24	24
	5190	5230	
Non HT40, 6 to 54 Mbps	22	25	
HT/VHT40, M0 to M23	24	24	
HT/VHT40 Beam Forming, M0 to M23	24	24	
HT/VHT40 STBC, M0 to M7	24	24	
	5210		
Non HT80, 6 to 54 Mbps	21		
VHT80, M0 to M9, M0 to M9 1-1ss	24		
VHT80 Beam Forming, M0 to M9, M0 to M9 1-1ss	23		
VHT80 STBC, M0 to M9 1ss	24		

Antenna Gain : 3 dBi

Operating Mode	Maximum Channel Power (dBm)		
	Frequency (MHz)		
	5180	5220	5240
Non HT20, 6 to 54 Mbps	24	24	24
Non HT20 Beam Forming, 6 to 54 Mbps	23	24	24
HT/VHT20, M0 to M23	24	24	24
HT/VHT20 Beam Forming, M0 to M23	24	24	24
HT/VHT20 STBC, M0 to M7	24	24	24
	5190	5230	
Non HT40, 6 to 54 Mbps	21	25	
HT/VHT40, M0 to M23	24	24	
HT/VHT40 Beam Forming, M0 to M23	23	24	
HT/VHT40 STBC, M0 to M7	24	24	
	5210		
Non HT80, 6 to 54 Mbps	20		
VHT80, M0 to M9, M0 to M9 1-1ss	23		
VHT80 Beam Forming, M0 to M9, M0 to M9 1-1ss	23		
VHT80 STBC, M0 to M9 1ss	23		

Antenna Gain : 4 dBi

Operating Mode	Maximum Channel Power (dBm)		
	Frequency (MHz)		
	5180	5220	5240
Non HT20, 6 to 54 Mbps	23	23	23
Non HT20 Beam Forming, 6 to 54 Mbps	22	23	23
HT/VHT20, M0 to M23	24	24	24
HT/VHT20 Beam Forming, M0 to M23	24	24	24
HT/VHT20 STBC, M0 to M7	24	24	24
	5190	5230	
Non HT40, 6 to 54 Mbps	21	25	
HT/VHT40, M0 to M23	23	24	
HT/VHT40 Beam Forming, M0 to M23	23	24	
HT/VHT40 STBC, M0 to M7	23	24	
	5210		
Non HT80, 6 to 54 Mbps	20		
VHT80, M0 to M9, M0 to M9 1-1ss	22		
VHT80 Beam Forming, M0 to M9, M0 to M9 1-1ss	22		
VHT80 STBC, M0 to M9 1ss	22		

Antenna Gain : 5 dBi

Operating Mode	Maximum Channel Power (dBm)		
	Frequency (MHz)		
	5180	5220	5240
Non HT20, 6 to 54 Mbps	23	23	23
Non HT20 Beam Forming, 6 to 54 Mbps	22	23	23
HT/VHT20, M0 to M23	24	24	24
HT/VHT20 Beam Forming, M0 to M23	24	24	24
HT/VHT20 STBC, M0 to M7	24	24	24
	5190	5230	
Non HT40, 6 to 54 Mbps	21	24	
HT/VHT40, M0 to M23	23	24	
HT/VHT40 Beam Forming, M0 to M23	22	24	
HT/VHT40 STBC, M0 to M7	23	24	
	5210		
Non HT80, 6 to 54 Mbps	19		
VHT80, M0 to M9, M0 to M9 1-1ss	22		
VHT80 Beam Forming, M0 to M9, M0 to M9 1-1ss	22		
VHT80 STBC, M0 to M9 1ss	22		

Antenna Gain : 6 dBi

Operating Mode	Maximum Channel Power (dBm)		
	Frequency (MHz)		
	5180	5220	5240
Non HT20, 6 to 54 Mbps	18	18	18
Non HT20 Beam Forming, 6 to 54 Mbps	14	13	15
HT/VHT20, M0 to M23	18	18	18
HT/VHT20 Beam Forming, M0 to M23	18	18	18
HT/VHT20 STBC, M0 to M7	18	18	18
	5190	5230	
Non HT40, 6 to 54 Mbps	17	18	
HT/VHT40, M0 to M23	18	18	
HT/VHT40 Beam Forming, M0 to M23	18	17	
HT/VHT40 STBC, M0 to M7	18	17	
	5210		
Non HT80, 6 to 54 Mbps	18		
VHT80, M0 to M9, M0 to M9 1-1ss	18		
VHT80 Beam Forming, M0 to M9, M0 to M9 1-1ss	17		
VHT80 STBC, M0 to M9 1ss	17		

Antenna Gain : 8 dBi

Operating Mode	Maximum Channel Power (dBm)		
	Frequency (MHz)		
	5180	5220	5240
Non HT20, 6 to 54 Mbps	22	21	20
Non HT20 Beam Forming, 6 to 54 Mbps	22	21	20
HT/VHT20, M0 to M23	23	24	24
HT/VHT20 Beam Forming, M0 to M23	23	24	24
HT/VHT20 STBC, M0 to M7	23	23	23
	5190	5230	
Non HT40, 6 to 54 Mbps	20	23	
HT/VHT40, M0 to M23	21	24	
HT/VHT40 Beam Forming, M0 to M23	21	24	
HT/VHT40 STBC, M0 to M7	21	24	
	5210		
Non HT80, 6 to 54 Mbps	18		
VHT80, M0 to M9, M0 to M9 1-1ss	19		
VHT80 Beam Forming, M0 to M9, M0 to M9 1-1ss	19		
VHT80 STBC, M0 to M9 1ss	19		

Antenna Gain : 13 dBi

Operating Mode	Maximum Channel Power (dBm)		
	Frequency (MHz)		
	5180	5220	5240
Non HT20, 6 to 54 Mbps	19	18	17
Non HT20 Beam Forming, 6 to 54 Mbps	17	17	17
HT/VHT20, M0 to M23	20	20	20
HT/VHT20 Beam Forming, M0 to M23	20	20	20
HT/VHT20 STBC, M0 to M7	19	20	20
	5190	5230	
Non HT40, 6 to 54 Mbps	17	19	
HT/VHT40, M0 to M23	18	23	
HT/VHT40 Beam Forming, M0 to M23	18	23	
HT/VHT40 STBC, M0 to M7	18	21	
	5210		
Non HT80, 6 to 54 Mbps	13		
VHT80, M0 to M9, M0 to M9 1-1ss	15		
VHT80 Beam Forming, M0 to M9, M0 to M9 1-1ss	15		
VHT80 STBC, M0 to M9 1ss	15		

A.1 99% and 26dB Bandwidth

FCC 15.407 The 99% occupied bandwidth is the frequency bandwidth such that, below its lower and above its upper frequency limits, the mean powers are each equal to 0.5% of the total mean power of the given emission. There is no limit for 99% OBW.

The 26 dB emission is the width of the emission that is constrained by the frequencies associated with the two outermost amplitude points (upper and lower frequencies) that are attenuated by 26 dB relative to the maximum level measured in the fundamental emission.

Test Procedure

Ref. ANSI C63.10: 2013 Section 6.9.3

99% BW and EBW (-26dB)

Test Procedure

1. Set the radio in the continuous transmitting mode.
2. Allow the trace to stabilize.
3. Setting the x-dB bandwidth mode to -26dB and OBW power function to 99% within the measurement set up function.
4. Select the automatic OBW measurement function of an instrument to perform bandwidth measurement.
5. Capture graphs and record pertinent measurement data.

Ref. ANSI C63.10: 2013 Section 6.9.3

99% BW and EBW (-26dB)

Test parameters

Span = 1.5 x to 5.0 times OBW

RBW = approx. 1% to 5% of the OBW

VBW \geq 3 x RBW

Detector = Peak or where practical sample shall be used

Trace = Max. Hold

System Number	Description	Samples	System under test	Support equipment
1	EUT	S01	<input checked="" type="checkbox"/>	<input type="checkbox"/>
	Support	S02	<input type="checkbox"/>	<input checked="" type="checkbox"/>

Tested By :

Jose Aguirre

Date of testing:

01-Jan-16 - 29-Feb-16

Test Result : PASS

See Appendix C for list of test equipment



Frequency (MHz)	Mode	Data Rate (Mbps)	26dB BW (MHz)	99% BW (MHz)
5180	Non HT20, 6 to 54 Mbps	6	23.8	18.0
	HT/VHT20, M0 to M23	m0	24.3	18.3
5190	Non HT40, 6 to 54 Mbps	6	58.4	37.3
	HT/VHT40, M0 to M23	m0	43.6	36.6
5210	Non HT80, 6 to 54 Mbps	6	95.3	76.4
	VHT80, M0 to M9, M0 to M9 1-1ss	m0x1	83.8	76.4
5220	Non HT20, 6 to 54 Mbps	6	23.6	18.0
	HT/VHT20, M0 to M23	m0	22.4	18.3
5230	Non HT40, 6 to 54 Mbps	6	73.0	37.7
	HT/VHT40, M0 to M23	m0	45.4	36.6
5240	Non HT20, 6 to 54 Mbps	6	22.6	18.0
	HT/VHT20, M0 to M23	m0	24.4	18.3



26dB / 99% Bandwidth, 5180 MHz, Non HT20, 6 to 54 Mbps

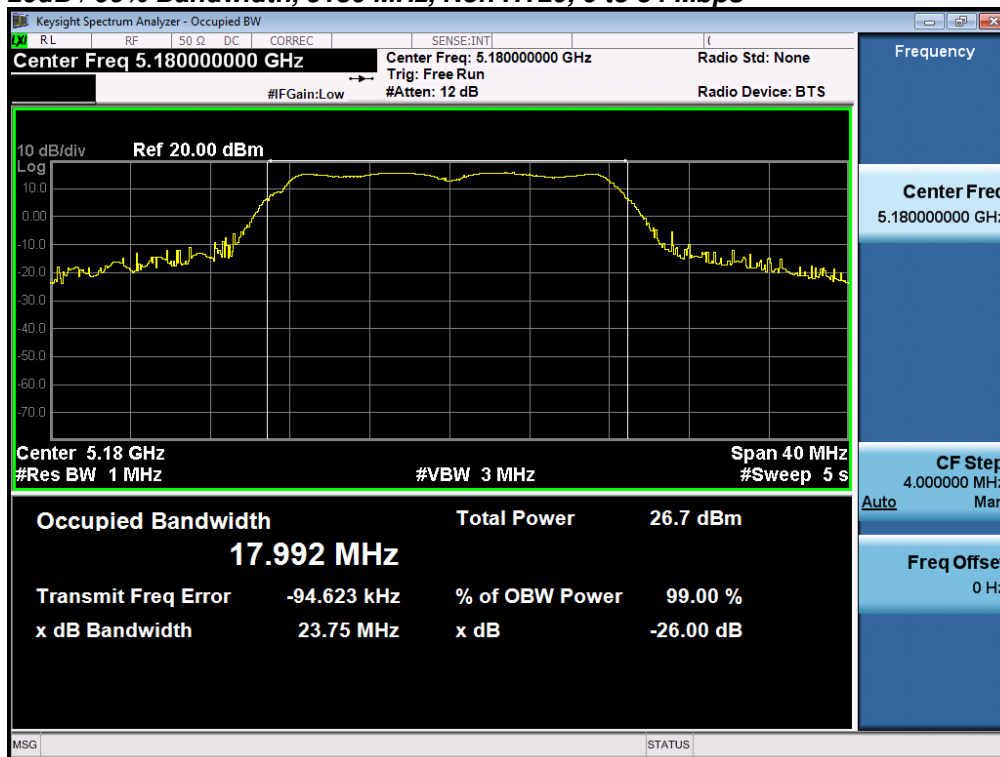

26dB / 99% Bandwidth, 5180 MHz, HT/VHT20, M0 to M23

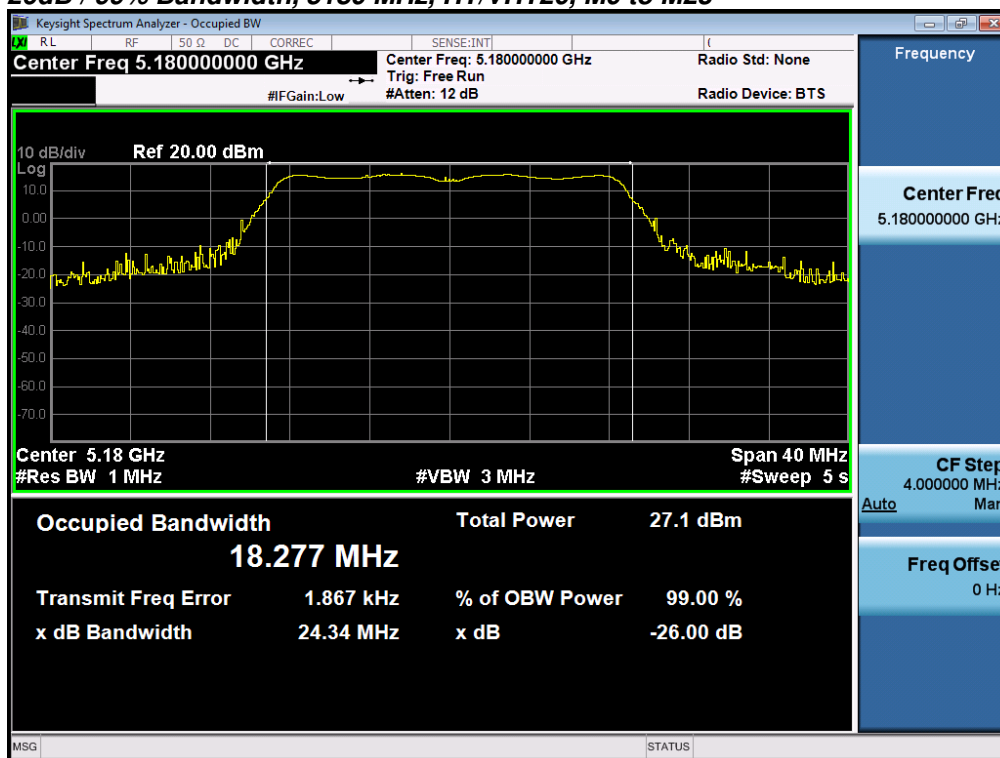



26dB / 99% Bandwidth, 5190 MHz, Non HT40, 6 to 54 Mbps

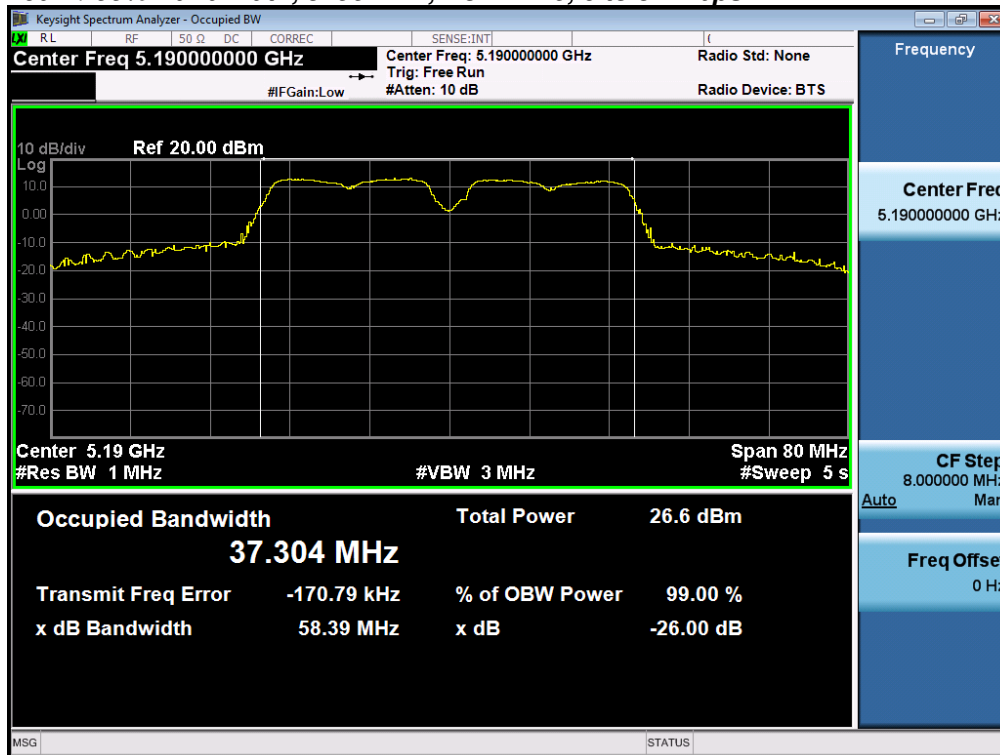

26dB / 99% Bandwidth, 5190 MHz, HT/VHT40, M0 to M23

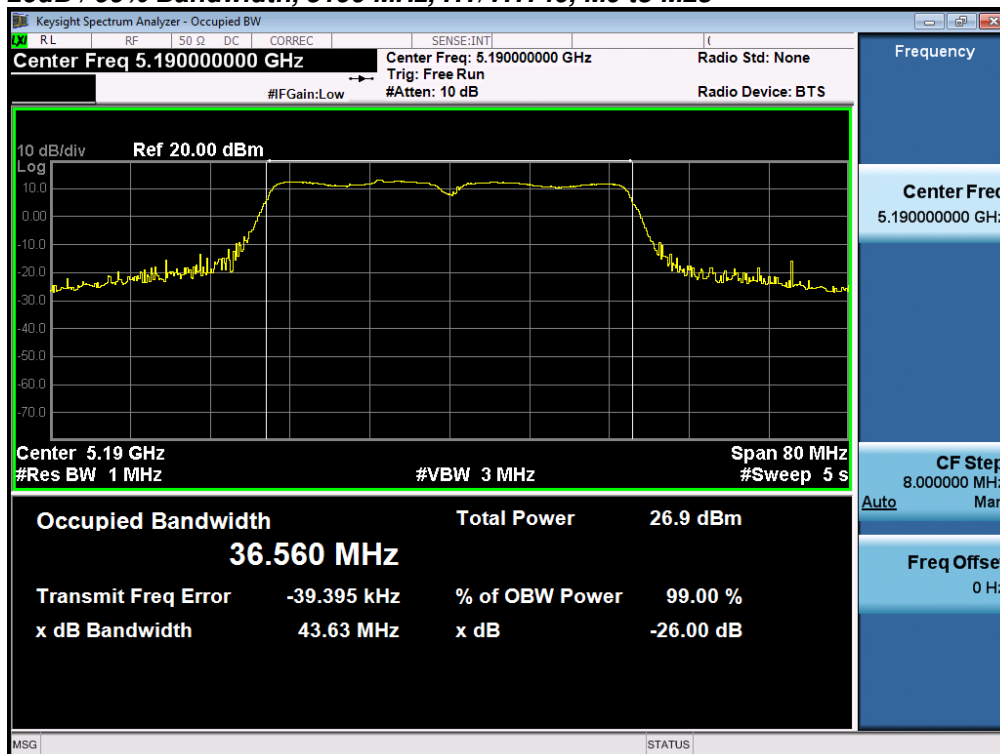

26dB / 99% Bandwidth, 5210 MHz, Non HT80, 6 to 54 Mbps

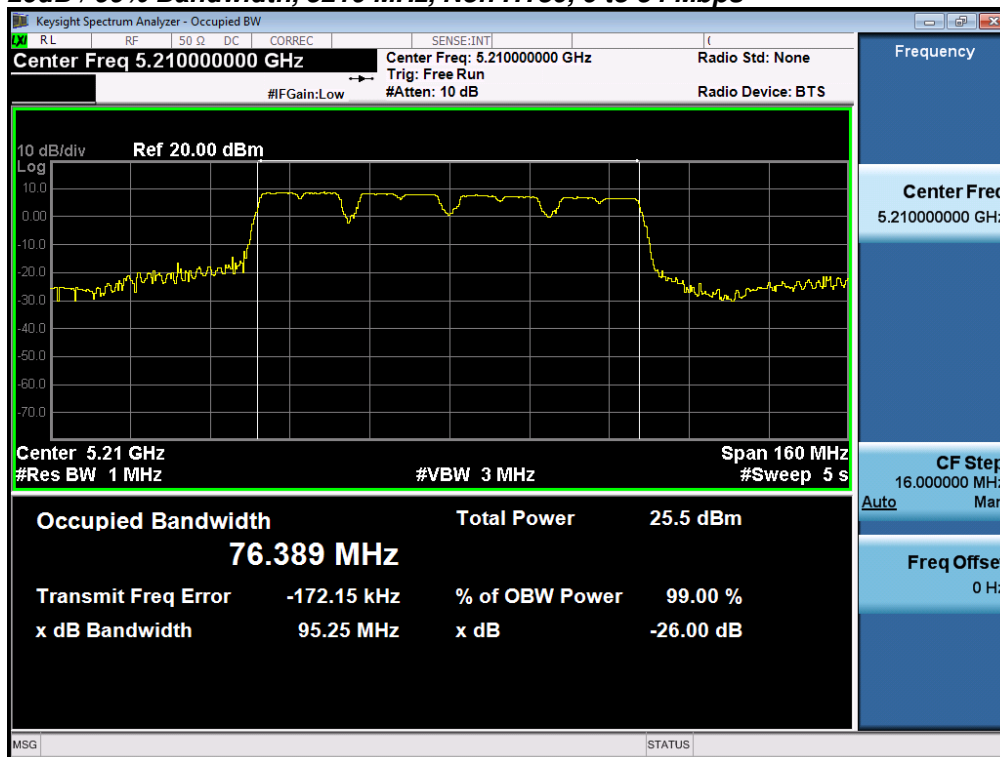

26dB / 99% Bandwidth, 5210 MHz, VHT80, M0 to M9, M0 to M9 1-1ss

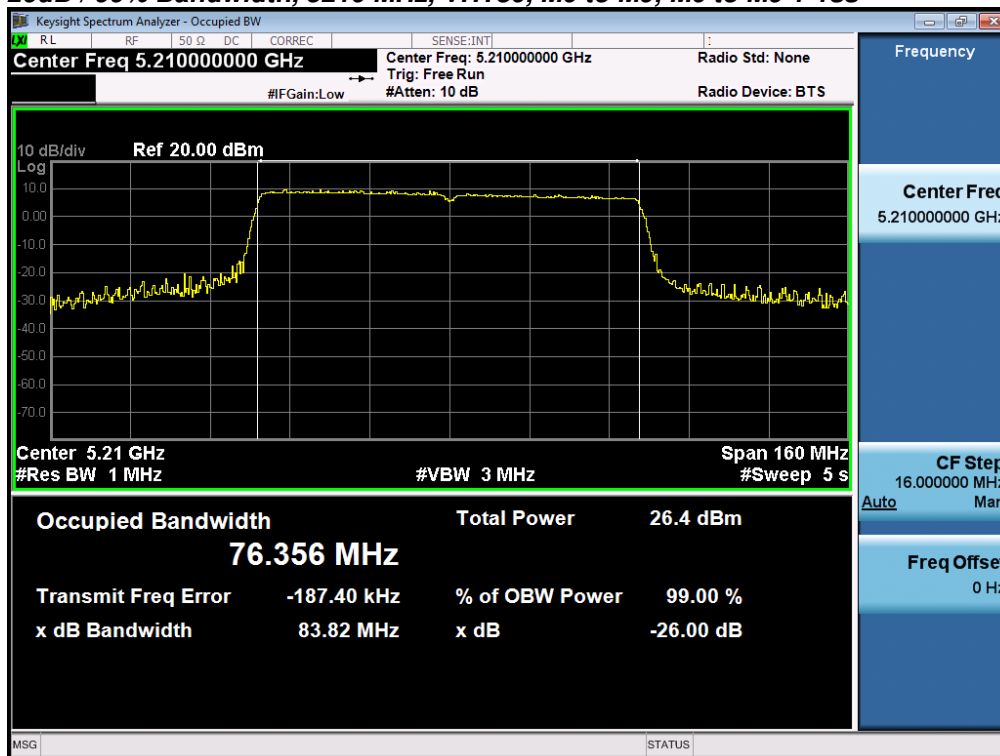

26dB / 99% Bandwidth, 5220 MHz, Non HT20, 6 to 54 Mbps

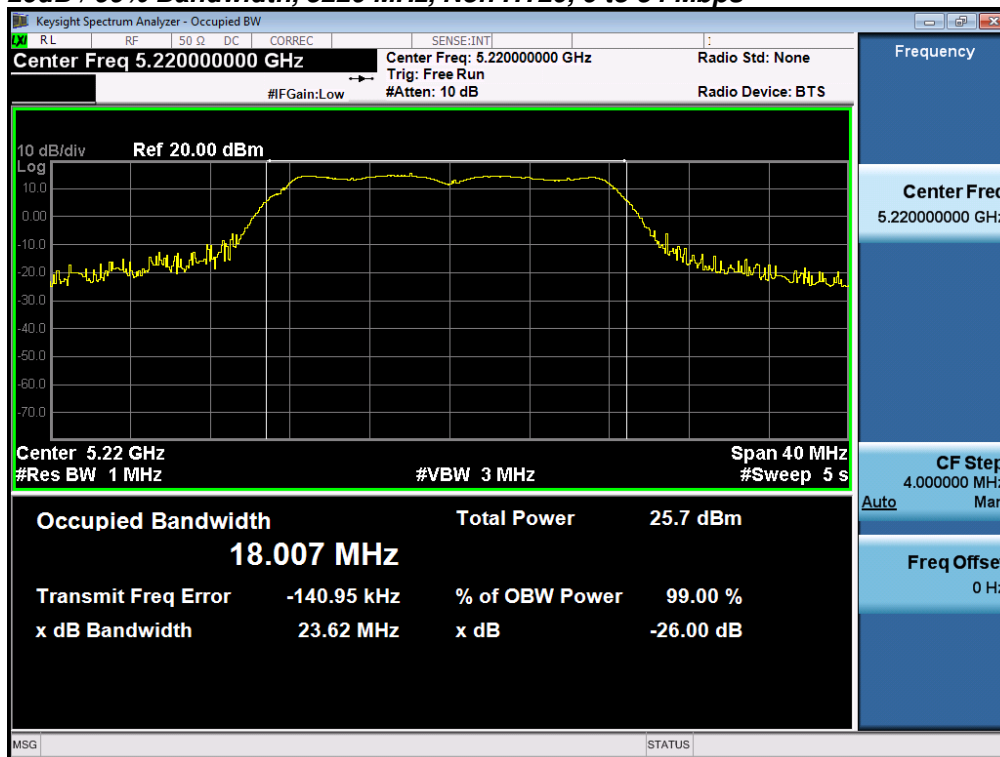

26dB / 99% Bandwidth, 5220 MHz, HT/VHT20, M0 to M23

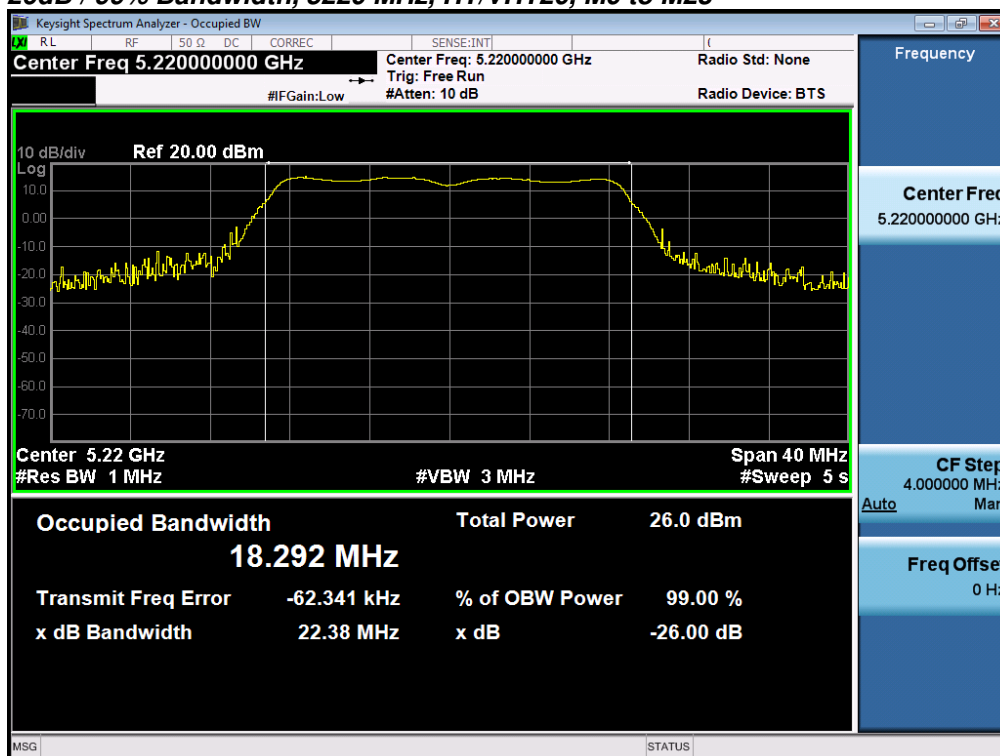

26dB / 99% Bandwidth, 5230 MHz, Non HT40, 6 to 54 Mbps

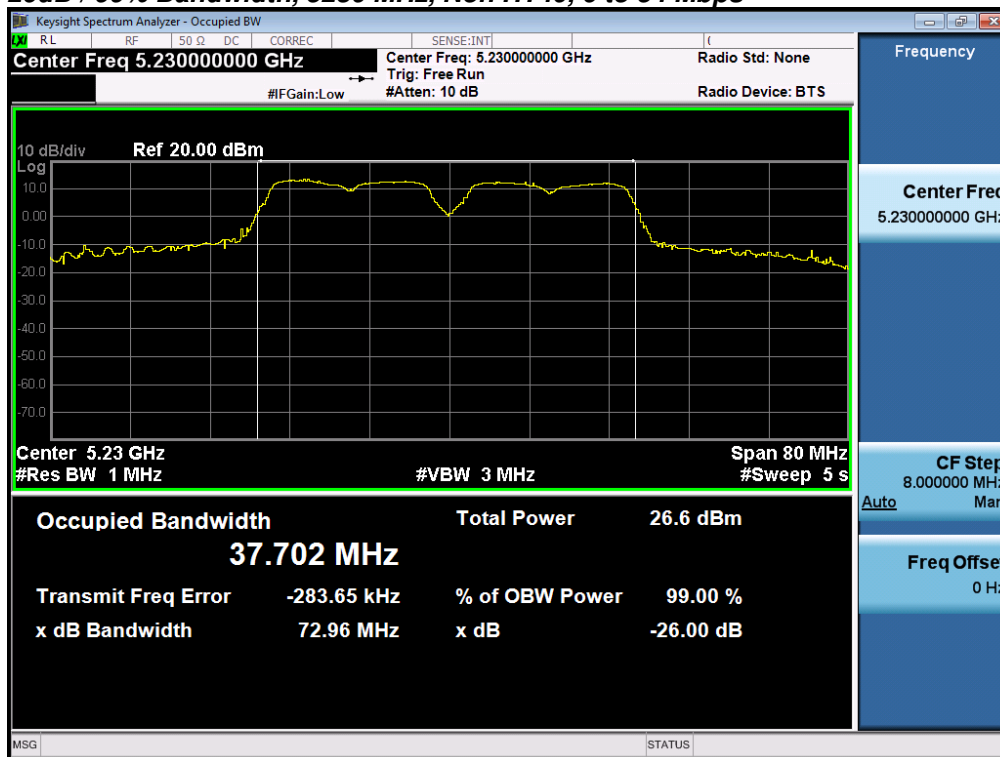

26dB / 99% Bandwidth, 5230 MHz, HT/VHT40, M0 to M23

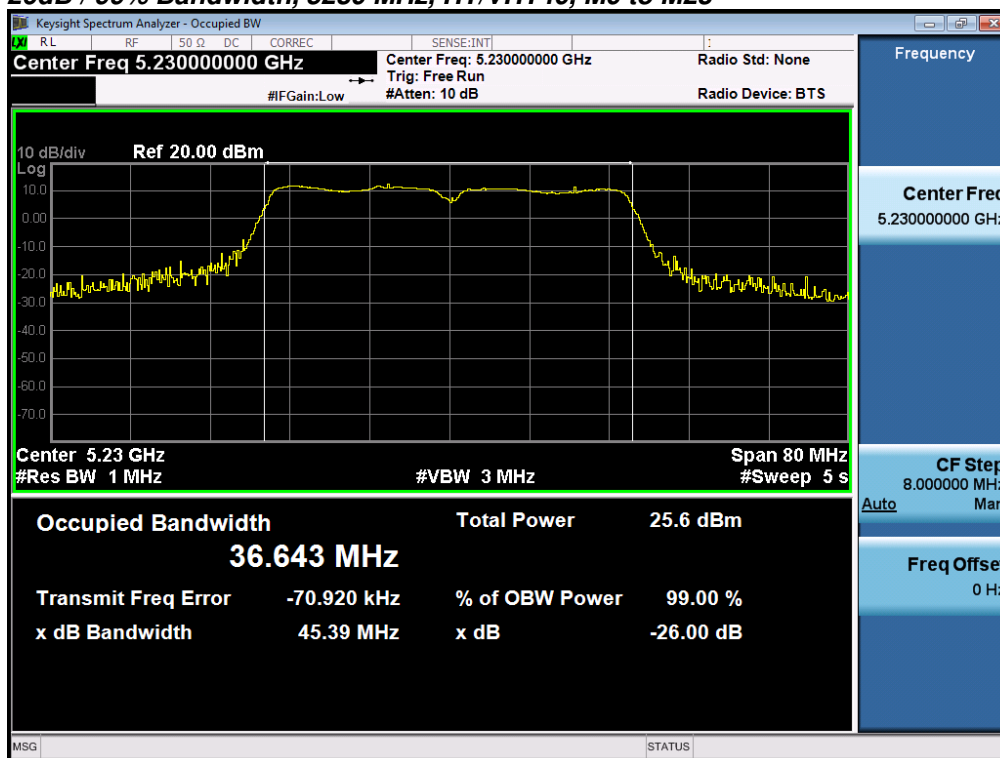

26dB / 99% Bandwidth, 5240 MHz, Non HT20, 6 to 54 Mbps

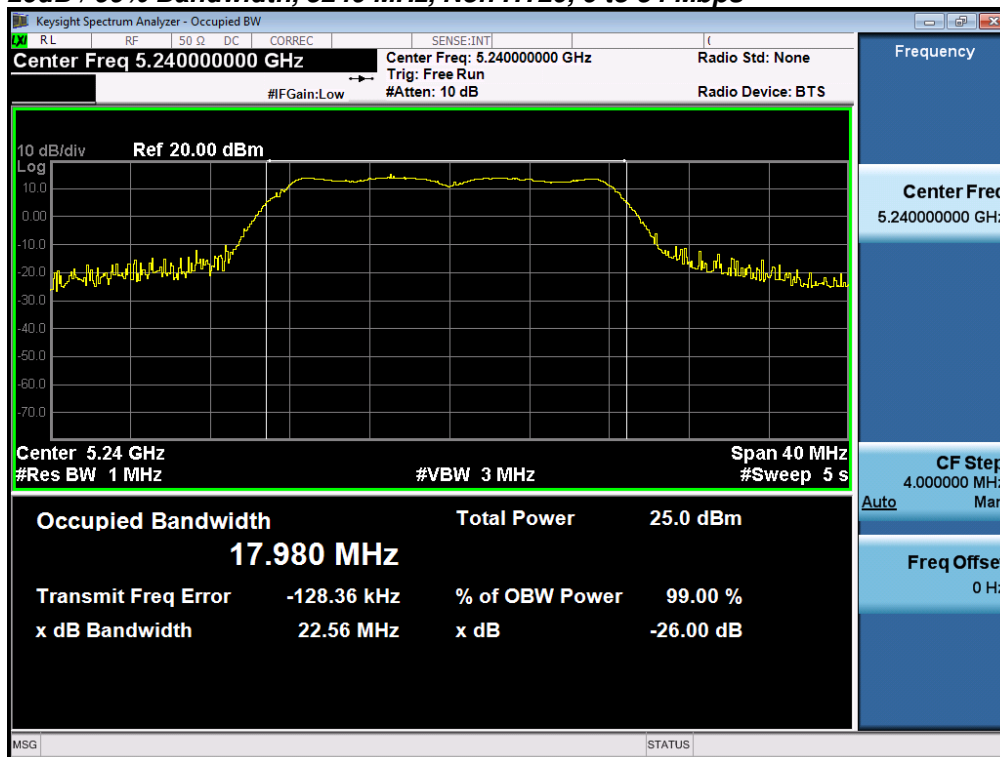

26dB / 99% Bandwidth, 5240 MHz, HT/VHT20, M0 to M23

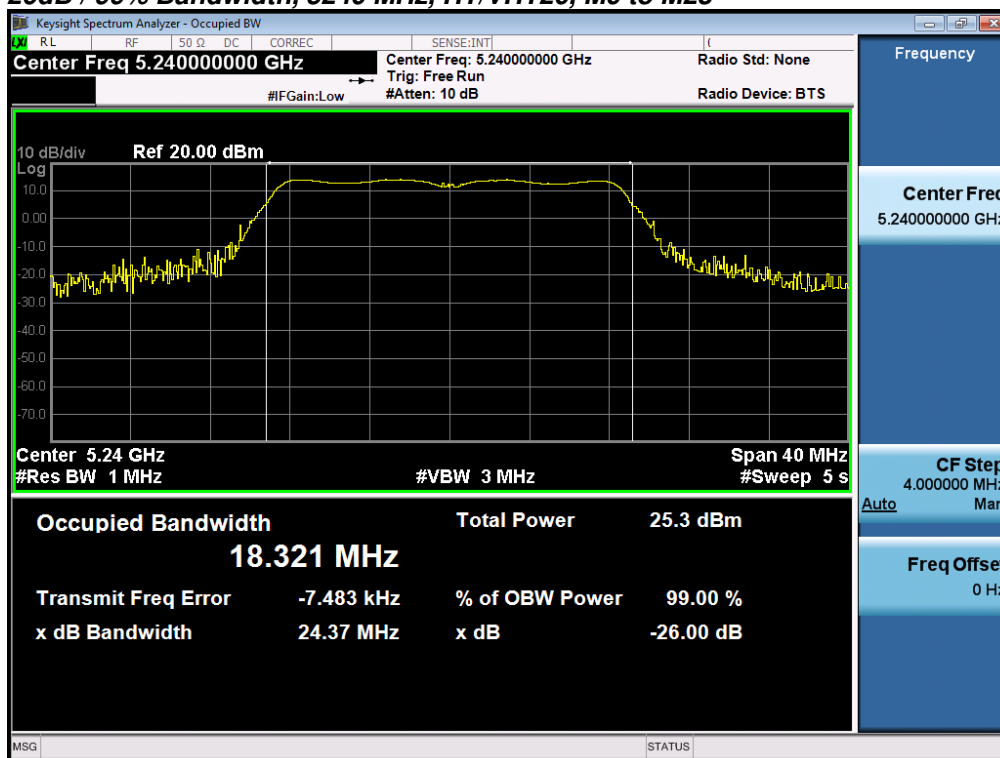

A.2 Maximum Conducted Output Power/ Power Spectral Density

15.407 (i) For an outdoor access point operating in the band 5.15-5.25 GHz, the maximum conducted output power over the frequency band of operation shall not exceed 1 W provided the maximum antenna gain does not exceed 6 dBi. In addition, the maximum power spectral density shall not exceed 17 dBm in any 1 megahertz band. If transmitting antennas of directional gain greater than 6 dBi are used, both the maximum conducted output power and the maximum power spectral density shall be reduced by the amount in dB that the directional gain of the antenna exceeds 6 dBi. The maximum e.i.r.p. at any elevation angle above 30 degrees as measured from the horizon must not exceed 125 mW (21 dBm).

(ii) For an indoor access point operating in the band 5.15-5.25 GHz, the maximum conducted output power over the frequency band of operation shall not exceed 1 W provided the maximum antenna gain does not exceed 6 dBi. In addition, the maximum power spectral density shall not exceed 17 dBm in any 1 megahertz band. If transmitting antennas of directional gain greater than 6 dBi are used, both the maximum conducted output power and the maximum power spectral density shall be reduced by the amount in dB that the directional gain of the antenna exceeds 6 dBi.

Test Procedure

Ref. KDB 789033 D02 General UNII Test Procedures New Rules v01r01
ANSI C63.10: 2013

Output Power
Test Procedure
<ol style="list-style-type: none"> 1. Set the radio in the continuous transmitting mode at full power 2. Compute power by integrating the spectrum across the EBW (or alternatively entire 99% OBW) of the signal using the instrument's band power measurement function. The integration shall be performed using the spectrum analyzer band-power measurement function with band limits set equal to the EBW or the OBW band edges. 3. Capture graphs and record pertinent measurement data.

Ref. KDB 789033 D02 General UNII Test Procedures New Rules v01r01
ANSI C63.10: 2013 section 12.3.2.2 Method SA-1

Output Power
Test parameters
Span = >1.5 times the OBW RBW = 1MHz VBW ≥ 3 x RBW Sweep = Auto couple Detector = sample Trace = Trace Average 100

The "measure-and-sum technique" is used for measuring in-band transmit power of a device. In the measure-and-sum approach, the conducted emission level is measured at each antenna port. The measured results at the various antenna ports are then summed mathematically to determine the total emission level from the device. Summing is performed in linear power units. (See ANSI C63.10 section 14.3.2.2)

System Number	Description	Samples	System under test	Support equipment
1	EUT	S01	<input checked="" type="checkbox"/>	<input type="checkbox"/>
	Support	S02	<input type="checkbox"/>	<input checked="" type="checkbox"/>

Tested By : Jose Aguirre	Date of testing: 01-Jan-16 - 29-Feb-16
Test Result : PASS	

See Appendix C for list of test equipment

Antenna Gain : 2 dBi

Frequency (MHz)	Mode	Tx Paths	Correlated Antenna Gain (dBi)	Tx 1 Max Power (dBm)	Tx 2 Max Power (dBm)	Tx 3 Max Power (dBm)	Tx 4 Max Power (dBm)	Total Tx Channel Power (dBm)	Limit (dBm)	Margin (dB)
5180	Non HT20, 6 to 54 Mbps	1	2	18.8				18.8	30.0	11.2
	Non HT20, 6 to 54 Mbps	2	2	18.8	18.2			21.5	30.0	8.5
	Non HT20, 6 to 54 Mbps	3	2	18.8	18.2	17.8		23.1	30.0	6.9
	Non HT20, 6 to 54 Mbps	4	2	18.8	18.2	17.8	17.9	24.2	30.0	5.8
	Non HT20 Beam Forming, 6 to 54 Mbps	2	5	18.8	18.2			21.5	30.0	8.5
	Non HT20 Beam Forming, 6 to 54 Mbps	3	7	18.8	18.2	17.8		23.1	29.0	5.9
	Non HT20 Beam Forming, 6 to 54 Mbps	4	8	15.7	17.1	16.4	16.8	22.6	28.0	5.4
	HT/VHT20, M0 to M7	1	2	19.0				19.0	30.0	11.0
	HT/VHT20, M0 to M7	2	2	19.0	18.4			21.7	30.0	8.3
	HT/VHT20, M8 to M15	2	2	19.0	18.4			21.7	30.0	8.3
	HT/VHT20, M0 to M7	3	2	19.0	18.4	17.8		23.2	30.0	6.8
	HT/VHT20, M8 to M15	3	2	19.0	18.4	17.8		23.2	30.0	6.8
	HT/VHT20, M16 to M23	3	2	19.0	18.4	17.8		23.2	30.0	6.8
	HT/VHT20, M0 to M7	4	2	19.0	18.4	17.8	18.2	24.4	30.0	5.6
	HT/VHT20, M8 to M15	4	2	19.0	18.4	17.8	18.2	24.4	30.0	5.6
	HT/VHT20, M16 to M23	4	2	19.0	18.4	17.8	18.2	24.4	30.0	5.6
	HT/VHT20 Beam Forming, M0 to M7	2	5	19.0	18.4			21.7	30.0	8.3
	HT/VHT20 Beam Forming, M8 to M15	2	2	19.0	18.4			21.7	30.0	8.3
	HT/VHT20 Beam Forming, M0 to M7	3	7	19.0	18.4	17.8		23.2	29.0	5.8
	HT/VHT20 Beam Forming, M8 to M15	3	4	19.0	18.4	17.8		23.2	30.0	6.8
	HT/VHT20 Beam Forming, M16 to M23	3	2	19.0	18.4	17.8		23.2	30.0	6.8
	HT/VHT20 Beam Forming, M0 to M7	4	8	17.8	17.4	16.7	17.1	23.3	28.0	4.7
	HT/VHT20 Beam Forming, M8 to M15	4	5	19.0	18.4	17.8	18.2	24.4	30.0	5.6
	HT/VHT20 Beam Forming, M16 to M23	4	3	19.0	18.4	17.8	18.2	24.4	30.0	5.6
	HT/VHT20 STBC, M0 to M7	2	2	19.0	18.4			21.7	30.0	8.3
	HT/VHT20 STBC, M0 to M7	3	2	19.0	18.4	17.8		23.2	30.0	6.8
	HT/VHT20 STBC, M0 to M7	4	2	19.0	18.4	17.8	18.2	24.4	30.0	5.6
	5190	Non HT40, 6 to 54 Mbps	1	2	18.6				18.6	30.0
Non HT40, 6 to 54 Mbps		2	2	18.6	18.1			21.4	30.0	8.6
Non HT40, 6 to 54 Mbps		3	2	16.4	15.9	15.8		20.8	30.0	9.2
Non HT40, 6 to 54 Mbps		4	2	16.4	15.9	15.8	15.7	22.0	30.0	8.0
HT/VHT40, M0 to M7		1	2	18.8				18.8	30.0	11.2
HT/VHT40, M0 to M7		2	2	18.8	18.3			21.6	30.0	8.4



	HT/VHT40, M8 to M15	2	2	18.8	18.3			21.6	30.0	8.4
	HT/VHT40, M0 to M7	3	2	18.8	18.3	17.8		23.1	30.0	6.9
	HT/VHT40, M8 to M15	3	2	18.8	18.3	17.8		23.1	30.0	6.9
	HT/VHT40, M16 to M23	3	2	18.8	18.3	17.8		23.1	30.0	6.9
	HT/VHT40, M0 to M7	4	2	18.8	18.3	17.8	17.8	24.2	30.0	5.8
	HT/VHT40, M8 to M15	4	2	18.8	18.3	17.8	17.8	24.2	30.0	5.8
	HT/VHT40, M16 to M23	4	2	18.8	18.3	17.8	17.8	24.2	30.0	5.8
	HT/VHT40 Beam Forming, M0 to M7	2	5	18.8	18.3			21.6	30.0	8.4
	HT/VHT40 Beam Forming, M8 to M15	2	2	18.8	18.3			21.6	30.0	8.4
	HT/VHT40 Beam Forming, M0 to M7	3	7	16.4	16.0	15.8		20.8	29.0	8.2
	HT/VHT40 Beam Forming, M8 to M15	3	4	18.8	18.3	17.8		23.1	30.0	6.9
	HT/VHT40 Beam Forming, M16 to M23	3	2	18.8	18.3	17.8		23.1	30.0	6.9
	HT/VHT40 Beam Forming, M0 to M7	4	8	16.3	15.9	14.7	14.5	21.4	28.0	6.6
	HT/VHT40 Beam Forming, M8 to M15	4	5	17.6	17.2	16.8	16.8	23.1	30.0	6.9
	HT/VHT40 Beam Forming, M16 to M23	4	3	18.8	18.3	17.8	17.8	24.2	30.0	5.8
	HT/VHT40 STBC, M0 to M7	2	2	18.8	18.3			21.6	30.0	8.4
	HT/VHT40 STBC, M0 to M7	3	2	18.8	18.3	17.8		23.1	30.0	6.9
	HT/VHT40 STBC, M0 to M7	4	2	18.8	18.3	17.8	17.8	24.2	30.0	5.8
5210	Non HT80, 6 to 54 Mbps	1	2	17.5				17.5	30.0	12.5
	Non HT80, 6 to 54 Mbps	2	2	16.3	16.0			19.2	30.0	10.8
	Non HT80, 6 to 54 Mbps	3	2	15.2	14.8	15.5		19.9	30.0	10.1
	Non HT80, 6 to 54 Mbps	4	2	15.2	14.8	15.5	14.9	21.1	30.0	8.9
	VHT80, M0 to M9 1ss	1	2	18.0				18.0	30.0	12.0
	VHT80, M0 to M9 1ss	2	2	18.0	17.7			20.9	30.0	9.1
	VHT80, M0 to M9 2ss	2	2	18.0	17.7			20.9	30.0	9.1
	VHT80, M0 to M9 1ss	3	2	18.0	17.7	18.2		22.7	30.0	7.3
	VHT80, M0 to M9 2ss	3	2	18.0	17.7	18.2		22.7	30.0	7.3
	VHT80, M0 to M9 3ss	3	2	18.0	17.7	18.2		22.7	30.0	7.3
	VHT80, M0 to M9 1ss	4	2	18.0	17.7	18.2	17.5	23.9	30.0	6.1
	VHT80, M0 to M9 2ss	4	2	18.0	17.7	18.2	17.5	23.9	30.0	6.1
	VHT80, M0 to M9 3ss	4	2	18.0	17.7	18.2	17.5	23.9	30.0	6.1
	VHT80 Beam Forming, M0 to M9 1ss	2	5	18.0	17.7			20.9	30.0	9.1
	VHT80 Beam Forming, M0 to M9 2ss	2	2	18.0	17.7			20.9	30.0	9.1
	VHT80 Beam Forming, M0 to M9 1ss	3	7	15.6	15.4	14.8		20.1	29.0	8.9
	VHT80 Beam Forming, M0 to M9 2ss	3	4	16.8	16.6	17.0		21.6	30.0	8.4
	VHT80 Beam Forming, M0 to M9 3ss	3	2	18.0	17.7	18.2		22.7	30.0	7.3
	VHT80 Beam Forming, M0 to M9 1ss	4	8	13.4	13.3	13.8	13.3	19.5	28.0	8.5
	VHT80 Beam Forming, M0 to M9 2ss	4	5	15.7	15.4	16.0	15.4	21.7	30.0	8.3
VHT80 Beam Forming, M0 to M9 3ss	4	3	16.8	16.6	17.0	16.4	22.7	30.0	7.3	
VHT80 STBC, M0 to M9 1ss	2	2	18.0	17.7			20.9	30.0	9.1	
VHT80 STBC, M0 to M9 1ss	3	2	18.0	17.7	18.2		22.7	30.0	7.3	



	VHT80 STBC, M0 to M9 1ss	4	2	18.0	17.7	18.2	17.5	23.9	30.0	6.1
5220	Non HT20, 6 to 54 Mbps	1	2	17.8				17.8	30.0	12.2
	Non HT20, 6 to 54 Mbps	2	2	17.8	17.9			20.9	30.0	9.1
	Non HT20, 6 to 54 Mbps	3	2	17.8	17.9	18.6		22.9	30.0	7.1
	Non HT20, 6 to 54 Mbps	4	2	17.8	17.9	18.6	17.7	24.0	30.0	6.0
	Non HT20 Beam Forming, 6 to 54 Mbps	2	5	17.8	17.9			20.9	30.0	9.1
	Non HT20 Beam Forming, 6 to 54 Mbps	3	7	17.8	17.9	18.6		22.9	29.0	6.1
	Non HT20 Beam Forming, 6 to 54 Mbps	4	8	17.8	17.9	18.6	17.7	24.0	28.0	4.0
	HT/VHT20, M0 to M7	1	2	18.0				18.0	30.0	12.0
	HT/VHT20, M0 to M7	2	2	18.0	18.0			21.0	30.0	9.0
	HT/VHT20, M8 to M15	2	2	18.0	18.0			21.0	30.0	9.0
	HT/VHT20, M0 to M7	3	2	18.0	18.0	18.8		23.1	30.0	6.9
	HT/VHT20, M8 to M15	3	2	18.0	18.0	18.8		23.1	30.0	6.9
	HT/VHT20, M16 to M23	3	2	18.0	18.0	18.8		23.1	30.0	6.9
	HT/VHT20, M0 to M7	4	2	18.0	18.0	18.8	17.9	24.2	30.0	5.8
	HT/VHT20, M8 to M15	4	2	18.0	18.0	18.8	17.9	24.2	30.0	5.8
	HT/VHT20, M16 to M23	4	2	18.0	18.0	18.8	17.9	24.2	30.0	5.8
	HT/VHT20 Beam Forming, M0 to M7	2	5	18.0	18.0			21.0	30.0	9.0
	HT/VHT20 Beam Forming, M8 to M15	2	2	18.0	18.0			21.0	30.0	9.0
	HT/VHT20 Beam Forming, M0 to M7	3	7	18.0	18.0	18.8		23.1	29.0	5.9
	HT/VHT20 Beam Forming, M8 to M15	3	4	18.0	18.0	18.8		23.1	30.0	6.9
	HT/VHT20 Beam Forming, M16 to M23	3	2	18.0	18.0	18.8		23.1	30.0	6.9
	HT/VHT20 Beam Forming, M0 to M7	4	8	18.0	18.0	18.8	17.9	24.2	28.0	3.8
	HT/VHT20 Beam Forming, M8 to M15	4	5	18.0	18.0	18.8	17.9	24.2	30.0	5.8
	HT/VHT20 Beam Forming, M16 to M23	4	3	18.0	18.0	18.8	17.9	24.2	30.0	5.8
HT/VHT20 STBC, M0 to M7	2	2	18.0	18.0			21.0	30.0	9.0	
HT/VHT20 STBC, M0 to M7	3	2	18.0	18.0	18.8		23.1	30.0	6.9	
HT/VHT20 STBC, M0 to M7	4	2	18.0	18.0	18.8	17.9	24.2	30.0	5.8	
5230	Non HT40, 6 to 54 Mbps	1	2	18.7				18.7	30.0	11.3
	Non HT40, 6 to 54 Mbps	2	2	18.7	18.8			21.8	30.0	8.2
	Non HT40, 6 to 54 Mbps	3	2	18.7	18.8	20.0		24.0	30.0	6.0
	Non HT40, 6 to 54 Mbps	4	2	18.7	18.8	20.0	19.0	25.2	30.0	4.8
	HT/VHT40, M0 to M7	1	2	17.6				17.6	30.0	12.4
	HT/VHT40, M0 to M7	2	2	17.6	17.5			20.6	30.0	9.4
	HT/VHT40, M8 to M15	2	2	17.6	17.5			20.6	30.0	9.4
	HT/VHT40, M0 to M7	3	2	17.6	17.5	18.6		22.7	30.0	7.3
	HT/VHT40, M8 to M15	3	2	17.6	17.5	18.6		22.7	30.0	7.3
	HT/VHT40, M16 to M23	3	2	17.6	17.5	18.6		22.7	30.0	7.3
	HT/VHT40, M0 to M7	4	2	17.6	17.5	18.6	17.7	23.9	30.0	6.1
	HT/VHT40, M8 to M15	4	2	17.6	17.5	18.6	17.7	23.9	30.0	6.1

	HT/VHT40, M16 to M23	4	2	17.6	17.5	18.6	17.7	23.9	30.0	6.1
	HT/VHT40 Beam Forming, M0 to M7	2	5	17.6	17.5			20.6	30.0	9.4
	HT/VHT40 Beam Forming, M8 to M15	2	2	17.6	17.5			20.6	30.0	9.4
	HT/VHT40 Beam Forming, M0 to M7	3	7	17.6	17.5	18.6		22.7	29.0	6.3
	HT/VHT40 Beam Forming, M8 to M15	3	4	17.6	17.5	18.6		22.7	30.0	7.3
	HT/VHT40 Beam Forming, M16 to M23	3	2	17.6	17.5	18.6		22.7	30.0	7.3
	HT/VHT40 Beam Forming, M0 to M7	4	8	17.6	17.5	18.6	17.7	23.9	28.0	4.1
	HT/VHT40 Beam Forming, M8 to M15	4	5	17.6	17.5	18.6	17.7	23.9	30.0	6.1
	HT/VHT40 Beam Forming, M16 to M23	4	3	17.6	17.5	18.6	17.7	23.9	30.0	6.1
	HT/VHT40 STBC, M0 to M7	2	2	17.6	17.5			20.6	30.0	9.4
	HT/VHT40 STBC, M0 to M7	3	2	17.6	17.5	18.6		22.7	30.0	7.3
	HT/VHT40 STBC, M0 to M7	4	2	17.6	17.5	18.6	17.7	23.9	30.0	6.1
5240	Non HT20, 6 to 54 Mbps	1	2	17.2				17.2	30.0	12.8
	Non HT20, 6 to 54 Mbps	2	2	17.2	17.3			20.3	30.0	9.7
	Non HT20, 6 to 54 Mbps	3	2	17.2	17.3	18.6		22.5	30.0	7.5
	Non HT20, 6 to 54 Mbps	4	2	17.2	17.3	18.6	17.8	23.8	30.0	6.2
	Non HT20 Beam Forming, 6 to 54 Mbps	2	5	17.2	17.3			20.3	30.0	9.7
	Non HT20 Beam Forming, 6 to 54 Mbps	3	7	17.2	17.3	18.6		22.5	29.0	6.5
	Non HT20 Beam Forming, 6 to 54 Mbps	4	8	17.2	17.3	18.6	17.8	23.8	28.0	4.2
	HT/VHT20, M0 to M7	1	2	17.3				17.3	30.0	12.7
	HT/VHT20, M0 to M7	2	2	17.3	17.4			20.4	30.0	9.6
	HT/VHT20, M8 to M15	2	2	17.3	17.4			20.4	30.0	9.6
	HT/VHT20, M0 to M7	3	2	17.3	17.4	18.8		22.7	30.0	7.3
	HT/VHT20, M8 to M15	3	2	17.3	17.4	18.8		22.7	30.0	7.3
	HT/VHT20, M16 to M23	3	2	17.3	17.4	18.8		22.7	30.0	7.3
	HT/VHT20, M0 to M7	4	2	17.3	17.4	18.8	17.9	23.9	30.0	6.1
	HT/VHT20, M8 to M15	4	2	17.3	17.4	18.8	17.9	23.9	30.0	6.1
	HT/VHT20, M16 to M23	4	2	17.3	17.4	18.8	17.9	23.9	30.0	6.1
	HT/VHT20 Beam Forming, M0 to M7	2	5	17.3	17.4			20.4	30.0	9.6
	HT/VHT20 Beam Forming, M8 to M15	2	2	17.3	17.4			20.4	30.0	9.6
	HT/VHT20 Beam Forming, M0 to M7	3	7	17.3	17.4	18.8		22.7	29.0	6.3
	HT/VHT20 Beam Forming, M8 to M15	3	4	17.3	17.4	18.8		22.7	30.0	7.3
	HT/VHT20 Beam Forming, M16 to M23	3	2	17.3	17.4	18.8		22.7	30.0	7.3
	HT/VHT20 Beam Forming, M0 to M7	4	8	17.3	17.4	18.8	17.9	23.9	28.0	4.1
	HT/VHT20 Beam Forming, M8 to M15	4	5	17.3	17.4	18.8	17.9	23.9	30.0	6.1
	HT/VHT20 Beam Forming, M16 to M23	4	3	17.3	17.4	18.8	17.9	23.9	30.0	6.1
	HT/VHT20 STBC, M0 to M7	2	2	17.3	17.4			20.4	30.0	9.6
	HT/VHT20 STBC, M0 to M7	3	2	17.3	17.4	18.8		22.7	30.0	7.3
	HT/VHT20 STBC, M0 to M7	4	2	17.3	17.4	18.8	17.9	23.9	30.0	6.1



Frequency (MHz)	Mode	Tx Paths	Correlated Antenna Gain (dBi)	Tx 1 PSD (dBm/MHz)	Tx 2 PSD (dBm/MHz)	Tx 3 PSD (dBm/MHz)	Tx 4 PSD (dBm/MHz)	Total PSD (dBm/MHz)	Limit (dBm/MHz)	Margin (dB)
5180	Non HT20, 6 to 54 Mbps	1	2	8.6				8.6	17.0	8.4
	Non HT20, 6 to 54 Mbps	2	5	8.6	7.7			11.2	17.0	5.8
	Non HT20, 6 to 54 Mbps	3	7	8.6	7.7	7.4		12.7	16.0	3.3
	Non HT20, 6 to 54 Mbps	4	8	8.6	7.7	7.4	7.7	13.9	15.0	1.1
	Non HT20 Beam Forming, 6 to 54 Mbps	2	5	8.6	7.7			11.2	17.0	5.8
	Non HT20 Beam Forming, 6 to 54 Mbps	3	7	8.6	7.7	7.4		12.7	16.0	3.3
	Non HT20 Beam Forming, 6 to 54 Mbps	4	8	5.3	6.6	6.0	6.4	12.1	15.0	2.9
	HT/VHT20, M0 to M7	1	2	8.2				8.2	17.0	8.8
	HT/VHT20, M0 to M7	2	5	8.2	7.7			11.0	17.0	6.0
	HT/VHT20, M8 to M15	2	2	8.2	7.7			11.0	17.0	6.0
	HT/VHT20, M0 to M7	3	7	8.2	7.7	6.8		12.4	16.0	3.6
	HT/VHT20, M8 to M15	3	4	8.2	7.7	6.8		12.4	17.0	4.6
	HT/VHT20, M16 to M23	3	2	8.2	7.7	6.8		12.4	17.0	4.6
	HT/VHT20, M0 to M7	4	8	8.2	7.7	6.8	7.2	13.5	15.0	1.5
	HT/VHT20, M8 to M15	4	5	8.2	7.7	6.8	7.2	13.5	17.0	3.5
	HT/VHT20, M16 to M23	4	3	8.2	7.7	6.8	7.2	13.5	17.0	3.5
	HT/VHT20 Beam Forming, M0 to M7	2	5	8.2	7.7			11.0	17.0	6.0
	HT/VHT20 Beam Forming, M8 to M15	2	2	8.2	7.7			11.0	17.0	6.0
	HT/VHT20 Beam Forming, M0 to M7	3	7	8.2	7.7	6.8		12.4	16.0	3.6
	HT/VHT20 Beam Forming, M8 to M15	3	4	8.2	7.7	6.8		12.4	17.0	4.6
	HT/VHT20 Beam Forming, M16 to M23	3	2	8.2	7.7	6.8		12.4	17.0	4.6
	HT/VHT20 Beam Forming, M0 to M7	4	8	7.1	6.4	6.2	6.5	12.6	15.0	2.4
	HT/VHT20 Beam Forming, M8 to M15	4	5	8.2	7.7	6.8	7.2	13.5	17.0	3.5
	HT/VHT20 Beam Forming, M16 to M23	4	3	8.2	7.7	6.8	7.2	13.5	17.0	3.5
	HT/VHT20 STBC, M0 to M7	2	2	8.2	7.7			11.0	17.0	6.0
	HT/VHT20 STBC, M0 to M7	3	4	8.2	7.7	6.8		12.4	17.0	4.6
	HT/VHT20 STBC, M0 to M7	4	5	8.2	7.7	6.8	7.2	13.5	17.0	3.5
	5190	Non HT40, 6 to 54 Mbps	1	2	5.2				5.2	17.0
Non HT40, 6 to 54 Mbps		2	5	5.2	4.9			8.1	17.0	8.9
Non HT40, 6 to 54 Mbps		3	7	2.9	2.5	2.8		7.5	16.0	8.5
Non HT40, 6 to 54 Mbps		4	8	2.9	2.5	2.8	2.2	8.6	15.0	6.4
HT/VHT40, M0 to M7		1	2	5.1				5.1	17.0	11.9
HT/VHT40, M0 to M7		2	5	5.1	4.6			7.9	17.0	9.1
HT/VHT40, M8 to M15		2	2	5.1	4.6			7.9	17.0	9.1



	HT/VHT40, M0 to M7	3	7	5.1	4.6	4.2		9.4	16.0	6.6
	HT/VHT40, M8 to M15	3	4	5.1	4.6	4.2		9.4	17.0	7.6
	HT/VHT40, M16 to M23	3	2	5.1	4.6	4.2		9.4	17.0	7.6
	HT/VHT40, M0 to M7	4	8	5.1	4.6	4.2	3.9	10.5	15.0	4.5
	HT/VHT40, M8 to M15	4	5	5.1	4.6	4.2	3.9	10.5	17.0	6.5
	HT/VHT40, M16 to M23	4	3	5.1	4.6	4.2	3.9	10.5	17.0	6.5
	HT/VHT40 Beam Forming, M0 to M7	2	5	5.1	4.6			7.9	17.0	9.1
	HT/VHT40 Beam Forming, M8 to M15	2	2	5.1	4.6			7.9	17.0	9.1
	HT/VHT40 Beam Forming, M0 to M7	3	7	2.8	2.0	2.0		7.1	16.0	8.9
	HT/VHT40 Beam Forming, M8 to M15	3	4	5.1	4.6	4.2		9.4	17.0	7.6
	HT/VHT40 Beam Forming, M16 to M23	3	2	5.1	4.6	4.2		9.4	17.0	7.6
	HT/VHT40 Beam Forming, M0 to M7	4	8	2.3	2.4	1.2	0.6	7.7	15.0	7.3
	HT/VHT40 Beam Forming, M8 to M15	4	5	3.9	3.5	2.9	3.0	9.4	17.0	7.6
	HT/VHT40 Beam Forming, M16 to M23	4	3	5.1	4.6	4.2	3.9	10.5	17.0	6.5
	HT/VHT40 STBC, M0 to M7	2	2	5.1	4.6			7.9	17.0	9.1
	HT/VHT40 STBC, M0 to M7	3	4	5.1	4.6	4.2		9.4	17.0	7.6
	HT/VHT40 STBC, M0 to M7	4	5	5.1	4.6	4.2	3.9	10.5	17.0	6.5
5210	Non HT80, 6 to 54 Mbps	1	2	1.1				1.1	17.0	15.9
	Non HT80, 6 to 54 Mbps	2	5	-0.1	-0.7			2.6	17.0	14.4
	Non HT80, 6 to 54 Mbps	3	7	-1.3	-1.8	-1.1		3.4	16.0	12.6
	Non HT80, 6 to 54 Mbps	4	8	-1.3	-1.8	-1.1	-1.9	4.5	15.0	10.5
	VHT80, M0 to M9 1ss	1	2	1.1				1.1	17.0	15.9
	VHT80, M0 to M9 1ss	2	5	1.1	0.5			3.8	17.0	13.2
	VHT80, M0 to M9 2ss	2	2	1.1	0.5			3.8	17.0	13.2
	VHT80, M0 to M9 1ss	3	7	1.1	0.5	0.9		5.6	16.0	10.4
	VHT80, M0 to M9 2ss	3	4	1.1	0.5	0.9		5.6	17.0	11.4
	VHT80, M0 to M9 3ss	3	2	1.1	0.5	0.9		5.6	17.0	11.4
	VHT80, M0 to M9 1ss	4	8	1.1	0.5	0.9	-0.2	6.6	15.0	8.4
	VHT80, M0 to M9 2ss	4	5	1.1	0.5	0.9	-0.2	6.6	17.0	10.4
	VHT80, M0 to M9 3ss	4	3	1.1	0.5	0.9	-0.2	6.6	17.0	10.4
	VHT80 Beam Forming, M0 to M9 1ss	2	5	1.1	0.5			3.8	17.0	13.2
	VHT80 Beam Forming, M0 to M9 2ss	2	2	1.1	0.5			3.8	17.0	13.2
	VHT80 Beam Forming, M0 to M9 1ss	3	7	-1.4	-1.4	-2.5		3.0	16.0	13.0
	VHT80 Beam Forming, M0 to M9 2ss	3	4	-0.1	-0.6	-0.4		4.4	17.0	12.6
	VHT80 Beam Forming, M0 to M9 3ss	3	2	1.1	0.5	0.9		5.6	17.0	11.4
	VHT80 Beam Forming, M0 to M9 1ss	4	8	-3.5	-3.7	-3.6	-4.0	2.3	15.0	12.7
	VHT80 Beam Forming, M0 to M9 2ss	4	5	-1.2	-1.7	-1.2	-2.1	4.5	17.0	12.5
	VHT80 Beam Forming, M0 to M9 3ss	4	3	-0.1	-0.6	-0.4	-1.2	5.5	17.0	11.5
	VHT80 STBC, M0 to M9 1ss	2	2	1.1	0.5			3.8	17.0	13.2
	VHT80 STBC, M0 to M9 1ss	3	2	1.1	0.5	0.9		5.6	17.0	11.4
VHT80 STBC, M0 to M9 1ss	4	2	1.1	0.5	0.9	-0.2	6.6	17.0	10.4	

5220	Non HT20, 6 to 54 Mbps	1	2	7.4				7.4	17.0	9.6
	Non HT20, 6 to 54 Mbps	2	5	7.4	7.5			10.5	17.0	6.5
	Non HT20, 6 to 54 Mbps	3	7	7.4	7.5	8.1		12.4	16.0	3.6
	Non HT20, 6 to 54 Mbps	4	8	7.4	7.5	8.1	7.1	13.6	15.0	1.4
	Non HT20 Beam Forming, 6 to 54 Mbps	2	5	7.4	7.5			10.5	17.0	6.5
	Non HT20 Beam Forming, 6 to 54 Mbps	3	7	7.4	7.5	8.1		12.4	16.0	3.6
	Non HT20 Beam Forming, 6 to 54 Mbps	4	8	7.4	7.5	8.1	7.1	13.6	15.0	1.4
	HT/VHT20, M0 to M7	1	2	7.2				7.2	17.0	9.8
	HT/VHT20, M0 to M7	2	5	7.2	7.4			10.3	17.0	6.7
	HT/VHT20, M8 to M15	2	2	7.2	7.4			10.3	17.0	6.7
	HT/VHT20, M0 to M7	3	7	7.2	7.4	8.0		12.3	16.0	3.7
	HT/VHT20, M8 to M15	3	4	7.2	7.4	8.0		12.3	17.0	4.7
	HT/VHT20, M16 to M23	3	2	7.2	7.4	8.0		12.3	17.0	4.7
	HT/VHT20, M0 to M7	4	8	7.2	7.4	8.0	7.0	13.4	15.0	1.6
	HT/VHT20, M8 to M15	4	5	7.2	7.4	8.0	7.0	13.4	17.0	3.6
	HT/VHT20, M16 to M23	4	3	7.2	7.4	8.0	7.0	13.4	17.0	3.6
	HT/VHT20 Beam Forming, M0 to M7	2	5	7.2	7.4			10.3	17.0	6.7
	HT/VHT20 Beam Forming, M8 to M15	2	2	7.2	7.4			10.3	17.0	6.7
	HT/VHT20 Beam Forming, M0 to M7	3	7	7.2	7.4	8.0		12.3	16.0	3.7
	HT/VHT20 Beam Forming, M8 to M15	3	4	7.2	7.4	8.0		12.3	17.0	4.7
	HT/VHT20 Beam Forming, M16 to M23	3	2	7.2	7.4	8.0		12.3	17.0	4.7
	HT/VHT20 Beam Forming, M0 to M7	4	8	7.2	7.4	8.0	7.0	13.4	15.0	1.6
	HT/VHT20 Beam Forming, M8 to M15	4	5	7.2	7.4	8.0	7.0	13.4	17.0	3.6
	HT/VHT20 Beam Forming, M16 to M23	4	3	7.2	7.4	8.0	7.0	13.4	17.0	3.6
HT/VHT20 STBC, M0 to M7	2	2	7.2	7.4			10.3	17.0	6.7	
HT/VHT20 STBC, M0 to M7	3	4	7.2	7.4	8.0		12.3	17.0	4.7	
HT/VHT20 STBC, M0 to M7	4	5	7.2	7.4	8.0	7.0	13.4	17.0	3.6	
5230	Non HT40, 6 to 54 Mbps	1	2	5.5				5.5	17.0	11.5
	Non HT40, 6 to 54 Mbps	2	5	5.5	5.9			8.7	17.0	8.3
	Non HT40, 6 to 54 Mbps	3	7	5.5	5.9	6.8		10.9	16.0	5.1
	Non HT40, 6 to 54 Mbps	4	8	5.5	5.9	6.8	5.6	12.0	15.0	3.0
	HT/VHT40, M0 to M7	1	2	4.1				4.1	17.0	12.9
	HT/VHT40, M0 to M7	2	5	4.1	3.8			7.0	17.0	10.0
	HT/VHT40, M8 to M15	2	2	4.1	3.8			7.0	17.0	10.0
	HT/VHT40, M0 to M7	3	7	4.1	3.8	4.8		9.0	16.0	7.0
	HT/VHT40, M8 to M15	3	4	4.1	3.8	4.8		9.0	17.0	8.0
	HT/VHT40, M16 to M23	3	2	4.1	3.8	4.8		9.0	17.0	8.0
	HT/VHT40, M0 to M7	4	8	4.1	3.8	4.8	3.8	10.2	15.0	4.8
	HT/VHT40, M8 to M15	4	5	4.1	3.8	4.8	3.8	10.2	17.0	6.8
	HT/VHT40, M16 to M23	4	3	4.1	3.8	4.8	3.8	10.2	17.0	6.8

	HT/VHT40 Beam Forming, M0 to M7	2	5	4.1	3.8			7.0	17.0	10.0
	HT/VHT40 Beam Forming, M8 to M15	2	2	4.1	3.8			7.0	17.0	10.0
	HT/VHT40 Beam Forming, M0 to M7	3	7	4.1	3.8	4.8		9.0	16.0	7.0
	HT/VHT40 Beam Forming, M8 to M15	3	4	4.1	3.8	4.8		9.0	17.0	8.0
	HT/VHT40 Beam Forming, M16 to M23	3	2	4.1	3.8	4.8		9.0	17.0	8.0
	HT/VHT40 Beam Forming, M0 to M7	4	8	4.1	3.8	4.8	3.8	10.2	15.0	4.8
	HT/VHT40 Beam Forming, M8 to M15	4	5	4.1	3.8	4.8	3.8	10.2	17.0	6.8
	HT/VHT40 Beam Forming, M16 to M23	4	3	4.1	3.8	4.8	3.8	10.2	17.0	6.8
	HT/VHT40 STBC, M0 to M7	2	2	4.1	3.8			7.0	17.0	10.0
	HT/VHT40 STBC, M0 to M7	3	4	4.1	3.8	4.8		9.0	17.0	8.0
	HT/VHT40 STBC, M0 to M7	4	5	4.1	3.8	4.8	3.8	10.2	17.0	6.8
5240	Non HT20, 6 to 54 Mbps	1	2	6.9				6.9	17.0	10.1
	Non HT20, 6 to 54 Mbps	2	5	6.9	6.9			9.9	17.0	7.1
	Non HT20, 6 to 54 Mbps	3	7	6.9	6.9	8.3		12.2	16.0	3.8
	Non HT20, 6 to 54 Mbps	4	8	6.9	6.9	8.3	7.4	13.4	15.0	1.6
	Non HT20 Beam Forming, 6 to 54 Mbps	2	5	6.9	6.9			9.9	17.0	7.1
	Non HT20 Beam Forming, 6 to 54 Mbps	3	7	6.9	6.9	8.3		12.2	16.0	3.8
	Non HT20 Beam Forming, 6 to 54 Mbps	4	8	6.9	6.9	8.3	7.4	13.4	15.0	1.6
	HT/VHT20, M0 to M7	1	2	6.5				6.5	17.0	10.5
	HT/VHT20, M0 to M7	2	5	6.5	6.7			9.6	17.0	7.4
	HT/VHT20, M8 to M15	2	2	6.5	6.7			9.6	17.0	7.4
	HT/VHT20, M0 to M7	3	7	6.5	6.7	8.1		11.9	16.0	4.1
	HT/VHT20, M8 to M15	3	4	6.5	6.7	8.1		11.9	17.0	5.1
	HT/VHT20, M16 to M23	3	2	6.5	6.7	8.1		11.9	17.0	5.1
	HT/VHT20, M0 to M7	4	8	6.5	6.7	8.1	7.0	13.1	15.0	1.9
	HT/VHT20, M8 to M15	4	5	6.5	6.7	8.1	7.0	13.1	17.0	3.9
	HT/VHT20, M16 to M23	4	3	6.5	6.7	8.1	7.0	13.1	17.0	3.9
	HT/VHT20 Beam Forming, M0 to M7	2	5	6.5	6.7			9.6	17.0	7.4
	HT/VHT20 Beam Forming, M8 to M15	2	2	6.5	6.7			9.6	17.0	7.4
	HT/VHT20 Beam Forming, M0 to M7	3	7	6.5	6.7	8.1		11.9	16.0	4.1
	HT/VHT20 Beam Forming, M8 to M15	3	4	6.5	6.7	8.1		11.9	17.0	5.1
	HT/VHT20 Beam Forming, M16 to M23	3	2	6.5	6.7	8.1		11.9	17.0	5.1
	HT/VHT20 Beam Forming, M0 to M7	4	8	6.5	6.7	8.1	7.0	13.1	15.0	1.9
	HT/VHT20 Beam Forming, M8 to M15	4	5	6.5	6.7	8.1	7.0	13.1	17.0	3.9
	HT/VHT20 Beam Forming, M16 to M23	4	3	6.5	6.7	8.1	7.0	13.1	17.0	3.9
	HT/VHT20 STBC, M0 to M7	2	2	6.5	6.7			9.6	17.0	7.4
	HT/VHT20 STBC, M0 to M7	3	4	6.5	6.7	8.1		11.9	17.0	5.1
	HT/VHT20 STBC, M0 to M7	4	5	6.5	6.7	8.1	7.0	13.1	17.0	3.9

Peak Output Power, 5220 MHz, HT/VHT20 Beam Forming, M0 to M7

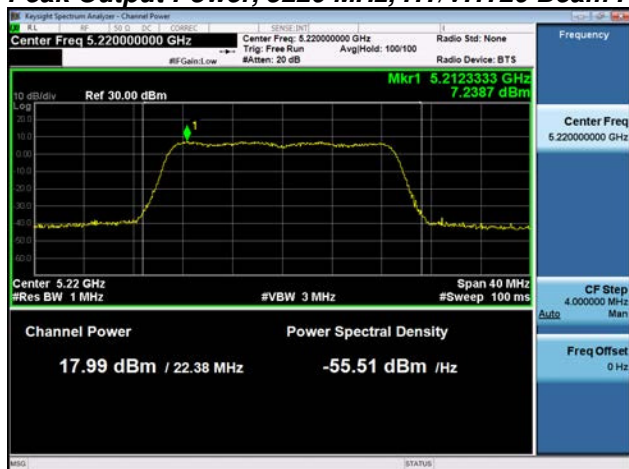

Antenna A

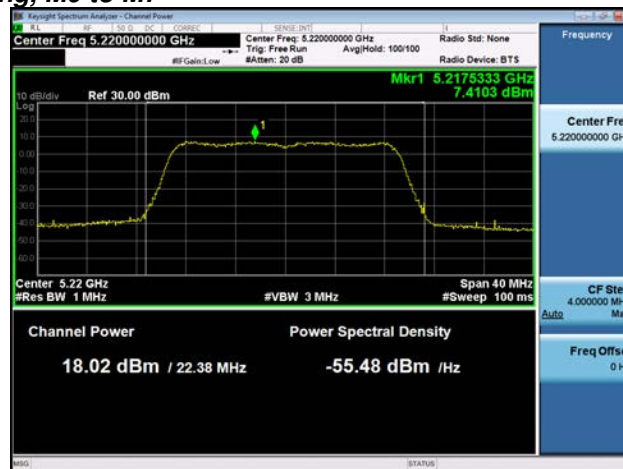

Antenna B

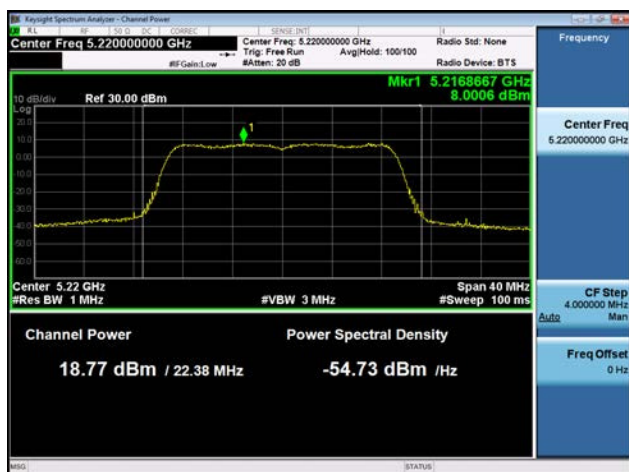

Antenna C

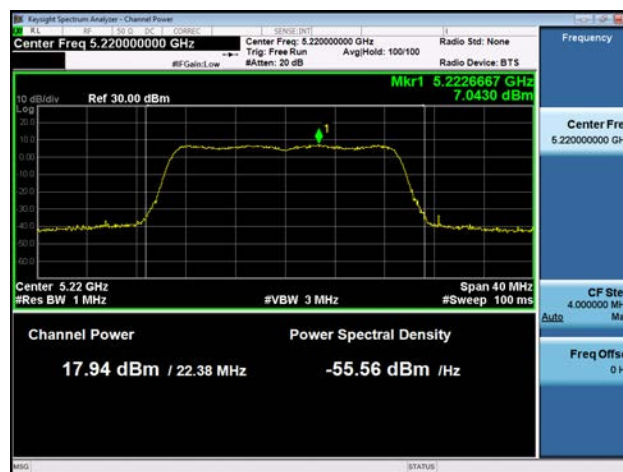

Antenna D

Power Spectral Density, 5180 MHz, Non HT20, 6 to 54 Mbps

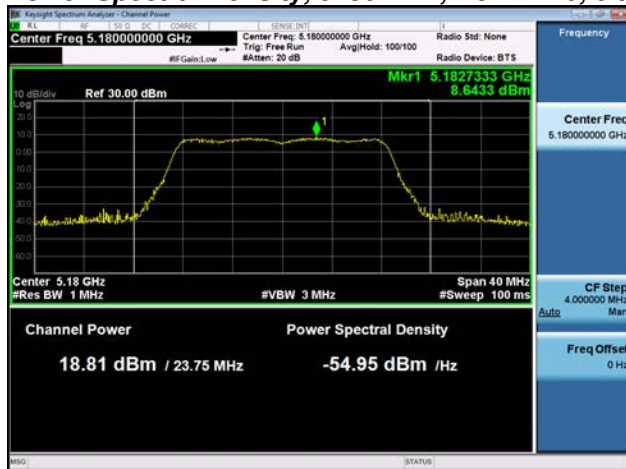

Antenna A

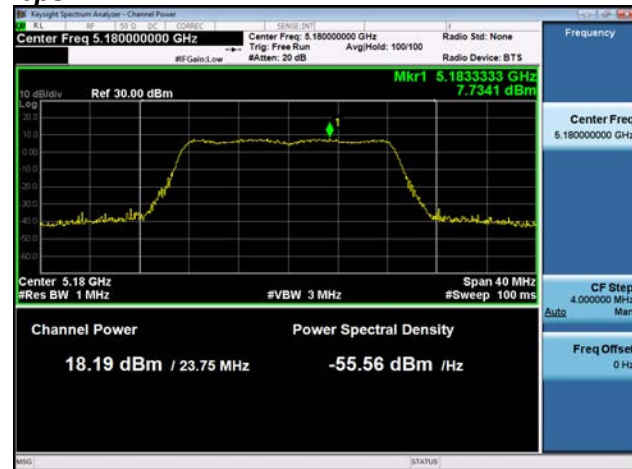

Antenna B

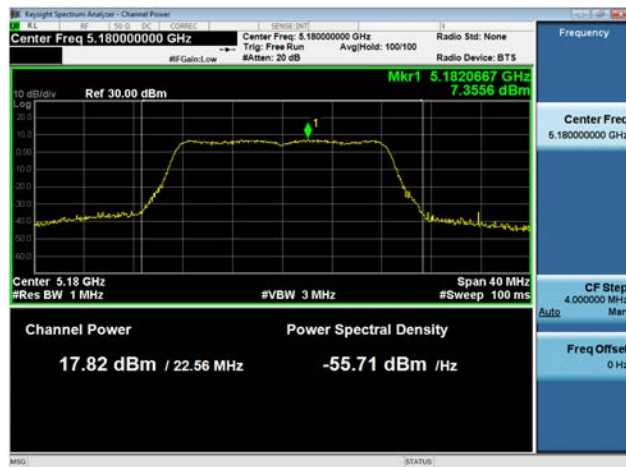

Antenna C

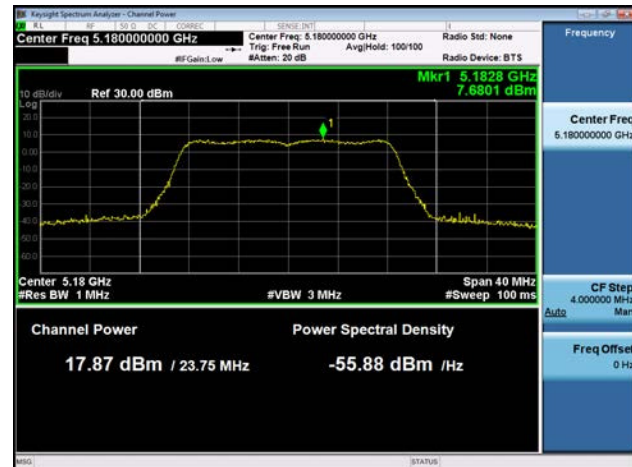

Antenna D

Antenna Gain : 3 dBi

Frequency (MHz)	Mode	Tx Paths	Correlated Antenna Gain (dBi)	Tx 1 Max Power (dBm)	Tx 2 Max Power (dBm)	Tx 3 Max Power (dBm)	Tx 4 Max Power (dBm)	Total Tx Channel Power (dBm)	Limit (dBm)	Margin (dB)
5180	Non HT20, 6 to 54 Mbps	1	3	18.8				18.8	30.0	11.2
	Non HT20, 6 to 54 Mbps	2	3	18.8	18.2			21.5	30.0	8.5
	Non HT20, 6 to 54 Mbps	3	3	18.8	18.2	17.8		23.1	30.0	6.9
	Non HT20, 6 to 54 Mbps	4	3	18.8	18.2	17.8	17.9	24.2	30.0	5.8
	Non HT20 Beam Forming, 6 to 54 Mbps	2	6	18.8	18.2			21.5	30.0	8.5
	Non HT20 Beam Forming, 6 to 54 Mbps	3	8	18.8	18.2	17.8		23.1	28.0	4.9
	Non HT20 Beam Forming, 6 to 54 Mbps	4	9	15.7	17.1	16.4	16.8	22.6	27.0	4.4
	HT/VHT20, M0 to M7	1	3	19.0				19.0	30.0	11.0
	HT/VHT20, M0 to M7	2	3	19.0	18.4			21.7	30.0	8.3
	HT/VHT20, M8 to M15	2	3	19.0	18.4			21.7	30.0	8.3
	HT/VHT20, M0 to M7	3	3	19.0	18.4	17.8		23.2	30.0	6.8
	HT/VHT20, M8 to M15	3	3	19.0	18.4	17.8		23.2	30.0	6.8
	HT/VHT20, M16 to M23	3	3	19.0	18.4	17.8		23.2	30.0	6.8
	HT/VHT20, M0 to M7	4	3	19.0	18.4	17.8	18.2	24.4	30.0	5.6
	HT/VHT20, M8 to M15	4	3	19.0	18.4	17.8	18.2	24.4	30.0	5.6
	HT/VHT20, M16 to M23	4	3	19.0	18.4	17.8	18.2	24.4	30.0	5.6
	HT/VHT20 Beam Forming, M0 to M7	2	6	19.0	18.4			21.7	30.0	8.3
	HT/VHT20 Beam Forming, M8 to M15	2	3	19.0	18.4			21.7	30.0	8.3
	HT/VHT20 Beam Forming, M0 to M7	3	8	19.0	18.4	17.8		23.2	28.0	4.8
	HT/VHT20 Beam Forming, M8 to M15	3	5	19.0	18.4	17.8		23.2	30.0	6.8
	HT/VHT20 Beam Forming, M16 to M23	3	3	19.0	18.4	17.8		23.2	30.0	6.8
	HT/VHT20 Beam Forming, M0 to M7	4	9	16.7	16.2	15.6	16.1	22.2	27.0	4.8
	HT/VHT20 Beam Forming, M8 to M15	4	6	19.0	18.4	17.8	18.2	24.4	30.0	5.6
	HT/VHT20 Beam Forming, M16 to M23	4	4	19.0	18.4	17.8	18.2	24.4	30.0	5.6
	HT/VHT20 STBC, M0 to M7	2	3	19.0	18.4			21.7	30.0	8.3
	HT/VHT20 STBC, M0 to M7	3	3	19.0	18.4	17.8		23.2	30.0	6.8
	HT/VHT20 STBC, M0 to M7	4	3	19.0	18.4	17.8	18.2	24.4	30.0	5.6
	5190	Non HT40, 6 to 54 Mbps	1	3	18.6				18.6	30.0
Non HT40, 6 to 54 Mbps		2	3	17.5	17.0			20.3	30.0	9.7
Non HT40, 6 to 54 Mbps		3	3	16.4	15.9	15.8		20.8	30.0	9.2
Non HT40, 6 to 54 Mbps		4	3	15.2	14.8	14.6	14.5	20.8	30.0	9.2
HT/VHT40, M0 to M7		1	3	18.8				18.8	30.0	11.2
HT/VHT40, M0 to M7		2	3	18.8	18.3			21.6	30.0	8.4

	HT/VHT40, M8 to M15	2	3	18.8	18.3			21.6	30.0	8.4
	HT/VHT40, M0 to M7	3	3	18.8	18.3	17.8		23.1	30.0	6.9
	HT/VHT40, M8 to M15	3	3	18.8	18.3	17.8		23.1	30.0	6.9
	HT/VHT40, M16 to M23	3	3	18.8	18.3	17.8		23.1	30.0	6.9
	HT/VHT40, M0 to M7	4	3	18.8	18.3	17.8	17.8	24.2	30.0	5.8
	HT/VHT40, M8 to M15	4	3	18.8	18.3	17.8	17.8	24.2	30.0	5.8
	HT/VHT40, M16 to M23	4	3	18.8	18.3	17.8	17.8	24.2	30.0	5.8
	HT/VHT40 Beam Forming, M0 to M7	2	6	18.8	18.3			21.6	30.0	8.4
	HT/VHT40 Beam Forming, M8 to M15	2	3	18.8	18.3			21.6	30.0	8.4
	HT/VHT40 Beam Forming, M0 to M7	3	8	16.4	16.0	15.8		20.8	28.0	7.2
	HT/VHT40 Beam Forming, M8 to M15	3	5	17.6	17.2	16.8		22.0	30.0	8.0
	HT/VHT40 Beam Forming, M16 to M23	3	3	18.8	18.3	17.8		23.1	30.0	6.9
	HT/VHT40 Beam Forming, M0 to M7	4	9	15.1	14.9	13.4	14.5	20.5	27.0	6.5
	HT/VHT40 Beam Forming, M8 to M15	4	6	16.4	16.0	15.8	15.6	22.0	30.0	8.0
	HT/VHT40 Beam Forming, M16 to M23	4	4	17.6	17.2	16.8	16.8	23.1	30.0	6.9
	HT/VHT40 STBC, M0 to M7	2	3	18.8	18.3			21.6	30.0	8.4
	HT/VHT40 STBC, M0 to M7	3	3	18.8	18.3	17.8		23.1	30.0	6.9
	HT/VHT40 STBC, M0 to M7	4	3	18.8	18.3	17.8	17.8	24.2	30.0	5.8
5210	Non HT80, 6 to 54 Mbps	1	3	16.3				16.3	30.0	13.7
	Non HT80, 6 to 54 Mbps	2	3	16.3	16.0			19.2	30.0	10.8
	Non HT80, 6 to 54 Mbps	3	3	15.2	14.8	15.5		19.9	30.0	10.1
	Non HT80, 6 to 54 Mbps	4	3	13.9	13.6	14.4	13.9	20.0	30.0	10.0
	VHT80, M0 to M9 1ss	1	3	18.0				18.0	30.0	12.0
	VHT80, M0 to M9 1ss	2	3	18.0	17.7			20.9	30.0	9.1
	VHT80, M0 to M9 2ss	2	3	18.0	17.7			20.9	30.0	9.1
	VHT80, M0 to M9 1ss	3	3	18.0	17.7	18.2		22.7	30.0	7.3
	VHT80, M0 to M9 2ss	3	3	18.0	17.7	18.2		22.7	30.0	7.3
	VHT80, M0 to M9 3ss	3	3	18.0	17.7	18.2		22.7	30.0	7.3
	VHT80, M0 to M9 1ss	4	3	16.8	16.6	17.0	16.4	22.7	30.0	7.3
	VHT80, M0 to M9 2ss	4	3	16.8	16.6	17.0	16.4	22.7	30.0	7.3
	VHT80, M0 to M9 3ss	4	3	16.8	16.6	17.0	16.4	22.7	30.0	7.3
	VHT80 Beam Forming, M0 to M9 1ss	2	6	16.8	16.6			19.7	30.0	10.3
	VHT80 Beam Forming, M0 to M9 2ss	2	3	18.0	17.7			20.9	30.0	9.1
	VHT80 Beam Forming, M0 to M9 1ss	3	8	14.4	14.3	13.7		18.9	28.0	9.1
	VHT80 Beam Forming, M0 to M9 2ss	3	5	16.8	16.6	17.0		21.6	30.0	8.4
	VHT80 Beam Forming, M0 to M9 3ss	3	3	18.0	17.7	18.2		22.7	30.0	7.3
	VHT80 Beam Forming, M0 to M9 1ss	4	9	12.5	12.3	12.8	12.2	18.5	27.0	8.5
	VHT80 Beam Forming, M0 to M9 2ss	4	6	15.6	15.4	14.8	14.3	21.1	30.0	8.9
VHT80 Beam Forming, M0 to M9 3ss	4	4	15.7	15.4	16.0	15.4	21.7	30.0	8.3	
VHT80 STBC, M0 to M9 1ss	2	3	18.0	17.7			20.9	30.0	9.1	
VHT80 STBC, M0 to M9 1ss	3	3	18.0	17.7	18.2		22.7	30.0	7.3	

	VHT80 STBC, M0 to M9 1ss	4	3	16.8	16.6	17.0	16.4	22.7	30.0	7.3
5220	Non HT20, 6 to 54 Mbps	1	3	17.8				17.8	30.0	12.2
	Non HT20, 6 to 54 Mbps	2	3	17.8	17.9			20.9	30.0	9.1
	Non HT20, 6 to 54 Mbps	3	3	17.8	17.9	18.6		22.9	30.0	7.1
	Non HT20, 6 to 54 Mbps	4	3	17.8	17.9	18.6	17.7	24.0	30.0	6.0
	Non HT20 Beam Forming, 6 to 54 Mbps	2	6	17.8	17.9			20.9	30.0	9.1
	Non HT20 Beam Forming, 6 to 54 Mbps	3	8	17.8	17.9	18.6		22.9	28.0	5.1
	Non HT20 Beam Forming, 6 to 54 Mbps	4	9	17.8	17.9	18.6	17.7	24.0	27.0	3.0
	HT/VHT20, M0 to M7	1	3	18.0				18.0	30.0	12.0
	HT/VHT20, M0 to M7	2	3	18.0	18.0			21.0	30.0	9.0
	HT/VHT20, M8 to M15	2	3	18.0	18.0			21.0	30.0	9.0
	HT/VHT20, M0 to M7	3	3	18.0	18.0	18.8		23.1	30.0	6.9
	HT/VHT20, M8 to M15	3	3	18.0	18.0	18.8		23.1	30.0	6.9
	HT/VHT20, M16 to M23	3	3	18.0	18.0	18.8		23.1	30.0	6.9
	HT/VHT20, M0 to M7	4	3	18.0	18.0	18.8	17.9	24.2	30.0	5.8
	HT/VHT20, M8 to M15	4	3	18.0	18.0	18.8	17.9	24.2	30.0	5.8
	HT/VHT20, M16 to M23	4	3	18.0	18.0	18.8	17.9	24.2	30.0	5.8
	HT/VHT20 Beam Forming, M0 to M7	2	6	18.0	18.0			21.0	30.0	9.0
	HT/VHT20 Beam Forming, M8 to M15	2	3	18.0	18.0			21.0	30.0	9.0
	HT/VHT20 Beam Forming, M0 to M7	3	8	18.0	18.0	18.8		23.1	28.0	4.9
	HT/VHT20 Beam Forming, M8 to M15	3	5	18.0	18.0	18.8		23.1	30.0	6.9
	HT/VHT20 Beam Forming, M16 to M23	3	3	18.0	18.0	18.8		23.1	30.0	6.9
	HT/VHT20 Beam Forming, M0 to M7	4	9	18.0	18.0	18.8	17.9	24.2	27.0	2.8
	HT/VHT20 Beam Forming, M8 to M15	4	6	18.0	18.0	18.8	17.9	24.2	30.0	5.8
	HT/VHT20 Beam Forming, M16 to M23	4	4	18.0	18.0	18.8	17.9	24.2	30.0	5.8
HT/VHT20 STBC, M0 to M7	2	3	18.0	18.0			21.0	30.0	9.0	
HT/VHT20 STBC, M0 to M7	3	3	18.0	18.0	18.8		23.1	30.0	6.9	
HT/VHT20 STBC, M0 to M7	4	3	18.0	18.0	18.8	17.9	24.2	30.0	5.8	
5230	Non HT40, 6 to 54 Mbps	1	3	18.7				18.7	30.0	11.3
	Non HT40, 6 to 54 Mbps	2	3	18.7	18.8			21.8	30.0	8.2
	Non HT40, 6 to 54 Mbps	3	3	18.7	18.8	20.0		24.0	30.0	6.0
	Non HT40, 6 to 54 Mbps	4	3	18.7	18.8	20.0	19.0	25.2	30.0	4.8
	HT/VHT40, M0 to M7	1	3	17.6				17.6	30.0	12.4
	HT/VHT40, M0 to M7	2	3	17.6	17.5			20.6	30.0	9.4
	HT/VHT40, M8 to M15	2	3	17.6	17.5			20.6	30.0	9.4
	HT/VHT40, M0 to M7	3	3	17.6	17.5	18.6		22.7	30.0	7.3
	HT/VHT40, M8 to M15	3	3	17.6	17.5	18.6		22.7	30.0	7.3
	HT/VHT40, M16 to M23	3	3	17.6	17.5	18.6		22.7	30.0	7.3
	HT/VHT40, M0 to M7	4	3	17.6	17.5	18.6	17.7	23.9	30.0	6.1
	HT/VHT40, M8 to M15	4	3	17.6	17.5	18.6	17.7	23.9	30.0	6.1

	HT/VHT40, M16 to M23	4	3	17.6	17.5	18.6	17.7	23.9	30.0	6.1
	HT/VHT40 Beam Forming, M0 to M7	2	6	17.6	17.5			20.6	30.0	9.4
	HT/VHT40 Beam Forming, M8 to M15	2	3	17.6	17.5			20.6	30.0	9.4
	HT/VHT40 Beam Forming, M0 to M7	3	8	17.6	17.5	18.6		22.7	28.0	5.3
	HT/VHT40 Beam Forming, M8 to M15	3	5	17.6	17.5	18.6		22.7	30.0	7.3
	HT/VHT40 Beam Forming, M16 to M23	3	3	17.6	17.5	18.6		22.7	30.0	7.3
	HT/VHT40 Beam Forming, M0 to M7	4	9	17.6	17.5	18.6	17.7	23.9	27.0	3.1
	HT/VHT40 Beam Forming, M8 to M15	4	6	17.6	17.5	18.6	17.7	23.9	30.0	6.1
	HT/VHT40 Beam Forming, M16 to M23	4	4	17.6	17.5	18.6	17.7	23.9	30.0	6.1
	HT/VHT40 STBC, M0 to M7	2	3	17.6	17.5			20.6	30.0	9.4
	HT/VHT40 STBC, M0 to M7	3	3	17.6	17.5	18.6		22.7	30.0	7.3
	HT/VHT40 STBC, M0 to M7	4	3	17.6	17.5	18.6	17.7	23.9	30.0	6.1
5240	Non HT20, 6 to 54 Mbps	1	3	17.2				17.2	30.0	12.8
	Non HT20, 6 to 54 Mbps	2	3	17.2	17.3			20.3	30.0	9.7
	Non HT20, 6 to 54 Mbps	3	3	17.2	17.3	18.6		22.5	30.0	7.5
	Non HT20, 6 to 54 Mbps	4	3	17.2	17.3	18.6	17.8	23.8	30.0	6.2
	Non HT20 Beam Forming, 6 to 54 Mbps	2	6	17.2	17.3			20.3	30.0	9.7
	Non HT20 Beam Forming, 6 to 54 Mbps	3	8	17.2	17.3	18.6		22.5	28.0	5.5
	Non HT20 Beam Forming, 6 to 54 Mbps	4	9	17.2	17.3	18.6	17.8	23.8	27.0	3.2
	HT/VHT20, M0 to M7	1	3	17.3				17.3	30.0	12.7
	HT/VHT20, M0 to M7	2	3	17.3	17.4			20.4	30.0	9.6
	HT/VHT20, M8 to M15	2	3	17.3	17.4			20.4	30.0	9.6
	HT/VHT20, M0 to M7	3	3	17.3	17.4	18.8		22.7	30.0	7.3
	HT/VHT20, M8 to M15	3	3	17.3	17.4	18.8		22.7	30.0	7.3
	HT/VHT20, M16 to M23	3	3	17.3	17.4	18.8		22.7	30.0	7.3
	HT/VHT20, M0 to M7	4	3	17.3	17.4	18.8	17.9	23.9	30.0	6.1
	HT/VHT20, M8 to M15	4	3	17.3	17.4	18.8	17.9	23.9	30.0	6.1
	HT/VHT20, M16 to M23	4	3	17.3	17.4	18.8	17.9	23.9	30.0	6.1
	HT/VHT20 Beam Forming, M0 to M7	2	6	17.3	17.4			20.4	30.0	9.6
	HT/VHT20 Beam Forming, M8 to M15	2	3	17.3	17.4			20.4	30.0	9.6
	HT/VHT20 Beam Forming, M0 to M7	3	8	17.3	17.4	18.8		22.7	28.0	5.3
	HT/VHT20 Beam Forming, M8 to M15	3	5	17.3	17.4	18.8		22.7	30.0	7.3
	HT/VHT20 Beam Forming, M16 to M23	3	3	17.3	17.4	18.8		22.7	30.0	7.3
	HT/VHT20 Beam Forming, M0 to M7	4	9	17.3	17.4	18.8	17.9	23.9	27.0	3.1
	HT/VHT20 Beam Forming, M8 to M15	4	6	17.3	17.4	18.8	17.9	23.9	30.0	6.1
	HT/VHT20 Beam Forming, M16 to M23	4	4	17.3	17.4	18.8	17.9	23.9	30.0	6.1
	HT/VHT20 STBC, M0 to M7	2	3	17.3	17.4			20.4	30.0	9.6
	HT/VHT20 STBC, M0 to M7	3	3	17.3	17.4	18.8		22.7	30.0	7.3
	HT/VHT20 STBC, M0 to M7	4	3	17.3	17.4	18.8	17.9	23.9	30.0	6.1

Frequency (MHz)	Mode	Tx Paths	Correlated Antenna Gain (dBi)	Tx 1 PSD (dBm/MHz)	Tx 2 PSD (dBm/MHz)	Tx 3 PSD (dBm/MHz)	Tx 4 PSD (dBm/MHz)	Total PSD (dBm/MHz)	Limit (dBm/MHz)	Margin (dB)
5180	Non HT20, 6 to 54 Mbps	1	3	8.6				8.6	17.0	8.4
	Non HT20, 6 to 54 Mbps	2	6	8.6	7.7			11.2	17.0	5.8
	Non HT20, 6 to 54 Mbps	3	8	8.6	7.7	7.4		12.7	15.0	2.3
	Non HT20, 6 to 54 Mbps	4	9	8.6	7.7	7.4	7.7	13.9	14.0	0.1
	Non HT20 Beam Forming, 6 to 54 Mbps	2	6	8.6	7.7			11.2	17.0	5.8
	Non HT20 Beam Forming, 6 to 54 Mbps	3	8	8.6	7.7	7.4		12.7	15.0	2.3
	Non HT20 Beam Forming, 6 to 54 Mbps	4	9	5.3	6.6	6.0	6.4	12.1	14.0	1.9
	HT/VHT20, M0 to M7	1	3	8.2				8.2	17.0	8.8
	HT/VHT20, M0 to M7	2	6	8.2	7.7			11.0	17.0	6.0
	HT/VHT20, M8 to M15	2	3	8.2	7.7			11.0	17.0	6.0
	HT/VHT20, M0 to M7	3	8	8.2	7.7	6.8		12.4	15.0	2.6
	HT/VHT20, M8 to M15	3	5	8.2	7.7	6.8		12.4	17.0	4.6
	HT/VHT20, M16 to M23	3	3	8.2	7.7	6.8		12.4	17.0	4.6
	HT/VHT20, M0 to M7	4	9	8.2	7.7	6.8	7.2	13.5	14.0	0.5
	HT/VHT20, M8 to M15	4	6	8.2	7.7	6.8	7.2	13.5	17.0	3.5
	HT/VHT20, M16 to M23	4	4	8.2	7.7	6.8	7.2	13.5	17.0	3.5
	HT/VHT20 Beam Forming, M0 to M7	2	6	8.2	7.7			11.0	17.0	6.0
	HT/VHT20 Beam Forming, M8 to M15	2	3	8.2	7.7			11.0	17.0	6.0
	HT/VHT20 Beam Forming, M0 to M7	3	8	8.2	7.7	6.8		12.4	15.0	2.6
	HT/VHT20 Beam Forming, M8 to M15	3	5	8.2	7.7	6.8		12.4	17.0	4.6
	HT/VHT20 Beam Forming, M16 to M23	3	3	8.2	7.7	6.8		12.4	17.0	4.6
	HT/VHT20 Beam Forming, M0 to M7	4	9	5.9	5.4	4.9	5.2	11.4	14.0	2.6
	HT/VHT20 Beam Forming, M8 to M15	4	6	8.2	7.7	6.8	7.2	13.5	17.0	3.5
	HT/VHT20 Beam Forming, M16 to M23	4	4	8.2	7.7	6.8	7.2	13.5	17.0	3.5
	HT/VHT20 STBC, M0 to M7	2	3	8.2	7.7			11.0	17.0	6.0
	HT/VHT20 STBC, M0 to M7	3	5	8.2	7.7	6.8		12.4	17.0	4.6
	HT/VHT20 STBC, M0 to M7	4	6	8.2	7.7	6.8	7.2	13.5	17.0	3.5
	5190	Non HT40, 6 to 54 Mbps	1	3	5.2				5.2	17.0
Non HT40, 6 to 54 Mbps		2	6	4.2	3.2			6.7	17.0	10.3
Non HT40, 6 to 54 Mbps		3	8	2.9	2.5	2.8		7.5	15.0	7.5
Non HT40, 6 to 54 Mbps		4	9	2.1	1.2	1.4	0.9	7.4	14.0	6.6
HT/VHT40, M0 to M7		1	3	5.1				5.1	17.0	11.9
HT/VHT40, M0 to M7		2	6	5.1	4.6			7.9	17.0	9.1
HT/VHT40, M8 to M15		2	3	5.1	4.6			7.9	17.0	9.1



	HT/VHT40, M0 to M7	3	8	5.1	4.6	4.2		9.4	15.0	5.6
	HT/VHT40, M8 to M15	3	5	5.1	4.6	4.2		9.4	17.0	7.6
	HT/VHT40, M16 to M23	3	3	5.1	4.6	4.2		9.4	17.0	7.6
	HT/VHT40, M0 to M7	4	9	5.1	4.6	4.2	3.9	10.5	14.0	3.5
	HT/VHT40, M8 to M15	4	6	5.1	4.6	4.2	3.9	10.5	17.0	6.5
	HT/VHT40, M16 to M23	4	4	5.1	4.6	4.2	3.9	10.5	17.0	6.5
	HT/VHT40 Beam Forming, M0 to M7	2	6	5.1	4.6			7.9	17.0	9.1
	HT/VHT40 Beam Forming, M8 to M15	2	3	5.1	4.6			7.9	17.0	9.1
	HT/VHT40 Beam Forming, M0 to M7	3	8	2.8	2.0	2.0		7.1	15.0	7.9
	HT/VHT40 Beam Forming, M8 to M15	3	5	3.9	3.5	2.9		8.2	17.0	8.8
	HT/VHT40 Beam Forming, M16 to M23	3	3	5.1	4.6	4.2		9.4	17.0	7.6
	HT/VHT40 Beam Forming, M0 to M7	4	9	1.6	1.4	-0.2	0.9	7.0	14.0	7.0
	HT/VHT40 Beam Forming, M8 to M15	4	6	2.8	2.0	2.0	2.0	8.2	17.0	8.8
	HT/VHT40 Beam Forming, M16 to M23	4	4	3.9	3.5	2.9	3.0	9.4	17.0	7.6
	HT/VHT40 STBC, M0 to M7	2	3	5.1	4.6			7.9	17.0	9.1
	HT/VHT40 STBC, M0 to M7	3	5	5.1	4.6	4.2		9.4	17.0	7.6
	HT/VHT40 STBC, M0 to M7	4	6	5.1	4.6	4.2	3.9	10.5	17.0	6.5
5210	Non HT80, 6 to 54 Mbps	1	3	-0.1				-0.1	17.0	17.1
	Non HT80, 6 to 54 Mbps	2	6	-0.1	-0.7			2.6	17.0	14.4
	Non HT80, 6 to 54 Mbps	3	8	-1.3	-1.8	-1.1		3.4	15.0	11.6
	Non HT80, 6 to 54 Mbps	4	9	-2.4	-3.0	-2.3	-2.9	3.4	14.0	10.6
	VHT80, M0 to M9 1ss	1	3	1.1				1.1	17.0	15.9
	VHT80, M0 to M9 1ss	2	6	1.1	0.5			3.8	17.0	13.2
	VHT80, M0 to M9 2ss	2	3	1.1	0.5			3.8	17.0	13.2
	VHT80, M0 to M9 1ss	3	8	1.1	0.5	0.9		5.6	15.0	9.4
	VHT80, M0 to M9 2ss	3	5	1.1	0.5	0.9		5.6	17.0	11.4
	VHT80, M0 to M9 3ss	3	3	1.1	0.5	0.9		5.6	17.0	11.4
	VHT80, M0 to M9 1ss	4	9	-0.1	-0.6	-0.4	-1.2	5.5	14.0	8.5
	VHT80, M0 to M9 2ss	4	6	-0.1	-0.6	-0.4	-1.2	5.5	17.0	11.5
	VHT80, M0 to M9 3ss	4	4	-0.1	-0.6	-0.4	-1.2	5.5	17.0	11.5
	VHT80 Beam Forming, M0 to M9 1ss	2	6	-0.1	-0.6			2.7	17.0	14.3
	VHT80 Beam Forming, M0 to M9 2ss	2	3	1.1	0.5			3.8	17.0	13.2
	VHT80 Beam Forming, M0 to M9 1ss	3	8	-2.3	-2.8	-3.7		1.9	15.0	13.1
	VHT80 Beam Forming, M0 to M9 2ss	3	5	-0.1	-0.6	-0.4		4.4	17.0	12.6
	VHT80 Beam Forming, M0 to M9 3ss	3	3	1.1	0.5	0.9		5.6	17.0	11.4
	VHT80 Beam Forming, M0 to M9 1ss	4	9	-4.3	-5.0	-4.4	-5.3	1.3	14.0	12.7
	VHT80 Beam Forming, M0 to M9 2ss	4	6	-1.4	-1.4	-2.5	-3.0	4.0	17.0	13.0
	VHT80 Beam Forming, M0 to M9 3ss	4	4	-1.2	-1.7	-1.2	-2.1	4.5	17.0	12.5
	VHT80 STBC, M0 to M9 1ss	2	3	1.1	0.5			3.8	17.0	13.2
	VHT80 STBC, M0 to M9 1ss	3	3	1.1	0.5	0.9		5.6	17.0	11.4
VHT80 STBC, M0 to M9 1ss	4	3	-0.1	-0.6	-0.4	-1.2	5.5	17.0	11.5	

5220	Non HT20, 6 to 54 Mbps	1	3	7.4				7.4	17.0	9.6
	Non HT20, 6 to 54 Mbps	2	6	7.4	7.5			10.5	17.0	6.5
	Non HT20, 6 to 54 Mbps	3	8	7.4	7.5	8.1		12.4	15.0	2.6
	Non HT20, 6 to 54 Mbps	4	9	7.4	7.5	8.1	7.1	13.6	14.0	0.4
	Non HT20 Beam Forming, 6 to 54 Mbps	2	6	7.4	7.5			10.5	17.0	6.5
	Non HT20 Beam Forming, 6 to 54 Mbps	3	8	7.4	7.5	8.1		12.4	15.0	2.6
	Non HT20 Beam Forming, 6 to 54 Mbps	4	9	7.4	7.5	8.1	7.1	13.6	14.0	0.4
	HT/VHT20, M0 to M7	1	3	7.2				7.2	17.0	9.8
	HT/VHT20, M0 to M7	2	6	7.2	7.4			10.3	17.0	6.7
	HT/VHT20, M8 to M15	2	3	7.2	7.4			10.3	17.0	6.7
	HT/VHT20, M0 to M7	3	8	7.2	7.4	8.0		12.3	15.0	2.7
	HT/VHT20, M8 to M15	3	5	7.2	7.4	8.0		12.3	17.0	4.7
	HT/VHT20, M16 to M23	3	3	7.2	7.4	8.0		12.3	17.0	4.7
	HT/VHT20, M0 to M7	4	9	7.2	7.4	8.0	7.0	13.4	14.0	0.6
	HT/VHT20, M8 to M15	4	6	7.2	7.4	8.0	7.0	13.4	17.0	3.6
	HT/VHT20, M16 to M23	4	4	7.2	7.4	8.0	7.0	13.4	17.0	3.6
	HT/VHT20 Beam Forming, M0 to M7	2	6	7.2	7.4			10.3	17.0	6.7
	HT/VHT20 Beam Forming, M8 to M15	2	3	7.2	7.4			10.3	17.0	6.7
	HT/VHT20 Beam Forming, M0 to M7	3	8	7.2	7.4	8.0		12.3	15.0	2.7
	HT/VHT20 Beam Forming, M8 to M15	3	5	7.2	7.4	8.0		12.3	17.0	4.7
	HT/VHT20 Beam Forming, M16 to M23	3	3	7.2	7.4	8.0		12.3	17.0	4.7
	HT/VHT20 Beam Forming, M0 to M7	4	9	7.2	7.4	8.0	7.0	13.4	14.0	0.6
	HT/VHT20 Beam Forming, M8 to M15	4	6	7.2	7.4	8.0	7.0	13.4	17.0	3.6
	HT/VHT20 Beam Forming, M16 to M23	4	4	7.2	7.4	8.0	7.0	13.4	17.0	3.6
HT/VHT20 STBC, M0 to M7	2	3	7.2	7.4			10.3	17.0	6.7	
HT/VHT20 STBC, M0 to M7	3	5	7.2	7.4	8.0		12.3	17.0	4.7	
HT/VHT20 STBC, M0 to M7	4	6	7.2	7.4	8.0	7.0	13.4	17.0	3.6	
5230	Non HT40, 6 to 54 Mbps	1	3	5.5				5.5	17.0	11.5
	Non HT40, 6 to 54 Mbps	2	6	5.5	5.9			8.7	17.0	8.3
	Non HT40, 6 to 54 Mbps	3	8	5.5	5.9	6.8		10.9	15.0	4.1
	Non HT40, 6 to 54 Mbps	4	9	5.5	5.9	6.8	5.6	12.0	14.0	2.0
	HT/VHT40, M0 to M7	1	3	4.1				4.1	17.0	12.9
	HT/VHT40, M0 to M7	2	6	4.1	3.8			7.0	17.0	10.0
	HT/VHT40, M8 to M15	2	3	4.1	3.8			7.0	17.0	10.0
	HT/VHT40, M0 to M7	3	8	4.1	3.8	4.8		9.0	15.0	6.0
	HT/VHT40, M8 to M15	3	5	4.1	3.8	4.8		9.0	17.0	8.0
	HT/VHT40, M16 to M23	3	3	4.1	3.8	4.8		9.0	17.0	8.0
	HT/VHT40, M0 to M7	4	9	4.1	3.8	4.8	3.8	10.2	14.0	3.8
	HT/VHT40, M8 to M15	4	6	4.1	3.8	4.8	3.8	10.2	17.0	6.8
	HT/VHT40, M16 to M23	4	4	4.1	3.8	4.8	3.8	10.2	17.0	6.8

	HT/VHT40 Beam Forming, M0 to M7	2	6	4.1	3.8			7.0	17.0	10.0
	HT/VHT40 Beam Forming, M8 to M15	2	3	4.1	3.8			7.0	17.0	10.0
	HT/VHT40 Beam Forming, M0 to M7	3	8	4.1	3.8	4.8		9.0	15.0	6.0
	HT/VHT40 Beam Forming, M8 to M15	3	5	4.1	3.8	4.8		9.0	17.0	8.0
	HT/VHT40 Beam Forming, M16 to M23	3	3	4.1	3.8	4.8		9.0	17.0	8.0
	HT/VHT40 Beam Forming, M0 to M7	4	9	4.1	3.8	4.8	3.8	10.2	14.0	3.8
	HT/VHT40 Beam Forming, M8 to M15	4	6	4.1	3.8	4.8	3.8	10.2	17.0	6.8
	HT/VHT40 Beam Forming, M16 to M23	4	4	4.1	3.8	4.8	3.8	10.2	17.0	6.8
	HT/VHT40 STBC, M0 to M7	2	3	4.1	3.8			7.0	17.0	10.0
	HT/VHT40 STBC, M0 to M7	3	5	4.1	3.8	4.8		9.0	17.0	8.0
	HT/VHT40 STBC, M0 to M7	4	6	4.1	3.8	4.8	3.8	10.2	17.0	6.8
5240	Non HT20, 6 to 54 Mbps	1	3	6.9				6.9	17.0	10.1
	Non HT20, 6 to 54 Mbps	2	6	6.9	6.9			9.9	17.0	7.1
	Non HT20, 6 to 54 Mbps	3	8	6.9	6.9	8.3		12.2	15.0	2.8
	Non HT20, 6 to 54 Mbps	4	9	6.9	6.9	8.3	7.4	13.4	14.0	0.6
	Non HT20 Beam Forming, 6 to 54 Mbps	2	6	6.9	6.9			9.9	17.0	7.1
	Non HT20 Beam Forming, 6 to 54 Mbps	3	8	6.9	6.9	8.3		12.2	15.0	2.8
	Non HT20 Beam Forming, 6 to 54 Mbps	4	9	6.9	6.9	8.3	7.4	13.4	14.0	0.6
	HT/VHT20, M0 to M7	1	3	6.5				6.5	17.0	10.5
	HT/VHT20, M0 to M7	2	6	6.5	6.7			9.6	17.0	7.4
	HT/VHT20, M8 to M15	2	3	6.5	6.7			9.6	17.0	7.4
	HT/VHT20, M0 to M7	3	8	6.5	6.7	8.1		11.9	15.0	3.1
	HT/VHT20, M8 to M15	3	5	6.5	6.7	8.1		11.9	17.0	5.1
	HT/VHT20, M16 to M23	3	3	6.5	6.7	8.1		11.9	17.0	5.1
	HT/VHT20, M0 to M7	4	9	6.5	6.7	8.1	7.0	13.1	14.0	0.9
	HT/VHT20, M8 to M15	4	6	6.5	6.7	8.1	7.0	13.1	17.0	3.9
	HT/VHT20, M16 to M23	4	4	6.5	6.7	8.1	7.0	13.1	17.0	3.9
	HT/VHT20 Beam Forming, M0 to M7	2	6	6.5	6.7			9.6	17.0	7.4
	HT/VHT20 Beam Forming, M8 to M15	2	3	6.5	6.7			9.6	17.0	7.4
	HT/VHT20 Beam Forming, M0 to M7	3	8	6.5	6.7	8.1		11.9	15.0	3.1
	HT/VHT20 Beam Forming, M8 to M15	3	5	6.5	6.7	8.1		11.9	17.0	5.1
	HT/VHT20 Beam Forming, M16 to M23	3	3	6.5	6.7	8.1		11.9	17.0	5.1
	HT/VHT20 Beam Forming, M0 to M7	4	9	6.5	6.7	8.1	7.0	13.1	14.0	0.9
	HT/VHT20 Beam Forming, M8 to M15	4	6	6.5	6.7	8.1	7.0	13.1	17.0	3.9
	HT/VHT20 Beam Forming, M16 to M23	4	4	6.5	6.7	8.1	7.0	13.1	17.0	3.9
	HT/VHT20 STBC, M0 to M7	2	3	6.5	6.7			9.6	17.0	7.4
	HT/VHT20 STBC, M0 to M7	3	5	6.5	6.7	8.1		11.9	17.0	5.1
	HT/VHT20 STBC, M0 to M7	4	6	6.5	6.7	8.1	7.0	13.1	17.0	3.9

Peak Output Power, 5220 MHz, HT/VHT20 Beam Forming, M0 to M7



Antenna A

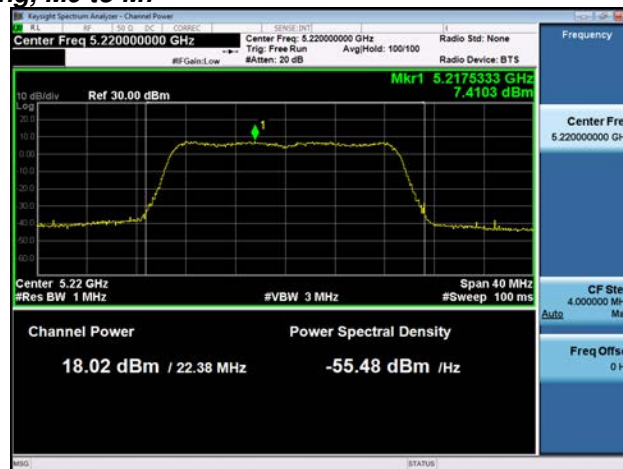

Antenna B

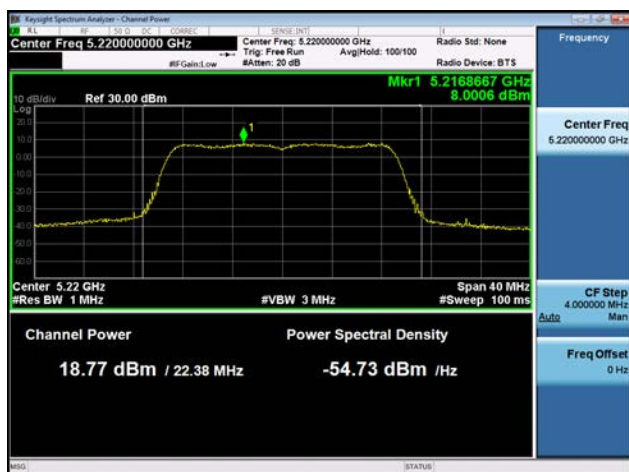

Antenna C

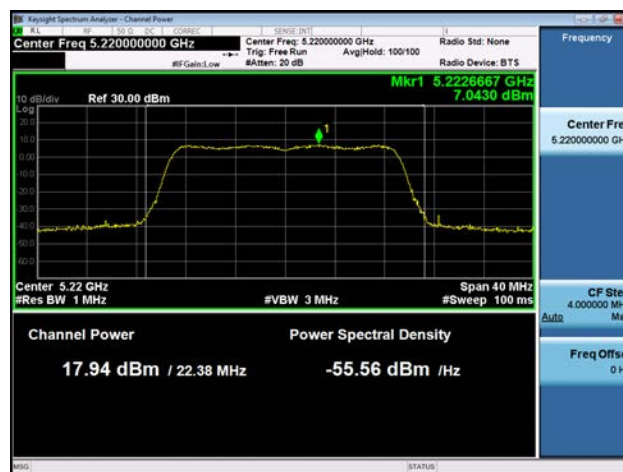

Antenna D

Power Spectral Density, 5180 MHz, Non HT20, 6 to 54 Mbps

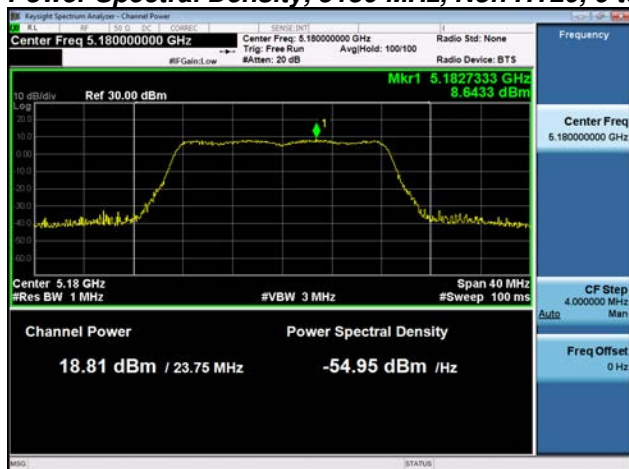

Antenna A

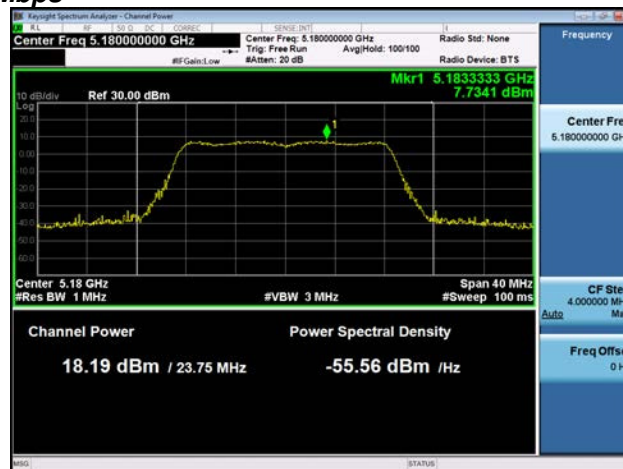

Antenna B

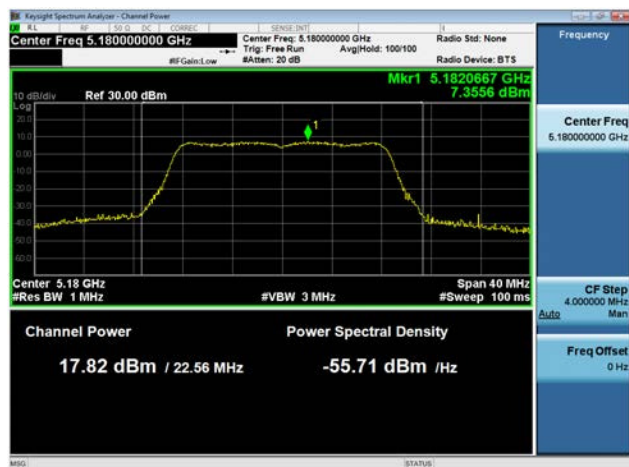

Antenna C

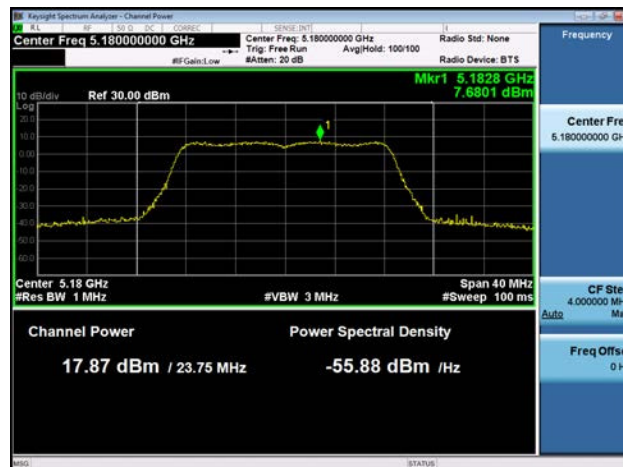

Antenna D

Antenna Gain : 4 dBi

Frequency (MHz)	Mode	Tx Paths	Correlated Antenna Gain (dBi)	Tx 1 Max Power (dBm)	Tx 2 Max Power (dBm)	Tx 3 Max Power (dBm)	Tx 4 Max Power (dBm)	Total Tx Channel Power (dBm)	Limit (dBm)	Margin (dB)
5180	Non HT20, 6 to 54 Mbps	1	4	18.8				18.8	30.0	11.2
	Non HT20, 6 to 54 Mbps	2	4	18.8	18.2			21.5	30.0	8.5
	Non HT20, 6 to 54 Mbps	3	4	18.8	18.2	17.8		23.1	30.0	6.9
	Non HT20, 6 to 54 Mbps	4	4	15.7	17.1	16.4	16.8	22.6	30.0	7.4
	Non HT20 Beam Forming, 6 to 54 Mbps	2	7	18.8	18.2			21.5	29.0	7.5
	Non HT20 Beam Forming, 6 to 54 Mbps	3	9	15.7	17.1	16.4		21.2	27.0	5.8
	Non HT20 Beam Forming, 6 to 54 Mbps	4	10	16.3	15.9	14.3	14.7	21.4	26.0	4.6
	HT/VHT20, M0 to M7	1	4	19.0				19.0	30.0	11.0
	HT/VHT20, M0 to M7	2	4	19.0	18.4			21.7	30.0	8.3
	HT/VHT20, M8 to M15	2	4	19.0	18.4			21.7	30.0	8.3
	HT/VHT20, M0 to M7	3	4	19.0	18.4	17.8		23.2	30.0	6.8
	HT/VHT20, M8 to M15	3	4	19.0	18.4	17.8		23.2	30.0	6.8
	HT/VHT20, M16 to M23	3	4	19.0	18.4	17.8		23.2	30.0	6.8
	HT/VHT20, M0 to M7	4	4	17.8	17.4	16.7	17.1	23.3	30.0	6.7
	HT/VHT20, M8 to M15	4	4	19.0	18.4	17.8	18.2	24.4	30.0	5.6
	HT/VHT20, M16 to M23	4	4	19.0	18.4	17.8	18.2	24.4	30.0	5.6
	HT/VHT20 Beam Forming, M0 to M7	2	7	19.0	18.4			21.7	29.0	7.3
	HT/VHT20 Beam Forming, M8 to M15	2	4	19.0	18.4			21.7	30.0	8.3
	HT/VHT20 Beam Forming, M0 to M7	3	9	17.8	17.4	16.7		22.1	27.0	4.9
	HT/VHT20 Beam Forming, M8 to M15	3	6	19.0	18.4	17.8		23.2	30.0	6.8
	HT/VHT20 Beam Forming, M16 to M23	3	4	19.0	18.4	17.8		23.2	30.0	6.8
	HT/VHT20 Beam Forming, M0 to M7	4	10	16.6	16.2	14.7	15.1	21.7	26.0	4.3
	HT/VHT20 Beam Forming, M8 to M15	4	7	19.0	18.4	17.8	18.2	24.4	29.0	4.6
	HT/VHT20 Beam Forming, M16 to M23	4	5	19.0	18.4	17.8	18.2	24.4	30.0	5.6
	HT/VHT20 STBC, M0 to M7	2	4	19.0	18.4			21.7	30.0	8.3
	HT/VHT20 STBC, M0 to M7	3	4	19.0	18.4	17.8		23.2	30.0	6.8
	HT/VHT20 STBC, M0 to M7	4	4	19.0	18.4	17.8	18.2	24.4	30.0	5.6
	5190	Non HT40, 6 to 54 Mbps	1	4	18.6				18.6	30.0
Non HT40, 6 to 54 Mbps		2	4	17.5	17.0			20.3	30.0	9.7
Non HT40, 6 to 54 Mbps		3	4	16.4	15.9	15.8		20.8	30.0	9.2
Non HT40, 6 to 54 Mbps		4	4	15.2	14.8	14.6	14.5	20.8	30.0	9.2
HT/VHT40, M0 to M7		1	4	18.8				18.8	30.0	11.2
HT/VHT40, M0 to M7		2	4	18.8	18.3			21.6	30.0	8.4



	HT/VHT40, M8 to M15	2	4	18.8	18.3			21.6	30.0	8.4
	HT/VHT40, M0 to M7	3	4	18.8	18.3	17.8		23.1	30.0	6.9
	HT/VHT40, M8 to M15	3	4	18.8	18.3	17.8		23.1	30.0	6.9
	HT/VHT40, M16 to M23	3	4	18.8	18.3	17.8		23.1	30.0	6.9
	HT/VHT40, M0 to M7	4	4	17.6	17.2	16.8	16.8	23.1	30.0	6.9
	HT/VHT40, M8 to M15	4	4	17.6	17.2	16.8	16.8	23.1	30.0	6.9
	HT/VHT40, M16 to M23	4	4	17.6	17.2	16.8	16.8	23.1	30.0	6.9
	HT/VHT40 Beam Forming, M0 to M7	2	7	18.8	18.3			21.6	29.0	7.4
	HT/VHT40 Beam Forming, M8 to M15	2	4	18.8	18.3			21.6	30.0	8.4
	HT/VHT40 Beam Forming, M0 to M7	3	9	16.3	15.9	14.7		20.5	27.0	6.5
	HT/VHT40 Beam Forming, M8 to M15	3	6	17.6	17.2	16.8		22.0	30.0	8.0
	HT/VHT40 Beam Forming, M16 to M23	3	4	18.8	18.3	17.8		23.1	30.0	6.9
	HT/VHT40 Beam Forming, M0 to M7	4	10	14.1	13.9	13.5	13.5	19.8	26.0	6.2
	HT/VHT40 Beam Forming, M8 to M15	4	7	16.3	15.9	14.7	14.5	21.4	29.0	7.6
	HT/VHT40 Beam Forming, M16 to M23	4	5	17.6	17.2	16.8	16.8	23.1	30.0	6.9
	HT/VHT40 STBC, M0 to M7	2	4	18.8	18.3			21.6	30.0	8.4
	HT/VHT40 STBC, M0 to M7	3	4	18.8	18.3	17.8		23.1	30.0	6.9
	HT/VHT40 STBC, M0 to M7	4	4	17.6	17.2	16.8	16.8	23.1	30.0	6.9
5210	Non HT80, 6 to 54 Mbps	1	4	16.3				16.3	30.0	13.7
	Non HT80, 6 to 54 Mbps	2	4	16.3	16.0			19.2	30.0	10.8
	Non HT80, 6 to 54 Mbps	3	4	13.9	13.6	14.4		18.8	30.0	11.2
	Non HT80, 6 to 54 Mbps	4	4	13.9	13.6	14.4	13.9	20.0	30.0	10.0
	VHT80, M0 to M9 1ss	1	4	18.0				18.0	30.0	12.0
	VHT80, M0 to M9 1ss	2	4	18.0	17.7			20.9	30.0	9.1
	VHT80, M0 to M9 2ss	2	4	18.0	17.7			20.9	30.0	9.1
	VHT80, M0 to M9 1ss	3	4	16.8	16.6	17.0		21.6	30.0	8.4
	VHT80, M0 to M9 2ss	3	4	16.8	16.6	17.0		21.6	30.0	8.4
	VHT80, M0 to M9 3ss	3	4	16.8	16.6	17.0		21.6	30.0	8.4
	VHT80, M0 to M9 1ss	4	4	15.7	15.4	16.0	15.4	21.7	30.0	8.3
	VHT80, M0 to M9 2ss	4	4	15.7	15.4	16.0	15.4	21.7	30.0	8.3
	VHT80, M0 to M9 3ss	4	4	15.7	15.4	16.0	15.4	21.7	30.0	8.3
	VHT80 Beam Forming, M0 to M9 1ss	2	7	16.8	16.6			19.7	29.0	9.3
	VHT80 Beam Forming, M0 to M9 2ss	2	4	18.0	17.7			20.9	30.0	9.1
	VHT80 Beam Forming, M0 to M9 1ss	3	9	14.4	14.3	13.7		18.9	27.0	8.1
	VHT80 Beam Forming, M0 to M9 2ss	3	6	15.7	15.4	16.0		20.5	30.0	9.5
	VHT80 Beam Forming, M0 to M9 3ss	3	4	16.8	16.6	17.0		21.6	30.0	8.4
	VHT80 Beam Forming, M0 to M9 1ss	4	10	11.5	11.4	11.7	11.2	17.5	26.0	8.5
	VHT80 Beam Forming, M0 to M9 2ss	4	7	14.4	14.3	13.7	14.3	20.2	29.0	8.8
	VHT80 Beam Forming, M0 to M9 3ss	4	5	15.7	15.4	16.0	15.4	21.7	30.0	8.3
VHT80 STBC, M0 to M9 1ss	2	4	18.0	17.7			20.9	30.0	9.1	
VHT80 STBC, M0 to M9 1ss	3	4	16.8	16.6	17.0		21.6	30.0	8.4	

	VHT80 STBC, M0 to M9 1ss	4	4	15.7	15.4	16.0	15.4	21.7	30.0	8.3
5220	Non HT20, 6 to 54 Mbps	1	4	17.8				17.8	30.0	12.2
	Non HT20, 6 to 54 Mbps	2	4	17.8	17.9			20.9	30.0	9.1
	Non HT20, 6 to 54 Mbps	3	4	17.8	17.9	18.6		22.9	30.0	7.1
	Non HT20, 6 to 54 Mbps	4	4	16.7	16.8	17.6	16.7	23.0	30.0	7.0
	Non HT20 Beam Forming, 6 to 54 Mbps	2	7	17.8	17.9			20.9	29.0	8.1
	Non HT20 Beam Forming, 6 to 54 Mbps	3	9	17.8	17.9	18.6		22.9	27.0	4.1
	Non HT20 Beam Forming, 6 to 54 Mbps	4	10	16.7	16.8	17.6	16.7	23.0	26.0	3.0
	HT/VHT20, M0 to M7	1	4	18.0				18.0	30.0	12.0
	HT/VHT20, M0 to M7	2	4	18.0	18.0			21.0	30.0	9.0
	HT/VHT20, M8 to M15	2	4	18.0	18.0			21.0	30.0	9.0
	HT/VHT20, M0 to M7	3	4	18.0	18.0	18.8		23.1	30.0	6.9
	HT/VHT20, M8 to M15	3	4	18.0	18.0	18.8		23.1	30.0	6.9
	HT/VHT20, M16 to M23	3	4	18.0	18.0	18.8		23.1	30.0	6.9
	HT/VHT20, M0 to M7	4	4	16.8	17.0	17.7	16.8	23.1	30.0	6.9
	HT/VHT20, M8 to M15	4	4	18.0	18.0	18.8	17.9	24.2	30.0	5.8
	HT/VHT20, M16 to M23	4	4	18.0	18.0	18.8	17.9	24.2	30.0	5.8
	HT/VHT20 Beam Forming, M0 to M7	2	7	18.0	18.0			21.0	29.0	8.0
	HT/VHT20 Beam Forming, M8 to M15	2	4	18.0	18.0			21.0	30.0	9.0
	HT/VHT20 Beam Forming, M0 to M7	3	9	18.0	18.0	18.8		23.1	27.0	3.9
	HT/VHT20 Beam Forming, M8 to M15	3	6	18.0	18.0	18.8		23.1	30.0	6.9
	HT/VHT20 Beam Forming, M16 to M23	3	4	18.0	18.0	18.8		23.1	30.0	6.9
	HT/VHT20 Beam Forming, M0 to M7	4	10	15.6	15.8	16.7	15.8	22.0	26.0	4.0
	HT/VHT20 Beam Forming, M8 to M15	4	7	18.0	18.0	18.8	17.9	24.2	29.0	4.8
	HT/VHT20 Beam Forming, M16 to M23	4	5	18.0	18.0	18.8	17.9	24.2	30.0	5.8
HT/VHT20 STBC, M0 to M7	2	4	18.0	18.0			21.0	30.0	9.0	
HT/VHT20 STBC, M0 to M7	3	4	18.0	18.0	18.8		23.1	30.0	6.9	
HT/VHT20 STBC, M0 to M7	4	4	18.0	18.0	18.8	17.9	24.2	30.0	5.8	
5230	Non HT40, 6 to 54 Mbps	1	4	18.7				18.7	30.0	11.3
	Non HT40, 6 to 54 Mbps	2	4	18.7	18.8			21.8	30.0	8.2
	Non HT40, 6 to 54 Mbps	3	4	18.7	18.8	20.0		24.0	30.0	6.0
	Non HT40, 6 to 54 Mbps	4	4	18.7	18.8	20.0	19.0	25.2	30.0	4.8
	HT/VHT40, M0 to M7	1	4	17.6				17.6	30.0	12.4
	HT/VHT40, M0 to M7	2	4	17.6	17.5			20.6	30.0	9.4
	HT/VHT40, M8 to M15	2	4	17.6	17.5			20.6	30.0	9.4
	HT/VHT40, M0 to M7	3	4	17.6	17.5	18.6		22.7	30.0	7.3
	HT/VHT40, M8 to M15	3	4	17.6	17.5	18.6		22.7	30.0	7.3
	HT/VHT40, M16 to M23	3	4	17.6	17.5	18.6		22.7	30.0	7.3
	HT/VHT40, M0 to M7	4	4	17.6	17.5	18.6	17.7	23.9	30.0	6.1
	HT/VHT40, M8 to M15	4	4	17.6	17.5	18.6	17.7	23.9	30.0	6.1

	HT/VHT40, M16 to M23	4	4	17.6	17.5	18.6	17.7	23.9	30.0	6.1
	HT/VHT40 Beam Forming, M0 to M7	2	7	17.6	17.5			20.6	29.0	8.4
	HT/VHT40 Beam Forming, M8 to M15	2	4	17.6	17.5			20.6	30.0	9.4
	HT/VHT40 Beam Forming, M0 to M7	3	9	17.6	17.5	18.6		22.7	27.0	4.3
	HT/VHT40 Beam Forming, M8 to M15	3	6	17.6	17.5	18.6		22.7	30.0	7.3
	HT/VHT40 Beam Forming, M16 to M23	3	4	17.6	17.5	18.6		22.7	30.0	7.3
	HT/VHT40 Beam Forming, M0 to M7	4	10	16.4	16.4	17.6	16.6	22.8	26.0	3.2
	HT/VHT40 Beam Forming, M8 to M15	4	7	17.6	17.5	18.6	17.7	23.9	29.0	5.1
	HT/VHT40 Beam Forming, M16 to M23	4	5	17.6	17.5	18.6	17.7	23.9	30.0	6.1
	HT/VHT40 STBC, M0 to M7	2	4	17.6	17.5			20.6	30.0	9.4
	HT/VHT40 STBC, M0 to M7	3	4	17.6	17.5	18.6		22.7	30.0	7.3
	HT/VHT40 STBC, M0 to M7	4	4	17.6	17.5	18.6	17.7	23.9	30.0	6.1
5240	Non HT20, 6 to 54 Mbps	1	4	17.2				17.2	30.0	12.8
	Non HT20, 6 to 54 Mbps	2	4	17.2	17.3			20.3	30.0	9.7
	Non HT20, 6 to 54 Mbps	3	4	17.2	17.3	18.6		22.5	30.0	7.5
	Non HT20, 6 to 54 Mbps	4	4	16.0	16.1	17.6	16.7	22.7	30.0	7.3
	Non HT20 Beam Forming, 6 to 54 Mbps	2	7	17.2	17.3			20.3	29.0	8.7
	Non HT20 Beam Forming, 6 to 54 Mbps	3	9	17.2	17.3	18.6		22.5	27.0	4.5
	Non HT20 Beam Forming, 6 to 54 Mbps	4	10	16.0	16.1	17.6	16.7	22.7	26.0	3.3
	HT/VHT20, M0 to M7	1	4	17.3				17.3	30.0	12.7
	HT/VHT20, M0 to M7	2	4	17.3	17.4			20.4	30.0	9.6
	HT/VHT20, M8 to M15	2	4	17.3	17.4			20.4	30.0	9.6
	HT/VHT20, M0 to M7	3	4	17.3	17.4	18.8		22.7	30.0	7.3
	HT/VHT20, M8 to M15	3	4	17.3	17.4	18.8		22.7	30.0	7.3
	HT/VHT20, M16 to M23	3	4	17.3	17.4	18.8		22.7	30.0	7.3
	HT/VHT20, M0 to M7	4	4	16.2	16.2	17.7	16.9	22.8	30.0	7.2
	HT/VHT20, M8 to M15	4	4	17.3	17.4	18.8	17.9	23.9	30.0	6.1
	HT/VHT20, M16 to M23	4	4	17.3	17.4	18.8	17.9	23.9	30.0	6.1
	HT/VHT20 Beam Forming, M0 to M7	2	7	17.3	17.4			20.4	29.0	8.6
	HT/VHT20 Beam Forming, M8 to M15	2	4	17.3	17.4			20.4	30.0	9.6
	HT/VHT20 Beam Forming, M0 to M7	3	9	17.3	17.4	18.8		22.7	27.0	4.3
	HT/VHT20 Beam Forming, M8 to M15	3	6	17.3	17.4	18.8		22.7	30.0	7.3
	HT/VHT20 Beam Forming, M16 to M23	3	4	17.3	17.4	18.8		22.7	30.0	7.3
	HT/VHT20 Beam Forming, M0 to M7	4	10	16.2	16.2	17.7	16.9	22.8	26.0	3.2
	HT/VHT20 Beam Forming, M8 to M15	4	7	17.3	17.4	18.8	17.9	23.9	29.0	5.1
	HT/VHT20 Beam Forming, M16 to M23	4	5	17.3	17.4	18.8	17.9	23.9	30.0	6.1
	HT/VHT20 STBC, M0 to M7	2	4	17.3	17.4			20.4	30.0	9.6
	HT/VHT20 STBC, M0 to M7	3	4	17.3	17.4	18.8		22.7	30.0	7.3
	HT/VHT20 STBC, M0 to M7	4	4	17.3	17.4	18.8	17.9	23.9	30.0	6.1

Frequency (MHz)	Mode	Tx Paths	Correlated Antenna Gain (dBi)	Tx 1 PSD (dBm/MHz)	Tx 2 PSD (dBm/MHz)	Tx 3 PSD (dBm/MHz)	Tx 4 PSD (dBm/MHz)	Total PSD (dBm/MHz)	Limit (dBm/MHz)	Margin (dB)
5180	Non HT20, 6 to 54 Mbps	1	4	8.6				8.6	17.0	8.4
	Non HT20, 6 to 54 Mbps	2	7	8.6	7.7			11.2	16.0	4.8
	Non HT20, 6 to 54 Mbps	3	9	8.6	7.7	7.4		12.7	14.0	1.3
	Non HT20, 6 to 54 Mbps	4	10	5.3	6.6	6.0	6.4	12.1	13.0	0.9
	Non HT20 Beam Forming, 6 to 54 Mbps	2	7	8.6	7.7			11.2	16.0	4.8
	Non HT20 Beam Forming, 6 to 54 Mbps	3	9	5.3	6.6	6.0		10.8	14.0	3.2
	Non HT20 Beam Forming, 6 to 54 Mbps	4	10	6.3	5.4	3.8	4.3	11.1	13.0	1.9
	HT/VHT20, M0 to M7	1	4	8.2				8.2	17.0	8.8
	HT/VHT20, M0 to M7	2	7	8.2	7.7			11.0	16.0	5.0
	HT/VHT20, M8 to M15	2	4	8.2	7.7			11.0	17.0	6.0
	HT/VHT20, M0 to M7	3	9	8.2	7.7	6.8		12.4	14.0	1.6
	HT/VHT20, M8 to M15	3	6	8.2	7.7	6.8		12.4	17.0	4.6
	HT/VHT20, M16 to M23	3	4	8.2	7.7	6.8		12.4	17.0	4.6
	HT/VHT20, M0 to M7	4	10	7.1	6.4	6.2	6.5	12.6	13.0	0.4
	HT/VHT20, M8 to M15	4	7	8.2	7.7	6.8	7.2	13.5	16.0	2.5
	HT/VHT20, M16 to M23	4	5	8.2	7.7	6.8	7.2	13.5	17.0	3.5
	HT/VHT20 Beam Forming, M0 to M7	2	7	8.2	7.7			11.0	16.0	5.0
	HT/VHT20 Beam Forming, M8 to M15	2	4	8.2	7.7			11.0	17.0	6.0
	HT/VHT20 Beam Forming, M0 to M7	3	9	7.1	6.4	6.2		11.4	14.0	2.6
	HT/VHT20 Beam Forming, M8 to M15	3	6	8.2	7.7	6.8		12.4	17.0	4.6
	HT/VHT20 Beam Forming, M16 to M23	3	4	8.2	7.7	6.8		12.4	17.0	4.6
	HT/VHT20 Beam Forming, M0 to M7	4	10	6.0	5.4	3.8	4.2	11.0	13.0	2.0
	HT/VHT20 Beam Forming, M8 to M15	4	7	8.2	7.7	6.8	7.2	13.5	16.0	2.5
	HT/VHT20 Beam Forming, M16 to M23	4	5	8.2	7.7	6.8	7.2	13.5	17.0	3.5
	HT/VHT20 STBC, M0 to M7	2	4	8.2	7.7			11.0	17.0	6.0
	HT/VHT20 STBC, M0 to M7	3	6	8.2	7.7	6.8		12.4	17.0	4.6
HT/VHT20 STBC, M0 to M7	4	7	8.2	7.7	6.8	7.2	13.5	16.0	2.5	
5190	Non HT40, 6 to 54 Mbps	1	4	5.2				5.2	17.0	11.8
	Non HT40, 6 to 54 Mbps	2	7	4.2	3.2			6.7	16.0	9.3
	Non HT40, 6 to 54 Mbps	3	9	2.9	2.5	2.8		7.5	14.0	6.5
	Non HT40, 6 to 54 Mbps	4	10	2.1	1.2	1.4	0.9	7.4	13.0	5.6
	HT/VHT40, M0 to M7	1	4	5.1				5.1	17.0	11.9
	HT/VHT40, M0 to M7	2	7	5.1	4.6			7.9	16.0	8.1
	HT/VHT40, M8 to M15	2	4	5.1	4.6			7.9	17.0	9.1

	HT/VHT40, M0 to M7	3	9	5.1	4.6	4.2		9.4	14.0	4.6
	HT/VHT40, M8 to M15	3	6	5.1	4.6	4.2		9.4	17.0	7.6
	HT/VHT40, M16 to M23	3	4	5.1	4.6	4.2		9.4	17.0	7.6
	HT/VHT40, M0 to M7	4	10	3.9	3.5	2.9	3.0	9.4	13.0	3.6
	HT/VHT40, M8 to M15	4	7	3.9	3.5	2.9	3.0	9.4	16.0	6.6
	HT/VHT40, M16 to M23	4	5	3.9	3.5	2.9	3.0	9.4	17.0	7.6
	HT/VHT40 Beam Forming, M0 to M7	2	7	5.1	4.6			7.9	16.0	8.1
	HT/VHT40 Beam Forming, M8 to M15	2	4	5.1	4.6			7.9	17.0	9.1
	HT/VHT40 Beam Forming, M0 to M7	3	9	2.3	2.4	1.2		6.8	14.0	7.2
	HT/VHT40 Beam Forming, M8 to M15	3	6	3.9	3.5	2.9		8.2	17.0	8.8
	HT/VHT40 Beam Forming, M16 to M23	3	4	5.1	4.6	4.2		9.4	17.0	7.6
	HT/VHT40 Beam Forming, M0 to M7	4	10	0.3	0.1	-0.2	-0.3	6.0	13.0	7.0
	HT/VHT40 Beam Forming, M8 to M15	4	7	2.3	2.4	1.2	0.6	7.7	16.0	8.3
	HT/VHT40 Beam Forming, M16 to M23	4	5	3.9	3.5	2.9	3.0	9.4	17.0	7.6
	HT/VHT40 STBC, M0 to M7	2	4	5.1	4.6			7.9	17.0	9.1
	HT/VHT40 STBC, M0 to M7	3	6	5.1	4.6	4.2		9.4	17.0	7.6
	HT/VHT40 STBC, M0 to M7	4	7	3.9	3.5	2.9	3.0	9.4	16.0	6.6
5210	Non HT80, 6 to 54 Mbps	1	4	-0.1				-0.1	17.0	17.1
	Non HT80, 6 to 54 Mbps	2	7	-0.1	-0.7			2.6	16.0	13.4
	Non HT80, 6 to 54 Mbps	3	9	-2.4	-3.0	-2.3		2.2	14.0	11.8
	Non HT80, 6 to 54 Mbps	4	10	-2.4	-3.0	-2.3	-2.9	3.4	13.0	9.6
	VHT80, M0 to M9 1ss	1	4	1.1				1.1	17.0	15.9
	VHT80, M0 to M9 1ss	2	7	1.1	0.5			3.8	16.0	12.2
	VHT80, M0 to M9 2ss	2	4	1.1	0.5			3.8	17.0	13.2
	VHT80, M0 to M9 1ss	3	9	-0.1	-0.6	-0.4		4.4	14.0	9.6
	VHT80, M0 to M9 2ss	3	6	-0.1	-0.6	-0.4		4.4	17.0	12.6
	VHT80, M0 to M9 3ss	3	4	-0.1	-0.6	-0.4		4.4	17.0	12.6
	VHT80, M0 to M9 1ss	4	10	-1.2	-1.7	-1.2	-2.1	4.5	13.0	8.5
	VHT80, M0 to M9 2ss	4	7	-1.2	-1.7	-1.2	-2.1	4.5	16.0	11.5
	VHT80, M0 to M9 3ss	4	5	-1.2	-1.7	-1.2	-2.1	4.5	17.0	12.5
	VHT80 Beam Forming, M0 to M9 1ss	2	7	-0.1	-0.6			2.7	16.0	13.3
	VHT80 Beam Forming, M0 to M9 2ss	2	4	1.1	0.5			3.8	17.0	13.2
	VHT80 Beam Forming, M0 to M9 1ss	3	9	-2.3	-2.8	-3.7		1.9	14.0	12.1
	VHT80 Beam Forming, M0 to M9 2ss	3	6	-1.2	-1.7	-1.2		3.4	17.0	13.6
	VHT80 Beam Forming, M0 to M9 3ss	3	4	-0.1	-0.6	-0.4		4.4	17.0	12.6
	VHT80 Beam Forming, M0 to M9 1ss	4	10	-5.1	-5.9	-5.8	-6.3	0.3	13.0	12.7
	VHT80 Beam Forming, M0 to M9 2ss	4	7	-2.3	-2.8	-3.7	-3.2	3.1	16.0	12.9
	VHT80 Beam Forming, M0 to M9 3ss	4	5	-1.2	-1.7	-1.2	-2.1	4.5	17.0	12.5
	VHT80 STBC, M0 to M9 1ss	2	4	1.1	0.5			3.8	17.0	13.2
	VHT80 STBC, M0 to M9 1ss	3	4	-0.1	-0.6	-0.4		4.4	17.0	12.6
VHT80 STBC, M0 to M9 1ss	4	4	-1.2	-1.7	-1.2	-2.1	4.5	17.0	12.5	

5220	Non HT20, 6 to 54 Mbps	1	4	7.4				7.4	17.0	9.6
	Non HT20, 6 to 54 Mbps	2	7	7.4	7.5			10.5	16.0	5.5
	Non HT20, 6 to 54 Mbps	3	9	7.4	7.5	8.1		12.4	14.0	1.6
	Non HT20, 6 to 54 Mbps	4	10	6.1	6.2	7.1	5.9	12.4	13.0	0.6
	Non HT20 Beam Forming, 6 to 54 Mbps	2	7	7.4	7.5			10.5	16.0	5.5
	Non HT20 Beam Forming, 6 to 54 Mbps	3	9	7.4	7.5	8.1		12.4	14.0	1.6
	Non HT20 Beam Forming, 6 to 54 Mbps	4	10	6.1	6.2	7.1	5.9	12.4	13.0	0.6
	HT/VHT20, M0 to M7	1	4	7.2				7.2	17.0	9.8
	HT/VHT20, M0 to M7	2	7	7.2	7.4			10.3	16.0	5.7
	HT/VHT20, M8 to M15	2	4	7.2	7.4			10.3	17.0	6.7
	HT/VHT20, M0 to M7	3	9	7.2	7.4	8.0		12.3	14.0	1.7
	HT/VHT20, M8 to M15	3	6	7.2	7.4	8.0		12.3	17.0	4.7
	HT/VHT20, M16 to M23	3	4	7.2	7.4	8.0		12.3	17.0	4.7
	HT/VHT20, M0 to M7	4	10	6.2	6.5	6.9	6.1	12.5	13.0	0.5
	HT/VHT20, M8 to M15	4	7	7.2	7.4	8.0	7.0	13.4	16.0	2.6
	HT/VHT20, M16 to M23	4	5	7.2	7.4	8.0	7.0	13.4	17.0	3.6
	HT/VHT20 Beam Forming, M0 to M7	2	7	7.2	7.4			10.3	16.0	5.7
	HT/VHT20 Beam Forming, M8 to M15	2	4	7.2	7.4			10.3	17.0	6.7
	HT/VHT20 Beam Forming, M0 to M7	3	9	7.2	7.4	8.0		12.3	14.0	1.7
	HT/VHT20 Beam Forming, M8 to M15	3	6	7.2	7.4	8.0		12.3	17.0	4.7
	HT/VHT20 Beam Forming, M16 to M23	3	4	7.2	7.4	8.0		12.3	17.0	4.7
	HT/VHT20 Beam Forming, M0 to M7	4	10	5.0	5.0	5.7	5.0	11.2	13.0	1.8
	HT/VHT20 Beam Forming, M8 to M15	4	7	7.2	7.4	8.0	7.0	13.4	16.0	2.6
HT/VHT20 Beam Forming, M16 to M23	4	5	7.2	7.4	8.0	7.0	13.4	17.0	3.6	
HT/VHT20 STBC, M0 to M7	2	4	7.2	7.4			10.3	17.0	6.7	
HT/VHT20 STBC, M0 to M7	3	6	7.2	7.4	8.0		12.3	17.0	4.7	
HT/VHT20 STBC, M0 to M7	4	7	7.2	7.4	8.0	7.0	13.4	16.0	2.6	
5230	Non HT40, 6 to 54 Mbps	1	4	5.5				5.5	17.0	11.5
	Non HT40, 6 to 54 Mbps	2	7	5.5	5.9			8.7	16.0	7.3
	Non HT40, 6 to 54 Mbps	3	9	5.5	5.9	6.8		10.9	14.0	3.1
	Non HT40, 6 to 54 Mbps	4	10	5.5	5.9	6.8	5.6	12.0	13.0	1.0
	HT/VHT40, M0 to M7	1	4	4.1				4.1	17.0	12.9
	HT/VHT40, M0 to M7	2	7	4.1	3.8			7.0	16.0	9.0
	HT/VHT40, M8 to M15	2	4	4.1	3.8			7.0	17.0	10.0
	HT/VHT40, M0 to M7	3	9	4.1	3.8	4.8		9.0	14.0	5.0
	HT/VHT40, M8 to M15	3	6	4.1	3.8	4.8		9.0	17.0	8.0
	HT/VHT40, M16 to M23	3	4	4.1	3.8	4.8		9.0	17.0	8.0
	HT/VHT40, M0 to M7	4	10	4.1	3.8	4.8	3.8	10.2	13.0	2.8
	HT/VHT40, M8 to M15	4	7	4.1	3.8	4.8	3.8	10.2	16.0	5.8
	HT/VHT40, M16 to M23	4	5	4.1	3.8	4.8	3.8	10.2	17.0	6.8

	HT/VHT40 Beam Forming, M0 to M7	2	7	4.1	3.8			7.0	16.0	9.0
	HT/VHT40 Beam Forming, M8 to M15	2	4	4.1	3.8			7.0	17.0	10.0
	HT/VHT40 Beam Forming, M0 to M7	3	9	4.1	3.8	4.8		9.0	14.0	5.0
	HT/VHT40 Beam Forming, M8 to M15	3	6	4.1	3.8	4.8		9.0	17.0	8.0
	HT/VHT40 Beam Forming, M16 to M23	3	4	4.1	3.8	4.8		9.0	17.0	8.0
	HT/VHT40 Beam Forming, M0 to M7	4	10	3.1	3.0	3.8	2.8	9.2	13.0	3.8
	HT/VHT40 Beam Forming, M8 to M15	4	7	4.1	3.8	4.8	3.8	10.2	16.0	5.8
	HT/VHT40 Beam Forming, M16 to M23	4	5	4.1	3.8	4.8	3.8	10.2	17.0	6.8
	HT/VHT40 STBC, M0 to M7	2	4	4.1	3.8			7.0	17.0	10.0
	HT/VHT40 STBC, M0 to M7	3	6	4.1	3.8	4.8		9.0	17.0	8.0
	HT/VHT40 STBC, M0 to M7	4	7	4.1	3.8	4.8	3.8	10.2	16.0	5.8
5240	Non HT20, 6 to 54 Mbps	1	4	6.9				6.9	17.0	10.1
	Non HT20, 6 to 54 Mbps	2	7	6.9	6.9			9.9	16.0	6.1
	Non HT20, 6 to 54 Mbps	3	9	6.9	6.9	8.3		12.2	14.0	1.8
	Non HT20, 6 to 54 Mbps	4	10	5.3	5.6	7.0	6.2	12.1	13.0	0.9
	Non HT20 Beam Forming, 6 to 54 Mbps	2	7	6.9	6.9			9.9	16.0	6.1
	Non HT20 Beam Forming, 6 to 54 Mbps	3	9	6.9	6.9	8.3		12.2	14.0	1.8
	Non HT20 Beam Forming, 6 to 54 Mbps	4	10	5.3	5.6	7.0	6.2	12.1	13.0	0.9
	HT/VHT20, M0 to M7	1	4	6.5				6.5	17.0	10.5
	HT/VHT20, M0 to M7	2	7	6.5	6.7			9.6	16.0	6.4
	HT/VHT20, M8 to M15	2	4	6.5	6.7			9.6	17.0	7.4
	HT/VHT20, M0 to M7	3	9	6.5	6.7	8.1		11.9	14.0	2.1
	HT/VHT20, M8 to M15	3	6	6.5	6.7	8.1		11.9	17.0	5.1
	HT/VHT20, M16 to M23	3	4	6.5	6.7	8.1		11.9	17.0	5.1
	HT/VHT20, M0 to M7	4	10	5.4	5.5	7.2	6.1	12.1	13.0	0.9
	HT/VHT20, M8 to M15	4	7	6.5	6.7	8.1	7.0	13.1	16.0	2.9
	HT/VHT20, M16 to M23	4	5	6.5	6.7	8.1	7.0	13.1	17.0	3.9
	HT/VHT20 Beam Forming, M0 to M7	2	7	6.5	6.7			9.6	16.0	6.4
	HT/VHT20 Beam Forming, M8 to M15	2	4	6.5	6.7			9.6	17.0	7.4
	HT/VHT20 Beam Forming, M0 to M7	3	9	6.5	6.7	8.1		11.9	14.0	2.1
	HT/VHT20 Beam Forming, M8 to M15	3	6	6.5	6.7	8.1		11.9	17.0	5.1
	HT/VHT20 Beam Forming, M16 to M23	3	4	6.5	6.7	8.1		11.9	17.0	5.1
	HT/VHT20 Beam Forming, M0 to M7	4	10	5.4	5.5	7.2	6.1	12.1	13.0	0.9
	HT/VHT20 Beam Forming, M8 to M15	4	7	6.5	6.7	8.1	7.0	13.1	16.0	2.9
	HT/VHT20 Beam Forming, M16 to M23	4	5	6.5	6.7	8.1	7.0	13.1	17.0	3.9
	HT/VHT20 STBC, M0 to M7	2	4	6.5	6.7			9.6	17.0	7.4
	HT/VHT20 STBC, M0 to M7	3	6	6.5	6.7	8.1		11.9	17.0	5.1
	HT/VHT20 STBC, M0 to M7	4	7	6.5	6.7	8.1	7.0	13.1	16.0	2.9

15.407 (i) The maximum e.i.r.p. at any elevation angle above 30 degrees as measured from the horizon must not exceed 125 mW (21 dBm).

Frequency (MHz)	Mode	Tx Paths	Correlated Antenna Gain (dBi)	Tx 1 Max Power (dBm)	Tx 2 Max Power (dBm)	Tx 3 Max Power (dBm)	Tx 4 Max Power (dBm)	Total Radiated Channel Power (dBm)	Limit (dBm)	Margin (dB)
5180	Non HT20, 6 to 54 Mbps	1	-8	18.8				10.8	21.0	10.2
	Non HT20, 6 to 54 Mbps	2	-8	18.8	18.2			13.5	21.0	7.5
	Non HT20, 6 to 54 Mbps	3	-8	18.8	18.2	17.8		15.1	21.0	5.9
	Non HT20, 6 to 54 Mbps	4	-8	15.7	17.1	16.4	16.8	14.6	21.0	6.4
	Non HT20 Beam Forming, 6 to 54 Mbps	2	-5	18.8	18.2			16.5	21.0	4.5
	Non HT20 Beam Forming, 6 to 54 Mbps	3	-3	15.7	17.1	16.4		18.2	21.0	2.8
	Non HT20 Beam Forming, 6 to 54 Mbps	4	-2	16.3	15.9	14.3	14.7	19.4	21.0	1.6
	HT/VHT20, M0 to M7	1	-8	19.0				11.0	21.0	10.0
	HT/VHT20, M0 to M7	2	-8	19.0	18.4			13.7	21.0	7.3
	HT/VHT20, M8 to M15	2	-8	19.0	18.4			13.7	21.0	7.3
	HT/VHT20, M0 to M7	3	-8	19.0	18.4	17.8		15.2	21.0	5.8
	HT/VHT20, M8 to M15	3	-8	19.0	18.4	17.8		15.2	21.0	5.8
	HT/VHT20, M16 to M23	3	-8	19.0	18.4	17.8		15.2	21.0	5.8
	HT/VHT20, M0 to M7	4	-8	17.8	17.4	16.7	17.1	15.3	21.0	5.7
	HT/VHT20, M8 to M15	4	-8	19.0	18.4	17.8	18.2	16.4	21.0	4.6
	HT/VHT20, M16 to M23	4	-8	19.0	18.4	17.8	18.2	16.4	21.0	4.6
	HT/VHT20 Beam Forming, M0 to M7	2	-5	19.0	18.4			16.7	21.0	4.3
	HT/VHT20 Beam Forming, M8 to M15	2	-8	19.0	18.4			13.7	21.0	7.3
	HT/VHT20 Beam Forming, M0 to M7	3	-3	17.8	17.4	16.7		19.1	21.0	1.9
	HT/VHT20 Beam Forming, M8 to M15	3	-6	19.0	18.4	17.8		17.2	21.0	3.8
	HT/VHT20 Beam Forming, M16 to M23	3	-8	19.0	18.4	17.8		15.2	21.0	5.8
	HT/VHT20 Beam Forming, M0 to M7	4	-2	16.6	16.2	14.7	15.1	19.7	21.0	1.3
	HT/VHT20 Beam Forming, M8 to M15	4	-5	19.0	18.4	17.8	18.2	19.4	21.0	1.6
	HT/VHT20 Beam Forming, M16 to M23	4	-7	19.0	18.4	17.8	18.2	17.4	21.0	3.6
	HT/VHT20 STBC, M0 to M7	2	-8	19.0	18.4			13.7	21.0	7.3
	HT/VHT20 STBC, M0 to M7	3	-8	19.0	18.4	17.8		15.2	21.0	5.8
HT/VHT20 STBC, M0 to M7	4	-8	19.0	18.4	17.8	18.2	16.4	21.0	4.6	
5190	Non HT40, 6 to 54 Mbps	1	-8	18.6				10.6	21.0	10.4
	Non HT40, 6 to 54 Mbps	2	-8	17.5	17.0			12.3	21.0	8.7
	Non HT40, 6 to 54 Mbps	3	-8	16.4	15.9	15.8		12.8	21.0	8.2
	Non HT40, 6 to 54 Mbps	4	-8	15.2	14.8	14.6	14.5	12.8	21.0	8.2
	HT/VHT40, M0 to M7	1	-8	18.8				10.8	21.0	10.2

	HT/VHT40, M0 to M7	2	-8	18.8	18.3			13.6	21.0	7.4
	HT/VHT40, M8 to M15	2	-8	18.8	18.3			13.6	21.0	7.4
	HT/VHT40, M0 to M7	3	-8	18.8	18.3	17.8		15.1	21.0	5.9
	HT/VHT40, M8 to M15	3	-8	18.8	18.3	17.8		15.1	21.0	5.9
	HT/VHT40, M16 to M23	3	-8	18.8	18.3	17.8		15.1	21.0	5.9
	HT/VHT40, M0 to M7	4	-8	17.6	17.2	16.8	16.8	15.1	21.0	5.9
	HT/VHT40, M8 to M15	4	-8	17.6	17.2	16.8	16.8	15.1	21.0	5.9
	HT/VHT40, M16 to M23	4	-8	17.6	17.2	16.8	16.8	15.1	21.0	5.9
	HT/VHT40 Beam Forming, M0 to M7	2	-5	18.8	18.3			16.6	21.0	4.4
	HT/VHT40 Beam Forming, M8 to M15	2	-8	18.8	18.3			13.6	21.0	7.4
	HT/VHT40 Beam Forming, M0 to M7	3	-3	16.3	15.9	14.7		17.5	21.0	3.5
	HT/VHT40 Beam Forming, M8 to M15	3	-6	17.6	17.2	16.8		16.0	21.0	5.0
	HT/VHT40 Beam Forming, M16 to M23	3	-8	18.8	18.3	17.8		15.1	21.0	5.9
	HT/VHT40 Beam Forming, M0 to M7	4	-2	14.1	13.9	13.5	13.5	17.8	21.0	3.2
	HT/VHT40 Beam Forming, M8 to M15	4	-5	16.3	15.9	14.7	14.5	16.4	21.0	4.6
	HT/VHT40 Beam Forming, M16 to M23	4	-7	17.6	17.2	16.8	16.8	16.1	21.0	4.9
	HT/VHT40 STBC, M0 to M7	2	-8	18.8	18.3			13.6	21.0	7.4
	HT/VHT40 STBC, M0 to M7	3	-8	18.8	18.3	17.8		15.1	21.0	5.9
	HT/VHT40 STBC, M0 to M7	4	-8	17.6	17.2	16.8	16.8	15.1	21.0	5.9
5210	Non HT80, 6 to 54 Mbps	1	-8	16.3				8.3	21.0	12.7
	Non HT80, 6 to 54 Mbps	2	-8	16.3	16.0			11.2	21.0	9.8
	Non HT80, 6 to 54 Mbps	3	-8	13.9	13.6	14.4		10.8	21.0	10.2
	Non HT80, 6 to 54 Mbps	4	-8	13.9	13.6	14.4	13.9	12.0	21.0	9.0
	VHT80, M0 to M9 1ss	1	-8	18.0				10.0	21.0	11.0
	VHT80, M0 to M9 1ss	2	-8	18.0	17.7			12.9	21.0	8.1
	VHT80, M0 to M9 2ss	2	-8	18.0	17.7			12.9	21.0	8.1
	VHT80, M0 to M9 1ss	3	-8	16.8	16.6	17.0		13.6	21.0	7.4
	VHT80, M0 to M9 2ss	3	-8	16.8	16.6	17.0		13.6	21.0	7.4
	VHT80, M0 to M9 3ss	3	-8	16.8	16.6	17.0		13.6	21.0	7.4
	VHT80, M0 to M9 1ss	4	-8	15.7	15.4	16.0	15.4	13.7	21.0	7.3
	VHT80, M0 to M9 2ss	4	-8	15.7	15.4	16.0	15.4	13.7	21.0	7.3
	VHT80, M0 to M9 3ss	4	-8	15.7	15.4	16.0	15.4	13.7	21.0	7.3
	VHT80 Beam Forming, M0 to M9 1ss	2	-5	16.8	16.6			14.7	21.0	6.3
	VHT80 Beam Forming, M0 to M9 2ss	2	-8	18.0	17.7			12.9	21.0	8.1
	VHT80 Beam Forming, M0 to M9 1ss	3	-3	14.4	14.3	13.7		15.9	21.0	5.1
	VHT80 Beam Forming, M0 to M9 2ss	3	-6	15.7	15.4	16.0		14.5	21.0	6.5
	VHT80 Beam Forming, M0 to M9 3ss	3	-8	16.8	16.6	17.0		13.6	21.0	7.4
	VHT80 Beam Forming, M0 to M9 1ss	4	-2	11.5	11.4	11.7	11.2	15.5	21.0	5.5
	VHT80 Beam Forming, M0 to M9 2ss	4	-5	14.4	14.3	13.7	14.3	15.2	21.0	5.8
VHT80 Beam Forming, M0 to M9 3ss	4	-7	15.7	15.4	16.0	15.4	14.7	21.0	6.3	
VHT80 STBC, M0 to M9 1ss	2	-8	18.0	17.7			12.9	21.0	8.1	



	VHT80 STBC, M0 to M9 1ss	3	-8	16.8	16.6	17.0		13.6	21.0	7.4
	VHT80 STBC, M0 to M9 1ss	4	-8	15.7	15.4	16.0	15.4	13.7	21.0	7.3
5250	Non HT160, 6 to 54 Mbps	1	-8	12.7				4.7	21.0	16.3
	Non HT160, 6 to 54 Mbps	2	-8	10.7	10.2			5.5	21.0	15.5
	Non HT160, 6 to 54 Mbps	3	-8	9.7	9.2	9.4		6.2	21.0	14.8
	Non HT160, 6 to 54 Mbps	4	-8	9.7	9.2	9.4	9.4	7.4	21.0	13.6
	VHT160, M0 to M9 1ss	1	-8	16.6				8.6	21.0	12.4
	VHT160, M0 to M9 1ss	2	-8	15.4	14.8			10.1	21.0	10.9
	VHT160, M0 to M9 2ss	2	-8	15.4	14.8			10.1	21.0	10.9
	VHT160, M0 to M9 1ss	3	-8	14.2	13.7	14.2		10.8	21.0	10.2
	VHT160, M0 to M9 2ss	3	-8	14.2	13.7	14.2		10.8	21.0	10.2
	VHT160, M0 to M9 3ss	3	-8	14.2	13.7	14.2		10.8	21.0	10.2
	VHT160, M0 to M9 1ss	4	-8	13.2	12.8	13.2	13.1	11.1	21.0	9.9
	VHT160, M0 to M9 2ss	4	-8	13.2	12.8	13.2	13.1	11.1	21.0	9.9
	VHT160, M0 to M9 3ss	4	-8	13.2	12.8	13.2	13.1	11.1	21.0	9.9
	VHT160 Beam Forming, M0 to M9 1ss	2	-5	14.2	13.7			12.0	21.0	9.0
	VHT160 Beam Forming, M0 to M9 2ss	2	-8	15.4	14.8			10.1	21.0	10.9
	VHT160 Beam Forming, M0 to M9 1ss	3	-3	11.3	10.9	11.1		12.9	21.0	8.1
	VHT160 Beam Forming, M0 to M9 2ss	3	-6	13.2	12.8	13.2		11.8	21.0	9.2
	VHT160 Beam Forming, M0 to M9 3ss	3	-8	14.2	13.7	14.2		10.8	21.0	10.2
	VHT160 Beam Forming, M0 to M9 1ss	4	-2	10.4	9.9	10.1	10.1	14.1	21.0	6.9
	VHT160 Beam Forming, M0 to M9 2ss	4	-5	12.3	11.8	12.1	12.0	13.1	21.0	7.9
	VHT160 Beam Forming, M0 to M9 3ss	4	-7	13.2	12.8	13.2	13.1	12.1	21.0	8.9
VHT160 STBC, M0 to M9 1ss	2	-8	15.4	14.8			10.1	21.0	10.9	
VHT160 STBC, M0 to M9 1ss	3	-8	14.2	13.7	14.2		10.8	21.0	10.2	
VHT160 STBC, M0 to M9 1ss	4	-8	13.2	12.8	13.2	13.1	11.1	21.0	9.9	
5220	Non HT20, 6 to 54 Mbps	1	-8	17.8				9.8	21.0	11.2
	Non HT20, 6 to 54 Mbps	2	-8	17.8	17.9			12.9	21.0	8.1
	Non HT20, 6 to 54 Mbps	3	-8	17.8	17.9	18.6		14.9	21.0	6.1
	Non HT20, 6 to 54 Mbps	4	-8	16.7	16.8	17.6	16.7	15.0	21.0	6.0
	Non HT20 Beam Forming, 6 to 54 Mbps	2	-5	17.8	17.9			15.9	21.0	5.1
	Non HT20 Beam Forming, 6 to 54 Mbps	3	-3	17.8	17.9	18.6		19.9	21.0	1.1
	Non HT20 Beam Forming, 6 to 54 Mbps	4	-2	16.7	16.8	17.6	16.7	21.0	21.0	0.0
	HT/VHT20, M0 to M7	1	-8	18.0				10.0	21.0	11.0
	HT/VHT20, M0 to M7	2	-8	18.0	18.0			13.0	21.0	8.0
	HT/VHT20, M8 to M15	2	-8	18.0	18.0			13.0	21.0	8.0
	HT/VHT20, M0 to M7	3	-8	18.0	18.0	18.8		15.1	21.0	5.9
	HT/VHT20, M8 to M15	3	-8	18.0	18.0	18.8		15.1	21.0	5.9
	HT/VHT20, M16 to M23	3	-8	18.0	18.0	18.8		15.1	21.0	5.9
HT/VHT20, M0 to M7	4	-8	16.8	17.0	17.7	16.8	15.1	21.0	5.9	

	HT/VHT20, M8 to M15	4	-8	18.0	18.0	18.8	17.9	16.2	21.0	4.8
	HT/VHT20, M16 to M23	4	-8	18.0	18.0	18.8	17.9	16.2	21.0	4.8
	HT/VHT20 Beam Forming, M0 to M7	2	-5	18.0	18.0			16.0	21.0	5.0
	HT/VHT20 Beam Forming, M8 to M15	2	-8	18.0	18.0			13.0	21.0	8.0
	HT/VHT20 Beam Forming, M0 to M7	3	-3	18.0	18.0	18.8		20.1	21.0	0.9
	HT/VHT20 Beam Forming, M8 to M15	3	-6	18.0	18.0	18.8		17.1	21.0	3.9
	HT/VHT20 Beam Forming, M16 to M23	3	-8	18.0	18.0	18.8		15.1	21.0	5.9
	HT/VHT20 Beam Forming, M0 to M7	4	-2	15.6	15.8	16.7	15.8	20.0	21.0	1.0
	HT/VHT20 Beam Forming, M8 to M15	4	-5	18.0	18.0	18.8	17.9	19.2	21.0	1.8
	HT/VHT20 Beam Forming, M16 to M23	4	-7	18.0	18.0	18.8	17.9	17.2	21.0	3.8
	HT/VHT20 STBC, M0 to M7	2	-8	18.0	18.0			13.0	21.0	8.0
	HT/VHT20 STBC, M0 to M7	3	-8	18.0	18.0	18.8		15.1	21.0	5.9
	HT/VHT20 STBC, M0 to M7	4	-8	18.0	18.0	18.8	17.9	16.2	21.0	4.8
5230	Non HT40, 6 to 54 Mbps	1	-8	18.7				10.7	21.0	10.3
	Non HT40, 6 to 54 Mbps	2	-8	18.7	18.8			13.8	21.0	7.2
	Non HT40, 6 to 54 Mbps	3	-8	18.7	18.8	20.0		16.0	21.0	5.0
	Non HT40, 6 to 54 Mbps	4	-8	18.7	18.8	20.0	19.0	17.2	21.0	3.8
	HT/VHT40, M0 to M7	1	-8	17.6				9.6	21.0	11.4
	HT/VHT40, M0 to M7	2	-8	17.6	17.5			12.6	21.0	8.4
	HT/VHT40, M8 to M15	2	-8	17.6	17.5			12.6	21.0	8.4
	HT/VHT40, M0 to M7	3	-8	17.6	17.5	18.6		14.7	21.0	6.3
	HT/VHT40, M8 to M15	3	-8	17.6	17.5	18.6		14.7	21.0	6.3
	HT/VHT40, M16 to M23	3	-8	17.6	17.5	18.6		14.7	21.0	6.3
	HT/VHT40, M0 to M7	4	-8	17.6	17.5	18.6	17.7	15.9	21.0	5.1
	HT/VHT40, M8 to M15	4	-8	17.6	17.5	18.6	17.7	15.9	21.0	5.1
	HT/VHT40, M16 to M23	4	-8	17.6	17.5	18.6	17.7	15.9	21.0	5.1
	HT/VHT40 Beam Forming, M0 to M7	2	-5	17.6	17.5			15.6	21.0	5.4
	HT/VHT40 Beam Forming, M8 to M15	2	-8	17.6	17.5			12.6	21.0	8.4
	HT/VHT40 Beam Forming, M0 to M7	3	-3	17.6	17.5	18.6		19.7	21.0	1.3
	HT/VHT40 Beam Forming, M8 to M15	3	-6	17.6	17.5	18.6		16.7	21.0	4.3
	HT/VHT40 Beam Forming, M16 to M23	3	-8	17.6	17.5	18.6		14.7	21.0	6.3
	HT/VHT40 Beam Forming, M0 to M7	4	-2	16.4	16.4	17.6	16.6	20.8	21.0	0.2
	HT/VHT40 Beam Forming, M8 to M15	4	-5	17.6	17.5	18.6	17.7	18.9	21.0	2.1
	HT/VHT40 Beam Forming, M16 to M23	4	-7	17.6	17.5	18.6	17.7	16.9	21.0	4.1
	HT/VHT40 STBC, M0 to M7	2	-8	17.6	17.5			12.6	21.0	8.4
HT/VHT40 STBC, M0 to M7	3	-8	17.6	17.5	18.6		14.7	21.0	6.3	
HT/VHT40 STBC, M0 to M7	4	-8	17.6	17.5	18.6	17.7	15.9	21.0	5.1	

5240	Non HT20, 6 to 54 Mbps	1	-8	17.2				9.2	21.0	11.8
	Non HT20, 6 to 54 Mbps	2	-8	17.2	17.3			12.3	21.0	8.7
	Non HT20, 6 to 54 Mbps	3	-8	17.2	17.3	18.6		14.5	21.0	6.5
	Non HT20, 6 to 54 Mbps	4	-8	16.0	16.1	17.6	16.7	14.7	21.0	6.3
	Non HT20 Beam Forming, 6 to 54 Mbps	2	-5	17.2	17.3			15.3	21.0	5.7
	Non HT20 Beam Forming, 6 to 54 Mbps	3	-3	17.2	17.3	18.6		19.5	21.0	1.5
	Non HT20 Beam Forming, 6 to 54 Mbps	4	-2	16.0	16.1	17.6	16.7	20.7	21.0	0.3
	HT/VHT20, M0 to M7	1	-8	17.3				9.3	21.0	11.7
	HT/VHT20, M0 to M7	2	-8	17.3	17.4			12.4	21.0	8.6
	HT/VHT20, M8 to M15	2	-8	17.3	17.4			12.4	21.0	8.6
	HT/VHT20, M0 to M7	3	-8	17.3	17.4	18.8		14.7	21.0	6.3
	HT/VHT20, M8 to M15	3	-8	17.3	17.4	18.8		14.7	21.0	6.3
	HT/VHT20, M16 to M23	3	-8	17.3	17.4	18.8		14.7	21.0	6.3
	HT/VHT20, M0 to M7	4	-8	16.2	16.2	17.7	16.9	14.8	21.0	6.2
	HT/VHT20, M8 to M15	4	-8	17.3	17.4	18.8	17.9	15.9	21.0	5.1
	HT/VHT20, M16 to M23	4	-8	17.3	17.4	18.8	17.9	15.9	21.0	5.1
	HT/VHT20 Beam Forming, M0 to M7	2	-5	17.3	17.4			15.4	21.0	5.6
	HT/VHT20 Beam Forming, M8 to M15	2	-8	17.3	17.4			12.4	21.0	8.6
	HT/VHT20 Beam Forming, M0 to M7	3	-3	17.3	17.4	18.8		19.7	21.0	1.3
	HT/VHT20 Beam Forming, M8 to M15	3	-6	17.3	17.4	18.8		16.7	21.0	4.3
	HT/VHT20 Beam Forming, M16 to M23	3	-8	17.3	17.4	18.8		14.7	21.0	6.3
	HT/VHT20 Beam Forming, M0 to M7	4	-2	16.2	16.2	17.7	16.9	20.8	21.0	0.2
	HT/VHT20 Beam Forming, M8 to M15	4	-5	17.3	17.4	18.8	17.9	18.9	21.0	2.1
	HT/VHT20 Beam Forming, M16 to M23	4	-7	17.3	17.4	18.8	17.9	16.9	21.0	4.1
	HT/VHT20 STBC, M0 to M7	2	-8	17.3	17.4			12.4	21.0	8.6
	HT/VHT20 STBC, M0 to M7	3	-8	17.3	17.4	18.8		14.7	21.0	6.3
HT/VHT20 STBC, M0 to M7	4	-8	17.3	17.4	18.8	17.9	15.9	21.0	5.1	



Peak Output Power, 5220 MHz, Non HT20 Beam Forming, 6 to 54 Mbps

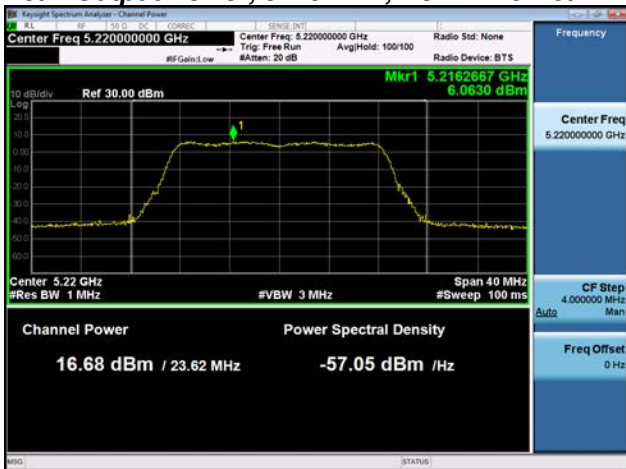

Antenna A

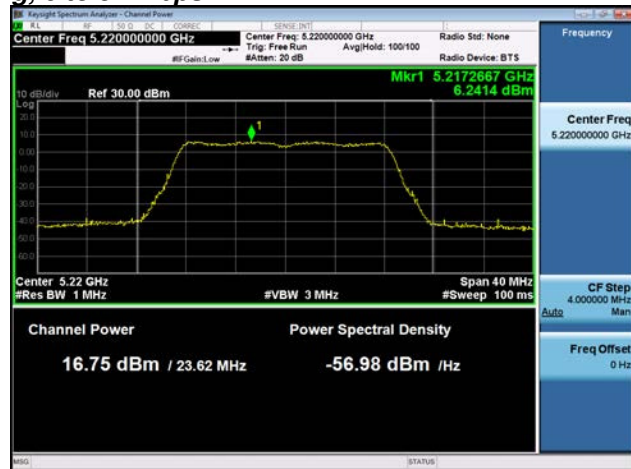

Antenna B

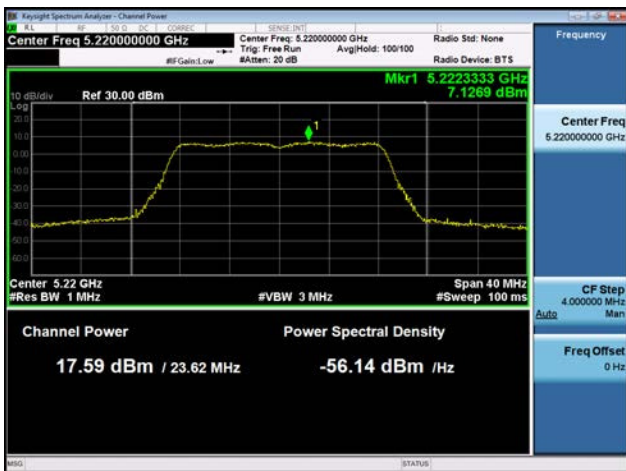

Antenna C

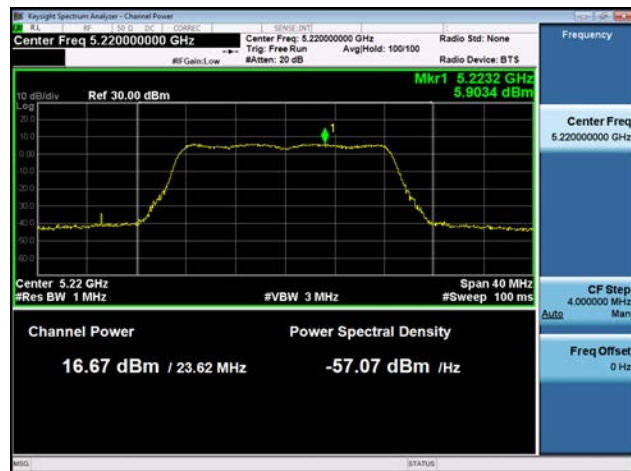

Antenna D

Power Spectral Density, 5180 MHz, HT/VHT20, M0 to M7

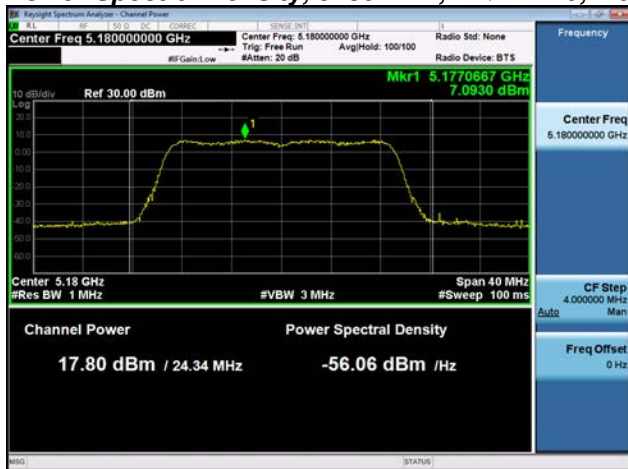

Antenna A

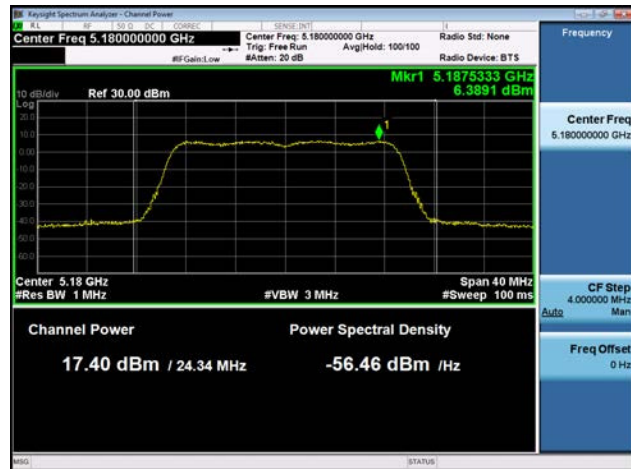

Antenna B

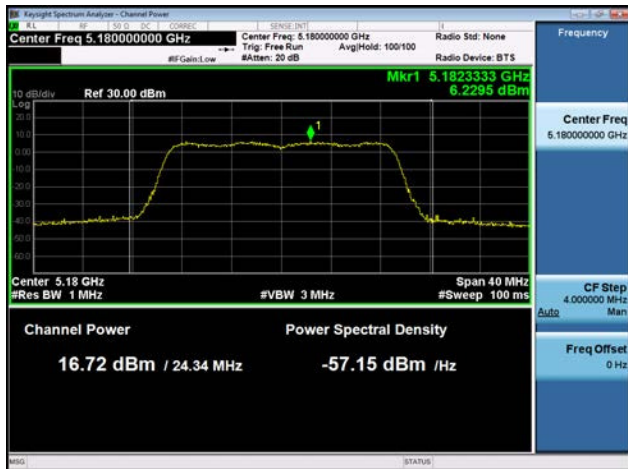

Antenna C

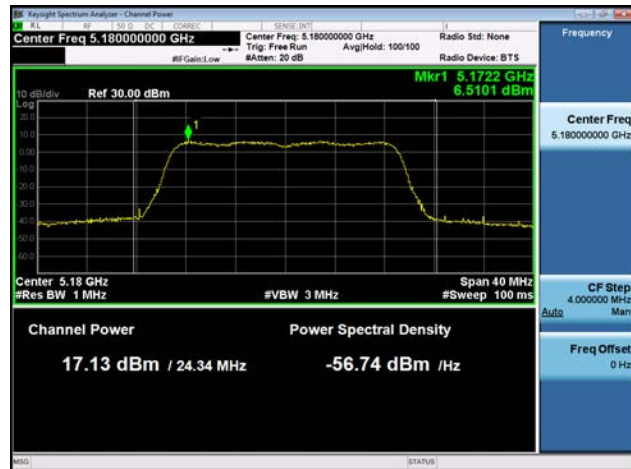

Antenna D

Antenna Gain : 5 dBi

Frequency (MHz)	Mode	Tx Paths	Correlated Antenna Gain (dBi)	Tx 1 Max Power (dBm)	Tx 2 Max Power (dBm)	Tx 3 Max Power (dBm)	Tx 4 Max Power (dBm)	Total Tx Channel Power (dBm)	Limit (dBm)	Margin (dB)
5180	Non HT20, 6 to 54 Mbps	1	5	18.8				18.8	30.0	11.2
	Non HT20, 6 to 54 Mbps	2	5	18.8	18.2			21.5	30.0	8.5
	Non HT20, 6 to 54 Mbps	3	5	18.8	18.2	17.8		23.1	30.0	6.9
	Non HT20, 6 to 54 Mbps	4	5	16.4	15.9	15.3	15.8	21.9	30.0	8.1
	Non HT20 Beam Forming, 6 to 54 Mbps	2	8	18.8	18.2			21.5	28.0	6.5
	Non HT20 Beam Forming, 6 to 54 Mbps	3	10	15.7	17.1	16.4		21.2	26.0	4.8
	Non HT20 Beam Forming, 6 to 54 Mbps	4	11	16.3	15.9	14.3	14.7	21.4	25.0	3.6
	HT/VHT20, M0 to M7	1	5	19.0				19.0	30.0	11.0
	HT/VHT20, M0 to M7	2	5	19.0	18.4			21.7	30.0	8.3
	HT/VHT20, M8 to M15	2	5	19.0	18.4			21.7	30.0	8.3
	HT/VHT20, M0 to M7	3	5	19.0	18.4	17.8		23.2	30.0	6.8
	HT/VHT20, M8 to M15	3	5	19.0	18.4	17.8		23.2	30.0	6.8
	HT/VHT20, M16 to M23	3	5	19.0	18.4	17.8		23.2	30.0	6.8
	HT/VHT20, M0 to M7	4	5	16.7	16.2	15.6	16.1	22.2	30.0	7.8
	HT/VHT20, M8 to M15	4	5	19.0	18.4	17.8	18.2	24.4	30.0	5.6
	HT/VHT20, M16 to M23	4	5	19.0	18.4	17.8	18.2	24.4	30.0	5.6
	HT/VHT20 Beam Forming, M0 to M7	2	8	19.0	18.4			21.7	28.0	6.3
	HT/VHT20 Beam Forming, M8 to M15	2	5	19.0	18.4			21.7	30.0	8.3
	HT/VHT20 Beam Forming, M0 to M7	3	10	16.7	16.2	15.6		21.0	26.0	5.0
	HT/VHT20 Beam Forming, M8 to M15	3	7	19.0	18.4	17.8		23.2	29.0	5.8
	HT/VHT20 Beam Forming, M16 to M23	3	5	19.0	18.4	17.8		23.2	30.0	6.8
	HT/VHT20 Beam Forming, M0 to M7	4	11	15.5	15.1	13.3	13.9	20.6	25.0	4.4
	HT/VHT20 Beam Forming, M8 to M15	4	8	17.8	17.4	16.7	17.1	23.3	28.0	4.7
	HT/VHT20 Beam Forming, M16 to M23	4	6	19.0	18.4	17.8	18.2	24.4	30.0	5.6
	HT/VHT20 STBC, M0 to M7	2	5	19.0	18.4			21.7	30.0	8.3
	HT/VHT20 STBC, M0 to M7	3	5	19.0	18.4	17.8		23.2	30.0	6.8
	HT/VHT20 STBC, M0 to M7	4	5	19.0	18.4	17.8	18.2	24.4	30.0	5.6
	5190	Non HT40, 6 to 54 Mbps	1	5	16.4				16.4	30.0
Non HT40, 6 to 54 Mbps		2	5	15.2	14.8			18.0	30.0	12.0
Non HT40, 6 to 54 Mbps		3	5	15.2	14.8	14.6		19.6	30.0	10.4
Non HT40, 6 to 54 Mbps		4	5	15.2	14.8	14.6	14.5	20.8	30.0	9.2
HT/VHT40, M0 to M7		1	5	18.8				18.8	30.0	11.2
HT/VHT40, M0 to M7		2	5	18.8	18.3			21.6	30.0	8.4

	HT/VHT40, M8 to M15	2	5	18.8	18.3			21.6	30.0	8.4
	HT/VHT40, M0 to M7	3	5	17.6	17.2	16.8		22.0	30.0	8.0
	HT/VHT40, M8 to M15	3	5	17.6	17.2	16.8		22.0	30.0	8.0
	HT/VHT40, M16 to M23	3	5	17.6	17.2	16.8		22.0	30.0	8.0
	HT/VHT40, M0 to M7	4	5	17.6	17.2	16.8	16.8	23.1	30.0	6.9
	HT/VHT40, M8 to M15	4	5	17.6	17.2	16.8	16.8	23.1	30.0	6.9
	HT/VHT40, M16 to M23	4	5	17.6	17.2	16.8	16.8	23.1	30.0	6.9
	HT/VHT40 Beam Forming, M0 to M7	2	8	17.6	17.2			20.4	28.0	7.6
	HT/VHT40 Beam Forming, M8 to M15	2	5	18.8	18.3			21.6	30.0	8.4
	HT/VHT40 Beam Forming, M0 to M7	3	10	15.1	14.9	13.4		19.3	26.0	6.7
	HT/VHT40 Beam Forming, M8 to M15	3	7	16.4	16.0	15.8		20.8	29.0	8.2
	HT/VHT40 Beam Forming, M16 to M23	3	5	17.6	17.2	16.8		22.0	30.0	8.0
	HT/VHT40 Beam Forming, M0 to M7	4	11	14.1	13.9	13.5	13.5	19.8	25.0	5.2
	HT/VHT40 Beam Forming, M8 to M15	4	8	16.3	15.9	14.7	14.5	21.4	28.0	6.6
	HT/VHT40 Beam Forming, M16 to M23	4	6	16.4	16.0	15.8	15.6	22.0	30.0	8.0
	HT/VHT40 STBC, M0 to M7	2	5	18.8	18.3			21.6	30.0	8.4
	HT/VHT40 STBC, M0 to M7	3	5	17.6	17.2	16.8		22.0	30.0	8.0
	HT/VHT40 STBC, M0 to M7	4	5	17.6	17.2	16.8	16.8	23.1	30.0	6.9
5210	Non HT80, 6 to 54 Mbps	1	5	16.3				16.3	30.0	13.7
	Non HT80, 6 to 54 Mbps	2	5	15.2	14.8			18.0	30.0	12.0
	Non HT80, 6 to 54 Mbps	3	5	13.9	13.6	14.4		18.8	30.0	11.2
	Non HT80, 6 to 54 Mbps	4	5	12.7	12.6	13.2	12.5	18.8	30.0	11.2
	VHT80, M0 to M9 1ss	1	5	18.0				18.0	30.0	12.0
	VHT80, M0 to M9 1ss	2	5	18.0	17.7			20.9	30.0	9.1
	VHT80, M0 to M9 2ss	2	5	18.0	17.7			20.9	30.0	9.1
	VHT80, M0 to M9 1ss	3	5	16.8	16.6	17.0		21.6	30.0	8.4
	VHT80, M0 to M9 2ss	3	5	16.8	16.6	17.0		21.6	30.0	8.4
	VHT80, M0 to M9 3ss	3	5	16.8	16.6	17.0		21.6	30.0	8.4
	VHT80, M0 to M9 1ss	4	5	15.7	15.4	16.0	15.4	21.7	30.0	8.3
	VHT80, M0 to M9 2ss	4	5	15.7	15.4	16.0	15.4	21.7	30.0	8.3
	VHT80, M0 to M9 3ss	4	5	15.7	15.4	16.0	15.4	21.7	30.0	8.3
	VHT80 Beam Forming, M0 to M9 1ss	2	8	15.7	15.4			18.6	28.0	9.4
	VHT80 Beam Forming, M0 to M9 2ss	2	5	18.0	17.7			20.9	30.0	9.1
	VHT80 Beam Forming, M0 to M9 1ss	3	10	12.5	12.3	12.8		17.3	26.0	8.7
	VHT80 Beam Forming, M0 to M9 2ss	3	7	15.6	15.4	14.8		20.1	29.0	8.9
	VHT80 Beam Forming, M0 to M9 3ss	3	5	16.8	16.6	17.0		21.6	30.0	8.4
	VHT80 Beam Forming, M0 to M9 1ss	4	11	10.3	8.9	8.4	8.4	15.1	25.0	9.9
	VHT80 Beam Forming, M0 to M9 2ss	4	8	13.4	13.3	13.8	13.3	19.5	28.0	8.5
VHT80 Beam Forming, M0 to M9 3ss	4	6	15.6	15.4	14.8	14.3	21.1	30.0	8.9	
VHT80 STBC, M0 to M9 1ss	2	5	18.0	17.7			20.9	30.0	9.1	
VHT80 STBC, M0 to M9 1ss	3	5	16.8	16.6	17.0		21.6	30.0	8.4	



	VHT80 STBC, M0 to M9 1ss	4	5	15.7	15.4	16.0	15.4	21.7	30.0	8.3
5220	Non HT20, 6 to 54 Mbps	1	5	17.8				17.8	30.0	12.2
	Non HT20, 6 to 54 Mbps	2	5	17.8	17.9			20.9	30.0	9.1
	Non HT20, 6 to 54 Mbps	3	5	17.8	17.9	18.6		22.9	30.0	7.1
	Non HT20, 6 to 54 Mbps	4	5	15.5	15.6	16.6	15.7	21.9	30.0	8.1
	Non HT20 Beam Forming, 6 to 54 Mbps	2	8	17.8	17.9			20.9	28.0	7.1
	Non HT20 Beam Forming, 6 to 54 Mbps	3	10	17.8	17.9	18.6		22.9	26.0	3.1
	Non HT20 Beam Forming, 6 to 54 Mbps	4	11	15.5	15.6	16.6	15.7	21.9	25.0	3.1
	HT/VHT20, M0 to M7	1	5	18.0				18.0	30.0	12.0
	HT/VHT20, M0 to M7	2	5	18.0	18.0			21.0	30.0	9.0
	HT/VHT20, M8 to M15	2	5	18.0	18.0			21.0	30.0	9.0
	HT/VHT20, M0 to M7	3	5	18.0	18.0	18.8		23.1	30.0	6.9
	HT/VHT20, M8 to M15	3	5	18.0	18.0	18.8		23.1	30.0	6.9
	HT/VHT20, M16 to M23	3	5	18.0	18.0	18.8		23.1	30.0	6.9
	HT/VHT20, M0 to M7	4	5	15.6	15.8	16.7	15.8	22.0	30.0	8.0
	HT/VHT20, M8 to M15	4	5	18.0	18.0	18.8	17.9	24.2	30.0	5.8
	HT/VHT20, M16 to M23	4	5	18.0	18.0	18.8	17.9	24.2	30.0	5.8
	HT/VHT20 Beam Forming, M0 to M7	2	8	18.0	18.0			21.0	28.0	7.0
	HT/VHT20 Beam Forming, M8 to M15	2	5	18.0	18.0			21.0	30.0	9.0
	HT/VHT20 Beam Forming, M0 to M7	3	10	18.0	18.0	18.8		23.1	26.0	2.9
	HT/VHT20 Beam Forming, M8 to M15	3	7	18.0	18.0	18.8		23.1	29.0	5.9
	HT/VHT20 Beam Forming, M16 to M23	3	5	18.0	18.0	18.8		23.1	30.0	6.9
	HT/VHT20 Beam Forming, M0 to M7	4	11	15.6	15.8	16.7	15.8	22.0	25.0	3.0
	HT/VHT20 Beam Forming, M8 to M15	4	8	18.0	18.0	18.8	17.9	24.2	28.0	3.8
	HT/VHT20 Beam Forming, M16 to M23	4	6	18.0	18.0	18.8	17.9	24.2	30.0	5.8
HT/VHT20 STBC, M0 to M7	2	5	18.0	18.0			21.0	30.0	9.0	
HT/VHT20 STBC, M0 to M7	3	5	18.0	18.0	18.8		23.1	30.0	6.9	
HT/VHT20 STBC, M0 to M7	4	5	18.0	18.0	18.8	17.9	24.2	30.0	5.8	
5230	Non HT40, 6 to 54 Mbps	1	5	18.7				18.7	30.0	11.3
	Non HT40, 6 to 54 Mbps	2	5	18.7	18.8			21.8	30.0	8.2
	Non HT40, 6 to 54 Mbps	3	5	18.7	18.8	20.0		24.0	30.0	6.0
	Non HT40, 6 to 54 Mbps	4	5	17.6	17.5	19.0	17.7	24.0	30.0	6.0
	HT/VHT40, M0 to M7	1	5	17.6				17.6	30.0	12.4
	HT/VHT40, M0 to M7	2	5	17.6	17.5			20.6	30.0	9.4
	HT/VHT40, M8 to M15	2	5	17.6	17.5			20.6	30.0	9.4
	HT/VHT40, M0 to M7	3	5	17.6	17.5	18.6		22.7	30.0	7.3
	HT/VHT40, M8 to M15	3	5	17.6	17.5	18.6		22.7	30.0	7.3
	HT/VHT40, M16 to M23	3	5	17.6	17.5	18.6		22.7	30.0	7.3
	HT/VHT40, M0 to M7	4	5	17.6	17.5	18.6	17.7	23.9	30.0	6.1
	HT/VHT40, M8 to M15	4	5	17.6	17.5	18.6	17.7	23.9	30.0	6.1

	HT/VHT40, M16 to M23	4	5	17.6	17.5	18.6	17.7	23.9	30.0	6.1
	HT/VHT40 Beam Forming, M0 to M7	2	8	17.6	17.5			20.6	28.0	7.4
	HT/VHT40 Beam Forming, M8 to M15	2	5	17.6	17.5			20.6	30.0	9.4
	HT/VHT40 Beam Forming, M0 to M7	3	10	17.6	17.5	18.6		22.7	26.0	3.3
	HT/VHT40 Beam Forming, M8 to M15	3	7	17.6	17.5	18.6		22.7	29.0	6.3
	HT/VHT40 Beam Forming, M16 to M23	3	5	17.6	17.5	18.6		22.7	30.0	7.3
	HT/VHT40 Beam Forming, M0 to M7	4	11	17.6	17.5	18.6	17.7	23.9	25.0	1.1
	HT/VHT40 Beam Forming, M8 to M15	4	8	17.6	17.5	18.6	17.7	23.9	28.0	4.1
	HT/VHT40 Beam Forming, M16 to M23	4	6	17.6	17.5	18.6	17.7	23.9	30.0	6.1
	HT/VHT40 STBC, M0 to M7	2	5	17.6	17.5			20.6	30.0	9.4
	HT/VHT40 STBC, M0 to M7	3	5	17.6	17.5	18.6		22.7	30.0	7.3
	HT/VHT40 STBC, M0 to M7	4	5	17.6	17.5	18.6	17.7	23.9	30.0	6.1
5240	Non HT20, 6 to 54 Mbps	1	5	17.2				17.2	30.0	12.8
	Non HT20, 6 to 54 Mbps	2	5	17.2	17.3			20.3	30.0	9.7
	Non HT20, 6 to 54 Mbps	3	5	17.2	17.3	18.6		22.5	30.0	7.5
	Non HT20, 6 to 54 Mbps	4	5	14.8	14.9	16.5	15.7	21.6	30.0	8.4
	Non HT20 Beam Forming, 6 to 54 Mbps	2	8	17.2	17.3			20.3	28.0	7.7
	Non HT20 Beam Forming, 6 to 54 Mbps	3	10	17.2	17.3	18.6		22.5	26.0	3.5
	Non HT20 Beam Forming, 6 to 54 Mbps	4	11	14.8	14.9	16.5	15.7	21.6	25.0	3.4
	HT/VHT20, M0 to M7	1	5	17.3				17.3	30.0	12.7
	HT/VHT20, M0 to M7	2	5	17.3	17.4			20.4	30.0	9.6
	HT/VHT20, M8 to M15	2	5	17.3	17.4			20.4	30.0	9.6
	HT/VHT20, M0 to M7	3	5	17.3	17.4	18.8		22.7	30.0	7.3
	HT/VHT20, M8 to M15	3	5	17.3	17.4	18.8		22.7	30.0	7.3
	HT/VHT20, M16 to M23	3	5	17.3	17.4	18.8		22.7	30.0	7.3
	HT/VHT20, M0 to M7	4	5	14.9	15.1	16.6	15.8	21.7	30.0	8.3
	HT/VHT20, M8 to M15	4	5	17.3	17.4	18.8	17.9	23.9	30.0	6.1
	HT/VHT20, M16 to M23	4	5	17.3	17.4	18.8	17.9	23.9	30.0	6.1
	HT/VHT20 Beam Forming, M0 to M7	2	8	17.3	17.4			20.4	28.0	7.6
	HT/VHT20 Beam Forming, M8 to M15	2	5	17.3	17.4			20.4	30.0	9.6
	HT/VHT20 Beam Forming, M0 to M7	3	10	17.3	17.4	18.8		22.7	26.0	3.3
	HT/VHT20 Beam Forming, M8 to M15	3	7	17.3	17.4	18.8		22.7	29.0	6.3
	HT/VHT20 Beam Forming, M16 to M23	3	5	17.3	17.4	18.8		22.7	30.0	7.3
	HT/VHT20 Beam Forming, M0 to M7	4	11	14.9	15.1	16.6	15.8	21.7	25.0	3.3
	HT/VHT20 Beam Forming, M8 to M15	4	8	17.3	17.4	18.8	17.9	23.9	28.0	4.1
	HT/VHT20 Beam Forming, M16 to M23	4	6	17.3	17.4	18.8	17.9	23.9	30.0	6.1
	HT/VHT20 STBC, M0 to M7	2	5	17.3	17.4			20.4	30.0	9.6
	HT/VHT20 STBC, M0 to M7	3	5	17.3	17.4	18.8		22.7	30.0	7.3
	HT/VHT20 STBC, M0 to M7	4	5	17.3	17.4	18.8	17.9	23.9	30.0	6.1

Frequency (MHz)	Mode	Tx Paths	Correlated Antenna Gain (dBi)	Tx 1 PSD (dBm/MHz)	Tx 2 PSD (dBm/MHz)	Tx 3 PSD (dBm/MHz)	Tx 4 PSD (dBm/MHz)	Total PSD (dBm/MHz)	Limit (dBm/MHz)	Margin (dB)
5180	Non HT20, 6 to 54 Mbps	1	5	8.6				8.6	17.0	8.4
	Non HT20, 6 to 54 Mbps	2	8	8.6	7.7			11.2	15.0	3.8
	Non HT20, 6 to 54 Mbps	3	10	8.6	7.7	7.4		12.7	13.0	0.3
	Non HT20, 6 to 54 Mbps	4	11	5.9	5.5	4.7	5.2	11.4	12.0	0.6
	Non HT20 Beam Forming, 6 to 54 Mbps	2	8	8.6	7.7			11.2	15.0	3.8
	Non HT20 Beam Forming, 6 to 54 Mbps	3	10	5.3	6.6	6.0		10.8	13.0	2.2
	Non HT20 Beam Forming, 6 to 54 Mbps	4	11	6.3	5.4	3.8	4.3	11.1	12.0	0.9
	HT/VHT20, M0 to M7	1	5	8.2				8.2	17.0	8.8
	HT/VHT20, M0 to M7	2	8	8.2	7.7			11.0	15.0	4.0
	HT/VHT20, M8 to M15	2	5	8.2	7.7			11.0	17.0	6.0
	HT/VHT20, M0 to M7	3	10	8.2	7.7	6.8		12.4	13.0	0.6
	HT/VHT20, M8 to M15	3	7	8.2	7.7	6.8		12.4	16.0	3.6
	HT/VHT20, M16 to M23	3	5	8.2	7.7	6.8		12.4	17.0	4.6
	HT/VHT20, M0 to M7	4	11	5.9	5.4	4.9	5.2	11.4	12.0	0.6
	HT/VHT20, M8 to M15	4	8	8.2	7.7	6.8	7.2	13.5	15.0	1.5
	HT/VHT20, M16 to M23	4	6	8.2	7.7	6.8	7.2	13.5	17.0	3.5
	HT/VHT20 Beam Forming, M0 to M7	2	8	8.2	7.7			11.0	15.0	4.0
	HT/VHT20 Beam Forming, M8 to M15	2	5	8.2	7.7			11.0	17.0	6.0
	HT/VHT20 Beam Forming, M0 to M7	3	10	5.9	5.4	4.9		10.2	13.0	2.8
	HT/VHT20 Beam Forming, M8 to M15	3	7	8.2	7.7	6.8		12.4	16.0	3.6
	HT/VHT20 Beam Forming, M16 to M23	3	5	8.2	7.7	6.8		12.4	17.0	4.6
	HT/VHT20 Beam Forming, M0 to M7	4	11	4.6	4.3	2.6	3.3	9.8	12.0	2.2
	HT/VHT20 Beam Forming, M8 to M15	4	8	7.1	6.4	6.2	6.5	12.6	15.0	2.4
	HT/VHT20 Beam Forming, M16 to M23	4	6	8.2	7.7	6.8	7.2	13.5	17.0	3.5
	HT/VHT20 STBC, M0 to M7	2	5	8.2	7.7			11.0	17.0	6.0
	HT/VHT20 STBC, M0 to M7	3	7	8.2	7.7	6.8		12.4	16.0	3.6
	HT/VHT20 STBC, M0 to M7	4	8	8.2	7.7	6.8	7.2	13.5	15.0	1.5
	5190	Non HT40, 6 to 54 Mbps	1	5	2.9				2.9	17.0
Non HT40, 6 to 54 Mbps		2	8	2.1	1.2			4.7	15.0	10.3
Non HT40, 6 to 54 Mbps		3	10	2.1	1.2	1.4		6.4	13.0	6.6
Non HT40, 6 to 54 Mbps		4	11	2.1	1.2	1.4	0.9	7.4	12.0	4.6
HT/VHT40, M0 to M7		1	5	5.1				5.1	17.0	11.9
HT/VHT40, M0 to M7		2	8	5.1	4.6			7.9	15.0	7.1
HT/VHT40, M8 to M15		2	5	5.1	4.6			7.9	17.0	9.1

	HT/VHT40, M0 to M7	3	10	3.9	3.5	2.9		8.2	13.0	4.8
	HT/VHT40, M8 to M15	3	7	3.9	3.5	2.9		8.2	16.0	7.8
	HT/VHT40, M16 to M23	3	5	3.9	3.5	2.9		8.2	17.0	8.8
	HT/VHT40, M0 to M7	4	11	3.9	3.5	2.9	3.0	9.4	12.0	2.6
	HT/VHT40, M8 to M15	4	8	3.9	3.5	2.9	3.0	9.4	15.0	5.6
	HT/VHT40, M16 to M23	4	6	3.9	3.5	2.9	3.0	9.4	17.0	7.6
	HT/VHT40 Beam Forming, M0 to M7	2	8	3.9	3.5			6.7	15.0	8.3
	HT/VHT40 Beam Forming, M8 to M15	2	5	5.1	4.6			7.9	17.0	9.1
	HT/VHT40 Beam Forming, M0 to M7	3	10	1.6	1.4	-0.2		5.8	13.0	7.2
	HT/VHT40 Beam Forming, M8 to M15	3	7	2.8	2.0	2.0		7.1	16.0	8.9
	HT/VHT40 Beam Forming, M16 to M23	3	5	3.9	3.5	2.9		8.2	17.0	8.8
	HT/VHT40 Beam Forming, M0 to M7	4	11	0.3	0.1	-0.2	-0.3	6.0	12.0	6.0
	HT/VHT40 Beam Forming, M8 to M15	4	8	2.3	2.4	1.2	0.6	7.7	15.0	7.3
	HT/VHT40 Beam Forming, M16 to M23	4	6	2.8	2.0	2.0	2.0	8.2	17.0	8.8
	HT/VHT40 STBC, M0 to M7	2	5	5.1	4.6			7.9	17.0	9.1
	HT/VHT40 STBC, M0 to M7	3	7	3.9	3.5	2.9		8.2	16.0	7.8
	HT/VHT40 STBC, M0 to M7	4	8	3.9	3.5	2.9	3.0	9.4	15.0	5.6
5210	Non HT80, 6 to 54 Mbps	1	5	-0.1				-0.1	17.0	17.1
	Non HT80, 6 to 54 Mbps	2	8	-1.3	-1.8			1.5	15.0	13.5
	Non HT80, 6 to 54 Mbps	3	10	-2.4	-3.0	-2.3		2.2	13.0	10.8
	Non HT80, 6 to 54 Mbps	4	11	-3.6	-4.1	-3.4	-4.5	2.1	12.0	9.9
	VHT80, M0 to M9 1ss	1	5	1.1				1.1	17.0	15.9
	VHT80, M0 to M9 1ss	2	8	1.1	0.5			3.8	15.0	11.2
	VHT80, M0 to M9 2ss	2	5	1.1	0.5			3.8	17.0	13.2
	VHT80, M0 to M9 1ss	3	10	-0.1	-0.6	-0.4		4.4	13.0	8.6
	VHT80, M0 to M9 2ss	3	7	-0.1	-0.6	-0.4		4.4	16.0	11.6
	VHT80, M0 to M9 3ss	3	5	-0.1	-0.6	-0.4		4.4	17.0	12.6
	VHT80, M0 to M9 1ss	4	11	-1.2	-1.7	-1.2	-2.1	4.5	12.0	7.5
	VHT80, M0 to M9 2ss	4	8	-1.2	-1.7	-1.2	-2.1	4.5	15.0	10.5
	VHT80, M0 to M9 3ss	4	6	-1.2	-1.7	-1.2	-2.1	4.5	17.0	12.5
	VHT80 Beam Forming, M0 to M9 1ss	2	8	-1.2	-1.7			1.6	15.0	13.4
	VHT80 Beam Forming, M0 to M9 2ss	2	5	1.1	0.5			3.8	17.0	13.2
	VHT80 Beam Forming, M0 to M9 1ss	3	10	-4.3	-5.0	-4.4		0.2	13.0	12.8
	VHT80 Beam Forming, M0 to M9 2ss	3	7	-1.4	-1.4	-2.5		3.0	16.0	13.0
	VHT80 Beam Forming, M0 to M9 3ss	3	5	-0.1	-0.6	-0.4		4.4	17.0	12.6
	VHT80 Beam Forming, M0 to M9 1ss	4	11	-6.9	-7.9	-7.8	-9.1	-1.8	12.0	13.8
	VHT80 Beam Forming, M0 to M9 2ss	4	8	-3.5	-3.7	-3.6	-4.0	2.3	15.0	12.7
	VHT80 Beam Forming, M0 to M9 3ss	4	6	-1.4	-1.4	-2.5	-3.0	4.0	17.0	13.0
	VHT80 STBC, M0 to M9 1ss	2	5	1.1	0.5			3.8	17.0	13.2
	VHT80 STBC, M0 to M9 1ss	3	5	-0.1	-0.6	-0.4		4.4	17.0	12.6
VHT80 STBC, M0 to M9 1ss	4	5	-1.2	-1.7	-1.2	-2.1	4.5	17.0	12.5	

5220	Non HT20, 6 to 54 Mbps	1	5	7.4				7.4	17.0	9.6
	Non HT20, 6 to 54 Mbps	2	8	7.4	7.5			10.5	15.0	4.5
	Non HT20, 6 to 54 Mbps	3	10	7.4	7.5	8.1		12.4	13.0	0.6
	Non HT20, 6 to 54 Mbps	4	11	4.9	5.1	5.9	5.0	11.3	12.0	0.7
	Non HT20 Beam Forming, 6 to 54 Mbps	2	8	7.4	7.5			10.5	15.0	4.5
	Non HT20 Beam Forming, 6 to 54 Mbps	3	10	7.4	7.5	8.1		12.4	13.0	0.6
	Non HT20 Beam Forming, 6 to 54 Mbps	4	11	4.9	5.1	5.9	5.0	11.3	12.0	0.7
	HT/VHT20, M0 to M7	1	5	7.2				7.2	17.0	9.8
	HT/VHT20, M0 to M7	2	8	7.2	7.4			10.3	15.0	4.7
	HT/VHT20, M8 to M15	2	5	7.2	7.4			10.3	17.0	6.7
	HT/VHT20, M0 to M7	3	10	7.2	7.4	8.0		12.3	13.0	0.7
	HT/VHT20, M8 to M15	3	7	7.2	7.4	8.0		12.3	16.0	3.7
	HT/VHT20, M16 to M23	3	5	7.2	7.4	8.0		12.3	17.0	4.7
	HT/VHT20, M0 to M7	4	11	5.0	5.0	5.7	5.0	11.2	12.0	0.8
	HT/VHT20, M8 to M15	4	8	7.2	7.4	8.0	7.0	13.4	15.0	1.6
	HT/VHT20, M16 to M23	4	6	7.2	7.4	8.0	7.0	13.4	17.0	3.6
	HT/VHT20 Beam Forming, M0 to M7	2	8	7.2	7.4			10.3	15.0	4.7
	HT/VHT20 Beam Forming, M8 to M15	2	5	7.2	7.4			10.3	17.0	6.7
	HT/VHT20 Beam Forming, M0 to M7	3	10	7.2	7.4	8.0		12.3	13.0	0.7
	HT/VHT20 Beam Forming, M8 to M15	3	7	7.2	7.4	8.0		12.3	16.0	3.7
	HT/VHT20 Beam Forming, M16 to M23	3	5	7.2	7.4	8.0		12.3	17.0	4.7
	HT/VHT20 Beam Forming, M0 to M7	4	11	5.0	5.0	5.7	5.0	11.2	12.0	0.8
	HT/VHT20 Beam Forming, M8 to M15	4	8	7.2	7.4	8.0	7.0	13.4	15.0	1.6
	HT/VHT20 Beam Forming, M16 to M23	4	6	7.2	7.4	8.0	7.0	13.4	17.0	3.6
HT/VHT20 STBC, M0 to M7	2	5	7.2	7.4			10.3	17.0	6.7	
HT/VHT20 STBC, M0 to M7	3	7	7.2	7.4	8.0		12.3	16.0	3.7	
HT/VHT20 STBC, M0 to M7	4	8	7.2	7.4	8.0	7.0	13.4	15.0	1.6	
5230	Non HT40, 6 to 54 Mbps	1	5	5.5				5.5	17.0	11.5
	Non HT40, 6 to 54 Mbps	2	8	5.5	5.9			8.7	15.0	6.3
	Non HT40, 6 to 54 Mbps	3	10	5.5	5.9	6.8		10.9	13.0	2.1
	Non HT40, 6 to 54 Mbps	4	11	4.4	4.5	5.6	4.5	10.8	12.0	1.2
	HT/VHT40, M0 to M7	1	5	4.1				4.1	17.0	12.9
	HT/VHT40, M0 to M7	2	8	4.1	3.8			7.0	15.0	8.0
	HT/VHT40, M8 to M15	2	5	4.1	3.8			7.0	17.0	10.0
	HT/VHT40, M0 to M7	3	10	4.1	3.8	4.8		9.0	13.0	4.0
	HT/VHT40, M8 to M15	3	7	4.1	3.8	4.8		9.0	16.0	7.0
	HT/VHT40, M16 to M23	3	5	4.1	3.8	4.8		9.0	17.0	8.0
	HT/VHT40, M0 to M7	4	11	4.1	3.8	4.8	3.8	10.2	12.0	1.8
	HT/VHT40, M8 to M15	4	8	4.1	3.8	4.8	3.8	10.2	15.0	4.8
	HT/VHT40, M16 to M23	4	6	4.1	3.8	4.8	3.8	10.2	17.0	6.8

	HT/VHT40 Beam Forming, M0 to M7	2	8	4.1	3.8			7.0	15.0	8.0
	HT/VHT40 Beam Forming, M8 to M15	2	5	4.1	3.8			7.0	17.0	10.0
	HT/VHT40 Beam Forming, M0 to M7	3	10	4.1	3.8	4.8		9.0	13.0	4.0
	HT/VHT40 Beam Forming, M8 to M15	3	7	4.1	3.8	4.8		9.0	16.0	7.0
	HT/VHT40 Beam Forming, M16 to M23	3	5	4.1	3.8	4.8		9.0	17.0	8.0
	HT/VHT40 Beam Forming, M0 to M7	4	11	4.1	3.8	4.8	3.8	10.2	12.0	1.8
	HT/VHT40 Beam Forming, M8 to M15	4	8	4.1	3.8	4.8	3.8	10.2	15.0	4.8
	HT/VHT40 Beam Forming, M16 to M23	4	6	4.1	3.8	4.8	3.8	10.2	17.0	6.8
	HT/VHT40 STBC, M0 to M7	2	5	4.1	3.8			7.0	17.0	10.0
	HT/VHT40 STBC, M0 to M7	3	7	4.1	3.8	4.8		9.0	16.0	7.0
	HT/VHT40 STBC, M0 to M7	4	8	4.1	3.8	4.8	3.8	10.2	15.0	4.8
5240	Non HT20, 6 to 54 Mbps	1	5	6.9				6.9	17.0	10.1
	Non HT20, 6 to 54 Mbps	2	8	6.9	6.9			9.9	15.0	5.1
	Non HT20, 6 to 54 Mbps	3	10	6.9	6.9	8.3		12.2	13.0	0.8
	Non HT20, 6 to 54 Mbps	4	11	4.3	4.2	5.9	5.3	11.0	12.0	1.0
	Non HT20 Beam Forming, 6 to 54 Mbps	2	8	6.9	6.9			9.9	15.0	5.1
	Non HT20 Beam Forming, 6 to 54 Mbps	3	10	6.9	6.9	8.3		12.2	13.0	0.8
	Non HT20 Beam Forming, 6 to 54 Mbps	4	11	4.3	4.2	5.9	5.3	11.0	12.0	1.0
	HT/VHT20, M0 to M7	1	5	6.5				6.5	17.0	10.5
	HT/VHT20, M0 to M7	2	8	6.5	6.7			9.6	15.0	5.4
	HT/VHT20, M8 to M15	2	5	6.5	6.7			9.6	17.0	7.4
	HT/VHT20, M0 to M7	3	10	6.5	6.7	8.1		11.9	13.0	1.1
	HT/VHT20, M8 to M15	3	7	6.5	6.7	8.1		11.9	16.0	4.1
	HT/VHT20, M16 to M23	3	5	6.5	6.7	8.1		11.9	17.0	5.1
	HT/VHT20, M0 to M7	4	11	4.1	4.1	5.7	5.3	10.9	12.0	1.1
	HT/VHT20, M8 to M15	4	8	6.5	6.7	8.1	7.0	13.1	15.0	1.9
	HT/VHT20, M16 to M23	4	6	6.5	6.7	8.1	7.0	13.1	17.0	3.9
	HT/VHT20 Beam Forming, M0 to M7	2	8	6.5	6.7			9.6	15.0	5.4
	HT/VHT20 Beam Forming, M8 to M15	2	5	6.5	6.7			9.6	17.0	7.4
	HT/VHT20 Beam Forming, M0 to M7	3	10	6.5	6.7	8.1		11.9	13.0	1.1
	HT/VHT20 Beam Forming, M8 to M15	3	7	6.5	6.7	8.1		11.9	16.0	4.1
	HT/VHT20 Beam Forming, M16 to M23	3	5	6.5	6.7	8.1		11.9	17.0	5.1
	HT/VHT20 Beam Forming, M0 to M7	4	11	4.1	4.1	5.7	5.3	10.9	12.0	1.1
	HT/VHT20 Beam Forming, M8 to M15	4	8	6.5	6.7	8.1	7.0	13.1	15.0	1.9
	HT/VHT20 Beam Forming, M16 to M23	4	6	6.5	6.7	8.1	7.0	13.1	17.0	3.9
	HT/VHT20 STBC, M0 to M7	2	5	6.5	6.7			9.6	17.0	7.4
	HT/VHT20 STBC, M0 to M7	3	7	6.5	6.7	8.1		11.9	16.0	4.1
	HT/VHT20 STBC, M0 to M7	4	8	6.5	6.7	8.1	7.0	13.1	15.0	1.9

Peak Output Power, 5230 MHz, HT/VHT40 Beam Forming, M0 to M7

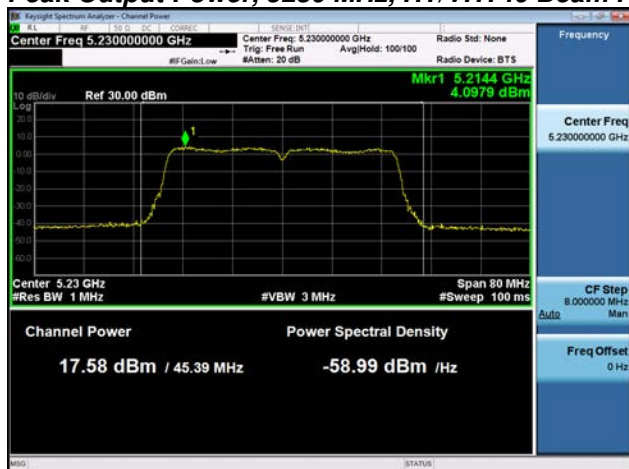

Antenna A

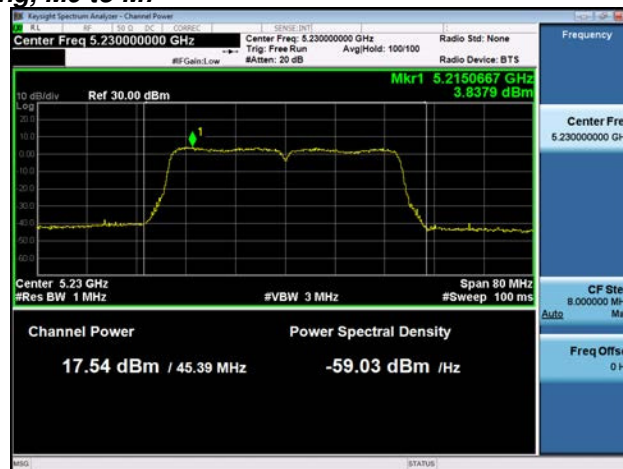

Antenna B

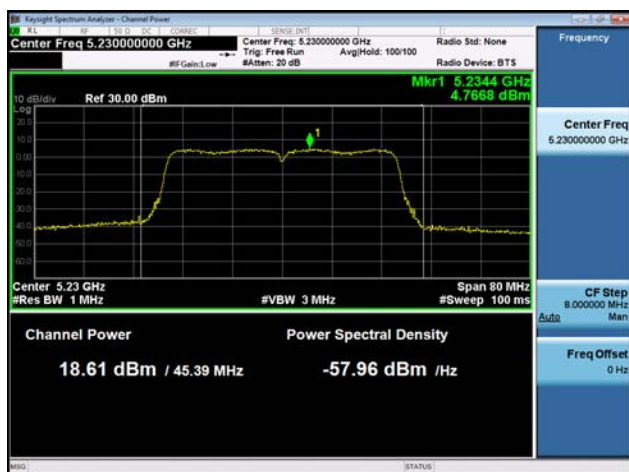

Antenna C

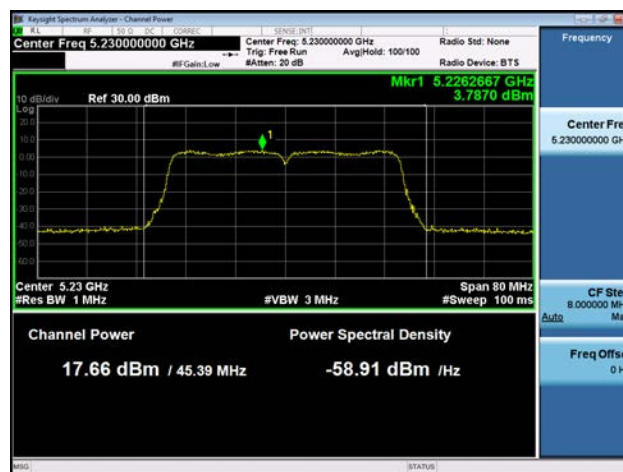

Antenna D

Power Spectral Density, 5180 MHz, Non HT20, 6 to 54 Mbps

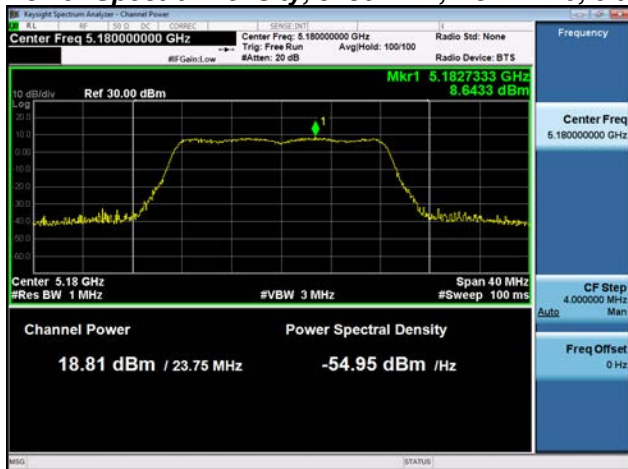

Antenna A

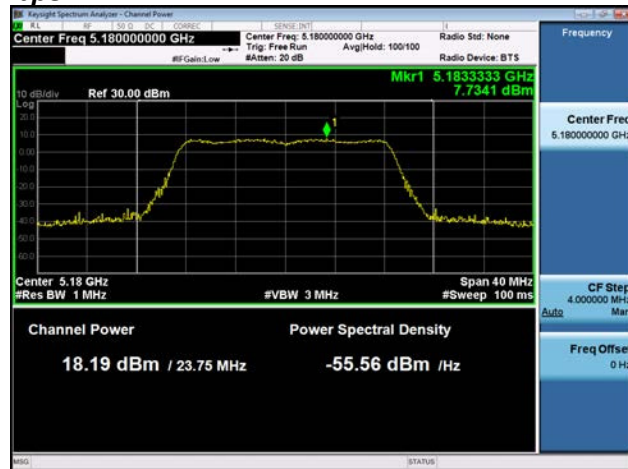

Antenna B

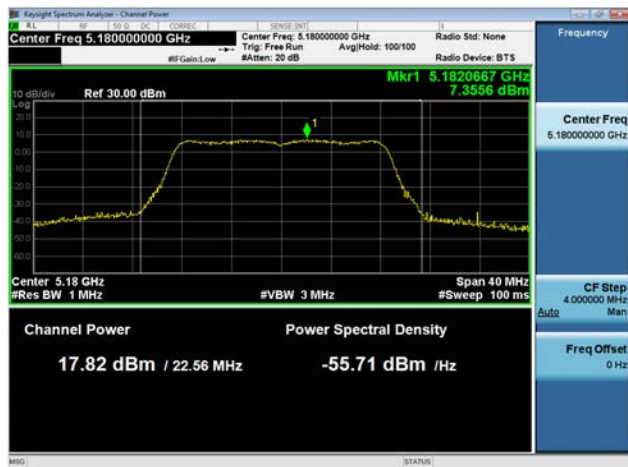

Antenna C

Antenna Gain : 6 dBi

Frequency (MHz)	Mode	Tx Paths	Correlated Antenna Gain (dBi)	Tx 1 Max Power (dBm)	Tx 2 Max Power (dBm)	Tx 3 Max Power (dBm)	Tx 4 Max Power (dBm)	Total Tx Channel Power (dBm)	Limit (dBm)	Margin (dB)
5180	Non HT20, 6 to 54 Mbps	1	6	15.7				15.7	30.0	14.3
	Non HT20, 6 to 54 Mbps	2	6	14.2	13.9			17.1	30.0	12.9
	Non HT20, 6 to 54 Mbps	3	6	13.3	12.9	12.0		17.5	30.0	12.5
	Non HT20, 6 to 54 Mbps	4	6	12.3	9.7	9.1	9.5	16.4	30.0	13.6
	Non HT20 Beam Forming, 6 to 54 Mbps	2	9	12.3	9.7			14.2	27.0	12.8
	Non HT20 Beam Forming, 6 to 54 Mbps	3	11	8.9	6.3	5.6		11.9	25.0	13.1
	Non HT20 Beam Forming, 6 to 54 Mbps	4	12	7.9	5.4	4.5	5.2	12.0	24.0	12.0
	HT/VHT20, M0 to M7	1	6	17.8				17.8	30.0	12.2
	HT/VHT20, M0 to M7	2	6	14.5	14.2			17.4	30.0	12.6
	HT/VHT20, M8 to M15	2	6	14.5	14.2			17.4	30.0	12.6
	HT/VHT20, M0 to M7	3	6	13.5	13.2	12.4		17.8	30.0	12.2
	HT/VHT20, M8 to M15	3	6	13.5	13.2	12.4		17.8	30.0	12.2
	HT/VHT20, M16 to M23	3	6	13.5	13.2	12.4		17.8	30.0	12.2
	HT/VHT20, M0 to M7	4	6	12.1	9.5	8.9	9.3	16.2	30.0	13.8
	HT/VHT20, M8 to M15	4	6	12.1	9.5	8.9	9.3	16.2	30.0	13.8
	HT/VHT20, M16 to M23	4	6	12.1	9.5	8.9	9.3	16.2	30.0	13.8
	HT/VHT20 Beam Forming, M0 to M7	2	9	12.1	9.5			14.0	27.0	13.0
	HT/VHT20 Beam Forming, M8 to M15	2	6	14.5	14.2			17.4	30.0	12.6
	HT/VHT20 Beam Forming, M0 to M7	3	11	8.9	6.3	5.6		11.9	25.0	13.1
	HT/VHT20 Beam Forming, M8 to M15	3	8	12.1	9.5	8.9		15.2	28.0	12.8
	HT/VHT20 Beam Forming, M16 to M23	3	6	13.5	13.2	12.4		17.8	30.0	12.2
	HT/VHT20 Beam Forming, M0 to M7	4	12	7.0	4.4	3.6	4.3	11.1	24.0	12.9
	HT/VHT20 Beam Forming, M8 to M15	4	9	10.0	7.6	7.0	7.3	14.2	27.0	12.8
	HT/VHT20 Beam Forming, M16 to M23	4	7	12.1	9.5	8.9	9.3	16.2	29.0	12.8
	HT/VHT20 STBC, M0 to M7	2	6	14.5	14.2			17.4	30.0	12.6
	HT/VHT20 STBC, M0 to M7	3	6	13.5	13.2	12.4		17.8	30.0	12.2
	HT/VHT20 STBC, M0 to M7	4	6	12.1	9.5	8.9	9.3	16.2	30.0	13.8
	5190	Non HT40, 6 to 54 Mbps	1	6	15.2				15.2	30.0
Non HT40, 6 to 54 Mbps		2	6	14.2	13.9			17.1	30.0	12.9
Non HT40, 6 to 54 Mbps		3	6	12.8	10.8	9.8		16.1	30.0	13.9
Non HT40, 6 to 54 Mbps		4	6	12.8	10.8	9.8	10.4	17.1	30.0	12.9
HT/VHT40, M0 to M7		1	6	17.6				17.6	30.0	12.4
HT/VHT40, M0 to M7		2	6	14.1	13.9			17.0	30.0	13.0



	HT/VHT40, M8 to M15	2	6	14.1	13.9			17.0	30.0	13.0
	HT/VHT40, M0 to M7	3	6	13.1	12.9	12.5		17.6	30.0	12.4
	HT/VHT40, M8 to M15	3	6	13.1	12.9	12.5		17.6	30.0	12.4
	HT/VHT40, M16 to M23	3	6	13.1	12.9	12.5		17.6	30.0	12.4
	HT/VHT40, M0 to M7	4	6	11.4	9.5	8.4	9.1	15.8	30.0	14.2
	HT/VHT40, M8 to M15	4	6	11.4	9.5	8.4	9.1	15.8	30.0	14.2
	HT/VHT40, M16 to M23	4	6	11.4	9.5	8.4	9.1	15.8	30.0	14.2
	HT/VHT40 Beam Forming, M0 to M7	2	9	11.4	9.5			13.6	27.0	13.4
	HT/VHT40 Beam Forming, M8 to M15	2	6	14.1	13.9			17.0	30.0	13.0
	HT/VHT40 Beam Forming, M0 to M7	3	11	9.4	7.4	6.2		12.6	25.0	12.4
	HT/VHT40 Beam Forming, M8 to M15	3	8	11.4	9.5	8.4		14.7	28.0	13.3
	HT/VHT40 Beam Forming, M16 to M23	3	6	13.1	12.9	12.5		17.6	30.0	12.4
	HT/VHT40 Beam Forming, M0 to M7	4	12	7.3	5.2	4.2	4.9	11.6	24.0	12.4
	HT/VHT40 Beam Forming, M8 to M15	4	9	10.4	8.5	7.4	8.0	14.7	27.0	12.3
	HT/VHT40 Beam Forming, M16 to M23	4	7	11.4	9.5	8.4	9.1	15.8	29.0	13.2
	HT/VHT40 STBC, M0 to M7	2	6	14.1	13.9			17.0	30.0	13.0
	HT/VHT40 STBC, M0 to M7	3	6	13.1	12.9	12.5		17.6	30.0	12.4
	HT/VHT40 STBC, M0 to M7	4	6	11.4	9.5	8.4	9.1	15.8	30.0	14.2
5210	Non HT80, 6 to 54 Mbps	1	6	16.3				16.3	30.0	13.7
	Non HT80, 6 to 54 Mbps	2	6	13.9	13.6			16.8	30.0	13.2
	Non HT80, 6 to 54 Mbps	3	6	12.7	12.6	13.2		17.6	30.0	12.4
	Non HT80, 6 to 54 Mbps	4	6	11.8	11.6	12.0	11.5	17.7	30.0	12.3
	VHT80, M0 to M9 1ss	1	6	18.0				18.0	30.0	12.0
	VHT80, M0 to M9 1ss	2	6	14.4	14.3			17.4	30.0	12.6
	VHT80, M0 to M9 2ss	2	6	14.4	14.3			17.4	30.0	12.6
	VHT80, M0 to M9 1ss	3	6	12.5	12.3	12.8		17.3	30.0	12.7
	VHT80, M0 to M9 2ss	3	6	12.5	12.3	12.8		17.3	30.0	12.7
	VHT80, M0 to M9 3ss	3	6	12.5	12.3	12.8		17.3	30.0	12.7
	VHT80, M0 to M9 1ss	4	6	11.4	9.9	9.3	9.5	16.1	30.0	13.9
	VHT80, M0 to M9 2ss	4	6	11.4	9.9	9.3	9.5	16.1	30.0	13.9
	VHT80, M0 to M9 3ss	4	6	11.4	9.9	9.3	9.5	16.1	30.0	13.9
	VHT80 Beam Forming, M0 to M9 1ss	2	9	11.4	9.9			13.7	27.0	13.3
	VHT80 Beam Forming, M0 to M9 2ss	2	6	14.4	14.3			17.4	30.0	12.6
	VHT80 Beam Forming, M0 to M9 1ss	3	11	8.1	6.8	6.3		11.9	25.0	13.1
	VHT80 Beam Forming, M0 to M9 2ss	3	8	11.4	9.9	9.3		15.1	28.0	12.9
	VHT80 Beam Forming, M0 to M9 3ss	3	6	12.5	12.3	12.8		17.3	30.0	12.7
	VHT80 Beam Forming, M0 to M9 1ss	4	12	7.1	5.8	5.3	5.4	12.0	24.0	12.0
	VHT80 Beam Forming, M0 to M9 2ss	4	9	9.3	8.0	7.3	7.5	14.1	27.0	12.9
VHT80 Beam Forming, M0 to M9 3ss	4	7	11.4	9.9	9.3	9.5	16.1	29.0	12.9	
VHT80 STBC, M0 to M9 1ss	2	6	14.4	14.3			17.4	30.0	12.6	
VHT80 STBC, M0 to M9 1ss	3	6	12.5	12.3	12.8		17.3	30.0	12.7	



	VHT80 STBC, M0 to M9 1ss	4	6	11.4	9.9	9.3	9.5	16.1	30.0	13.9
5220	Non HT20, 6 to 54 Mbps	1	6	17.8				17.8	30.0	12.2
	Non HT20, 6 to 54 Mbps	2	6	14.3	14.5			17.4	30.0	12.6
	Non HT20, 6 to 54 Mbps	3	6	12.3	12.6	13.2		17.5	30.0	12.5
	Non HT20, 6 to 54 Mbps	4	6	10.9	9.6	9.4	9.3	15.9	30.0	14.1
	Non HT20 Beam Forming, 6 to 54 Mbps	2	9	10.9	9.6			13.3	27.0	13.7
	Non HT20 Beam Forming, 6 to 54 Mbps	3	11	8.9	7.7	7.5		12.8	25.0	12.2
	Non HT20 Beam Forming, 6 to 54 Mbps	4	12	6.8	5.5	5.1	5.2	11.7	24.0	12.3
	HT/VHT20, M0 to M7	1	6	18.0				18.0	30.0	12.0
	HT/VHT20, M0 to M7	2	6	14.4	14.6			17.5	30.0	12.5
	HT/VHT20, M8 to M15	2	6	14.4	14.6			17.5	30.0	12.5
	HT/VHT20, M0 to M7	3	6	12.5	12.8	13.3		17.7	30.0	12.3
	HT/VHT20, M8 to M15	3	6	12.5	12.8	13.3		17.7	30.0	12.3
	HT/VHT20, M16 to M23	3	6	12.5	12.8	13.3		17.7	30.0	12.3
	HT/VHT20, M0 to M7	4	6	11.0	9.7	9.6	9.5	16.0	30.0	14.0
	HT/VHT20, M8 to M15	4	6	11.0	9.7	9.6	9.5	16.0	30.0	14.0
	HT/VHT20, M16 to M23	4	6	11.0	9.7	9.6	9.5	16.0	30.0	14.0
	HT/VHT20 Beam Forming, M0 to M7	2	9	11.0	9.7			13.4	27.0	13.6
	HT/VHT20 Beam Forming, M8 to M15	2	6	14.4	14.6			17.5	30.0	12.5
	HT/VHT20 Beam Forming, M0 to M7	3	11	9.0	7.8	7.6		12.9	25.0	12.1
	HT/VHT20 Beam Forming, M8 to M15	3	8	11.0	9.7	9.6		14.9	28.0	13.1
	HT/VHT20 Beam Forming, M16 to M23	3	6	12.5	12.8	13.3		17.7	30.0	12.3
	HT/VHT20 Beam Forming, M0 to M7	4	12	7.0	5.6	5.3	5.4	11.9	24.0	12.1
	HT/VHT20 Beam Forming, M8 to M15	4	9	9.0	7.8	7.6	7.5	14.0	27.0	13.0
	HT/VHT20 Beam Forming, M16 to M23	4	7	11.0	9.7	9.6	9.5	16.0	29.0	13.0
HT/VHT20 STBC, M0 to M7	2	6	14.4	14.6			17.5	30.0	12.5	
HT/VHT20 STBC, M0 to M7	3	6	12.5	12.8	13.3		17.7	30.0	12.3	
HT/VHT20 STBC, M0 to M7	4	6	11.0	9.7	9.6	9.5	16.0	30.0	14.0	
5230	Non HT40, 6 to 54 Mbps	1	6	17.6				17.6	30.0	12.4
	Non HT40, 6 to 54 Mbps	2	6	14.0	14.1			17.1	30.0	12.9
	Non HT40, 6 to 54 Mbps	3	6	12.3	11.6	11.1		16.5	30.0	13.5
	Non HT40, 6 to 54 Mbps	4	6	12.3	11.6	11.1	10.8	17.5	30.0	12.5
	HT/VHT40, M0 to M7	1	6	17.6				17.6	30.0	12.4
	HT/VHT40, M0 to M7	2	6	13.9	14.1			17.0	30.0	13.0
	HT/VHT40, M8 to M15	2	6	13.9	14.1			17.0	30.0	13.0
	HT/VHT40, M0 to M7	3	6	12.0	12.2	13.3		17.3	30.0	12.7
	HT/VHT40, M8 to M15	3	6	12.0	12.2	13.3		17.3	30.0	12.7
	HT/VHT40, M16 to M23	3	6	12.0	12.2	13.3		17.3	30.0	12.7
	HT/VHT40, M0 to M7	4	6	11.1	10.4	10.0	9.5	16.3	30.0	13.7
	HT/VHT40, M8 to M15	4	6	11.1	10.4	10.0	9.5	16.3	30.0	13.7



	HT/VHT40, M16 to M23	4	6	11.1	10.4	10.0	9.5	16.3	30.0	13.7
	HT/VHT40 Beam Forming, M0 to M7	2	9	11.1	10.4			13.8	27.0	13.2
	HT/VHT40 Beam Forming, M8 to M15	2	6	13.9	14.1			17.0	30.0	13.0
	HT/VHT40 Beam Forming, M0 to M7	3	11	7.8	7.1	6.6		12.0	25.0	13.0
	HT/VHT40 Beam Forming, M8 to M15	3	8	11.1	10.4	10.0		15.3	28.0	12.7
	HT/VHT40 Beam Forming, M16 to M23	3	6	12.0	12.2	13.3		17.3	30.0	12.7
	HT/VHT40 Beam Forming, M0 to M7	4	12	5.9	5.2	4.8	4.4	11.1	24.0	12.9
	HT/VHT40 Beam Forming, M8 to M15	4	9	9.1	8.4	7.7	7.5	14.2	27.0	12.8
	HT/VHT40 Beam Forming, M16 to M23	4	7	11.1	10.4	10.0	9.5	16.3	29.0	12.7
	HT/VHT40 STBC, M0 to M7	2	6	13.9	14.1			17.0	30.0	13.0
	HT/VHT40 STBC, M0 to M7	3	6	12.0	12.2	13.3		17.3	30.0	12.7
	HT/VHT40 STBC, M0 to M7	4	6	11.1	10.4	10.0	9.5	16.3	30.0	13.7
5240	Non HT20, 6 to 54 Mbps	1	6	17.2				17.2	30.0	12.8
	Non HT20, 6 to 54 Mbps	2	6	14.8	14.9			17.9	30.0	12.1
	Non HT20, 6 to 54 Mbps	3	6	11.7	12.0	13.2		17.1	30.0	12.9
	Non HT20, 6 to 54 Mbps	4	6	11.1	10.3	10.5	9.6	16.4	30.0	13.6
	Non HT20 Beam Forming, 6 to 54 Mbps	2	9	11.7	12.0			14.9	27.0	12.1
	Non HT20 Beam Forming, 6 to 54 Mbps	3	11	8.0	7.2	7.2		12.3	25.0	12.7
	Non HT20 Beam Forming, 6 to 54 Mbps	4	12	6.1	5.3	5.2	4.5	11.3	24.0	12.7
	HT/VHT20, M0 to M7	1	6	17.3				17.3	30.0	12.7
	HT/VHT20, M0 to M7	2	6	14.8	15.0			17.9	30.0	12.1
	HT/VHT20, M8 to M15	2	6	14.8	15.0			17.9	30.0	12.1
	HT/VHT20, M0 to M7	3	6	11.8	12.0	13.3		17.2	30.0	12.8
	HT/VHT20, M8 to M15	3	6	11.8	12.0	13.3		17.2	30.0	12.8
	HT/VHT20, M16 to M23	3	6	11.8	12.0	13.3		17.2	30.0	12.8
	HT/VHT20, M0 to M7	4	6	11.3	10.5	10.6	9.8	16.6	30.0	13.4
	HT/VHT20, M8 to M15	4	6	11.3	10.5	10.6	9.8	16.6	30.0	13.4
	HT/VHT20, M16 to M23	4	6	11.3	10.5	10.6	9.8	16.6	30.0	13.4
	HT/VHT20 Beam Forming, M0 to M7	2	9	11.8	12.0			14.9	27.0	12.1
	HT/VHT20 Beam Forming, M8 to M15	2	6	14.8	15.0			17.9	30.0	12.1
	HT/VHT20 Beam Forming, M0 to M7	3	11	8.1	7.3	7.3		12.4	25.0	12.6
	HT/VHT20 Beam Forming, M8 to M15	3	8	11.3	10.5	10.6		15.6	28.0	12.4
	HT/VHT20 Beam Forming, M16 to M23	3	6	11.8	12.0	13.3		17.2	30.0	12.8
	HT/VHT20 Beam Forming, M0 to M7	4	12	6.2	5.5	5.3	4.6	11.5	24.0	12.5
	HT/VHT20 Beam Forming, M8 to M15	4	9	9.2	8.6	8.7	7.7	14.6	27.0	12.4
	HT/VHT20 Beam Forming, M16 to M23	4	7	11.3	10.5	10.6	9.8	16.6	29.0	12.4
	HT/VHT20 STBC, M0 to M7	2	6	14.8	15.0			17.9	30.0	12.1
	HT/VHT20 STBC, M0 to M7	3	6	11.8	12.0	13.3		17.2	30.0	12.8
	HT/VHT20 STBC, M0 to M7	4	6	11.3	10.5	10.6	9.8	16.6	30.0	13.4

Frequency (MHz)	Mode	Tx Paths	Correlated Antenna Gain (dBi)	Tx 1 PSD (dBm/MHz)	Tx 2 PSD (dBm/MHz)	Tx 3 PSD (dBm/MHz)	Tx 4 PSD (dBm/MHz)	Total PSD (dBm/MHz)	Limit (dBm/MHz)	Margin (dB)
5180	Non HT20, 6 to 54 Mbps	1	6	5.3				5.3	17.0	11.7
	Non HT20, 6 to 54 Mbps	2	9	3.4	3.4			6.4	14.0	7.6
	Non HT20, 6 to 54 Mbps	3	11	2.7	2.4	1.5		7.0	12.0	5.0
	Non HT20, 6 to 54 Mbps	4	12	1.8	-0.8	-1.0	-1.1	5.9	11.0	5.1
	Non HT20 Beam Forming, 6 to 54 Mbps	2	9	1.8	-0.8			3.7	14.0	10.3
	Non HT20 Beam Forming, 6 to 54 Mbps	3	11	-1.4	-4.1	-5.0		1.6	12.0	10.4
	Non HT20 Beam Forming, 6 to 54 Mbps	4	12	-2.7	-5.4	-6.1	-5.3	1.4	11.0	9.6
	HT/VHT20, M0 to M7	1	6	7.1				7.1	17.0	9.9
	HT/VHT20, M0 to M7	2	9	3.8	3.5			6.7	14.0	7.3
	HT/VHT20, M8 to M15	2	6	3.8	3.5			6.7	17.0	10.3
	HT/VHT20, M0 to M7	3	11	2.9	2.8	1.8		7.3	12.0	4.7
	HT/VHT20, M8 to M15	3	8	2.9	2.8	1.8		7.3	15.0	7.7
	HT/VHT20, M16 to M23	3	6	2.9	2.8	1.8		7.3	17.0	9.7
	HT/VHT20, M0 to M7	4	12	1.2	-1.2	-1.9	-1.3	5.4	11.0	5.6
	HT/VHT20, M8 to M15	4	9	1.2	-1.2	-1.9	-1.3	5.4	14.0	8.6
	HT/VHT20, M16 to M23	4	7	1.2	-1.2	-1.9	-1.3	5.4	16.0	10.6
	HT/VHT20 Beam Forming, M0 to M7	2	9	1.2	-1.2			3.2	14.0	10.8
	HT/VHT20 Beam Forming, M8 to M15	2	6	3.8	3.5			6.7	17.0	10.3
	HT/VHT20 Beam Forming, M0 to M7	3	11	-1.8	-4.4	-5.3		1.2	12.0	10.8
	HT/VHT20 Beam Forming, M8 to M15	3	8	1.2	-1.2	-1.9		4.3	15.0	10.7
	HT/VHT20 Beam Forming, M16 to M23	3	6	2.9	2.8	1.8		7.3	17.0	9.7
	HT/VHT20 Beam Forming, M0 to M7	4	12	-3.9	-6.4	-7.1	-6.5	0.2	11.0	10.8
	HT/VHT20 Beam Forming, M8 to M15	4	9	-1.0	-2.9	-3.5	-3.6	3.4	14.0	10.6
	HT/VHT20 Beam Forming, M16 to M23	4	7	1.2	-1.2	-1.9	-1.3	5.4	16.0	10.6
	HT/VHT20 STBC, M0 to M7	2	6	3.8	3.5			6.7	17.0	10.3
	HT/VHT20 STBC, M0 to M7	3	8	2.9	2.8	1.8		7.3	15.0	7.7
	HT/VHT20 STBC, M0 to M7	4	9	1.2	-1.2	-1.9	-1.3	5.4	14.0	8.6
	5190	Non HT40, 6 to 54 Mbps	1	6	2.1				2.1	17.0
Non HT40, 6 to 54 Mbps		2	9	1.0	0.7			3.9	14.0	10.1
Non HT40, 6 to 54 Mbps		3	11	-0.8	-2.7	-3.8		2.5	12.0	9.5
Non HT40, 6 to 54 Mbps		4	12	-0.8	-2.7	-3.8	-3.2	3.5	11.0	7.5
HT/VHT40, M0 to M7		1	6	3.9				3.9	17.0	13.1
HT/VHT40, M0 to M7		2	9	0.3	0.1			3.2	14.0	10.8
HT/VHT40, M8 to M15		2	6	0.3	0.1			3.2	17.0	13.8

	HT/VHT40, M0 to M7	3	11	-0.3	-0.5	-1.1		4.2	12.0	7.8
	HT/VHT40, M8 to M15	3	8	-0.3	-0.5	-1.1		4.2	15.0	10.8
	HT/VHT40, M16 to M23	3	6	-0.3	-0.5	-1.1		4.2	17.0	12.8
	HT/VHT40, M0 to M7	4	12	-2.4	-4.3	-5.4	-4.9	1.9	11.0	9.1
	HT/VHT40, M8 to M15	4	9	-2.4	-4.3	-5.4	-4.9	1.9	14.0	12.1
	HT/VHT40, M16 to M23	4	7	-2.4	-4.3	-5.4	-4.9	1.9	16.0	14.1
	HT/VHT40 Beam Forming, M0 to M7	2	9	-2.4	-4.3			-0.2	14.0	14.2
	HT/VHT40 Beam Forming, M8 to M15	2	6	0.3	0.1			3.2	17.0	13.8
	HT/VHT40 Beam Forming, M0 to M7	3	11	-4.5	-6.4	-7.5		-1.2	12.0	13.2
	HT/VHT40 Beam Forming, M8 to M15	3	8	-2.4	-4.3	-5.4		0.9	15.0	14.1
	HT/VHT40 Beam Forming, M16 to M23	3	6	-0.3	-0.5	-1.1		4.2	17.0	12.8
	HT/VHT40 Beam Forming, M0 to M7	4	12	-6.6	-8.7	-9.5	-8.8	-2.2	11.0	13.2
	HT/VHT40 Beam Forming, M8 to M15	4	9	-3.1	-5.4	-6.5	-5.9	1.0	14.0	13.0
	HT/VHT40 Beam Forming, M16 to M23	4	7	-2.4	-4.3	-5.4	-4.9	1.9	16.0	14.1
	HT/VHT40 STBC, M0 to M7	2	6	0.3	0.1			3.2	17.0	13.8
	HT/VHT40 STBC, M0 to M7	3	8	-0.3	-0.5	-1.1		4.2	15.0	10.8
	HT/VHT40 STBC, M0 to M7	4	9	-2.4	-4.3	-5.4	-4.9	1.9	14.0	12.1
5210	Non HT80, 6 to 54 Mbps	1	6	-0.1				-0.1	17.0	17.1
	Non HT80, 6 to 54 Mbps	2	9	-2.4	-3.0			0.3	14.0	13.7
	Non HT80, 6 to 54 Mbps	3	11	-3.6	-4.1	-3.4		1.1	12.0	10.9
	Non HT80, 6 to 54 Mbps	4	12	-4.6	-5.0	-4.5	-5.6	1.1	11.0	9.9
	VHT80, M0 to M9 1ss	1	6	1.1				1.1	17.0	15.9
	VHT80, M0 to M9 1ss	2	9	-2.3	-2.8			0.5	14.0	13.5
	VHT80, M0 to M9 2ss	2	6	-2.3	-2.8			0.5	17.0	16.5
	VHT80, M0 to M9 1ss	3	11	-4.3	-5.0	-4.4		0.2	12.0	11.8
	VHT80, M0 to M9 2ss	3	8	-4.3	-5.0	-4.4		0.2	15.0	14.8
	VHT80, M0 to M9 3ss	3	6	-4.3	-5.0	-4.4		0.2	17.0	16.8
	VHT80, M0 to M9 1ss	4	12	-6.0	-6.4	-7.1	-7.9	-0.8	11.0	11.8
	VHT80, M0 to M9 2ss	4	9	-6.0	-6.4	-7.1	-7.9	-0.8	14.0	14.8
	VHT80, M0 to M9 3ss	4	7	-6.0	-6.4	-7.1	-7.9	-0.8	16.0	16.8
	VHT80 Beam Forming, M0 to M9 1ss	2	9	-6.0	-6.4			-3.2	14.0	17.2
	VHT80 Beam Forming, M0 to M9 2ss	2	6	-2.3	-2.8			0.5	17.0	16.5
	VHT80 Beam Forming, M0 to M9 1ss	3	11	-9.2	-9.8	-10.2		-4.9	12.0	16.9
	VHT80 Beam Forming, M0 to M9 2ss	3	8	-6.0	-6.4	-7.1		-1.7	15.0	16.7
	VHT80 Beam Forming, M0 to M9 3ss	3	6	-4.3	-5.0	-4.4		0.2	17.0	16.8
	VHT80 Beam Forming, M0 to M9 1ss	4	12	-10.2	-11.3	-10.8	-11.9	-5.0	11.0	16.0
	VHT80 Beam Forming, M0 to M9 2ss	4	9	-7.9	-8.4	-8.9	-9.9	-2.7	14.0	16.7
	VHT80 Beam Forming, M0 to M9 3ss	4	7	-6.0	-6.4	-7.1	-7.9	-0.8	16.0	16.8
	VHT80 STBC, M0 to M9 1ss	2	6	-2.3	-2.8			0.5	17.0	16.5
	VHT80 STBC, M0 to M9 1ss	3	6	-4.3	-5.0	-4.4		0.2	17.0	16.8
VHT80 STBC, M0 to M9 1ss	4	6	-6.0	-6.4	-7.1	-7.9	-0.8	17.0	17.8	

5220	Non HT20, 6 to 54 Mbps	1	6	7.4				7.4	17.0	9.6
	Non HT20, 6 to 54 Mbps	2	9	3.9	3.8			6.9	14.0	7.1
	Non HT20, 6 to 54 Mbps	3	11	1.7	2.3	2.6		7.0	12.0	5.0
	Non HT20, 6 to 54 Mbps	4	12	0.4	-0.8	-1.1	-1.3	5.4	11.0	5.6
	Non HT20 Beam Forming, 6 to 54 Mbps	2	9	0.4	-0.8			2.9	14.0	11.1
	Non HT20 Beam Forming, 6 to 54 Mbps	3	11	-1.6	-2.9	-2.8		2.4	12.0	9.6
	Non HT20 Beam Forming, 6 to 54 Mbps	4	12	-3.7	-5.0	-5.4	-5.4	1.2	11.0	9.8
	HT/VHT20, M0 to M7	1	6	7.2				7.2	17.0	9.8
	HT/VHT20, M0 to M7	2	9	3.5	3.8			6.7	14.0	7.3
	HT/VHT20, M8 to M15	2	6	3.5	3.8			6.7	17.0	10.3
	HT/VHT20, M0 to M7	3	11	1.8	1.9	2.7		6.9	12.0	5.1
	HT/VHT20, M8 to M15	3	8	1.8	1.9	2.7		6.9	15.0	8.1
	HT/VHT20, M16 to M23	3	6	1.8	1.9	2.7		6.9	17.0	10.1
	HT/VHT20, M0 to M7	4	12	0.3	-1.1	-0.5	-1.1	5.5	11.0	5.5
	HT/VHT20, M8 to M15	4	9	0.3	-1.1	-0.5	-1.1	5.5	14.0	8.5
	HT/VHT20, M16 to M23	4	7	0.3	-1.1	-0.5	-1.1	5.5	16.0	10.5
	HT/VHT20 Beam Forming, M0 to M7	2	9	0.3	-1.1			2.7	14.0	11.3
	HT/VHT20 Beam Forming, M8 to M15	2	6	3.5	3.8			6.7	17.0	10.3
	HT/VHT20 Beam Forming, M0 to M7	3	11	-1.7	-2.9	-3.1		2.2	12.0	9.8
	HT/VHT20 Beam Forming, M8 to M15	3	8	0.3	-1.1	-0.5		4.4	15.0	10.6
	HT/VHT20 Beam Forming, M16 to M23	3	6	1.8	1.9	2.7		6.9	17.0	10.1
	HT/VHT20 Beam Forming, M0 to M7	4	12	-4.0	-5.3	-5.3	-5.2	1.1	11.0	9.9
	HT/VHT20 Beam Forming, M8 to M15	4	9	-1.7	-2.9	-3.1	-3.4	3.3	14.0	10.7
	HT/VHT20 Beam Forming, M16 to M23	4	7	0.3	-1.1	-0.5	-1.1	5.5	16.0	10.5
HT/VHT20 STBC, M0 to M7	2	6	3.5	3.8			6.7	17.0	10.3	
HT/VHT20 STBC, M0 to M7	3	8	1.8	1.9	2.7		6.9	15.0	8.1	
HT/VHT20 STBC, M0 to M7	4	9	0.3	-1.1	-0.5	-1.1	5.5	14.0	8.5	
5230	Non HT40, 6 to 54 Mbps	1	6	4.4				4.4	17.0	12.6
	Non HT40, 6 to 54 Mbps	2	9	0.6	0.8			3.7	14.0	10.3
	Non HT40, 6 to 54 Mbps	3	11	-0.8	-1.2	-1.4		3.6	12.0	8.4
	Non HT40, 6 to 54 Mbps	4	12	-0.8	-1.2	-1.4	-2.7	4.6	11.0	6.4
	HT/VHT40, M0 to M7	1	6	4.1				4.1	17.0	12.9
	HT/VHT40, M0 to M7	2	9	0.1	0.5			3.3	14.0	10.7
	HT/VHT40, M8 to M15	2	6	0.1	0.5			3.3	17.0	13.7
	HT/VHT40, M0 to M7	3	11	-1.6	-1.6	-0.5		3.6	12.0	8.4
	HT/VHT40, M8 to M15	3	8	-1.6	-1.6	-0.5		3.6	15.0	11.4
	HT/VHT40, M16 to M23	3	6	-1.6	-1.6	-0.5		3.6	17.0	13.4
	HT/VHT40, M0 to M7	4	12	-2.8	-3.0	-3.4	-4.2	2.7	11.0	8.3
	HT/VHT40, M8 to M15	4	9	-2.8	-3.0	-3.4	-4.2	2.7	14.0	11.3
	HT/VHT40, M16 to M23	4	7	-2.8	-3.0	-3.4	-4.2	2.7	16.0	13.3

	HT/VHT40 Beam Forming, M0 to M7	2	9	-2.8	-3.0			0.1	14.0	13.9
	HT/VHT40 Beam Forming, M8 to M15	2	6	0.1	0.5			3.3	17.0	13.7
	HT/VHT40 Beam Forming, M0 to M7	3	11	-5.6	-6.1	-6.8		-1.4	12.0	13.4
	HT/VHT40 Beam Forming, M8 to M15	3	8	-2.8	-3.0	-3.4		1.7	15.0	13.3
	HT/VHT40 Beam Forming, M16 to M23	3	6	-1.6	-1.6	-0.5		3.6	17.0	13.4
	HT/VHT40 Beam Forming, M0 to M7	4	12	-7.8	-8.1	-8.7	-9.5	-2.5	11.0	13.5
	HT/VHT40 Beam Forming, M8 to M15	4	9	-4.7	-5.1	-5.8	-5.8	0.7	14.0	13.3
	HT/VHT40 Beam Forming, M16 to M23	4	7	-2.8	-3.0	-3.4	-4.2	2.7	16.0	13.3
	HT/VHT40 STBC, M0 to M7	2	6	0.1	0.5			3.3	17.0	13.7
	HT/VHT40 STBC, M0 to M7	3	8	-1.6	-1.6	-0.5		3.6	15.0	11.4
	HT/VHT40 STBC, M0 to M7	4	9	-2.8	-3.0	-3.4	-4.2	2.7	14.0	11.3
5240	Non HT20, 6 to 54 Mbps	1	6	6.9				6.9	17.0	10.1
	Non HT20, 6 to 54 Mbps	2	9	4.3	4.2			7.3	14.0	6.7
	Non HT20, 6 to 54 Mbps	3	11	1.1	1.6	3.0		6.7	12.0	5.3
	Non HT20, 6 to 54 Mbps	4	12	0.6	-0.1	0.4	-0.8	6.1	11.0	4.9
	Non HT20 Beam Forming, 6 to 54 Mbps	2	9	1.1	1.6			4.4	14.0	9.6
	Non HT20 Beam Forming, 6 to 54 Mbps	3	11	-2.7	-3.4	-3.3		1.6	12.0	10.4
	Non HT20 Beam Forming, 6 to 54 Mbps	4	12	-4.4	-5.1	-5.5	-6.1	0.8	11.0	10.2
	HT/VHT20, M0 to M7	1	6	6.5				6.5	17.0	10.5
	HT/VHT20, M0 to M7	2	9	3.9	4.3			7.1	14.0	6.9
	HT/VHT20, M8 to M15	2	6	3.9	4.3			7.1	17.0	9.9
	HT/VHT20, M0 to M7	3	11	1.3	1.2	2.4		6.4	12.0	5.6
	HT/VHT20, M8 to M15	3	8	1.3	1.2	2.4		6.4	15.0	8.6
	HT/VHT20, M16 to M23	3	6	1.3	1.2	2.4		6.4	17.0	10.6
	HT/VHT20, M0 to M7	4	12	0.3	-0.2	-0.2	-0.5	5.9	11.0	5.1
	HT/VHT20, M8 to M15	4	9	0.3	-0.2	-0.2	-0.5	5.9	14.0	8.1
	HT/VHT20, M16 to M23	4	7	0.3	-0.2	-0.2	-0.5	5.9	16.0	10.1
	HT/VHT20 Beam Forming, M0 to M7	2	9	1.3	1.2			4.3	14.0	9.7
	HT/VHT20 Beam Forming, M8 to M15	2	6	3.9	4.3			7.1	17.0	9.9
	HT/VHT20 Beam Forming, M0 to M7	3	11	-2.4	-3.3	-3.6		1.7	12.0	10.3
	HT/VHT20 Beam Forming, M8 to M15	3	8	0.3	-0.2	-0.2		4.7	15.0	10.3
	HT/VHT20 Beam Forming, M16 to M23	3	6	1.3	1.2	2.4		6.4	17.0	10.6
	HT/VHT20 Beam Forming, M0 to M7	4	12	-4.1	-5.3	-5.2	-5.8	1.0	11.0	10.0
	HT/VHT20 Beam Forming, M8 to M15	4	9	-1.7	-2.1	-1.4	-3.1	4.0	14.0	10.0
	HT/VHT20 Beam Forming, M16 to M23	4	7	0.3	-0.2	-0.2	-0.5	5.9	16.0	10.1
	HT/VHT20 STBC, M0 to M7	2	6	3.9	4.3			7.1	17.0	9.9
	HT/VHT20 STBC, M0 to M7	3	8	1.3	1.2	2.4		6.4	15.0	8.6
	HT/VHT20 STBC, M0 to M7	4	9	0.3	-0.2	-0.2	-0.5	5.9	14.0	8.1

15.407 (i) The maximum e.i.r.p. at any elevation angle above 30 degrees as measured from the horizon must not exceed 125 mW (21 dBm).

Frequency (MHz)	Mode	Tx Paths	Correlated Antenna Gain (dBi)	Tx 1 Max Power (dBm)	Tx 2 Max Power (dBm)	Tx 3 Max Power (dBm)	Tx 4 Max Power (dBm)	Total Radiated Channel Power (dBm)	Limit (dBm)	Margin (dB)
5180	Non HT20, 6 to 54 Mbps	1	3	15.7				18.7	21.0	2.3
	Non HT20, 6 to 54 Mbps	2	3	14.2	13.9			20.1	21.0	0.9
	Non HT20, 6 to 54 Mbps	3	3	13.3	12.9	12.0		20.5	21.0	0.5
	Non HT20, 6 to 54 Mbps	4	3	12.3	9.7	9.1	9.5	19.4	21.0	1.6
	Non HT20 Beam Forming, 6 to 54 Mbps	2	6	12.3	9.7			20.2	21.0	0.8
	Non HT20 Beam Forming, 6 to 54 Mbps	3	8	8.9	6.3	5.6		19.9	21.0	1.1
	Non HT20 Beam Forming, 6 to 54 Mbps	4	9	7.9	5.4	4.5	5.2	21.0	21.0	0.0
	HT/VHT20, M0 to M7	1	3	17.8				20.8	21.0	0.2
	HT/VHT20, M0 to M7	2	3	14.5	14.2			20.4	21.0	0.6
	HT/VHT20, M8 to M15	2	3	14.5	14.2			20.4	21.0	0.6
	HT/VHT20, M0 to M7	3	3	13.5	13.2	12.4		20.8	21.0	0.2
	HT/VHT20, M8 to M15	3	3	13.5	13.2	12.4		20.8	21.0	0.2
	HT/VHT20, M16 to M23	3	3	13.5	13.2	12.4		20.8	21.0	0.2
	HT/VHT20, M0 to M7	4	3	12.1	9.5	8.9	9.3	19.2	21.0	1.8
	HT/VHT20, M8 to M15	4	3	12.1	9.5	8.9	9.3	19.2	21.0	1.8
	HT/VHT20, M16 to M23	4	3	12.1	9.5	8.9	9.3	19.2	21.0	1.8
	HT/VHT20 Beam Forming, M0 to M7	2	6	12.1	9.5			20.0	21.0	1.0
	HT/VHT20 Beam Forming, M8 to M15	2	3	14.5	14.2			20.4	21.0	0.6
	HT/VHT20 Beam Forming, M0 to M7	3	8	8.9	6.3	5.6		19.9	21.0	1.1
	HT/VHT20 Beam Forming, M8 to M15	3	5	12.1	9.5	8.9		20.2	21.0	0.8
	HT/VHT20 Beam Forming, M16 to M23	3	3	13.5	13.2	12.4		20.8	21.0	0.2
	HT/VHT20 Beam Forming, M0 to M7	4	9	7.0	4.4	3.6	4.3	20.1	21.0	0.9
	HT/VHT20 Beam Forming, M8 to M15	4	6	10.0	7.6	7.0	7.3	20.2	21.0	0.8
	HT/VHT20 Beam Forming, M16 to M23	4	4	12.1	9.5	8.9	9.3	20.2	21.0	0.8
	HT/VHT20 STBC, M0 to M7	2	3	14.5	14.2			20.4	21.0	0.6
	HT/VHT20 STBC, M0 to M7	3	3	13.5	13.2	12.4		20.8	21.0	0.2
HT/VHT20 STBC, M0 to M7	4	3	12.1	9.5	8.9	9.3	19.2	21.0	1.8	
5190	Non HT40, 6 to 54 Mbps	1	3	15.2				18.2	21.0	2.8
	Non HT40, 6 to 54 Mbps	2	3	14.2	13.9			20.1	21.0	0.9
	Non HT40, 6 to 54 Mbps	3	3	12.8	10.8	9.8		19.1	21.0	1.9
	Non HT40, 6 to 54 Mbps	4	3	12.8	10.8	9.8	10.4	20.1	21.0	0.9
	HT/VHT40, M0 to M7	1	3	17.6				20.6	21.0	0.4

	HT/VHT40, M0 to M7	2	3	14.1	13.9			20.0	21.0	1.0
	HT/VHT40, M8 to M15	2	3	14.1	13.9			20.0	21.0	1.0
	HT/VHT40, M0 to M7	3	3	13.1	12.9	12.5		20.6	21.0	0.4
	HT/VHT40, M8 to M15	3	3	13.1	12.9	12.5		20.6	21.0	0.4
	HT/VHT40, M16 to M23	3	3	13.1	12.9	12.5		20.6	21.0	0.4
	HT/VHT40, M0 to M7	4	3	11.4	9.5	8.4	9.1	18.8	21.0	2.2
	HT/VHT40, M8 to M15	4	3	11.4	9.5	8.4	9.1	18.8	21.0	2.2
	HT/VHT40, M16 to M23	4	3	11.4	9.5	8.4	9.1	18.8	21.0	2.2
	HT/VHT40 Beam Forming, M0 to M7	2	6	11.4	9.5			19.6	21.0	1.4
	HT/VHT40 Beam Forming, M8 to M15	2	3	14.1	13.9			20.0	21.0	1.0
	HT/VHT40 Beam Forming, M0 to M7	3	8	9.4	7.4	6.2		20.6	21.0	0.4
	HT/VHT40 Beam Forming, M8 to M15	3	5	11.4	9.5	8.4		19.7	21.0	1.3
	HT/VHT40 Beam Forming, M16 to M23	3	3	13.1	12.9	12.5		20.6	21.0	0.4
	HT/VHT40 Beam Forming, M0 to M7	4	9	7.3	5.2	4.2	4.9	20.6	21.0	0.4
	HT/VHT40 Beam Forming, M8 to M15	4	6	10.4	8.5	7.4	8.0	20.7	21.0	0.3
	HT/VHT40 Beam Forming, M16 to M23	4	4	11.4	9.5	8.4	9.1	19.8	21.0	1.2
	HT/VHT40 STBC, M0 to M7	2	3	14.1	13.9			20.0	21.0	1.0
	HT/VHT40 STBC, M0 to M7	3	3	13.1	12.9	12.5		20.6	21.0	0.4
	HT/VHT40 STBC, M0 to M7	4	3	11.4	9.5	8.4	9.1	18.8	21.0	2.2
5210	Non HT80, 6 to 54 Mbps	1	3	16.3				19.3	21.0	1.7
	Non HT80, 6 to 54 Mbps	2	3	13.9	13.6			19.8	21.0	1.2
	Non HT80, 6 to 54 Mbps	3	3	12.7	12.6	13.2		20.6	21.0	0.4
	Non HT80, 6 to 54 Mbps	4	3	11.8	11.6	12.0	11.5	20.7	21.0	0.3
	VHT80, M0 to M9 1ss	1	3	18.0				21.0	21.0	0.0
	VHT80, M0 to M9 1ss	2	3	14.4	14.3			20.4	21.0	0.6
	VHT80, M0 to M9 2ss	2	3	14.4	14.3			20.4	21.0	0.6
	VHT80, M0 to M9 1ss	3	3	12.5	12.3	12.8		20.3	21.0	0.7
	VHT80, M0 to M9 2ss	3	3	12.5	12.3	12.8		20.3	21.0	0.7
	VHT80, M0 to M9 3ss	3	3	12.5	12.3	12.8		20.3	21.0	0.7
	VHT80, M0 to M9 1ss	4	3	11.4	9.9	9.3	9.5	19.1	21.0	1.9
	VHT80, M0 to M9 2ss	4	3	11.4	9.9	9.3	9.5	19.1	21.0	1.9
	VHT80, M0 to M9 3ss	4	3	11.4	9.9	9.3	9.5	19.1	21.0	1.9
	VHT80 Beam Forming, M0 to M9 1ss	2	6	11.4	9.9			19.7	21.0	1.3
	VHT80 Beam Forming, M0 to M9 2ss	2	3	14.4	14.3			20.4	21.0	0.6
	VHT80 Beam Forming, M0 to M9 1ss	3	8	8.1	6.8	6.3		19.9	21.0	1.1
	VHT80 Beam Forming, M0 to M9 2ss	3	5	11.4	9.9	9.3		20.1	21.0	0.9
	VHT80 Beam Forming, M0 to M9 3ss	3	3	12.5	12.3	12.8		20.3	21.0	0.7
	VHT80 Beam Forming, M0 to M9 1ss	4	9	7.1	5.8	5.3	5.4	21.0	21.0	0.0
	VHT80 Beam Forming, M0 to M9 2ss	4	6	9.3	8.0	7.3	7.5	20.1	21.0	0.9
VHT80 Beam Forming, M0 to M9 3ss	4	4	11.4	9.9	9.3	9.5	20.1	21.0	0.9	
VHT80 STBC, M0 to M9 1ss	2	3	14.4	14.3			20.4	21.0	0.6	

	VHT80 STBC, M0 to M9 1ss	3	3	12.5	12.3	12.8		20.3	21.0	0.7
	VHT80 STBC, M0 to M9 1ss	4	3	11.4	9.9	9.3	9.5	19.1	21.0	1.9
5250	Non HT160, 6 to 54 Mbps	1	3	11.7				14.7	21.0	6.3
	Non HT160, 6 to 54 Mbps	2	3	10.7	10.2			16.5	21.0	4.5
	Non HT160, 6 to 54 Mbps	3	3	10.6	8.0	7.7		16.7	21.0	4.3
	Non HT160, 6 to 54 Mbps	4	3	9.6	7.1	6.6	6.9	16.8	21.0	4.2
	VHT160, M0 to M9 1ss	1	3	15.4				18.4	21.0	2.6
	VHT160, M0 to M9 1ss	2	3	14.2	13.7			20.0	21.0	1.0
	VHT160, M0 to M9 2ss	2	3	14.2	13.7			20.0	21.0	1.0
	VHT160, M0 to M9 1ss	3	3	13.2	12.8	13.2		20.8	21.0	0.2
	VHT160, M0 to M9 2ss	3	3	13.2	12.8	13.2		20.8	21.0	0.2
	VHT160, M0 to M9 3ss	3	3	13.2	12.8	13.2		20.8	21.0	0.2
	VHT160, M0 to M9 1ss	4	3	12.2	9.6	9.3	9.4	19.3	21.0	1.7
	VHT160, M0 to M9 2ss	4	3	12.2	9.6	9.3	9.4	19.3	21.0	1.7
	VHT160, M0 to M9 3ss	4	3	12.2	9.6	9.3	9.4	19.3	21.0	1.7
	VHT160 Beam Forming, M0 to M9 1ss	2	6	12.2	9.6			20.1	21.0	0.9
	VHT160 Beam Forming, M0 to M9 2ss	2	3	14.2	13.7			20.0	21.0	1.0
	VHT160 Beam Forming, M0 to M9 1ss	3	8	8.7	6.3	6.1		20.0	21.0	1.0
	VHT160 Beam Forming, M0 to M9 2ss	3	5	12.2	9.6	9.3		20.3	21.0	0.7
	VHT160 Beam Forming, M0 to M9 3ss	3	3	13.2	12.8	13.2		20.8	21.0	0.2
	VHT160 Beam Forming, M0 to M9 1ss	4	9	6.8	4.3	4.3	4.3	20.1	21.0	0.9
	VHT160 Beam Forming, M0 to M9 2ss	4	6	10.2	7.6	7.1	7.4	20.3	21.0	0.7
	VHT160 Beam Forming, M0 to M9 3ss	4	4	12.2	9.6	9.3	9.4	20.3	21.0	0.7
VHT160 STBC, M0 to M9 1ss	2	3	14.2	13.7			20.0	21.0	1.0	
VHT160 STBC, M0 to M9 1ss	3	3	13.2	12.8	13.2		20.8	21.0	0.2	
VHT160 STBC, M0 to M9 1ss	4	3	12.2	9.6	9.3	9.4	19.3	21.0	1.7	
5220	Non HT20, 6 to 54 Mbps	1	3	17.8				20.8	21.0	0.2
	Non HT20, 6 to 54 Mbps	2	3	14.3	14.5			20.4	21.0	0.6
	Non HT20, 6 to 54 Mbps	3	3	12.3	12.6	13.2		20.5	21.0	0.5
	Non HT20, 6 to 54 Mbps	4	3	10.9	9.6	9.4	9.3	18.9	21.0	2.1
	Non HT20 Beam Forming, 6 to 54 Mbps	2	6	10.9	9.6			19.3	21.0	1.7
	Non HT20 Beam Forming, 6 to 54 Mbps	3	8	8.9	7.7	7.5		20.8	21.0	0.2
	Non HT20 Beam Forming, 6 to 54 Mbps	4	9	6.8	5.5	5.1	5.2	20.7	21.0	0.3
	HT/VHT20, M0 to M7	1	3	18.0				21.0	21.0	0.0
	HT/VHT20, M0 to M7	2	3	14.4	14.6			20.5	21.0	0.5
	HT/VHT20, M8 to M15	2	3	14.4	14.6			20.5	21.0	0.5
	HT/VHT20, M0 to M7	3	3	12.5	12.8	13.3		20.7	21.0	0.3
	HT/VHT20, M8 to M15	3	3	12.5	12.8	13.3		20.7	21.0	0.3
	HT/VHT20, M16 to M23	3	3	12.5	12.8	13.3		20.7	21.0	0.3
	HT/VHT20, M0 to M7	4	3	11.0	9.7	9.6	9.5	19.0	21.0	2.0

	HT/VHT20, M8 to M15	4	3	11.0	9.7	9.6	9.5	19.0	21.0	2.0
	HT/VHT20, M16 to M23	4	3	11.0	9.7	9.6	9.5	19.0	21.0	2.0
	HT/VHT20 Beam Forming, M0 to M7	2	6	11.0	9.7			19.4	21.0	1.6
	HT/VHT20 Beam Forming, M8 to M15	2	3	14.4	14.6			20.5	21.0	0.5
	HT/VHT20 Beam Forming, M0 to M7	3	8	9.0	7.8	7.6		20.9	21.0	0.1
	HT/VHT20 Beam Forming, M8 to M15	3	5	11.0	9.7	9.6		19.9	21.0	1.1
	HT/VHT20 Beam Forming, M16 to M23	3	3	12.5	12.8	13.3		20.7	21.0	0.3
	HT/VHT20 Beam Forming, M0 to M7	4	9	7.0	5.6	5.3	5.4	20.9	21.0	0.1
	HT/VHT20 Beam Forming, M8 to M15	4	6	9.0	7.8	7.6	7.5	20.0	21.0	1.0
	HT/VHT20 Beam Forming, M16 to M23	4	4	11.0	9.7	9.6	9.5	20.0	21.0	1.0
	HT/VHT20 STBC, M0 to M7	2	3	14.4	14.6			20.5	21.0	0.5
	HT/VHT20 STBC, M0 to M7	3	3	12.5	12.8	13.3		20.7	21.0	0.3
	HT/VHT20 STBC, M0 to M7	4	3	11.0	9.7	9.6	9.5	19.0	21.0	2.0
5230	Non HT40, 6 to 54 Mbps	1	3	17.6				20.6	21.0	0.4
	Non HT40, 6 to 54 Mbps	2	3	14.0	14.1			20.1	21.0	0.9
	Non HT40, 6 to 54 Mbps	3	3	12.3	11.6	11.1		19.5	21.0	1.5
	Non HT40, 6 to 54 Mbps	4	3	12.3	11.6	11.1	10.8	20.5	21.0	0.5
	HT/VHT40, M0 to M7	1	3	17.6				20.6	21.0	0.4
	HT/VHT40, M0 to M7	2	3	13.9	14.1			20.0	21.0	1.0
	HT/VHT40, M8 to M15	2	3	13.9	14.1			20.0	21.0	1.0
	HT/VHT40, M0 to M7	3	3	12.0	12.2	13.3		20.3	21.0	0.7
	HT/VHT40, M8 to M15	3	3	12.0	12.2	13.3		20.3	21.0	0.7
	HT/VHT40, M16 to M23	3	3	12.0	12.2	13.3		20.3	21.0	0.7
	HT/VHT40, M0 to M7	4	3	11.1	10.4	10.0	9.5	19.3	21.0	1.7
	HT/VHT40, M8 to M15	4	3	11.1	10.4	10.0	9.5	19.3	21.0	1.7
	HT/VHT40, M16 to M23	4	3	11.1	10.4	10.0	9.5	19.3	21.0	1.7
	HT/VHT40 Beam Forming, M0 to M7	2	6	11.1	10.4			19.8	21.0	1.2
	HT/VHT40 Beam Forming, M8 to M15	2	3	13.9	14.1			20.0	21.0	1.0
	HT/VHT40 Beam Forming, M0 to M7	3	8	7.8	7.1	6.6		20.0	21.0	1.0
	HT/VHT40 Beam Forming, M8 to M15	3	5	11.1	10.4	10.0		20.3	21.0	0.7
	HT/VHT40 Beam Forming, M16 to M23	3	3	12.0	12.2	13.3		20.3	21.0	0.7
	HT/VHT40 Beam Forming, M0 to M7	4	9	5.9	5.2	4.8	4.4	20.1	21.0	0.9
	HT/VHT40 Beam Forming, M8 to M15	4	6	9.1	8.4	7.7	7.5	20.2	21.0	0.8
	HT/VHT40 Beam Forming, M16 to M23	4	4	11.1	10.4	10.0	9.5	20.3	21.0	0.7
HT/VHT40 STBC, M0 to M7	2	3	13.9	14.1			20.0	21.0	1.0	
HT/VHT40 STBC, M0 to M7	3	3	12.0	12.2	13.3		20.3	21.0	0.7	
HT/VHT40 STBC, M0 to M7	4	3	11.1	10.4	10.0	9.5	19.3	21.0	1.7	

5240	Non HT20, 6 to 54 Mbps	1	3	17.2				20.2	21.0	0.8
	Non HT20, 6 to 54 Mbps	2	3	14.8	14.9			20.9	21.0	0.1
	Non HT20, 6 to 54 Mbps	3	3	11.7	12.0	13.2		20.1	21.0	0.9
	Non HT20, 6 to 54 Mbps	4	3	11.1	10.3	10.5	9.6	19.4	21.0	1.6
	Non HT20 Beam Forming, 6 to 54 Mbps	2	6	11.7	12.0			20.9	21.0	0.1
	Non HT20 Beam Forming, 6 to 54 Mbps	3	8	8.0	7.2	7.2		20.3	21.0	0.7
	Non HT20 Beam Forming, 6 to 54 Mbps	4	9	6.1	5.3	5.2	4.5	20.3	21.0	0.7
	HT/VHT20, M0 to M7	1	3	17.3				20.3	21.0	0.7
	HT/VHT20, M0 to M7	2	3	14.8	15.0			20.9	21.0	0.1
	HT/VHT20, M8 to M15	2	3	14.8	15.0			20.9	21.0	0.1
	HT/VHT20, M0 to M7	3	3	11.8	12.0	13.3		20.2	21.0	0.8
	HT/VHT20, M8 to M15	3	3	11.8	12.0	13.3		20.2	21.0	0.8
	HT/VHT20, M16 to M23	3	3	11.8	12.0	13.3		20.2	21.0	0.8
	HT/VHT20, M0 to M7	4	3	11.3	10.5	10.6	9.8	19.6	21.0	1.4
	HT/VHT20, M8 to M15	4	3	11.3	10.5	10.6	9.8	19.6	21.0	1.4
	HT/VHT20, M16 to M23	4	3	11.3	10.5	10.6	9.8	19.6	21.0	1.4
	HT/VHT20 Beam Forming, M0 to M7	2	6	11.8	12.0			20.9	21.0	0.1
	HT/VHT20 Beam Forming, M8 to M15	2	3	14.8	15.0			20.9	21.0	0.1
	HT/VHT20 Beam Forming, M0 to M7	3	8	8.1	7.3	7.3		20.4	21.0	0.6
	HT/VHT20 Beam Forming, M8 to M15	3	5	11.3	10.5	10.6		20.6	21.0	0.4
	HT/VHT20 Beam Forming, M16 to M23	3	3	11.8	12.0	13.3		20.2	21.0	0.8
	HT/VHT20 Beam Forming, M0 to M7	4	9	6.2	5.5	5.3	4.6	20.5	21.0	0.5
	HT/VHT20 Beam Forming, M8 to M15	4	6	9.2	8.6	8.7	7.7	20.6	21.0	0.4
	HT/VHT20 Beam Forming, M16 to M23	4	4	11.3	10.5	10.6	9.8	20.6	21.0	0.4
	HT/VHT20 STBC, M0 to M7	2	3	14.8	15.0			20.9	21.0	0.1
	HT/VHT20 STBC, M0 to M7	3	3	11.8	12.0	13.3		20.2	21.0	0.8
	HT/VHT20 STBC, M0 to M7	4	3	11.3	10.5	10.6	9.8	19.6	21.0	1.4

Peak Output Power, 5210 MHz, VHT80, M0 to M9 1ss

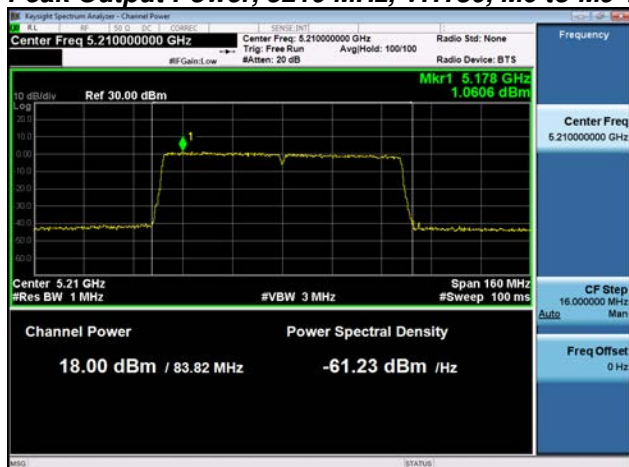

Antenna A

Power Spectral Density, 5180 MHz, HT/VHT20, M0 to M7

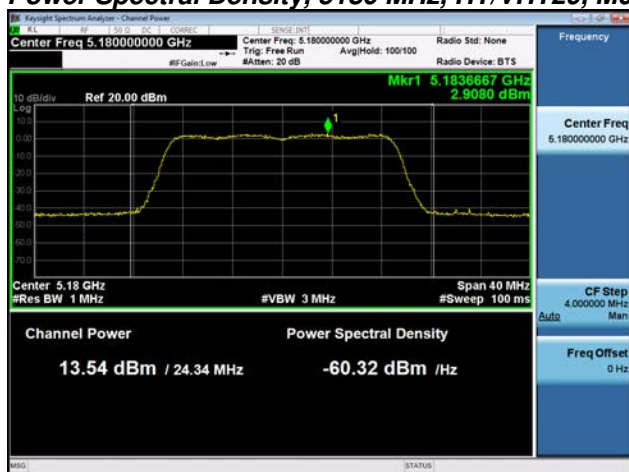

Antenna A

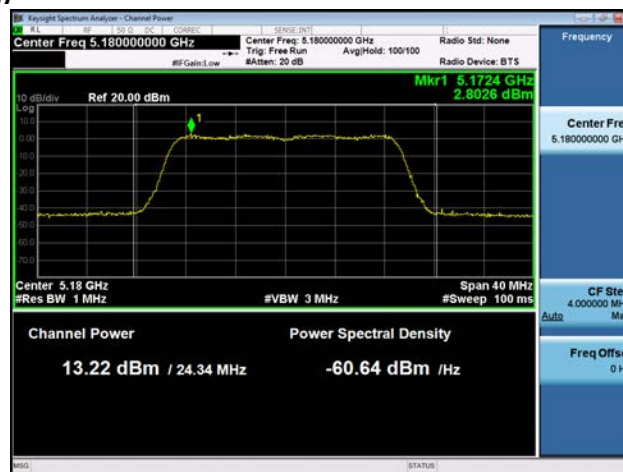

Antenna B

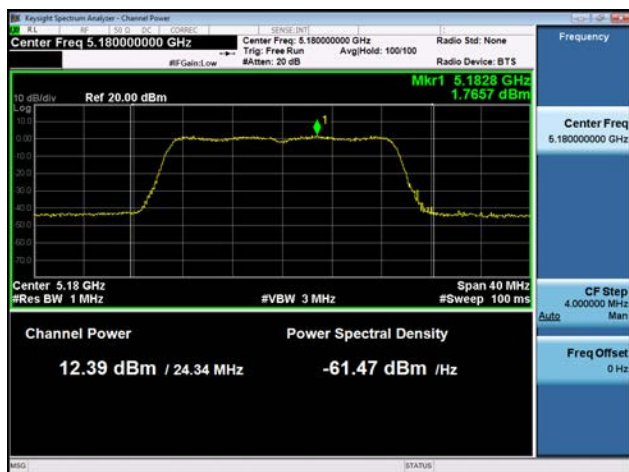

Antenna C

Antenna Gain : 8 dBi

Frequency (MHz)	Mode	Tx Paths	Correlated Antenna Gain (dBi)	Tx 1 Max Power (dBm)	Tx 2 Max Power (dBm)	Tx 3 Max Power (dBm)	Tx 4 Max Power (dBm)	Total Tx Channel Power (dBm)	Limit (dBm)	Margin (dB)
5180	Non HT20, 6 to 54 Mbps	1	8	18.8				18.8	28.0	9.2
	Non HT20, 6 to 54 Mbps	2	8	18.8	18.2			21.5	28.0	6.5
	Non HT20, 6 to 54 Mbps	3	8	15.2	14.8	13.0		19.2	28.0	8.8
	Non HT20, 6 to 54 Mbps	4	8	13.3	12.9	12.0	12.6	18.7	28.0	9.3
	Non HT20 Beam Forming, 6 to 54 Mbps	2	11	18.8	18.2			21.5	25.0	3.5
	Non HT20 Beam Forming, 6 to 54 Mbps	3	13	15.2	14.8	13.0		19.2	23.0	3.8
	Non HT20 Beam Forming, 6 to 54 Mbps	4	14	13.3	12.9	12.0	12.6	18.7	22.0	3.3
	HT/VHT20, M0 to M7	1	8	19.0				19.0	28.0	9.0
	HT/VHT20, M0 to M7	2	8	19.0	18.4			21.7	28.0	6.3
	HT/VHT20, M8 to M15	2	8	19.0	18.4			21.7	28.0	6.3
	HT/VHT20, M0 to M7	3	8	16.6	16.2	14.7		20.7	28.0	7.3
	HT/VHT20, M8 to M15	3	8	19.0	18.4	17.8		23.2	28.0	4.8
	HT/VHT20, M16 to M23	3	8	19.0	18.4	17.8		23.2	28.0	4.8
	HT/VHT20, M0 to M7	4	8	13.5	13.2	12.4	12.9	19.0	28.0	9.0
	HT/VHT20, M8 to M15	4	8	16.7	16.2	15.6	16.1	22.2	28.0	5.8
	HT/VHT20, M16 to M23	4	8	17.8	17.4	16.7	17.1	23.3	28.0	4.7
	HT/VHT20 Beam Forming, M0 to M7	2	11	19.0	18.4			21.7	25.0	3.3
	HT/VHT20 Beam Forming, M8 to M15	2	8	19.0	18.4			21.7	28.0	6.3
	HT/VHT20 Beam Forming, M0 to M7	3	13	15.5	15.1	13.3		19.5	23.0	3.5
	HT/VHT20 Beam Forming, M8 to M15	3	10	16.7	16.2	15.6		21.0	26.0	5.0
	HT/VHT20 Beam Forming, M16 to M23	3	8	19.0	18.4	17.8		23.2	28.0	4.8
	HT/VHT20 Beam Forming, M0 to M7	4	14	12.1	9.5	8.9	9.3	16.2	22.0	5.8
	HT/VHT20 Beam Forming, M8 to M15	4	11	15.5	15.1	13.3	13.9	20.6	25.0	4.4
	HT/VHT20 Beam Forming, M16 to M23	4	9	16.7	16.2	15.6	16.1	22.2	27.0	4.8
	HT/VHT20 STBC, M0 to M7	2	8	19.0	18.4			21.7	28.0	6.3
	HT/VHT20 STBC, M0 to M7	3	8	19.0	18.4	17.8		23.2	28.0	4.8
	HT/VHT20 STBC, M0 to M7	4	8	16.7	16.2	15.6	16.1	22.2	28.0	5.8
	5190	Non HT40, 6 to 54 Mbps	1	8	15.2				15.2	28.0
Non HT40, 6 to 54 Mbps		2	8	15.2	14.8			18.0	28.0	10.0
Non HT40, 6 to 54 Mbps		3	8	14.2	13.9	13.5		18.6	28.0	9.4
Non HT40, 6 to 54 Mbps		4	8	14.2	13.9	13.5	13.5	19.8	28.0	8.2
HT/VHT40, M0 to M7		1	8	18.8				18.8	28.0	9.2
HT/VHT40, M0 to M7		2	8	17.6	17.2			20.4	28.0	7.6

	HT/VHT40, M8 to M15	2	8	17.6	17.2			20.4	28.0	7.6
	HT/VHT40, M0 to M7	3	8	16.4	16.0	15.8		20.8	28.0	7.2
	HT/VHT40, M8 to M15	3	8	16.4	16.0	15.8		20.8	28.0	7.2
	HT/VHT40, M16 to M23	3	8	16.4	16.0	15.8		20.8	28.0	7.2
	HT/VHT40, M0 to M7	4	8	16.3	15.9	14.7	14.5	21.4	28.0	6.6
	HT/VHT40, M8 to M15	4	8	16.3	15.9	14.7	14.5	21.4	28.0	6.6
	HT/VHT40, M16 to M23	4	8	16.3	15.9	14.7	14.5	21.4	28.0	6.6
	HT/VHT40 Beam Forming, M0 to M7	2	11	16.4	16.0			19.2	25.0	5.8
	HT/VHT40 Beam Forming, M8 to M15	2	8	17.6	17.2			20.4	28.0	7.6
	HT/VHT40 Beam Forming, M0 to M7	3	13	13.1	12.9	12.5		17.6	23.0	5.4
	HT/VHT40 Beam Forming, M8 to M15	3	10	15.1	14.9	13.4		19.3	26.0	6.7
	HT/VHT40 Beam Forming, M16 to M23	3	8	16.4	16.0	15.8		20.8	28.0	7.2
	HT/VHT40 Beam Forming, M0 to M7	4	14	9.4	7.4	6.2	7.0	13.7	22.0	8.3
	HT/VHT40 Beam Forming, M8 to M15	4	11	14.1	13.9	13.5	13.5	19.8	25.0	5.2
	HT/VHT40 Beam Forming, M16 to M23	4	9	15.1	14.9	13.4	14.5	20.5	27.0	6.5
	HT/VHT40 STBC, M0 to M7	2	8	17.6	17.2			20.4	28.0	7.6
	HT/VHT40 STBC, M0 to M7	3	8	16.4	16.0	15.8		20.8	28.0	7.2
	HT/VHT40 STBC, M0 to M7	4	8	16.3	15.9	14.7	14.5	21.4	28.0	6.6
5210	Non HT80, 6 to 54 Mbps	1	8	15.2				15.2	28.0	12.8
	Non HT80, 6 to 54 Mbps	2	8	13.9	13.6			16.8	28.0	11.2
	Non HT80, 6 to 54 Mbps	3	8	11.8	11.6	12.0		16.6	28.0	11.4
	Non HT80, 6 to 54 Mbps	4	8	11.8	11.6	12.0	11.5	17.7	28.0	10.3
	VHT80, M0 to M9 1ss	1	8	18.0				18.0	28.0	10.0
	VHT80, M0 to M9 1ss	2	8	15.7	15.4			18.6	28.0	9.4
	VHT80, M0 to M9 2ss	2	8	15.7	15.4			18.6	28.0	9.4
	VHT80, M0 to M9 1ss	3	8	14.4	14.3	13.7		18.9	28.0	9.1
	VHT80, M0 to M9 2ss	3	8	14.4	14.3	13.7		18.9	28.0	9.1
	VHT80, M0 to M9 3ss	3	8	14.4	14.3	13.7		18.9	28.0	9.1
	VHT80, M0 to M9 1ss	4	8	13.4	13.3	13.8	13.3	19.5	28.0	8.5
	VHT80, M0 to M9 2ss	4	8	13.4	13.3	13.8	13.3	19.5	28.0	8.5
	VHT80, M0 to M9 3ss	4	8	13.4	13.3	13.8	13.3	19.5	28.0	8.5
	VHT80 Beam Forming, M0 to M9 1ss	2	11	14.4	14.3			17.4	25.0	7.6
	VHT80 Beam Forming, M0 to M9 2ss	2	8	15.7	15.4			18.6	28.0	9.4
	VHT80 Beam Forming, M0 to M9 1ss	3	13	9.3	8.0	7.3		13.1	23.0	9.9
	VHT80 Beam Forming, M0 to M9 2ss	3	10	12.5	12.3	12.8		17.3	26.0	8.7
	VHT80 Beam Forming, M0 to M9 3ss	3	8	14.4	14.3	13.7		18.9	28.0	9.1
	VHT80 Beam Forming, M0 to M9 1ss	4	14	8.1	6.8	6.3	6.3	13.0	22.0	9.0
	VHT80 Beam Forming, M0 to M9 2ss	4	11	10.3	8.9	8.4	8.4	15.1	25.0	9.9
VHT80 Beam Forming, M0 to M9 3ss	4	9	12.5	12.3	12.8	12.2	18.5	27.0	8.5	
VHT80 STBC, M0 to M9 1ss	2	8	15.7	15.4			18.6	28.0	9.4	
VHT80 STBC, M0 to M9 1ss	3	8	14.4	14.3	13.7		18.9	28.0	9.1	

	VHT80 STBC, M0 to M9 1ss	4	8	13.4	13.3	13.8	13.3	19.5	28.0	8.5
5220	Non HT20, 6 to 54 Mbps	1	8	17.8				17.8	28.0	10.2
	Non HT20, 6 to 54 Mbps	2	8	17.8	17.9			20.9	28.0	7.1
	Non HT20, 6 to 54 Mbps	3	8	15.4	15.6	15.5		20.3	28.0	7.7
	Non HT20, 6 to 54 Mbps	4	8	12.3	12.6	13.2	12.5	18.7	28.0	9.3
	Non HT20 Beam Forming, 6 to 54 Mbps	2	11	17.8	17.9			20.9	25.0	4.1
	Non HT20 Beam Forming, 6 to 54 Mbps	3	13	15.4	15.6	15.5		20.3	23.0	2.7
	Non HT20 Beam Forming, 6 to 54 Mbps	4	14	12.3	12.6	13.2	12.5	18.7	22.0	3.3
	HT/VHT20, M0 to M7	1	8	18.0				18.0	28.0	10.0
	HT/VHT20, M0 to M7	2	8	18.0	18.0			21.0	28.0	7.0
	HT/VHT20, M8 to M15	2	8	18.0	18.0			21.0	28.0	7.0
	HT/VHT20, M0 to M7	3	8	15.5	15.7	15.6		20.4	28.0	7.6
	HT/VHT20, M8 to M15	3	8	18.0	18.0	18.8		23.1	28.0	4.9
	HT/VHT20, M16 to M23	3	8	18.0	18.0	18.8		23.1	28.0	4.9
	HT/VHT20, M0 to M7	4	8	12.5	12.8	13.3	12.7	18.9	28.0	9.1
	HT/VHT20, M8 to M15	4	8	15.6	15.8	16.7	15.8	22.0	28.0	6.0
	HT/VHT20, M16 to M23	4	8	18.0	18.0	18.8	17.9	24.2	28.0	3.8
	HT/VHT20 Beam Forming, M0 to M7	2	11	18.0	18.0			21.0	25.0	4.0
	HT/VHT20 Beam Forming, M8 to M15	2	8	18.0	18.0			21.0	28.0	7.0
	HT/VHT20 Beam Forming, M0 to M7	3	13	15.5	15.7	15.6		20.4	23.0	2.6
	HT/VHT20 Beam Forming, M8 to M15	3	10	18.0	18.0	18.8		23.1	26.0	2.9
	HT/VHT20 Beam Forming, M16 to M23	3	8	18.0	18.0	18.8		23.1	28.0	4.9
	HT/VHT20 Beam Forming, M0 to M7	4	14	12.5	12.8	13.3	12.7	18.9	22.0	3.1
	HT/VHT20 Beam Forming, M8 to M15	4	11	15.6	15.8	16.7	15.8	22.0	25.0	3.0
	HT/VHT20 Beam Forming, M16 to M23	4	9	18.0	18.0	18.8	17.9	24.2	27.0	2.8
HT/VHT20 STBC, M0 to M7	2	8	18.0	18.0			21.0	28.0	7.0	
HT/VHT20 STBC, M0 to M7	3	8	18.0	18.0	18.8		23.1	28.0	4.9	
HT/VHT20 STBC, M0 to M7	4	8	15.6	15.8	16.7	15.8	22.0	28.0	6.0	
5230	Non HT40, 6 to 54 Mbps	1	8	18.7				18.7	28.0	9.3
	Non HT40, 6 to 54 Mbps	2	8	18.7	18.8			21.8	28.0	6.2
	Non HT40, 6 to 54 Mbps	3	8	17.6	17.5	19.0		22.9	28.0	5.1
	Non HT40, 6 to 54 Mbps	4	8	15.3	15.2	16.7	15.6	21.8	28.0	6.2
	HT/VHT40, M0 to M7	1	8	17.6				17.6	28.0	10.4
	HT/VHT40, M0 to M7	2	8	17.6	17.5			20.6	28.0	7.4
	HT/VHT40, M8 to M15	2	8	17.6	17.5			20.6	28.0	7.4
	HT/VHT40, M0 to M7	3	8	17.6	17.5	18.6		22.7	28.0	5.3
	HT/VHT40, M8 to M15	3	8	17.6	17.5	18.6		22.7	28.0	5.3
	HT/VHT40, M16 to M23	3	8	17.6	17.5	18.6		22.7	28.0	5.3
	HT/VHT40, M0 to M7	4	8	15.2	15.2	16.5	15.5	21.7	28.0	6.3
	HT/VHT40, M8 to M15	4	8	17.6	17.5	18.6	17.7	23.9	28.0	4.1

	HT/VHT40, M16 to M23	4	8	17.6	17.5	18.6	17.7	23.9	28.0	4.1
	HT/VHT40 Beam Forming, M0 to M7	2	11	17.6	17.5			20.6	25.0	4.4
	HT/VHT40 Beam Forming, M8 to M15	2	8	17.6	17.5			20.6	28.0	7.4
	HT/VHT40 Beam Forming, M0 to M7	3	13	17.6	17.5	18.6		22.7	23.0	0.3
	HT/VHT40 Beam Forming, M8 to M15	3	10	17.6	17.5	18.6		22.7	26.0	3.3
	HT/VHT40 Beam Forming, M16 to M23	3	8	17.6	17.5	18.6		22.7	28.0	5.3
	HT/VHT40 Beam Forming, M0 to M7	4	14	15.2	15.2	16.5	15.5	21.7	22.0	0.3
	HT/VHT40 Beam Forming, M8 to M15	4	11	17.6	17.5	18.6	17.7	23.9	25.0	1.1
	HT/VHT40 Beam Forming, M16 to M23	4	9	17.6	17.5	18.6	17.7	23.9	27.0	3.1
	HT/VHT40 STBC, M0 to M7	2	8	17.6	17.5			20.6	28.0	7.4
	HT/VHT40 STBC, M0 to M7	3	8	17.6	17.5	18.6		22.7	28.0	5.3
	HT/VHT40 STBC, M0 to M7	4	8	17.6	17.5	18.6	17.7	23.9	28.0	4.1
5240	Non HT20, 6 to 54 Mbps	1	8	17.2				17.2	28.0	10.8
	Non HT20, 6 to 54 Mbps	2	8	17.2	17.3			20.3	28.0	7.7
	Non HT20, 6 to 54 Mbps	3	8	14.8	14.9	16.5		20.2	28.0	7.8
	Non HT20, 6 to 54 Mbps	4	8	12.7	12.9	14.2	13.7	19.4	28.0	8.6
	Non HT20 Beam Forming, 6 to 54 Mbps	2	11	17.2	17.3			20.3	25.0	4.7
	Non HT20 Beam Forming, 6 to 54 Mbps	3	13	14.8	14.9	16.5		20.2	23.0	2.8
	Non HT20 Beam Forming, 6 to 54 Mbps	4	14	12.7	12.9	14.2	13.7	19.4	22.0	2.6
	HT/VHT20, M0 to M7	1	8	17.3				17.3	28.0	10.7
	HT/VHT20, M0 to M7	2	8	17.3	17.4			20.4	28.0	7.6
	HT/VHT20, M8 to M15	2	8	17.3	17.4			20.4	28.0	7.6
	HT/VHT20, M0 to M7	3	8	14.9	15.1	16.6		20.4	28.0	7.6
	HT/VHT20, M8 to M15	3	8	17.3	17.4	18.8		22.7	28.0	5.3
	HT/VHT20, M16 to M23	3	8	17.3	17.4	18.8		22.7	28.0	5.3
	HT/VHT20, M0 to M7	4	8	11.8	12.0	13.3	12.7	18.5	28.0	9.5
	HT/VHT20, M8 to M15	4	8	14.9	15.1	16.6	15.8	21.7	28.0	6.3
	HT/VHT20, M16 to M23	4	8	17.3	17.4	18.8	17.9	23.9	28.0	4.1
	HT/VHT20 Beam Forming, M0 to M7	2	11	17.3	17.4			20.4	25.0	4.6
	HT/VHT20 Beam Forming, M8 to M15	2	8	17.3	17.4			20.4	28.0	7.6
	HT/VHT20 Beam Forming, M0 to M7	3	13	14.9	15.1	16.6		20.4	23.0	2.6
	HT/VHT20 Beam Forming, M8 to M15	3	10	17.3	17.4	18.8		22.7	26.0	3.3
	HT/VHT20 Beam Forming, M16 to M23	3	8	17.3	17.4	18.8		22.7	28.0	5.3
	HT/VHT20 Beam Forming, M0 to M7	4	14	11.8	12.0	13.3	12.7	18.5	22.0	3.5
	HT/VHT20 Beam Forming, M8 to M15	4	11	14.9	15.1	16.6	15.8	21.7	25.0	3.3
	HT/VHT20 Beam Forming, M16 to M23	4	9	17.3	17.4	18.8	17.9	23.9	27.0	3.1
	HT/VHT20 STBC, M0 to M7	2	8	17.3	17.4			20.4	28.0	7.6
	HT/VHT20 STBC, M0 to M7	3	8	17.3	17.4	18.8		22.7	28.0	5.3
	HT/VHT20 STBC, M0 to M7	4	8	14.9	15.1	16.6	15.8	21.7	28.0	6.3

Frequency (MHz)	Mode	Tx Paths	Correlated Antenna Gain (dBi)	Tx 1 PSD (dBm/MHz)	Tx 2 PSD (dBm/MHz)	Tx 3 PSD (dBm/MHz)	Tx 4 PSD (dBm/MHz)	Total PSD (dBm/MHz)	Limit (dBm/MHz)	Margin (dB)
5180	Non HT20, 6 to 54 Mbps	1	8	8.6				8.6	15.0	6.4
	Non HT20, 6 to 54 Mbps	2	11	8.6	7.7			11.2	12.0	0.8
	Non HT20, 6 to 54 Mbps	3	13	4.8	4.6	2.3		8.8	10.0	1.2
	Non HT20, 6 to 54 Mbps	4	14	2.7	2.4	1.5	2.0	8.2	9.0	0.8
	Non HT20 Beam Forming, 6 to 54 Mbps	2	11	8.6	7.7			11.2	12.0	0.8
	Non HT20 Beam Forming, 6 to 54 Mbps	3	13	4.8	4.6	2.3		8.8	10.0	1.2
	Non HT20 Beam Forming, 6 to 54 Mbps	4	14	2.7	2.4	1.5	2.0	8.2	9.0	0.8
	HT/VHT20, M0 to M7	1	8	8.2				8.2	15.0	6.8
	HT/VHT20, M0 to M7	2	11	8.2	7.7			11.0	12.0	1.0
	HT/VHT20, M8 to M15	2	8	8.2	7.7			11.0	15.0	4.0
	HT/VHT20, M0 to M7	3	13	6.0	5.4	3.8		9.9	10.0	0.1
	HT/VHT20, M8 to M15	3	10	8.2	7.7	6.8		12.4	13.0	0.6
	HT/VHT20, M16 to M23	3	8	8.2	7.7	6.8		12.4	15.0	2.6
	HT/VHT20, M0 to M7	4	14	2.9	2.8	1.8	1.9	8.4	9.0	0.6
	HT/VHT20, M8 to M15	4	11	5.9	5.4	4.9	5.2	11.4	12.0	0.6
	HT/VHT20, M16 to M23	4	9	7.1	6.4	6.2	6.5	12.6	14.0	1.4
	HT/VHT20 Beam Forming, M0 to M7	2	11	8.2	7.7			11.0	12.0	1.0
	HT/VHT20 Beam Forming, M8 to M15	2	8	8.2	7.7			11.0	15.0	4.0
	HT/VHT20 Beam Forming, M0 to M7	3	13	4.6	4.3	2.6		8.7	10.0	1.3
	HT/VHT20 Beam Forming, M8 to M15	3	10	5.9	5.4	4.9		10.2	13.0	2.8
	HT/VHT20 Beam Forming, M16 to M23	3	8	8.2	7.7	6.8		12.4	15.0	2.6
	HT/VHT20 Beam Forming, M0 to M7	4	14	1.2	-1.2	-1.9	-1.3	5.4	9.0	3.6
	HT/VHT20 Beam Forming, M8 to M15	4	11	4.6	4.3	2.6	3.3	9.8	12.0	2.2
	HT/VHT20 Beam Forming, M16 to M23	4	9	5.9	5.4	4.9	5.2	11.4	14.0	2.6
	HT/VHT20 STBC, M0 to M7	2	8	8.2	7.7			11.0	15.0	4.0
	HT/VHT20 STBC, M0 to M7	3	10	8.2	7.7	6.8		12.4	13.0	0.6
	HT/VHT20 STBC, M0 to M7	4	11	5.9	5.4	4.9	5.2	11.4	12.0	0.6
	5190	Non HT40, 6 to 54 Mbps	1	8	2.1				2.1	15.0
Non HT40, 6 to 54 Mbps		2	11	2.1	1.2			4.7	12.0	7.3
Non HT40, 6 to 54 Mbps		3	13	1.0	0.7	0.4		5.5	10.0	4.5
Non HT40, 6 to 54 Mbps		4	14	1.0	0.7	0.4	-0.1	6.5	9.0	2.5
HT/VHT40, M0 to M7		1	8	5.1				5.1	15.0	9.9
HT/VHT40, M0 to M7		2	11	3.9	3.5			6.7	12.0	5.3
HT/VHT40, M8 to M15		2	8	3.9	3.5			6.7	15.0	8.3

	HT/VHT40, M0 to M7	3	13	2.8	2.0	2.0		7.1	10.0	2.9
	HT/VHT40, M8 to M15	3	10	2.8	2.0	2.0		7.1	13.0	5.9
	HT/VHT40, M16 to M23	3	8	2.8	2.0	2.0		7.1	15.0	7.9
	HT/VHT40, M0 to M7	4	14	2.3	2.4	1.2	0.6	7.7	9.0	1.3
	HT/VHT40, M8 to M15	4	11	2.3	2.4	1.2	0.6	7.7	12.0	4.3
	HT/VHT40, M16 to M23	4	9	2.3	2.4	1.2	0.6	7.7	14.0	6.3
	HT/VHT40 Beam Forming, M0 to M7	2	11	2.8	2.0			5.4	12.0	6.6
	HT/VHT40 Beam Forming, M8 to M15	2	8	3.9	3.5			6.7	15.0	8.3
	HT/VHT40 Beam Forming, M0 to M7	3	13	-0.3	-0.5	-1.1		4.2	10.0	5.8
	HT/VHT40 Beam Forming, M8 to M15	3	10	1.6	1.4	-0.2		5.8	13.0	7.2
	HT/VHT40 Beam Forming, M16 to M23	3	8	2.8	2.0	2.0		7.1	15.0	7.9
	HT/VHT40 Beam Forming, M0 to M7	4	14	-4.5	-6.4	-7.5	-6.5	-0.1	9.0	9.1
	HT/VHT40 Beam Forming, M8 to M15	4	11	0.3	0.1	-0.2	-0.3	6.0	12.0	6.0
	HT/VHT40 Beam Forming, M16 to M23	4	9	1.6	1.4	-0.2	0.9	7.0	14.0	7.0
	HT/VHT40 STBC, M0 to M7	2	8	3.9	3.5			6.7	15.0	8.3
	HT/VHT40 STBC, M0 to M7	3	10	2.8	2.0	2.0		7.1	13.0	5.9
	HT/VHT40 STBC, M0 to M7	4	11	2.3	2.4	1.2	0.6	7.7	12.0	4.3
5210	Non HT80, 6 to 54 Mbps	1	8	-1.3				-1.3	15.0	16.3
	Non HT80, 6 to 54 Mbps	2	11	-2.4	-3.0			0.3	12.0	11.7
	Non HT80, 6 to 54 Mbps	3	13	-4.6	-5.0	-4.5		0.1	10.0	9.9
	Non HT80, 6 to 54 Mbps	4	14	-4.6	-5.0	-4.5	-5.6	1.1	9.0	7.9
	VHT80, M0 to M9 1ss	1	8	1.1				1.1	15.0	13.9
	VHT80, M0 to M9 1ss	2	11	-1.2	-1.7			1.6	12.0	10.4
	VHT80, M0 to M9 2ss	2	8	-1.2	-1.7			1.6	15.0	13.4
	VHT80, M0 to M9 1ss	3	13	-2.3	-2.8	-3.7		1.9	10.0	8.1
	VHT80, M0 to M9 2ss	3	10	-2.3	-2.8	-3.7		1.9	13.0	11.1
	VHT80, M0 to M9 3ss	3	8	-2.3	-2.8	-3.7		1.9	15.0	13.1
	VHT80, M0 to M9 1ss	4	14	-3.5	-3.7	-3.6	-4.0	2.3	9.0	6.7
	VHT80, M0 to M9 2ss	4	11	-3.5	-3.7	-3.6	-4.0	2.3	12.0	9.7
	VHT80, M0 to M9 3ss	4	9	-3.5	-3.7	-3.6	-4.0	2.3	14.0	11.7
	VHT80 Beam Forming, M0 to M9 1ss	2	11	-2.3	-2.8			0.5	12.0	11.5
	VHT80 Beam Forming, M0 to M9 2ss	2	8	-1.2	-1.7			1.6	15.0	13.4
	VHT80 Beam Forming, M0 to M9 1ss	3	13	-7.9	-8.4	-8.9		-3.6	10.0	13.6
	VHT80 Beam Forming, M0 to M9 2ss	3	10	-4.3	-5.0	-4.4		0.2	13.0	12.8
	VHT80 Beam Forming, M0 to M9 3ss	3	8	-2.3	-2.8	-3.7		1.9	15.0	13.1
	VHT80 Beam Forming, M0 to M9 1ss	4	14	-9.2	-9.8	-10.2	-11.2	-4.0	9.0	13.0
	VHT80 Beam Forming, M0 to M9 2ss	4	11	-6.9	-7.9	-7.8	-9.1	-1.8	12.0	13.8
	VHT80 Beam Forming, M0 to M9 3ss	4	9	-4.3	-5.0	-4.4	-5.3	1.3	14.0	12.7
	VHT80 STBC, M0 to M9 1ss	2	8	-1.2	-1.7			1.6	15.0	13.4
	VHT80 STBC, M0 to M9 1ss	3	8	-2.3	-2.8	-3.7		1.9	15.0	13.1
VHT80 STBC, M0 to M9 1ss	4	8	-3.5	-3.7	-3.6	-4.0	2.3	15.0	12.7	

5220	Non HT20, 6 to 54 Mbps	1	8	7.4				7.4	15.0	7.6
	Non HT20, 6 to 54 Mbps	2	11	7.4	7.5			10.5	12.0	1.5
	Non HT20, 6 to 54 Mbps	3	13	4.6	4.8	4.8		9.5	10.0	0.5
	Non HT20, 6 to 54 Mbps	4	14	1.7	2.3	2.6	1.9	8.2	9.0	0.8
	Non HT20 Beam Forming, 6 to 54 Mbps	2	11	7.4	7.5			10.5	12.0	1.5
	Non HT20 Beam Forming, 6 to 54 Mbps	3	13	4.6	4.8	4.8		9.5	10.0	0.5
	Non HT20 Beam Forming, 6 to 54 Mbps	4	14	1.7	2.3	2.6	1.9	8.2	9.0	0.8
	HT/VHT20, M0 to M7	1	8	7.2				7.2	15.0	7.8
	HT/VHT20, M0 to M7	2	11	7.2	7.4			10.3	12.0	1.7
	HT/VHT20, M8 to M15	2	8	7.2	7.4			10.3	15.0	4.7
	HT/VHT20, M0 to M7	3	13	4.8	5.2	4.6		9.6	10.0	0.4
	HT/VHT20, M8 to M15	3	10	7.2	7.4	8.0		12.3	13.0	0.7
	HT/VHT20, M16 to M23	3	8	7.2	7.4	8.0		12.3	15.0	2.7
	HT/VHT20, M0 to M7	4	14	1.8	1.9	2.7	1.9	8.1	9.0	0.9
	HT/VHT20, M8 to M15	4	11	5.0	5.0	5.7	5.0	11.2	12.0	0.8
	HT/VHT20, M16 to M23	4	9	7.2	7.4	8.0	7.0	13.4	14.0	0.6
	HT/VHT20 Beam Forming, M0 to M7	2	11	7.2	7.4			10.3	12.0	1.7
	HT/VHT20 Beam Forming, M8 to M15	2	8	7.2	7.4			10.3	15.0	4.7
	HT/VHT20 Beam Forming, M0 to M7	3	13	4.8	5.2	4.6		9.6	10.0	0.4
	HT/VHT20 Beam Forming, M8 to M15	3	10	7.2	7.4	8.0		12.3	13.0	0.7
	HT/VHT20 Beam Forming, M16 to M23	3	8	7.2	7.4	8.0		12.3	15.0	2.7
	HT/VHT20 Beam Forming, M0 to M7	4	14	1.8	1.9	2.7	1.9	8.1	9.0	0.9
	HT/VHT20 Beam Forming, M8 to M15	4	11	5.0	5.0	5.7	5.0	11.2	12.0	0.8
	HT/VHT20 Beam Forming, M16 to M23	4	9	7.2	7.4	8.0	7.0	13.4	14.0	0.6
HT/VHT20 STBC, M0 to M7	2	8	7.2	7.4			10.3	15.0	4.7	
HT/VHT20 STBC, M0 to M7	3	10	7.2	7.4	8.0		12.3	13.0	0.7	
HT/VHT20 STBC, M0 to M7	4	11	5.0	5.0	5.7	5.0	11.2	12.0	0.8	
5230	Non HT40, 6 to 54 Mbps	1	8	5.5				5.5	15.0	9.5
	Non HT40, 6 to 54 Mbps	2	11	5.5	5.9			8.7	12.0	3.3
	Non HT40, 6 to 54 Mbps	3	13	4.4	4.5	5.6		9.6	10.0	0.4
	Non HT40, 6 to 54 Mbps	4	14	2.0	2.1	3.5	1.9	8.4	9.0	0.6
	HT/VHT40, M0 to M7	1	8	4.1				4.1	15.0	10.9
	HT/VHT40, M0 to M7	2	11	4.1	3.8			7.0	12.0	5.0
	HT/VHT40, M8 to M15	2	8	4.1	3.8			7.0	15.0	8.0
	HT/VHT40, M0 to M7	3	13	4.1	3.8	4.8		9.0	10.0	1.0
	HT/VHT40, M8 to M15	3	10	4.1	3.8	4.8		9.0	13.0	4.0
	HT/VHT40, M16 to M23	3	8	4.1	3.8	4.8		9.0	15.0	6.0
	HT/VHT40, M0 to M7	4	14	2.2	2.0	2.6	1.8	8.2	9.0	0.8
	HT/VHT40, M8 to M15	4	11	4.1	3.8	4.8	3.8	10.2	12.0	1.8
	HT/VHT40, M16 to M23	4	9	4.1	3.8	4.8	3.8	10.2	14.0	3.8

	HT/VHT40 Beam Forming, M0 to M7	2	11	4.1	3.8			7.0	12.0	5.0
	HT/VHT40 Beam Forming, M8 to M15	2	8	4.1	3.8			7.0	15.0	8.0
	HT/VHT40 Beam Forming, M0 to M7	3	13	4.1	3.8	4.8		9.0	10.0	1.0
	HT/VHT40 Beam Forming, M8 to M15	3	10	4.1	3.8	4.8		9.0	13.0	4.0
	HT/VHT40 Beam Forming, M16 to M23	3	8	4.1	3.8	4.8		9.0	15.0	6.0
	HT/VHT40 Beam Forming, M0 to M7	4	14	2.2	2.0	2.6	1.8	8.2	9.0	0.8
	HT/VHT40 Beam Forming, M8 to M15	4	11	4.1	3.8	4.8	3.8	10.2	12.0	1.8
	HT/VHT40 Beam Forming, M16 to M23	4	9	4.1	3.8	4.8	3.8	10.2	14.0	3.8
	HT/VHT40 STBC, M0 to M7	2	8	4.1	3.8			7.0	15.0	8.0
	HT/VHT40 STBC, M0 to M7	3	10	4.1	3.8	4.8		9.0	13.0	4.0
	HT/VHT40 STBC, M0 to M7	4	11	4.1	3.8	4.8	3.8	10.2	12.0	1.8
5240	Non HT20, 6 to 54 Mbps	1	8	6.9				6.9	15.0	8.1
	Non HT20, 6 to 54 Mbps	2	11	6.9	6.9			9.9	12.0	2.1
	Non HT20, 6 to 54 Mbps	3	13	4.3	4.2	5.9		9.6	10.0	0.4
	Non HT20, 6 to 54 Mbps	4	14	2.1	2.2	3.8	3.4	9.0	9.0	0.0
	Non HT20 Beam Forming, 6 to 54 Mbps	2	11	6.9	6.9			9.9	12.0	2.1
	Non HT20 Beam Forming, 6 to 54 Mbps	3	13	4.3	4.2	5.9		9.6	10.0	0.4
	Non HT20 Beam Forming, 6 to 54 Mbps	4	14	2.1	2.2	3.8	3.4	9.0	9.0	0.0
	HT/VHT20, M0 to M7	1	8	6.5				6.5	15.0	8.5
	HT/VHT20, M0 to M7	2	11	6.5	6.7			9.6	12.0	2.4
	HT/VHT20, M8 to M15	2	8	6.5	6.7			9.6	15.0	5.4
	HT/VHT20, M0 to M7	3	13	4.1	4.1	5.7		9.5	10.0	0.5
	HT/VHT20, M8 to M15	3	10	6.5	6.7	8.1		11.9	13.0	1.1
	HT/VHT20, M16 to M23	3	8	6.5	6.7	8.1		11.9	15.0	3.1
	HT/VHT20, M0 to M7	4	14	1.3	1.2	2.4	2.1	7.8	9.0	1.2
	HT/VHT20, M8 to M15	4	11	4.1	4.1	5.7	5.3	10.9	12.0	1.1
	HT/VHT20, M16 to M23	4	9	6.5	6.7	8.1	7.0	13.1	14.0	0.9
	HT/VHT20 Beam Forming, M0 to M7	2	11	6.5	6.7			9.6	12.0	2.4
	HT/VHT20 Beam Forming, M8 to M15	2	8	6.5	6.7			9.6	15.0	5.4
	HT/VHT20 Beam Forming, M0 to M7	3	13	4.1	4.1	5.7		9.5	10.0	0.5
	HT/VHT20 Beam Forming, M8 to M15	3	10	6.5	6.7	8.1		11.9	13.0	1.1
	HT/VHT20 Beam Forming, M16 to M23	3	8	6.5	6.7	8.1		11.9	15.0	3.1
	HT/VHT20 Beam Forming, M0 to M7	4	14	1.3	1.2	2.4	2.1	7.8	9.0	1.2
	HT/VHT20 Beam Forming, M8 to M15	4	11	4.1	4.1	5.7	5.3	10.9	12.0	1.1
	HT/VHT20 Beam Forming, M16 to M23	4	9	6.5	6.7	8.1	7.0	13.1	14.0	0.9
	HT/VHT20 STBC, M0 to M7	2	8	6.5	6.7			9.6	15.0	5.4
	HT/VHT20 STBC, M0 to M7	3	10	6.5	6.7	8.1		11.9	13.0	1.1
	HT/VHT20 STBC, M0 to M7	4	11	4.1	4.1	5.7	5.3	10.9	12.0	1.1

Peak Output Power, 5230 MHz, HT/VHT40 Beam Forming, M0 to M7

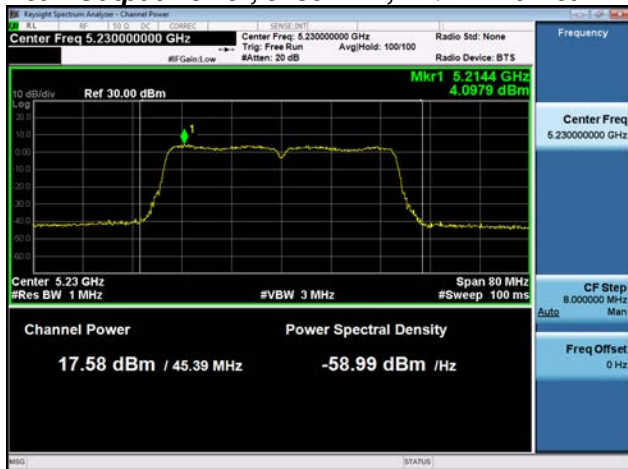

Antenna A

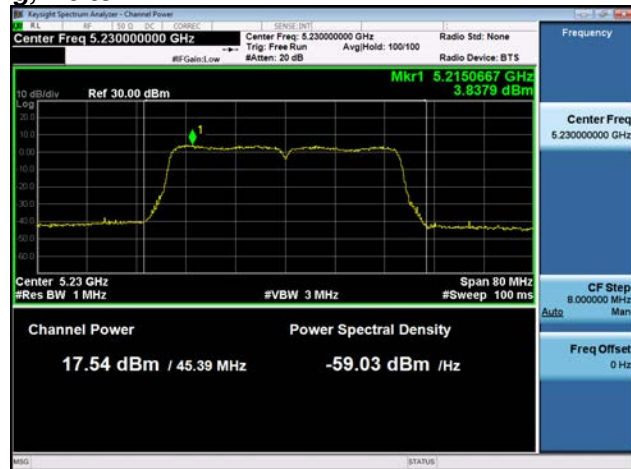

Antenna B

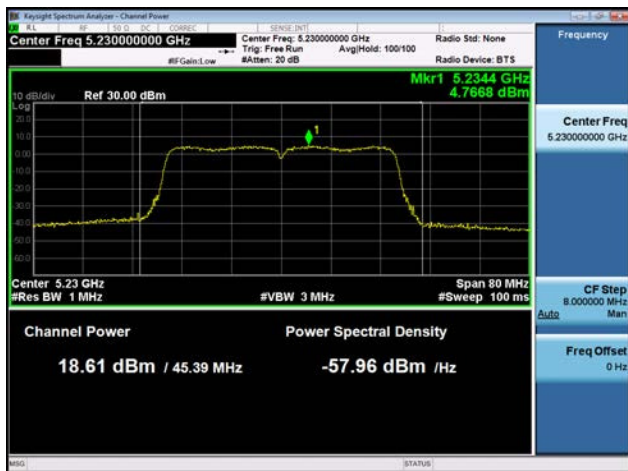

Antenna C

Power Spectral Density, 5240 MHz, Non HT20, 6 to 54 Mbps

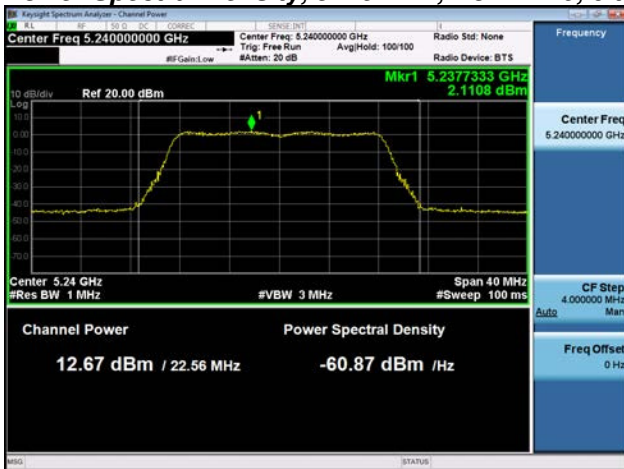

Antenna A

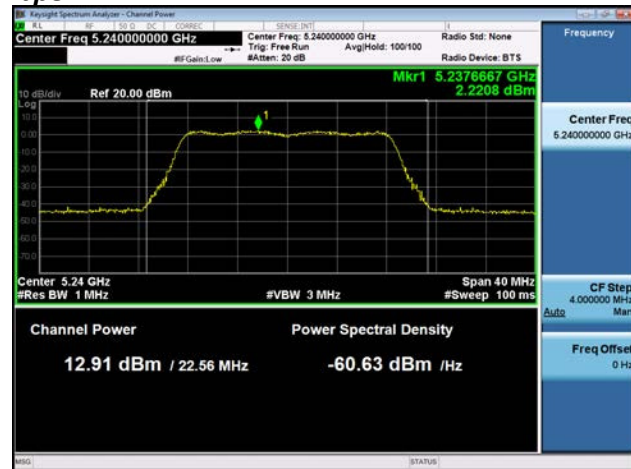

Antenna B

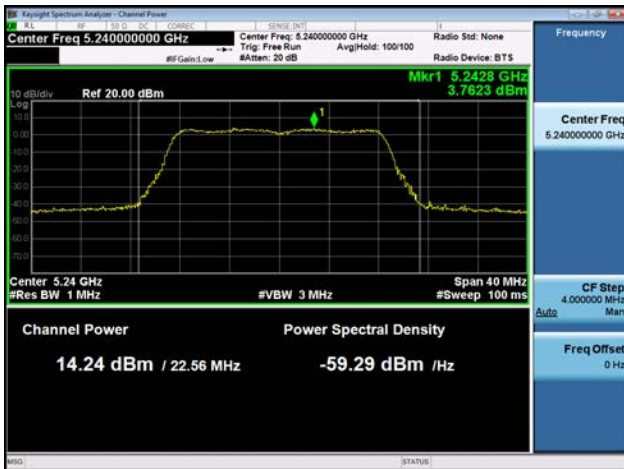

Antenna C

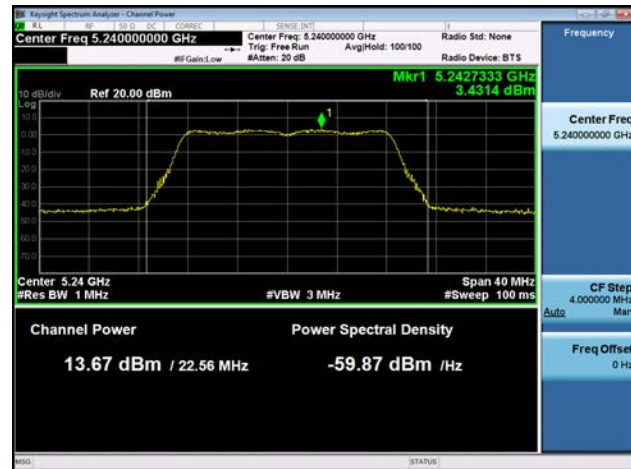

Antenna D

Antenna Gain : 13 dBi

Frequency (MHz)	Mode	Tx Paths	Correlated Antenna Gain (dBi)	Tx 1 Max Power (dBm)	Tx 2 Max Power (dBm)	Tx 3 Max Power (dBm)	Tx 4 Max Power (dBm)	Total Tx Channel Power (dBm)	Limit (dBm)	Margin (dB)
5180	Non HT20, 6 to 54 Mbps	1	13	18.8				18.8	23.0	4.2
	Non HT20, 6 to 54 Mbps	2	13	14.2	13.9			17.1	23.0	5.9
	Non HT20, 6 to 54 Mbps	3	13	12.3	9.7	9.1		15.4	23.0	7.6
	Non HT20, 6 to 54 Mbps	4	13	10.0	7.7	7.0	7.4	14.2	23.0	8.8
	Non HT20 Beam Forming, 6 to 54 Mbps	2	13	14.2	13.9			17.1	23.0	5.9
	Non HT20 Beam Forming, 6 to 54 Mbps	3	16	11.1	8.7	8.1		14.3	20.0	5.7
	Non HT20 Beam Forming, 6 to 54 Mbps	4	16	8.9	6.3	5.6	6.2	13.0	20.0	7.0
	HT/VHT20, M0 to M7	1	13	19.0				19.0	23.0	4.0
	HT/VHT20, M0 to M7	2	13	14.5	14.2			17.4	23.0	5.6
	HT/VHT20, M8 to M15	2	13	16.7	16.2			19.5	23.0	3.5
	HT/VHT20, M0 to M7	3	13	12.1	9.5	8.9		15.2	23.0	7.8
	HT/VHT20, M8 to M15	3	13	13.5	13.2	12.4		17.8	23.0	5.2
	HT/VHT20, M16 to M23	3	13	15.5	15.1	13.3		19.5	23.0	3.5
	HT/VHT20, M0 to M7	4	13	10.0	7.6	7.0	7.3	14.2	23.0	8.8
	HT/VHT20, M8 to M15	4	13	12.1	9.5	8.9	9.3	16.2	23.0	6.8
	HT/VHT20, M16 to M23	4	13	13.5	13.2	12.4	12.9	19.0	23.0	4.0
	HT/VHT20 Beam Forming, M0 to M7	2	13	14.5	14.2			17.4	23.0	5.6
	HT/VHT20 Beam Forming, M8 to M15	2	13	16.7	16.2			19.5	23.0	3.5
	HT/VHT20 Beam Forming, M0 to M7	3	16	10.0	7.6	7.0		13.2	20.0	6.8
	HT/VHT20 Beam Forming, M8 to M15	3	13	13.5	13.2	12.4		17.8	23.0	5.2
	HT/VHT20 Beam Forming, M16 to M23	3	13	15.5	15.1	13.3		19.5	23.0	3.5
	HT/VHT20 Beam Forming, M0 to M7	4	16	8.9	6.3	5.6	6.2	13.0	20.0	7.0
	HT/VHT20 Beam Forming, M8 to M15	4	13	12.1	9.5	8.9	9.3	16.2	23.0	6.8
	HT/VHT20 Beam Forming, M16 to M23	4	13	13.5	13.2	12.4	12.9	19.0	23.0	4.0
	HT/VHT20 STBC, M0 to M7	2	13	16.7	16.2			19.5	23.0	3.5
	HT/VHT20 STBC, M0 to M7	3	13	13.5	13.2	12.4		17.8	23.0	5.2
	HT/VHT20 STBC, M0 to M7	4	13	12.1	9.5	8.9	9.3	16.2	23.0	6.8
	5190	Non HT40, 6 to 54 Mbps	1	13	14.2				14.2	23.0
Non HT40, 6 to 54 Mbps		2	13	14.3	14.1			17.2	23.0	5.8
Non HT40, 6 to 54 Mbps		3	13	11.8	9.8	8.7		15.1	23.0	7.9
Non HT40, 6 to 54 Mbps		4	13	10.8	8.8	7.7	8.4	15.1	23.0	7.9
HT/VHT40, M0 to M7		1	13	16.4				16.4	23.0	6.6
HT/VHT40, M0 to M7		2	13	14.1	13.9			17.0	23.0	6.0

	HT/VHT40, M8 to M15	2	13	14.1	13.9			17.0	23.0	6.0
	HT/VHT40, M0 to M7	3	13	13.1	12.9	12.5		17.6	23.0	5.4
	HT/VHT40, M8 to M15	3	13	13.1	12.9	12.5		17.6	23.0	5.4
	HT/VHT40, M16 to M23	3	13	13.1	12.9	12.5		17.6	23.0	5.4
	HT/VHT40, M0 to M7	4	13	11.4	9.5	8.4	9.1	15.8	23.0	7.2
	HT/VHT40, M8 to M15	4	13	11.4	9.5	8.4	9.1	15.8	23.0	7.2
	HT/VHT40, M16 to M23	4	13	11.4	9.5	8.4	9.1	15.8	23.0	7.2
	HT/VHT40 Beam Forming, M0 to M7	2	13	14.1	13.9			17.0	23.0	6.0
	HT/VHT40 Beam Forming, M8 to M15	2	13	14.1	13.9			17.0	23.0	6.0
	HT/VHT40 Beam Forming, M0 to M7	3	16	9.4	7.4	6.2		12.6	20.0	7.4
	HT/VHT40 Beam Forming, M8 to M15	3	13	13.1	12.9	12.5		17.6	23.0	5.4
	HT/VHT40 Beam Forming, M16 to M23	3	13	13.1	12.9	12.5		17.6	23.0	5.4
	HT/VHT40 Beam Forming, M0 to M7	4	16	8.2	6.1	5.0	5.8	12.5	20.0	7.5
	HT/VHT40 Beam Forming, M8 to M15	4	13	11.4	9.5	8.4	9.1	15.8	23.0	7.2
	HT/VHT40 Beam Forming, M16 to M23	4	13	11.4	9.5	8.4	9.1	15.8	23.0	7.2
	HT/VHT40 STBC, M0 to M7	2	13	14.1	13.9			17.0	23.0	6.0
	HT/VHT40 STBC, M0 to M7	3	13	13.1	12.9	12.5		17.6	23.0	5.4
	HT/VHT40 STBC, M0 to M7	4	13	11.4	9.5	8.4	9.1	15.8	23.0	7.2
5210	Non HT80, 6 to 54 Mbps	1	13	12.7				12.7	23.0	10.3
	Non HT80, 6 to 54 Mbps	2	13	9.8	8.2			12.1	23.0	10.9
	Non HT80, 6 to 54 Mbps	3	13	7.6	6.3	6.8		11.7	23.0	11.3
	Non HT80, 6 to 54 Mbps	4	13	7.5	6.4	5.9	5.9	12.5	23.0	10.5
	VHT80, M0 to M9 1ss	1	13	14.4				14.4	23.0	8.6
	VHT80, M0 to M9 1ss	2	13	12.5	12.3			15.4	23.0	7.6
	VHT80, M0 to M9 2ss	2	13	12.5	12.3			15.4	23.0	7.6
	VHT80, M0 to M9 1ss	3	13	9.3	8.0	7.3		13.1	23.0	9.9
	VHT80, M0 to M9 2ss	3	13	9.3	8.0	7.3		13.1	23.0	9.9
	VHT80, M0 to M9 3ss	3	13	9.3	8.0	7.3		13.1	23.0	9.9
	VHT80, M0 to M9 1ss	4	13	8.1	6.8	6.3	6.3	13.0	23.0	10.0
	VHT80, M0 to M9 2ss	4	13	8.1	6.8	6.3	6.3	13.0	23.0	10.0
	VHT80, M0 to M9 3ss	4	13	8.1	6.8	6.3	6.3	13.0	23.0	10.0
	VHT80 Beam Forming, M0 to M9 1ss	2	13	12.5	12.3			15.4	23.0	7.6
	VHT80 Beam Forming, M0 to M9 2ss	2	13	12.5	12.3			15.4	23.0	7.6
	VHT80 Beam Forming, M0 to M9 1ss	3	13	9.3	8.0	7.3		13.1	23.0	9.9
	VHT80 Beam Forming, M0 to M9 2ss	3	13	9.3	8.0	7.3		13.1	23.0	9.9
	VHT80 Beam Forming, M0 to M9 3ss	3	13	9.3	8.0	7.3		13.1	23.0	9.9
	VHT80 Beam Forming, M0 to M9 1ss	4	13	8.1	6.8	6.3	6.3	13.0	23.0	10.0
	VHT80 Beam Forming, M0 to M9 2ss	4	13	8.1	6.8	6.3	6.3	13.0	23.0	10.0
VHT80 Beam Forming, M0 to M9 3ss	4	13	8.1	6.8	6.3	6.3	13.0	23.0	10.0	
VHT80 STBC, M0 to M9 1ss	2	13	12.5	12.3			15.4	23.0	7.6	
VHT80 STBC, M0 to M9 1ss	3	13	9.3	8.0	7.3		13.1	23.0	9.9	

	VHT80 STBC, M0 to M9 1ss	4	13	8.1	6.8	6.3	6.3	13.0	23.0	10.0
5220	Non HT20, 6 to 54 Mbps	1	13	17.8				17.8	23.0	5.2
	Non HT20, 6 to 54 Mbps	2	13	14.3	14.5			17.4	23.0	5.6
	Non HT20, 6 to 54 Mbps	3	13	10.9	9.6	9.4		14.8	23.0	8.2
	Non HT20, 6 to 54 Mbps	4	13	8.9	7.7	7.5	7.4	13.9	23.0	9.1
	Non HT20 Beam Forming, 6 to 54 Mbps	2	13	14.3	14.5			17.4	23.0	5.6
	Non HT20 Beam Forming, 6 to 54 Mbps	3	16	10.9	9.6	9.4		14.8	20.0	5.2
	Non HT20 Beam Forming, 6 to 54 Mbps	4	16	8.9	7.7	7.5	7.4	13.9	20.0	6.1
	HT/VHT20, M0 to M7	1	13	18.0				18.0	23.0	5.0
	HT/VHT20, M0 to M7	2	13	14.4	14.6			17.5	23.0	5.5
	HT/VHT20, M8 to M15	2	13	16.8	17.0			19.9	23.0	3.1
	HT/VHT20, M0 to M7	3	13	11.0	9.7	9.6		14.9	23.0	8.1
	HT/VHT20, M8 to M15	3	13	12.5	12.8	13.3		17.7	23.0	5.3
	HT/VHT20, M16 to M23	3	13	15.5	15.7	15.6		20.4	23.0	2.6
	HT/VHT20, M0 to M7	4	13	9.0	7.8	7.6	7.5	14.0	23.0	9.0
	HT/VHT20, M8 to M15	4	13	11.0	9.7	9.6	9.5	16.0	23.0	7.0
	HT/VHT20, M16 to M23	4	13	12.5	12.8	13.3	12.7	18.9	23.0	4.1
	HT/VHT20 Beam Forming, M0 to M7	2	13	14.4	14.6			17.5	23.0	5.5
	HT/VHT20 Beam Forming, M8 to M15	2	13	16.8	17.0			19.9	23.0	3.1
	HT/VHT20 Beam Forming, M0 to M7	3	16	11.0	9.7	9.6		14.9	20.0	5.1
	HT/VHT20 Beam Forming, M8 to M15	3	13	12.5	12.8	13.3		17.7	23.0	5.3
	HT/VHT20 Beam Forming, M16 to M23	3	13	15.5	15.7	15.6		20.4	23.0	2.6
	HT/VHT20 Beam Forming, M0 to M7	4	16	9.0	7.8	7.6	7.5	14.0	20.0	6.0
	HT/VHT20 Beam Forming, M8 to M15	4	13	11.0	9.7	9.6	9.5	16.0	23.0	7.0
	HT/VHT20 Beam Forming, M16 to M23	4	13	12.5	12.8	13.3	12.7	18.9	23.0	4.1
HT/VHT20 STBC, M0 to M7	2	13	16.8	17.0			19.9	23.0	3.1	
HT/VHT20 STBC, M0 to M7	3	13	12.5	12.8	13.3		17.7	23.0	5.3	
HT/VHT20 STBC, M0 to M7	4	13	11.0	9.7	9.6	9.5	16.0	23.0	7.0	
5230	Non HT40, 6 to 54 Mbps	1	13	18.7				18.7	23.0	4.3
	Non HT40, 6 to 54 Mbps	2	13	16.4	16.4			19.4	23.0	3.6
	Non HT40, 6 to 54 Mbps	3	13	13.2	13.4	13.3		18.1	23.0	4.9
	Non HT40, 6 to 54 Mbps	4	13	11.3	10.6	10.1	9.8	16.5	23.0	6.5
	HT/VHT40, M0 to M7	1	13	17.6				17.6	23.0	5.4
	HT/VHT40, M0 to M7	2	13	17.6	17.5			20.6	23.0	2.4
	HT/VHT40, M8 to M15	2	13	17.6	17.5			20.6	23.0	2.4
	HT/VHT40, M0 to M7	3	13	12.9	13.1	14.3		18.2	23.0	4.8
	HT/VHT40, M8 to M15	3	13	15.2	15.2	16.5		20.4	23.0	2.6
	HT/VHT40, M16 to M23	3	13	17.6	17.5	18.6		22.7	23.0	0.3
	HT/VHT40, M0 to M7	4	13	11.1	10.4	10.0	9.5	16.3	23.0	6.7
	HT/VHT40, M8 to M15	4	13	13.9	14.1	14.1	14.3	20.1	23.0	2.9

	HT/VHT40, M16 to M23	4	13	15.2	15.2	16.5	15.5	21.7	23.0	1.3
	HT/VHT40 Beam Forming, M0 to M7	2	13	17.6	17.5			20.6	23.0	2.4
	HT/VHT40 Beam Forming, M8 to M15	2	13	17.6	17.5			20.6	23.0	2.4
	HT/VHT40 Beam Forming, M0 to M7	3	16	12.9	13.1	14.3		18.2	20.0	1.8
	HT/VHT40 Beam Forming, M8 to M15	3	13	15.2	15.2	16.5		20.4	23.0	2.6
	HT/VHT40 Beam Forming, M16 to M23	3	13	17.6	17.5	18.6		22.7	23.0	0.3
	HT/VHT40 Beam Forming, M0 to M7	4	16	11.1	10.4	10.0	9.5	16.3	20.0	3.7
	HT/VHT40 Beam Forming, M8 to M15	4	13	13.9	14.1	14.1	14.3	20.1	23.0	2.9
	HT/VHT40 Beam Forming, M16 to M23	4	13	15.2	15.2	16.5	15.5	21.7	23.0	1.3
	HT/VHT40 STBC, M0 to M7	2	13	17.6	17.5			20.6	23.0	2.4
	HT/VHT40 STBC, M0 to M7	3	13	15.2	15.2	16.5		20.4	23.0	2.6
	HT/VHT40 STBC, M0 to M7	4	13	13.9	14.1	14.1	14.3	20.1	23.0	2.9
5240	Non HT20, 6 to 54 Mbps	1	13	17.2				17.2	23.0	5.8
	Non HT20, 6 to 54 Mbps	2	13	13.6	13.9			16.8	23.0	6.2
	Non HT20, 6 to 54 Mbps	3	13	10.1	9.4	9.6		14.5	23.0	8.5
	Non HT20, 6 to 54 Mbps	4	13	9.1	8.5	8.6	7.6	14.5	23.0	8.5
	Non HT20 Beam Forming, 6 to 54 Mbps	2	13	13.6	13.9			16.8	23.0	6.2
	Non HT20 Beam Forming, 6 to 54 Mbps	3	16	10.1	9.4	9.6		14.5	20.0	5.5
	Non HT20 Beam Forming, 6 to 54 Mbps	4	16	9.1	8.5	8.6	7.6	14.5	20.0	5.5
	HT/VHT20, M0 to M7	1	13	17.3				17.3	23.0	5.7
	HT/VHT20, M0 to M7	2	13	13.8	14.0			16.9	23.0	6.1
	HT/VHT20, M8 to M15	2	13	17.3	17.4			20.4	23.0	2.6
	HT/VHT20, M0 to M7	3	13	11.3	10.5	10.6		15.6	23.0	7.4
	HT/VHT20, M8 to M15	3	13	13.8	14.0	14.3		18.8	23.0	4.2
	HT/VHT20, M16 to M23	3	13	14.9	15.1	16.6		20.4	23.0	2.6
	HT/VHT20, M0 to M7	4	13	9.2	8.6	8.7	7.7	14.6	23.0	8.4
	HT/VHT20, M8 to M15	4	13	11.3	10.5	10.6	9.8	16.6	23.0	6.4
	HT/VHT20, M16 to M23	4	13	11.8	12.0	13.3	12.7	18.5	23.0	4.5
	HT/VHT20 Beam Forming, M0 to M7	2	13	13.8	14.0			16.9	23.0	6.1
	HT/VHT20 Beam Forming, M8 to M15	2	13	17.3	17.4			20.4	23.0	2.6
	HT/VHT20 Beam Forming, M0 to M7	3	16	11.3	10.5	10.6		15.6	20.0	4.4
	HT/VHT20 Beam Forming, M8 to M15	3	13	13.8	14.0	14.3		18.8	23.0	4.2
	HT/VHT20 Beam Forming, M16 to M23	3	13	14.9	15.1	16.6		20.4	23.0	2.6
	HT/VHT20 Beam Forming, M0 to M7	4	16	9.2	8.6	8.7	7.7	14.6	20.0	5.4
	HT/VHT20 Beam Forming, M8 to M15	4	13	11.3	10.5	10.6	9.8	16.6	23.0	6.4
	HT/VHT20 Beam Forming, M16 to M23	4	13	11.8	12.0	13.3	12.7	18.5	23.0	4.5
	HT/VHT20 STBC, M0 to M7	2	13	17.3	17.4			20.4	23.0	2.6
	HT/VHT20 STBC, M0 to M7	3	13	13.8	14.0	14.3		18.8	23.0	4.2
HT/VHT20 STBC, M0 to M7	4	13	11.3	10.5	10.6	9.8	16.6	23.0	6.4	

Frequency (MHz)	Mode	Tx Paths	Correlated Antenna Gain (dBi)	Tx 1 PSD (dBm/MHz)	Tx 2 PSD (dBm/MHz)	Tx 3 PSD (dBm/MHz)	Tx 4 PSD (dBm/MHz)	Total PSD (dBm/MHz)	Limit (dBm/MHz)	Margin (dB)
5180	Non HT20, 6 to 54 Mbps	1	13	8.6				8.6	10.0	1.4
	Non HT20, 6 to 54 Mbps	2	16	3.4	3.4			6.4	7.0	0.6
	Non HT20, 6 to 54 Mbps	3	18	1.8	-0.8	-1.0		5.0	5.0	0.0
	Non HT20, 6 to 54 Mbps	4	19	-0.4	-3.1	-3.4	-3.0	3.7	4.0	0.3
	Non HT20 Beam Forming, 6 to 54 Mbps	2	16	3.4	3.4			6.4	7.0	0.6
	Non HT20 Beam Forming, 6 to 54 Mbps	3	18	0.7	-1.7	-2.5		3.8	5.0	1.2
	Non HT20 Beam Forming, 6 to 54 Mbps	4	19	-1.4	-4.1	-5.0	-4.3	2.6	4.0	1.4
	HT/VHT20, M0 to M7	1	13	8.2				8.2	10.0	1.8
	HT/VHT20, M0 to M7	2	16	3.8	3.5			6.7	7.0	0.3
	HT/VHT20, M8 to M15	2	13	5.9	5.4			8.7	10.0	1.3
	HT/VHT20, M0 to M7	3	18	1.2	-1.2	-1.9		4.3	5.0	0.7
	HT/VHT20, M8 to M15	3	15	2.9	2.8	1.8		7.3	8.0	0.7
	HT/VHT20, M16 to M23	3	13	4.6	4.3	2.6		8.7	10.0	1.3
	HT/VHT20, M0 to M7	4	19	-1.0	-2.9	-3.5	-3.6	3.4	4.0	0.6
	HT/VHT20, M8 to M15	4	16	1.2	-1.2	-1.9	-1.3	5.4	7.0	1.6
	HT/VHT20, M16 to M23	4	14	2.9	2.8	1.8	1.9	8.4	9.0	0.6
	HT/VHT20 Beam Forming, M0 to M7	2	16	3.8	3.5			6.7	7.0	0.3
	HT/VHT20 Beam Forming, M8 to M15	2	13	5.9	5.4			8.7	10.0	1.3
	HT/VHT20 Beam Forming, M0 to M7	3	18	-1.0	-2.9	-3.5		2.4	5.0	2.6
	HT/VHT20 Beam Forming, M8 to M15	3	15	2.9	2.8	1.8		7.3	8.0	0.7
	HT/VHT20 Beam Forming, M16 to M23	3	13	4.6	4.3	2.6		8.7	10.0	1.3
	HT/VHT20 Beam Forming, M0 to M7	4	19	-1.8	-4.4	-5.3	-4.6	2.2	4.0	1.8
	HT/VHT20 Beam Forming, M8 to M15	4	16	1.2	-1.2	-1.9	-1.3	5.4	7.0	1.6
	HT/VHT20 Beam Forming, M16 to M23	4	14	2.9	2.8	1.8	1.9	8.4	9.0	0.6
	HT/VHT20 STBC, M0 to M7	2	13	5.9	5.4			8.7	10.0	1.3
	HT/VHT20 STBC, M0 to M7	3	15	2.9	2.8	1.8		7.3	8.0	0.7
	HT/VHT20 STBC, M0 to M7	4	16	1.2	-1.2	-1.9	-1.3	5.4	7.0	1.6
	5190	Non HT40, 6 to 54 Mbps	1	13	1.0				1.0	10.0
Non HT40, 6 to 54 Mbps		2	16	1.0	0.9			4.0	7.0	3.0
Non HT40, 6 to 54 Mbps		3	18	-1.6	-3.4	-4.4		1.8	5.0	3.2
Non HT40, 6 to 54 Mbps		4	19	-2.4	-4.5	-5.5	-4.7	1.9	4.0	2.1
HT/VHT40, M0 to M7		1	13	2.8				2.8	10.0	7.2
HT/VHT40, M0 to M7		2	16	0.3	0.1			3.2	7.0	3.8
HT/VHT40, M8 to M15		2	13	0.3	0.1			3.2	10.0	6.8