



Test Report

FCC ID: LDK102099

**AIR-AP3802E-B-K9, AIR-AP3802E-UXK9
AIR-AP2802E-B-K9, AIR-AP2802E-UXK9**

IC: 2461B-102099

**AIR-AP3802E-A-K9, AIR-AP3802E-UXK9
AIR-AP2802E-A-K9, AIR-AP2802E-UXK9**

Cisco Aironet 802.11ac Dual Band Access Points

5725-5850 MHz

Against the following Specifications:

CFR47 Part 15.407

RSS-247

Cisco Systems

170 West Tasman Drive

San Jose, CA 95134

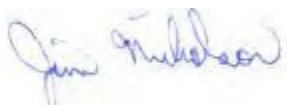
| | |
|---|--|
|  |  |
| Author: Jose Aguirre Tested By | Approved By: Jim Nicholson Title: Technical Leader, Engineering Revision: 3 |

This report replaces any previously entered test report under EDCS –**1552001**. This test report has been electronically authorized and archived using the CISCO Engineering Document Control system.



This test report has been electronically authorized and archived using the CISCO Engineering Document Control system.

SECTION 1: OVERVIEW3

SECTION 2: ASSESSMENT INFORMATION4

 2.1 GENERAL4

 2.2 DATE OF TESTING.....6

 2.3 REPORT ISSUE DATE6

 2.4 TESTING FACILITIES6

 2.5 EQUIPMENT ASSESSED (EUT).....6

 2.6 EUT DESCRIPTION.....7

SECTION 3: RESULT SUMMARY.....10

 3.1 RESULTS SUMMARY TABLE10

SECTION 4: SAMPLE DETAILS.....12

APPENDIX A: EMISSION TEST RESULTS13

 CONDUCTED TEST SETUP DIAGRAM.....13

 TARGET MAXIMUM CHANNEL POWER13

 A.1 6dB BANDWIDTH14

 A.2 99% AND 26DB BANDWIDTH.....22

 A.3 MAXIMUM CONDUCTED OUTPUT POWER.....30

 A.4 POWER SPECTRAL DENSITY36

 A.4 CONDUCTED SPURIOUS EMISSIONS42

 A.5 CONDUCTED BANEDGE56

APPENDIX B: EMISSION TEST RESULTS.....63

 RADIATED EMISSION SETUP DIAGRAM-BELOW 1G63

 RADIATED EMISSION SETUP DIAGRAM-ABOVE 1G63

 B.1 RADIATED SPURIOUS EMISSIONS.....64

 B.2 RADIATED RECEIVER SPURIOUS EMISSIONS75

 B.3 RADIATED EMISSIONS 30MHZ TO 1GHZ.....80

 B.4 AC CONDUCTED EMISSIONS.....82

APPENDIX C: LIST OF TEST EQUIPMENT USED TO PERFORM THE TEST.....88

APPENDIX E: ABBREVIATION KEY AND DEFINITIONS90



Section 1: Overview

The samples were assessed against the tests detailed in section 3 under the requirements of the following specifications:

| |
|---|
| Specifications: |
| CFR47 Part 15.407 RSS-247 Issue 1: May 2015 RSS-Gen Issue 4: Nov 2014 |

Measurements were made in accordance with

- ANSI C63.10:2013
- KDB 789033 D02 General UNII Test Procedures New Rules v01r01
- KDB 662911 D01 Multiple Transmitter Output v02r01



Section 2: Assessment Information

2.1 General

This report contains an assessment of an apparatus against Electromagnetic Compatibility Standards based upon tests carried out on the samples submitted. The testing was performed by and for the use of Cisco systems Inc:

With regard to this assessment, the following points should be noted:

- a) The results contained in this report relate only to the items tested and were obtained in the period between the date of the initial assessment and the date of issue of the report. Manufactured products will not necessarily give identical results due to production and measurement tolerances.
- b) The apparatus was set up and exercised using the configuration and modes of operation defined in this report only.
- c) Where relevant, the apparatus was only assessed using the susceptibility criteria defined in this report and the Test Assessment Plan (TAP).
- d) All testing was performed under the following environmental conditions:

| | |
|----------------------|--------------------------------------|
| Temperature | 15°C to 35°C (54°F to 95°F) |
| Atmospheric Pressure | 860mbar to 1060mbar (25.4" to 31.3") |
| Humidity | 10% to 75*% |
- e) All AC testing was performed at one or more of the following supply voltages:
110V 60 Hz (+/-20%)

Units of Measurement

The units of measurements defined in the appendices are reported in specific terms, which are test dependent. Where radiated measurements are concerned these are defined at a particular distance. Basic voltage measurements are defined in units of [dBuV]

As an example, the basic calculation for all measurements is as follows:

$$\text{Emission level [dBuV]} = \text{Indicated voltage level [dBuV]} + \text{Cable Loss [dB]} + \text{Other correction factors [dB]}$$

The combinations of correction factors are dependent upon the exact test configurations [see test equipment lists for further details] and may include:-

Antenna Factors, Pre Amplifier Gain, LISN Loss, Pulse Limiter Loss and Filter Insertion Loss

Note: to convert the results from dBuV/m to uV/m use the following formula:-

$$\text{Level in uV/m} = \text{Common Antilogarithm } [(X \text{ dBuV/m})/20] = Y \text{ uV/m}$$



Measurement Uncertainty Values

| | |
|-----------------------------------|------------------------|
| voltage and power measurements | ± 2 dB |
| conducted EIRP measurements | ± 1.4 dB |
| radiated measurements | ± 3.2 dB |
| frequency measurements | ± 2.4 10 ⁻⁷ |
| temperature measurements | ± 0.54° |
| humidity measurements | ± 2.3% |
| DC and low frequency measurements | ± 2.5% |

Where relevant measurement uncertainty levels have been estimated for tests performed on the apparatus. This uncertainty represents an expanded uncertainty expressed at approximately the 95% confidence level using a coverage factor of k=2.

Radiated emissions (expanded uncertainty, confidence interval 95%)

| | |
|--------------------|------------|
| 30 MHz - 300 MHz | +/- 3.8 dB |
| 300 MHz - 1000 MHz | +/- 4.3 dB |
| 1 GHz - 10 GHz | +/- 4.0 dB |
| 10 GHz - 18GHz | +/- 8.2 dB |
| 18GHz - 26.5GHz | +/- 4.1 dB |
| 26.5GHz - 40GHz | +/- 3.9 dB |

Conducted emissions (expanded uncertainty, confidence interval 95%)

| | |
|----------------|-------------|
| 30 MHz – 40GHz | +/- 0.38 dB |
|----------------|-------------|

A product is considered to comply with a requirement if the nominal measured value is below the limit line. The product is considered to not be in compliance in case the nominal measured value is above the limit line.

This report must not be reproduced except in full, without written approval of Cisco Systems.

**2.2 Date of testing**

01-Jan-16 - 22-Feb-16

2.3 Report Issue Date

06-May-2012

Cisco uses an electronic system to issue, store and control the revision of test reports. This system is called the Engineering Document Control System (EDCS). The actual report issue date is embedded into the original file on EDCS. Any copies of this report, either electronic or paper, that are not on EDCS must be considered uncontrolled.

2.4 Testing facilities

This assessment was performed by:

Testing Laboratory

Cisco Systems, Inc.,
125 West Tasman Drive
San Jose, CA 95134, USA

Registration Numbers for Industry Canada

| Cisco System Site | Address | Site Identifier |
|--------------------------|---|------------------------|
| Building P, 10m Chamber | 125 West Tasman Dr San Jose, CA 95134 | Company #: 2461N-2 |
| Building P, 5m Chamber | 125 West Tasman Dr San Jose, CA 95134 | Company #: 2461N-1 |
| Building I, 5m Chamber | 285 W. Tasman Drive San Jose, California 95134 | Company #: 2461M-1 |

Test Engineers

Jose Aguirre

2.5 Equipment Assessed (EUT)

AIR-AP3802E-B-K9



2.6 EUT Description

The Cisco Aironet 802.11ac Radio supports the following modes of operation. The modes are further defined in the radio Theory of Operation. The modes included in this report represent the worst case data for all modes.

- 802.11n/ac - Non HT20, One Antenna, 6 to 54 Mbps
- 802.11n/ac - Non HT20, Two Antennas, 6 to 54 Mbps
- 802.11n/ac - Non HT20, Three Antennas, 6 to 54 Mbps
- 802.11n/ac - Non HT20, Four Antennas, 6 to 54 Mbps

- 802.11n/ac - Non HT20 Beam Forming, Two Antennas, 6 to 54 Mbps
- 802.11n/ac - Non HT20 Beam Forming, Three Antennas, 6 to 54 Mbps
- 802.11n/ac - Non HT20 Beam Forming, Four Antennas, 6 to 54 Mbps

- 802.11n/ac - HT/VHT20, One Antenna, M0 to M7
- 802.11n/ac - HT/VHT20, Two Antennas, M0 to M7
- 802.11n/ac - HT/VHT20, Two Antennas, M8 to M15
- 802.11n/ac - HT/VHT20, Three Antennas, M0 to M7
- 802.11n/ac - HT/VHT20, Three Antennas, M8 to M15
- 802.11n/ac - HT/VHT20, Three Antennas, M16 to M23
- 802.11n/ac - HT/VHT20, Four Antennas, M0 to M7
- 802.11n/ac - HT/VHT20, Four Antennas, M8 to M15
- 802.11n/ac - HT/VHT20, Four Antennas, M16 to M23

- 802.11n/ac - HT/VHT20 Beam Forming, Two Antennas, M0 to M7
- 802.11n/ac - HT/VHT20 Beam Forming, Two Antennas, M8 to M15
- 802.11n/ac - HT/VHT20 Beam Forming, Three Antennas, M0 to M7
- 802.11n/ac - HT/VHT20 Beam Forming, Three Antennas, M8 to M15
- 802.11n/ac - HT/VHT20 Beam Forming, Three Antennas, M16 to M23
- 802.11n/ac - HT/VHT20 Beam Forming, Four Antennas, M0 to M7
- 802.11n/ac - HT/VHT20 Beam Forming, Four Antennas, M8 to M15
- 802.11n/ac - HT/VHT20 Beam Forming, Four Antennas, M16 to M23

- 802.11n/ac - HT/VHT20 STBC, Two Antennas, M0 to M7
- 802.11n/ac - HT/VHT20 STBC, Three Antennas, M0 to M7
- 802.11n/ac - HT/VHT20 STBC, Four Antennas, M0 to M7

- 802.11n/ac - Non HT40 Duplicate, One Antenna, 6 to 54 Mbps
- 802.11n/ac - Non HT40 Duplicate, Two Antennas, 6 to 54 Mbps
- 802.11n/ac - Non HT40 Duplicate, Three Antennas, 6 to 54 Mbps
- 802.11n/ac - Non HT40 Duplicate, Four Antennas, 6 to 54 Mbps

- 802.11n/ac - HT/VHT40, One Antenna, M0 to M7
- 802.11n/ac - HT/VHT40, Two Antennas, M0 to M7
- 802.11n/ac - HT/VHT40, Two Antennas, M8 to M15
- 802.11n/ac - HT/VHT40, Three Antennas, M0 to M7
- 802.11n/ac - HT/VHT40, Three Antennas, M8 to M15
- 802.11n/ac - HT/VHT40, Three Antennas, M16 to M23
- 802.11n/ac - HT/VHT40, Four Antennas, M0 to M7
- 802.11n/ac - HT/VHT40, Four Antennas, M8 to M15
- 802.11n/ac - HT/VHT40, Four Antennas, M16 to M23



802.11n/ac - HT/VHT40 Beam Forming, Two Antennas, M0 to M7
802.11n/ac - HT/VHT40 Beam Forming, Two Antennas, M8 to M15
802.11n/ac - HT/VHT40 Beam Forming, Three Antennas, M0 to M7
802.11n/ac - HT/VHT40 Beam Forming, Three Antennas, M8 to M15
802.11n/ac - HT/VHT40 Beam Forming, Three Antennas, M16 to M23
802.11n/ac - HT/VHT40 Beam Forming, Four Antennas, M0 to M7
802.11n/ac - HT/VHT40 Beam Forming, Four Antennas, M8 to M15
802.11n/ac - HT/VHT40 Beam Forming, Four Antennas, M16 to M23

802.11n/ac - HT/VHT40 STBC, Two Antennas, M0 to M7
802.11n/ac - HT/VHT40 STBC, Three Antennas, M0 to M7
802.11n/ac - HT/VHT40 STBC, Four Antennas, M0 to M7

802.11n/ac - Non HT80 Duplicate, One Antenna, 6 to 54 Mbps
802.11n/ac - Non HT80 Duplicate, Two Antennas, 6 to 54 Mbps
802.11n/ac - Non HT80 Duplicate, Three Antennas, 6 to 54 Mbps
802.11n/ac - Non HT80 Duplicate, Four Antennas, 6 to 54 Mbps

802.11ac - VHT80, One Antenna, M0.1 to M9.1
802.11ac - VHT80, Two Antennas, M0.1 to M9.1
802.11ac - VHT80, Two Antennas, M0.2 to M9.2
802.11ac - VHT80, Three Antennas, M0.1 to M9.1
802.11ac - VHT80, Three Antennas, M0.2 to M9.2
802.11ac - VHT80, Three Antennas, M0.3 to M9.3
802.11ac - VHT80, Four Antennas, M0.1 to M9.1
802.11ac - VHT80, Four Antennas, M0.2 to M9.2
802.11ac - VHT80, Four Antennas, M0.3 to M9.3

802.11ac - VHT80 Beam Forming, Two Antennas, M0.1 to M9.1
802.11ac - VHT80 Beam Forming, Two Antennas, M0.2 to M9.2
802.11ac - VHT80 Beam Forming, Three Antennas, M0.1 to M9.1
802.11ac - VHT80 Beam Forming, Three Antennas, M0.2 to M9.2
802.11ac - VHT80 Beam Forming, Three Antennas, M0.3 to M9.3
802.11ac - VHT80 Beam Forming, Four Antennas, M0.1 to M9.1
802.11ac - VHT80 Beam Forming, Four Antennas, M0.2 to M9.2
802.11ac - VHT80 Beam Forming, Four Antennas, M0.3 to M9.3

802.11ac - VHT80 STBC, Two Antennas, M0.1 to M9.1
802.11ac - VHT80 STBC, Three Antennas, M0.1 to M9.1
802.11ac - VHT80 STBC, Four Antennas, M0.1 to M9.1



The following antennas are supported by this product series.
The data included in this report represent the worst case data for all antennas.

| Frequency | Part Number | Antenna Type | Antenna Gain (dBi) | Model |
|--------------------|------------------|--|--------------------|-------------|
| 5 GHz | AIR-ANT5140V-R | MIMO 3-Element Omni | 4 | 3800E |
| | AIR-ANT5140NV-R | MIMO Wall-Mount Omni Antenna | 4 | 3800E |
| | AIR-ANT5145V-R | Diversity Omni-directional | 4.5 | 3800E |
| | AIR-ANT5160NP-R | MIMO 3-Element Patch | 6 | 3800E |
| 2.4 / 5 GHz | AIR-ANT2451V-R | Omni | 2 / 3 | 3800E |
| | AIR-ANT2451NV-R | Omni | 3 / 4 | 3800E |
| | AIR-ANT2524DB-R | Dual-resonant black dipole | 2 / 4 | 2800E/3800E |
| | AIR-ANT2524DW-R | Dual-resonant white dipole | 2 / 4 | 2800E/3800E |
| | AIR-ANT2524DG-R | Dual-resonant gray dipole | 2 / 4 | 2800E/3800E |
| | AIR-ANT2524V4C-R | Dual-resonant ceiling mount omni (4-pack) | 2 / 4 | 2800E/3800E |
| | AIR-ANT2535SDW-R | Dual-resonant "stubby" monopole | 3 / 5 | 2800E/3800E |
| | AIR-ANT2544V4M-R | Dual-resonant omni (4-pack) | 4 / 4 | 2800E/3800E |
| | AIR-ANT2566P4W-R | Dual-resonant "directional" antenna (4-pack) | 6 / 6 | 2800E/3800E |
| | AIR-ANT25-LOC-02 | Directional HL / Directional WiFi | 4 / 4 | 2800E/3800E |
| | AIR-ANT25-LOC-03 | Linear HL / Omni WiFi | 1 / 3 | 2800E/3800E |
| | AIR-ANT25-LOC-04 | Omni HL / Omni WiFi | 1 / 3 | 2800E/3800E |

Section 3: Result Summary

3.1 Results Summary Table

Conducted emissions

| Basic Standard | Technical Requirements / Details | Result |
|--|--|--------|
| FCC 15.407 RSS-247 | 6dB Bandwidth: Systems using digital modulation techniques may operate in the 2400-2483.5MHz band. The minimum 6dB bandwidth shall be at least 500 kHz. | Pass |
| FCC 15.407 RSS-247 | 99% & 26 dB Bandwidth: The 99% occupied bandwidth is the frequency bandwidth such that, below its lower and above its upper frequency limits, the mean powers are each equal to 0.5% of the total mean power of the given emission. There is no limit for 99% OBW. The 26 dB emission is the width of the emission that is constrained by the frequencies associated with the two outermost amplitude points (upper and lower frequencies) that are attenuated by 26 dB relative to the maximum level measured in the fundamental emission. | Pass |
| FCC 15.407 RSS-247 | Output Power: For the band 5.725-5.85 GHz, the maximum conducted output power over the frequency band of operation shall not exceed 1 W. | Pass |
| FCC 15.407 RSS-247 | Power Spectral Density: 15.407 The maximum power spectral density shall not exceed 30 dBm in any 500-kHz band. | Pass |
| FCC 15.407 RSS-247 | Conducted Spurious Emissions / Band-Edge: For transmitters operating in the 5.725-5.85 GHz band: All emissions within the frequency range from the band edge to 10 MHz above or below the band edge shall not exceed an e.i.r.p. of -17 dBm/MHz; for frequencies 10 MHz or greater above or below the band edge, emissions shall not exceed an e.i.r.p. of -27 dBm/MHz. | Pass |
| FCC 15.407 FCC 15.209 FCC 152.05 RSS-247 RSS-Gen | Restricted band: Unwanted emissions falling within the restricted bands, as defined in FCC 15.205 (a) must also comply with the radiated emission limits specified in FCC 15.209 (a). | Pass |



Radiated Emissions (General requirements)

| Basic Standard | Technical Requirements / Details | Result |
|---|---|--------|
| FCC 15.407 FCC 15.209 FCC 15.205 RSS-Gen | <p>TX Spurious Emissions: Except as provided elsewhere in this subpart, the emissions from an intentional radiator shall not exceed the field strength levels specified in the filed strength limits table in this section.</p> | Pass |
| FCC 15.207 RSS-Gen | <p>AC conducted Emissions: Except when the requirements applicable to a given device state otherwise, for any radio apparatus equipped to operate from the public utility AC power supply, either directly or indirectly (such as with a battery charger), the radio frequency voltage of emissions conducted back onto the AC power lines in the frequency range of 0.15 MHz to 30 MHz shall not exceed the limits shown in the table in these sections. The more stringent limit applies at the frequency range boundaries.</p> | Pass |

* MPE calculation is recorded in a separate report



Section 4: Sample Details

Note: Each sample was evaluated to ensure that its condition was suitable to be used as a test sample prior to the commencement of testing.

4.1 Sample Details

| Sample No. | Equipment Details | Manufacturer | Hardware Rev. | Firmware Rev. | Software Rev. | Serial Number |
|------------|------------------------------|---------------|---------------|-------------------|---------------|--------------------|
| S01 | AIR-AP3802E-B-K9 | Cisco Systems | 01 | Linux ver 3.14.33 | U-boot | FOC1945132D |
| S02* | PWR-CUBE-B 341-100460-001 | Delta | A0 | NA | NA | Engineering sample |

(*) S02 are support equipment Power supplies for EUT S01

4.2 System Details

| System # | Description | Samples |
|----------|------------------|---------|
| 1 | AIR-AP3802E-B-K9 | S01 |
| 2 | PWR-CUBE-B | S02 |

4.3 Mode of Operation Details

| Mode# | Description | Comments |
|-------|-------------------------|--|
| 1 | Continuous Transmitting | Continuous Transmitting $\geq 98\%$ duty cycle |

All measurements were made in accordance with

- ANSI C63.10:2013
- KDB 789033 D02 General UNII Test Procedures New Rules v01r01
- KDB 662911 D01 Multiple Transmitter Output v02r01

Appendix A: Emission Test Results

Conducted Test Setup Diagram

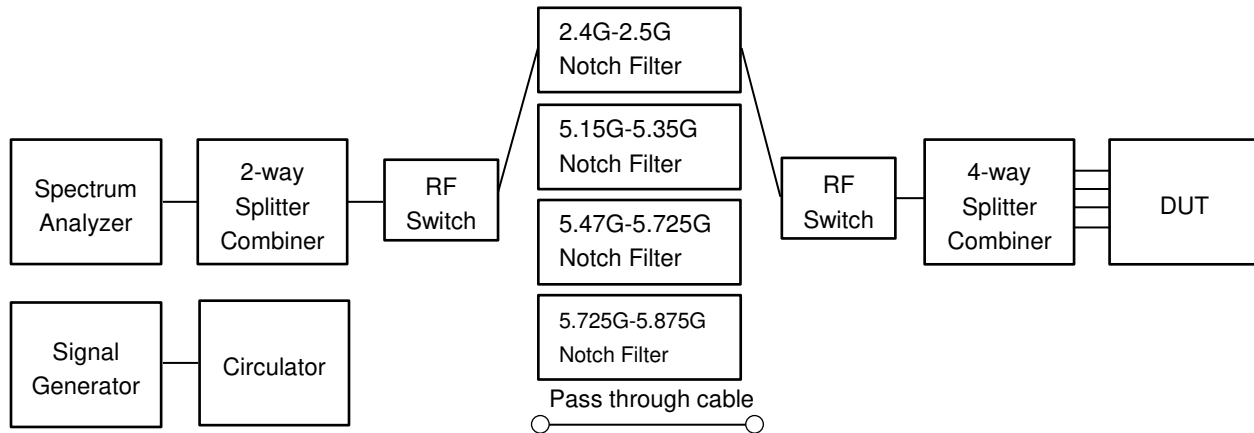

Target Maximum Channel Power

The following table details the maximum supported Total Channel Power for all operating modes.

| Operating Mode | Maximum Channel Power (dBm) | | |
|--|-----------------------------|------|------|
| | Frequency (MHz) | | |
| | 5745 | 5785 | 5825 |
| Non HT20, 6 to 54 Mbps | 15 | 21 | 16 |
| Non HT20 Beam Forming, 6 to 54 Mbps | 11 | 21 | 12 |
| HT/VHT20, M0 to M23, M0 to M9 1-0ss | 15 | 21 | 16 |
| HT/VHT20 Beam Forming, M0 to M23, M0 to M9 1-0ss | 15 | 21 | 16 |
| HT/VHT20 STBC, M0 to M7 | 15 | 21 | 16 |
| | 5755 | 5795 | |
| Non HT40, 6 to 54 Mbps | 7 | 20 | |
| HT/VHT40, M0 to M23, M0 to M9 1-0ss | 11 | 21 | |
| HT/VHT40 Beam Forming, M0 to M23, M0 to M9 1-0ss | 11 | 21 | |
| HT/VHT40 STBC, M0 to M7 | 11 | 21 | |
| | 5775 | | |
| Non HT80, 6 to 54 Mbps | 14 | | |
| VHT80, M0 to M9, M0 to M9 1-0ss | 13 | | |
| VHT80 Beam Forming, M0 to M9, M0 to M9 1-0ss | 13 | | |
| VHT80 STBC, M0.1 to M9.1 | 13 | | |



A.1 6dB Bandwidth

15.407 Within the 5.725-5.85 GHz band, the minimum 6 dB bandwidth of U-NII devices shall be at least 500 kHz.

Test Procedure

Ref. KDB 789033 D02 General UNII Test Procedures New Rules v01r01
ANSI C63.10: 2013

| |
|--|
| <p>6 BW Test Procedure</p> <ol style="list-style-type: none"> 1. Set the radio in the continuous transmitting mode. 2. Allow the trace to stabilize. 3. Setting the x-dB bandwidth mode to -6dB within the measurement set up function. 4. Select the automatic OBW measurement function of an instrument to perform bandwidth measurement. 5. Capture graphs and record pertinent measurement data. |
|--|

Ref. KDB 789033 D02 General UNII Test Procedures New Rules v01r01
ANSI C63.10: 2013 section 11.8.2 Option 2

| |
|---|
| <p>6 BW Test parameters</p> <p>X dB BW = 6dB (using the OBW function of the spectrum analyzer) Span = Large enough to capture the entire EBW RBW = 100 KHz VBW ≥ 3 x RBW Sweep = Auto couple Detector = Peak or where practical sample shall be used Trace = Max. Hold</p> |
|---|

| System Number | Description | Samples | System under test | Support equipment |
|---------------|-------------|---------|-------------------------------------|-------------------------------------|
| 1 | EUT | S01 | <input checked="" type="checkbox"/> | <input type="checkbox"/> |
| | Support | S02 | <input type="checkbox"/> | <input checked="" type="checkbox"/> |

| | |
|--|--|
| <p>Tested By : Jose Aguirre</p> | <p>Date of testing: 01-Jan-16 - 22-Feb-16</p> |
| <p>Test Result : PASS</p> | |

See Appendix C for list of test equipment



| Frequency (MHz) | Mode | Data Rate (Mbps) | 6dB BW (MHz) | Limit (kHz) | Margin (MHz) |
|-----------------|-------------------------------------|------------------|--------------|-------------|--------------|
| 5745 | Non HT20, 6 to 54 Mbps | 6 | 16.4 | >500 | 15.9 |
| | HT/VHT20, M0 to M23, M0 to M9 1-0ss | m0 | 17.4 | >500 | 16.9 |
| 5755 | Non HT40, 6 to 54 Mbps | 6 | 35.6 | >500 | 35.1 |
| | HT/VHT40, M0 to M23, M0 to M9 1-0ss | m0 | 35.5 | >500 | 35.0 |
| 5775 | Non HT80, 6 to 54 Mbps | 6 | 76.1 | >500 | 75.6 |
| | VHT80, M0 to M9, M0 to M9 1-0ss | m0x1 | 76.0 | >500 | 75.5 |
| 5785 | Non HT20, 6 to 54 Mbps | 6 | 16.4 | >500 | 15.9 |
| | HT/VHT20, M0 to M23, M0 to M9 1-0ss | m0 | 17.6 | >500 | 17.1 |
| 5795 | Non HT40, 6 to 54 Mbps | 6 | 36.1 | >500 | 35.6 |
| | HT/VHT40, M0 to M23, M0 to M9 1-0ss | m0 | 35.6 | >500 | 35.1 |
| 5825 | Non HT20, 6 to 54 Mbps | 6 | 16.4 | >500 | 15.9 |
| | HT/VHT20, M0 to M23, M0 to M9 1-0ss | m0 | 17.5 | >500 | 17.0 |



6dB Bandwidth, 5745 MHz, Non HT20, 6 to 54 Mbps

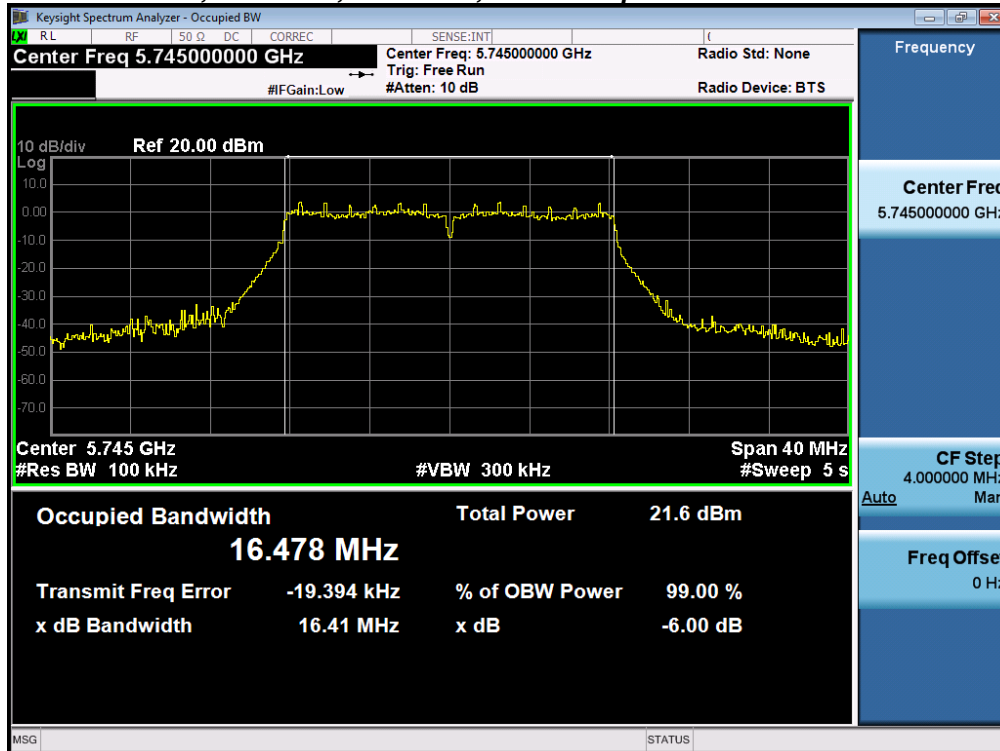

6dB Bandwidth, 5745 MHz, HT/VHT20, M0 to M23, M0 to M9 1-0ss





6dB Bandwidth, 5755 MHz, Non HT40, 6 to 54 Mbps

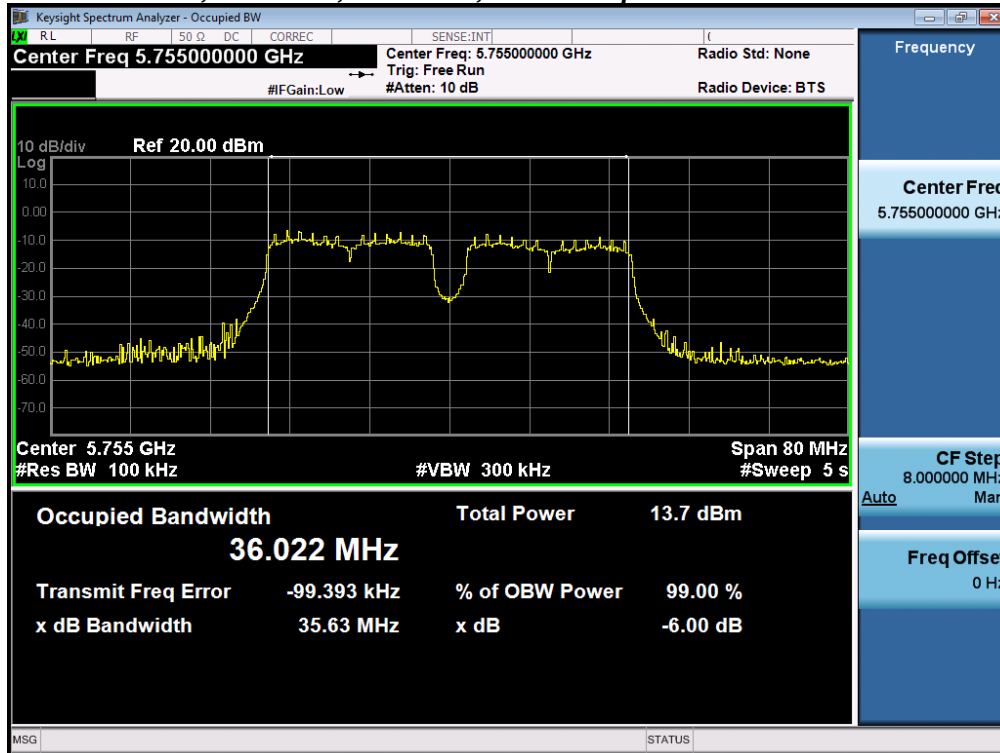

6dB Bandwidth, 5755 MHz, HT/VHT40, M0 to M23, M0 to M9 1-0ss

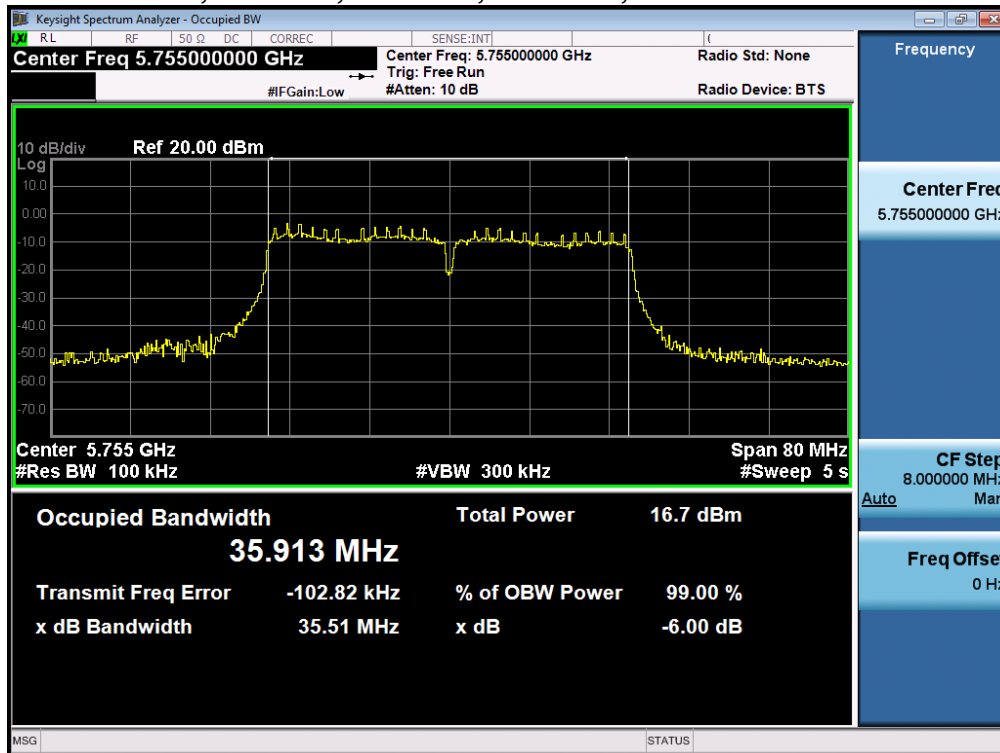



6dB Bandwidth, 5775 MHz, Non HT80, 6 to 54 Mbps

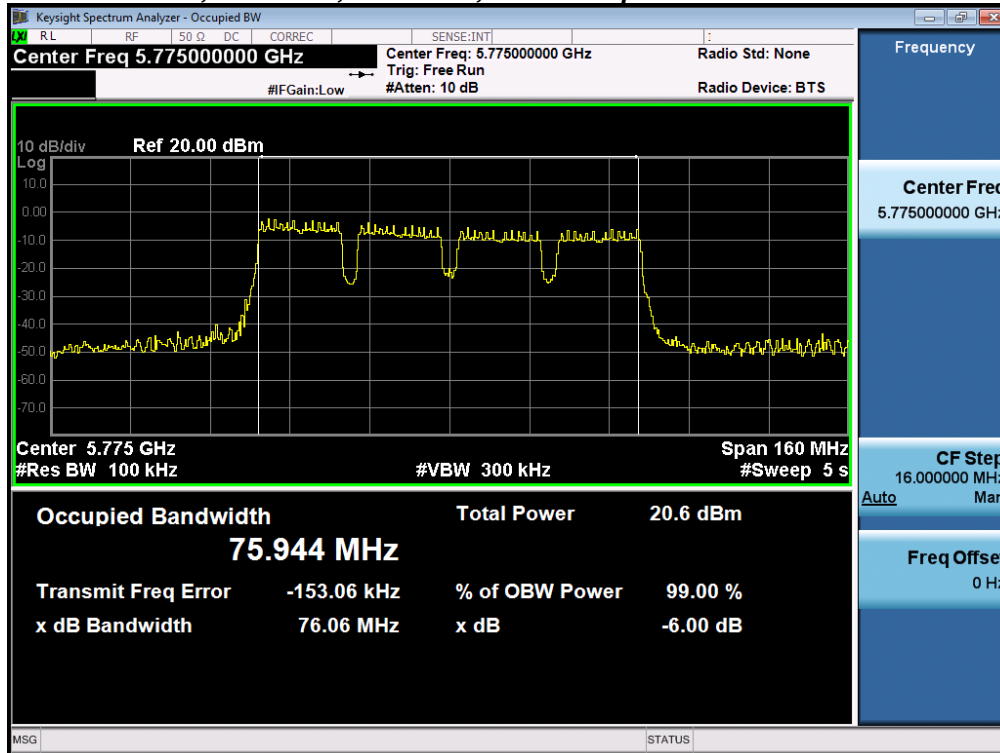

6dB Bandwidth, 5775 MHz, VHT80, M0 to M9, M0 to M9 1-0ss

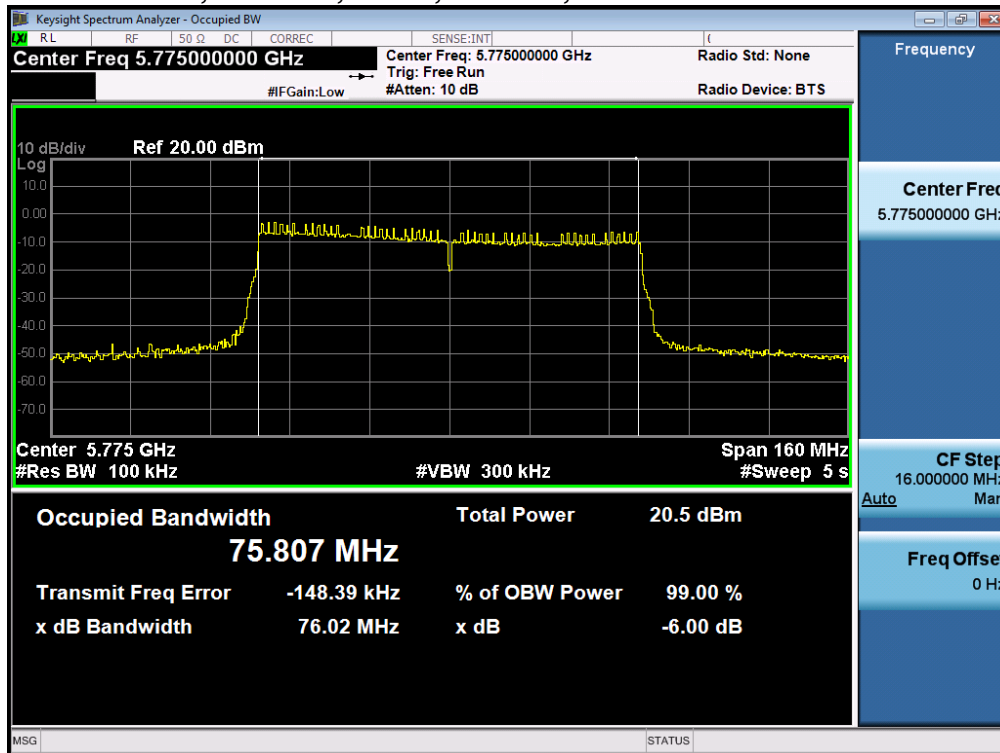



6dB Bandwidth, 5785 MHz, Non HT20, 6 to 54 Mbps

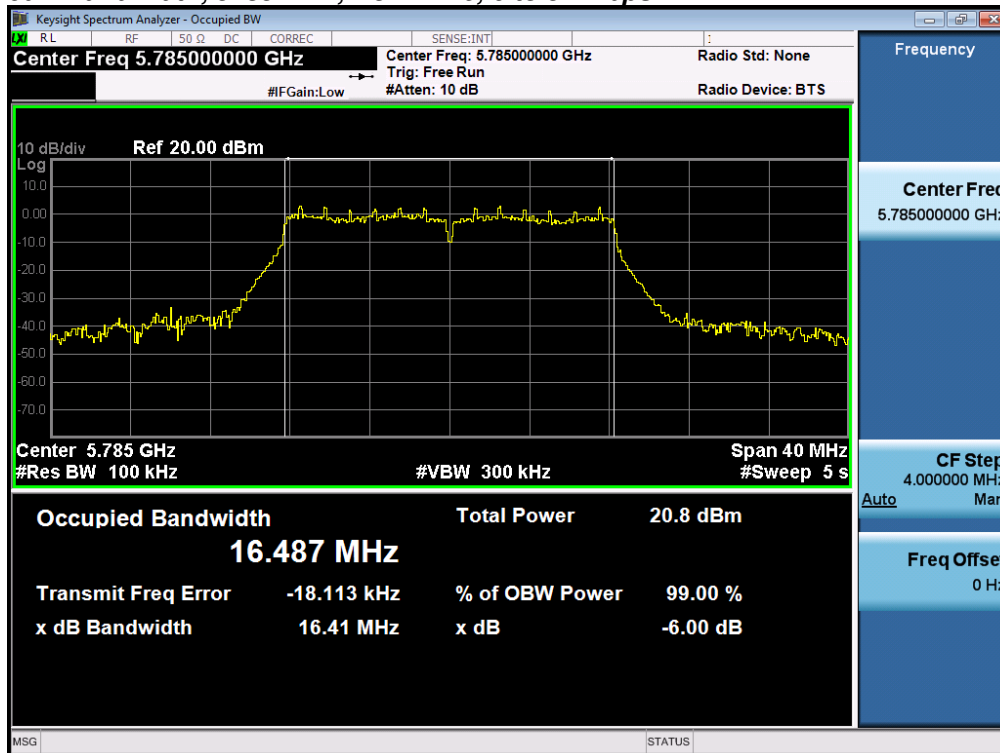

6dB Bandwidth, 5785 MHz, HT/VHT20, M0 to M23, M0 to M9 1-0ss

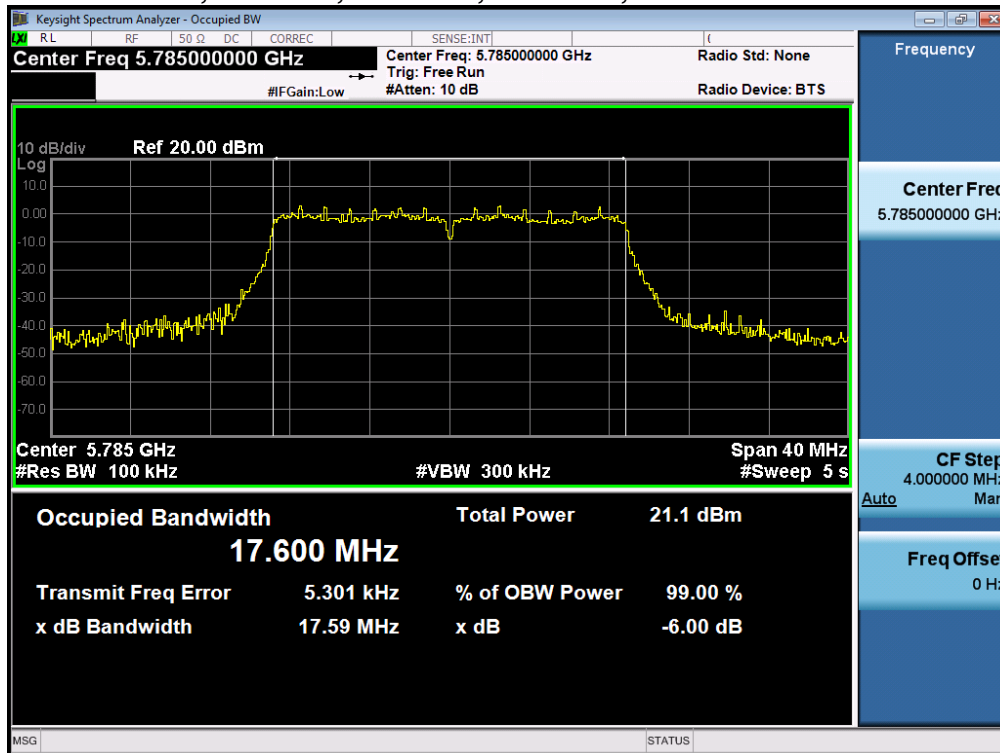



6dB Bandwidth, 5795 MHz, Non HT40, 6 to 54 Mbps

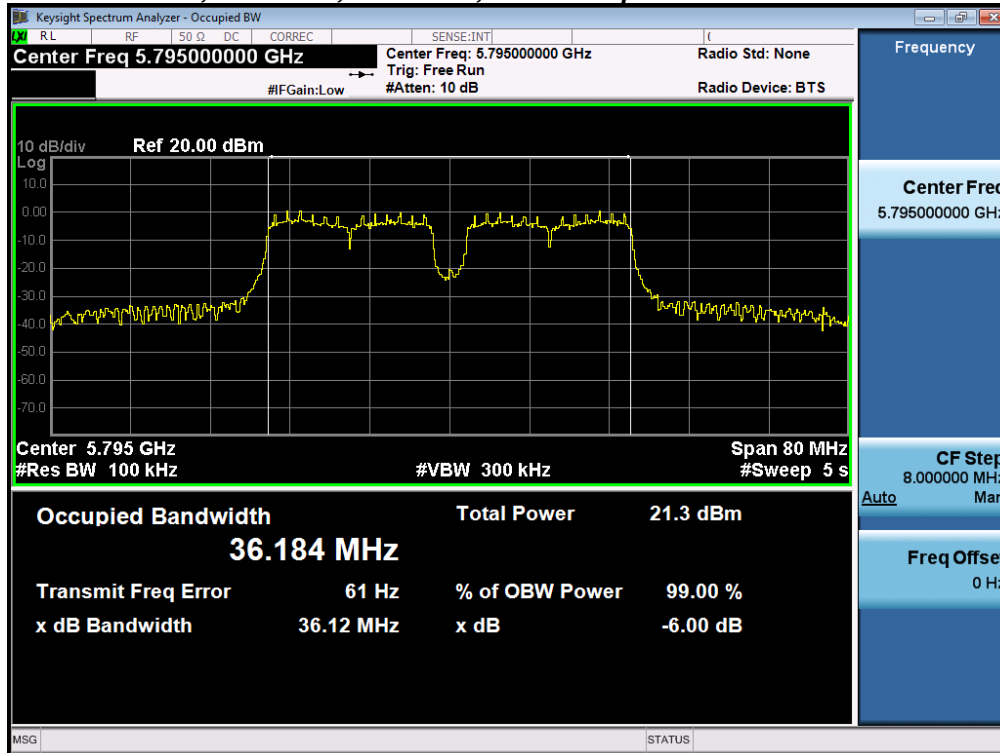

6dB Bandwidth, 5795 MHz, HT/VHT40, M0 to M23, M0 to M9 1-0ss

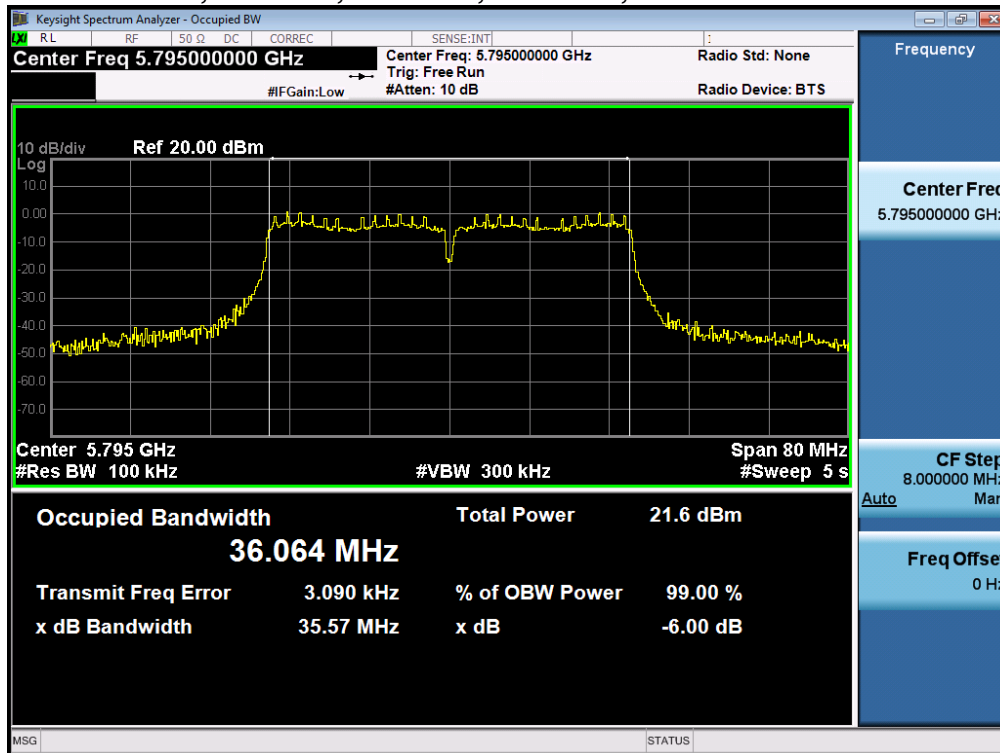



6dB Bandwidth, 5825 MHz, Non HT20, 6 to 54 Mbps

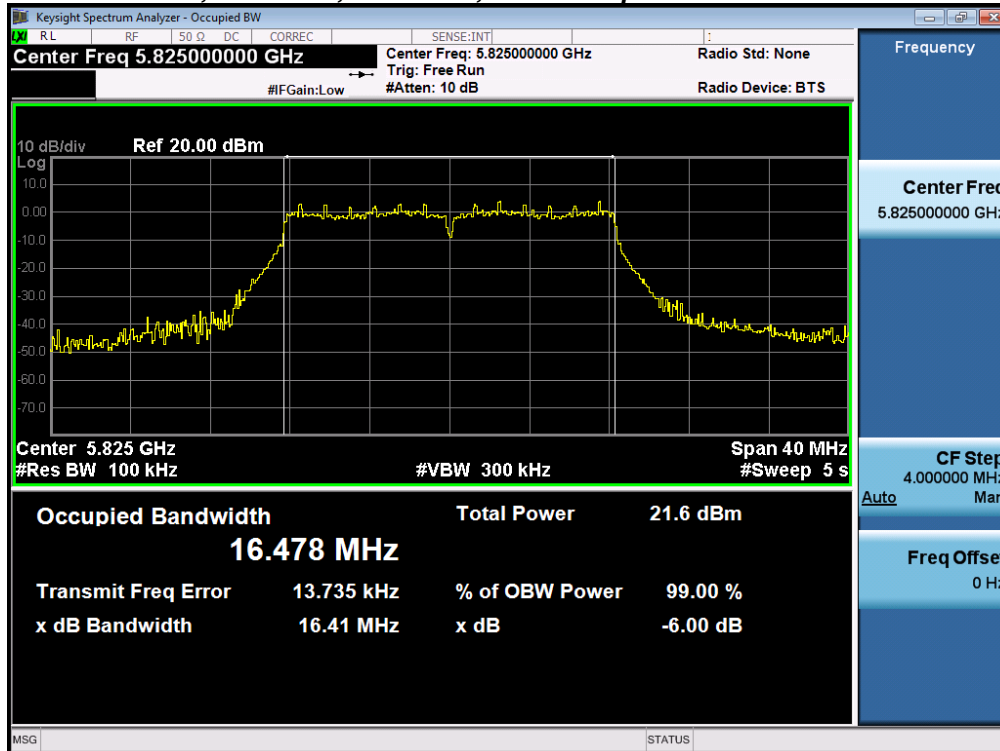

6dB Bandwidth, 5825 MHz, HT/VHT20, M0 to M23, M0 to M9 1-0ss

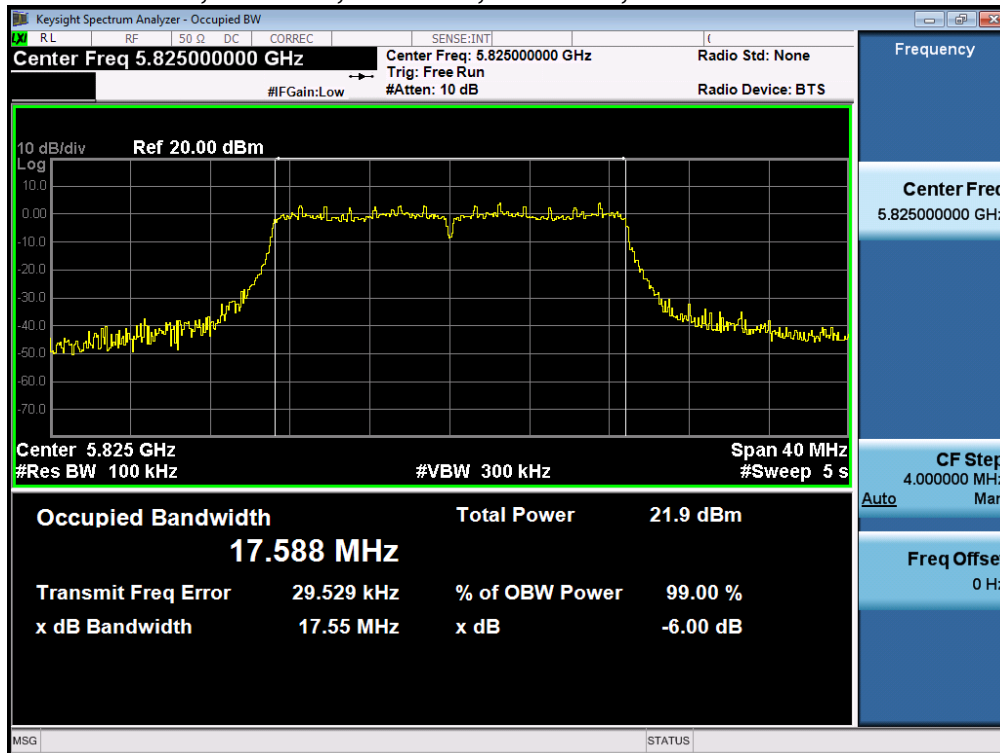



A.2 99% and 26dB Bandwidth

FCC 15.407 The 99% occupied bandwidth is the frequency bandwidth such that, below its lower and above its upper frequency limits, the mean powers are each equal to 0.5% of the total mean power of the given emission. There is no limit for 99% OBW.

The 26 dB emission is the width of the emission that is constrained by the frequencies associated with the two outermost amplitude points (upper and lower frequencies) that are attenuated by 26 dB relative to the maximum level measured in the fundamental emission.

Test Procedure

Ref. ANSI C63.10: 2013 Section 6.9.3

99% BW and EBW (-26dB)

Test Procedure

1. Set the radio in the continuous transmitting mode.
2. Allow the trace to stabilize.
3. Setting the x-dB bandwidth mode to -26dB and OBW power function to 99% within the measurement set up function.
4. Select the automatic OBW measurement function of an instrument to perform bandwidth measurement.
5. Capture graphs and record pertinent measurement data.

Ref. ANSI C63.10: 2013 Section 6.9.3

99% BW and EBW (-26dB)

Test parameters

Span = 1.5 x to 5.0 times OBW
 RBW = approx. 1% to 5% of the OBW
 VBW ≥ 3 x RBW
 Detector = Peak or where practical sample shall be used
 Trace = Max. Hold

| System Number | Description | Samples | System under test | Support equipment |
|---------------|-------------|---------|-------------------------------------|-------------------------------------|
| 1 | EUT | S01 | <input checked="" type="checkbox"/> | <input type="checkbox"/> |
| | Support | S02 | <input type="checkbox"/> | <input checked="" type="checkbox"/> |

| | |
|------------------------------------|--|
| Tested By : Jose Aguirre | Date of testing: 01-Jan-16 - 22-Feb-16 |
| Test Result : PASS | |

See Appendix C for list of test equipment



| Frequency (MHz) | Mode | Data Rate (Mbps) | 26dB BW (MHz) | 99% BW (MHz) |
|-----------------|-------------------------------------|------------------|---------------|--------------|
| 5745 | Non HT20, 6 to 54 Mbps | 6 | 23.3 | 18.0 |
| | HT/VHT20, M0 to M23, M0 to M9 1-0ss | m0 | 23.9 | 18.3 |
| 5755 | Non HT40, 6 to 54 Mbps | 6 | 44.4 | 36.9 |
| | HT/VHT40, M0 to M23, M0 to M9 1-0ss | m0 | 43.4 | 36.5 |
| 5775 | Non HT80, 6 to 54 Mbps | 6 | 83.9 | 76.6 |
| | VHT80, M0 to M9, M0 to M9 1-0ss | m0x1 | 82.6 | 76.7 |
| 5785 | Non HT20, 6 to 54 Mbps | 6 | 24.4 | 23.4 |
| | HT/VHT20, M0 to M23, M0 to M9 1-0ss | m0 | 23.8 | 23.1 |
| 5795 | Non HT40, 6 to 54 Mbps | 6 | 58.1 | 62.8 |
| | HT/VHT40, M0 to M23, M0 to M9 1-0ss | m0 | 46.0 | 45.3 |
| 5825 | Non HT20, 6 to 54 Mbps | 6 | 21.5 | 23.2 |
| | HT/VHT20, M0 to M23, M0 to M9 1-0ss | m0 | 23.5 | 24.3 |



26dB / 99% Bandwidth, 5745 MHz, Non HT20, 6 to 54 Mbps

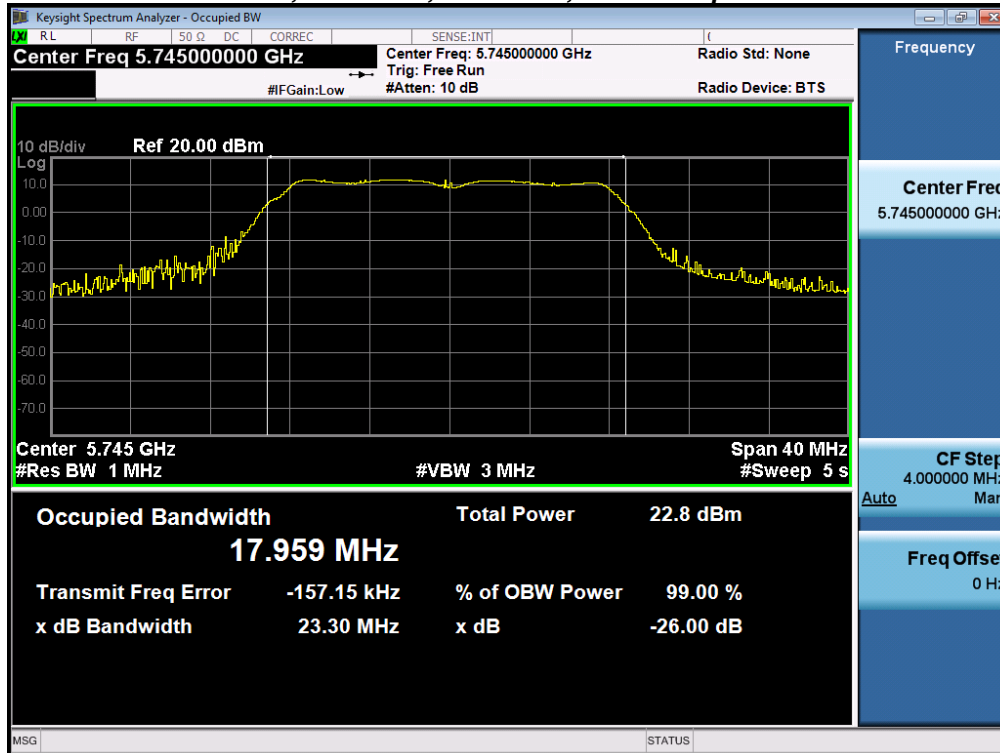

26dB / 99% Bandwidth, 5745 MHz, HT/VHT20, M0 to M23, M0 to M9 1-0ss

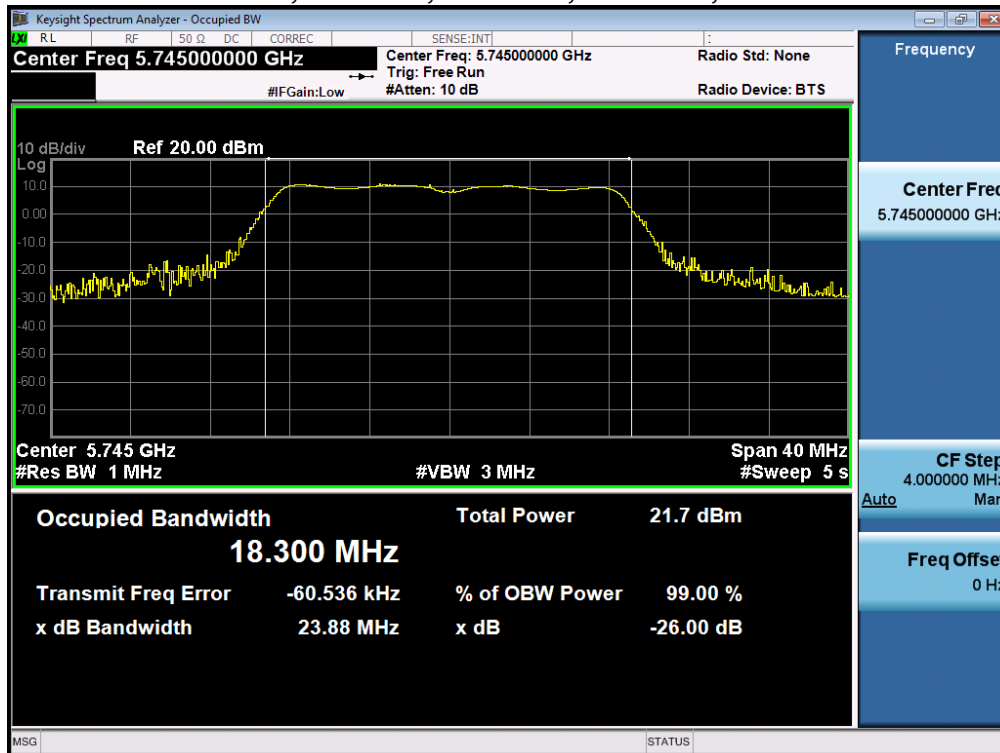



26dB / 99% Bandwidth, 5755 MHz, Non HT40, 6 to 54 Mbps

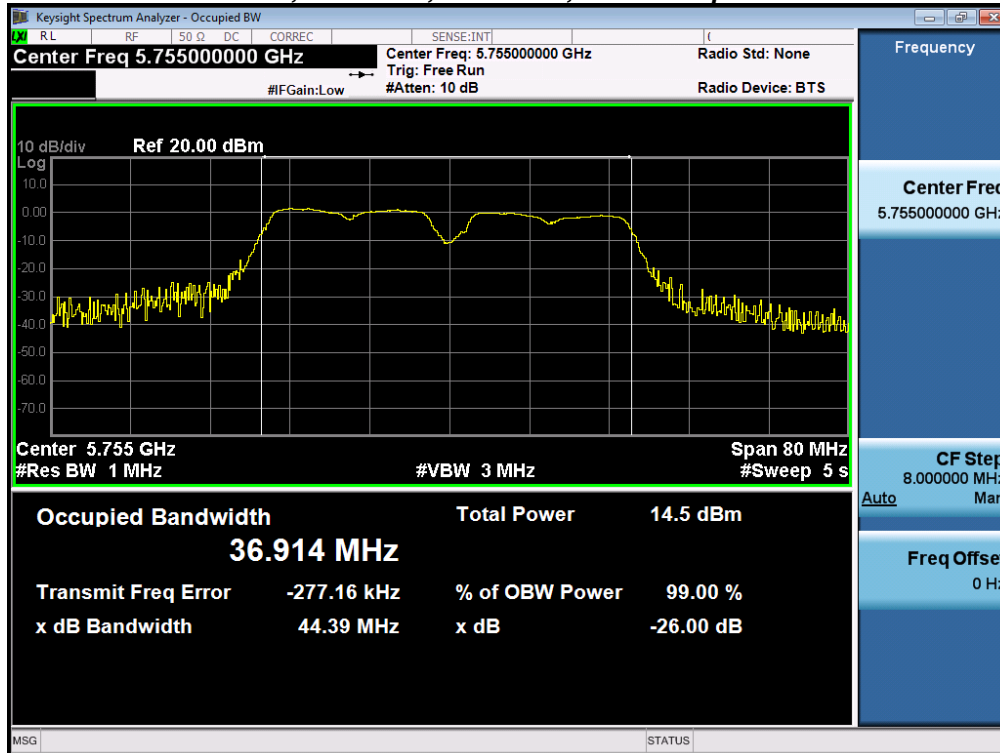

26dB / 99% Bandwidth, 5755 MHz, HT/VHT40, M0 to M23, M0 to M9 1-0ss

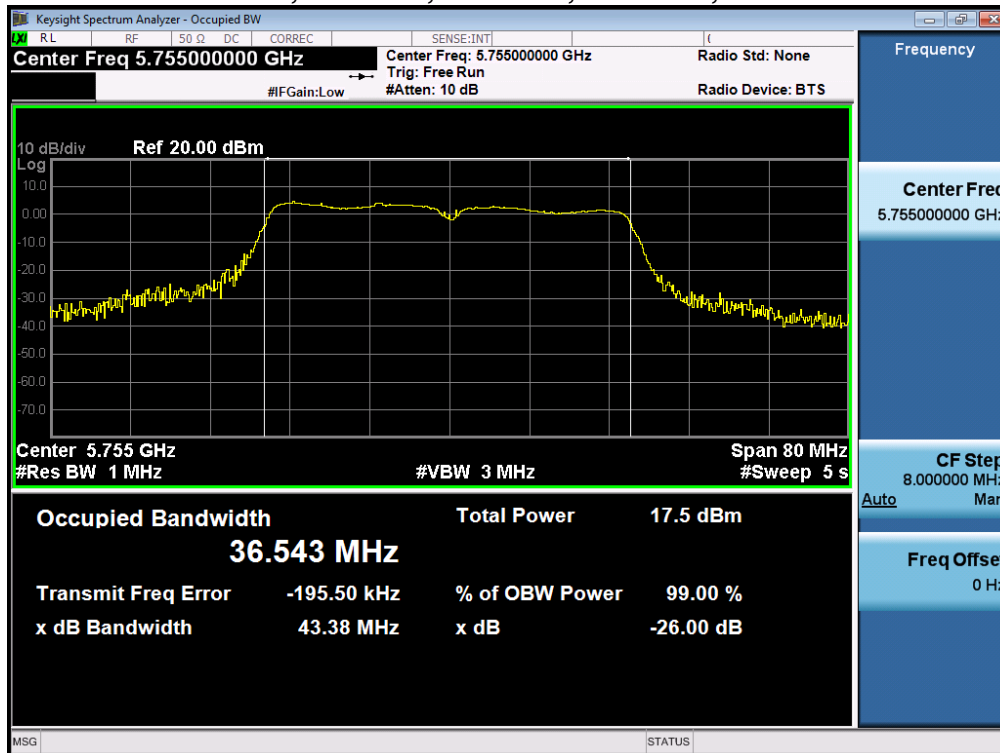



26dB / 99% Bandwidth, 5775 MHz, Non HT80, 6 to 54 Mbps

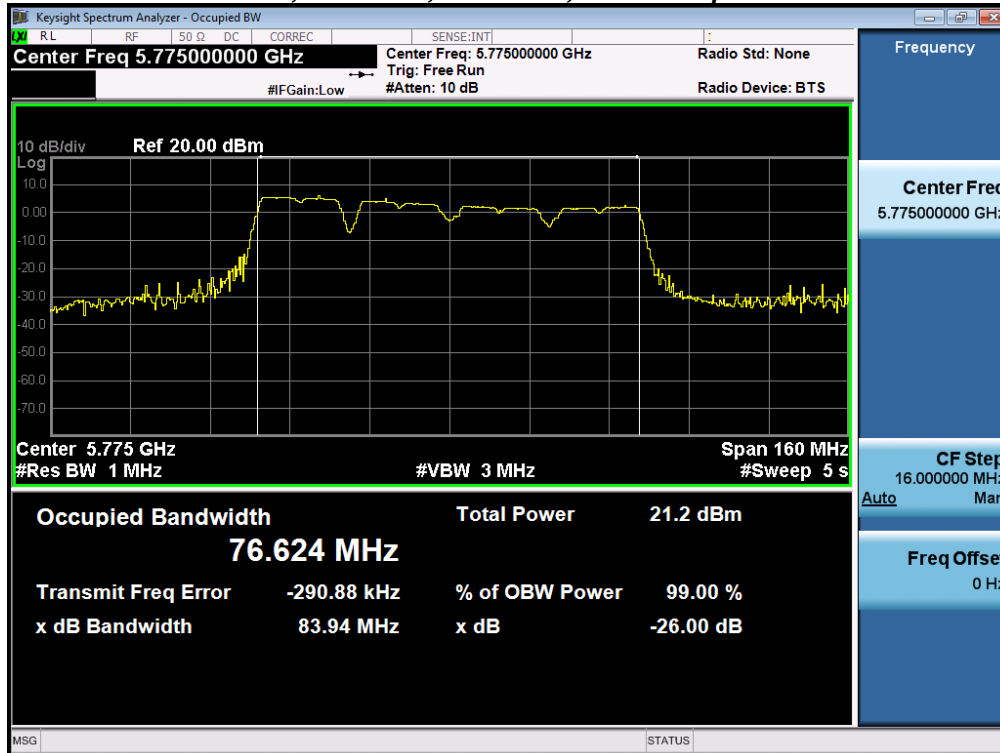

26dB / 99% Bandwidth, 5775 MHz, VHT80, M0 to M9, M0 to M9 1-0ss

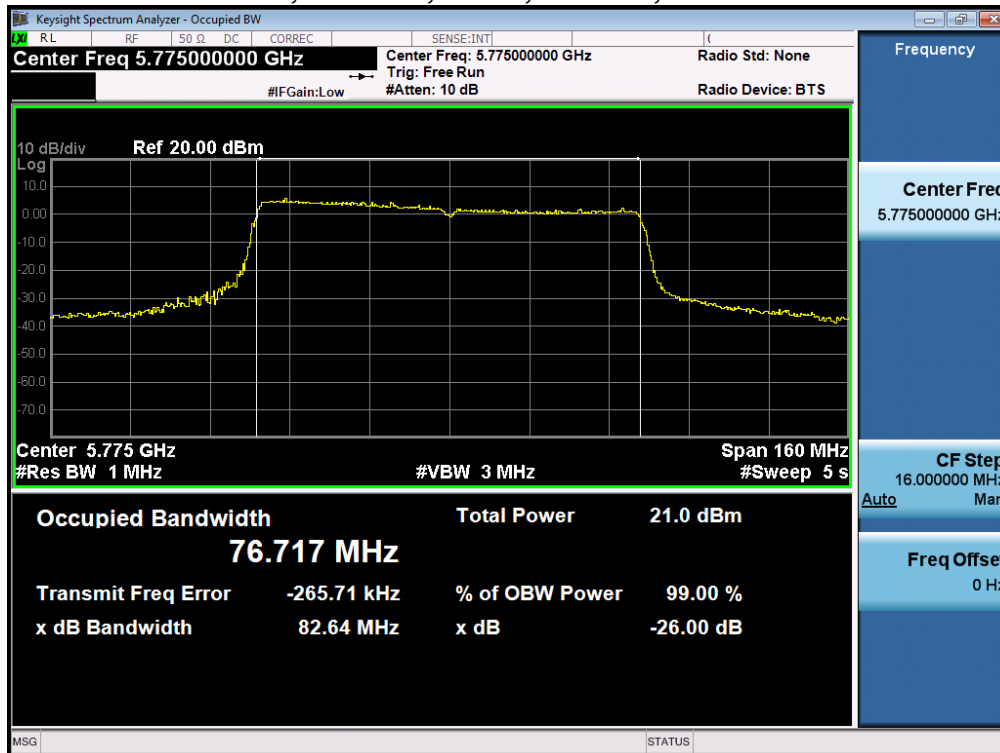



26dB / 99% Bandwidth, 5785 MHz, Non HT20, 6 to 54 Mbps

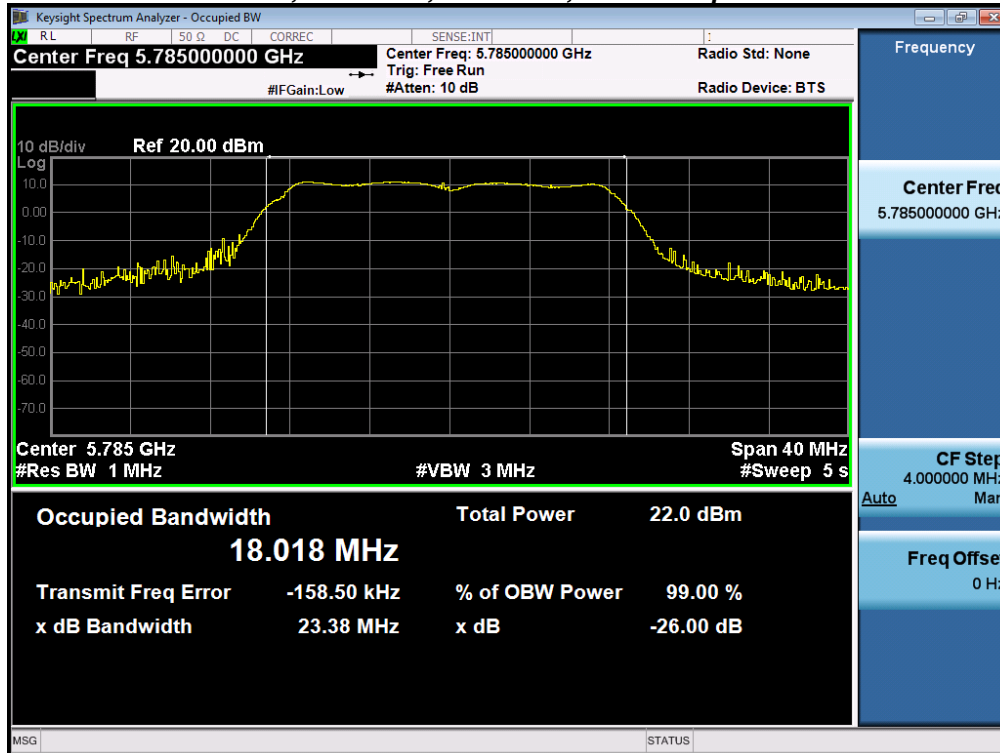

26dB / 99% Bandwidth, 5785 MHz, HT/VHT20, M0 to M23, M0 to M9 1-0ss

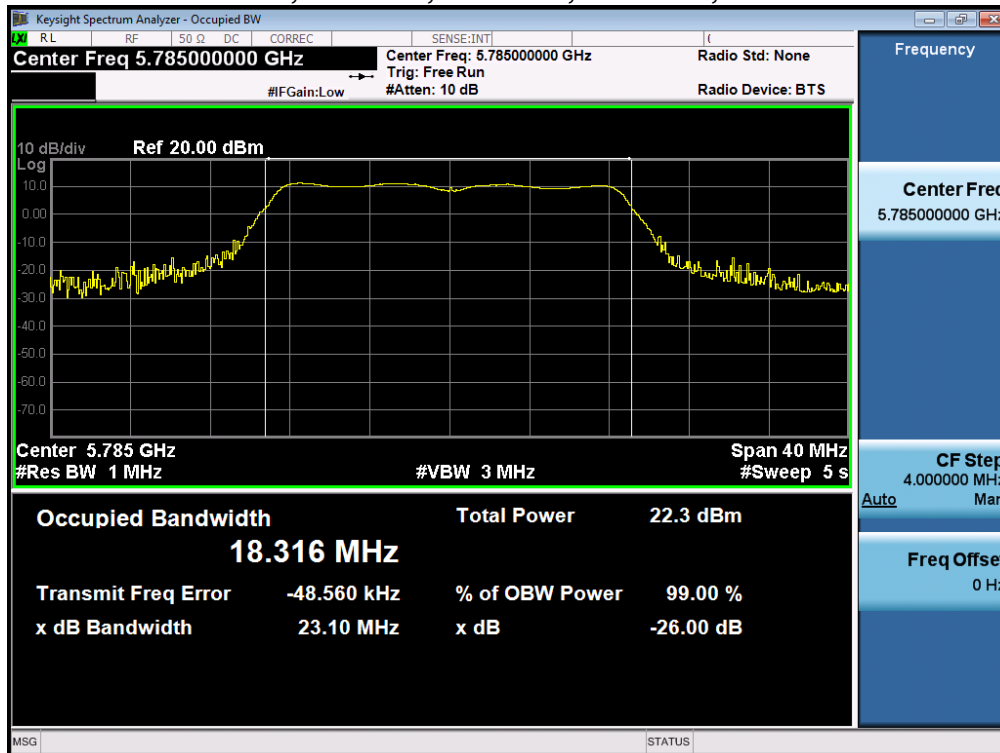



26dB / 99% Bandwidth, 5795 MHz, Non HT40, 6 to 54 Mbps

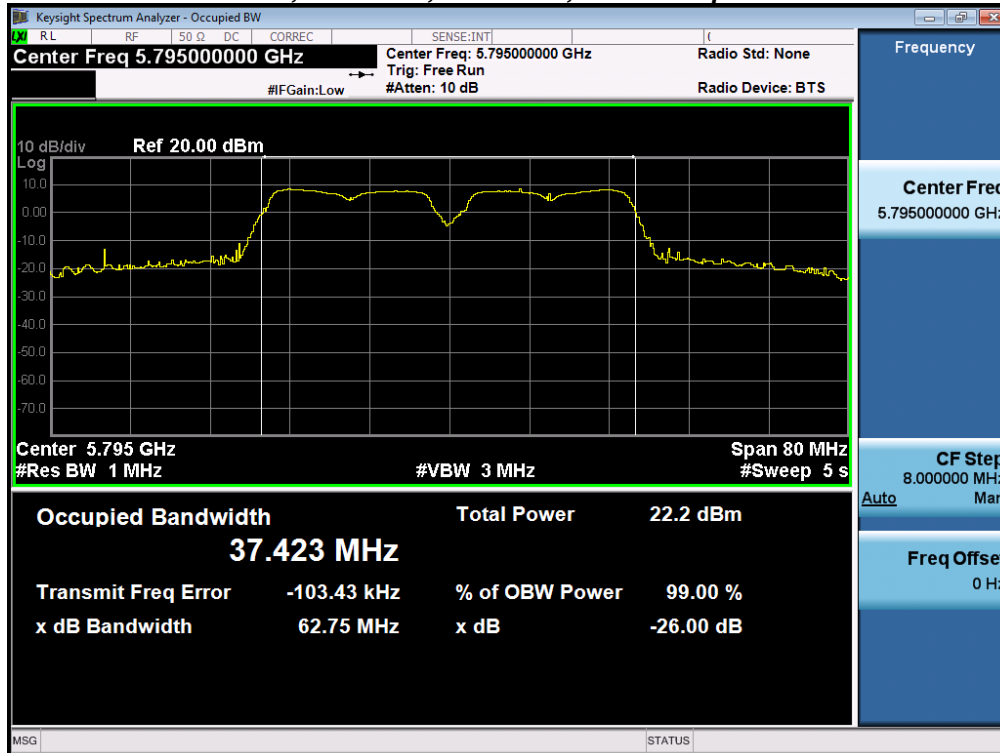

26dB / 99% Bandwidth, 5795 MHz, HT/VHT40, M0 to M23, M0 to M9 1-0ss

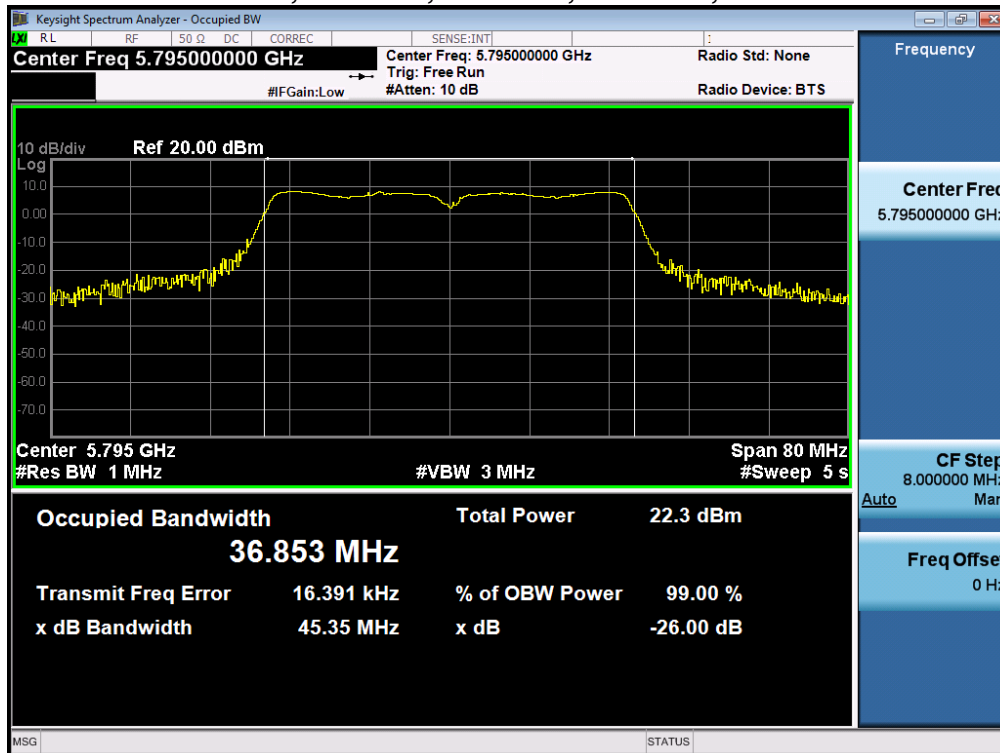



26dB / 99% Bandwidth, 5825 MHz, Non HT20, 6 to 54 Mbps

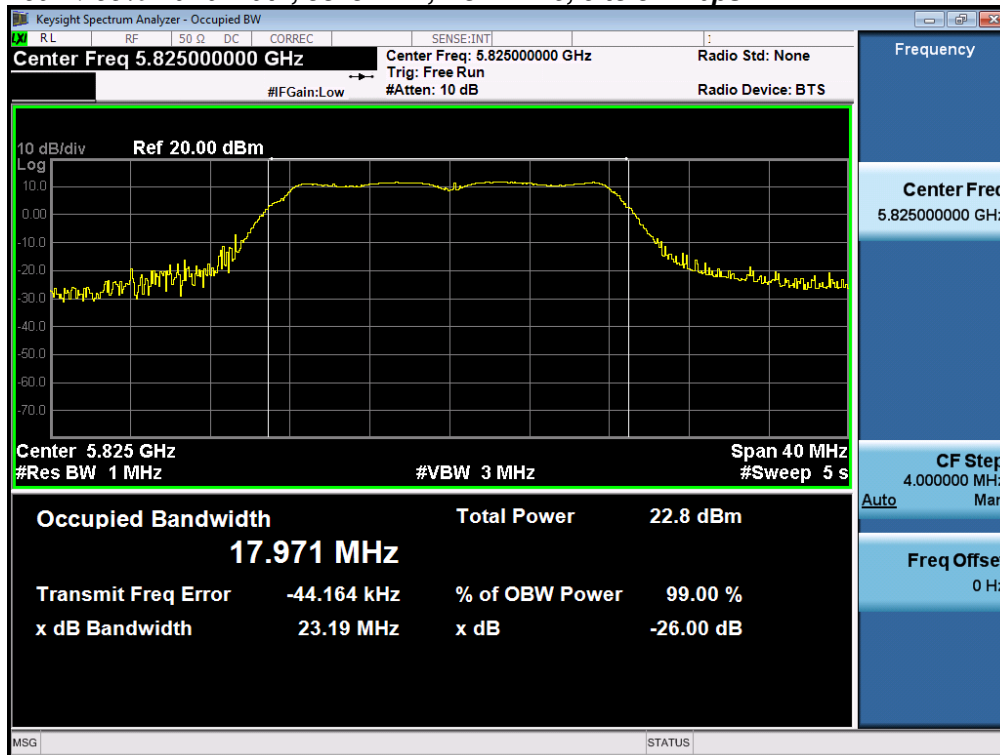

26dB / 99% Bandwidth, 5825 MHz, HT/VHT20, M0 to M23, M0 to M9 1-0ss

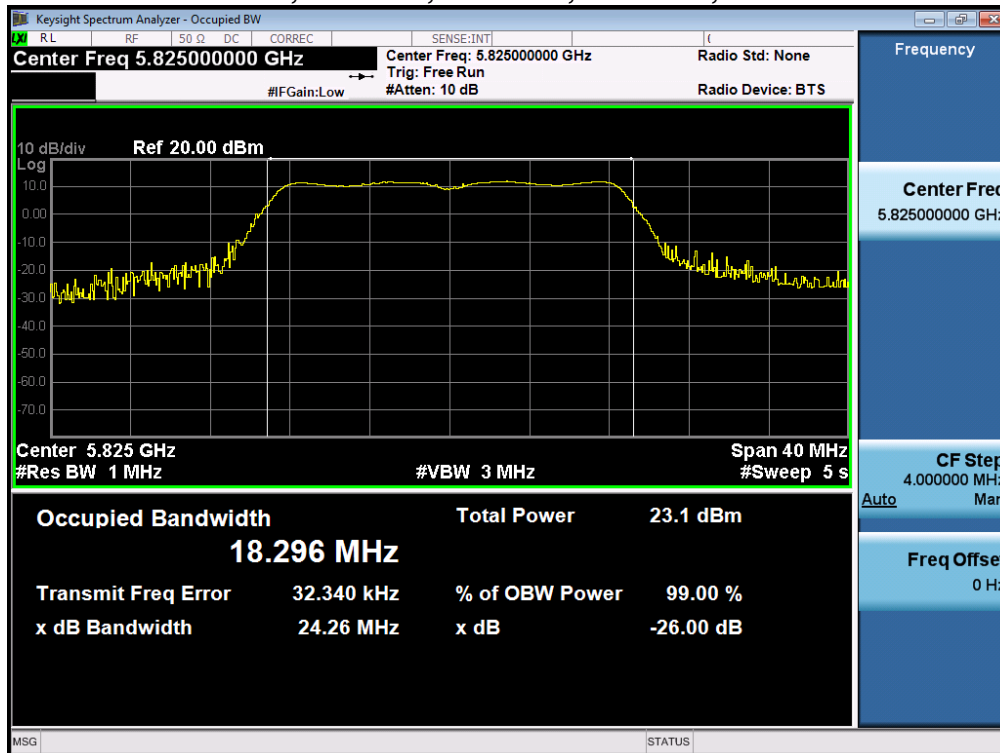



A.3 Maximum Conducted Output Power

15.407 (3) For the band 5.725-5.85 GHz, the maximum conducted output power over the frequency band of operation shall not exceed 1 W. In addition, the maximum power spectral density shall not exceed 30 dBm in any 500-kHz band. If transmitting antennas of directional gain greater than 6 dBi are used, both the maximum conducted output power and the maximum power spectral density shall be reduced by the amount in dB that the directional gain of the antenna exceeds 6 dBi. However, fixed point-to-point U-NII devices operating in this band may employ transmitting antennas with directional gain greater than 6 dBi without any corresponding reduction in transmitter conducted power. Fixed, point-to-point operations exclude the use of point-to-multipoint systems, omnidirectional applications, and multiple collocated transmitters transmitting the same information. The operator of the U-NII device, or if the equipment is professionally installed, the installer, is responsible for ensuring that systems employing high gain directional antennas are used exclusively for fixed, point-to-point operations.

Test Procedure

Ref. KDB 789033 D02 General UNII Test Procedures New Rules v01r01
ANSI C63.10: 2013

| |
|---|
| Output Power Test Procedure |
| <ol style="list-style-type: none"> 1. Set the radio in the continuous transmitting mode at full power 2. Compute power by integrating the spectrum across the EBW (or alternatively entire 99% OBW) of the signal using the instrument's band power measurement function. The integration shall be performed using the spectrum analyzer band-power measurement function with band limits set equal to the EBW or the OBW band edges. 3. Capture graphs and record pertinent measurement data. |

Ref. KDB 789033 D02 General UNII Test Procedures New Rules v01r01
ANSI C63.10: 2013 section 12.3.2.2 Method SA-1

| |
|---|
| Output Power Test parameters |
| Span = >1.5 times the OBW RBW = 1MHz VBW ≥ 3 x RBW Sweep = Auto couple Detector = sample Trace = Trace Average 100 |

The "measure-and-sum technique" is used for measuring in-band transmit power of a device. In the measure-and-sum approach, the conducted emission level is measured at each antenna port. The measured results at the various antenna ports are then summed mathematically to determine the total emission level from the device. Summing is performed in linear power units. (See ANSI C63.10 section 14.3.2.2)

| System Number | Description | Samples | System under test | Support equipment |
|---------------|-------------|---------|-------------------------------------|-------------------------------------|
| 1 | EUT | S01 | <input checked="" type="checkbox"/> | <input type="checkbox"/> |
| | Support | S02 | <input type="checkbox"/> | <input checked="" type="checkbox"/> |

| | |
|------------------------------------|--|
| Tested By : Jose Aguirre | Date of testing: 01-Jan-16 - 22-Feb-16 |
| Test Result : PASS | |

See Appendix C for list of test equipment



| Frequency (MHz) | Mode | Tx Paths | Correlated Antenna Gain (dBi) | Tx 1 Max Power (dBm) | Tx 2 Max Power (dBm) | Tx 3 Max Power (dBm) | Tx 4 Max Power (dBm) | Total Tx Channel Power (dBm) | Limit (dBm) | Margin (dB) |
|------------------------|-------------------------------------|------------------------|-------------------------------|----------------------|----------------------|----------------------|----------------------|------------------------------|-------------|-------------|
| 5745 | Non HT20, 6 to 54 Mbps | 1 | 6 | 14.8 | | | | 14.8 | 30.0 | 15.2 |
| | Non HT20, 6 to 54 Mbps | 2 | 6 | 11.3 | 10.5 | | | 13.9 | 30.0 | 16.1 |
| | Non HT20, 6 to 54 Mbps | 3 | 6 | 9.4 | 8.5 | 7.7 | | 13.4 | 30.0 | 16.6 |
| | Non HT20, 6 to 54 Mbps | 4 | 6 | 8.5 | 7.6 | 6.8 | 9.3 | 14.2 | 30.0 | 15.8 |
| | Non HT20 Beam Forming, 6 to 54 Mbps | 2 | 9 | 8.5 | 7.6 | | | 11.1 | 27.0 | 15.9 |
| | Non HT20 Beam Forming, 6 to 54 Mbps | 3 | 11 | 5.5 | 4.5 | 3.7 | | 9.4 | 25.0 | 15.6 |
| | Non HT20 Beam Forming, 6 to 54 Mbps | 4 | 12 | 2.0 | 0.6 | -0.2 | 2.7 | 7.4 | 24.0 | 16.6 |
| | HT/VHT20, M0 to M7 | 1 | 6 | 13.7 | | | | 13.7 | 30.0 | 16.3 |
| | HT/VHT20, M0 to M7 | 2 | 6 | 10.6 | 9.6 | | | 13.1 | 30.0 | 16.9 |
| | HT/VHT20, M8 to M15 | 2 | 6 | 10.6 | 9.6 | | | 13.1 | 30.0 | 16.9 |
| | HT/VHT20, M0 to M7 | 3 | 6 | 10.6 | 9.6 | 8.9 | | 14.5 | 30.0 | 15.5 |
| | HT/VHT20, M8 to M15 | 3 | 6 | 10.6 | 9.6 | 8.9 | | 14.5 | 30.0 | 15.5 |
| | HT/VHT20, M16 to M23 | 3 | 6 | 10.6 | 9.6 | 8.9 | | 14.5 | 30.0 | 15.5 |
| | HT/VHT20, M0 to M7 | 4 | 6 | 7.7 | 6.8 | 6.0 | 8.5 | 13.4 | 30.0 | 16.6 |
| | HT/VHT20, M8 to M15 | 4 | 6 | 7.7 | 6.8 | 6.0 | 8.5 | 13.4 | 30.0 | 16.6 |
| | HT/VHT20, M16 to M23 | 4 | 6 | 7.7 | 6.8 | 6.0 | 8.5 | 13.4 | 30.0 | 16.6 |
| | HT/VHT20 Beam Forming, M0 to M7 | 2 | 9 | 7.7 | 6.8 | | | 10.3 | 27.0 | 16.7 |
| | HT/VHT20 Beam Forming, M8 to M15 | 2 | 6 | 10.6 | 9.6 | | | 13.1 | 30.0 | 16.9 |
| | HT/VHT20 Beam Forming, M0 to M7 | 3 | 11 | 4.8 | 3.6 | 2.7 | | 8.6 | 25.0 | 16.4 |
| | HT/VHT20 Beam Forming, M8 to M15 | 3 | 8 | 7.7 | 6.8 | 6.0 | | 11.7 | 29.0 | 16.7 |
| | HT/VHT20 Beam Forming, M16 to M23 | 3 | 6 | 10.6 | 9.6 | 8.9 | | 14.5 | 30.0 | 15.5 |
| | HT/VHT20 Beam Forming, M0 to M7 | 4 | 12 | 2.1 | 0.7 | -0.1 | 2.7 | 7.5 | 24.0 | 16.5 |
| | HT/VHT20 Beam Forming, M8 to M15 | 4 | 9 | 4.8 | 3.6 | 2.7 | 5.4 | 10.3 | 27.0 | 16.7 |
| | HT/VHT20 Beam Forming, M16 to M23 | 4 | 7 | 6.6 | 5.6 | 4.8 | 7.4 | 12.2 | 29.0 | 16.8 |
| | HT/VHT20 STBC, M0 to M7 | 2 | 6 | 10.6 | 9.6 | | | 13.1 | 30.0 | 16.9 |
| | HT/VHT20 STBC, M0 to M7 | 3 | 6 | 10.6 | 9.6 | 8.9 | | 14.5 | 30.0 | 15.5 |
| | HT/VHT20 STBC, M0 to M7 | 4 | 6 | 7.7 | 6.8 | 6.0 | 8.5 | 13.4 | 30.0 | 16.6 |
| | 5755 | Non HT40, 6 to 54 Mbps | 1 | 6 | 6.6 | | | | 6.6 | 30.0 |
| Non HT40, 6 to 54 Mbps | | 2 | 6 | 2.7 | 1.7 | | | 5.2 | 30.0 | 24.8 |
| Non HT40, 6 to 54 Mbps | | 3 | 6 | 1.6 | 0.4 | -0.1 | | 5.5 | 30.0 | 24.5 |
| Non HT40, 6 to 54 Mbps | | 4 | 6 | 0.6 | -0.5 | -1.1 | 1.5 | 6.3 | 30.0 | 23.7 |
| HT/VHT40, M0 to M7 | | 1 | 6 | 9.4 | | | | 9.4 | 30.0 | 20.6 |
| HT/VHT40, M0 to M7 | | 2 | 6 | 7.6 | 6.3 | | | 10.0 | 30.0 | 20.0 |



| | | | | | | | | | | |
|----------------------------------|-----------------------------------|---|------|------|------|------|------|------|------|------|
| | HT/VHT40, M8 to M15 | 2 | 6 | 7.6 | 6.3 | | | 10.0 | 30.0 | 20.0 |
| | HT/VHT40, M0 to M7 | 3 | 6 | 7.6 | 6.3 | 5.6 | | 11.4 | 30.0 | 18.6 |
| | HT/VHT40, M8 to M15 | 3 | 6 | 7.6 | 6.3 | 5.6 | | 11.4 | 30.0 | 18.6 |
| | HT/VHT40, M16 to M23 | 3 | 6 | 7.6 | 6.3 | 5.6 | | 11.4 | 30.0 | 18.6 |
| | HT/VHT40, M0 to M7 | 4 | 6 | 4.3 | 3.2 | 2.8 | 5.1 | 10.0 | 30.0 | 20.0 |
| | HT/VHT40, M8 to M15 | 4 | 6 | 4.3 | 3.2 | 2.8 | 5.1 | 10.0 | 30.0 | 20.0 |
| | HT/VHT40, M16 to M23 | 4 | 6 | 4.3 | 3.2 | 2.8 | 5.1 | 10.0 | 30.0 | 20.0 |
| | HT/VHT40 Beam Forming, M0 to M7 | 2 | 9 | 4.3 | 3.2 | | | 6.8 | 27.0 | 20.2 |
| | HT/VHT40 Beam Forming, M8 to M15 | 2 | 6 | 7.6 | 6.3 | | | 10.0 | 30.0 | 20.0 |
| | HT/VHT40 Beam Forming, M0 to M7 | 3 | 11 | -0.7 | -1.8 | -2.3 | | 3.2 | 25.0 | 21.8 |
| | HT/VHT40 Beam Forming, M8 to M15 | 3 | 8 | 4.3 | 3.2 | 2.8 | | 8.3 | 28.0 | 19.7 |
| | HT/VHT40 Beam Forming, M16 to M23 | 3 | 6 | 7.6 | 6.3 | 5.6 | | 11.4 | 30.0 | 18.6 |
| | HT/VHT40 Beam Forming, M0 to M7 | 4 | 12 | -1.5 | -2.8 | -3.3 | -0.7 | 4.1 | 24.0 | 19.9 |
| | HT/VHT40 Beam Forming, M8 to M15 | 4 | 9 | 0.3 | -0.8 | -1.3 | 1.2 | 6.0 | 27.0 | 21.0 |
| | HT/VHT40 Beam Forming, M16 to M23 | 4 | 7 | 3.3 | 2.2 | 1.6 | 4.1 | 8.9 | 29.0 | 20.1 |
| | HT/VHT40 STBC, M0 to M7 | 2 | 6 | 7.6 | 6.3 | | | 10.0 | 30.0 | 20.0 |
| | HT/VHT40 STBC, M0 to M7 | 3 | 6 | 7.6 | 6.3 | 5.6 | | 11.4 | 30.0 | 18.6 |
| | HT/VHT40 STBC, M0 to M7 | 4 | 6 | 4.3 | 3.2 | 2.8 | 5.1 | 10.0 | 30.0 | 20.0 |
| | | | | | | | | | | |
| 5775 | Non HT80, 6 to 54 Mbps | 1 | 6 | 13.0 | | | | 13.0 | 30.0 | 17.0 |
| | Non HT80, 6 to 54 Mbps | 2 | 6 | 9.7 | 9.4 | | | 12.6 | 30.0 | 17.4 |
| | Non HT80, 6 to 54 Mbps | 3 | 6 | 9.7 | 9.4 | 9.5 | | 14.3 | 30.0 | 15.7 |
| | Non HT80, 6 to 54 Mbps | 4 | 6 | 5.1 | 4.8 | 5.1 | 6.3 | 11.4 | 30.0 | 18.6 |
| | VHT80, M0.1 to M9.1 | 1 | 6 | 12.5 | | | | 12.5 | 30.0 | 17.5 |
| | VHT80, M0.1 to M9.1 | 2 | 6 | 10.3 | 10.0 | | | 13.2 | 30.0 | 16.8 |
| | VHT80, M0.2 to M9.2 | 2 | 6 | 10.3 | 10.0 | | | 13.2 | 30.0 | 16.8 |
| | VHT80, M0.1 to M9.1 | 3 | 6 | 7.5 | 7.1 | 7.3 | | 12.1 | 30.0 | 17.9 |
| | VHT80, M0.2 to M9.2 | 3 | 6 | 7.5 | 7.1 | 7.3 | | 12.1 | 30.0 | 17.9 |
| | VHT80, M0.3 to M9.3 | 3 | 6 | 7.5 | 7.1 | 7.3 | | 12.1 | 30.0 | 17.9 |
| | VHT80, M0.1 to M9.1 | 4 | 6 | 6.6 | 6.1 | 6.3 | 7.7 | 12.7 | 30.0 | 17.3 |
| | VHT80, M0.2 to M9.2 | 4 | 6 | 6.6 | 6.1 | 6.3 | 7.7 | 12.7 | 30.0 | 17.3 |
| | VHT80, M0.3 to M9.3 | 4 | 6 | 6.6 | 6.1 | 6.3 | 7.7 | 12.7 | 30.0 | 17.3 |
| | VHT80 Beam Forming, M0.1 to M9.1 | 2 | 6 | 10.3 | 10.0 | | | 13.2 | 30.0 | 16.8 |
| | VHT80 Beam Forming, M0.2 to M9.2 | 2 | 6 | 10.3 | 10.0 | | | 13.2 | 30.0 | 16.8 |
| | VHT80 Beam Forming, M0.1 to M9.1 | 3 | 6 | 7.5 | 7.1 | 7.3 | | 12.1 | 30.0 | 17.9 |
| | VHT80 Beam Forming, M0.2 to M9.2 | 3 | 6 | 7.5 | 7.1 | 7.3 | | 12.1 | 30.0 | 17.9 |
| | VHT80 Beam Forming, M0.3 to M9.3 | 3 | 6 | 7.5 | 7.1 | 7.3 | | 12.1 | 30.0 | 17.9 |
| | VHT80 Beam Forming, M0.1 to M9.1 | 4 | 6 | 6.6 | 6.1 | 6.3 | 7.7 | 12.7 | 30.0 | 17.3 |
| | VHT80 Beam Forming, M0.2 to M9.2 | 4 | 6 | 6.6 | 6.1 | 6.3 | 7.7 | 12.7 | 30.0 | 17.3 |
| VHT80 Beam Forming, M0.3 to M9.3 | 4 | 6 | 6.6 | 6.1 | 6.3 | 7.7 | 12.7 | 30.0 | 17.3 | |
| VHT80 STBC, M0.1 to M9.1 | 2 | 6 | 10.3 | 10.0 | | | 13.2 | 30.0 | 16.8 | |



| | | | | | | | | | | |
|-------------------------|--|----------|-----------|-------------|-------------|-------------|-------------|-------------|-------------|------------|
| | VHT80 STBC, M0.1 to M9.1 | 3 | 6 | 7.5 | 7.1 | 7.3 | | 12.1 | 30.0 | 17.9 |
| | VHT80 STBC, M0.1 to M9.1 | 4 | 6 | 6.6 | 6.1 | 6.3 | 7.7 | 12.7 | 30.0 | 17.3 |
| 5785 | Non HT20, 6 to 54 Mbps | 1 | 6 | 14.0 | | | | 14.0 | 30.0 | 16.0 |
| | Non HT20, 6 to 54 Mbps | 2 | 6 | 14.0 | 14.1 | | | 17.1 | 30.0 | 12.9 |
| | Non HT20, 6 to 54 Mbps | 3 | 6 | 14.0 | 14.1 | 13.7 | | 18.7 | 30.0 | 11.3 |
| | Non HT20, 6 to 54 Mbps | 4 | 6 | 14.0 | 14.1 | 13.7 | 15.8 | 20.5 | 30.0 | 9.5 |
| | Non HT20 Beam Forming, 6 to 54 Mbps | 2 | 9 | 14.0 | 14.1 | | | 17.1 | 27.0 | 9.9 |
| | Non HT20 Beam Forming, 6 to 54 Mbps | 3 | 11 | 14.0 | 14.1 | 13.7 | | 18.7 | 25.0 | 6.3 |
| | Non HT20 Beam Forming, 6 to 54 Mbps | 4 | 12 | 14.0 | 14.1 | 13.7 | 15.8 | 20.5 | 24.0 | 3.5 |
| | HT/VHT20, M0 to M7 | 1 | 6 | 14.2 | | | | 14.2 | 30.0 | 15.8 |
| | HT/VHT20, M0 to M7 | 2 | 6 | 14.2 | 14.4 | | | 17.3 | 30.0 | 12.7 |
| | HT/VHT20, M8 to M15 | 2 | 6 | 14.2 | 14.4 | | | 17.3 | 30.0 | 12.7 |
| | HT/VHT20, M0 to M7 | 3 | 6 | 14.2 | 14.4 | 13.9 | | 18.9 | 30.0 | 11.1 |
| | HT/VHT20, M8 to M15 | 3 | 6 | 14.2 | 14.4 | 13.9 | | 18.9 | 30.0 | 11.1 |
| | HT/VHT20, M16 to M23 | 3 | 6 | 14.2 | 14.4 | 13.9 | | 18.9 | 30.0 | 11.1 |
| | HT/VHT20, M0 to M7 | 4 | 6 | 14.2 | 14.4 | 13.9 | 16.0 | 20.7 | 30.0 | 9.3 |
| | HT/VHT20, M8 to M15 | 4 | 6 | 14.2 | 14.4 | 13.9 | 16.0 | 20.7 | 30.0 | 9.3 |
| | HT/VHT20, M16 to M23 | 4 | 6 | 14.2 | 14.4 | 13.9 | 16.0 | 20.7 | 30.0 | 9.3 |
| | HT/VHT20 Beam Forming, M0 to M7 | 2 | 9 | 14.2 | 14.4 | | | 17.3 | 27.0 | 9.7 |
| | HT/VHT20 Beam Forming, M8 to M15 | 2 | 6 | 14.2 | 14.4 | | | 17.3 | 30.0 | 12.7 |
| | HT/VHT20 Beam Forming, M0 to M7 | 3 | 11 | 14.2 | 14.4 | 13.9 | | 18.9 | 25.0 | 6.1 |
| | HT/VHT20 Beam Forming, M8 to M15 | 3 | 8 | 14.2 | 14.4 | 13.9 | | 18.9 | 28.0 | 9.1 |
| | HT/VHT20 Beam Forming, M16 to M23 | 3 | 6 | 14.2 | 14.4 | 13.9 | | 18.9 | 30.0 | 11.1 |
| | HT/VHT20 Beam Forming, M0 to M7 | 4 | 12 | 14.2 | 14.4 | 13.9 | 16.0 | 20.7 | 24.0 | 3.3 |
| | HT/VHT20 Beam Forming, M8 to M15 | 4 | 9 | 14.2 | 14.4 | 13.9 | 16.0 | 20.7 | 27.0 | 6.3 |
| | HT/VHT20 Beam Forming, M16 to M23 | 4 | 7 | 14.2 | 14.4 | 13.9 | 16.0 | 20.7 | 29.0 | 8.3 |
| | HT/VHT20 STBC, M0 to M7 | 2 | 6 | 14.2 | 14.4 | | | 17.3 | 30.0 | 12.7 |
| | HT/VHT20 STBC, M0 to M7 | 3 | 6 | 14.2 | 14.4 | 13.9 | | 18.9 | 30.0 | 11.1 |
| HT/VHT20 STBC, M0 to M7 | 4 | 6 | 14.2 | 14.4 | 13.9 | 16.0 | 20.7 | 30.0 | 9.3 | |
| 5795 | Non HT40, 6 to 54 Mbps | 1 | 6 | 14.2 | | | | 14.2 | 30.0 | 15.8 |
| | Non HT40, 6 to 54 Mbps | 2 | 6 | 14.2 | 14.5 | | | 17.4 | 30.0 | 12.6 |
| | Non HT40, 6 to 54 Mbps | 3 | 6 | 14.2 | 14.5 | 15.1 | | 19.4 | 30.0 | 10.6 |
| | Non HT40, 6 to 54 Mbps | 4 | 6 | 13.0 | 13.4 | 13.9 | 15.0 | 19.9 | 30.0 | 10.1 |
| | HT/VHT40, M0 to M7 | 1 | 6 | 14.2 | | | | 14.2 | 30.0 | 15.8 |
| | HT/VHT40, M0 to M7 | 2 | 6 | 14.2 | 13.4 | | | 16.8 | 30.0 | 13.2 |
| | HT/VHT40, M8 to M15 | 2 | 6 | 14.2 | 13.4 | | | 16.8 | 30.0 | 13.2 |
| | HT/VHT40, M0 to M7 | 3 | 6 | 14.2 | 13.4 | 13.9 | | 18.6 | 30.0 | 11.4 |
| | HT/VHT40, M8 to M15 | 3 | 6 | 14.2 | 13.4 | 13.9 | | 18.6 | 30.0 | 11.4 |
| | HT/VHT40, M16 to M23 | 3 | 6 | 14.2 | 13.4 | 13.9 | | 18.6 | 30.0 | 11.4 |



| | | | | | | | | | | |
|-------------------------|-------------------------------------|---|------|------|------|------|------|------|------|------|
| | HT/VHT40, M0 to M7 | 4 | 6 | 14.2 | 13.4 | 13.9 | 16.1 | 20.5 | 30.0 | 9.5 |
| | HT/VHT40, M8 to M15 | 4 | 6 | 14.2 | 13.4 | 13.9 | 16.1 | 20.5 | 30.0 | 9.5 |
| | HT/VHT40, M16 to M23 | 4 | 6 | 14.2 | 13.4 | 13.9 | 16.1 | 20.5 | 30.0 | 9.5 |
| | HT/VHT40 Beam Forming, M0 to M7 | 2 | 9 | 14.2 | 13.4 | | | 16.8 | 27.0 | 10.2 |
| | HT/VHT40 Beam Forming, M8 to M15 | 2 | 6 | 14.2 | 13.4 | | | 16.8 | 30.0 | 13.2 |
| | HT/VHT40 Beam Forming, M0 to M7 | 3 | 11 | 14.2 | 13.4 | 13.9 | | 18.6 | 25.0 | 6.4 |
| | HT/VHT40 Beam Forming, M8 to M15 | 3 | 8 | 14.2 | 13.4 | 13.9 | | 18.6 | 28.0 | 9.4 |
| | HT/VHT40 Beam Forming, M16 to M23 | 3 | 6 | 14.2 | 13.4 | 13.9 | | 18.6 | 30.0 | 11.4 |
| | HT/VHT40 Beam Forming, M0 to M7 | 4 | 12 | 14.2 | 13.4 | 13.9 | 16.1 | 20.5 | 24.0 | 3.5 |
| | HT/VHT40 Beam Forming, M8 to M15 | 4 | 9 | 14.2 | 13.4 | 13.9 | 16.1 | 20.5 | 27.0 | 6.5 |
| | HT/VHT40 Beam Forming, M16 to M23 | 4 | 7 | 14.2 | 13.4 | 13.9 | 16.1 | 20.5 | 29.0 | 8.5 |
| | HT/VHT40 STBC, M0 to M7 | 2 | 6 | 14.2 | 13.4 | | | 16.8 | 30.0 | 13.2 |
| | HT/VHT40 STBC, M0 to M7 | 3 | 6 | 14.2 | 13.4 | 13.9 | | 18.6 | 30.0 | 11.4 |
| | HT/VHT40 STBC, M0 to M7 | 4 | 6 | 14.2 | 13.4 | 13.9 | 16.1 | 20.5 | 30.0 | 9.5 |
| | | | | | | | | | | |
| 5825 | Non HT20, 6 to 54 Mbps | 1 | 6 | 14.8 | | | | 14.8 | 30.0 | 15.2 |
| | Non HT20, 6 to 54 Mbps | 2 | 6 | 13.6 | 12.7 | | | 16.2 | 30.0 | 13.8 |
| | Non HT20, 6 to 54 Mbps | 3 | 6 | 11.0 | 10.5 | 11.0 | | 15.6 | 30.0 | 14.4 |
| | Non HT20, 6 to 54 Mbps | 4 | 6 | 8.7 | 8.5 | 9.1 | 10.2 | 15.2 | 30.0 | 14.8 |
| | Non HT20 Beam Forming, 6 to 54 Mbps | 2 | 9 | 9.7 | 9.4 | | | 12.6 | 27.0 | 14.4 |
| | Non HT20 Beam Forming, 6 to 54 Mbps | 3 | 11 | 5.8 | 5.5 | 6.0 | | 10.5 | 25.0 | 14.5 |
| | Non HT20 Beam Forming, 6 to 54 Mbps | 4 | 12 | 2.8 | 2.4 | 3.0 | 4.2 | 9.2 | 24.0 | 14.8 |
| | HT/VHT20, M0 to M7 | 1 | 6 | 15.0 | | | | 15.0 | 30.0 | 15.0 |
| | HT/VHT20, M0 to M7 | 2 | 6 | 13.8 | 13.0 | | | 16.4 | 30.0 | 13.6 |
| | HT/VHT20, M8 to M15 | 2 | 6 | 13.8 | 13.0 | | | 16.4 | 30.0 | 13.6 |
| | HT/VHT20, M0 to M7 | 3 | 6 | 11.2 | 10.7 | 11.3 | | 15.8 | 30.0 | 14.2 |
| | HT/VHT20, M8 to M15 | 3 | 6 | 11.2 | 10.7 | 11.3 | | 15.8 | 30.0 | 14.2 |
| | HT/VHT20, M16 to M23 | 3 | 6 | 11.2 | 10.7 | 11.3 | | 15.8 | 30.0 | 14.2 |
| | HT/VHT20, M0 to M7 | 4 | 6 | 8.9 | 8.7 | 9.4 | 10.4 | 15.4 | 30.0 | 14.6 |
| | HT/VHT20, M8 to M15 | 4 | 6 | 8.9 | 8.7 | 9.4 | 10.4 | 15.4 | 30.0 | 14.6 |
| | HT/VHT20, M16 to M23 | 4 | 6 | 8.9 | 8.7 | 9.4 | 10.4 | 15.4 | 30.0 | 14.6 |
| | HT/VHT20 Beam Forming, M0 to M7 | 2 | 9 | 10.0 | 9.6 | | | 12.8 | 27.0 | 14.2 |
| | HT/VHT20 Beam Forming, M8 to M15 | 2 | 6 | 13.8 | 13.0 | | | 16.4 | 30.0 | 13.6 |
| | HT/VHT20 Beam Forming, M0 to M7 | 3 | 11 | 7.0 | 6.6 | 7.2 | | 11.7 | 25.0 | 13.3 |
| | HT/VHT20 Beam Forming, M8 to M15 | 3 | 8 | 8.9 | 8.7 | 9.4 | | 13.8 | 29.0 | 15.2 |
| | HT/VHT20 Beam Forming, M16 to M23 | 3 | 6 | 11.2 | 10.7 | 11.3 | | 15.8 | 30.0 | 14.2 |
| | HT/VHT20 Beam Forming, M0 to M7 | 4 | 12 | 3.1 | 2.7 | 3.3 | 4.4 | 9.4 | 24.0 | 14.6 |
| | HT/VHT20 Beam Forming, M8 to M15 | 4 | 9 | 7.0 | 6.6 | 7.2 | 8.5 | 13.4 | 27.0 | 13.6 |
| | HT/VHT20 Beam Forming, M16 to M23 | 4 | 7 | 8.9 | 8.7 | 9.4 | 10.4 | 15.4 | 29.0 | 13.6 |
| HT/VHT20 STBC, M0 to M7 | 2 | 6 | 13.8 | 13.0 | | | 16.4 | 30.0 | 13.6 | |
| HT/VHT20 STBC, M0 to M7 | 3 | 6 | 11.2 | 10.7 | 11.3 | | 15.8 | 30.0 | 14.2 | |



| | | | | | | | | | |
|-------------------------|---|---|-----|-----|-----|------|------|------|------|
| HT/VHT20 STBC, M0 to M7 | 4 | 6 | 8.9 | 8.7 | 9.4 | 10.4 | 15.4 | 30.0 | 14.6 |
|-------------------------|---|---|-----|-----|-----|------|------|------|------|

Peak Output Power, 5785 MHz, HT/VHT20 Beam Forming, M0 to M7

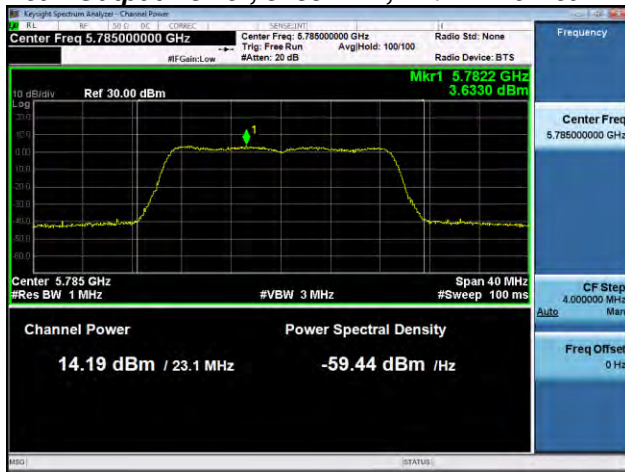

Antenna A

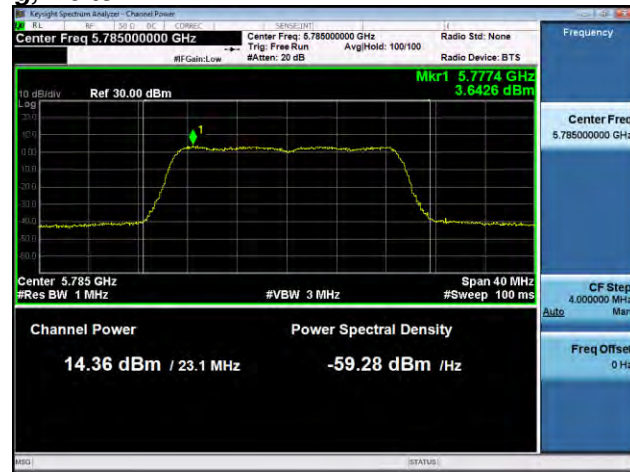

Antenna B



Antenna C

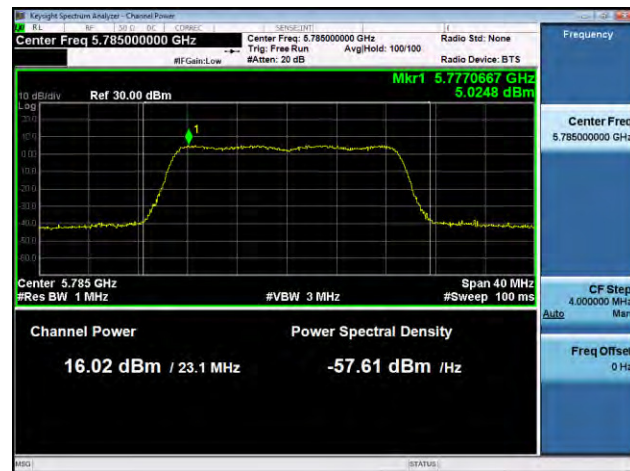

Antenna D



A.4 Power Spectral Density

15.407

The power spectral density shall not exceed 30 dBm in any 500 kHz band. If transmitting antennas of directional gain greater than 6 dBi are used, both the maximum conducted output power and the power spectral density shall be reduced by the amount in dB that the directional gain of the antenna exceeds 6 dBi.

Test Procedure

Ref. KDB 789033 D02 General UNII Test Procedures New Rules v01r01

| |
|--|
| Power Spectral Density Test Procedure |
| 1. Connect the antenna port(s) to the spectrum analyzer input. 2. Set the radio in the continuous transmitting mode at full power 3. Configure Spectrum analyzer as per test parameters below and Peak search marker 4. Capture graphs and record pertinent measurement data. |

Ref. KDB 789033 D02 v01r01 section F.5

| |
|--|
| Power Spectral Density Test parameters |
| Span = >1.5 times the OBW RBW = 500 kHz. VBW ≥ 3 x RBW Sweep = 10s Detector = Peak Trace = Single Sweep Marker = Peak Search |

The "Measure and add 10 log(N) dB technique", where N is the number of outputs, is used for measuring in-band Power Spectral Density. With this technique, spectrum measurements are performed at each output of the device, and the quantity 10 log(4) (or 6dB) is added to the worst case spectrum value before comparing to the emission limit. (ANSI C63.10 2013 section 14.3.2.3)

| System Number | Description | Samples | System under test | Support equipment |
|---------------|-------------|---------|-------------------------------------|-------------------------------------|
| 1 | EUT | S01 | <input checked="" type="checkbox"/> | <input type="checkbox"/> |
| | Support | S02 | <input type="checkbox"/> | <input checked="" type="checkbox"/> |

| | |
|------------------------------------|--|
| Tested By : Jose Aguirre | Date of testing: 01-Jan-16 - 22-Feb-16 |
| Test Result : PASS | |

See Appendix C for list of test equipment



| Frequency (MHz) | Mode | Tx Paths | Correlated Antenna Gain (dBi) | Tx 1 PSD (dBm/MHz) | Tx 2 PSD (dBm/MHz) | Tx 3 PSD (dBm/MHz) | Tx 4 PSD (dBm/MHz) | Total PSD (dBm/500MHz) | Limit (dBm/500MHz) | Margin (dB) | |
|-------------------------|-------------------------------------|----------|-------------------------------|--------------------|--------------------|--------------------|--------------------|------------------------|--------------------|-------------|------|
| 5745 | Non HT20, 6 to 54 Mbps | 1 | 6 | 2.0 | | | | 2.0 | 30.0 | 28.0 | |
| | Non HT20, 6 to 54 Mbps | 2 | 9 | -2.1 | -2.5 | | | 0.7 | 27.0 | 26.3 | |
| | Non HT20, 6 to 54 Mbps | 3 | 11 | -3.9 | -4.6 | -5.4 | | 0.2 | 25.0 | 24.8 | |
| | Non HT20, 6 to 54 Mbps | 4 | 12 | -4.6 | -5.7 | -6.4 | -3.8 | 1.0 | 24.0 | 23.0 | |
| | Non HT20 Beam Forming, 6 to 54 Mbps | 2 | 9 | -4.6 | -5.7 | | | -2.1 | 27.0 | 29.1 | |
| | Non HT20 Beam Forming, 6 to 54 Mbps | 3 | 11 | -7.6 | -8.9 | -9.5 | | -3.8 | 25.0 | 28.8 | |
| | Non HT20 Beam Forming, 6 to 54 Mbps | 4 | 12 | -11.1 | -12.8 | -13.6 | -10.6 | -5.8 | 24.0 | 29.8 | |
| | HT/VHT20, M0 to M7 | 1 | 6 | 0.1 | | | | | 0.1 | 30.0 | 29.9 |
| | HT/VHT20, M0 to M7 | 2 | 9 | -3.0 | -3.8 | | | | -0.4 | 27.0 | 27.4 |
| | HT/VHT20, M8 to M15 | 2 | 6 | -3.0 | -3.8 | | | | -0.4 | 30.0 | 30.4 |
| | HT/VHT20, M0 to M7 | 3 | 11 | -3.0 | -3.8 | -4.3 | | | 1.1 | 25.0 | 23.9 |
| | HT/VHT20, M8 to M15 | 3 | 8 | -3.0 | -3.8 | -4.3 | | | 1.1 | 29.0 | 27.3 |
| | HT/VHT20, M16 to M23 | 3 | 6 | -3.0 | -3.8 | -4.3 | | | 1.1 | 30.0 | 28.9 |
| | HT/VHT20, M0 to M7 | 4 | 12 | -6.0 | -6.5 | -7.5 | -5.2 | | -0.2 | 24.0 | 24.2 |
| | HT/VHT20, M8 to M15 | 4 | 9 | -6.0 | -6.5 | -7.5 | -5.2 | | -0.2 | 27.0 | 27.2 |
| | HT/VHT20, M16 to M23 | 4 | 7 | -6.0 | -6.5 | -7.5 | -5.2 | | -0.2 | 29.0 | 29.2 |
| | HT/VHT20 Beam Forming, M0 to M7 | 2 | 9 | -6.0 | -6.5 | | | | -3.2 | 27.0 | 30.2 |
| | HT/VHT20 Beam Forming, M8 to M15 | 2 | 6 | -3.0 | -3.8 | | | | -0.4 | 30.0 | 30.4 |
| | HT/VHT20 Beam Forming, M0 to M7 | 3 | 11 | -8.6 | -9.8 | -10.9 | | | -4.9 | 25.0 | 29.9 |
| | HT/VHT20 Beam Forming, M8 to M15 | 3 | 8 | -6.0 | -6.5 | -7.5 | | | -1.9 | 28.0 | 29.9 |
| | HT/VHT20 Beam Forming, M16 to M23 | 3 | 6 | -3.0 | -3.8 | -4.3 | | | 1.1 | 30.0 | 28.9 |
| | HT/VHT20 Beam Forming, M0 to M7 | 4 | 12 | -11.3 | -12.5 | -13.6 | -10.6 | | -5.8 | 24.0 | 29.8 |
| | HT/VHT20 Beam Forming, M8 to M15 | 4 | 9 | -8.6 | -9.8 | -10.9 | -8.3 | | -3.3 | 27.0 | 30.3 |
| | HT/VHT20 Beam Forming, M16 to M23 | 4 | 7 | -6.5 | -7.5 | -8.7 | -6.0 | | -1.0 | 29.0 | 30.0 |
| | HT/VHT20 STBC, M0 to M7 | 2 | 6 | -3.0 | -3.8 | | | | -0.4 | 30.0 | 30.4 |
| | HT/VHT20 STBC, M0 to M7 | 3 | 8 | -3.0 | -3.8 | -4.3 | | | 1.1 | 28.0 | 26.9 |
| HT/VHT20 STBC, M0 to M7 | 4 | 9 | -6.0 | -6.5 | -7.5 | -5.2 | | -0.2 | 27.0 | 27.2 | |
| 5755 | Non HT40, 6 to 54 Mbps | 1 | 6 | -9.1 | | | | -9.1 | 30.0 | 39.1 | |
| | Non HT40, 6 to 54 Mbps | 2 | 9 | -12.7 | -13.9 | | | -10.2 | 27.0 | 37.2 | |
| | Non HT40, 6 to 54 Mbps | 3 | 11 | -13.8 | -15.3 | -16.1 | | -10.2 | 25.0 | 35.2 | |
| | Non HT40, 6 to 54 Mbps | 4 | 12 | -15.1 | -16.1 | -17.2 | -14.3 | -9.5 | 24.0 | 33.5 | |
| | HT/VHT40, M0 to M7 | 1 | 6 | -6.4 | | | | -6.4 | 30.0 | 36.4 | |
| | HT/VHT40, M0 to M7 | 2 | 9 | -8.1 | -9.4 | | | -5.7 | 27.0 | 32.7 | |



| | | | | | | | | | | |
|----------------------------------|-----------------------------------|---|-------|-------|-------|-------|-------|-------|------|------|
| | HT/VHT40, M8 to M15 | 2 | 6 | -8.1 | -9.4 | | | -5.7 | 30.0 | 35.7 |
| | HT/VHT40, M0 to M7 | 3 | 11 | -8.1 | -9.4 | -10.9 | | -4.5 | 25.0 | 29.5 |
| | HT/VHT40, M8 to M15 | 3 | 8 | -8.1 | -9.4 | -10.9 | | -4.5 | 28.0 | 32.6 |
| | HT/VHT40, M16 to M23 | 3 | 6 | -8.1 | -9.4 | -10.9 | | -4.5 | 30.0 | 34.5 |
| | HT/VHT40, M0 to M7 | 4 | 12 | -11.8 | -12.7 | -13.9 | -11.3 | -6.3 | 24.0 | 30.3 |
| | HT/VHT40, M8 to M15 | 4 | 9 | -11.8 | -12.7 | -13.9 | -11.3 | -6.3 | 27.0 | 33.3 |
| | HT/VHT40, M16 to M23 | 4 | 7 | -11.8 | -12.7 | -13.9 | -11.3 | -6.3 | 29.0 | 35.3 |
| | HT/VHT40 Beam Forming, M0 to M7 | 2 | 9 | -11.8 | -12.7 | | | -9.2 | 27.0 | 36.2 |
| | HT/VHT40 Beam Forming, M8 to M15 | 2 | 6 | -8.1 | -9.4 | | | -5.7 | 30.0 | 35.7 |
| | HT/VHT40 Beam Forming, M0 to M7 | 3 | 11 | -16.6 | -17.9 | -18.7 | | -12.9 | 25.0 | 37.9 |
| | HT/VHT40 Beam Forming, M8 to M15 | 3 | 8 | -11.8 | -12.7 | -13.9 | | -7.9 | 28.0 | 36.0 |
| | HT/VHT40 Beam Forming, M16 to M23 | 3 | 6 | -8.1 | -9.4 | -10.9 | | -4.5 | 30.0 | 34.5 |
| | HT/VHT40 Beam Forming, M0 to M7 | 4 | 12 | -17.3 | -18.6 | -19.7 | -16.4 | -11.8 | 24.0 | 35.8 |
| | HT/VHT40 Beam Forming, M8 to M15 | 4 | 9 | -15.6 | -16.8 | -17.5 | -14.8 | -10.0 | 27.0 | 37.0 |
| | HT/VHT40 Beam Forming, M16 to M23 | 4 | 7 | -12.5 | -13.5 | -14.6 | -12.0 | -7.0 | 29.0 | 36.0 |
| | HT/VHT40 STBC, M0 to M7 | 2 | 6 | -8.1 | -9.4 | | | -5.7 | 30.0 | 35.7 |
| | HT/VHT40 STBC, M0 to M7 | 3 | 8 | -8.1 | -9.4 | -10.9 | | -4.5 | 29.0 | 33.0 |
| | HT/VHT40 STBC, M0 to M7 | 4 | 9 | -11.8 | -12.7 | -13.9 | -11.3 | -6.3 | 27.0 | 33.3 |
| | | | | | | | | | | |
| 5775 | Non HT80, 6 to 54 Mbps | 1 | 6 | -5.1 | | | | -5.1 | 30.0 | 35.1 |
| | Non HT80, 6 to 54 Mbps | 2 | 9 | -8.4 | -9.7 | | | -6.0 | 27.0 | 33.0 |
| | Non HT80, 6 to 54 Mbps | 3 | 11 | -8.4 | -9.7 | -9.9 | | -4.5 | 25.0 | 29.5 |
| | Non HT80, 6 to 54 Mbps | 4 | 12 | -13.1 | -13.8 | -14.5 | -12.5 | -7.4 | 24.0 | 31.4 |
| | VHT80, M0.1 to M9.1 | 1 | 6 | -5.9 | | | | -5.9 | 30.0 | 35.9 |
| | VHT80, M0.1 to M9.1 | 2 | 6 | -8.4 | -8.9 | | | -5.6 | 30.0 | 35.6 |
| | VHT80, M0.2 to M9.2 | 2 | 6 | -8.4 | -8.9 | | | -5.6 | 30.0 | 35.6 |
| | VHT80, M0.1 to M9.1 | 3 | 6 | -11.2 | -12.3 | -12.9 | | -7.3 | 30.0 | 37.3 |
| | VHT80, M0.2 to M9.2 | 3 | 6 | -11.2 | -12.3 | -12.9 | | -7.3 | 30.0 | 37.3 |
| | VHT80, M0.3 to M9.3 | 3 | 6 | -11.2 | -12.3 | -12.9 | | -7.3 | 30.0 | 37.3 |
| | VHT80, M0.1 to M9.1 | 4 | 6 | -12.0 | -13.4 | -14.0 | -11.4 | -6.6 | 30.0 | 36.6 |
| | VHT80, M0.2 to M9.2 | 4 | 6 | -12.0 | -13.4 | -14.0 | -11.4 | -6.6 | 30.0 | 36.6 |
| | VHT80, M0.3 to M9.3 | 4 | 6 | -12.0 | -13.4 | -14.0 | -11.4 | -6.6 | 30.0 | 36.6 |
| | VHT80 Beam Forming, M0.1 to M9.1 | 2 | 6 | -8.4 | -8.9 | | | -5.6 | 30.0 | 35.6 |
| | VHT80 Beam Forming, M0.2 to M9.2 | 2 | 6 | -8.4 | -8.9 | | | -5.6 | 30.0 | 35.6 |
| | VHT80 Beam Forming, M0.1 to M9.1 | 3 | 6 | -11.2 | -12.3 | -12.9 | | -7.3 | 30.0 | 37.3 |
| | VHT80 Beam Forming, M0.2 to M9.2 | 3 | 6 | -11.2 | -12.3 | -12.9 | | -7.3 | 30.0 | 37.3 |
| | VHT80 Beam Forming, M0.3 to M9.3 | 3 | 6 | -11.2 | -12.3 | -12.9 | | -7.3 | 30.0 | 37.3 |
| | VHT80 Beam Forming, M0.1 to M9.1 | 4 | 6 | -12.0 | -13.4 | -14.0 | -11.4 | -6.6 | 30.0 | 36.6 |
| | VHT80 Beam Forming, M0.2 to M9.2 | 4 | 6 | -12.0 | -13.4 | -14.0 | -11.4 | -6.6 | 30.0 | 36.6 |
| VHT80 Beam Forming, M0.3 to M9.3 | 4 | 6 | -12.0 | -13.4 | -14.0 | -11.4 | -6.6 | 30.0 | 36.6 | |
| VHT80 STBC, M0.1 to M9.1 | 2 | 6 | -8.4 | -8.9 | | | -5.6 | 30.0 | 35.6 | |



| | | | | | | | | | | |
|-------------------------|-------------------------------------|----------|-----------|------------|------------|------------|------------|------------|-------------|-------------|
| | VHT80 STBC, M0.1 to M9.1 | 3 | 6 | -11.2 | -12.3 | -12.9 | | -7.3 | 30.0 | 37.3 |
| | VHT80 STBC, M0.1 to M9.1 | 4 | 6 | -12.0 | -13.4 | -14.0 | -11.4 | -6.6 | 30.0 | 36.6 |
| 5785 | Non HT20, 6 to 54 Mbps | 1 | 6 | 0.7 | | | | 0.7 | 30.0 | 29.3 |
| | Non HT20, 6 to 54 Mbps | 2 | 9 | 0.7 | 0.5 | | | 3.6 | 27.0 | 23.4 |
| | Non HT20, 6 to 54 Mbps | 3 | 11 | 0.7 | 0.5 | 0.7 | | 5.4 | 25.0 | 19.6 |
| | Non HT20, 6 to 54 Mbps | 4 | 12 | 0.7 | 0.5 | 0.7 | 2.3 | 7.1 | 24.0 | 16.8 |
| | Non HT20 Beam Forming, 6 to 54 Mbps | 2 | 9 | 0.7 | 0.5 | | | 3.6 | 27.0 | 23.4 |
| | Non HT20 Beam Forming, 6 to 54 Mbps | 3 | 11 | 0.7 | 0.5 | 0.7 | | 5.4 | 25.0 | 19.6 |
| | Non HT20 Beam Forming, 6 to 54 Mbps | 4 | 12 | 0.7 | 0.5 | 0.7 | 2.3 | 7.1 | 24.0 | 16.8 |
| | HT/VHT20, M0 to M7 | 1 | 6 | 0.9 | | | | 0.9 | 30.0 | 29.1 |
| | HT/VHT20, M0 to M7 | 2 | 9 | 0.9 | 0.7 | | | 3.8 | 27.0 | 23.2 |
| | HT/VHT20, M8 to M15 | 2 | 6 | 0.9 | 0.7 | | | 3.8 | 30.0 | 26.2 |
| | HT/VHT20, M0 to M7 | 3 | 11 | 0.9 | 0.7 | 0.3 | | 5.4 | 25.0 | 19.6 |
| | HT/VHT20, M8 to M15 | 3 | 8 | 0.9 | 0.7 | 0.3 | | 5.4 | 28.0 | 22.6 |
| | HT/VHT20, M16 to M23 | 3 | 6 | 0.9 | 0.7 | 0.3 | | 5.4 | 30.0 | 24.6 |
| | HT/VHT20, M0 to M7 | 4 | 12 | 0.9 | 0.7 | 0.3 | 2.4 | 7.2 | 24.0 | 16.8 |
| | HT/VHT20, M8 to M15 | 4 | 9 | 0.9 | 0.7 | 0.3 | 2.4 | 7.2 | 27.0 | 19.8 |
| | HT/VHT20, M16 to M23 | 4 | 7 | 0.9 | 0.7 | 0.3 | 2.4 | 7.2 | 29.0 | 21.8 |
| | HT/VHT20 Beam Forming, M0 to M7 | 2 | 9 | 0.9 | 0.7 | | | 3.8 | 27.0 | 23.2 |
| | HT/VHT20 Beam Forming, M8 to M15 | 2 | 6 | 0.9 | 0.7 | | | 3.8 | 30.0 | 26.2 |
| | HT/VHT20 Beam Forming, M0 to M7 | 3 | 11 | 0.9 | 0.7 | 0.3 | | 5.4 | 25.0 | 19.6 |
| | HT/VHT20 Beam Forming, M8 to M15 | 3 | 8 | 0.9 | 0.7 | 0.3 | | 5.4 | 28.0 | 22.6 |
| | HT/VHT20 Beam Forming, M16 to M23 | 3 | 6 | 0.9 | 0.7 | 0.3 | | 5.4 | 30.0 | 24.6 |
| | HT/VHT20 Beam Forming, M0 to M7 | 4 | 12 | 0.9 | 0.7 | 0.3 | 2.4 | 7.2 | 24.0 | 16.8 |
| | HT/VHT20 Beam Forming, M8 to M15 | 4 | 9 | 0.9 | 0.7 | 0.3 | 2.4 | 7.2 | 27.0 | 19.8 |
| | HT/VHT20 Beam Forming, M16 to M23 | 4 | 7 | 0.9 | 0.7 | 0.3 | 2.4 | 7.2 | 29.0 | 21.8 |
| | HT/VHT20 STBC, M0 to M7 | 2 | 6 | 0.9 | 0.7 | | | 3.8 | 30.0 | 26.2 |
| | HT/VHT20 STBC, M0 to M7 | 3 | 8 | 0.9 | 0.7 | 0.3 | | 5.4 | 28.0 | 22.6 |
| HT/VHT20 STBC, M0 to M7 | 4 | 9 | 0.9 | 0.7 | 0.3 | 2.4 | 7.2 | 27.0 | 19.8 | |
| 5795 | Non HT40, 6 to 54 Mbps | 1 | 6 | -2.3 | | | | -2.3 | 30.0 | 32.3 |
| | Non HT40, 6 to 54 Mbps | 2 | 9 | -2.3 | -1.9 | | | 0.9 | 27.0 | 26.1 |
| | Non HT40, 6 to 54 Mbps | 3 | 11 | -2.3 | -1.9 | -1.5 | | 2.9 | 25.0 | 22.1 |
| | Non HT40, 6 to 54 Mbps | 4 | 12 | -3.3 | -2.9 | -2.1 | -1.4 | 3.7 | 24.0 | 20.3 |
| | HT/VHT40, M0 to M7 | 1 | 6 | -2.5 | | | | -2.5 | 30.0 | 32.5 |
| | HT/VHT40, M0 to M7 | 2 | 9 | -2.5 | -3.2 | | | 0.2 | 27.0 | 26.8 |
| | HT/VHT40, M8 to M15 | 2 | 6 | -2.5 | -3.2 | | | 0.2 | 30.0 | 29.8 |
| | HT/VHT40, M0 to M7 | 3 | 11 | -2.5 | -3.2 | -2.7 | | 2.0 | 25.0 | 23.0 |
| | HT/VHT40, M8 to M15 | 3 | 8 | -2.5 | -3.2 | -2.7 | | 2.0 | 28.0 | 26.1 |
| | HT/VHT40, M16 to M23 | 3 | 6 | -2.5 | -3.2 | -2.7 | | 2.0 | 30.0 | 28.0 |



| | | | | | | | | | | |
|------|-------------------------------------|---|----|-------|-------|-------|------|------|------|------|
| | HT/VHT40, M0 to M7 | 4 | 12 | -2.5 | -3.2 | -2.7 | -0.6 | 3.9 | 24.0 | 20.1 |
| | HT/VHT40, M8 to M15 | 4 | 9 | -2.5 | -3.2 | -2.7 | -0.6 | 3.9 | 27.0 | 23.1 |
| | HT/VHT40, M16 to M23 | 4 | 7 | -2.5 | -3.2 | -2.7 | -0.6 | 3.9 | 29.0 | 25.1 |
| | HT/VHT40 Beam Forming, M0 to M7 | 2 | 9 | -2.5 | -3.2 | | | 0.2 | 27.0 | 26.8 |
| | HT/VHT40 Beam Forming, M8 to M15 | 2 | 6 | -2.5 | -3.2 | | | 0.2 | 30.0 | 29.8 |
| | HT/VHT40 Beam Forming, M0 to M7 | 3 | 11 | -2.5 | -3.2 | -2.7 | | 2.0 | 25.0 | 23.0 |
| | HT/VHT40 Beam Forming, M8 to M15 | 3 | 8 | -2.5 | -3.2 | -2.7 | | 2.0 | 28.0 | 26.1 |
| | HT/VHT40 Beam Forming, M16 to M23 | 3 | 6 | -2.5 | -3.2 | -2.7 | | 2.0 | 30.0 | 28.0 |
| | HT/VHT40 Beam Forming, M0 to M7 | 4 | 12 | -2.5 | -3.2 | -2.7 | -0.6 | 3.9 | 24.0 | 20.1 |
| | HT/VHT40 Beam Forming, M8 to M15 | 4 | 9 | -2.5 | -3.2 | -2.7 | -0.6 | 3.9 | 27.0 | 23.1 |
| | HT/VHT40 Beam Forming, M16 to M23 | 4 | 7 | -2.5 | -3.2 | -2.7 | -0.6 | 3.9 | 29.0 | 25.1 |
| | HT/VHT40 STBC, M0 to M7 | 2 | 6 | -2.5 | -3.2 | | | 0.2 | 30.0 | 29.8 |
| | HT/VHT40 STBC, M0 to M7 | 3 | 8 | -2.5 | -3.2 | -2.7 | | 2.0 | 28.0 | 26.1 |
| | HT/VHT40 STBC, M0 to M7 | 4 | 9 | -2.5 | -3.2 | -2.7 | -0.6 | 3.9 | 27.0 | 23.1 |
| | | | | | | | | | | |
| 5825 | Non HT20, 6 to 54 Mbps | 1 | 6 | 1.6 | | | | 1.6 | 30.0 | 28.4 |
| | Non HT20, 6 to 54 Mbps | 2 | 9 | 0.2 | -0.5 | | | 2.9 | 27.0 | 24.1 |
| | Non HT20, 6 to 54 Mbps | 3 | 11 | -1.6 | -3.0 | -2.4 | | 2.5 | 25.0 | 22.6 |
| | Non HT20, 6 to 54 Mbps | 4 | 12 | -4.7 | -4.8 | -4.4 | -3.2 | 1.8 | 24.0 | 22.2 |
| | Non HT20 Beam Forming, 6 to 54 Mbps | 2 | 9 | -3.4 | -3.7 | | | -0.5 | 27.0 | 27.5 |
| | Non HT20 Beam Forming, 6 to 54 Mbps | 3 | 11 | -7.5 | -8.0 | -7.1 | | -2.7 | 25.0 | 27.7 |
| | Non HT20 Beam Forming, 6 to 54 Mbps | 4 | 12 | -10.5 | -11.0 | -10.3 | -9.3 | -4.2 | 24.0 | 28.2 |
| | HT/VHT20, M0 to M7 | 1 | 6 | 1.5 | | | | 1.5 | 30.0 | 28.5 |
| | HT/VHT20, M0 to M7 | 2 | 9 | 0.3 | -0.6 | | | 2.9 | 27.0 | 24.1 |
| | HT/VHT20, M8 to M15 | 2 | 6 | 0.3 | -0.6 | | | 2.9 | 30.0 | 27.1 |
| | HT/VHT20, M0 to M7 | 3 | 11 | -2.4 | -2.8 | -2.5 | | 2.2 | 25.0 | 22.8 |
| | HT/VHT20, M8 to M15 | 3 | 8 | -2.4 | -2.8 | -2.5 | | 2.2 | 28.0 | 25.8 |
| | HT/VHT20, M16 to M23 | 3 | 6 | -2.4 | -2.8 | -2.5 | | 2.2 | 30.0 | 27.8 |
| | HT/VHT20, M0 to M7 | 4 | 12 | -4.7 | -4.3 | -4.0 | -3.4 | 1.9 | 24.0 | 22.0 |
| | HT/VHT20, M8 to M15 | 4 | 9 | -4.7 | -4.3 | -4.0 | -3.4 | 1.9 | 27.0 | 25.0 |
| | HT/VHT20, M16 to M23 | 4 | 7 | -4.7 | -4.3 | -4.0 | -3.4 | 1.9 | 29.0 | 27.1 |
| | HT/VHT20 Beam Forming, M0 to M7 | 2 | 9 | -3.7 | -4.0 | | | -0.8 | 27.0 | 27.8 |
| | HT/VHT20 Beam Forming, M8 to M15 | 2 | 6 | 0.3 | -0.6 | | | 2.9 | 30.0 | 27.1 |
| | HT/VHT20 Beam Forming, M0 to M7 | 3 | 11 | -6.6 | -6.5 | -6.2 | | -1.7 | 25.0 | 26.7 |
| | HT/VHT20 Beam Forming, M8 to M15 | 3 | 8 | -4.7 | -4.3 | -4.0 | | 0.4 | 28.0 | 27.6 |
| | HT/VHT20 Beam Forming, M16 to M23 | 3 | 6 | -2.4 | -2.8 | -2.5 | | 2.2 | 30.0 | 27.8 |
| | HT/VHT20 Beam Forming, M0 to M7 | 4 | 12 | -10.2 | -10.9 | -10.3 | -9.3 | -4.1 | 24.0 | 28.1 |
| | HT/VHT20 Beam Forming, M8 to M15 | 4 | 9 | -6.6 | -6.5 | -6.2 | -5.3 | -0.1 | 27.0 | 27.1 |
| | HT/VHT20 Beam Forming, M16 to M23 | 4 | 7 | -4.7 | -4.3 | -4.0 | -3.4 | 1.9 | 29.0 | 27.1 |
| | HT/VHT20 STBC, M0 to M7 | 2 | 6 | 0.3 | -0.6 | | | 2.9 | 30.0 | 27.1 |
| | HT/VHT20 STBC, M0 to M7 | 3 | 8 | -2.4 | -2.8 | -2.5 | | 2.2 | 28.0 | 25.8 |



| | | | | | | | | | |
|-------------------------|---|---|------|------|------|------|-----|------|------|
| HT/VHT20 STBC, M0 to M7 | 4 | 9 | -4.7 | -4.3 | -4.0 | -3.4 | 1.9 | 27.0 | 25.0 |
|-------------------------|---|---|------|------|------|------|-----|------|------|

Power Spectral Density, 5785 MHz, HT/VHT20 Beam Forming, M0 to M7

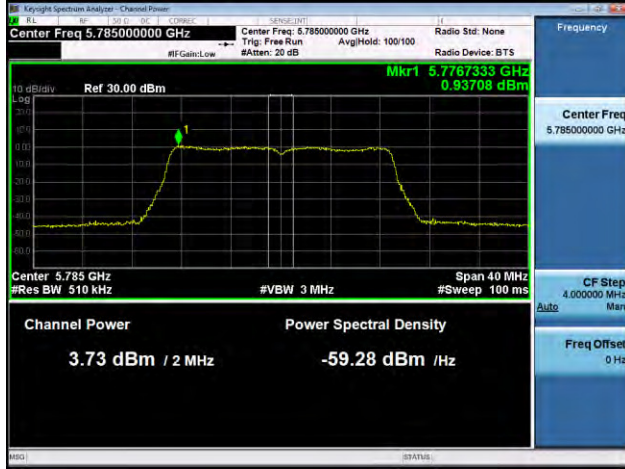

Antenna A

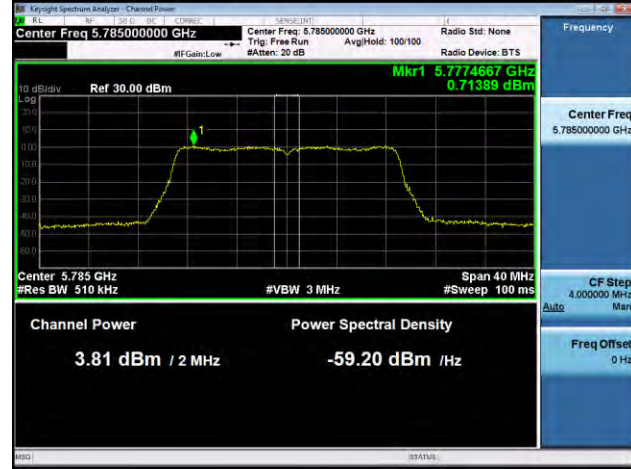

Antenna B



Antenna C

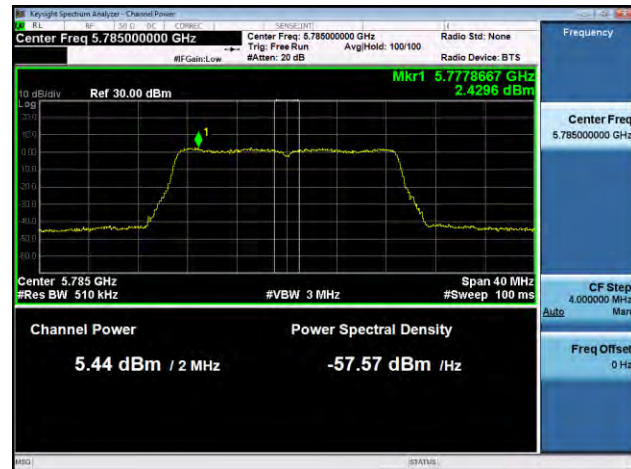

Antenna D



A.5 Conducted Spurious Emissions

15.407 (b) Undesirable emission limits. Except as shown in paragraph (b) (7) of this section, the maximum emissions outside of the frequency bands of operation shall be attenuated in accordance with the following limits:

(4) For transmitters operating in the 5.725-5.85 GHz band: All emissions within the frequency range from the band edge to 10 MHz above or below the band edge shall not exceed an e.i.r.p. of -17 dBm/MHz; for frequencies 10 MHz or greater above or below the band edge, emissions shall not exceed an e.i.r.p. of -27 dBm/MHz.

(6) Unwanted emissions below 1 GHz must comply with the general field strength limits set forth in §15.209.

(7) The provisions of §15.205 apply to intentional radiators operating under this section.

Test Procedure

Ref. KDB 789033 D02 General UNII Test Procedures New Rules v01r01
ANSI C63.10: 2013

| Conducted Spurious Emissions | |
|---|--|
| Test Procedure | |
| 1. Connect the antenna port(s) to the spectrum analyzer input. 2. Place the radio in continuous transmit mode. Use the procedures in KDB 789033 D02 General UNII Test Procedures New Rules v01 to substitute conducted measurements in place of radiated measurements. 3. Configure Spectrum analyzer as per test parameters below (be sure to enter all losses between the transmitter output and the spectrum analyzer). 4. Record the marker waveform peak to spur difference. Also measure any emissions in the restricted bands. 5. The "measure-and-sum technique" is used for measuring in-band transmit power of a device. In the measure-and-sum approach, the conducted emission level is measured at each antenna port. The measured results at the various antenna ports are then summed mathematically to determine the total emission level from the device. Summing is performed in linear power units. The worst case output is recorded. 6. Capture graphs and record pertinent measurement data. | |

Ref. KDB 789033 D02 General UNII Test Procedures New Rules v01r01
ANSI C63.10: 2013 section 12.7.7.3 (average) & 12.7.6 (peak)

| Conducted Spurious Emissions | |
|--|--|
| Test parameters | |
| Span = 30MHz to 18GHz / 18GHz to 40GHz RBW = 1 MHz VBW ≥ 3 x RBW for Peak, 1kHz for Average Sweep = Auto couple Detector = Peak Trace = Max Hold. | |

| System Number | Description | Samples | System under test | Support equipment |
|---------------|-------------|---------|-------------------------------------|-------------------------------------|
| 1 | EUT | S01 | <input checked="" type="checkbox"/> | <input type="checkbox"/> |
| | Support | S02 | <input type="checkbox"/> | <input checked="" type="checkbox"/> |

| | |
|------------------------------------|--|
| Tested By : Jose Aguirre | Date of testing: 01-Jan-16 - 22-Feb-16 |
| Test Result : PASS | |

See Appendix C for list of test equipment



| Frequency (MHz) | Mode | Tx Paths | Correlated Antenna Gain (dBi) | Tx 1 Spur Power (dBm) | Tx 2 Spur Power (dBm) | Tx 3 Spur Power (dBm) | Tx 4 Spur Power (dBm) | Total Conducted Spur (dBm) | Limit (dBm) | Margin (dB) |
|------------------------|--|------------------------|-------------------------------|-----------------------|-----------------------|-----------------------|-----------------------|----------------------------|---------------|-------------|
| 5745 | Non HT20, 6 to 54 Mbps | 1 | 6 | -69.2 | | | | -63.2 | -41.25 | 22.0 |
| | Non HT20, 6 to 54 Mbps | 2 | 6 | -69.2 | -68.8 | | | -60.0 | -41.25 | 18.7 |
| | Non HT20, 6 to 54 Mbps | 3 | 6 | -69.2 | -68.8 | -66.6 | | -57.3 | -41.25 | 16.0 |
| | Non HT20, 6 to 54 Mbps | 4 | 6 | -69.2 | -68.8 | -66.6 | -68.6 | -56.2 | -41.25 | 14.9 |
| | Non HT20 Beam Forming, 6 to 54 Mbps | 2 | 9 | -69.2 | -68.8 | | | -57.0 | -41.25 | 15.7 |
| | Non HT20 Beam Forming, 6 to 54 Mbps | 3 | 11 | -69.2 | -68.8 | -66.6 | | -52.5 | -41.25 | 11.2 |
| | Non HT20 Beam Forming, 6 to 54 Mbps | 4 | 12 | -69.2 | -68.8 | -66.6 | -68.6 | -50.2 | -41.25 | 8.9 |
| | HT/VHT20, M0 to M7 | 1 | 6 | -69.1 | | | | -63.1 | -41.25 | 21.9 |
| | HT/VHT20, M0 to M7 | 2 | 6 | -69.1 | -68.7 | | | -59.9 | -41.25 | 18.6 |
| | HT/VHT20, M8 to M15 | 2 | 6 | -69.1 | -68.7 | | | -59.9 | -41.25 | 18.6 |
| | HT/VHT20, M0 to M7 | 3 | 6 | -69.1 | -68.7 | -69.1 | | -58.2 | -41.25 | 16.9 |
| | HT/VHT20, M8 to M15 | 3 | 6 | -69.1 | -68.7 | -69.1 | | -58.2 | -41.25 | 16.9 |
| | HT/VHT20, M16 to M23 | 3 | 6 | -69.1 | -68.7 | -69.1 | | -58.2 | -41.25 | 16.9 |
| | HT/VHT20, M0 to M7 | 4 | 6 | -69.1 | -68.7 | -69.1 | -68.9 | -56.9 | -41.25 | 15.7 |
| | HT/VHT20, M8 to M15 | 4 | 6 | -69.1 | -68.7 | -69.1 | -68.9 | -56.9 | -41.25 | 15.7 |
| | HT/VHT20, M16 to M23 | 4 | 6 | -69.1 | -68.7 | -69.1 | -68.9 | -56.9 | -41.25 | 15.7 |
| | HT/VHT20 Beam Forming, M0 to M7 | 2 | 9 | -69.1 | -68.7 | | | -56.9 | -41.25 | 15.6 |
| | HT/VHT20 Beam Forming, M8 to M15 | 2 | 6 | -69.1 | -68.7 | | | -59.9 | -41.25 | 18.6 |
| | HT/VHT20 Beam Forming, M0 to M7 | 3 | 11 | -69.1 | -68.7 | -69.1 | | -53.4 | -41.25 | 12.1 |
| | HT/VHT20 Beam Forming, M8 to M15 | 3 | 8 | -69.1 | -68.7 | -69.1 | | -56.4 | -41.25 | 15.1 |
| | HT/VHT20 Beam Forming, M16 to M23 | 3 | 6 | -69.1 | -68.7 | -69.1 | | -58.2 | -41.25 | 16.9 |
| | HT/VHT20 Beam Forming, M0 to M7 | 4 | 12 | -69.1 | -68.7 | -69.1 | -68.9 | -50.9 | -41.25 | 9.7 |
| | HT/VHT20 Beam Forming, M8 to M15 | 4 | 9 | -69.1 | -68.7 | -69.1 | -68.9 | -53.9 | -41.25 | 12.7 |
| | HT/VHT20 Beam Forming, M16 to M23 | 4 | 7 | -69.1 | -68.7 | -69.1 | -68.9 | -55.7 | -41.25 | 14.5 |
| | HT/VHT20 STBC, M0 to M7 | 2 | 6 | -69.1 | -68.7 | | | -59.9 | -41.25 | 18.6 |
| | HT/VHT20 STBC, M0 to M7 | 3 | 6 | -69.1 | -68.7 | -69.1 | | -58.2 | -41.25 | 16.9 |
| | HT/VHT20 STBC, M0 to M7 | 4 | 6 | -69.1 | -68.7 | -69.1 | -68.9 | -56.9 | -41.25 | 15.7 |
| | 5755 | Non HT40, 6 to 54 Mbps | 1 | 6 | -69.1 | | | | -63.1 | -41.25 |
| Non HT40, 6 to 54 Mbps | | 2 | 6 | -69.1 | -69.1 | | | -60.1 | -41.25 | 18.8 |
| Non HT40, 6 to 54 Mbps | | 3 | 6 | -69.1 | -69.1 | -69.3 | | -58.4 | -41.25 | 17.1 |
| Non HT40, 6 to 54 Mbps | | 4 | 6 | -69.1 | -69.1 | -69.3 | -69.2 | -57.2 | -41.25 | 15.9 |
| HT/VHT40, M0 to M7 | | 1 | 6 | -69.0 | | | | -63.0 | -41.25 | 21.8 |
| HT/VHT40, M0 to M7 | | 2 | 6 | -69.0 | -69.1 | | | -60.0 | -41.25 | 18.8 |



| | | | | | | | | | | |
|----------------------------------|-----------------------------------|---|-------|-------|-------|-------|-------|--------|--------|------|
| | HT/VHT40, M8 to M15 | 2 | 6 | -69.0 | -69.1 | | | -60.0 | -41.25 | 18.8 |
| | HT/VHT40, M0 to M7 | 3 | 6 | -69.0 | -69.1 | -69.2 | | -58.3 | -41.25 | 17.1 |
| | HT/VHT40, M8 to M15 | 3 | 6 | -69.0 | -69.1 | -69.2 | | -58.3 | -41.25 | 17.1 |
| | HT/VHT40, M16 to M23 | 3 | 6 | -69.0 | -69.1 | -69.2 | | -58.3 | -41.25 | 17.1 |
| | HT/VHT40, M0 to M7 | 4 | 6 | -69.0 | -69.1 | -69.2 | -69.1 | -57.1 | -41.25 | 15.8 |
| | HT/VHT40, M8 to M15 | 4 | 6 | -69.0 | -69.1 | -69.2 | -69.1 | -57.1 | -41.25 | 15.8 |
| | HT/VHT40, M16 to M23 | 4 | 6 | -69.0 | -69.1 | -69.2 | -69.1 | -57.1 | -41.25 | 15.8 |
| | HT/VHT40 Beam Forming, M0 to M7 | 2 | 9 | -69.0 | -69.1 | | | -57.0 | -41.25 | 15.8 |
| | HT/VHT40 Beam Forming, M8 to M15 | 2 | 6 | -69.0 | -69.1 | | | -60.0 | -41.25 | 18.8 |
| | HT/VHT40 Beam Forming, M0 to M7 | 3 | 11 | -69.0 | -69.1 | -69.2 | | -53.5 | -41.25 | 12.3 |
| | HT/VHT40 Beam Forming, M8 to M15 | 3 | 8 | -69.0 | -69.1 | -69.2 | | -56.5 | -41.25 | 15.3 |
| | HT/VHT40 Beam Forming, M16 to M23 | 3 | 6 | -69.0 | -69.1 | -69.2 | | -58.3 | -41.25 | 17.1 |
| | HT/VHT40 Beam Forming, M0 to M7 | 4 | 12 | -69.0 | -69.1 | -69.2 | -69.1 | -51.1 | -41.25 | 9.8 |
| | HT/VHT40 Beam Forming, M8 to M15 | 4 | 9 | -69.0 | -69.1 | -69.2 | -69.1 | -54.1 | -41.25 | 12.8 |
| | HT/VHT40 Beam Forming, M16 to M23 | 4 | 7 | -69.0 | -69.1 | -69.2 | -69.1 | -55.9 | -41.25 | 14.6 |
| | HT/VHT40 STBC, M0 to M7 | 2 | 6 | -69.0 | -69.1 | | | -60.0 | -41.25 | 18.8 |
| | HT/VHT40 STBC, M0 to M7 | 3 | 6 | -69.0 | -69.1 | -69.2 | | -58.3 | -41.25 | 17.1 |
| | HT/VHT40 STBC, M0 to M7 | 4 | 6 | -69.0 | -69.1 | -69.2 | -69.1 | -57.1 | -41.25 | 15.8 |
| | | | | | | | | | | |
| 5775 | Non HT80, 6 to 54 Mbps | 1 | 6 | -69.1 | | | | -63.1 | -41.25 | 21.9 |
| | Non HT80, 6 to 54 Mbps | 2 | 6 | -69.1 | -66.7 | | | -58.7 | -41.25 | 17.5 |
| | Non HT80, 6 to 54 Mbps | 3 | 6 | -69.1 | -66.7 | -69.2 | | -57.4 | -41.25 | 16.2 |
| | Non HT80, 6 to 54 Mbps | 4 | 6 | -69.1 | -66.7 | -69.2 | -69.1 | -56.4 | -41.25 | 15.1 |
| | VHT80, M0.1 to M9.1 | 1 | 6 | -69.2 | | | | -63.2 | -41.25 | 22.0 |
| | VHT80, M0.1 to M9.1 | 2 | 6 | -69.2 | -69.2 | | | -60.2 | -41.25 | 18.9 |
| | VHT80, M0.2 to M9.2 | 2 | 6 | -69.2 | -69.2 | | | -60.2 | -41.25 | 18.9 |
| | VHT80, M0.1 to M9.1 | 3 | 6 | -69.2 | -69.2 | -69.2 | | -58.4 | -41.25 | 17.2 |
| | VHT80, M0.2 to M9.2 | 3 | 6 | -69.2 | -69.2 | -69.2 | | -58.4 | -41.25 | 17.2 |
| | VHT80, M0.3 to M9.3 | 3 | 6 | -69.2 | -69.2 | -69.2 | | -58.4 | -41.25 | 17.2 |
| | VHT80, M0.1 to M9.1 | 4 | 6 | -69.2 | -69.2 | -69.2 | -69.2 | -57.2 | -41.25 | 15.9 |
| | VHT80, M0.2 to M9.2 | 4 | 6 | -69.2 | -69.2 | -69.2 | -69.2 | -57.2 | -41.25 | 15.9 |
| | VHT80, M0.3 to M9.3 | 4 | 6 | -69.2 | -69.2 | -69.2 | -69.2 | -57.2 | -41.25 | 15.9 |
| | VHT80 Beam Forming, M0.1 to M9.1 | 2 | 6 | -69.2 | -69.2 | | | -60.2 | -41.25 | 18.9 |
| | VHT80 Beam Forming, M0.2 to M9.2 | 2 | 6 | -69.2 | -69.2 | | | -60.2 | -41.25 | 18.9 |
| | VHT80 Beam Forming, M0.1 to M9.1 | 3 | 6 | -69.2 | -69.2 | -69.2 | | -58.4 | -41.25 | 17.2 |
| | VHT80 Beam Forming, M0.2 to M9.2 | 3 | 6 | -69.2 | -69.2 | -69.2 | | -58.4 | -41.25 | 17.2 |
| | VHT80 Beam Forming, M0.3 to M9.3 | 3 | 6 | -69.2 | -69.2 | -69.2 | | -58.4 | -41.25 | 17.2 |
| | VHT80 Beam Forming, M0.1 to M9.1 | 4 | 6 | -69.2 | -69.2 | -69.2 | -69.2 | -57.2 | -41.25 | 15.9 |
| | VHT80 Beam Forming, M0.2 to M9.2 | 4 | 6 | -69.2 | -69.2 | -69.2 | -69.2 | -57.2 | -41.25 | 15.9 |
| VHT80 Beam Forming, M0.3 to M9.3 | 4 | 6 | -69.2 | -69.2 | -69.2 | -69.2 | -57.2 | -41.25 | 15.9 | |
| VHT80 STBC, M0.1 to M9.1 | 2 | 6 | -69.2 | -69.2 | | | -60.2 | -41.25 | 18.9 | |



| | | | | | | | | | | |
|-------------------------|-------------------------------------|---|-------|-------|-------|-------|-------|--------|--------|------|
| | VHT80 STBC, M0.1 to M9.1 | 3 | 6 | -69.2 | -69.2 | -69.2 | | -58.4 | -41.25 | 17.2 |
| | VHT80 STBC, M0.1 to M9.1 | 4 | 6 | -69.2 | -69.2 | -69.2 | -69.2 | -57.2 | -41.25 | 15.9 |
| 5785 | Non HT20, 6 to 54 Mbps | 1 | 6 | -69.3 | | | | -63.3 | -41.25 | 22.1 |
| | Non HT20, 6 to 54 Mbps | 2 | 6 | -69.3 | -69.0 | | | -60.1 | -41.25 | 18.9 |
| | Non HT20, 6 to 54 Mbps | 3 | 6 | -69.3 | -69.0 | -68.7 | | -58.2 | -41.25 | 17.0 |
| | Non HT20, 6 to 54 Mbps | 4 | 6 | -69.3 | -69.0 | -68.7 | -66.8 | -56.3 | -41.25 | 15.1 |
| | Non HT20 Beam Forming, 6 to 54 Mbps | 2 | 9 | -69.3 | -69.0 | | | -57.1 | -41.25 | 15.9 |
| | Non HT20 Beam Forming, 6 to 54 Mbps | 3 | 11 | -69.3 | -69.0 | -68.7 | | -53.4 | -41.25 | 12.2 |
| | Non HT20 Beam Forming, 6 to 54 Mbps | 4 | 12 | -69.3 | -69.0 | -68.7 | -66.8 | -50.3 | -41.25 | 9.1 |
| | HT/VHT20, M0 to M7 | 1 | 6 | -69.3 | | | | -63.3 | -41.25 | 22.1 |
| | HT/VHT20, M0 to M7 | 2 | 6 | -69.3 | -69.0 | | | -60.1 | -41.25 | 18.9 |
| | HT/VHT20, M8 to M15 | 2 | 6 | -69.3 | -69.0 | | | -60.1 | -41.25 | 18.9 |
| | HT/VHT20, M0 to M7 | 3 | 6 | -69.3 | -69.0 | -69.1 | | -58.4 | -41.25 | 17.1 |
| | HT/VHT20, M8 to M15 | 3 | 6 | -69.3 | -69.0 | -69.1 | | -58.4 | -41.25 | 17.1 |
| | HT/VHT20, M16 to M23 | 3 | 6 | -69.3 | -69.0 | -69.1 | | -58.4 | -41.25 | 17.1 |
| | HT/VHT20, M0 to M7 | 4 | 6 | -69.3 | -69.0 | -69.1 | -69.0 | -57.1 | -41.25 | 15.8 |
| | HT/VHT20, M8 to M15 | 4 | 6 | -69.3 | -69.0 | -69.1 | -69.0 | -57.1 | -41.25 | 15.8 |
| | HT/VHT20, M16 to M23 | 4 | 6 | -69.3 | -69.0 | -69.1 | -69.0 | -57.1 | -41.25 | 15.8 |
| | HT/VHT20 Beam Forming, M0 to M7 | 2 | 9 | -69.3 | -69.0 | | | -57.1 | -41.25 | 15.9 |
| | HT/VHT20 Beam Forming, M8 to M15 | 2 | 6 | -69.3 | -69.0 | | | -60.1 | -41.25 | 18.9 |
| | HT/VHT20 Beam Forming, M0 to M7 | 3 | 11 | -69.3 | -69.0 | -69.1 | | -53.6 | -41.25 | 12.3 |
| | HT/VHT20 Beam Forming, M8 to M15 | 3 | 8 | -69.3 | -69.0 | -69.1 | | -56.6 | -41.25 | 15.3 |
| | HT/VHT20 Beam Forming, M16 to M23 | 3 | 6 | -69.3 | -69.0 | -69.1 | | -58.4 | -41.25 | 17.1 |
| | HT/VHT20 Beam Forming, M0 to M7 | 4 | 12 | -69.3 | -69.0 | -69.1 | -69.0 | -51.1 | -41.25 | 9.8 |
| | HT/VHT20 Beam Forming, M8 to M15 | 4 | 9 | -69.3 | -69.0 | -69.1 | -69.0 | -54.1 | -41.25 | 12.8 |
| | HT/VHT20 Beam Forming, M16 to M23 | 4 | 7 | -69.3 | -69.0 | -69.1 | -69.0 | -55.9 | -41.25 | 14.6 |
| HT/VHT20 STBC, M0 to M7 | 2 | 6 | -69.3 | -69.0 | | | -60.1 | -41.25 | 18.9 | |
| HT/VHT20 STBC, M0 to M7 | 3 | 6 | -69.3 | -69.0 | -69.1 | | -58.4 | -41.25 | 17.1 | |
| HT/VHT20 STBC, M0 to M7 | 4 | 6 | -69.3 | -69.0 | -69.1 | -69.0 | -57.1 | -41.25 | 15.8 | |
| 5795 | Non HT40, 6 to 54 Mbps | 1 | 6 | -69.5 | | | | -63.5 | -41.25 | 22.3 |
| | Non HT40, 6 to 54 Mbps | 2 | 6 | -69.5 | -66.7 | | | -58.9 | -41.25 | 17.6 |
| | Non HT40, 6 to 54 Mbps | 3 | 6 | -69.5 | -66.7 | -69.3 | | -57.5 | -41.25 | 16.3 |
| | Non HT40, 6 to 54 Mbps | 4 | 6 | -69.5 | -66.7 | -69.3 | -69.3 | -56.5 | -41.25 | 15.3 |
| | HT/VHT40, M0 to M7 | 1 | 6 | -69.2 | | | | -63.2 | -41.25 | 22.0 |
| | HT/VHT40, M0 to M7 | 2 | 6 | -69.2 | -69.5 | | | -60.3 | -41.25 | 19.1 |
| | HT/VHT40, M8 to M15 | 2 | 6 | -69.2 | -69.5 | | | -60.3 | -41.25 | 19.1 |
| | HT/VHT40, M0 to M7 | 3 | 6 | -69.2 | -69.5 | -69.4 | | -58.6 | -41.25 | 17.3 |
| | HT/VHT40, M8 to M15 | 3 | 6 | -69.2 | -69.5 | -69.4 | | -58.6 | -41.25 | 17.3 |
| | HT/VHT40, M16 to M23 | 3 | 6 | -69.2 | -69.5 | -69.4 | | -58.6 | -41.25 | 17.3 |



| | | | | | | | | | | |
|-----------------------------------|-------------------------------------|---|-------|-------|-------|-------|-------|--------|--------|------|
| | HT/VHT40, M0 to M7 | 4 | 6 | -69.2 | -69.5 | -69.4 | -69.4 | -57.4 | -41.25 | 16.1 |
| | HT/VHT40, M8 to M15 | 4 | 6 | -69.2 | -69.5 | -69.4 | -69.4 | -57.4 | -41.25 | 16.1 |
| | HT/VHT40, M16 to M23 | 4 | 6 | -69.2 | -69.5 | -69.4 | -69.4 | -57.4 | -41.25 | 16.1 |
| | HT/VHT40 Beam Forming, M0 to M7 | 2 | 9 | -69.2 | -69.5 | | | -57.3 | -41.25 | 16.1 |
| | HT/VHT40 Beam Forming, M8 to M15 | 2 | 6 | -69.2 | -69.5 | | | -60.3 | -41.25 | 19.1 |
| | HT/VHT40 Beam Forming, M0 to M7 | 3 | 11 | -69.2 | -69.5 | -69.4 | | -53.8 | -41.25 | 12.5 |
| | HT/VHT40 Beam Forming, M8 to M15 | 3 | 8 | -69.2 | -69.5 | -69.4 | | -56.8 | -41.25 | 15.5 |
| | HT/VHT40 Beam Forming, M16 to M23 | 3 | 6 | -69.2 | -69.5 | -69.4 | | -58.6 | -41.25 | 17.3 |
| | HT/VHT40 Beam Forming, M0 to M7 | 4 | 12 | -69.2 | -69.5 | -69.4 | -69.4 | -51.4 | -41.25 | 10.1 |
| | HT/VHT40 Beam Forming, M8 to M15 | 4 | 9 | -69.2 | -69.5 | -69.4 | -69.4 | -54.4 | -41.25 | 13.1 |
| | HT/VHT40 Beam Forming, M16 to M23 | 4 | 7 | -69.2 | -69.5 | -69.4 | -69.4 | -56.2 | -41.25 | 14.9 |
| | HT/VHT40 STBC, M0 to M7 | 2 | 6 | -69.2 | -69.5 | | | -60.3 | -41.25 | 19.1 |
| | HT/VHT40 STBC, M0 to M7 | 3 | 6 | -69.2 | -69.5 | -69.4 | | -58.6 | -41.25 | 17.3 |
| | HT/VHT40 STBC, M0 to M7 | 4 | 6 | -69.2 | -69.5 | -69.4 | -69.4 | -57.4 | -41.25 | 16.1 |
| | | | | | | | | | | |
| 5825 | Non HT20, 6 to 54 Mbps | 1 | 6 | -69.3 | | | | -63.3 | -41.25 | 22.1 |
| | Non HT20, 6 to 54 Mbps | 2 | 6 | -69.3 | -66.9 | | | -58.9 | -41.25 | 17.7 |
| | Non HT20, 6 to 54 Mbps | 3 | 6 | -69.3 | -66.9 | -69.3 | | -57.6 | -41.25 | 16.3 |
| | Non HT20, 6 to 54 Mbps | 4 | 6 | -69.3 | -66.9 | -69.3 | -69.0 | -56.5 | -41.25 | 15.2 |
| | Non HT20 Beam Forming, 6 to 54 Mbps | 2 | 9 | -69.3 | -66.9 | | | -55.9 | -41.25 | 14.7 |
| | Non HT20 Beam Forming, 6 to 54 Mbps | 3 | 11 | -69.3 | -66.9 | -69.3 | | -52.8 | -41.25 | 11.5 |
| | Non HT20 Beam Forming, 6 to 54 Mbps | 4 | 12 | -69.3 | -66.9 | -69.3 | -69.0 | -50.5 | -41.25 | 9.2 |
| | HT/VHT20, M0 to M7 | 1 | 6 | -69.1 | | | | -63.1 | -41.25 | 21.9 |
| | HT/VHT20, M0 to M7 | 2 | 6 | -69.1 | -69.2 | | | -60.1 | -41.25 | 18.9 |
| | HT/VHT20, M8 to M15 | 2 | 6 | -69.1 | -69.2 | | | -60.1 | -41.25 | 18.9 |
| | HT/VHT20, M0 to M7 | 3 | 6 | -69.1 | -69.2 | -69.2 | | -58.4 | -41.25 | 17.1 |
| | HT/VHT20, M8 to M15 | 3 | 6 | -69.1 | -69.2 | -69.2 | | -58.4 | -41.25 | 17.1 |
| | HT/VHT20, M16 to M23 | 3 | 6 | -69.1 | -69.2 | -69.2 | | -58.4 | -41.25 | 17.1 |
| | HT/VHT20, M0 to M7 | 4 | 6 | -69.1 | -69.2 | -69.2 | -69.3 | -57.2 | -41.25 | 15.9 |
| | HT/VHT20, M8 to M15 | 4 | 6 | -69.1 | -69.2 | -69.2 | -69.3 | -57.2 | -41.25 | 15.9 |
| | HT/VHT20, M16 to M23 | 4 | 6 | -69.1 | -69.2 | -69.2 | -69.3 | -57.2 | -41.25 | 15.9 |
| | HT/VHT20 Beam Forming, M0 to M7 | 2 | 9 | -69.1 | -69.2 | | | -57.1 | -41.25 | 15.9 |
| | HT/VHT20 Beam Forming, M8 to M15 | 2 | 6 | -69.1 | -69.2 | | | -60.1 | -41.25 | 18.9 |
| | HT/VHT20 Beam Forming, M0 to M7 | 3 | 11 | -69.1 | -69.2 | -69.2 | | -53.6 | -41.25 | 12.3 |
| | HT/VHT20 Beam Forming, M8 to M15 | 3 | 8 | -69.1 | -69.2 | -69.2 | | -56.6 | -41.25 | 15.3 |
| | HT/VHT20 Beam Forming, M16 to M23 | 3 | 6 | -69.1 | -69.2 | -69.2 | | -58.4 | -41.25 | 17.1 |
| | HT/VHT20 Beam Forming, M0 to M7 | 4 | 12 | -69.1 | -69.2 | -69.2 | -69.3 | -51.2 | -41.25 | 9.9 |
| | HT/VHT20 Beam Forming, M8 to M15 | 4 | 9 | -69.1 | -69.2 | -69.2 | -69.3 | -54.2 | -41.25 | 12.9 |
| HT/VHT20 Beam Forming, M16 to M23 | 4 | 7 | -69.1 | -69.2 | -69.2 | -69.3 | -56.0 | -41.25 | 14.7 | |
| HT/VHT20 STBC, M0 to M7 | 2 | 6 | -69.1 | -69.2 | | | -60.1 | -41.25 | 18.9 | |
| HT/VHT20 STBC, M0 to M7 | 3 | 6 | -69.1 | -69.2 | -69.2 | | -58.4 | -41.25 | 17.1 | |



| | | | | | | | | | |
|-------------------------|---|---|-------|-------|-------|-------|-------|--------|------|
| HT/VHT20 STBC, M0 to M7 | 4 | 6 | -69.1 | -69.2 | -69.2 | -69.3 | -57.2 | -41.25 | 15.9 |
|-------------------------|---|---|-------|-------|-------|-------|-------|--------|------|



| Frequency (MHz) | Mode | Tx Paths | Correlated Antenna Gain (dBi) | Tx 1 Spur Power (dBm) | Tx 2 Spur Power (dBm) | Tx 3 Spur Power (dBm) | Tx 4 Spur Power (dBm) | Total Conducted Spur (dBm) | Limit (dBm) | Margin (dB) |
|-------------------------|-------------------------------------|----------|-------------------------------|-----------------------|-----------------------|-----------------------|-----------------------|----------------------------|-------------|-------------|
| 5745 | Non HT20, 6 to 54 Mbps | 1 | 6 | -60.4 | | | | -54.4 | -21.25 | 33.2 |
| | Non HT20, 6 to 54 Mbps | 2 | 6 | -60.4 | -57.6 | | | -49.8 | -21.25 | 28.5 |
| | Non HT20, 6 to 54 Mbps | 3 | 6 | -60.4 | -57.6 | -60.6 | | -48.5 | -21.25 | 27.3 |
| | Non HT20, 6 to 54 Mbps | 4 | 6 | -60.4 | -57.6 | -60.6 | -58.9 | -47.2 | -21.25 | 25.9 |
| | Non HT20 Beam Forming, 6 to 54 Mbps | 2 | 9 | -60.4 | -57.6 | | | -46.8 | -21.25 | 25.5 |
| | Non HT20 Beam Forming, 6 to 54 Mbps | 3 | 11 | -60.4 | -57.6 | -60.6 | | -43.7 | -21.25 | 22.5 |
| | Non HT20 Beam Forming, 6 to 54 Mbps | 4 | 12 | -60.4 | -57.6 | -60.6 | -58.9 | -41.2 | -21.25 | 19.9 |
| | HT/VHT20, M0 to M7 | 1 | 6 | -58.4 | | | | -52.4 | -21.25 | 31.2 |
| | HT/VHT20, M0 to M7 | 2 | 6 | -58.4 | -59.7 | | | -50.0 | -21.25 | 28.7 |
| | HT/VHT20, M8 to M15 | 2 | 6 | -58.4 | -59.7 | | | -50.0 | -21.25 | 28.7 |
| | HT/VHT20, M0 to M7 | 3 | 6 | -58.4 | -59.7 | -60.2 | | -48.6 | -21.25 | 27.3 |
| | HT/VHT20, M8 to M15 | 3 | 6 | -58.4 | -59.7 | -60.2 | | -48.6 | -21.25 | 27.3 |
| | HT/VHT20, M16 to M23 | 3 | 6 | -58.4 | -59.7 | -60.2 | | -48.6 | -21.25 | 27.3 |
| | HT/VHT20, M0 to M7 | 4 | 6 | -58.4 | -59.7 | -60.2 | -60.4 | -47.6 | -21.25 | 26.3 |
| | HT/VHT20, M8 to M15 | 4 | 6 | -58.4 | -59.7 | -60.2 | -60.4 | -47.6 | -21.25 | 26.3 |
| | HT/VHT20, M16 to M23 | 4 | 6 | -58.4 | -59.7 | -60.2 | -60.4 | -47.6 | -21.25 | 26.3 |
| | HT/VHT20 Beam Forming, M0 to M7 | 2 | 9 | -58.4 | -59.7 | | | -47.0 | -21.25 | 25.7 |
| | HT/VHT20 Beam Forming, M8 to M15 | 2 | 6 | -58.4 | -59.7 | | | -50.0 | -21.25 | 28.7 |
| | HT/VHT20 Beam Forming, M0 to M7 | 3 | 11 | -58.4 | -59.7 | -60.2 | | -43.8 | -21.25 | 22.5 |
| | HT/VHT20 Beam Forming, M8 to M15 | 3 | 8 | -58.4 | -59.7 | -60.2 | | -46.8 | -21.25 | 25.5 |
| | HT/VHT20 Beam Forming, M16 to M23 | 3 | 6 | -58.4 | -59.7 | -60.2 | | -48.6 | -21.25 | 27.3 |
| | HT/VHT20 Beam Forming, M0 to M7 | 4 | 12 | -58.4 | -59.7 | -60.2 | -60.4 | -41.6 | -21.25 | 20.3 |
| | HT/VHT20 Beam Forming, M8 to M15 | 4 | 9 | -58.4 | -59.7 | -60.2 | -60.4 | -44.6 | -21.25 | 23.3 |
| | HT/VHT20 Beam Forming, M16 to M23 | 4 | 7 | -58.4 | -59.7 | -60.2 | -60.4 | -46.4 | -21.25 | 25.1 |
| HT/VHT20 STBC, M0 to M7 | 2 | 6 | -58.4 | -59.7 | | | -50.0 | -21.25 | 28.7 | |
| HT/VHT20 STBC, M0 to M7 | 3 | 6 | -58.4 | -59.7 | -60.2 | | -48.6 | -21.25 | 27.3 | |
| HT/VHT20 STBC, M0 to M7 | 4 | 6 | -58.4 | -59.7 | -60.2 | -60.4 | -47.6 | -21.25 | 26.3 | |
| 5755 | Non HT40, 6 to 54 Mbps | 1 | 6 | -60.0 | | | | -54.0 | -21.25 | 32.8 |
| | Non HT40, 6 to 54 Mbps | 2 | 6 | -60.0 | -60.1 | | | -51.0 | -21.25 | 29.8 |
| | Non HT40, 6 to 54 Mbps | 3 | 6 | -60.0 | -60.1 | -59.0 | | -48.9 | -21.25 | 27.6 |
| | Non HT40, 6 to 54 Mbps | 4 | 6 | -60.0 | -60.1 | -59.0 | -58.5 | -47.3 | -21.25 | 26.1 |
| | HT/VHT40, M0 to M7 | 1 | 6 | -60.7 | | | | -54.7 | -21.25 | 33.5 |
| | HT/VHT40, M0 to M7 | 2 | 6 | -60.7 | -58.2 | | | -50.3 | -21.25 | 29.0 |



| | | | | | | | | | | |
|----------------------------------|-----------------------------------|---|-------|-------|-------|-------|-------|--------|--------|------|
| | HT/VHT40, M8 to M15 | 2 | 6 | -60.7 | -58.2 | | | -50.3 | -21.25 | 29.0 |
| | HT/VHT40, M0 to M7 | 3 | 6 | -60.7 | -58.2 | -61.7 | | -49.2 | -21.25 | 27.9 |
| | HT/VHT40, M8 to M15 | 3 | 6 | -60.7 | -58.2 | -61.7 | | -49.2 | -21.25 | 27.9 |
| | HT/VHT40, M16 to M23 | 3 | 6 | -60.7 | -58.2 | -61.7 | | -49.2 | -21.25 | 27.9 |
| | HT/VHT40, M0 to M7 | 4 | 6 | -60.7 | -58.2 | -61.7 | -59.2 | -47.7 | -21.25 | 26.5 |
| | HT/VHT40, M8 to M15 | 4 | 6 | -60.7 | -58.2 | -61.7 | -59.2 | -47.7 | -21.25 | 26.5 |
| | HT/VHT40, M16 to M23 | 4 | 6 | -60.7 | -58.2 | -61.7 | -59.2 | -47.7 | -21.25 | 26.5 |
| | HT/VHT40 Beam Forming, M0 to M7 | 2 | 9 | -60.7 | -58.2 | | | -47.3 | -21.25 | 26.0 |
| | HT/VHT40 Beam Forming, M8 to M15 | 2 | 6 | -60.7 | -58.2 | | | -50.3 | -21.25 | 29.0 |
| | HT/VHT40 Beam Forming, M0 to M7 | 3 | 11 | -60.7 | -58.2 | -61.7 | | -44.4 | -21.25 | 23.1 |
| | HT/VHT40 Beam Forming, M8 to M15 | 3 | 8 | -60.7 | -58.2 | -61.7 | | -47.4 | -21.25 | 26.1 |
| | HT/VHT40 Beam Forming, M16 to M23 | 3 | 6 | -60.7 | -58.2 | -61.7 | | -49.2 | -21.25 | 27.9 |
| | HT/VHT40 Beam Forming, M0 to M7 | 4 | 12 | -60.7 | -58.2 | -61.7 | -59.2 | -41.7 | -21.25 | 20.5 |
| | HT/VHT40 Beam Forming, M8 to M15 | 4 | 9 | -60.7 | -58.2 | -61.7 | -59.2 | -44.7 | -21.25 | 23.5 |
| | HT/VHT40 Beam Forming, M16 to M23 | 4 | 7 | -60.7 | -58.2 | -61.7 | -59.2 | -46.5 | -21.25 | 25.3 |
| | HT/VHT40 STBC, M0 to M7 | 2 | 6 | -60.7 | -58.2 | | | -50.3 | -21.25 | 29.0 |
| | HT/VHT40 STBC, M0 to M7 | 3 | 6 | -60.7 | -58.2 | -61.7 | | -49.2 | -21.25 | 27.9 |
| | HT/VHT40 STBC, M0 to M7 | 4 | 6 | -60.7 | -58.2 | -61.7 | -59.2 | -47.7 | -21.25 | 26.5 |
| | | | | | | | | | | |
| 5775 | Non HT80, 6 to 54 Mbps | 1 | 6 | -56.0 | | | | -50.0 | -21.25 | 28.8 |
| | Non HT80, 6 to 54 Mbps | 2 | 6 | -56.0 | -61.2 | | | -48.9 | -21.25 | 27.6 |
| | Non HT80, 6 to 54 Mbps | 3 | 6 | -56.0 | -61.2 | -60.8 | | -47.9 | -21.25 | 26.6 |
| | Non HT80, 6 to 54 Mbps | 4 | 6 | -56.0 | -61.2 | -60.8 | -59.0 | -46.7 | -21.25 | 25.5 |
| | VHT80, M0.1 to M9.1 | 1 | 6 | -58.9 | | | | -52.9 | -21.25 | 31.7 |
| | VHT80, M0.1 to M9.1 | 2 | 6 | -58.9 | -59.0 | | | -49.9 | -21.25 | 28.7 |
| | VHT80, M0.2 to M9.2 | 2 | 6 | -58.9 | -59.0 | | | -49.9 | -21.25 | 28.7 |
| | VHT80, M0.1 to M9.1 | 3 | 6 | -58.9 | -59.0 | -62.4 | | -49.1 | -21.25 | 27.8 |
| | VHT80, M0.2 to M9.2 | 3 | 6 | -58.9 | -59.0 | -62.4 | | -49.1 | -21.25 | 27.8 |
| | VHT80, M0.3 to M9.3 | 3 | 6 | -58.9 | -59.0 | -62.4 | | -49.1 | -21.25 | 27.8 |
| | VHT80, M0.1 to M9.1 | 4 | 6 | -58.9 | -59.0 | -62.4 | -58.8 | -47.5 | -21.25 | 26.3 |
| | VHT80, M0.2 to M9.2 | 4 | 6 | -58.9 | -59.0 | -62.4 | -58.8 | -47.5 | -21.25 | 26.3 |
| | VHT80, M0.3 to M9.3 | 4 | 6 | -58.9 | -59.0 | -62.4 | -58.8 | -47.5 | -21.25 | 26.3 |
| | VHT80 Beam Forming, M0.1 to M9.1 | 2 | 6 | -58.9 | -59.0 | | | -49.9 | -21.25 | 28.7 |
| | VHT80 Beam Forming, M0.2 to M9.2 | 2 | 6 | -58.9 | -59.0 | | | -49.9 | -21.25 | 28.7 |
| | VHT80 Beam Forming, M0.1 to M9.1 | 3 | 6 | -58.9 | -59.0 | -62.4 | | -49.1 | -21.25 | 27.8 |
| | VHT80 Beam Forming, M0.2 to M9.2 | 3 | 6 | -58.9 | -59.0 | -62.4 | | -49.1 | -21.25 | 27.8 |
| | VHT80 Beam Forming, M0.3 to M9.3 | 3 | 6 | -58.9 | -59.0 | -62.4 | | -49.1 | -21.25 | 27.8 |
| | VHT80 Beam Forming, M0.1 to M9.1 | 4 | 6 | -58.9 | -59.0 | -62.4 | -58.8 | -47.5 | -21.25 | 26.3 |
| | VHT80 Beam Forming, M0.2 to M9.2 | 4 | 6 | -58.9 | -59.0 | -62.4 | -58.8 | -47.5 | -21.25 | 26.3 |
| VHT80 Beam Forming, M0.3 to M9.3 | 4 | 6 | -58.9 | -59.0 | -62.4 | -58.8 | -47.5 | -21.25 | 26.3 | |
| VHT80 STBC, M0.1 to M9.1 | 2 | 6 | -58.9 | -59.0 | | | -49.9 | -21.25 | 28.7 | |



| | | | | | | | | | | |
|-------------------------|-------------------------------------|---|-------|-------|-------|-------|-------|--------|--------|------|
| | VHT80 STBC, M0.1 to M9.1 | 3 | 6 | -58.9 | -59.0 | -62.4 | | -49.1 | -21.25 | 27.8 |
| | VHT80 STBC, M0.1 to M9.1 | 4 | 6 | -58.9 | -59.0 | -62.4 | -58.8 | -47.5 | -21.25 | 26.3 |
| 5785 | Non HT20, 6 to 54 Mbps | 1 | 6 | -60.5 | | | | -54.5 | -21.25 | 33.3 |
| | Non HT20, 6 to 54 Mbps | 2 | 6 | -60.5 | -59.1 | | | -50.7 | -21.25 | 29.5 |
| | Non HT20, 6 to 54 Mbps | 3 | 6 | -60.5 | -59.1 | -57.2 | | -48.0 | -21.25 | 26.7 |
| | Non HT20, 6 to 54 Mbps | 4 | 6 | -60.5 | -59.1 | -57.2 | -58.9 | -46.7 | -21.25 | 25.5 |
| | Non HT20 Beam Forming, 6 to 54 Mbps | 2 | 9 | -60.5 | -59.1 | | | -47.7 | -21.25 | 26.5 |
| | Non HT20 Beam Forming, 6 to 54 Mbps | 3 | 11 | -60.5 | -59.1 | -57.2 | | -43.2 | -21.25 | 21.9 |
| | Non HT20 Beam Forming, 6 to 54 Mbps | 4 | 12 | -60.5 | -59.1 | -57.2 | -58.9 | -40.7 | -21.25 | 19.5 |
| | HT/VHT20, M0 to M7 | 1 | 6 | -58.8 | | | | -52.8 | -21.25 | 31.6 |
| | HT/VHT20, M0 to M7 | 2 | 6 | -58.8 | -59.0 | | | -49.9 | -21.25 | 28.6 |
| | HT/VHT20, M8 to M15 | 2 | 6 | -58.8 | -59.0 | | | -49.9 | -21.25 | 28.6 |
| | HT/VHT20, M0 to M7 | 3 | 6 | -58.8 | -59.0 | -56.5 | | -47.2 | -21.25 | 25.9 |
| | HT/VHT20, M8 to M15 | 3 | 6 | -58.8 | -59.0 | -56.5 | | -47.2 | -21.25 | 25.9 |
| | HT/VHT20, M16 to M23 | 3 | 6 | -58.8 | -59.0 | -56.5 | | -47.2 | -21.25 | 25.9 |
| | HT/VHT20, M0 to M7 | 4 | 6 | -58.8 | -59.0 | -56.5 | -58.2 | -46.0 | -21.25 | 24.7 |
| | HT/VHT20, M8 to M15 | 4 | 6 | -58.8 | -59.0 | -56.5 | -58.2 | -46.0 | -21.25 | 24.7 |
| | HT/VHT20, M16 to M23 | 4 | 6 | -58.8 | -59.0 | -56.5 | -58.2 | -46.0 | -21.25 | 24.7 |
| | HT/VHT20 Beam Forming, M0 to M7 | 2 | 9 | -58.8 | -59.0 | | | -46.9 | -21.25 | 25.6 |
| | HT/VHT20 Beam Forming, M8 to M15 | 2 | 6 | -58.8 | -59.0 | | | -49.9 | -21.25 | 28.6 |
| | HT/VHT20 Beam Forming, M0 to M7 | 3 | 11 | -58.8 | -59.0 | -56.5 | | -42.4 | -21.25 | 21.1 |
| | HT/VHT20 Beam Forming, M8 to M15 | 3 | 8 | -58.8 | -59.0 | -56.5 | | -45.4 | -21.25 | 24.1 |
| | HT/VHT20 Beam Forming, M16 to M23 | 3 | 6 | -58.8 | -59.0 | -56.5 | | -47.2 | -21.25 | 25.9 |
| | HT/VHT20 Beam Forming, M0 to M7 | 4 | 12 | -58.8 | -59.0 | -56.5 | -58.2 | -40.0 | -21.25 | 18.7 |
| | HT/VHT20 Beam Forming, M8 to M15 | 4 | 9 | -58.8 | -59.0 | -56.5 | -58.2 | -43.0 | -21.25 | 21.7 |
| | HT/VHT20 Beam Forming, M16 to M23 | 4 | 7 | -58.8 | -59.0 | -56.5 | -58.2 | -44.8 | -21.25 | 23.5 |
| HT/VHT20 STBC, M0 to M7 | 2 | 6 | -58.8 | -59.0 | | | -49.9 | -21.25 | 28.6 | |
| HT/VHT20 STBC, M0 to M7 | 3 | 6 | -58.8 | -59.0 | -56.5 | | -47.2 | -21.25 | 25.9 | |
| HT/VHT20 STBC, M0 to M7 | 4 | 6 | -58.8 | -59.0 | -56.5 | -58.2 | -46.0 | -21.25 | 24.7 | |
| 5795 | Non HT40, 6 to 54 Mbps | 1 | 6 | -58.5 | | | | -52.5 | -21.25 | 31.3 |
| | Non HT40, 6 to 54 Mbps | 2 | 6 | -58.5 | -58.1 | | | -49.3 | -21.25 | 28.0 |
| | Non HT40, 6 to 54 Mbps | 3 | 6 | -58.5 | -58.1 | -60.5 | | -48.1 | -21.25 | 26.9 |
| | Non HT40, 6 to 54 Mbps | 4 | 6 | -58.5 | -58.1 | -60.5 | -59.7 | -47.1 | -21.25 | 25.8 |
| | HT/VHT40, M0 to M7 | 1 | 6 | -59.7 | | | | -53.7 | -21.25 | 32.5 |
| | HT/VHT40, M0 to M7 | 2 | 6 | -59.7 | -56.3 | | | -48.7 | -21.25 | 27.4 |
| | HT/VHT40, M8 to M15 | 2 | 6 | -59.7 | -56.3 | | | -48.7 | -21.25 | 27.4 |
| | HT/VHT40, M0 to M7 | 3 | 6 | -59.7 | -56.3 | -60.9 | | -47.7 | -21.25 | 26.5 |
| | HT/VHT40, M8 to M15 | 3 | 6 | -59.7 | -56.3 | -60.9 | | -47.7 | -21.25 | 26.5 |
| | HT/VHT40, M16 to M23 | 3 | 6 | -59.7 | -56.3 | -60.9 | | -47.7 | -21.25 | 26.5 |



| | | | | | | | | | | |
|-------------------------|--|----------|-----------|--------------|--------------|--------------|--------------|--------------|---------------|-------------|
| | HT/VHT40, M0 to M7 | 4 | 6 | -59.7 | -56.3 | -60.9 | -58.7 | -46.5 | -21.25 | 25.3 |
| | HT/VHT40, M8 to M15 | 4 | 6 | -59.7 | -56.3 | -60.9 | -58.7 | -46.5 | -21.25 | 25.3 |
| | HT/VHT40, M16 to M23 | 4 | 6 | -59.7 | -56.3 | -60.9 | -58.7 | -46.5 | -21.25 | 25.3 |
| | HT/VHT40 Beam Forming, M0 to M7 | 2 | 9 | -59.7 | -56.3 | | | -45.7 | -21.25 | 24.4 |
| | HT/VHT40 Beam Forming, M8 to M15 | 2 | 6 | -59.7 | -56.3 | | | -48.7 | -21.25 | 27.4 |
| | HT/VHT40 Beam Forming, M0 to M7 | 3 | 11 | -59.7 | -56.3 | -60.9 | | -42.9 | -21.25 | 21.7 |
| | HT/VHT40 Beam Forming, M8 to M15 | 3 | 8 | -59.7 | -56.3 | -60.9 | | -45.9 | -21.25 | 24.7 |
| | HT/VHT40 Beam Forming, M16 to M23 | 3 | 6 | -59.7 | -56.3 | -60.9 | | -47.7 | -21.25 | 26.5 |
| | HT/VHT40 Beam Forming, M0 to M7 | 4 | 12 | -59.7 | -56.3 | -60.9 | -58.7 | -40.5 | -21.25 | 19.3 |
| | HT/VHT40 Beam Forming, M8 to M15 | 4 | 9 | -59.7 | -56.3 | -60.9 | -58.7 | -43.5 | -21.25 | 22.3 |
| | HT/VHT40 Beam Forming, M16 to M23 | 4 | 7 | -59.7 | -56.3 | -60.9 | -58.7 | -45.3 | -21.25 | 24.1 |
| | HT/VHT40 STBC, M0 to M7 | 2 | 6 | -59.7 | -56.3 | | | -48.7 | -21.25 | 27.4 |
| | HT/VHT40 STBC, M0 to M7 | 3 | 6 | -59.7 | -56.3 | -60.9 | | -47.7 | -21.25 | 26.5 |
| | HT/VHT40 STBC, M0 to M7 | 4 | 6 | -59.7 | -56.3 | -60.9 | -58.7 | -46.5 | -21.25 | 25.3 |
| | | | | | | | | | | |
| 5825 | Non HT20, 6 to 54 Mbps | 1 | 6 | -59.7 | | | | -53.7 | -21.25 | 32.5 |
| | Non HT20, 6 to 54 Mbps | 2 | 6 | -59.7 | -59.0 | | | -50.3 | -21.25 | 29.1 |
| | Non HT20, 6 to 54 Mbps | 3 | 6 | -59.7 | -59.0 | -59.4 | | -48.6 | -21.25 | 27.3 |
| | Non HT20, 6 to 54 Mbps | 4 | 6 | -59.7 | -59.0 | -59.4 | -55.2 | -45.9 | -21.25 | 24.6 |
| | Non HT20 Beam Forming, 6 to 54 Mbps | 2 | 9 | -59.7 | -59.0 | | | -47.3 | -21.25 | 26.1 |
| | Non HT20 Beam Forming, 6 to 54 Mbps | 3 | 11 | -59.7 | -59.0 | -59.4 | | -43.8 | -21.25 | 22.5 |
| | Non HT20 Beam Forming, 6 to 54 Mbps | 4 | 12 | -59.7 | -59.0 | -59.4 | -55.2 | -39.9 | -21.25 | 18.6 |
| | HT/VHT20, M0 to M7 | 1 | 6 | -58.9 | | | | -52.9 | -21.25 | 31.7 |
| | HT/VHT20, M0 to M7 | 2 | 6 | -58.9 | -57.1 | | | -48.9 | -21.25 | 27.6 |
| | HT/VHT20, M8 to M15 | 2 | 6 | -58.9 | -57.1 | | | -48.9 | -21.25 | 27.6 |
| | HT/VHT20, M0 to M7 | 3 | 6 | -58.9 | -57.1 | -60.5 | | -47.8 | -21.25 | 26.6 |
| | HT/VHT20, M8 to M15 | 3 | 6 | -58.9 | -57.1 | -60.5 | | -47.8 | -21.25 | 26.6 |
| | HT/VHT20, M16 to M23 | 3 | 6 | -58.9 | -57.1 | -60.5 | | -47.8 | -21.25 | 26.6 |
| | HT/VHT20, M0 to M7 | 4 | 6 | -58.9 | -57.1 | -60.5 | -59.2 | -46.7 | -21.25 | 25.5 |
| | HT/VHT20, M8 to M15 | 4 | 6 | -58.9 | -57.1 | -60.5 | -59.2 | -46.7 | -21.25 | 25.5 |
| | HT/VHT20, M16 to M23 | 4 | 6 | -58.9 | -57.1 | -60.5 | -59.2 | -46.7 | -21.25 | 25.5 |
| | HT/VHT20 Beam Forming, M0 to M7 | 2 | 9 | -58.9 | -57.1 | | | -45.9 | -21.25 | 24.6 |
| | HT/VHT20 Beam Forming, M8 to M15 | 2 | 6 | -58.9 | -57.1 | | | -48.9 | -21.25 | 27.6 |
| | HT/VHT20 Beam Forming, M0 to M7 | 3 | 11 | -58.9 | -57.1 | -60.5 | | -43.0 | -21.25 | 21.8 |
| | HT/VHT20 Beam Forming, M8 to M15 | 3 | 8 | -58.9 | -57.1 | -60.5 | | -46.0 | -21.25 | 24.8 |
| | HT/VHT20 Beam Forming, M16 to M23 | 3 | 6 | -58.9 | -57.1 | -60.5 | | -47.8 | -21.25 | 26.6 |
| | HT/VHT20 Beam Forming, M0 to M7 | 4 | 12 | -58.9 | -57.1 | -60.5 | -59.2 | -40.7 | -21.25 | 19.5 |
| | HT/VHT20 Beam Forming, M8 to M15 | 4 | 9 | -58.9 | -57.1 | -60.5 | -59.2 | -43.7 | -21.25 | 22.5 |
| | HT/VHT20 Beam Forming, M16 to M23 | 4 | 7 | -58.9 | -57.1 | -60.5 | -59.2 | -45.5 | -21.25 | 24.3 |
| HT/VHT20 STBC, M0 to M7 | 2 | 6 | -58.9 | -57.1 | | | -48.9 | -21.25 | 27.6 | |
| HT/VHT20 STBC, M0 to M7 | 3 | 6 | -58.9 | -57.1 | -60.5 | | -47.8 | -21.25 | 26.6 | |



| | | | | | | | | | |
|-------------------------|---|---|-------|-------|-------|-------|-------|--------|------|
| HT/VHT20 STBC, M0 to M7 | 4 | 6 | -58.9 | -57.1 | -60.5 | -59.2 | -46.7 | -21.25 | 25.5 |
|-------------------------|---|---|-------|-------|-------|-------|-------|--------|------|



Conducted Spurs Average, All Antennas



Conducted Spurs Peak, All Antennas





Conducted Spurs Average, 5745 MHz, Non HT20 Beam Forming, 6 to 54 Mbps



Antenna A



Antenna B



Antenna C



Antenna D



Conducted Spurs Peak, 5825 MHz, Non HT20 Beam Forming, 6 to 54 Mbps

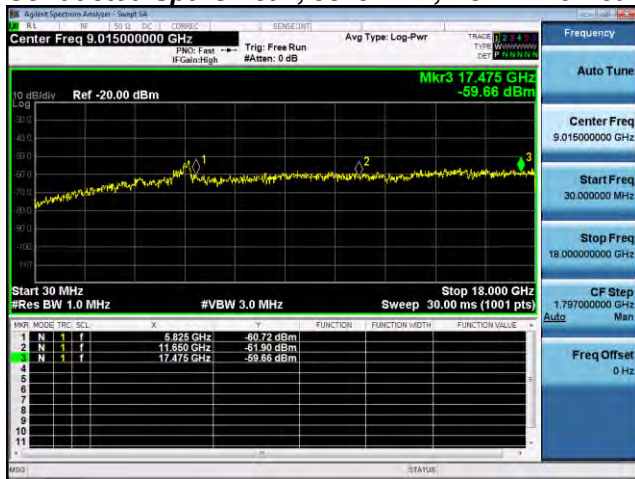

Antenna A



Antenna B

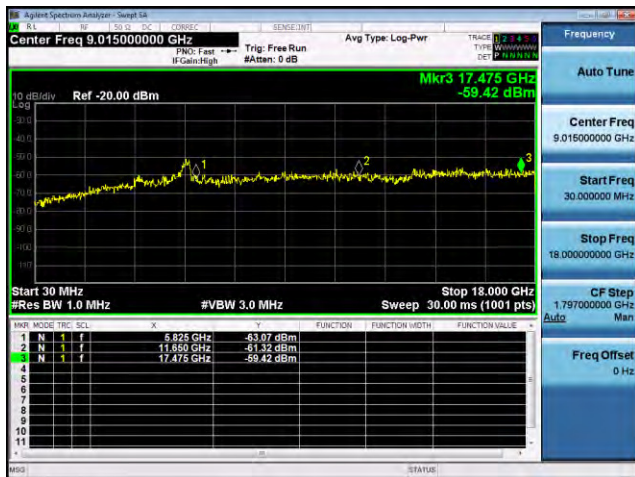

Antenna C

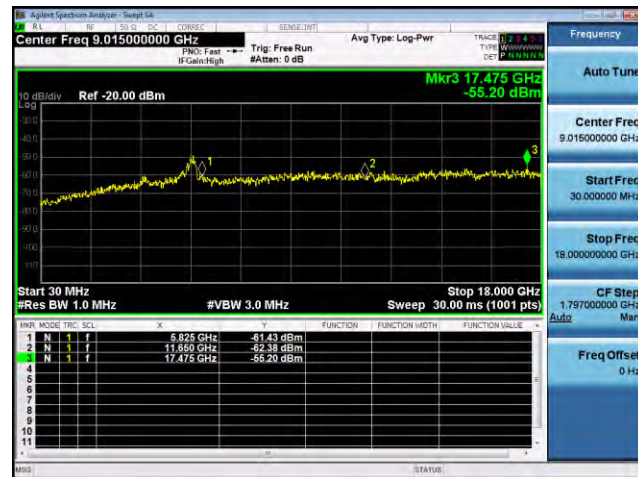

Antenna D



A.6 Conducted Bandedge

15.407 (b) *Undesirable emission limits.* Except as shown in paragraph (b) (7) of this section, the maximum emissions outside of the frequency bands of operation shall be attenuated in accordance with the following limits:

- (4) For transmitters operating in the 5.725-5.85 GHz band: All emissions within the frequency range from the band edge to 10 MHz above or below the band edge shall not exceed an e.i.r.p. of -17 dBm/MHz; for frequencies 10 MHz or greater above or below the band edge, emissions shall not exceed an e.i.r.p. of -27 dBm/MHz.
- (6) Unwanted emissions below 1 GHz must comply with the general field strength limits set forth in 15.209.
- (7) The provisions of §15.205 apply to intentional radiators operating under this section.
- (8) When measuring the emission limits, the nominal carrier frequency shall be adjusted as close to the upper and lower frequency band edges as the design of the equipment permits

Test Procedure

Ref. KDB 789033 D02 General UNII Test Procedures New Rules v01r01
ANSI C63.10: 2013

| |
|--|
| <p>Conducted Bandedge Test Procedure</p> |
| <ol style="list-style-type: none"> 1. Connect the antenna port(s) to the spectrum analyzer input. 2. Place the radio in continuous transmit mode. Use the procedures in ANSI C63.10: 2013 to substitute conducted measurements in place of radiated measurements. 3. Configure Spectrum analyzer as per test parameters below (be sure to enter all losses between the transmitter output and the spectrum analyzer). 4. Place a marker at the end of the restricted band closest to the transmit frequency to show compliance. Also measure any emissions in the restricted bands. 5. The “measure-and-sum technique” is used for measuring in-band transmit power of a device. In the measure-and-sum approach, the conducted emission level is measured at each antenna port. The measured results at the various antenna ports are then summed mathematically to determine the total emission level from the device. Summing is performed in linear power units. The worst case output is recorded. 6. Place a marker at the end of the restricted band closest to the transmit frequency to show compliance. Also measure any emissions in the restricted bands 7. Capture graphs and record pertinent measurement data. |

Ref. ANSI C63.10: 2013 section 12.7.6 (peak) & 12.7.7.3 (average, Method VB-A (Alternative))

| |
|--|
| <p>Conducted Bandedge Test parameters restricted Band</p> |
| <p>RBW = 1 MHz VBW ≥ 3 x RBW for Peak, 100Hz for Average Sweep = Auto couple Detector = Peak Trace = Max Hold.</p> |

| System Number | Description | Samples | System under test | Support equipment |
|---------------|-------------|---------|-------------------------------------|-------------------------------------|
| 1 | EUT | S01 | <input checked="" type="checkbox"/> | <input type="checkbox"/> |
| | Support | S02 | <input type="checkbox"/> | <input checked="" type="checkbox"/> |

| | |
|--|--|
| <p>Tested By : Jose Aguirre</p> | <p>Date of testing: 01-Jan-16 - 22-Feb-16</p> |
| <p>Test Result : PASS</p> | |

See Appendix C for list of test equipment



| Frequency (MHz) | Mode | Tx Paths | Correlated Antenna Gain (dBi) | Tx 1 Bandedge Level (dBm) | Tx 2 Bandedge Level (dBm) | Tx 3 Bandedge Level (dBm) | Tx 4 Bandedge Level (dBm) | Total Tx Bandedge Level (dBm) | Limit (dBm) | Margin (dB) |
|------------------------|-------------------------------------|------------------------|-------------------------------|---------------------------|---------------------------|---------------------------|---------------------------|-------------------------------|-------------|-------------|
| 5745 | Non HT20, 6 to 54 Mbps | 1 | 6 | -33.0 | | | | -27.0 | -27.00 | 0.0 |
| | Non HT20, 6 to 54 Mbps | 2 | 6 | -37.0 | -35.5 | | | -27.2 | -27.00 | 0.2 |
| | Non HT20, 6 to 54 Mbps | 3 | 6 | -38.4 | -38.0 | -38.3 | | -27.5 | -27.00 | 0.5 |
| | Non HT20, 6 to 54 Mbps | 4 | 6 | -39.5 | -38.9 | -39.6 | -38.8 | -27.2 | -27.00 | 0.2 |
| | Non HT20 Beam Forming, 6 to 54 Mbps | 2 | 9 | -39.5 | -38.9 | | | -27.2 | -27.00 | 0.2 |
| | Non HT20 Beam Forming, 6 to 54 Mbps | 3 | 11 | -41.8 | -41.7 | -46.6 | | -27.3 | -27.00 | 0.3 |
| | Non HT20 Beam Forming, 6 to 54 Mbps | 4 | 12 | -45.3 | -45.5 | -45.8 | -44.8 | -27.3 | -27.00 | 0.3 |
| | HT/VHT20, M0 to M7 | 1 | 6 | -34.6 | | | | -28.6 | -27.00 | 1.6 |
| | HT/VHT20, M0 to M7 | 2 | 6 | -36.7 | -37.0 | | | -27.8 | -27.00 | 0.8 |
| | HT/VHT20, M8 to M15 | 2 | 6 | -36.7 | -37.0 | | | -27.8 | -27.00 | 0.8 |
| | HT/VHT20, M0 to M7 | 3 | 6 | -36.7 | -37.0 | -45.0 | | -27.5 | -27.00 | 0.5 |
| | HT/VHT20, M8 to M15 | 3 | 6 | -36.7 | -37.0 | -45.0 | | -27.5 | -27.00 | 0.5 |
| | HT/VHT20, M16 to M23 | 3 | 6 | -36.7 | -37.0 | -45.0 | | -27.5 | -27.00 | 0.5 |
| | HT/VHT20, M0 to M7 | 4 | 6 | -39.7 | -39.2 | -40.5 | -39.8 | -27.8 | -27.00 | 0.8 |
| | HT/VHT20, M8 to M15 | 4 | 6 | -39.7 | -39.2 | -40.5 | -39.8 | -27.8 | -27.00 | 0.8 |
| | HT/VHT20, M16 to M23 | 4 | 6 | -39.7 | -39.2 | -40.5 | -39.8 | -27.8 | -27.00 | 0.8 |
| | HT/VHT20 Beam Forming, M0 to M7 | 2 | 9 | -39.7 | -39.2 | | | -27.4 | -27.00 | 0.4 |
| | HT/VHT20 Beam Forming, M8 to M15 | 2 | 6 | -36.7 | -37.0 | | | -27.8 | -27.00 | 0.8 |
| | HT/VHT20 Beam Forming, M0 to M7 | 3 | 11 | -42.9 | -42.6 | -43.4 | | -27.4 | -27.00 | 0.4 |
| | HT/VHT20 Beam Forming, M8 to M15 | 3 | 8 | -39.7 | -39.2 | -40.5 | | -27.2 | -27.00 | 0.2 |
| | HT/VHT20 Beam Forming, M16 to M23 | 3 | 6 | -36.7 | -37.0 | -45.0 | | -27.5 | -27.00 | 0.5 |
| | HT/VHT20 Beam Forming, M0 to M7 | 4 | 12 | -46.2 | -45.3 | -45.9 | -45.8 | -27.8 | -27.00 | 0.8 |
| | HT/VHT20 Beam Forming, M8 to M15 | 4 | 9 | -42.9 | -42.6 | -43.4 | -42.8 | -27.9 | -27.00 | 0.9 |
| | HT/VHT20 Beam Forming, M16 to M23 | 4 | 7 | -41.4 | -41.1 | -41.3 | -40.9 | -28.0 | -27.00 | 1.0 |
| | HT/VHT20 STBC, M0 to M7 | 2 | 6 | -36.7 | -37.0 | | | -27.8 | -27.00 | 0.8 |
| | HT/VHT20 STBC, M0 to M7 | 3 | 6 | -36.7 | -37.0 | -45.0 | | -27.5 | -27.00 | 0.5 |
| | HT/VHT20 STBC, M0 to M7 | 4 | 6 | -39.7 | -39.2 | -40.5 | -39.8 | -27.8 | -27.00 | 0.8 |
| | 5755 | Non HT40, 6 to 54 Mbps | 1 | 6 | -35.0 | | | | -29.0 | -27.00 |
| Non HT40, 6 to 54 Mbps | | 2 | 6 | -39.3 | -36.0 | | | -28.3 | -27.00 | 1.3 |
| Non HT40, 6 to 54 Mbps | | 3 | 6 | -37.9 | -39.3 | -39.6 | | -28.1 | -27.00 | 1.1 |
| Non HT40, 6 to 54 Mbps | | 4 | 6 | -39.4 | -43.0 | -40.0 | -40.0 | -28.4 | -27.00 | 1.4 |
| HT/VHT40, M0 to M7 | | 1 | 6 | -33.4 | | | | -27.4 | -27.00 | 0.4 |



| | | | | | | | | | | |
|----------------------------------|-----------------------------------|---|-------|-------|-------|-------|-------|--------|--------|-----|
| | HT/VHT40, M0 to M7 | 2 | 6 | -39.0 | -36.7 | | | -28.7 | -27.00 | 1.7 |
| | HT/VHT40, M8 to M15 | 2 | 6 | -39.0 | -36.7 | | | -28.7 | -27.00 | 1.7 |
| | HT/VHT40, M0 to M7 | 3 | 6 | -39.0 | -36.7 | -46.2 | | -28.4 | -27.00 | 1.4 |
| | HT/VHT40, M8 to M15 | 3 | 6 | -39.0 | -36.7 | -46.2 | | -28.4 | -27.00 | 1.4 |
| | HT/VHT40, M16 to M23 | 3 | 6 | -39.0 | -36.7 | -46.2 | | -28.4 | -27.00 | 1.4 |
| | HT/VHT40, M0 to M7 | 4 | 6 | -41.1 | -41.1 | -37.9 | -39.3 | -27.6 | -27.00 | 0.6 |
| | HT/VHT40, M8 to M15 | 4 | 6 | -41.1 | -41.1 | -37.9 | -39.3 | -27.6 | -27.00 | 0.6 |
| | HT/VHT40, M16 to M23 | 4 | 6 | -41.1 | -41.1 | -37.9 | -39.3 | -27.6 | -27.00 | 0.6 |
| | HT/VHT40 Beam Forming, M0 to M7 | 2 | 9 | -41.1 | -41.1 | | | -29.1 | -27.00 | 2.1 |
| | HT/VHT40 Beam Forming, M8 to M15 | 2 | 6 | -39.0 | -36.7 | | | -28.7 | -27.00 | 1.7 |
| | HT/VHT40 Beam Forming, M0 to M7 | 3 | 11 | -42.7 | -43.7 | -43.9 | | -27.8 | -27.00 | 0.8 |
| | HT/VHT40 Beam Forming, M8 to M15 | 3 | 8 | -41.1 | -41.1 | -37.9 | | -27.2 | -27.00 | 0.2 |
| | HT/VHT40 Beam Forming, M16 to M23 | 3 | 6 | -39.0 | -36.7 | -46.2 | | -28.4 | -27.00 | 1.4 |
| | HT/VHT40 Beam Forming, M0 to M7 | 4 | 12 | -48.2 | -48.9 | -46.6 | -42.7 | -27.8 | -27.00 | 0.8 |
| | HT/VHT40 Beam Forming, M8 to M15 | 4 | 9 | -43.7 | -40.1 | -44.8 | -42.1 | -27.3 | -27.00 | 0.3 |
| | HT/VHT40 Beam Forming, M16 to M23 | 4 | 7 | -40.4 | -39.0 | -44.7 | -44.1 | -28.2 | -27.00 | 1.2 |
| | HT/VHT40 STBC, M0 to M7 | 2 | 6 | -39.0 | -36.7 | | | -28.7 | -27.00 | 1.7 |
| | HT/VHT40 STBC, M0 to M7 | 3 | 6 | -39.0 | -36.7 | -46.2 | | -28.4 | -27.00 | 1.4 |
| | HT/VHT40 STBC, M0 to M7 | 4 | 6 | -41.1 | -41.1 | -37.9 | -39.3 | -27.6 | -27.00 | 0.6 |
| 5775 | Non HT80, 6 to 54 Mbps | 1 | 6 | -34.8 | | | | -28.8 | -27.00 | 1.8 |
| | Non HT80, 6 to 54 Mbps | 2 | 6 | -37.8 | -38.9 | | | -29.3 | -27.00 | 2.3 |
| | Non HT80, 6 to 54 Mbps | 3 | 6 | -37.8 | -38.9 | -40.3 | | -28.1 | -27.00 | 1.1 |
| | Non HT80, 6 to 54 Mbps | 4 | 6 | -42.0 | -36.8 | -43.7 | -41.4 | -28.1 | -27.00 | 1.1 |
| | VHT80, M0.1 to M9.1 | 1 | 6 | -34.1 | | | | -28.1 | -27.00 | 1.1 |
| | VHT80, M0.1 to M9.1 | 2 | 6 | -36.8 | -37.5 | | | -28.1 | -27.00 | 1.1 |
| | VHT80, M0.2 to M9.2 | 2 | 6 | -36.8 | -37.5 | | | -28.1 | -27.00 | 1.1 |
| | VHT80, M0.1 to M9.1 | 3 | 6 | -38.2 | -38.1 | -37.6 | | -27.2 | -27.00 | 0.2 |
| | VHT80, M0.2 to M9.2 | 3 | 6 | -38.2 | -38.1 | -37.6 | | -27.2 | -27.00 | 0.2 |
| | VHT80, M0.3 to M9.3 | 3 | 6 | -38.2 | -38.1 | -37.6 | | -27.2 | -27.00 | 0.2 |
| | VHT80, M0.1 to M9.1 | 4 | 6 | -40.5 | -41.1 | -40.9 | -40.9 | -28.8 | -27.00 | 1.8 |
| | VHT80, M0.2 to M9.2 | 4 | 6 | -40.5 | -41.1 | -40.9 | -40.9 | -28.8 | -27.00 | 1.8 |
| | VHT80, M0.3 to M9.3 | 4 | 6 | -40.5 | -41.1 | -40.9 | -40.9 | -28.8 | -27.00 | 1.8 |
| | VHT80 Beam Forming, M0.1 to M9.1 | 2 | 6 | -36.8 | -37.5 | | | -28.1 | -27.00 | 1.1 |
| | VHT80 Beam Forming, M0.2 to M9.2 | 2 | 6 | -36.8 | -37.5 | | | -28.1 | -27.00 | 1.1 |
| | VHT80 Beam Forming, M0.1 to M9.1 | 3 | 6 | -38.2 | -38.1 | -37.6 | | -27.2 | -27.00 | 0.2 |
| | VHT80 Beam Forming, M0.2 to M9.2 | 3 | 6 | -38.2 | -38.1 | -37.6 | | -27.2 | -27.00 | 0.2 |
| | VHT80 Beam Forming, M0.3 to M9.3 | 3 | 6 | -38.2 | -38.1 | -37.6 | | -27.2 | -27.00 | 0.2 |
| | VHT80 Beam Forming, M0.1 to M9.1 | 4 | 6 | -40.5 | -41.1 | -40.9 | -40.9 | -28.8 | -27.00 | 1.8 |
| | VHT80 Beam Forming, M0.2 to M9.2 | 4 | 6 | -40.5 | -41.1 | -40.9 | -40.9 | -28.8 | -27.00 | 1.8 |
| VHT80 Beam Forming, M0.3 to M9.3 | 4 | 6 | -40.5 | -41.1 | -40.9 | -40.9 | -28.8 | -27.00 | 1.8 | |



| | | | | | | | | | | |
|-------------------------|--|----------|-----------|--------------|--------------|--------------|--------------|--------------|---------------|------------|
| | VHT80 STBC, M0.1 to M9.1 | 2 | 6 | -36.8 | -37.5 | | | -28.1 | -27.00 | 1.1 |
| | VHT80 STBC, M0.1 to M9.1 | 3 | 6 | -38.2 | -38.1 | -37.6 | | -27.2 | -27.00 | 0.2 |
| | VHT80 STBC, M0.1 to M9.1 | 4 | 6 | -40.5 | -41.1 | -40.9 | -40.9 | -28.8 | -27.00 | 1.8 |
| 5795 | Non HT40, 6 to 54 Mbps | 1 | 6 | -39.4 | | | | -33.4 | -27.00 | 6.4 |
| | Non HT40, 6 to 54 Mbps | 2 | 6 | -39.4 | -44.1 | | | -32.1 | -27.00 | 5.1 |
| | Non HT40, 6 to 54 Mbps | 3 | 6 | -39.4 | -44.1 | -34.7 | | -27.1 | -27.00 | 0.1 |
| | Non HT40, 6 to 54 Mbps | 4 | 6 | -42.9 | -51.8 | -43.8 | -43.1 | -32.3 | -27.00 | 5.3 |
| | HT/VHT40, M0 to M7 | 1 | 6 | -44.6 | | | | -38.6 | -27.00 | 11.6 |
| | HT/VHT40, M0 to M7 | 2 | 6 | -44.6 | -47.2 | | | -36.7 | -27.00 | 9.7 |
| | HT/VHT40, M8 to M15 | 2 | 6 | -44.6 | -47.2 | | | -36.7 | -27.00 | 9.7 |
| | HT/VHT40, M0 to M7 | 3 | 6 | -44.6 | -47.2 | -52.0 | | -36.2 | -27.00 | 9.2 |
| | HT/VHT40, M8 to M15 | 3 | 6 | -44.6 | -47.2 | -52.0 | | -36.2 | -27.00 | 9.2 |
| | HT/VHT40, M16 to M23 | 3 | 6 | -44.6 | -47.2 | -52.0 | | -36.2 | -27.00 | 9.2 |
| | HT/VHT40, M0 to M7 | 4 | 6 | -44.6 | -47.2 | -52.0 | -47.3 | -35.0 | -27.00 | 8.0 |
| | HT/VHT40, M8 to M15 | 4 | 6 | -44.6 | -47.2 | -52.0 | -47.3 | -35.0 | -27.00 | 8.0 |
| | HT/VHT40, M16 to M23 | 4 | 6 | -44.6 | -47.2 | -52.0 | -47.3 | -35.0 | -27.00 | 8.0 |
| | HT/VHT40 Beam Forming, M0 to M7 | 2 | 9 | -44.6 | -47.2 | | | -33.7 | -27.00 | 6.7 |
| | HT/VHT40 Beam Forming, M8 to M15 | 2 | 6 | -44.6 | -47.2 | | | -36.7 | -27.00 | 9.7 |
| | HT/VHT40 Beam Forming, M0 to M7 | 3 | 11 | -44.6 | -47.2 | -52.0 | | -31.4 | -27.00 | 4.4 |
| | HT/VHT40 Beam Forming, M8 to M15 | 3 | 8 | -44.6 | -47.2 | -52.0 | | -34.4 | -27.00 | 7.4 |
| | HT/VHT40 Beam Forming, M16 to M23 | 3 | 6 | -44.6 | -47.2 | -52.0 | | -36.2 | -27.00 | 9.2 |
| | HT/VHT40 Beam Forming, M0 to M7 | 4 | 12 | -44.6 | -47.2 | -52.0 | -47.3 | -29.0 | -27.00 | 2.0 |
| | HT/VHT40 Beam Forming, M8 to M15 | 4 | 9 | -44.6 | -47.2 | -52.0 | -47.3 | -32.0 | -27.00 | 5.0 |
| | HT/VHT40 Beam Forming, M16 to M23 | 4 | 7 | -44.6 | -47.2 | -52.0 | -47.3 | -33.8 | -27.00 | 6.8 |
| HT/VHT40 STBC, M0 to M7 | 2 | 6 | -44.6 | -47.2 | | | -36.7 | -27.00 | 9.7 | |
| HT/VHT40 STBC, M0 to M7 | 3 | 6 | -44.6 | -47.2 | -52.0 | | -36.2 | -27.00 | 9.2 | |
| HT/VHT40 STBC, M0 to M7 | 4 | 6 | -44.6 | -47.2 | -52.0 | -47.3 | -35.0 | -27.00 | 8.0 | |
| 5825 | Non HT20, 6 to 54 Mbps | 1 | 6 | -34.2 | | | | -28.2 | -27.00 | 1.2 |
| | Non HT20, 6 to 54 Mbps | 2 | 6 | -35.6 | -37.3 | | | -27.4 | -27.00 | 0.4 |
| | Non HT20, 6 to 54 Mbps | 3 | 6 | -37.7 | -39.1 | -38.3 | | -27.6 | -27.00 | 0.6 |
| | Non HT20, 6 to 54 Mbps | 4 | 6 | -39.8 | -41.7 | -40.0 | -39.4 | -28.1 | -27.00 | 1.1 |
| | Non HT20 Beam Forming, 6 to 54 Mbps | 2 | 9 | -38.7 | -40.3 | | | -27.4 | -27.00 | 0.4 |
| | Non HT20 Beam Forming, 6 to 54 Mbps | 3 | 11 | -42.1 | -43.3 | -42.9 | | -27.2 | -27.00 | 0.2 |
| | Non HT20 Beam Forming, 6 to 54 Mbps | 4 | 12 | -44.5 | -45.5 | -45.4 | -44.8 | -27.0 | -27.00 | 0.0 |
| | HT/VHT20, M0 to M7 | 1 | 6 | -33.7 | | | | -27.7 | -27.00 | 0.7 |
| | HT/VHT20, M0 to M7 | 2 | 6 | -35.2 | -37.8 | | | -27.3 | -27.00 | 0.3 |
| | HT/VHT20, M8 to M15 | 2 | 6 | -35.2 | -37.8 | | | -27.3 | -27.00 | 0.3 |
| | HT/VHT20, M0 to M7 | 3 | 6 | -37.5 | -39.2 | -38.9 | | -27.7 | -27.00 | 0.7 |
| HT/VHT20, M8 to M15 | 3 | 6 | -37.5 | -39.2 | -38.9 | | -27.7 | -27.00 | 0.7 | |



| | | | | | | | | | |
|-----------------------------------|---|----|-------|-------|-------|-------|-------|--------|-----|
| HT/VHT20, M16 to M23 | 3 | 6 | -37.5 | -39.2 | -38.9 | | -27.7 | -27.00 | 0.7 |
| HT/VHT20, M0 to M7 | 4 | 6 | -40.0 | -41.2 | -40.7 | -39.3 | -28.2 | -27.00 | 1.2 |
| HT/VHT20, M8 to M15 | 4 | 6 | -40.0 | -41.2 | -40.7 | -39.3 | -28.2 | -27.00 | 1.2 |
| HT/VHT20, M16 to M23 | 4 | 6 | -40.0 | -41.2 | -40.7 | -39.3 | -28.2 | -27.00 | 1.2 |
| HT/VHT20 Beam Forming, M0 to M7 | 2 | 9 | -38.2 | -40.3 | | | -27.1 | -27.00 | 0.1 |
| HT/VHT20 Beam Forming, M8 to M15 | 2 | 6 | -35.2 | -37.8 | | | -27.3 | -27.00 | 0.3 |
| HT/VHT20 Beam Forming, M0 to M7 | 3 | 11 | -42.1 | -43.6 | -42.5 | | -27.1 | -27.00 | 0.1 |
| HT/VHT20 Beam Forming, M8 to M15 | 3 | 8 | -40.0 | -41.2 | -40.7 | | -28.0 | -27.00 | 1.0 |
| HT/VHT20 Beam Forming, M16 to M23 | 3 | 6 | -37.5 | -39.2 | -38.9 | | -27.7 | -27.00 | 0.7 |
| HT/VHT20 Beam Forming, M0 to M7 | 4 | 12 | -44.5 | -46.8 | -46.2 | -44.2 | -27.3 | -27.00 | 0.3 |
| HT/VHT20 Beam Forming, M8 to M15 | 4 | 9 | -42.1 | -43.6 | -42.5 | -40.8 | -27.1 | -27.00 | 0.1 |
| HT/VHT20 Beam Forming, M16 to M23 | 4 | 7 | -40.0 | -41.2 | -40.7 | -39.3 | -27.0 | -27.00 | 0.0 |
| HT/VHT20 STBC, M0 to M7 | 2 | 6 | -35.2 | -37.8 | | | -27.3 | -27.00 | 0.3 |
| HT/VHT20 STBC, M0 to M7 | 3 | 6 | -37.5 | -39.2 | -38.9 | | -27.7 | -27.00 | 0.7 |
| HT/VHT20 STBC, M0 to M7 | 4 | 6 | -40.0 | -41.2 | -40.7 | -39.3 | -28.2 | -27.00 | 1.2 |



Conducted Bandedge Peak, 5745 MHz, Non HT20, 6 to 54 Mbps

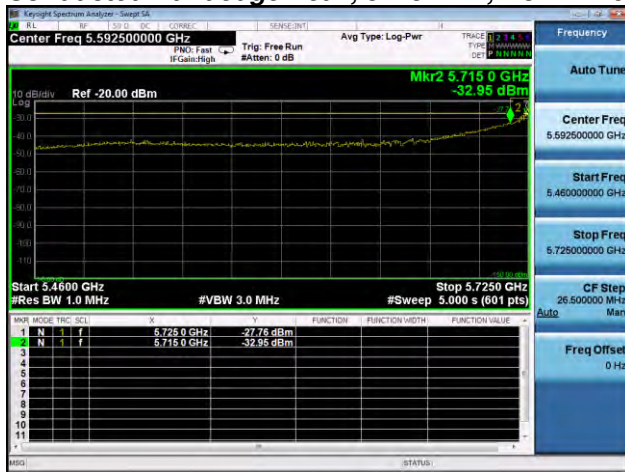

Antenna A



Conducted Bandedge Peak, 5825 MHz, Non HT20 Beam Forming, 6 to 54 Mbps

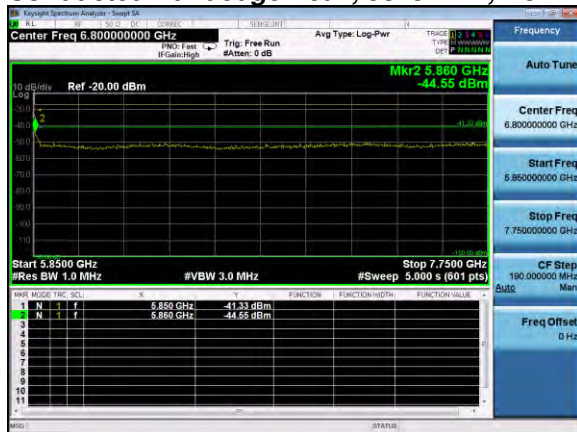

Antenna A

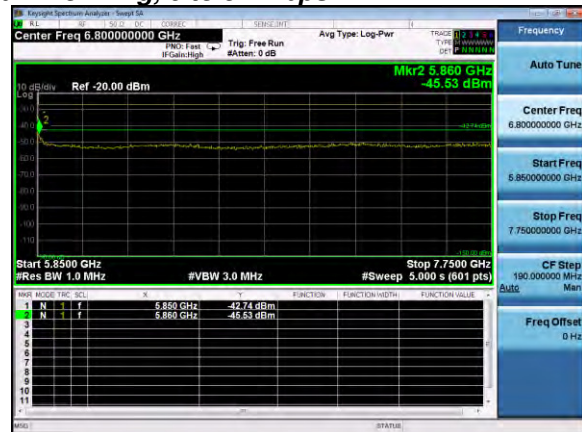

Antenna B



Antenna C



Antenna D

Appendix B: Emission Test Results

Testing Laboratory: Cisco Systems, Inc., 125 West Tasman Drive, San Jose, CA 95134, USA

Radiated Emission Setup Diagram-Below 1G

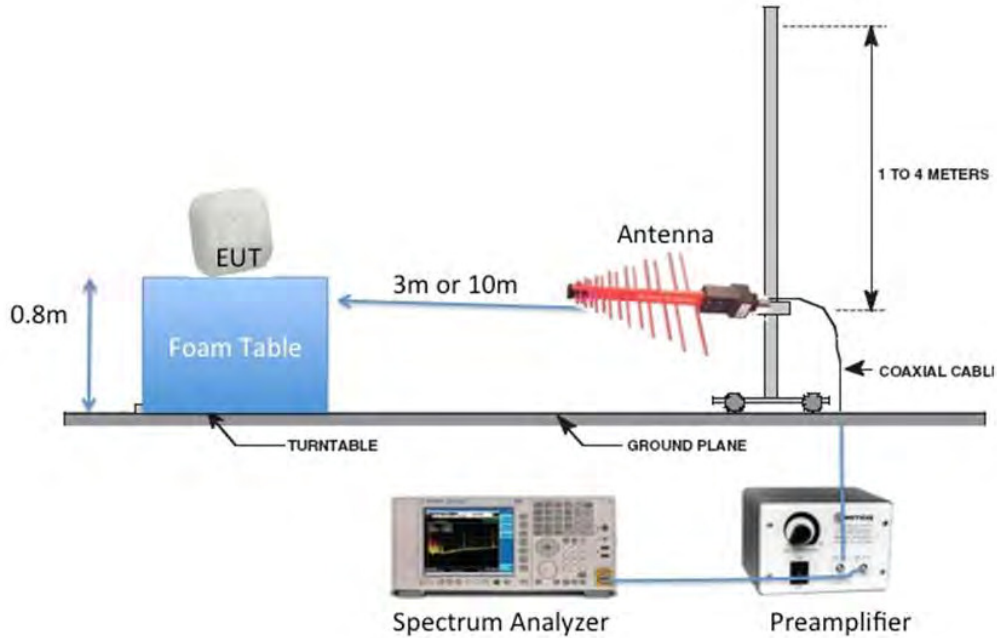

Radiated Emission Setup Diagram-Above 1G

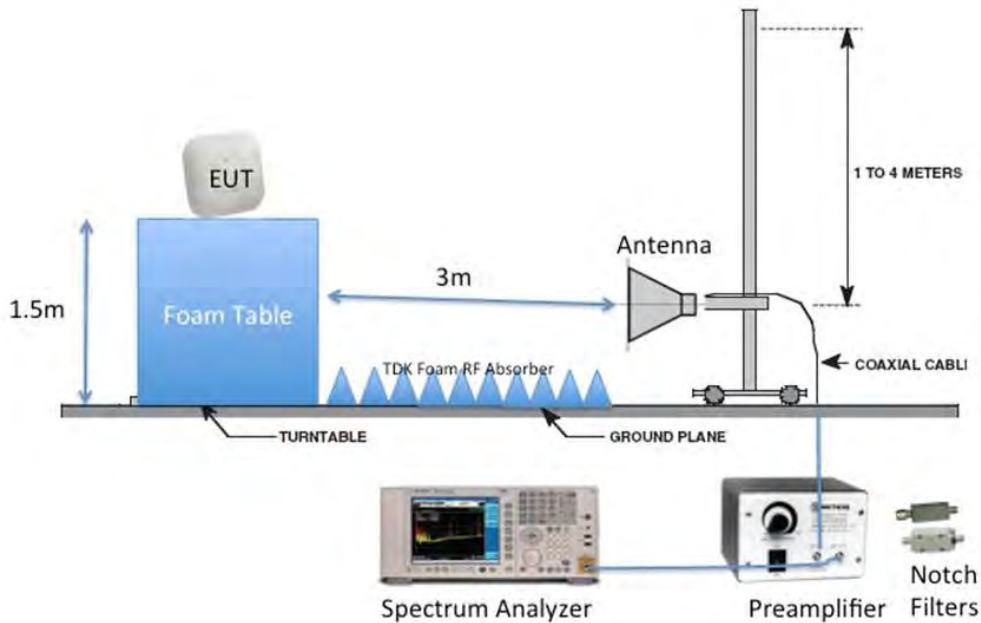



B.1 Radiated Spurious Emissions

15.407 (b) Undesirable emission limits. Except as shown in paragraph (b) (7) of this section, the maximum emissions outside of the frequency bands of operation shall be attenuated in accordance with the following limits:

(4) For transmitters operating in the 5.725-5.85 GHz band: All emissions within the frequency range from the band edge to 10 MHz above or below the band edge shall not exceed an e.i.r.p. of -17 dBm/MHz; for frequencies 10 MHz or greater above or below the band edge, emissions shall not exceed an e.i.r.p. of -27 dBm/MHz.

(6) Unwanted emissions below 1 GHz must comply with the general field strength limits set forth in 15.209.

(7) The provisions of §15.205 apply to intentional radiators operating under this section.

(8) When measuring the emission limits, the nominal carrier frequency shall be adjusted as close to the upper and lower frequency band edges as the design of the equipment permits

Ref. ANSI C63.10: 2013 section 12.7.6 (peak) & 12.7.7.3 (average)

Using Vasona, configure the spectrum analyzer as shown below (be sure to enter all losses between the transmitter output and the spectrum analyzer). Place the radio in continuous transmit mode.

| | |
|-----------------------|-------------------------------------|
| Span: | 1GHz – 18 GHz/18GHz-26G/26GHz-40GHz |
| Reference Level: | 80 dBuV |
| Attenuation: | 10 dB |
| Sweep Time: | Coupled |
| Resolution Bandwidth: | 1MHz |
| Video Bandwidth: | 3 MHz for peak, 1 KHz for average |
| Detector: | Peak |

Terminate the access Point RF ports with 50 ohm loads.

Maximize Turntable (find worst case table angle), Maximize Antenna (find worst case height)

Save 2 plots: 1) Average plot (Vertical and Horizontal), Limit= 54dBuV/m @3m
2) Peak plot (Vertical and Horizontal), Limit = 74dBuV/m @3m

Place a marker at the end of the restricted band closest to the transmit frequency to show compliance. Also measure any emissions in the restricted bands.

This report represents the worst case data for all supported operating modes and antennas. There are no measurable emissions above 18 GHz.

| System Number | Description | Samples | System under test | Support equipment |
|---------------|-------------|---------|-------------------------------------|-------------------------------------|
| 1 | EUT | S01 | <input checked="" type="checkbox"/> | <input type="checkbox"/> |
| | Support | S02 | <input type="checkbox"/> | <input checked="" type="checkbox"/> |

| | |
|------------------------------------|---|
| Tested By : Jose Aguirre | Date of testing: 10-Feb-16 to 22-Feb-16 |
| Test Result : PASS | |

See Appendix C for list of test equipment

**B.1.A Transmitter Radiated Spurious Emissions-Average worst case**

| Frequency (MHz) | Mode | Data Rate (Mbps) | Spurious Emission Level (dBuV/m) | Limit (dBuV/m) | Margin (MHz) |
|-----------------|----------------------------------|------------------|----------------------------------|----------------|--------------|
| 5745 | Non HT/VHT20, 6 to 54 Mbps | 6 | 50.5 | 54.0 | 3.5 |
| 5755 | HT/VHT40, M0 to M7, M0 to M9 1ss | m0 | 50.4 | 54.0 | 3.6 |
| 5775 | HT/VHT80, M0 to M7, M0 to M9 1ss | m0x1 | 50.6 | 54.0 | 3.4 |
| 5785 | Non HT/VHT20, 6 to 54 Mbps | 6 | 50.4 | 54.0 | 3.6 |
| 5795 | HT/VHT40, M0 to M7, M0 to M9 1ss | m0 | 50.5 | 54.0 | 3.5 |
| 5825 | Non HT/VHT20, 6 to 54 Mbps | 6 | 50.4 | 54.0 | 3.6 |



B.1.A.1 Radiated Transmitter Spurs, 5745 MHz, Non HT/VHT20, 6 to 54 Mbps, Average (1-18GHz)



B.1.A.2 Radiated Transmitter Spurs, 5755 MHz, HT/VHT40, M0 to M7, M0 to M9 1ss Average (1-18GHz)





B.1.A.3 Radiated Transmitter Spurs, 5775 MHz, HT/VHT80, M0 to M7, M0 to M9 1ss, Average (1-18GHz)



B.1.A.4 Radiated Transmitter Spurs, 5785 MHz, Non HT/VHT20, 6 to 54 Mbps, Average (1-18GHz)





B.1.A.5 Radiated Transmitter Spurs, 5795 MHz, HT/VHT40, M0 to M7, M0 to M9 1ss, Average (1-18GHz)



B.1.A.6 Radiated Transmitter Spurs, 5825 MHz, Non HT/VHT20, 6 to 54 Mbps, Average (1-18GHz)

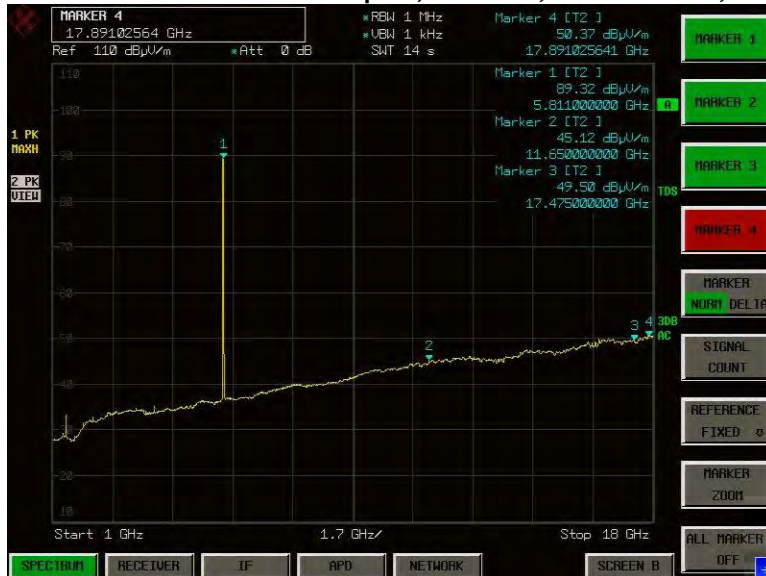



B.1.A.7 Radiated Transmitter Spurs, All rate, All modes, Average (18-26.5GHz)



B.1.A.8 Radiated Transmitter Spurs, All rate, All modes, Average (26.5- 40GHz)



**B.1.P Transmitter Radiated Spurious Emissions-Peak worst case**

| Frequency (MHz) | Mode | Data Rate (Mbps) | Spurious Emission Level (dBuV/m) | Limit (dBuV/m) | Margin (MHz) |
|-----------------|----------------------------------|------------------|----------------------------------|----------------|--------------|
| 5745 | Non HT/VHT20, 6 to 54 Mbps | 6 | 62.6 | 74.0 | 11.4 |
| 5755 | HT/VHT40, M0 to M7, M0 to M9 1ss | m0 | 62.5 | 74.0 | 11.5 |
| 5775 | HT/VHT80, M0 to M7, M0 to M9 1ss | m0x1 | 62.7 | 74.0 | 11.3 |
| 5785 | Non HT/VHT20, 6 to 54 Mbps | 6 | 61.3 | 74.0 | 12.7 |
| 5795 | HT/VHT40, M0 to M7, M0 to M9 1ss | m0 | 62.0 | 74.0 | 12.0 |
| 5825 | Non HT/VHT20, 6 to 54 Mbps | 6 | 62.2 | 74.0 | 11.8 |



B.1.P.1 Radiated Transmitter Spurs, 5745 MHz, Non HT/VHT20, 6 to 54 Mbps, (1-18GHz)

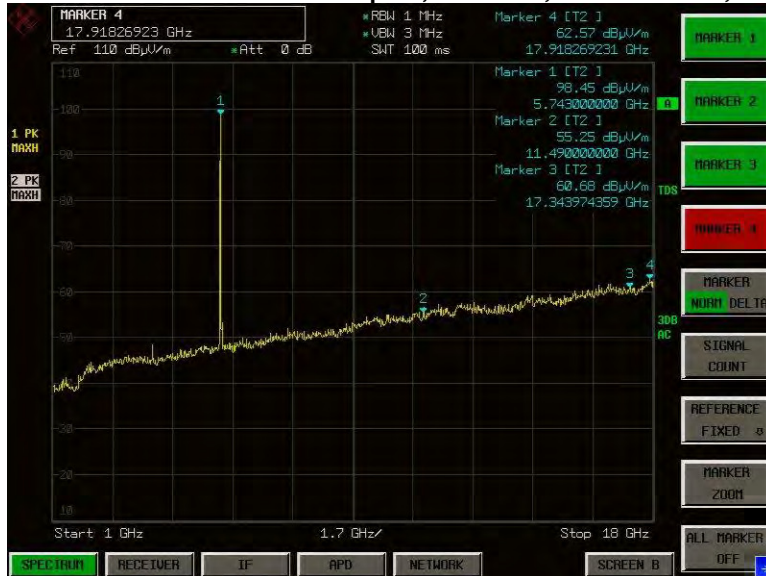

B.1.P.2 Radiated Transmitter Spurs, 5755 MHz, HT/VHT40, M0 to M7, M0 to M9 1ss, Peak (1-18GHz)





B.1.P.3 Radiated Transmitter Spurs, 5775 MHz, VHT80, M0 to M9, M0 to M9 1.1, Peak (1-18GHz)

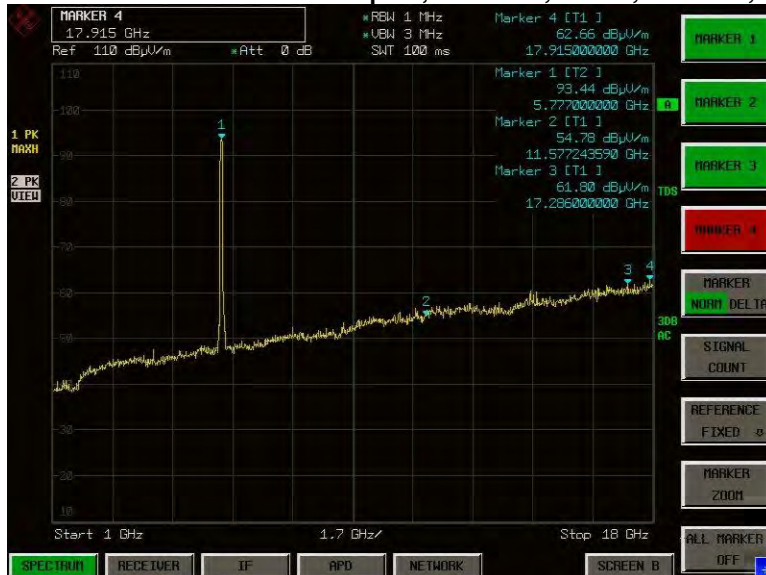

B.1.P.4 Radiated Transmitter Spurs, 5785 MHz, Non HT/VHT20, 6 to 54 Mbps, Peak (1-18GHz)

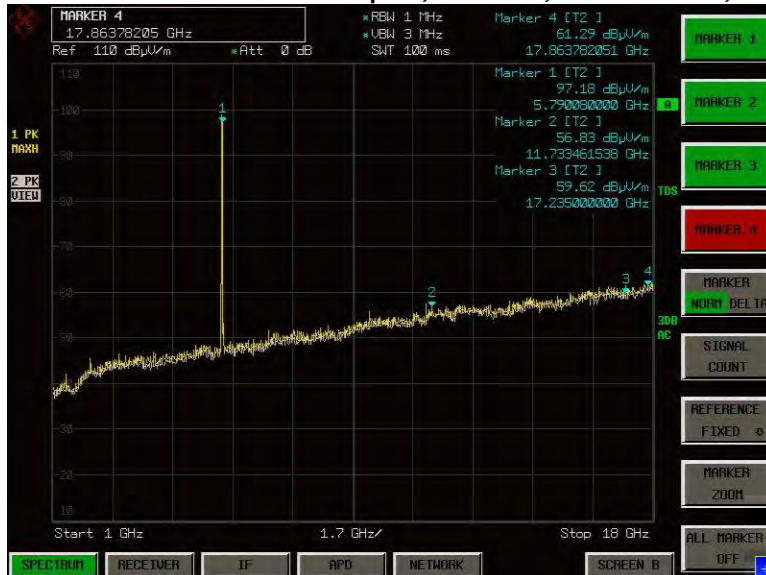



B.1.P.5 Radiated Transmitter Spurs, 5795 MHz, HT/VHT40, M0 to M7, M0 to M9 1ss, Peak (1-18GHz)

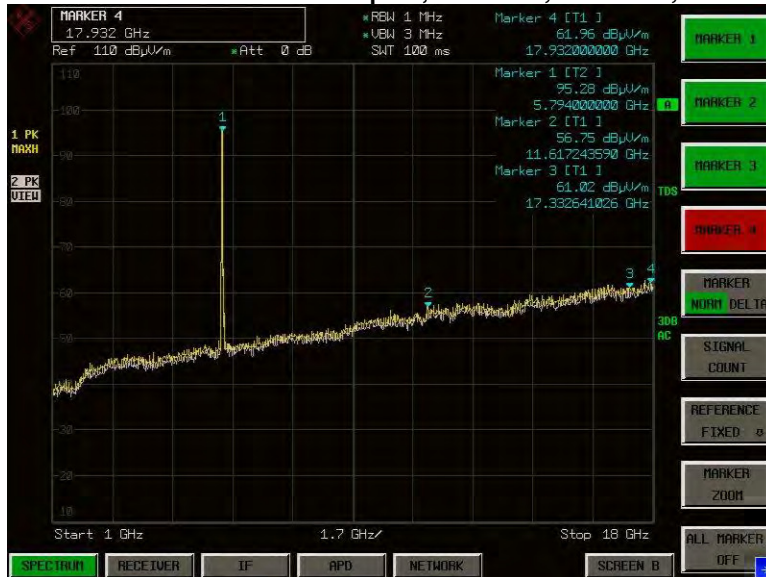

B.1.P.6 Radiated Transmitter Spurs, 5825 MHz, Non HT/VHT20, 6 to 54 Mbps, Peak (1-18GHz)

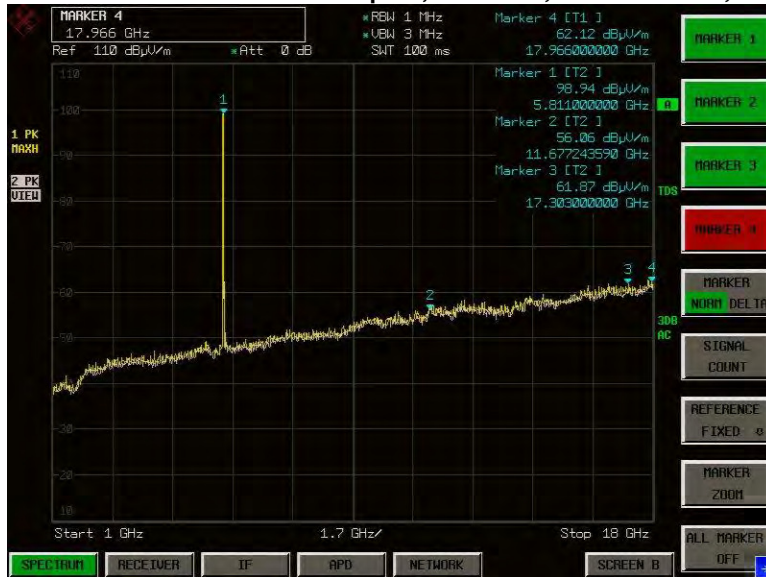



B.1.P.7 Radiated Transmitter Spurs, All rate, All modes, Peak (18-26.5GHz)



B.1.P.8 Radiated Transmitter Spurs, All rate, All modes, Peak (26.5-40GHz)





B.2 Radiated Receiver Spurious Emissions

RSS-GEN: Receivers, are required to comply with the limits of spurious emissions as set out in this section. Receiver emission measurements are to be performed as per the normative test method referenced in Section 3.

For emissions at frequencies below 1 GHz, measurements shall be performed using a CISPR quasi-peak detector and the related measurement bandwidth. At frequencies above 1 GHz, measurements shall be performed using a linear average detector with a minimum resolution bandwidth of 1 MHz.

Ref. ANSI C63.10: 2013 section 12.7.6 (peak) & 12.7.7.3 (average)

Using Vasona, configure the spectrum analyzer as shown below (be sure to enter all losses between the transmitter output and the spectrum analyzer). Place the radio in continuous transmit mode.

| | |
|-----------------------|-------------------------------------|
| Span: | 1GHz – 18 GHz/18GHz-26G/26GHz-40GHz |
| Reference Level: | 80 dBuV |
| Attenuation: | 10 dB |
| Sweep Time: | Coupled |
| Resolution Bandwidth: | 1MHz |
| Video Bandwidth: | 3 MHz for peak, 1 KHz for average |
| Detector: | Peak |

Terminate the access Point RF ports with 50 ohm loads.

Maximize Turntable (find worst case table angle), Maximize Antenna (find worst case height)

Save 2 plots: 1) Average plot (Vertical and Horizontal), Limit= 54dBuV/m @3m
 2) Peak plot (Vertical and Horizontal), Limit = 74dBuV/m @3m

Place a marker at the end of the restricted band closest to the transmit frequency to show compliance. Also measure any emissions in the restricted bands.

This report represents the worst case data for all supported operating modes and antennas. There are no measurable emissions above 18 GHz.

| System Number | Description | Samples | System under test | Support equipment |
|---------------|-------------|---------|-------------------------------------|-------------------------------------|
| 1 | EUT | S01 | <input checked="" type="checkbox"/> | <input type="checkbox"/> |
| | Support | S02 | <input type="checkbox"/> | <input checked="" type="checkbox"/> |

| | |
|------------------------------------|--|
| Tested By : Jose Aguirre | Date of testing: 01-Jan-16 - 22-Feb-16 |
| Test Result : PASS | |

See Appendix C for list of test equipment



B.2.A Receiver Radiated Spurious Emissions Average Measurements

B.2.A.1 Radiated Receiver Spurs, All rates, All Mode, Average (1-18GHz)



B.2.A.2 Radiated Receiver Spurs, All rates, All Mode, Average (18-26.5GHz)





B.2.A.3 Radiated Receiver Spurs, All rates, All Mode, Average (26.5-40GHz)





B.2.P Receiver Radiated Spurious Emissions Peak Measurements

B.2.P.1 Radiated Receiver Spurs, All rates, All Mode, Peak (1-18GHz)



B.2.P.2 Radiated Receiver Spurs, All rates, All Mode, Peak (18-26.5GHz)





B.2.P.3 Radiated Receiver Spurs, All rates, All Mode, Peak (26.5-40GHz)





B.3 Radiated Emissions 30MHz to 1GHz

15.205 / 15.209 / RSS-Gen:

Radiated emissions which fall in the restricted bands, as defined in Section 15.205(a), and RSS-Gen sec 8.10 must also comply with the radiated emission limits specified in Section 15.209(a) (see Section 15.205(c)) and RSS-Gen sec 8.9

Ref. ANSI C63.10: 2013 section 6.5

Using Vasona, configure the spectrum analyzer as shown below (be sure to enter all losses between the transmitter output and the spectrum analyzer). Place the radio in continuous transmit mode.

| | |
|-----------------------|-------------------------------|
| Span: | 30MHz – 1GHz |
| Reference Level: | 80 dBuV |
| Attenuation: | 10 dB |
| Sweep Time: | Coupled |
| Resolution Bandwidth: | 100kHz |
| Video Bandwidth: | 300kHz |
| Detector: | Peak for Pre-scan, Quasi-Peak |

Compliance shall be determined using CISPR quasi-peak detection; however, peak detection is permitted as an alternative to quasi-peak detection.

Terminate the access Point RF ports with 50 ohm loads.

Maximize Turntable (find worst case table angle), Maximize Antenna (find worst case height)

This report represents the worst case data for all supported operating modes and antennas.

| System Number | Description | Samples | System under test | Support equipment |
|---------------|-------------|---------|-------------------------------------|-------------------------------------|
| 1 | EUT | S01 | <input checked="" type="checkbox"/> | <input type="checkbox"/> |
| | Support | S02 | <input type="checkbox"/> | <input checked="" type="checkbox"/> |

| | |
|------------------------------------|--|
| Tested By : Jose Aguirre | Date of testing: 10-Feb-16 - 22-Feb-16 |
| Test Result : PASS | |

See Appendix C for list of test equipment



Graphical Test Results

Note that the data displayed on the plots detailed in this appendix were measured using a 'Peak Detector'. Please refer to the results table for the detectors used during formal measurements

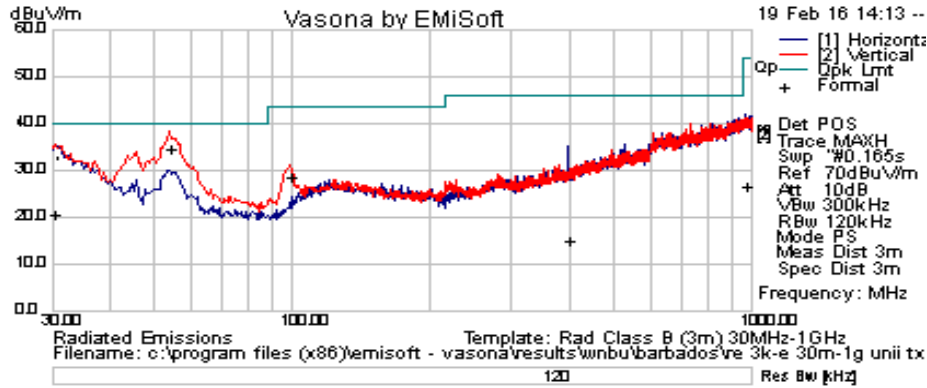

Test Results

| Frequency MHz | Raw dBuV | Cable Loss | AF dB | Level dBuV/m | Measurement Type | P ol | Hgt cm | Azt Deg | Limit dBuV/m | Margin dB | Pass /Fail |
|---------------|----------|------------|-------|--------------|------------------|------|--------|---------|--------------|-----------|------------|
| 967.505 | 0.54 | 2.96 | 23.1 | 26.6 | Quasi Max | H | 389 | 52 | 54 | -27.4 | Pass |
| 53.998 | 26.59 | 0.7 | 7.35 | 34.65 | Quasi Max | V | 110 | 142 | 40 | -5.35 | Pass |
| 98.87 | 18.09 | 0.93 | 9.89 | 28.92 | Quasi Max | V | 157 | 194 | 43.5 | -14.58 | Pass |
| 398.115 | -1.71 | 1.89 | 15.06 | 15.24 | Quasi Max | H | 326 | 200 | 46 | -30.76 | Pass |
| 30.485 | -0.96 | 0.49 | 21.27 | 20.81 | Quasi Max | V | 355 | 350 | 40 | -19.19 | Pass |



B.4 AC Conducted Emissions

FCC 15.207 Except when the requirements applicable to a given device state otherwise, for any radio apparatus equipped to operate from the public utility AC power supply, either directly or indirectly (such as with a battery charger), the radio frequency voltage of emissions conducted back onto the AC power lines in the frequency range of 0.15 MHz to 30 MHz shall not exceed the limits shown in the table in these sections. The more stringent limit applies at the frequency range boundaries.

Measurement Procedure
 Accordance with ANSI C63.10:2013 section 6.2

Using Vasona, configure the spectrum analyzer as shown below (be sure to enter all losses between the transmitter output and the spectrum analyzer). Place the radio in continuous transmit mode.

Span: 150 KHz – 30 MHz
 Attenuation: 10 dB
 Sweep Time: Coupled
 Resolution Bandwidth: 9 KHz
 Video Bandwidth: 30 KHz
 Detector: Quasi-Peak / Average

| System Number | Description | Samples | System under test | Support equipment |
|---------------|-------------|---------|-------------------------------------|-------------------------------------|
| 1 | EUT | S01 | <input checked="" type="checkbox"/> | <input type="checkbox"/> |
| | Support | S02 | <input type="checkbox"/> | <input checked="" type="checkbox"/> |

| | |
|------------------------------------|---|
| Tested By : Jose Aguirre | Date of testing: 10-Feb-16 to 22-Feb-16 |
| Test Result : PASS | |

See Appendix C for list of test equipment



Graphical Test Results

Note that the data displayed on the plots detailed in this appendix were measured using a 'Peak Detector'. Please refer to the results table for the detectors used during formal measurements

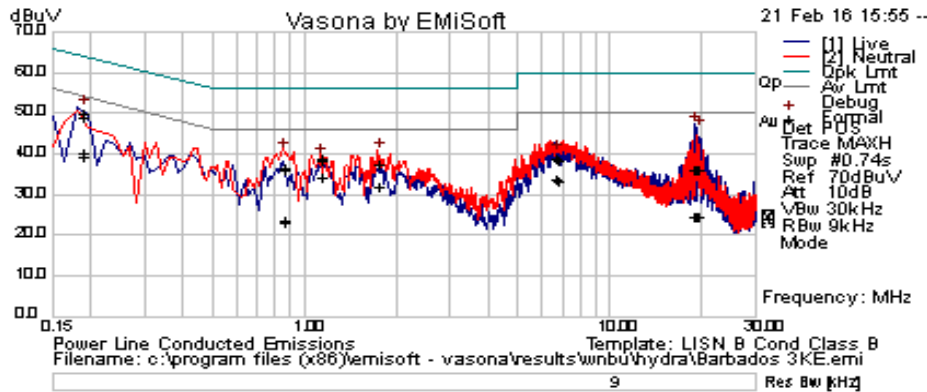

Test Results

| Frequency MHz | Raw dBuV | Cable Loss | Factors dB | Level dBuV | Measurement Type | Line | Limit dBuV | Margin dB | Pass /Fail |
|---------------|----------|------------|------------|------------|------------------|---------|------------|-----------|------------|
| 0.857757 | 16.19 | 19.91 | 0.03 | 36.14 | Quasi Peak | Live | 56 | -19.86 | Pass |
| 0.187244 | 29.09 | 20.91 | 0.06 | 50.06 | Quasi Peak | Live | 64.16 | -14.1 | Pass |
| 19.007406 | 15.87 | 20.3 | 0.2 | 36.37 | Quasi Peak | Live | 60 | -23.63 | Pass |
| 1.755417 | 17.64 | 19.9 | 0.03 | 37.57 | Quasi Peak | Live | 56 | -18.43 | Pass |
| 19.383573 | 15.92 | 20.3 | 0.2 | 36.42 | Quasi Peak | Live | 60 | -23.58 | Pass |
| 6.724028 | 18.68 | 20.01 | 0.07 | 38.76 | Quasi Peak | Live | 60 | -21.24 | Pass |
| 1.131699 | 18.77 | 19.9 | 0.04 | 38.71 | Quasi Peak | Live | 56 | -17.29 | Pass |
| 19.029708 | 16 | 20.3 | 0.2 | 36.5 | Quasi Peak | Neutral | 60 | -23.5 | Pass |
| 0.856911 | 16.86 | 19.91 | 0.03 | 36.81 | Quasi Peak | Neutral | 56 | -19.19 | Pass |
| 19.384527 | 15.97 | 20.3 | 0.2 | 36.47 | Quasi Peak | Neutral | 60 | -23.53 | Pass |
| 0.190178 | 28.11 | 20.9 | 0.06 | 49.06 | Quasi Peak | Neutral | 64.03 | -14.97 | Pass |
| 1.133571 | 19.28 | 19.9 | 0.04 | 39.22 | Quasi Peak | Neutral | 56 | -16.78 | Pass |
| 1.756893 | 17.73 | 19.9 | 0.03 | 37.66 | Quasi Peak | Neutral | 56 | -18.34 | Pass |
| 6.712994 | 19.08 | 20.01 | 0.07 | 39.16 | Quasi Peak | Neutral | 60 | -20.84 | Pass |
| 0.857757 | 4.02 | 19.91 | 0.03 | 23.97 | Average | Live | 46 | -22.03 | Pass |
| 0.187244 | 19.33 | 20.91 | 0.06 | 40.3 | Average | Live | 54.16 | -13.86 | Pass |
| 19.007406 | 4.14 | 20.3 | 0.2 | 24.65 | Average | Live | 50 | -25.35 | Pass |
| 1.755417 | 12.41 | 19.9 | 0.03 | 32.34 | Average | Live | 46 | -13.66 | Pass |
| 19.383573 | 4.45 | 20.3 | 0.2 | 24.95 | Average | Live | 50 | -25.05 | Pass |
| 6.724028 | 13.39 | 20.01 | 0.07 | 33.47 | Average | Live | 50 | -16.53 | Pass |
| 1.131699 | 14.43 | 19.9 | 0.04 | 34.37 | Average | Live | 46 | -11.63 | Pass |
| 19.029708 | 4.05 | 20.3 | 0.2 | 24.55 | Average | Neutral | 50 | -25.45 | Pass |
| 0.856911 | 3.62 | 19.91 | 0.03 | 23.57 | Average | Neutral | 46 | -22.43 | Pass |
| 19.384527 | 4.22 | 20.3 | 0.2 | 24.72 | Average | Neutral | 50 | -25.28 | Pass |
| 0.190178 | 18.8 | 20.9 | 0.06 | 39.75 | Average | Neutral | 54.03 | -14.28 | Pass |
| 1.133571 | 14.69 | 19.9 | 0.04 | 34.63 | Average | Neutral | 46 | -11.37 | Pass |
| 1.756893 | 12.41 | 19.9 | 0.03 | 32.34 | Average | Neutral | 46 | -13.66 | Pass |
| 6.712994 | 13.86 | 20.01 | 0.07 | 33.94 | Average | Neutral | 50 | -16.06 | Pass |

Photographs of setup



Title: Conducted Test Setup

This is a dual band 2.4GHz / 5GHz device. All ports in this test set up photo are connected as all testing is automated. Section 2.6 of this test report given an overview of the different Tx antenna combinations used by this device.

AIR-AP3802E-B-K9 AC Mains Conducted Emissions setup



AIR-AP3802E-B-K9 Radiated Emissions setup 30MHz – 1GHz

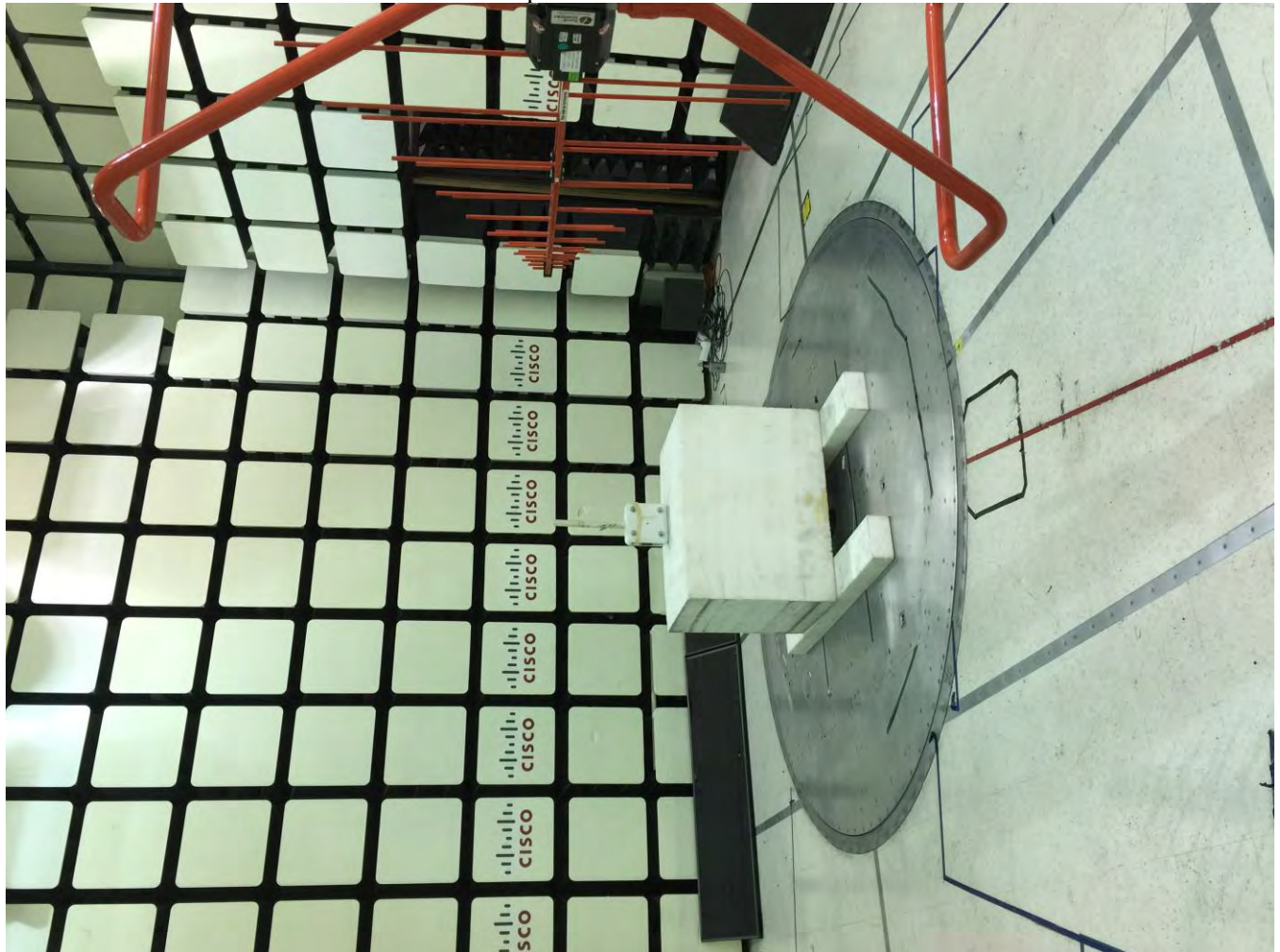

AIR-AP3802E-B-K9 Radiated Emissions setup above 1GHz

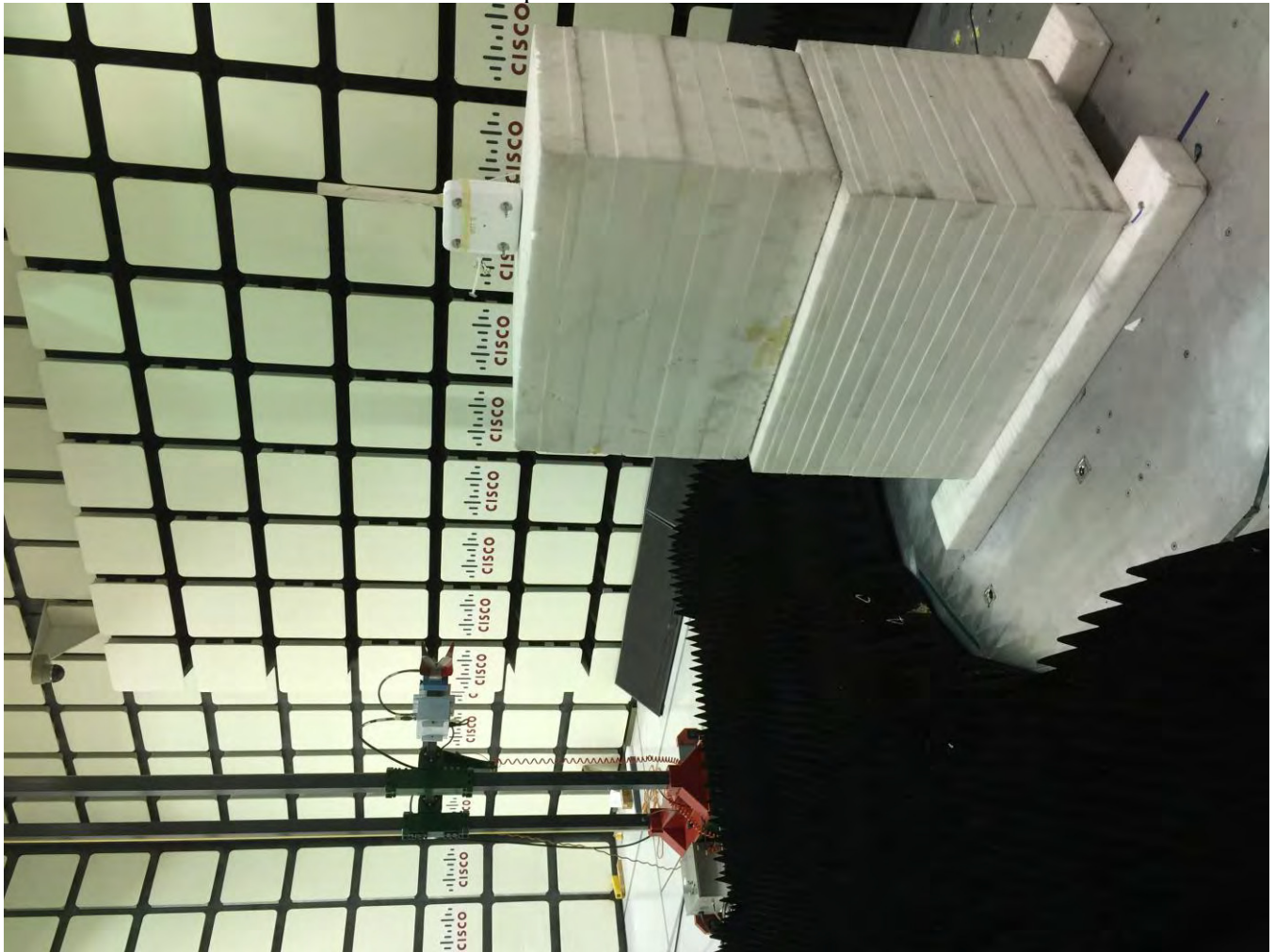



Appendix C: List of Test Equipment Used to perform the test

| Equip# | Manufacturer/ Model | Description | Last Cal | Next Due | Test Item |
|---|-------------------------------------|---|---------------------|---------------------|---------------|
| Test Equipment used for Radiated Emissions | | | | | |
| CIS005691 | NSP1800-25-S1 Miteq | Broadband Preamp (1-18GHz) | 25-Jun-15 | 25-Jun-16 | B.1, B.2 |
| CIS008448 | NSA 5m Chamber Cisco | NSA 5m Chamber | 9-Oct-15 | 9-Oct-16 | B.3 |
| CIS021117 | UFB311A-0-2484-520520 Micro-Coax | RF Coaxial Cable, to 18GHz, 248.4 in | 24-Aug-15 | 24-Aug-16 | B.1, B.2, B.3 |
| CIS034075 | RSG 2000 Schaffner | Reference Spectrum Generator, 1-18GHz | Cal Not Required | Cal Not Required | B.1, B.2 |
| CIS035284 | 3117 ETS-Lindgren | Double Ridged Waveguide Horn Antenna | 30-Sep-15 | 30-Sep-16 | B.1, B.2 |
| CIS037236 | 50CB-015 JFW | GPIB Control Box | Cal Not Required | Cal Not Required | B.1, B.2 |
| CIS040597 | Above 1GHz Site Cal Cisco | Above 1GHz Cispr Site Verification | 25-Sep-15 | 25-Sep-16 | B.1, B.2 |
| CIS041979 | 1840 Cisco | 18-40GHz EMI Test Head/Verification Fixture | 13-Jul-15 | 13-Jul-16 | B.1, B.2 |
| CIS042266 | JB1 Sunol Sciences | Combination Antenna | 21-Apr-15 | 21-Apr-16 | B.3 |
| CIS044940 | ESU40 Rohde & Schwarz | EMI Test Receiver, 20Hz-40GHz | 2-Nov-15 | 2-Nov-16 | B.1, B.2 |
| CIS054230 | iBTHP-5-DB9 Newport | 5 inch Temp/RH/Press Sensor w/20ft cable | 10-Feb-16 | 10-Feb-17 | B.1, B.2, B.3 |

| Test Equipment used for AC Mains Conducted Emissions | | | | | |
|---|--|--|---------------------|---------------------|-----------|
| Equip No | Model Manufacturer | Description | Last Cal | Next Cal | Test Item |
| CIS002464 | FCC-801-M2-16 Fischer Custom Communications | CDN, 2-LINE, 16A | 12-Mar-15 | 12-Mar-16 | B.4 |
| CIS049532 | H785-150K-50-21378 TTE | High Pass Filter | 8-May-15 | 8-May-16 | B.4 |
| CIS020913 | FCC-LISN-PA-NEMA-5-15 Fischer Custom Communications | AC Adapter | 8-May-15 | 8-May-16 | B.4 |
| CIS007704 | FCC-LISN-50/250-50-2-01 Fischer Custom Communications | LISN | 8-May-15 | 8-May-16 | B.4 |
| CIS008185 | FCC-450B-2.4-N Fischer Custom Communications | Instrumentation Limiter | 28-Jul-15 | 28-Jul-16 | B.4 |
| CIS051756 | 5-T-MB Bird | 5W 50 Ohm BNC Termination 4GHz | 6-Aug-15 | 6-Aug-16 | B.4 |
| CIS049563 | Sucoflex 106A Huber + Suhner | N Type Cable 18GHz | 24-Aug-15 | 24-Aug-16 | B.4 |
| CIS021117 | UFB311A-0-2484-520520 Micro-Coax | RF Coaxial Cable, to 18GHz, 248.4 in | 24-Aug-15 | 24-Aug-16 | B.4 |
| CIS044940 | ESU40 Rohde & Schwarz | EMI Test Receiver, 20Hz-40GHz | 2-Nov-15 | 2-Nov-16 | B.4 |
| CIS054647 | 33-605 Stanley | 10meter Measuring Tape | Cal not required | Cal not required | B.4 |
| CIS018963 | CNE V York | Comparison Noise Emitter, 30 - 1000MHz | Cal not required | Cal not required | B.4 |

| Test Equipment used for RF Conducted Tests | | | | | |
|---|-----------------------|-------------|----------|----------|-----------|
| Equip No | Model Manufacturer | Description | Last Cal | Next Cal | Test Item |



| | | | | | |
|-----------|-------------------------------------|---|------------------|------------------|------------|
| CIS050721 | N9030A Keysight | PXA Signal Analyzer | 13-Apr-15 | 13-Apr-16 | A1 thru A4 |
| CIS054662 | SF18-S1S1-36 MegaPhase | SMA 36" cable | 24-Sep-15 | 24-Sep-16 | A1 thru A4 |
| CIS054663 | F120-S1S1-48 MegaPhase | SMA 48" Cable | 25-Sep-15 | 25-Sep-16 | A1 thru A4 |
| CIS054665 | RA08-S1S1-24 MegaPhase | SMA 24" Cable | 25-Sep-15 | 25-Sep-16 | A1 thru A4 |
| CIS054666 | RA08-S1S1-18 MegaPhase | SMA 18" Cable | 25-Sep-15 | 25-Sep-16 | A1 thru A4 |
| CIS054667 | RA08-S1S1-18 MegaPhase | SMA 18" Cable | 25-Sep-15 | 25-Sep-16 | A1 thru A4 |
| CIS054668 | RA08-S1S1-18 MegaPhase | SMA 18" Cable | 25-Sep-15 | 25-Sep-16 | A1 thru A4 |
| CIS054669 | RA08-S1S1-18 MegaPhase | SMA 18" Cable | 25-Sep-15 | 25-Sep-16 | A1 thru A4 |
| CIS054670 | RA08-S1S1-12 MegaPhase | SMA 12" Cable | 25-Sep-15 | 25-Sep-16 | A1 thru A4 |
| CIS054671 | RA08-S1S1-12 MegaPhase | SMA 12" Cable | 25-Sep-15 | 25-Sep-16 | A1 thru A4 |
| CIS054672 | RA08-S1S1-12 MegaPhase | SMA 12" Cable | 25-Sep-15 | 25-Sep-16 | A1 thru A4 |
| CIS054673 | RA08-S1S1-12 MegaPhase | SMA 12" Cable | 25-Sep-15 | 25-Sep-16 | A1 thru A4 |
| CIS054674 | RA08-S1S1-12 MegaPhase | SMA 12" Cable | 25-Sep-15 | 25-Sep-16 | A1 thru A4 |
| CIS054675 | RA08-S1S1-12 MegaPhase | SMA 12" Cable | 25-Sep-15 | 25-Sep-16 | A1 thru A4 |
| CIS054677 | RA08-S1S1-12 MegaPhase | SMA 12" Cable | 25-Sep-15 | 25-Sep-16 | A1 thru A4 |
| CIS054678 | RA08-S1S1-12 MegaPhase | SMA 12" Cable | 25-Sep-15 | 25-Sep-16 | A1 thru A4 |
| CIS054686 | NI PXI-2796 National Instruments | Plug-in switch module | 6-Oct-15 | 6-Oct-16 | A1 thru A4 |
| CIS055094 | PXI-1042 National Instruments | Chassis | Cal Not Required | Cal Not Required | A1 thru A4 |
| CIS055117 | RFLT2WDC40G RF Lambda | 2 Way 40GHz Splitter | 11-Nov-15 | 11-Nov-16 | A1 thru A4 |
| CIS055166 | RFLT4WDC40GK RF Lambda | 4 Way Power Divider 40GHz | 23-Nov-15 | 23-Nov-16 | A1 thru A4 |
| CIS054656 | BRC50705-02 Micro-Tronics | Band Reject Filter | 24-Sep-15 | 24-Sep-16 | A1 thru A4 |
| CIS054655 | BRC50704-02 Micro-Tronics | Notch Filter, SB:5.470-5.725GHz, to 12GHz | 24-Sep-15 | 24-Sep-16 | A1 thru A4 |
| CIS054654 | BRC50703-02 Micro-Tronics | Notch Filter, SB:5.150-5.350GHz, to 11GHz | 24-Sep-15 | 24-Sep-16 | A1 thru A4 |
| CIS054653 | BRM50702-02 Micro-Tronics | Notch Filter, SB:2.400-2.500GHz, to 18GHz | 24-Sep-15 | 24-Sep-16 | A1 thru A4 |
| CIS054637 | BWS30-W2/ Aeroflex | SMA 30dB Attenuator | 02-June-15 | 02-June-16 | A1 thru A4 |
| CIS054636 | BWS20-W2/ Aeroflex | 20dB SMA Attenuator | 02-June-15 | 02-June-16 | A1 thru A4 |



Appendix E: Abbreviation Key and Definitions

The following table defines abbreviations used within this test report.

| Abbreviation | Description | Abbreviation | Description |
|--------------|--|--------------|-------------------------------------|
| EMC | Electro Magnetic Compatibility | °F | Degrees Fahrenheit |
| EMI | Electro Magnetic Interference | °C | Degrees Celsius |
| EUT | Equipment Under Test | Temp | Temperature |
| ITE | Information Technology Equipment | S/N | Serial Number |
| TAP | Test Assessment Schedule | Qty | Quantity |
| ESD | Electro Static Discharge | emf | Electromotive force |
| EFT | Electric Fast Transient | RMS | Root mean square |
| EDCS | Engineering Document Control System | Qp | Quasi Peak |
| Config | Configuration | Av | Average |
| CIS# | Cisco Number (unique identification number for Cisco test equipment) | Pk | Peak |
| Cal | Calibration | kHz | Kilohertz (1×10^3) |
| EN | European Norm | MHz | MegaHertz (1×10^6) |
| IEC | International Electro technical Commission | GHz | Gigahertz (1×10^9) |
| CISPR | International Special Committee on Radio Interference | H | Horizontal |
| CDN | Coupling/Decoupling Network | V | Vertical |
| LISN | Line Impedance Stabilization Network | dB | decibel |
| PE | Protective Earth | V | Volt |
| GND | Ground | kV | Kilovolt (1×10^3) |
| L1 | Line 1 | μ V | Microvolt (1×10^{-6}) |
| L2 | Line2 | A | Amp |
| L3 | Line 3 | μ A | Micro Amp (1×10^{-6}) |
| DC | Direct Current | mS | Milli Second (1×10^{-3}) |
| RAW | Uncorrected measurement value, as indicated by the measuring device | μ S | Micro Second (1×10^{-6}) |
| RF | Radio Frequency | μ S | Micro Second (1×10^{-6}) |
| SLCE | Signal Line Conducted Emissions | m | Meter |
| Meas dist | Measurement distance | Spec dist | Specification distance |
| N/A or NA | Not Applicable | SL | Signal Line (or Telecom Line) |
| P | Power Line | L | Live Line |
| N | Neutral Line | R | Return |
| S | Supply | AC | Alternating Current |



End