



Test Report

**AIR-AP3802E-B-K9
AIR-AP3802E-UXK9
AIR-AP2802E-B-K9
AIR-AP2802E-UXK9**

Cisco Aironet 802.11ac Dual Band Access Points

FCC ID: LDK102099

5150-5250 MHz



Against the following Specifications:

CFR47 Part 15.407

Cisco Systems

170 West Tasman Drive

San Jose, CA 95134

	
Author: Jose Aguirre Tested By	Approved By: Jim Nicholson Title: Technical Leader, Engineering Revision: 3

This report replaces any previously entered test report under EDCS – 1551995 .This test report has been electronically authorized and archived using the CISCO Engineering Document Control system.

This test report has been electronically authorized and archived using the CISCO Engineering Document Control system.

SECTION 1: OVERVIEW	3
SECTION 2: ASSESSMENT INFORMATION	4
2.1 GENERAL	4
2.2 DATE OF TESTING.....	6
2.3 REPORT ISSUE DATE	6
2.4 TESTING FACILITIES	6
2.5 EQUIPMENT ASSESSED (EUT).....	6
2.6 EUT DESCRIPTION.....	7
SECTION 3: RESULT SUMMARY.....	10
3.1 RESULTS SUMMARY TABLE	10
SECTION 4: SAMPLE DETAILS.....	12
APPENDIX A: EMISSION TEST RESULTS	13
CONDUCTED TEST SETUP DIAGRAM.....	13
TARGET MAXIMUM CHANNEL POWER	13
A.1 99% AND 26DB BANDWIDTH.....	14
A.2 MAXIMUM CONDUCTED OUTPUT POWER/ POWER SPECTRAL DENSITY	22
A.3 CONDUCTED SPURIOUS EMISSIONS	34
A.4 CONDUCTED BAND EDGE	46
APPENDIX B: EMISSION TEST RESULTS.....	54
RADIATED EMISSION SETUP DIAGRAM-BELOW 1G	54
RADIATED EMISSION SETUP DIAGRAM-ABOVE 1G	54
B1 RADIATED SPURIOUS EMISSIONS	55
B.2 RADIATED EMISSIONS 30MHZ TO 1GHZ.....	68
B.3 AC CONDUCTED EMISSIONS.....	70
APPENDIX C: LIST OF TEST EQUIPMENT USED TO PERFORM THE TEST.....	76
APPENDIX E: ABBREVIATION KEY AND DEFINITIONS	78



Section 1: Overview

The samples were assessed against the tests detailed in section 3 under the requirements of the following specifications:

Specifications:
CFR47 Part 15.407

Measurements were made in accordance with

- ANSI C63.10:2013
- KDB 789033 D02 General UNII Test Procedures New Rules v01r01
- KDB 662911 D01 Multiple Transmitter Output v02r01

Section 2: Assessment Information

2.1 General

This report contains an assessment of an apparatus against Electromagnetic Compatibility Standards based upon tests carried out on the samples submitted. The testing was performed by and for the use of Cisco systems Inc:

With regard to this assessment, the following points should be noted:

- a) The results contained in this report relate only to the items tested and were obtained in the period between the date of the initial assessment and the date of issue of the report. Manufactured products will not necessarily give identical results due to production and measurement tolerances.
- b) The apparatus was set up and exercised using the configuration and modes of operation defined in this report only.
- c) Where relevant, the apparatus was only assessed using the susceptibility criteria defined in this report and the Test Assessment Plan (TAP).
- d) All testing was performed under the following environmental conditions:

Temperature	15°C to 35°C (54°F to 95°F)
Atmospheric Pressure	860mbar to 1060mbar (25.4" to 31.3")
Humidity	10% to 75*%
- e) All AC testing was performed at one or more of the following supply voltages:
110V 60 Hz (+/-20%)

Units of Measurement

The units of measurements defined in the appendices are reported in specific terms, which are test dependent. Where radiated measurements are concerned these are defined at a particular distance. Basic voltage measurements are defined in units of [dBuV]

As an example, the basic calculation for all measurements is as follows:

$$\text{Emission level [dBuV]} = \text{Indicated voltage level [dBuV]} + \text{Cable Loss [dB]} + \text{Other correction factors [dB]}$$

The combinations of correction factors are dependent upon the exact test configurations [see test equipment lists for further details] and may include:-

Antenna Factors, Pre Amplifier Gain, LISN Loss, Pulse Limiter Loss and Filter Insertion Loss..

Note: to convert the results from dBuV/m to uV/m use the following formula:-

$$\text{Level in uV/m} = \text{Common Antilogarithm} [(X \text{ dBuV/m})/20] = Y \text{ uV/m}$$

Measurement Uncertainty Values

voltage and power measurements	± 2 dB
conducted EIRP measurements	± 1.4 dB
radiated measurements	± 3.2 dB
frequency measurements	± 2.4 10 ⁻⁷
temperature measurements	± 0.54°
humidity measurements	± 2.3%
DC and low frequency measurements	± 2.5%

Where relevant measurement uncertainty levels have been estimated for tests performed on the apparatus. This uncertainty represents an expanded uncertainty expressed at approximately the 95% confidence level using a coverage factor of k=2.

Radiated emissions (expanded uncertainty, confidence interval 95%)

30 MHz - 300 MHz	+/- 3.8 dB
300 MHz - 1000 MHz	+/- 4.3 dB
1 GHz - 10 GHz	+/- 4.0 dB
10 GHz - 18GHz	+/- 8.2 dB
18GHz - 26.5GHz	+/- 4.1 dB
26.5GHz - 40GHz	+/- 3.9 dB

Conducted emissions (expanded uncertainty, confidence interval 95%)

30 MHz – 40GHz	+/- 0.38 dB
----------------	-------------

A product is considered to comply with a requirement if the nominal measured value is below the limit line. The product is considered to not be in compliance in case the nominal measured value is above the limit line.

This report must not be reproduced except in full, without written approval of Cisco Systems.

2.2 Date of testing

01-Jan-16 - 22-Feb-16

2.3 Report Issue Date

06-March-2016

Cisco uses an electronic system to issue, store and control the revision of test reports. This system is called the Engineering Document Control System (EDCS). The actual report issue date is embedded into the original file on EDCS. Any copies of this report, either electronic or paper, that are not on EDCS must be considered uncontrolled.

2.4 Testing facilities

This assessment was performed by:

Testing Laboratory

Cisco Systems, Inc.,
125 West Tasman Drive
San Jose, CA 95134, USA

Registration Numbers for Industry Canada

Cisco System Site	Address	Site Identifier
Building P, 10m Chamber	125 West Tasman Dr San Jose, CA 95134	Company #: 2461N-2
Building P, 5m Chamber	125 West Tasman Dr San Jose, CA 95134	Company #: 2461N-1
Building I, 5m Chamber	285 W. Tasman Drive San Jose, California 95134	Company #: 2461M-1

Test Engineers

Jose Aguirre

2.5 Equipment Assessed (EUT)

AIR-AP3802E-B-K9

2.6 EUT Description

The Cisco Aironet 802.11ac Radio supports the following modes of operation. The modes are further defined in the radio Theory of Operation. The modes included in this report represent the worst case data for all modes.

- 802.11n/ac - Non HT20, One Antenna, 6 to 54 Mbps
- 802.11n/ac - Non HT20, Two Antennas, 6 to 54 Mbps
- 802.11n/ac - Non HT20, Three Antennas, 6 to 54 Mbps
- 802.11n/ac - Non HT20, Four Antennas, 6 to 54 Mbps

- 802.11n/ac - Non HT20 Beam Forming, Two Antennas, 6 to 54 Mbps
- 802.11n/ac - Non HT20 Beam Forming, Three Antennas, 6 to 54 Mbps
- 802.11n/ac - Non HT20 Beam Forming, Four Antennas, 6 to 54 Mbps

- 802.11n/ac - HT/VHT20, One Antenna, M0 to M7
- 802.11n/ac - HT/VHT20, Two Antennas, M0 to M7
- 802.11n/ac - HT/VHT20, Two Antennas, M8 to M15
- 802.11n/ac - HT/VHT20, Three Antennas, M0 to M7
- 802.11n/ac - HT/VHT20, Three Antennas, M8 to M15
- 802.11n/ac - HT/VHT20, Three Antennas, M16 to M23
- 802.11n/ac - HT/VHT20, Four Antennas, M0 to M7
- 802.11n/ac - HT/VHT20, Four Antennas, M8 to M15
- 802.11n/ac - HT/VHT20, Four Antennas, M16 to M23

- 802.11n/ac - HT/VHT20 Beam Forming, Two Antennas, M0 to M7
- 802.11n/ac - HT/VHT20 Beam Forming, Two Antennas, M8 to M15
- 802.11n/ac - HT/VHT20 Beam Forming, Three Antennas, M0 to M7
- 802.11n/ac - HT/VHT20 Beam Forming, Three Antennas, M8 to M15
- 802.11n/ac - HT/VHT20 Beam Forming, Three Antennas, M16 to M23
- 802.11n/ac - HT/VHT20 Beam Forming, Four Antennas, M0 to M7
- 802.11n/ac - HT/VHT20 Beam Forming, Four Antennas, M8 to M15
- 802.11n/ac - HT/VHT20 Beam Forming, Four Antennas, M16 to M23

- 802.11n/ac - HT/VHT20 STBC, Two Antennas, M0 to M7
- 802.11n/ac - HT/VHT20 STBC, Three Antennas, M0 to M7
- 802.11n/ac - HT/VHT20 STBC, Four Antennas, M0 to M7

- 802.11n/ac - Non HT40 Duplicate, One Antenna, 6 to 54 Mbps
- 802.11n/ac - Non HT40 Duplicate, Two Antennas, 6 to 54 Mbps
- 802.11n/ac - Non HT40 Duplicate, Three Antennas, 6 to 54 Mbps
- 802.11n/ac - Non HT40 Duplicate, Four Antennas, 6 to 54 Mbps

- 802.11n/ac - HT/VHT40, One Antenna, M0 to M7
- 802.11n/ac - HT/VHT40, Two Antennas, M0 to M7
- 802.11n/ac - HT/VHT40, Two Antennas, M8 to M15
- 802.11n/ac - HT/VHT40, Three Antennas, M0 to M7
- 802.11n/ac - HT/VHT40, Three Antennas, M8 to M15
- 802.11n/ac - HT/VHT40, Three Antennas, M16 to M23
- 802.11n/ac - HT/VHT40, Four Antennas, M0 to M7
- 802.11n/ac - HT/VHT40, Four Antennas, M8 to M15
- 802.11n/ac - HT/VHT40, Four Antennas, M16 to M23

802.11n/ac - HT/VHT40 Beam Forming, Two Antennas, M0 to M7
802.11n/ac - HT/VHT40 Beam Forming, Two Antennas, M8 to M15
802.11n/ac - HT/VHT40 Beam Forming, Three Antennas, M0 to M7
802.11n/ac - HT/VHT40 Beam Forming, Three Antennas, M8 to M15
802.11n/ac - HT/VHT40 Beam Forming, Three Antennas, M16 to M23
802.11n/ac - HT/VHT40 Beam Forming, Four Antennas, M0 to M7
802.11n/ac - HT/VHT40 Beam Forming, Four Antennas, M8 to M15
802.11n/ac - HT/VHT40 Beam Forming, Four Antennas, M16 to M23

802.11n/ac - HT/VHT40 STBC, Two Antennas, M0 to M7
802.11n/ac - HT/VHT40 STBC, Three Antennas, M0 to M7
802.11n/ac - HT/VHT40 STBC, Four Antennas, M0 to M7

802.11n/ac - Non HT80 Duplicate, One Antenna, 6 to 54 Mbps
802.11n/ac - Non HT80 Duplicate, Two Antennas, 6 to 54 Mbps
802.11n/ac - Non HT80 Duplicate, Three Antennas, 6 to 54 Mbps
802.11n/ac - Non HT80 Duplicate, Four Antennas, 6 to 54 Mbps

802.11ac - VHT80, One Antenna, M0.1 to M9.1
802.11ac - VHT80, Two Antennas, M0.1 to M9.1
802.11ac - VHT80, Two Antennas, M0.2 to M9.2
802.11ac - VHT80, Three Antennas, M0.1 to M9.1
802.11ac - VHT80, Three Antennas, M0.2 to M9.2
802.11ac - VHT80, Three Antennas, M0.3 to M9.3
802.11ac - VHT80, Four Antennas, M0.1 to M9.1
802.11ac - VHT80, Four Antennas, M0.2 to M9.2
802.11ac - VHT80, Four Antennas, M0.3 to M9.3

802.11ac - VHT80 Beam Forming, Two Antennas, M0.1 to M9.1
802.11ac - VHT80 Beam Forming, Two Antennas, M0.2 to M9.2
802.11ac - VHT80 Beam Forming, Three Antennas, M0.1 to M9.1
802.11ac - VHT80 Beam Forming, Three Antennas, M0.2 to M9.2
802.11ac - VHT80 Beam Forming, Three Antennas, M0.3 to M9.3
802.11ac - VHT80 Beam Forming, Four Antennas, M0.1 to M9.1
802.11ac - VHT80 Beam Forming, Four Antennas, M0.2 to M9.2
802.11ac - VHT80 Beam Forming, Four Antennas, M0.3 to M9.3

802.11ac - VHT80 STBC, Two Antennas, M0.1 to M9.1
802.11ac - VHT80 STBC, Three Antennas, M0.1 to M9.1
802.11ac - VHT80 STBC, Four Antennas, M0.1 to M9.1

The following antennas are supported by this product series.
The data included in this report represent the worst case data for all antennas.

Frequency	Part Number	Antenna Type	Antenna Gain (dBi)	Model
5 GHz	AIR-ANT5140V-R	MIMO 3-Element Omni	4	3800E
	AIR-ANT5140NV-R	MIMO Wall-Mount Omni Antenna	4	3800E
	AIR-ANT5145V-R	Diversity Omni-directional	4.5	3800E
	AIR-ANT5160NP-R	MIMO 3-Element Patch	6	3800E
2.4 / 5 GHz	AIR-ANT2451V-R	Omni	2 / 3	3800E
	AIR-ANT2451NV-R	Omni	3 / 4	3800E
	AIR-ANT2524DB-R	Dual-resonant black dipole	2 / 4	2800E/3800E
	AIR-ANT2524DW-R	Dual-resonant white dipole	2 / 4	2800E/3800E
	AIR-ANT2524DG-R	Dual-resonant gray dipole	2 / 4	2800E/3800E
	AIR-ANT2524V4C-R	Dual-resonant ceiling mount omni (4-pack)	2 / 4	2800E/3800E
	AIR-ANT2535SDW-R	Dual-resonant "stubby" monopole	3 / 5	2800E/3800E
	AIR-ANT2544V4M-R	Dual-resonant omni (4-pack)	4 / 4	2800E/3800E
	AIR-ANT2566P4W-R	Dual-resonant "directional" antenna (4-pack)	6 / 6	2800E/3800E
	AIR-ANT25-LOC-02	Directional HL / Directional WiFi	4 / 4	2800E/3800E
	AIR-ANT25-LOC-03	Linear HL / Omni WiFi	1 / 3	2800E/3800E
	AIR-ANT25-LOC-04	Omni HL / Omni WiFi	1 / 3	2800E/3800E

Section 3: Result Summary

3.1 Results Summary Table

Conducted emissions

Basic Standard	Technical Requirements / Details	Result
FCC 15.407	<p>99% & 26 dB Bandwidth:</p> <p>The 99% occupied bandwidth is the frequency bandwidth such that, below its lower and above its upper frequency limits, the mean powers are each equal to 0.5% of the total mean power of the given emission. There is no limit for 99% OBW.</p> <p>The 26 dB emission is the width of the emission that is constrained by the frequencies associated with the two outermost amplitude points (upper and lower frequencies) that are attenuated by 26 dB relative to the maximum level measured in the fundamental emission.</p>	Pass
FCC 15.407	<p>Output Power:</p> <p>15.407: (i) For an outdoor access point operating in the band 5.15-5.25 GHz, the maximum conducted output power over the frequency band of operation shall not exceed 1 W provided the maximum antenna gain does not exceed 6 dBi. If transmitting antennas of directional gain greater than 6 dBi are used, the maximum conducted output power shall be reduced by the amount in dB that the directional gain of the antenna exceeds 6 dBi. The maximum e.i.r.p. at any elevation angle above 30 degrees as measured from the horizon must not exceed 125 mW (21 dBm).</p> <p>(ii) For an indoor access point operating in the band 5.15-5.25 GHz, the maximum conducted output power over the frequency band of operation shall not exceed 1 W provided the maximum antenna gain does not exceed 6 dBi. If transmitting antennas of directional gain greater than 6 dBi are used, the maximum conducted output power shall be reduced by the amount in dB that the directional gain of the antenna exceeds 6 dBi.</p>	Pass
FCC 15.407	<p>Power Spectral Density:</p> <p>15.407 The maximum power spectral density shall not exceed 17 dBm in any 1 megahertz band. If transmitting antennas of directional gain greater than 6 dBi are used, both the maximum conducted output power and the maximum power spectral density shall be reduced by the amount in dB that the directional gain of the antenna exceeds 6 dBi.</p>	Pass
FCC 15.407	<p>Conducted Spurious Emissions / Band-Edge:</p> <p>For transmitters operating in the 5.15-5.25 GHz band: all emissions outside of the 5.15-5.25 GHz band shall not exceed an EIRP of -27dBm/MHz.</p>	Pass
FCC 15.407 FCC 15.209 FCC 152.05	<p>Restricted band:</p> <p>Unwanted emissions falling within the restricted bands, as defined in FCC 15.205 (a) must also comply with the radiated emission limits specified in FCC 15.209 (a).</p>	Pass

Radiated Emissions (General requirements)

Basic Standard	Technical Requirements / Details	Result
FCC 15.209 FCC 15.205	TX Spurious Emissions: Except as provided elsewhere in this subpart, the emissions from an intentional radiator shall not exceed the field strength levels specified in the filed strength limits table in this section.	Pass
FCC 15.207	AC conducted Emissions: Except when the requirements applicable to a given device state otherwise, for any radio apparatus equipped to operate from the public utility AC power supply, either directly or indirectly (such as with a battery charger), the radio frequency voltage of emissions conducted back onto the AC power lines in the frequency range of 0.15 MHz to 30 MHz shall not exceed the limits shown in the table in these sections. The more stringent limit applies at the frequency range boundaries.	Pass

* MPE calculation is recorded in a separate report

Section 4: Sample Details

Note: Each sample was evaluated to ensure that its condition was suitable to be used as a test sample prior to the commencement of testing.

4.1 Sample Details

Sample No.	Equipment Details	Manufacturer	Hardware Rev.	Firmware Rev.	Software Rev.	Serial Number
S01	AIR-AP3802E-B-K9	Cisco Systems	01	Linux ver 3.14.33	U-boot	FOC1945132D
S02*	PWR-CUBE-B 341-100460-001	Delta	A0	NA	NA	Engineering sample

(*) S02 are support equipment Power supplies for EUT S01

4.2 System Details

System #	Description	Samples
1	AIR-AP3802E-B-K9	S01
2	PWR-CUBE-B	S02

4.3 Mode of Operation Details

Mode#	Description	Comments
1	Continuous Transmitting	Continuous Transmitting ≥98% duty cycle

All measurements were made in accordance with

- ANSI C63.10:2013
- KDB 789033 D02 General UNII Test Procedures New Rules v01r01
- KDB 662911 D01 Multiple Transmitter Output v02r01

Appendix A: Emission Test Results

Conducted Test Setup Diagram

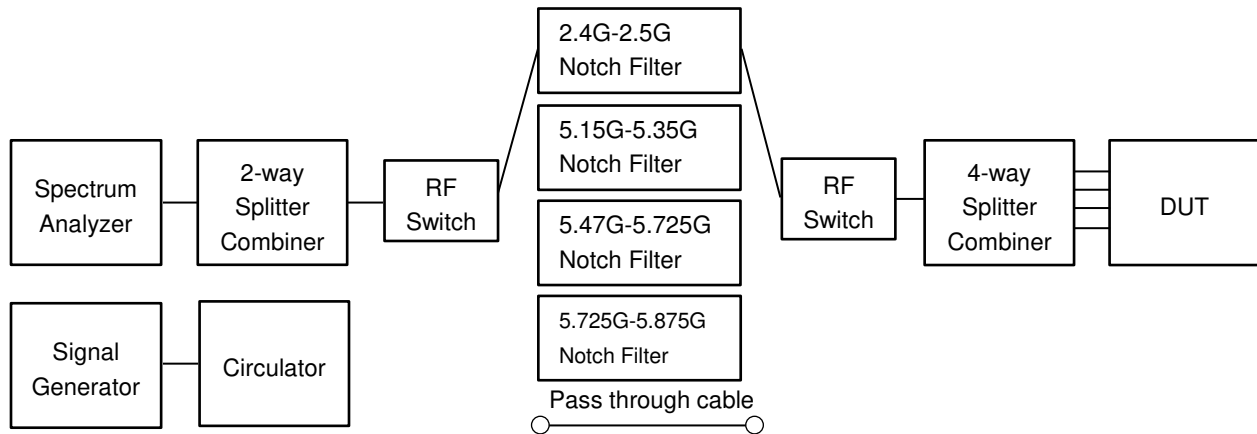

Target Maximum Channel Power

The following table details the maximum supported Total Channel Power for all operating modes.

Operating Mode	Maximum Channel Power (dBm)		
	Frequency (MHz)		
	5180	5220	5240
Non HT20, 6 to 54 Mbps	20	21	21
Non HT20 Beam Forming, 6 to 54 Mbps	17	21	21
HT/VHT20, M0 to M23, M0 to M9 1-0ss	20	21	21
HT/VHT20 Beam Forming, M0 to M23, M0 to M9 1-0ss	20	21	21
HT/VHT20 STBC, M0 to M7	20	21	21
	5190	5230	
Non HT40, 6 to 54 Mbps	18	22	
HT/VHT40, M0 to M23, M0 to M9 1-0ss	19	21	
HT/VHT40 Beam Forming, M0 to M23, M0 to M9 1-0ss	17	21	
HT/VHT40 STBC, M0 to M7	19	21	
	5210		
Non HT80, 6 to 54 Mbps	16		
VHT80, M0 to M9, M0 to M9 1-0ss	18		
VHT80 Beam Forming, M0 to M9, M0 to M9 1-0ss	18		
VHT80 STBC, M0.1 to M9.1	18		

A.1 99% and 26dB Bandwidth

FCC 15.407 The 99% occupied bandwidth is the frequency bandwidth such that, below its lower and above its upper frequency limits, the mean powers are each equal to 0.5% of the total mean power of the given emission. There is no limit for 99% OBW.

The 26 dB emission is the width of the emission that is constrained by the frequencies associated with the two outermost amplitude points (upper and lower frequencies) that are attenuated by 26 dB relative to the maximum level measured in the fundamental emission.

Test Procedure

Ref. ANSI C63.10: 2013 Section 6.9.3

99% BW and EBW (-26dB)

Test Procedure

1. Set the radio in the continuous transmitting mode.
2. Allow the trace to stabilize.
3. Setting the x-dB bandwidth mode to -26dB and OBW power function to 99% within the measurement set up function.
4. Select the automatic OBW measurement function of an instrument to perform bandwidth measurement.
5. Capture graphs and record pertinent measurement data.

Ref. ANSI C63.10: 2013 Section 6.9.3

99% BW and EBW (-26dB)

Test parameters

Span = 1.5 x to 5.0 times OBW

RBW = approx. 1% to 5% of the OBW

VBW \geq 3 x RBW

Detector = Peak or where practical sample shall be used

Trace = Max. Hold

System Number	Description	Samples	System under test	Support equipment
1	EUT	S01	<input checked="" type="checkbox"/>	<input type="checkbox"/>
	Support	S02	<input type="checkbox"/>	<input checked="" type="checkbox"/>

Tested By :

Jose Aguirre

Date of testing:

01-Jan-16 - 22-Feb-16

Test Result : PASS

See Appendix C for list of test equipment



Frequency (MHz)	Mode	Data Rate (Mbps)	26dB BW (MHz)	99% BW (MHz)
5180	Non HT20, 6 to 54 Mbps	6	25.5	18.0
	HT/VHT20, M0 to M23, M0 to M9 1-0ss	m0	24.1	18.4
5190	Non HT40, 6 to 54 Mbps	6	63.6	37.3
	HT/VHT40, M0 to M23, M0 to M9 1-0ss	m0	45.1	36.8
5210	Non HT80, 6 to 54 Mbps	6	82.5	76.4
	VHT80, M0 to M9, M0 to M9 1-0ss	m0x1	83.2	76.6
5220	Non HT20, 6 to 54 Mbps	6	22.2	17.9
	HT/VHT20, M0 to M23, M0 to M9 1-0ss	m0	26.1	18.3
5230	Non HT40, 6 to 54 Mbps	6	49.2	36.9
	HT/VHT40, M0 to M23, M0 to M9 1-0ss	m0	44.3	36.6
5240	Non HT20, 6 to 54 Mbps	6	22.5	17.9
	HT/VHT20, M0 to M23, M0 to M9 1-0ss	m0	23.0	18.3



26dB / 99% Bandwidth, 5180 MHz, Non HT20, 6 to 54 Mbps

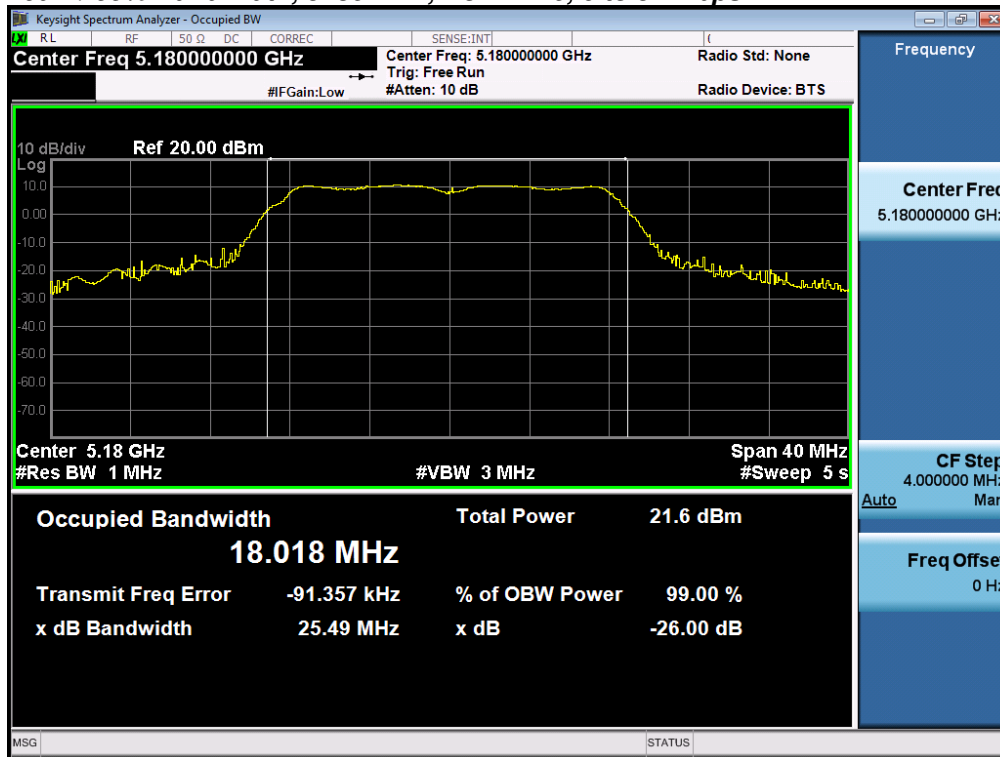

26dB / 99% Bandwidth, 5180 MHz, HT/VHT20, M0 to M23, M0 to M9 1-0ss

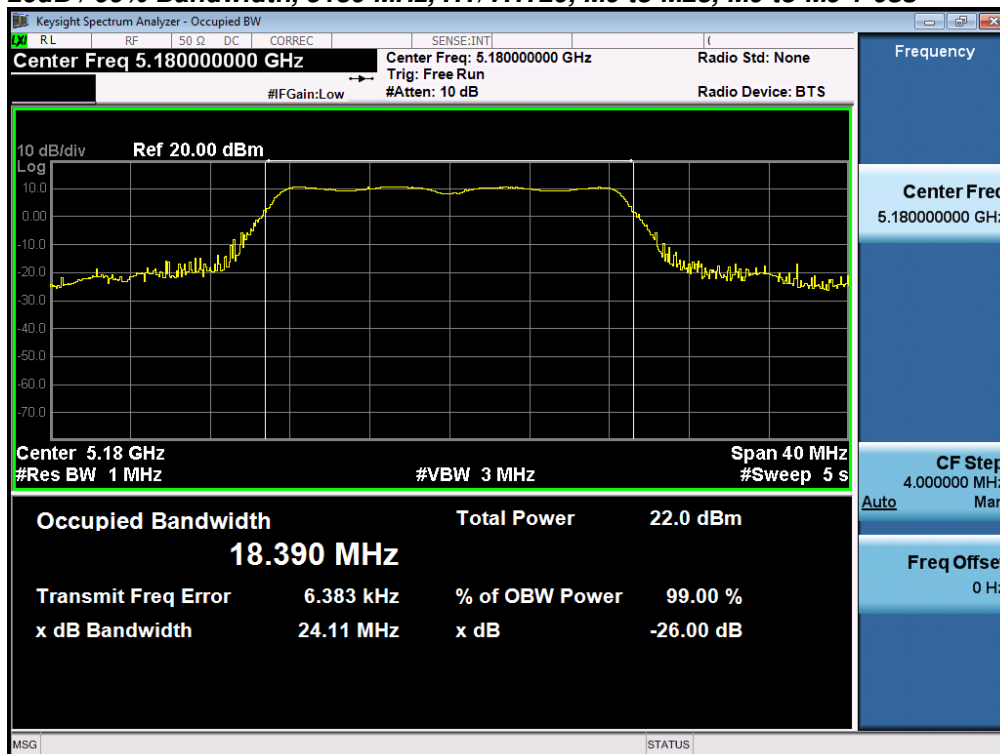



26dB / 99% Bandwidth, 5190 MHz, Non HT40, 6 to 54 Mbps

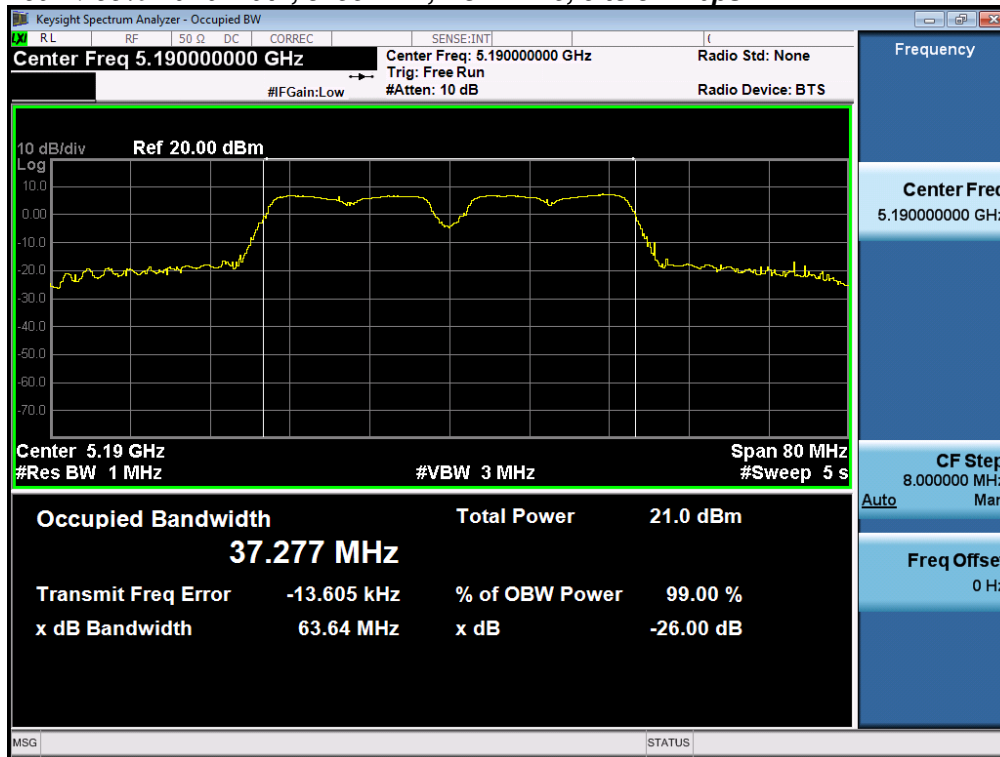

26dB / 99% Bandwidth, 5190 MHz, HT/VHT40, M0 to M23, M0 to M9 1-0ss

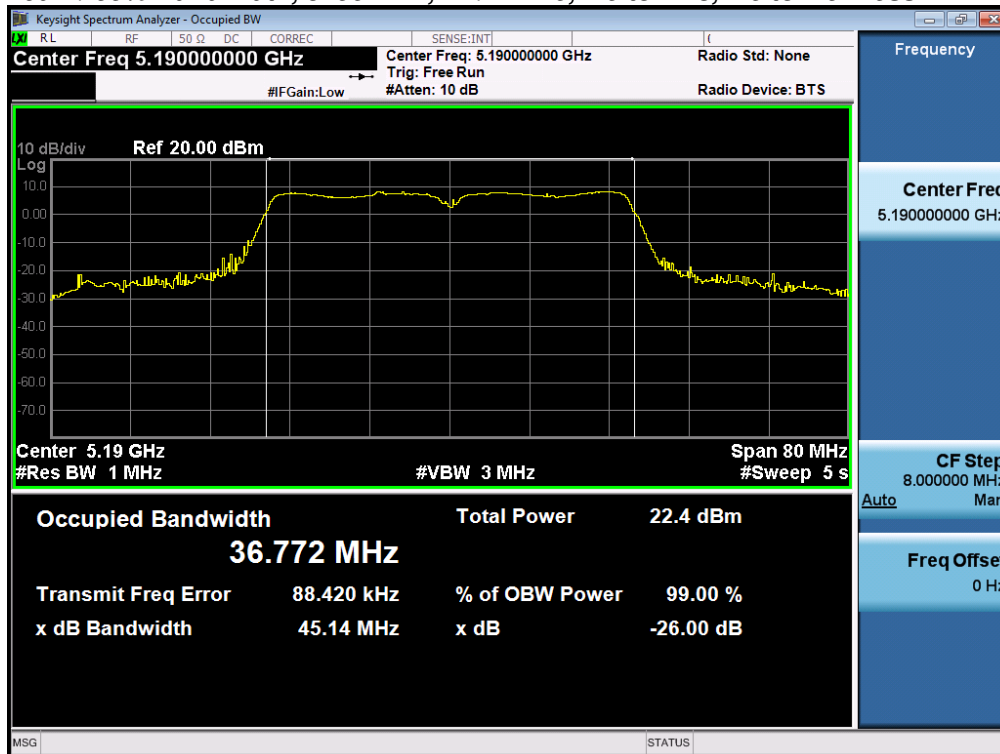



26dB / 99% Bandwidth, 5210 MHz, Non HT80, 6 to 54 Mbps

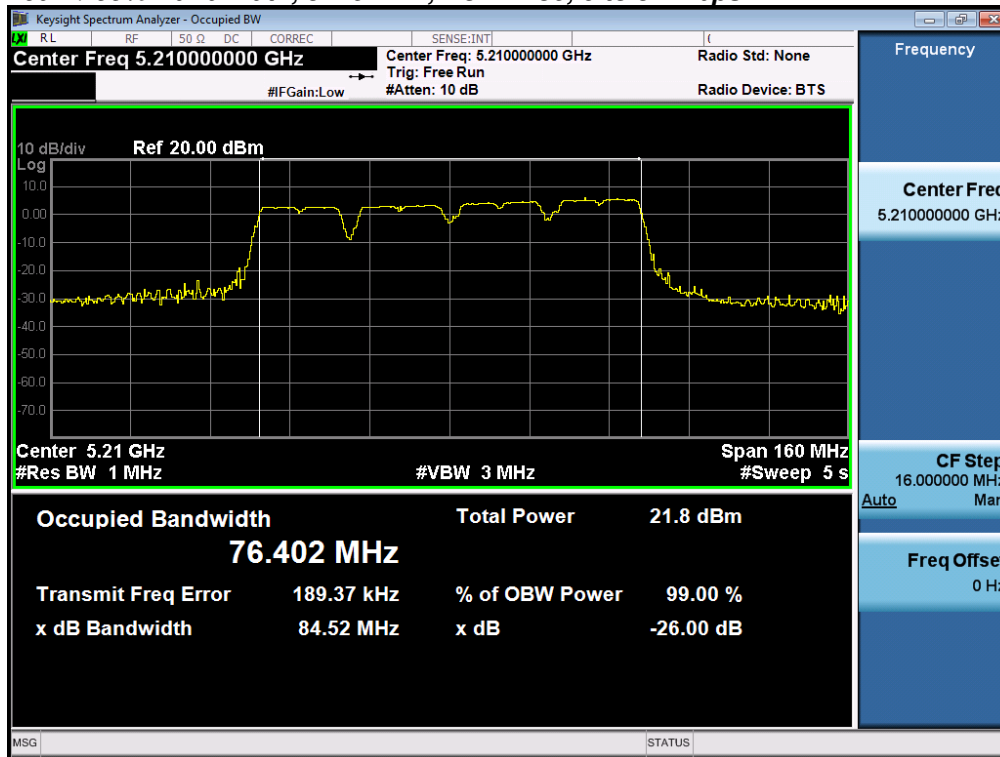

26dB / 99% Bandwidth, 5210 MHz, VHT80, M0 to M9, M0 to M9 1-0ss

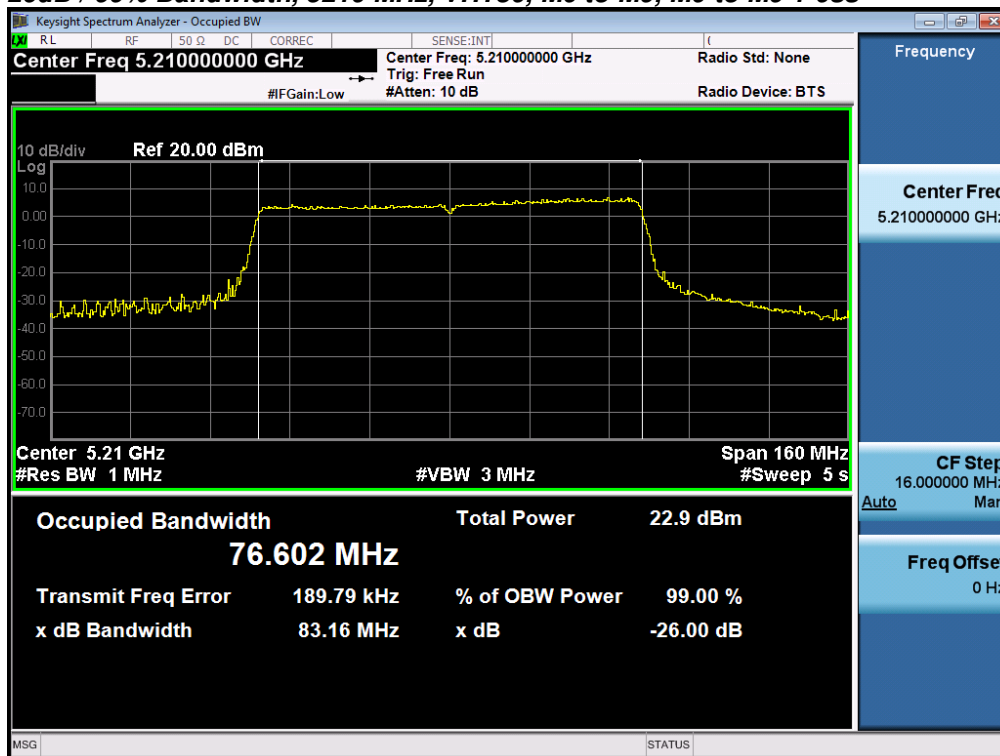



26dB / 99% Bandwidth, 5220 MHz, Non HT20, 6 to 54 Mbps

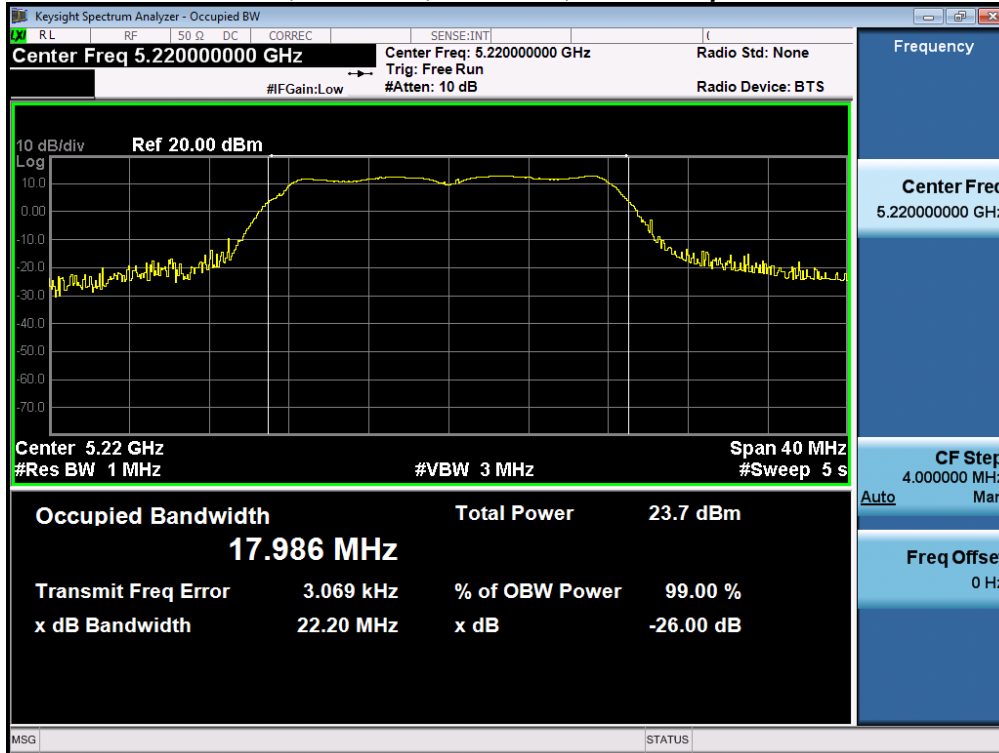

26dB / 99% Bandwidth, 5220 MHz, HT/VHT20, M0 to M23, M0 to M9 1-0ss

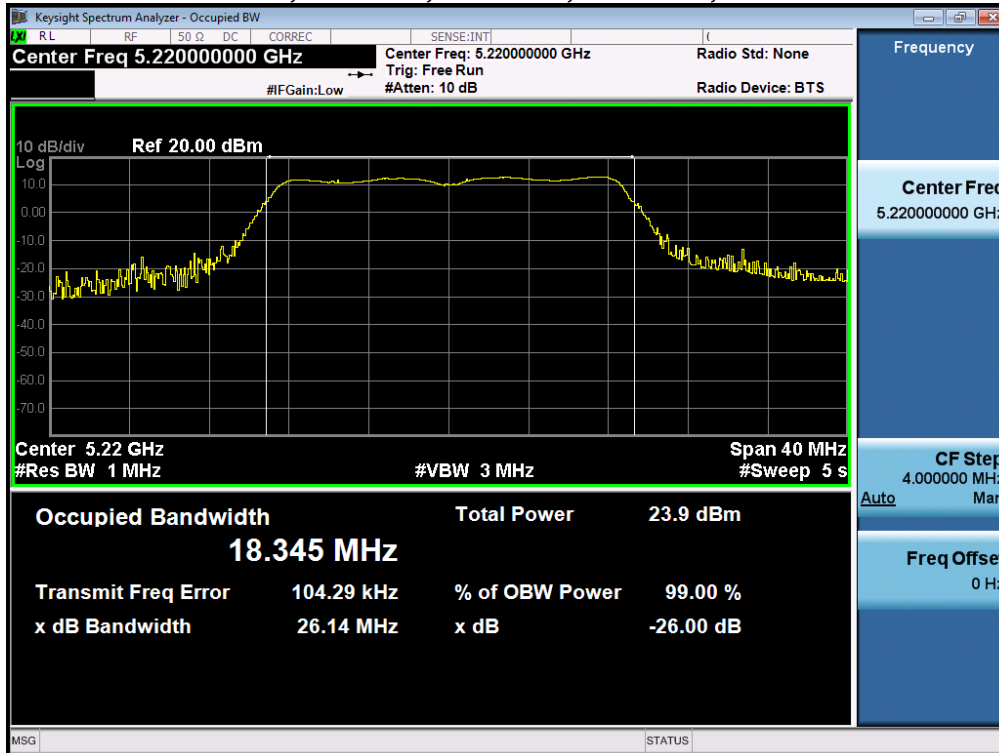



26dB / 99% Bandwidth, 5230 MHz, Non HT40, 6 to 54 Mbps

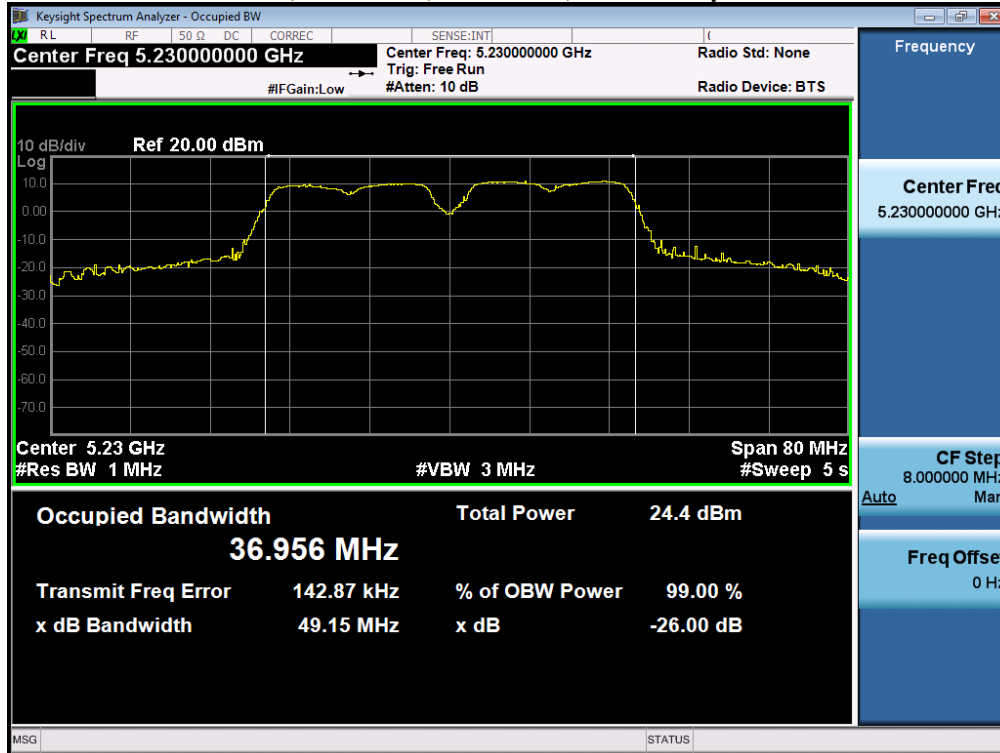

26dB / 99% Bandwidth, 5230 MHz, HT/VHT40, M0 to M23, M0 to M9 1-0ss

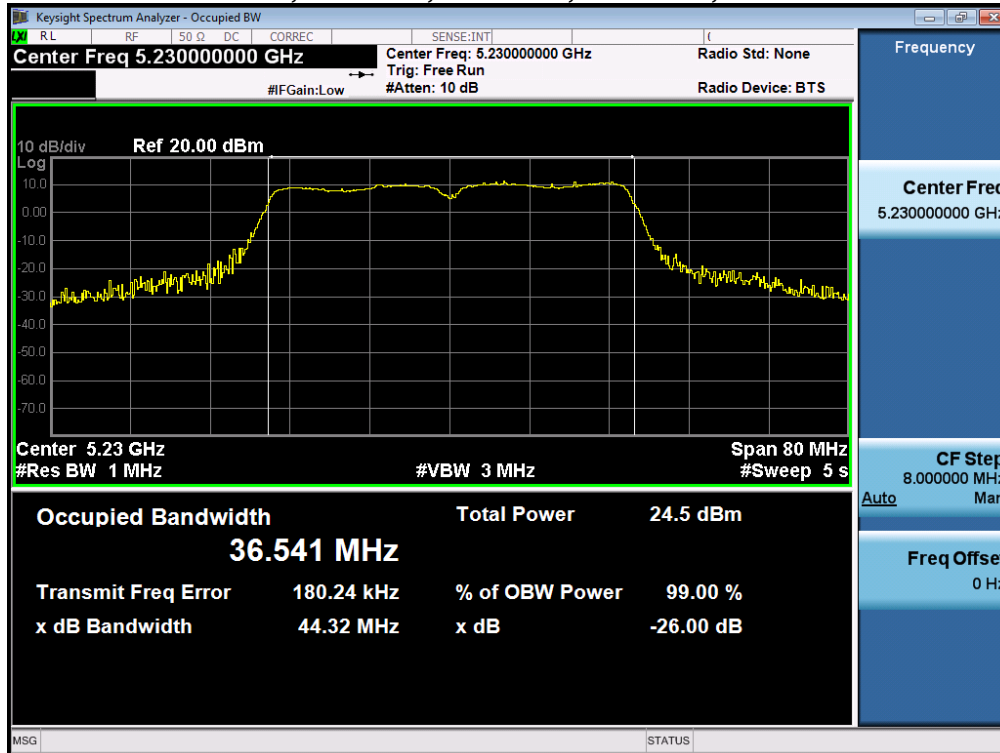

26dB / 99% Bandwidth, 5240 MHz, Non HT20, 6 to 54 Mbps

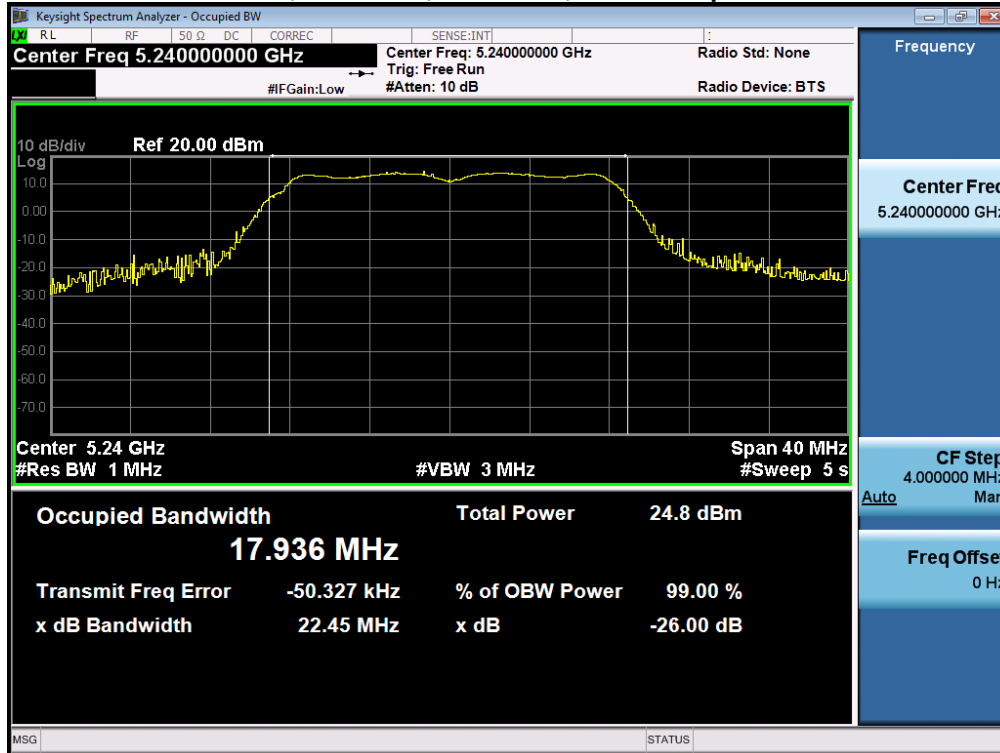

26dB / 99% Bandwidth, 5240 MHz, HT/VHT20, M0 to M23, M0 to M9 1-0ss

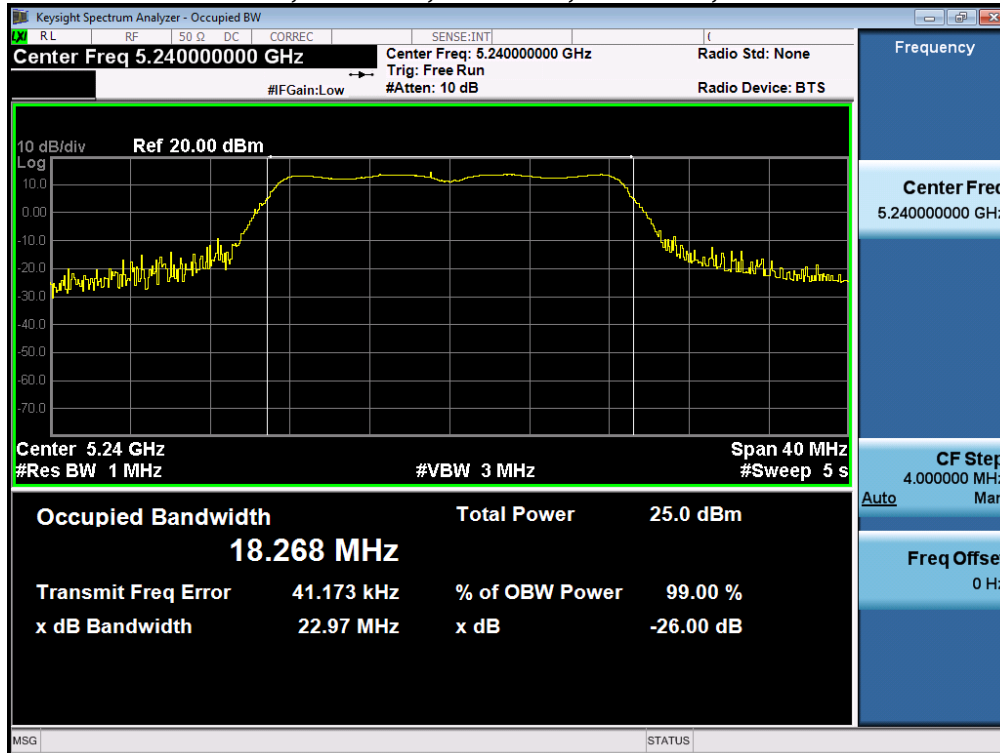

A.2 Maximum Conducted Output Power/ Power Spectral Density

15.407 (i) For an outdoor access point operating in the band 5.15-5.25 GHz, the maximum conducted output power over the frequency band of operation shall not exceed 1 W provided the maximum antenna gain does not exceed 6 dBi. In addition, the maximum power spectral density shall not exceed 17 dBm in any 1 megahertz band. If transmitting antennas of directional gain greater than 6 dBi are used, both the maximum conducted output power and the maximum power spectral density shall be reduced by the amount in dB that the directional gain of the antenna exceeds 6 dBi. The maximum e.i.r.p. at any elevation angle above 30 degrees as measured from the horizon must not exceed 125 mW (21 dBm).

(ii) For an indoor access point operating in the band 5.15-5.25 GHz, the maximum conducted output power over the frequency band of operation shall not exceed 1 W provided the maximum antenna gain does not exceed 6 dBi. In addition, the maximum power spectral density shall not exceed 17 dBm in any 1 megahertz band. If transmitting antennas of directional gain greater than 6 dBi are used, both the maximum conducted output power and the maximum power spectral density shall be reduced by the amount in dB that the directional gain of the antenna exceeds 6 dBi.

Test Procedure

Ref. KDB 789033 D02 General UNII Test Procedures New Rules v01r01
ANSI C63.10: 2013

Output Power
Test Procedure
<ol style="list-style-type: none"> 1. Set the radio in the continuous transmitting mode at full power 2. Compute power by integrating the spectrum across the EBW (or alternatively entire 99% OBW) of the signal using the instrument's band power measurement function. The integration shall be performed using the spectrum analyzer band-power measurement function with band limits set equal to the EBW or the OBW band edges. 3. Capture graphs and record pertinent measurement data.

Ref. KDB 789033 D02 General UNII Test Procedures New Rules v01r01
ANSI C63.10: 2013 section 12.3.2.2 Method SA-1

Output Power
Test parameters
Span = >1.5 times the OBW RBW = 1MHz VBW ≥ 3 x RBW Sweep = Auto couple Detector = sample Trace = Trace Average 100

The "measure-and-sum technique" is used for measuring in-band transmit power of a device. In the measure-and-sum approach, the conducted emission level is measured at each antenna port. The measured results at the various antenna ports are then summed mathematically to determine the total emission level from the device. Summing is performed in linear power units. (See ANSI C63.10 section 14.3.2.2)

System Number	Description	Samples	System under test	Support equipment
1	EUT	S01	<input checked="" type="checkbox"/>	<input type="checkbox"/>
	Support	S02	<input type="checkbox"/>	<input checked="" type="checkbox"/>



Tested By : Jose Aguirre	Date of testing: 01-Jan-16 - 22-Feb-16
Test Result : PASS	

See Appendix C for list of test equipment

Frequency (MHz)	Mode	Tx Paths	Correlated Antenna Gain (dBi)	Tx 1 Max Power (dBm)	Tx 2 Max Power (dBm)	Tx 3 Max Power (dBm)	Tx 4 Max Power (dBm)	Total Tx Channel Power (dBm)	Limit (dBm)	Margin (dB)
5180	Non HT20, 6 to 54 Mbps	1	6	13.8				13.8	30.0	16.2
	Non HT20, 6 to 54 Mbps	2	6	13.8	13.5			16.7	30.0	13.3
	Non HT20, 6 to 54 Mbps	3	6	13.8	13.5	12.4		18.0	30.0	12.0
	Non HT20, 6 to 54 Mbps	4	6	13.8	13.5	12.4	15.5	20.0	30.0	10.0
	Non HT20 Beam Forming, 6 to 54 Mbps	2	9	13.8	13.5			16.7	27.0	10.3
	Non HT20 Beam Forming, 6 to 54 Mbps	3	11	13.8	13.5	12.4		18.0	25.0	7.0
	Non HT20 Beam Forming, 6 to 54 Mbps	4	12	11.7	12.3	11.3	13.0	18.1	24.0	5.9
	HT/VHT20, M0 to M7	1	6	14.1				14.1	30.0	15.9
	HT/VHT20, M0 to M7	2	6	14.1	13.6			16.9	30.0	13.1
	HT/VHT20, M8 to M15	2	6	14.1	13.6			16.9	30.0	13.1
	HT/VHT20, M0 to M7	3	6	14.1	13.6	12.7		18.3	30.0	11.7
	HT/VHT20, M8 to M15	3	6	14.1	13.6	12.7		18.3	30.0	11.7
	HT/VHT20, M16 to M23	3	6	14.1	13.6	12.7		18.3	30.0	11.7
	HT/VHT20, M0 to M7	4	6	14.1	13.6	12.7	15.8	20.2	30.0	9.8
	HT/VHT20, M8 to M15	4	6	14.1	13.6	12.7	15.8	20.2	30.0	9.8
	HT/VHT20, M16 to M23	4	6	14.1	13.6	12.7	15.8	20.2	30.0	9.8
	HT/VHT20 Beam Forming, M0 to M7	2	9	14.1	13.6			16.9	27.0	10.1
	HT/VHT20 Beam Forming, M8 to M15	2	6	14.1	13.6			16.9	30.0	13.1
	HT/VHT20 Beam Forming, M0 to M7	3	11	13.0	13.6	11.6		17.6	25.0	7.4
	HT/VHT20 Beam Forming, M8 to M15	3	8	14.1	13.6	12.7		18.3	28.0	9.7
	HT/VHT20 Beam Forming, M16 to M23	3	6	14.1	13.6	12.7		18.3	30.0	11.7
	HT/VHT20 Beam Forming, M0 to M7	4	12	11.9	12.6	11.5	13.3	18.4	24.0	5.6
	HT/VHT20 Beam Forming, M8 to M15	4	9	14.1	13.6	12.7	15.8	20.2	27.0	6.8
	HT/VHT20 Beam Forming, M16 to M23	4	7	14.1	13.6	12.7	15.8	20.2	29.0	8.8
	HT/VHT20 STBC, M0 to M7	2	6	14.1	13.6			16.9	30.0	13.1
	HT/VHT20 STBC, M0 to M7	3	6	14.1	13.6	12.7		18.3	30.0	11.7
	HT/VHT20 STBC, M0 to M7	4	6	14.1	13.6	12.7	15.8	20.2	30.0	9.8
	5190	Non HT40, 6 to 54 Mbps	1	6	13.1				13.1	30.0
Non HT40, 6 to 54 Mbps		2	6	13.1	13.5			16.3	30.0	13.7
Non HT40, 6 to 54 Mbps		3	6	12.0	12.4	12.1		16.9	30.0	13.1
Non HT40, 6 to 54 Mbps		4	6	12.0	11.3	10.9	13.0	17.9	30.0	12.1
HT/VHT40, M0 to M7		1	6	13.3				13.3	30.0	16.7
HT/VHT40, M0 to M7		2	6	13.3	13.6			16.5	30.0	13.5
HT/VHT40, M8 to M15		2	6	13.3	13.6			16.5	30.0	13.5

	HT/VHT40, M0 to M7	3	6	12.2	12.5	12.2		17.1	30.0	12.9
	HT/VHT40, M8 to M15	3	6	12.2	12.5	12.2		17.1	30.0	12.9
	HT/VHT40, M16 to M23	3	6	12.2	12.5	12.2		17.1	30.0	12.9
	HT/VHT40, M0 to M7	4	6	12.2	12.5	12.2	13.2	18.6	30.0	11.4
	HT/VHT40, M8 to M15	4	6	12.2	12.5	12.2	13.2	18.6	30.0	11.4
	HT/VHT40, M16 to M23	4	6	12.2	12.5	12.2	13.2	18.6	30.0	11.4
	HT/VHT40 Beam Forming, M0 to M7	2	9	11.1	11.4			14.3	27.0	12.7
	HT/VHT40 Beam Forming, M8 to M15	2	6	13.3	13.6			16.5	30.0	13.5
	HT/VHT40 Beam Forming, M0 to M7	3	11	9.8	10.3	9.9		14.8	25.0	10.2
	HT/VHT40 Beam Forming, M8 to M15	3	8	11.1	11.4	11.0		15.9	28.0	12.1
	HT/VHT40 Beam Forming, M16 to M23	3	6	12.2	12.5	12.2		17.1	30.0	12.9
	HT/VHT40 Beam Forming, M0 to M7	4	12	7.9	8.5	8.1	9.0	14.4	24.0	9.6
	HT/VHT40 Beam Forming, M8 to M15	4	9	9.8	10.3	9.9	10.9	16.3	27.0	10.7
	HT/VHT40 Beam Forming, M16 to M23	4	7	11.1	11.4	11.0	12.0	17.4	29.0	11.6
	HT/VHT40 STBC, M0 to M7	2	6	13.3	13.6			16.5	30.0	13.5
	HT/VHT40 STBC, M0 to M7	3	6	12.2	12.5	12.2		17.1	30.0	12.9
	HT/VHT40 STBC, M0 to M7	4	6	12.2	12.5	12.2	13.2	18.6	30.0	11.4
5210	Non HT80, 6 to 54 Mbps	1	6	13.8				13.8	30.0	16.2
	Non HT80, 6 to 54 Mbps	2	6	12.7	12.2			15.5	30.0	14.5
	Non HT80, 6 to 54 Mbps	3	6	11.5	11.1	10.2		15.7	30.0	14.3
	Non HT80, 6 to 54 Mbps	4	6	11.5	11.1	10.2	11.2	17.0	30.0	13.0
	VHT80, M0 to M9 1ss	1	6	14.5				14.5	30.0	15.5
	VHT80, M0 to M9 1ss	2	6	13.3	13.0			16.2	30.0	13.8
	VHT80, M0 to M9 2ss	2	6	13.3	13.0			16.2	30.0	13.8
	VHT80, M0 to M9 1ss	3	6	12.3	11.7	10.9		16.4	30.0	13.6
	VHT80, M0 to M9 2ss	3	6	12.3	11.7	10.9		16.4	30.0	13.6
	VHT80, M0 to M9 3ss	3	6	12.3	11.7	10.9		16.4	30.0	13.6
	VHT80, M0 to M9 1ss	4	6	12.3	11.7	10.9	11.8	17.7	30.0	12.3
	VHT80, M0 to M9 2ss	4	6	12.3	11.7	10.9	11.8	17.7	30.0	12.3
	VHT80, M0 to M9 3ss	4	6	12.3	11.7	10.9	11.8	17.7	30.0	12.3
	VHT80 Beam Forming, M0 to M9 1ss	2	9	11.2	10.6			13.9	27.0	13.1
	VHT80 Beam Forming, M0 to M9 2ss	2	6	13.3	13.0			16.2	30.0	13.8
	VHT80 Beam Forming, M0 to M9 1ss	3	11	9.2	8.7	7.9		13.4	25.0	11.6
	VHT80 Beam Forming, M0 to M9 2ss	3	8	11.2	10.6	9.8		15.3	28.0	12.7
	VHT80 Beam Forming, M0 to M9 3ss	3	6	12.3	11.7	10.9		16.4	30.0	13.6
	VHT80 Beam Forming, M0 to M9 1ss	4	12	8.1	7.6	6.8	7.7	13.6	24.0	10.4
	VHT80 Beam Forming, M0 to M9 2ss	4	9	10.1	9.7	8.8	9.6	15.6	27.0	11.4
	VHT80 Beam Forming, M0 to M9 3ss	4	7	11.2	10.6	9.8	10.5	16.6	29.0	12.4
	VHT80 STBC, M0 to M9 1ss	2	6	13.3	13.0			16.2	30.0	13.8
	VHT80 STBC, M0 to M9 1ss	3	6	12.3	11.7	10.9		16.4	30.0	13.6
VHT80 STBC, M0 to M9 1ss	4	6	12.3	11.7	10.9	11.8	17.7	30.0	12.3	

5220	Non HT20, 6 to 54 Mbps	1	6	15.8				15.8	30.0	14.2
	Non HT20, 6 to 54 Mbps	2	6	15.8	14.5			18.2	30.0	11.8
	Non HT20, 6 to 54 Mbps	3	6	15.8	14.5	13.8		19.6	30.0	10.4
	Non HT20, 6 to 54 Mbps	4	6	15.8	14.5	13.8	15.8	21.1	30.0	8.9
	Non HT20 Beam Forming, 6 to 54 Mbps	2	9	15.8	14.5			18.2	27.0	8.8
	Non HT20 Beam Forming, 6 to 54 Mbps	3	11	15.8	14.5	13.8		19.6	25.0	5.4
	Non HT20 Beam Forming, 6 to 54 Mbps	4	12	15.8	14.5	13.8	15.8	21.1	24.0	2.9
	HT/VHT20, M0 to M7	1	6	15.9				15.9	30.0	14.1
	HT/VHT20, M0 to M7	2	6	15.9	14.5			18.3	30.0	11.7
	HT/VHT20, M8 to M15	2	6	15.9	14.5			18.3	30.0	11.7
	HT/VHT20, M0 to M7	3	6	15.9	14.5	13.9		19.6	30.0	10.4
	HT/VHT20, M8 to M15	3	6	15.9	14.5	13.9		19.6	30.0	10.4
	HT/VHT20, M16 to M23	3	6	15.9	14.5	13.9		19.6	30.0	10.4
	HT/VHT20, M0 to M7	4	6	15.9	14.5	13.9	15.8	21.1	30.0	8.9
	HT/VHT20, M8 to M15	4	6	15.9	14.5	13.9	15.8	21.1	30.0	8.9
	HT/VHT20, M16 to M23	4	6	15.9	14.5	13.9	15.8	21.1	30.0	8.9
	HT/VHT20 Beam Forming, M0 to M7	2	9	15.9	14.5			18.3	27.0	8.7
	HT/VHT20 Beam Forming, M8 to M15	2	6	15.9	14.5			18.3	30.0	11.7
	HT/VHT20 Beam Forming, M0 to M7	3	11	15.9	14.5	13.9		19.6	25.0	5.4
	HT/VHT20 Beam Forming, M8 to M15	3	8	15.9	14.5	13.9		19.6	28.0	8.4
	HT/VHT20 Beam Forming, M16 to M23	3	6	15.9	14.5	13.9		19.6	30.0	10.4
	HT/VHT20 Beam Forming, M0 to M7	4	12	15.9	14.5	13.9	15.8	21.1	24.0	2.9
	HT/VHT20 Beam Forming, M8 to M15	4	9	15.9	14.5	13.9	15.8	21.1	27.0	5.9
	HT/VHT20 Beam Forming, M16 to M23	4	7	15.9	14.5	13.9	15.8	21.1	29.0	7.9
HT/VHT20 STBC, M0 to M7	2	6	15.9	14.5			18.3	30.0	11.7	
HT/VHT20 STBC, M0 to M7	3	6	15.9	14.5	13.9		19.6	30.0	10.4	
HT/VHT20 STBC, M0 to M7	4	6	15.9	14.5	13.9	15.8	21.1	30.0	8.9	
5230	Non HT40, 6 to 54 Mbps	1	6	16.5				16.5	30.0	13.5
	Non HT40, 6 to 54 Mbps	2	6	16.5	15.7			19.1	30.0	10.9
	Non HT40, 6 to 54 Mbps	3	6	16.5	15.7	14.4		20.4	30.0	9.6
	Non HT40, 6 to 54 Mbps	4	6	16.5	15.7	14.4	15.5	21.6	30.0	8.4
	HT/VHT40, M0 to M7	1	6	16.5				16.5	30.0	13.5
	HT/VHT40, M0 to M7	2	6	16.5	14.5			18.6	30.0	11.4
	HT/VHT40, M8 to M15	2	6	16.5	14.5			18.6	30.0	11.4
	HT/VHT40, M0 to M7	3	6	16.5	14.5	13.3		19.7	30.0	10.3
	HT/VHT40, M8 to M15	3	6	16.5	14.5	13.3		19.7	30.0	10.3
	HT/VHT40, M16 to M23	3	6	16.5	14.5	13.3		19.7	30.0	10.3
	HT/VHT40, M0 to M7	4	6	16.5	14.5	13.3	15.4	21.1	30.0	8.9
	HT/VHT40, M8 to M15	4	6	16.5	14.5	13.3	15.4	21.1	30.0	8.9
	HT/VHT40, M16 to M23	4	6	16.5	14.5	13.3	15.4	21.1	30.0	8.9

	HT/VHT40 Beam Forming, M0 to M7	2	9	16.5	14.5			18.6	27.0	8.4
	HT/VHT40 Beam Forming, M8 to M15	2	6	16.5	14.5			18.6	30.0	11.4
	HT/VHT40 Beam Forming, M0 to M7	3	11	16.5	14.5	13.3		19.7	25.0	5.3
	HT/VHT40 Beam Forming, M8 to M15	3	8	16.5	14.5	13.3		19.7	28.0	8.3
	HT/VHT40 Beam Forming, M16 to M23	3	6	16.5	14.5	13.3		19.7	30.0	10.3
	HT/VHT40 Beam Forming, M0 to M7	4	12	16.5	14.5	13.3	15.4	21.1	24.0	2.9
	HT/VHT40 Beam Forming, M8 to M15	4	9	16.5	14.5	13.3	15.4	21.1	27.0	5.9
	HT/VHT40 Beam Forming, M16 to M23	4	7	16.5	14.5	13.3	15.4	21.1	29.0	7.9
	HT/VHT40 STBC, M0 to M7	2	6	16.5	14.5			18.6	30.0	11.4
	HT/VHT40 STBC, M0 to M7	3	6	16.5	14.5	13.3		19.7	30.0	10.3
	HT/VHT40 STBC, M0 to M7	4	6	16.5	14.5	13.3	15.4	21.1	30.0	8.9
5240	Non HT20, 6 to 54 Mbps	1	6	17.0				17.0	30.0	13.0
	Non HT20, 6 to 54 Mbps	2	6	17.0	14.8			19.0	30.0	11.0
	Non HT20, 6 to 54 Mbps	3	6	17.0	14.8	12.6		19.9	30.0	10.1
	Non HT20, 6 to 54 Mbps	4	6	17.0	14.8	12.6	15.7	21.3	30.0	8.7
	Non HT20 Beam Forming, 6 to 54 Mbps	2	9	17.0	14.8			19.0	27.0	8.0
	Non HT20 Beam Forming, 6 to 54 Mbps	3	11	17.0	14.8	12.6		19.9	25.0	5.1
	Non HT20 Beam Forming, 6 to 54 Mbps	4	12	17.0	14.8	12.6	15.7	21.3	24.0	2.7
	HT/VHT20, M0 to M7	1	6	17.1				17.1	30.0	12.9
	HT/VHT20, M0 to M7	2	6	17.1	14.9			19.1	30.0	10.9
	HT/VHT20, M8 to M15	2	6	17.1	14.9			19.1	30.0	10.9
	HT/VHT20, M0 to M7	3	6	17.1	14.9	12.8		20.1	30.0	9.9
	HT/VHT20, M8 to M15	3	6	17.1	14.9	12.8		20.1	30.0	9.9
	HT/VHT20, M16 to M23	3	6	17.1	14.9	12.8		20.1	30.0	9.9
	HT/VHT20, M0 to M7	4	6	17.1	14.9	12.8	15.8	21.4	30.0	8.6
	HT/VHT20, M8 to M15	4	6	17.1	14.9	12.8	15.8	21.4	30.0	8.6
	HT/VHT20, M16 to M23	4	6	17.1	14.9	12.8	15.8	21.4	30.0	8.6
	HT/VHT20 Beam Forming, M0 to M7	2	9	17.1	14.9			19.1	27.0	7.9
	HT/VHT20 Beam Forming, M8 to M15	2	6	17.1	14.9			19.1	30.0	10.9
	HT/VHT20 Beam Forming, M0 to M7	3	11	17.1	14.9	12.8		20.1	25.0	4.9
	HT/VHT20 Beam Forming, M8 to M15	3	8	17.1	14.9	12.8		20.1	28.0	7.9
	HT/VHT20 Beam Forming, M16 to M23	3	6	17.1	14.9	12.8		20.1	30.0	9.9
	HT/VHT20 Beam Forming, M0 to M7	4	12	17.1	14.9	12.8	15.8	21.4	24.0	2.6
	HT/VHT20 Beam Forming, M8 to M15	4	9	17.1	14.9	12.8	15.8	21.4	27.0	5.6
	HT/VHT20 Beam Forming, M16 to M23	4	7	17.1	14.9	12.8	15.8	21.4	29.0	7.6
	HT/VHT20 STBC, M0 to M7	2	6	17.1	14.9			19.1	30.0	10.9
	HT/VHT20 STBC, M0 to M7	3	6	17.1	14.9	12.8		20.1	30.0	9.9
	HT/VHT20 STBC, M0 to M7	4	6	17.1	14.9	12.8	15.8	21.4	30.0	8.6

Frequency (MHz)	Mode	Tx Paths	Correlated Antenna Gain (dBi)	Tx 1 PSD (dBm/MHz)	Tx 2 PSD (dBm/MHz)	Tx 3 PSD (dBm/MHz)	Tx 4 PSD (dBm/MHz)	Total PSD (dBm/MHz)	Limit (dBm/MHz)	Margin (dB)
5180	Non HT20, 6 to 54 Mbps	1	6	3.0				3.0	17.0	14.0
	Non HT20, 6 to 54 Mbps	2	9	3.0	3.0			6.0	14.0	8.0
	Non HT20, 6 to 54 Mbps	3	11	3.0	3.0	2.1		7.5	12.0	4.5
	Non HT20, 6 to 54 Mbps	4	12	3.0	3.0	2.1	4.9	9.4	11.0	1.6
	Non HT20 Beam Forming, 6 to 54 Mbps	2	9	3.0	3.0			6.0	14.0	8.0
	Non HT20 Beam Forming, 6 to 54 Mbps	3	11	3.0	3.0	2.1		7.5	12.0	4.5
	Non HT20 Beam Forming, 6 to 54 Mbps	4	12	1.1	1.8	0.7	2.5	7.6	11.0	3.4
	HT/VHT20, M0 to M7	1	6	3.4				3.4	17.0	13.6
	HT/VHT20, M0 to M7	2	9	3.4	2.8			6.1	14.0	7.9
	HT/VHT20, M8 to M15	2	6	3.4	2.8			6.1	17.0	10.9
	HT/VHT20, M0 to M7	3	11	3.4	2.8	2.5		7.7	12.0	4.3
	HT/VHT20, M8 to M15	3	8	3.4	2.8	2.5		7.7	15.0	7.3
	HT/VHT20, M16 to M23	3	6	3.4	2.8	2.5		7.7	17.0	9.3
	HT/VHT20, M0 to M7	4	12	3.4	2.8	2.5	5.1	9.6	11.0	1.4
	HT/VHT20, M8 to M15	4	9	3.4	2.8	2.5	5.1	9.6	14.0	4.4
	HT/VHT20, M16 to M23	4	7	3.4	2.8	2.5	5.1	9.6	16.0	6.4
	HT/VHT20 Beam Forming, M0 to M7	2	9	3.4	2.8			6.1	14.0	7.9
	HT/VHT20 Beam Forming, M8 to M15	2	6	3.4	2.8			6.1	17.0	10.9
	HT/VHT20 Beam Forming, M0 to M7	3	11	2.1	2.8	1.1		6.8	12.0	5.2
	HT/VHT20 Beam Forming, M8 to M15	3	8	3.4	2.8	2.5		7.7	15.0	7.3
	HT/VHT20 Beam Forming, M16 to M23	3	6	3.4	2.8	2.5		7.7	17.0	9.3
	HT/VHT20 Beam Forming, M0 to M7	4	12	1.3	1.8	1.1	2.5	7.7	11.0	3.3
	HT/VHT20 Beam Forming, M8 to M15	4	9	3.4	2.8	2.5	5.1	9.6	14.0	4.4
	HT/VHT20 Beam Forming, M16 to M23	4	7	3.4	2.8	2.5	5.1	9.6	16.0	6.4
	HT/VHT20 STBC, M0 to M7	2	6	3.4	2.8			6.1	17.0	10.9
	HT/VHT20 STBC, M0 to M7	3	8	3.4	2.8	2.5		7.7	15.0	7.3
	HT/VHT20 STBC, M0 to M7	4	9	3.4	2.8	2.5	5.1	9.6	14.0	4.4
	5190	Non HT40, 6 to 54 Mbps	1	6	-0.2				-0.2	17.0
Non HT40, 6 to 54 Mbps		2	9	-0.2	0.1			3.0	14.0	11.0
Non HT40, 6 to 54 Mbps		3	11	-1.3	-1.0	-0.9		3.7	12.0	8.3
Non HT40, 6 to 54 Mbps		4	12	-1.4	-2.1	-2.2	-0.6	4.5	11.0	6.5
HT/VHT40, M0 to M7		1	6	-0.2				-0.2	17.0	17.2
HT/VHT40, M0 to M7		2	9	-0.2	-0.2			2.8	14.0	11.2
HT/VHT40, M8 to M15		2	6	-0.2	-0.2			2.8	17.0	14.2

	HT/VHT40, M0 to M7	3	11	-1.6	-1.1	-1.2		3.5	12.0	8.5
	HT/VHT40, M8 to M15	3	8	-1.6	-1.1	-1.2		3.5	15.0	11.5
	HT/VHT40, M16 to M23	3	6	-1.6	-1.1	-1.2		3.5	17.0	13.5
	HT/VHT40, M0 to M7	4	12	-1.6	-1.1	-1.2	-0.6	4.9	11.0	6.1
	HT/VHT40, M8 to M15	4	9	-1.6	-1.1	-1.2	-0.6	4.9	14.0	9.1
	HT/VHT40, M16 to M23	4	7	-1.6	-1.1	-1.2	-0.6	4.9	16.0	11.1
	HT/VHT40 Beam Forming, M0 to M7	2	9	-2.4	-1.9			0.9	14.0	13.1
	HT/VHT40 Beam Forming, M8 to M15	2	6	-0.2	-0.2			2.8	17.0	14.2
	HT/VHT40 Beam Forming, M0 to M7	3	11	-3.6	-3.4	-3.5		1.3	12.0	10.7
	HT/VHT40 Beam Forming, M8 to M15	3	8	-2.4	-1.9	-2.4		2.5	15.0	12.5
	HT/VHT40 Beam Forming, M16 to M23	3	6	-1.6	-1.1	-1.2		3.5	17.0	13.5
	HT/VHT40 Beam Forming, M0 to M7	4	12	-5.9	-5.3	-5.1	-4.8	0.8	11.0	10.2
	HT/VHT40 Beam Forming, M8 to M15	4	9	-3.6	-3.4	-3.5	-2.9	2.7	14.0	11.3
	HT/VHT40 Beam Forming, M16 to M23	4	7	-2.4	-1.9	-2.4	-2.0	3.9	16.0	12.1
	HT/VHT40 STBC, M0 to M7	2	6	-0.2	-0.2			2.8	17.0	14.2
	HT/VHT40 STBC, M0 to M7	3	8	-1.6	-1.1	-1.2		3.5	15.0	11.5
	HT/VHT40 STBC, M0 to M7	4	9	-1.6	-1.1	-1.2	-0.6	4.9	14.0	9.1
5210	Non HT80, 6 to 54 Mbps	1	6	-2.0				-2.0	17.0	19.0
	Non HT80, 6 to 54 Mbps	2	9	-3.1	-4.3			-0.6	14.0	14.6
	Non HT80, 6 to 54 Mbps	3	11	-4.3	-5.5	-6.2		-0.5	12.0	12.5
	Non HT80, 6 to 54 Mbps	4	12	-4.3	-5.5	-6.2	-5.7	0.7	11.0	10.3
	VHT80, M0 to M9 1ss	1	6	-1.8				-1.8	17.0	18.8
	VHT80, M0 to M9 1ss	2	9	-2.9	-4.1			-0.4	14.0	14.4
	VHT80, M0 to M9 2ss	2	6	-2.9	-4.1			-0.4	17.0	17.4
	VHT80, M0 to M9 1ss	3	11	-4.0	-5.6	-6.0		-0.3	12.0	12.3
	VHT80, M0 to M9 2ss	3	8	-4.0	-5.6	-6.0		-0.3	15.0	15.3
	VHT80, M0 to M9 3ss	3	6	-4.0	-5.6	-6.0		-0.3	17.0	17.3
	VHT80, M0 to M9 1ss	4	12	-4.0	-5.6	-6.0	-5.5	0.8	11.0	10.2
	VHT80, M0 to M9 2ss	4	9	-4.0	-5.6	-6.0	-5.5	0.8	14.0	13.2
	VHT80, M0 to M9 3ss	4	7	-4.0	-5.6	-6.0	-5.5	0.8	16.0	15.2
	VHT80 Beam Forming, M0 to M9 1ss	2	9	-4.8	-6.6			-2.6	14.0	16.6
	VHT80 Beam Forming, M0 to M9 2ss	2	6	-2.9	-4.1			-0.4	17.0	17.4
	VHT80 Beam Forming, M0 to M9 1ss	3	11	-7.3	-8.2	-9.2		-3.4	12.0	15.4
	VHT80 Beam Forming, M0 to M9 2ss	3	8	-4.8	-6.6	-7.3		-1.3	15.0	16.3
	VHT80 Beam Forming, M0 to M9 3ss	3	6	-4.0	-5.6	-6.0		-0.3	17.0	17.3
	VHT80 Beam Forming, M0 to M9 1ss	4	12	-8.2	-9.4	-10.1	-9.7	-3.3	11.0	14.3
	VHT80 Beam Forming, M0 to M9 2ss	4	9	-6.0	-7.0	-8.2	-8.1	-1.2	14.0	15.2
	VHT80 Beam Forming, M0 to M9 3ss	4	7	-4.8	-6.6	-7.3	-7.2	-0.3	16.0	16.3
	VHT80 STBC, M0 to M9 1ss	2	6	-2.9	-4.1			-0.4	17.0	17.4
	VHT80 STBC, M0 to M9 1ss	3	6	-4.0	-5.6	-6.0		-0.3	17.0	17.3
VHT80 STBC, M0 to M9 1ss	4	6	-4.0	-5.6	-6.0	-5.5	0.8	17.0	16.2	

5220	Non HT20, 6 to 54 Mbps	1	6	5.5				5.5	17.0	11.5
	Non HT20, 6 to 54 Mbps	2	9	5.5	4.1			7.9	14.0	6.1
	Non HT20, 6 to 54 Mbps	3	11	5.5	4.1	3.3		9.2	12.0	2.8
	Non HT20, 6 to 54 Mbps	4	12	5.5	4.1	3.3	5.1	10.6	11.0	0.4
	Non HT20 Beam Forming, 6 to 54 Mbps	2	9	5.5	4.1			7.9	14.0	6.1
	Non HT20 Beam Forming, 6 to 54 Mbps	3	11	5.5	4.1	3.3		9.2	12.0	2.8
	Non HT20 Beam Forming, 6 to 54 Mbps	4	12	5.5	4.1	3.3	5.1	10.6	11.0	0.4
	HT/VHT20, M0 to M7	1	6	5.2				5.2	17.0	11.8
	HT/VHT20, M0 to M7	2	9	5.2	3.8			7.6	14.0	6.4
	HT/VHT20, M8 to M15	2	6	5.2	3.8			7.6	17.0	9.4
	HT/VHT20, M0 to M7	3	11	5.2	3.8	3.2		8.9	12.0	3.1
	HT/VHT20, M8 to M15	3	8	5.2	3.8	3.2		8.9	15.0	6.1
	HT/VHT20, M16 to M23	3	6	5.2	3.8	3.2		8.9	17.0	8.1
	HT/VHT20, M0 to M7	4	12	5.2	3.8	3.2	5.1	10.4	11.0	0.6
	HT/VHT20, M8 to M15	4	9	5.2	3.8	3.2	5.1	10.4	14.0	3.6
	HT/VHT20, M16 to M23	4	7	5.2	3.8	3.2	5.1	10.4	16.0	5.6
	HT/VHT20 Beam Forming, M0 to M7	2	9	5.2	3.8			7.6	14.0	6.4
	HT/VHT20 Beam Forming, M8 to M15	2	6	5.2	3.8			7.6	17.0	9.4
	HT/VHT20 Beam Forming, M0 to M7	3	11	5.2	3.8	3.2		8.9	12.0	3.1
	HT/VHT20 Beam Forming, M8 to M15	3	8	5.2	3.8	3.2		8.9	15.0	6.1
	HT/VHT20 Beam Forming, M16 to M23	3	6	5.2	3.8	3.2		8.9	17.0	8.1
	HT/VHT20 Beam Forming, M0 to M7	4	12	5.2	3.8	3.2	5.1	10.4	11.0	0.6
	HT/VHT20 Beam Forming, M8 to M15	4	9	5.2	3.8	3.2	5.1	10.4	14.0	3.6
HT/VHT20 Beam Forming, M16 to M23	4	7	5.2	3.8	3.2	5.1	10.4	16.0	5.6	
HT/VHT20 STBC, M0 to M7	2	6	5.2	3.8			7.6	17.0	9.4	
HT/VHT20 STBC, M0 to M7	3	8	5.2	3.8	3.2		8.9	15.0	6.1	
HT/VHT20 STBC, M0 to M7	4	9	5.2	3.8	3.2	5.1	10.4	14.0	3.6	
5230	Non HT40, 6 to 54 Mbps	1	6	3.6				3.6	17.0	13.4
	Non HT40, 6 to 54 Mbps	2	9	3.6	2.1			5.9	14.0	8.1
	Non HT40, 6 to 54 Mbps	3	11	3.6	2.1	1.3		7.2	12.0	4.8
	Non HT40, 6 to 54 Mbps	4	12	3.6	2.1	1.3	2.0	8.4	11.0	2.6
	HT/VHT40, M0 to M7	1	6	3.2				3.2	17.0	13.8
	HT/VHT40, M0 to M7	2	9	3.2	0.9			5.2	14.0	8.8
	HT/VHT40, M8 to M15	2	6	3.2	0.9			5.2	17.0	11.8
	HT/VHT40, M0 to M7	3	11	3.2	0.9	0.5		6.5	12.0	5.5
	HT/VHT40, M8 to M15	3	8	3.2	0.9	0.5		6.5	15.0	8.5
	HT/VHT40, M16 to M23	3	6	3.2	0.9	0.5		6.5	17.0	10.5
	HT/VHT40, M0 to M7	4	12	3.2	0.9	0.5	1.6	7.7	11.0	3.3
	HT/VHT40, M8 to M15	4	9	3.2	0.9	0.5	1.6	7.7	14.0	6.3
	HT/VHT40, M16 to M23	4	7	3.2	0.9	0.5	1.6	7.7	16.0	8.3

	HT/VHT40 Beam Forming, M0 to M7	2	9	3.2	0.9			5.2	14.0	8.8
	HT/VHT40 Beam Forming, M8 to M15	2	6	3.2	0.9			5.2	17.0	11.8
	HT/VHT40 Beam Forming, M0 to M7	3	11	3.2	0.9	0.5		6.5	12.0	5.5
	HT/VHT40 Beam Forming, M8 to M15	3	8	3.2	0.9	0.5		6.5	15.0	8.5
	HT/VHT40 Beam Forming, M16 to M23	3	6	3.2	0.9	0.5		6.5	17.0	10.5
	HT/VHT40 Beam Forming, M0 to M7	4	12	3.2	0.9	0.5	1.6	7.7	11.0	3.3
	HT/VHT40 Beam Forming, M8 to M15	4	9	3.2	0.9	0.5	1.6	7.7	14.0	6.3
	HT/VHT40 Beam Forming, M16 to M23	4	7	3.2	0.9	0.5	1.6	7.7	16.0	8.3
	HT/VHT40 STBC, M0 to M7	2	6	3.2	0.9			5.2	17.0	11.8
	HT/VHT40 STBC, M0 to M7	3	8	3.2	0.9	0.5		6.5	15.0	8.5
	HT/VHT40 STBC, M0 to M7	4	9	3.2	0.9	0.5	1.6	7.7	14.0	6.3
5240	Non HT20, 6 to 54 Mbps	1	6	6.5				6.5	17.0	10.5
	Non HT20, 6 to 54 Mbps	2	9	6.5	4.1			8.5	14.0	5.5
	Non HT20, 6 to 54 Mbps	3	11	6.5	4.1	2.1		9.4	12.0	2.6
	Non HT20, 6 to 54 Mbps	4	12	6.5	4.1	2.1	5.2	10.8	11.0	0.2
	Non HT20 Beam Forming, 6 to 54 Mbps	2	9	6.5	4.1			8.5	14.0	5.5
	Non HT20 Beam Forming, 6 to 54 Mbps	3	11	6.5	4.1	2.1		9.4	12.0	2.6
	Non HT20 Beam Forming, 6 to 54 Mbps	4	12	6.5	4.1	2.1	5.2	10.8	11.0	0.2
	HT/VHT20, M0 to M7	1	6	6.4				6.4	17.0	10.6
	HT/VHT20, M0 to M7	2	9	6.4	4.4			8.5	14.0	5.5
	HT/VHT20, M8 to M15	2	6	6.4	4.4			8.5	17.0	8.5
	HT/VHT20, M0 to M7	3	11	6.4	4.4	2.5		9.5	12.0	2.5
	HT/VHT20, M8 to M15	3	8	6.4	4.4	2.5		9.5	15.0	5.5
	HT/VHT20, M16 to M23	3	6	6.4	4.4	2.5		9.5	17.0	7.5
	HT/VHT20, M0 to M7	4	12	6.4	4.4	2.5	5.0	10.8	11.0	0.2
	HT/VHT20, M8 to M15	4	9	6.4	4.4	2.5	5.0	10.8	14.0	3.2
	HT/VHT20, M16 to M23	4	7	6.4	4.4	2.5	5.0	10.8	16.0	5.2
	HT/VHT20 Beam Forming, M0 to M7	2	9	6.4	4.4			8.5	14.0	5.5
	HT/VHT20 Beam Forming, M8 to M15	2	6	6.4	4.4			8.5	17.0	8.5
	HT/VHT20 Beam Forming, M0 to M7	3	11	6.4	4.4	2.5		9.5	12.0	2.5
	HT/VHT20 Beam Forming, M8 to M15	3	8	6.4	4.4	2.5		9.5	15.0	5.5
	HT/VHT20 Beam Forming, M16 to M23	3	6	6.4	4.4	2.5		9.5	17.0	7.5
	HT/VHT20 Beam Forming, M0 to M7	4	12	6.4	4.4	2.5	5.0	10.8	11.0	0.2
	HT/VHT20 Beam Forming, M8 to M15	4	9	6.4	4.4	2.5	5.0	10.8	14.0	3.2
	HT/VHT20 Beam Forming, M16 to M23	4	7	6.4	4.4	2.5	5.0	10.8	16.0	5.2
	HT/VHT20 STBC, M0 to M7	2	6	6.4	4.4			8.5	17.0	8.5
	HT/VHT20 STBC, M0 to M7	3	8	6.4	4.4	2.5		9.5	15.0	5.5
HT/VHT20 STBC, M0 to M7	4	9	6.4	4.4	2.5	5.0	10.8	14.0	3.2	

Peak Output Power, 5240 MHz, HT/VHT20 Beam Forming, M0 to M7

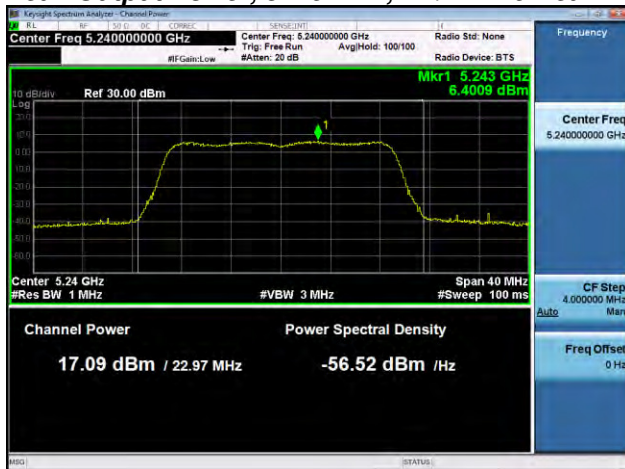

Antenna A

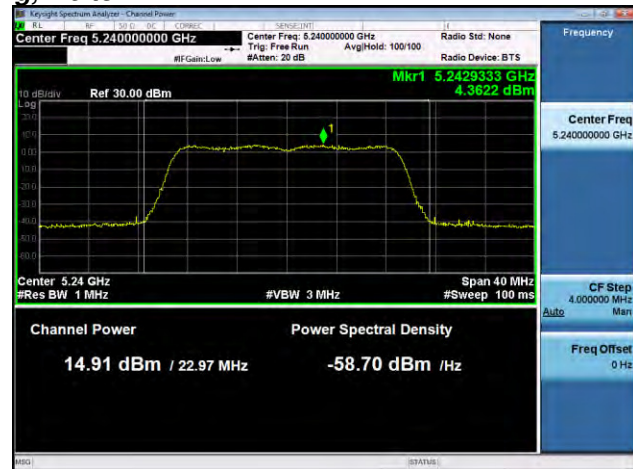

Antenna B

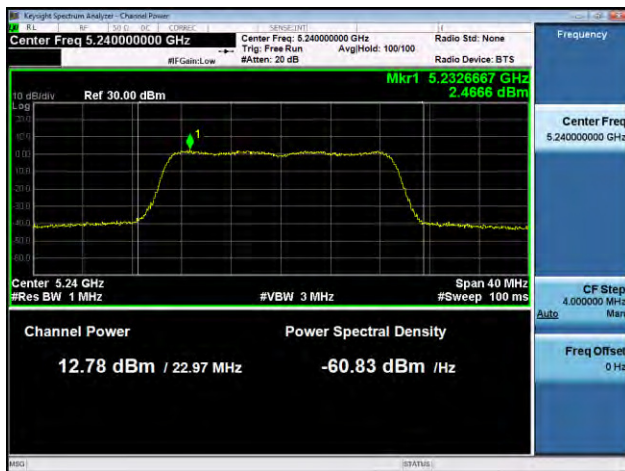

Antenna C

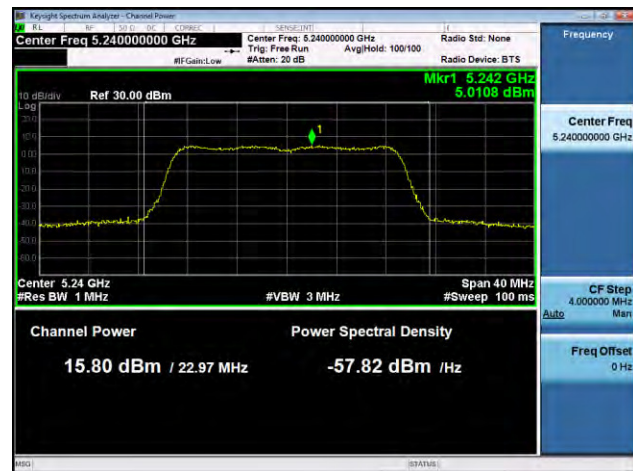

Antenna D

Power Spectral Density, 5240 MHz, HT/VHT20 Beam Forming, M0 to M7

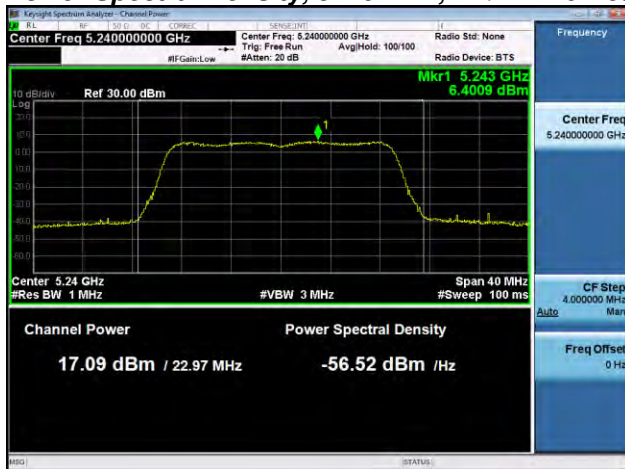

Antenna A

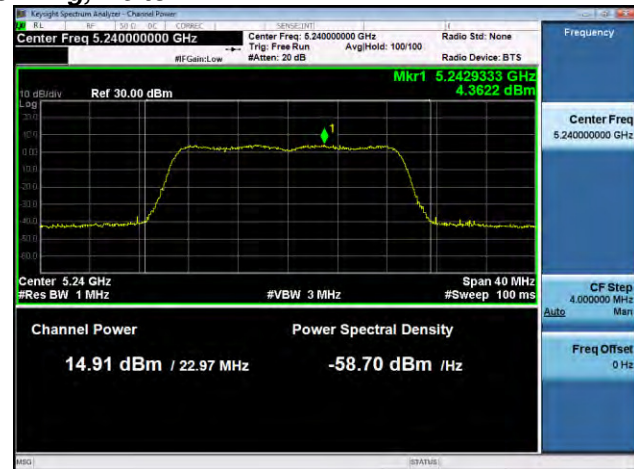

Antenna B

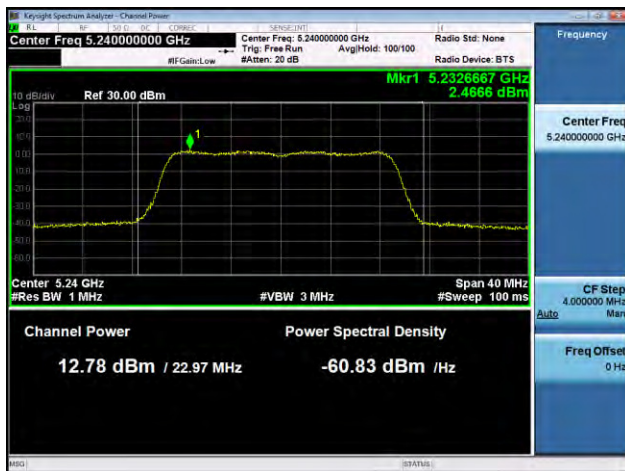

Antenna C

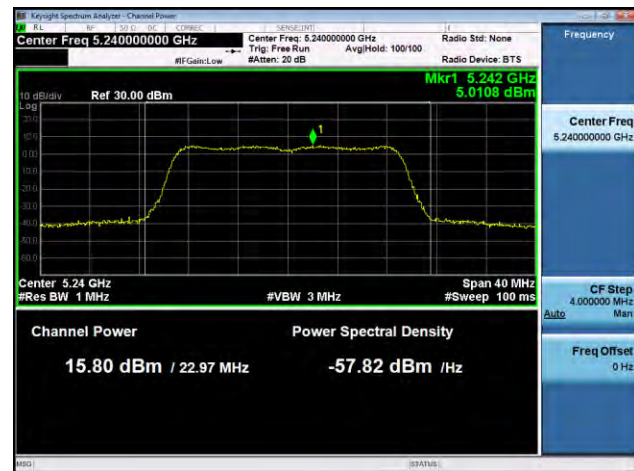

Antenna D

A.3 Conducted Spurious Emissions

15.407 (b) Undesirable emission limits. Except as shown in paragraph (b) (7) of this section, the maximum emissions outside of the frequency bands of operation shall be attenuated in accordance with the following limits:

(1) For transmitters operating in the 5.15-5.25 GHz band: All emissions outside of the 5.15-5.35 GHz band shall not exceed an e.i.r.p. of -27 dBm/MHz.

Radiated emissions which fall in the restricted bands, as defined in Section 15.205(a), must also comply with the radiated emission limits specified in Section 15.209(a) (see Section 15.205(c)).

Test Procedure

Ref. KDB 789033 D02 General UNII Test Procedures New Rules v01r01
ANSI C63.10: 2013

Conducted Spurious Emissions

Test Procedure

1. Connect the antenna port(s) to the spectrum analyzer input.
2. Place the radio in continuous transmit mode. Use the procedures in KDB 789033 D02 General UNII Test Procedures New Rules v01 to substitute conducted measurements in place of radiated measurements.
3. Configure Spectrum analyzer as per test parameters below (be sure to enter all losses between the transmitter output and the spectrum analyzer).
4. Record the marker waveform peak to spur difference. Also measure any emissions in the restricted bands.
5. The "measure-and-sum technique" is used for measuring in-band transmit power of a device. In the measure-and-sum approach, the conducted emission level is measured at each antenna port. The measured results at the various antenna ports are then summed mathematically to determine the total emission level from the device. Summing is performed in linear power units. The worst case output is recorded.
6. Capture graphs and record pertinent measurement data.

Ref. KDB 789033 D02 General UNII Test Procedures New Rules v01r01
ANSI C63.10: 2013 section 12.7.7.3 (average) & 12.7.6 (peak)

Conducted Spurious Emissions

Test parameters

Span = 30MHz to 18GHz / 18GHz to 40GHz
 RBW = 1 MHz
 VBW $\geq 3 \times$ RBW for Peak, 1kHz for Average
 Sweep = Auto couple
 Detector = Peak
 Trace = Max Hold.

System Number	Description	Samples	System under test	Support equipment
1	EUT	S01	<input checked="" type="checkbox"/>	<input type="checkbox"/>
	Support	S02	<input type="checkbox"/>	<input checked="" type="checkbox"/>

Tested By :

Jose Aguirre

Date of testing:

01-Jan-16 - 22-Feb-16

Test Result : PASS

See Appendix C for list of test equipment

Frequency (MHz)	Mode	Tx Paths	Correlated Antenna Gain (dBi)	Tx 1 Spur Power (dBm)	Tx 2 Spur Power (dBm)	Tx 3 Spur Power (dBm)	Tx 4 Spur Power (dBm)	Total Conducted Spur (dBm)	Limit (dBm)	Margin (dB)
5180	Non HT20, 6 to 54 Mbps	1	6	-67.5				-61.5	-41.25	20.3
	Non HT20, 6 to 54 Mbps	2	6	-67.5	-67.5			-58.5	-41.25	17.2
	Non HT20, 6 to 54 Mbps	3	6	-67.5	-67.5	-67.5		-56.7	-41.25	15.5
	Non HT20, 6 to 54 Mbps	4	6	-67.5	-67.5	-67.5	-67.5	-55.5	-41.25	14.2
	Non HT20 Beam Forming, 6 to 54 Mbps	2	9	-67.5	-67.5			-55.5	-41.25	14.2
	Non HT20 Beam Forming, 6 to 54 Mbps	3	11	-67.5	-67.5	-67.5		-51.9	-41.25	10.7
	Non HT20 Beam Forming, 6 to 54 Mbps	4	12	-67.5	-67.5	-67.5	-67.5	-49.5	-41.25	8.2
	HT/VHT20, M0 to M7	1	6	-67.8				-61.8	-41.25	20.6
	HT/VHT20, M0 to M7	2	6	-67.8	-67.8			-58.8	-41.25	17.5
	HT/VHT20, M8 to M15	2	6	-67.8	-67.8			-58.8	-41.25	17.5
	HT/VHT20, M0 to M7	3	6	-67.8	-67.8	-67.6		-57.0	-41.25	15.7
	HT/VHT20, M8 to M15	3	6	-67.8	-67.8	-67.6		-57.0	-41.25	15.7
	HT/VHT20, M16 to M23	3	6	-67.8	-67.8	-67.6		-57.0	-41.25	15.7
	HT/VHT20, M0 to M7	4	6	-67.8	-67.8	-67.6	-67.5	-55.7	-41.25	14.4
	HT/VHT20, M8 to M15	4	6	-67.8	-67.8	-67.6	-67.5	-55.7	-41.25	14.4
	HT/VHT20, M16 to M23	4	6	-67.8	-67.8	-67.6	-67.5	-55.7	-41.25	14.4
	HT/VHT20 Beam Forming, M0 to M7	2	9	-67.8	-67.8			-55.8	-41.25	14.5
	HT/VHT20 Beam Forming, M8 to M15	2	6	-67.8	-67.8			-58.8	-41.25	17.5
	HT/VHT20 Beam Forming, M0 to M7	3	11	-67.8	-67.8	-67.6		-52.2	-41.25	10.9
	HT/VHT20 Beam Forming, M8 to M15	3	8	-67.8	-67.8	-67.6		-55.2	-41.25	13.9
	HT/VHT20 Beam Forming, M16 to M23	3	6	-67.8	-67.8	-67.6		-57.0	-41.25	15.7
	HT/VHT20 Beam Forming, M0 to M7	4	12	-67.8	-67.8	-67.6	-67.5	-49.7	-41.25	8.4
	HT/VHT20 Beam Forming, M8 to M15	4	9	-67.8	-67.8	-67.6	-67.5	-52.7	-41.25	11.4
	HT/VHT20 Beam Forming, M16 to M23	4	7	-67.8	-67.8	-67.6	-67.5	-54.5	-41.25	13.2
HT/VHT20 STBC, M0 to M7	2	6	-67.8	-67.8			-58.8	-41.25	17.5	
HT/VHT20 STBC, M0 to M7	3	6	-67.8	-67.8	-67.6		-57.0	-41.25	15.7	
HT/VHT20 STBC, M0 to M7	4	6	-67.8	-67.8	-67.6	-67.5	-55.7	-41.25	14.4	
5190	Non HT40, 6 to 54 Mbps	1	6	-67.2				-61.2	-41.25	20.0
	Non HT40, 6 to 54 Mbps	2	6	-67.2	-67.6			-58.4	-41.25	17.1
	Non HT40, 6 to 54 Mbps	3	6	-67.2	-67.6	-67.5		-56.7	-41.25	15.4
	Non HT40, 6 to 54 Mbps	4	6	-67.2	-67.6	-67.5	-67.6	-55.5	-41.25	14.2
	HT/VHT40, M0 to M7	1	6	-67.7				-61.7	-41.25	20.5
	HT/VHT40, M0 to M7	2	6	-67.7	-67.5			-58.6	-41.25	17.3
	HT/VHT40, M8 to M15	2	6	-67.7	-67.5			-58.6	-41.25	17.3

	HT/VHT40, M0 to M7	3	6	-67.7	-67.5	-67.5		-56.8	-41.25	15.5
	HT/VHT40, M8 to M15	3	6	-67.7	-67.5	-67.5		-56.8	-41.25	15.5
	HT/VHT40, M16 to M23	3	6	-67.7	-67.5	-67.5		-56.8	-41.25	15.5
	HT/VHT40, M0 to M7	4	6	-67.7	-67.5	-67.5	-67.6	-55.6	-41.25	14.3
	HT/VHT40, M8 to M15	4	6	-67.7	-67.5	-67.5	-67.6	-55.6	-41.25	14.3
	HT/VHT40, M16 to M23	4	6	-67.7	-67.5	-67.5	-67.6	-55.6	-41.25	14.3
	HT/VHT40 Beam Forming, M0 to M7	2	9	-67.7	-67.5			-55.6	-41.25	14.3
	HT/VHT40 Beam Forming, M8 to M15	2	6	-67.7	-67.5			-58.6	-41.25	17.3
	HT/VHT40 Beam Forming, M0 to M7	3	11	-67.7	-67.5	-67.5		-52.0	-41.25	10.7
	HT/VHT40 Beam Forming, M8 to M15	3	8	-67.7	-67.5	-67.5		-55.0	-41.25	13.7
	HT/VHT40 Beam Forming, M16 to M23	3	6	-67.7	-67.5	-67.5		-56.8	-41.25	15.5
	HT/VHT40 Beam Forming, M0 to M7	4	12	-67.7	-67.5	-67.5	-67.6	-49.6	-41.25	8.3
	HT/VHT40 Beam Forming, M8 to M15	4	9	-67.7	-67.5	-67.5	-67.6	-52.6	-41.25	11.3
	HT/VHT40 Beam Forming, M16 to M23	4	7	-67.7	-67.5	-67.5	-67.6	-54.4	-41.25	13.1
	HT/VHT40 STBC, M0 to M7	2	6	-67.7	-67.5			-58.6	-41.25	17.3
	HT/VHT40 STBC, M0 to M7	3	6	-67.7	-67.5	-67.5		-56.8	-41.25	15.5
	HT/VHT40 STBC, M0 to M7	4	6	-67.7	-67.5	-67.5	-67.6	-55.6	-41.25	14.3
5210	Non HT80, 6 to 54 Mbps	1	6	-67.7				-61.7	-41.25	20.5
	Non HT80, 6 to 54 Mbps	2	6	-67.7	-67.4			-58.5	-41.25	17.3
	Non HT80, 6 to 54 Mbps	3	6	-67.7	-67.4	-67.5		-56.8	-41.25	15.5
	Non HT80, 6 to 54 Mbps	4	6	-67.7	-67.4	-67.5	-67.3	-55.5	-41.25	14.2
	VHT80, M0.1 to M9.1	1	6	-67.6				-61.6	-41.25	20.4
	VHT80, M0.1 to M9.1	2	6	-67.6	-67.6			-58.6	-41.25	17.3
	VHT80, M0.2 to M9.2	2	6	-67.6	-67.6			-58.6	-41.25	17.3
	VHT80, M0.1 to M9.1	3	6	-67.6	-67.6	-67.6		-56.8	-41.25	15.6
	VHT80, M0.2 to M9.2	3	6	-67.6	-67.6	-67.6		-56.8	-41.25	15.6
	VHT80, M0.3 to M9.3	3	6	-67.6	-67.6	-67.6		-56.8	-41.25	15.6
	VHT80, M0.1 to M9.1	4	6	-67.6	-67.6	-67.6	-67.5	-55.6	-41.25	14.3
	VHT80, M0.2 to M9.2	4	6	-67.6	-67.6	-67.6	-67.5	-55.6	-41.25	14.3
	VHT80, M0.3 to M9.3	4	6	-67.6	-67.6	-67.6	-67.5	-55.6	-41.25	14.3
	VHT80 Beam Forming, M0.1 to M9.1	2	6	-67.6	-67.6			-58.6	-41.25	17.3
	VHT80 Beam Forming, M0.2 to M9.2	2	6	-67.6	-67.6			-58.6	-41.25	17.3
	VHT80 Beam Forming, M0.1 to M9.1	3	6	-67.6	-67.6	-67.6		-56.8	-41.25	15.6
	VHT80 Beam Forming, M0.2 to M9.2	3	6	-67.6	-67.6	-67.6		-56.8	-41.25	15.6
	VHT80 Beam Forming, M0.3 to M9.3	3	6	-67.6	-67.6	-67.6		-56.8	-41.25	15.6
	VHT80 Beam Forming, M0.1 to M9.1	4	6	-67.6	-67.6	-67.6	-67.5	-55.6	-41.25	14.3
	VHT80 Beam Forming, M0.2 to M9.2	4	6	-67.6	-67.6	-67.6	-67.5	-55.6	-41.25	14.3
	VHT80 Beam Forming, M0.3 to M9.3	4	6	-67.6	-67.6	-67.6	-67.5	-55.6	-41.25	14.3
	VHT80 STBC, M0.1 to M9.1	2	6	-67.6	-67.6			-58.6	-41.25	17.3
VHT80 STBC, M0.1 to M9.1	3	6	-67.6	-67.6	-67.6		-56.8	-41.25	15.6	
VHT80 STBC, M0.1 to M9.1	4	6	-67.6	-67.6	-67.6	-67.5	-55.6	-41.25	14.3	

5220	Non HT20, 6 to 54 Mbps	1	6	-68.6				-62.6	-41.25	21.4
	Non HT20, 6 to 54 Mbps	2	6	-68.6	-68.8			-59.7	-41.25	18.4
	Non HT20, 6 to 54 Mbps	3	6	-68.6	-68.8	-68.6		-57.9	-41.25	16.6
	Non HT20, 6 to 54 Mbps	4	6	-68.6	-68.8	-68.6	-68.4	-56.6	-41.25	15.3
	Non HT20 Beam Forming, 6 to 54 Mbps	2	9	-68.6	-68.8			-56.7	-41.25	15.4
	Non HT20 Beam Forming, 6 to 54 Mbps	3	11	-68.6	-68.8	-68.6		-53.1	-41.25	11.8
	Non HT20 Beam Forming, 6 to 54 Mbps	4	12	-68.6	-68.8	-68.6	-68.4	-50.6	-41.25	9.3
	HT/VHT20, M0 to M7	1	6	-68.5				-62.5	-41.25	21.3
	HT/VHT20, M0 to M7	2	6	-68.5	-66.7			-58.5	-41.25	17.2
	HT/VHT20, M8 to M15	2	6	-68.5	-66.7			-58.5	-41.25	17.2
	HT/VHT20, M0 to M7	3	6	-68.5	-66.7	-68.8		-57.1	-41.25	15.9
	HT/VHT20, M8 to M15	3	6	-68.5	-66.7	-68.8		-57.1	-41.25	15.9
	HT/VHT20, M16 to M23	3	6	-68.5	-66.7	-68.8		-57.1	-41.25	15.9
	HT/VHT20, M0 to M7	4	6	-68.5	-66.7	-68.8	-68.7	-56.1	-41.25	14.8
	HT/VHT20, M8 to M15	4	6	-68.5	-66.7	-68.8	-68.7	-56.1	-41.25	14.8
	HT/VHT20, M16 to M23	4	6	-68.5	-66.7	-68.8	-68.7	-56.1	-41.25	14.8
	HT/VHT20 Beam Forming, M0 to M7	2	9	-68.5	-66.7			-55.5	-41.25	14.2
	HT/VHT20 Beam Forming, M8 to M15	2	6	-68.5	-66.7			-58.5	-41.25	17.2
	HT/VHT20 Beam Forming, M0 to M7	3	11	-68.5	-66.7	-68.8		-52.3	-41.25	11.1
	HT/VHT20 Beam Forming, M8 to M15	3	8	-68.5	-66.7	-68.8		-55.3	-41.25	14.1
	HT/VHT20 Beam Forming, M16 to M23	3	6	-68.5	-66.7	-68.8		-57.1	-41.25	15.9
	HT/VHT20 Beam Forming, M0 to M7	4	12	-68.5	-66.7	-68.8	-68.7	-50.1	-41.25	8.8
	HT/VHT20 Beam Forming, M8 to M15	4	9	-68.5	-66.7	-68.8	-68.7	-53.1	-41.25	11.8
	HT/VHT20 Beam Forming, M16 to M23	4	7	-68.5	-66.7	-68.8	-68.7	-54.9	-41.25	13.6
HT/VHT20 STBC, M0 to M7	2	6	-68.5	-66.7			-58.5	-41.25	17.2	
HT/VHT20 STBC, M0 to M7	3	6	-68.5	-66.7	-68.8		-57.1	-41.25	15.9	
HT/VHT20 STBC, M0 to M7	4	6	-68.5	-66.7	-68.8	-68.7	-56.1	-41.25	14.8	
5230	Non HT40, 6 to 54 Mbps	1	6	-68.6				-62.6	-41.25	21.4
	Non HT40, 6 to 54 Mbps	2	6	-68.6	-66.8			-58.6	-41.25	17.3
	Non HT40, 6 to 54 Mbps	3	6	-68.6	-66.8	-68.8		-57.2	-41.25	15.9
	Non HT40, 6 to 54 Mbps	4	6	-68.6	-66.8	-68.8	-68.7	-56.1	-41.25	14.9
	HT/VHT40, M0 to M7	1	6	-66.7				-60.7	-41.25	19.5
	HT/VHT40, M0 to M7	2	6	-66.7	-68.6			-58.5	-41.25	17.3
	HT/VHT40, M8 to M15	2	6	-66.7	-68.6			-58.5	-41.25	17.3
	HT/VHT40, M0 to M7	3	6	-66.7	-68.6	-68.6		-57.1	-41.25	15.8
	HT/VHT40, M8 to M15	3	6	-66.7	-68.6	-68.6		-57.1	-41.25	15.8
	HT/VHT40, M16 to M23	3	6	-66.7	-68.6	-68.6		-57.1	-41.25	15.8
	HT/VHT40, M0 to M7	4	6	-66.7	-68.6	-68.6	-68.7	-56.0	-41.25	14.8
	HT/VHT40, M8 to M15	4	6	-66.7	-68.6	-68.6	-68.7	-56.0	-41.25	14.8
	HT/VHT40, M16 to M23	4	6	-66.7	-68.6	-68.6	-68.7	-56.0	-41.25	14.8

HT/VHT40 Beam Forming, M0 to M7	2	9	-66.7	-68.6				-55.5	-41.25	14.3
HT/VHT40 Beam Forming, M8 to M15	2	6	-66.7	-68.6				-58.5	-41.25	17.3
HT/VHT40 Beam Forming, M0 to M7	3	11	-66.7	-68.6	-68.6			-52.3	-41.25	11.0
HT/VHT40 Beam Forming, M8 to M15	3	8	-66.7	-68.6	-68.6			-55.3	-41.25	14.0
HT/VHT40 Beam Forming, M16 to M23	3	6	-66.7	-68.6	-68.6			-57.1	-41.25	15.8
HT/VHT40 Beam Forming, M0 to M7	4	12	-66.7	-68.6	-68.6	-68.7		-50.0	-41.25	8.8
HT/VHT40 Beam Forming, M8 to M15	4	9	-66.7	-68.6	-68.6	-68.7		-53.0	-41.25	11.8
HT/VHT40 Beam Forming, M16 to M23	4	7	-66.7	-68.6	-68.6	-68.7		-54.8	-41.25	13.6
HT/VHT40 STBC, M0 to M7	2	6	-66.7	-68.6				-58.5	-41.25	17.3
HT/VHT40 STBC, M0 to M7	3	6	-66.7	-68.6	-68.6			-57.1	-41.25	15.8
HT/VHT40 STBC, M0 to M7	4	6	-66.7	-68.6	-68.6	-68.7		-56.0	-41.25	14.8

Non HT20, 6 to 54 Mbps	1	6	-68.5					-62.5	-41.25	21.3
Non HT20, 6 to 54 Mbps	2	6	-68.5	-68.8				-59.6	-41.25	18.4
Non HT20, 6 to 54 Mbps	3	6	-68.5	-68.8	-68.5			-57.8	-41.25	16.6
Non HT20, 6 to 54 Mbps	4	6	-68.5	-68.8	-68.5	-66.7		-56.0	-41.25	14.8
Non HT20 Beam Forming, 6 to 54 Mbps	2	9	-68.5	-68.8				-56.6	-41.25	15.4
Non HT20 Beam Forming, 6 to 54 Mbps	3	11	-68.5	-68.8	-68.5			-53.0	-41.25	11.8
Non HT20 Beam Forming, 6 to 54 Mbps	4	12	-68.5	-68.8	-68.5	-66.7		-50.0	-41.25	8.8
HT/VHT20, M0 to M7	1	6	-68.7					-62.7	-41.25	21.5
HT/VHT20, M0 to M7	2	6	-68.7	-68.7				-59.7	-41.25	18.4
HT/VHT20, M8 to M15	2	6	-68.7	-68.7				-59.7	-41.25	18.4
HT/VHT20, M0 to M7	3	6	-68.7	-68.7	-68.6			-57.9	-41.25	16.6
HT/VHT20, M8 to M15	3	6	-68.7	-68.7	-68.6			-57.9	-41.25	16.6
HT/VHT20, M16 to M23	3	6	-68.7	-68.7	-68.6			-57.9	-41.25	16.6
HT/VHT20, M0 to M7	4	6	-68.7	-68.7	-68.6	-68.6		-56.6	-41.25	15.4
HT/VHT20, M8 to M15	4	6	-68.7	-68.7	-68.6	-68.6		-56.6	-41.25	15.4
HT/VHT20, M16 to M23	4	6	-68.7	-68.7	-68.6	-68.6		-56.6	-41.25	15.4
HT/VHT20 Beam Forming, M0 to M7	2	9	-68.7	-68.7				-56.7	-41.25	15.4
HT/VHT20 Beam Forming, M8 to M15	2	6	-68.7	-68.7				-59.7	-41.25	18.4
HT/VHT20 Beam Forming, M0 to M7	3	11	-68.7	-68.7	-68.6			-53.1	-41.25	11.8
HT/VHT20 Beam Forming, M8 to M15	3	8	-68.7	-68.7	-68.6			-56.1	-41.25	14.8
HT/VHT20 Beam Forming, M16 to M23	3	6	-68.7	-68.7	-68.6			-57.9	-41.25	16.6
HT/VHT20 Beam Forming, M0 to M7	4	12	-68.7	-68.7	-68.6	-68.6		-50.6	-41.25	9.4
HT/VHT20 Beam Forming, M8 to M15	4	9	-68.7	-68.7	-68.6	-68.6		-53.6	-41.25	12.4
HT/VHT20 Beam Forming, M16 to M23	4	7	-68.7	-68.7	-68.6	-68.6		-55.4	-41.25	14.2
HT/VHT20 STBC, M0 to M7	2	6	-68.7	-68.7				-59.7	-41.25	18.4
HT/VHT20 STBC, M0 to M7	3	6	-68.7	-68.7	-68.6			-57.9	-41.25	16.6
HT/VHT20 STBC, M0 to M7	4	6	-68.7	-68.7	-68.6	-68.6		-56.6	-41.25	15.4

Frequency (MHz)	Mode	Tx Paths	Correlated Antenna Gain (dBi)	Tx 1 Spur Power (dBm)	Tx 2 Spur Power (dBm)	Tx 3 Spur Power (dBm)	Tx 4 Spur Power (dBm)	Total Conducted Spur (dBm)	Limit (dBm)	Margin (dB)
5180	Non HT20, 6 to 54 Mbps	1	6	-58.4				-52.4	-21.25	31.2
	Non HT20, 6 to 54 Mbps	2	6	-58.4	-59.5			-49.9	-21.25	28.7
	Non HT20, 6 to 54 Mbps	3	6	-58.4	-59.5	-59.8		-48.4	-21.25	27.2
	Non HT20, 6 to 54 Mbps	4	6	-58.4	-59.5	-59.8	-55.0	-45.7	-21.25	24.4
	Non HT20 Beam Forming, 6 to 54 Mbps	2	9	-58.4	-59.5			-46.9	-21.25	25.7
	Non HT20 Beam Forming, 6 to 54 Mbps	3	11	-58.4	-59.5	-59.8		-43.6	-21.25	22.4
	Non HT20 Beam Forming, 6 to 54 Mbps	4	12	-58.4	-59.5	-59.8	-55.0	-39.7	-21.25	18.4
	HT/VHT20, M0 to M7	1	6	-59.8				-53.8	-21.25	32.6
	HT/VHT20, M0 to M7	2	6	-59.8	-59.7			-50.7	-21.25	29.5
	HT/VHT20, M8 to M15	2	6	-59.8	-59.7			-50.7	-21.25	29.5
	HT/VHT20, M0 to M7	3	6	-59.8	-59.7	-58.5		-48.5	-21.25	27.3
	HT/VHT20, M8 to M15	3	6	-59.8	-59.7	-58.5		-48.5	-21.25	27.3
	HT/VHT20, M16 to M23	3	6	-59.8	-59.7	-58.5		-48.5	-21.25	27.3
	HT/VHT20, M0 to M7	4	6	-59.8	-59.7	-58.5	-60.6	-47.6	-21.25	26.3
	HT/VHT20, M8 to M15	4	6	-59.8	-59.7	-58.5	-60.6	-47.6	-21.25	26.3
	HT/VHT20, M16 to M23	4	6	-59.8	-59.7	-58.5	-60.6	-47.6	-21.25	26.3
	HT/VHT20 Beam Forming, M0 to M7	2	9	-59.8	-59.7			-47.7	-21.25	26.5
	HT/VHT20 Beam Forming, M8 to M15	2	6	-59.8	-59.7			-50.7	-21.25	29.5
	HT/VHT20 Beam Forming, M0 to M7	3	11	-59.8	-59.7	-58.5		-43.7	-21.25	22.5
	HT/VHT20 Beam Forming, M8 to M15	3	8	-59.8	-59.7	-58.5		-46.7	-21.25	25.5
	HT/VHT20 Beam Forming, M16 to M23	3	6	-59.8	-59.7	-58.5		-48.5	-21.25	27.3
	HT/VHT20 Beam Forming, M0 to M7	4	12	-59.8	-59.7	-58.5	-60.6	-41.6	-21.25	20.3
	HT/VHT20 Beam Forming, M8 to M15	4	9	-59.8	-59.7	-58.5	-60.6	-44.6	-21.25	23.3
	HT/VHT20 Beam Forming, M16 to M23	4	7	-59.8	-59.7	-58.5	-60.6	-46.4	-21.25	25.1
	HT/VHT20 STBC, M0 to M7	2	6	-59.8	-59.7			-50.7	-21.25	29.5
	HT/VHT20 STBC, M0 to M7	3	6	-59.8	-59.7	-58.5		-48.5	-21.25	27.3
HT/VHT20 STBC, M0 to M7	4	6	-59.8	-59.7	-58.5	-60.6	-47.6	-21.25	26.3	
5190	Non HT40, 6 to 54 Mbps	1	6	-61.4				-55.4	-21.25	34.2
	Non HT40, 6 to 54 Mbps	2	6	-61.4	-60.8			-52.1	-21.25	30.8
	Non HT40, 6 to 54 Mbps	3	6	-61.4	-60.8	-61.8		-50.5	-21.25	29.3
	Non HT40, 6 to 54 Mbps	4	6	-61.4	-60.8	-61.8	-59.6	-48.8	-21.25	27.5
	HT/VHT40, M0 to M7	1	6	-57.2				-51.2	-21.25	30.0
	HT/VHT40, M0 to M7	2	6	-57.2	-54.3			-46.5	-21.25	25.3
	HT/VHT40, M8 to M15	2	6	-57.2	-54.3			-46.5	-21.25	25.3

	HT/VHT40, M0 to M7	3	6	-57.2	-54.3	-54.6		-44.4	-21.25	23.2
	HT/VHT40, M8 to M15	3	6	-57.2	-54.3	-54.6		-44.4	-21.25	23.2
	HT/VHT40, M16 to M23	3	6	-57.2	-54.3	-54.6		-44.4	-21.25	23.2
	HT/VHT40, M0 to M7	4	6	-57.2	-54.3	-54.6	-61.1	-44.1	-21.25	22.8
	HT/VHT40, M8 to M15	4	6	-57.2	-54.3	-54.6	-61.1	-44.1	-21.25	22.8
	HT/VHT40, M16 to M23	4	6	-57.2	-54.3	-54.6	-61.1	-44.1	-21.25	22.8
	HT/VHT40 Beam Forming, M0 to M7	2	9	-57.2	-54.3			-43.5	-21.25	22.3
	HT/VHT40 Beam Forming, M8 to M15	2	6	-57.2	-54.3			-46.5	-21.25	25.3
	HT/VHT40 Beam Forming, M0 to M7	3	11	-57.2	-54.3	-54.6		-39.6	-21.25	18.4
	HT/VHT40 Beam Forming, M8 to M15	3	8	-57.2	-54.3	-54.6		-42.6	-21.25	21.4
	HT/VHT40 Beam Forming, M16 to M23	3	6	-57.2	-54.3	-54.6		-44.4	-21.25	23.2
	HT/VHT40 Beam Forming, M0 to M7	4	12	-57.2	-54.3	-54.6	-61.1	-38.1	-21.25	16.8
	HT/VHT40 Beam Forming, M8 to M15	4	9	-57.2	-54.3	-54.6	-61.1	-41.1	-21.25	19.8
	HT/VHT40 Beam Forming, M16 to M23	4	7	-57.2	-54.3	-54.6	-61.1	-42.9	-21.25	21.6
	HT/VHT40 STBC, M0 to M7	2	6	-57.2	-54.3			-46.5	-21.25	25.3
	HT/VHT40 STBC, M0 to M7	3	6	-57.2	-54.3	-54.6		-44.4	-21.25	23.2
	HT/VHT40 STBC, M0 to M7	4	6	-57.2	-54.3	-54.6	-61.1	-44.1	-21.25	22.8
5210	Non HT80, 6 to 54 Mbps	1	6	-59.3				-53.3	-21.25	32.1
	Non HT80, 6 to 54 Mbps	2	6	-59.3	-50.1			-43.6	-21.25	22.4
	Non HT80, 6 to 54 Mbps	3	6	-59.3	-50.1	-51.1		-41.3	-21.25	20.0
	Non HT80, 6 to 54 Mbps	4	6	-59.3	-50.1	-51.1	-60.1	-41.1	-21.25	19.8
	VHT80, M0.1 to M9.1	1	6	-55.8				-49.8	-21.25	28.6
	VHT80, M0.1 to M9.1	2	6	-55.8	-54.3			-46.0	-21.25	24.7
	VHT80, M0.2 to M9.2	2	6	-55.8	-54.3			-46.0	-21.25	24.7
	VHT80, M0.1 to M9.1	3	6	-55.8	-54.3	-59.0		-45.2	-21.25	23.9
	VHT80, M0.2 to M9.2	3	6	-55.8	-54.3	-59.0		-45.2	-21.25	23.9
	VHT80, M0.3 to M9.3	3	6	-55.8	-54.3	-59.0		-45.2	-21.25	23.9
	VHT80, M0.1 to M9.1	4	6	-55.8	-54.3	-59.0	-55.2	-43.7	-21.25	22.5
	VHT80, M0.2 to M9.2	4	6	-55.8	-54.3	-59.0	-55.2	-43.7	-21.25	22.5
	VHT80, M0.3 to M9.3	4	6	-55.8	-54.3	-59.0	-55.2	-43.7	-21.25	22.5
	VHT80 Beam Forming, M0.1 to M9.1	2	6	-55.8	-54.3			-46.0	-21.25	24.7
	VHT80 Beam Forming, M0.2 to M9.2	2	6	-55.8	-54.3			-46.0	-21.25	24.7
	VHT80 Beam Forming, M0.1 to M9.1	3	6	-55.8	-54.3	-59.0		-45.2	-21.25	23.9
	VHT80 Beam Forming, M0.2 to M9.2	3	6	-55.8	-54.3	-59.0		-45.2	-21.25	23.9
	VHT80 Beam Forming, M0.3 to M9.3	3	6	-55.8	-54.3	-59.0		-45.2	-21.25	23.9
	VHT80 Beam Forming, M0.1 to M9.1	4	6	-55.8	-54.3	-59.0	-55.2	-43.7	-21.25	22.5
	VHT80 Beam Forming, M0.2 to M9.2	4	6	-55.8	-54.3	-59.0	-55.2	-43.7	-21.25	22.5
	VHT80 Beam Forming, M0.3 to M9.3	4	6	-55.8	-54.3	-59.0	-55.2	-43.7	-21.25	22.5
	VHT80 STBC, M0.1 to M9.1	2	6	-55.8	-54.3			-46.0	-21.25	24.7
	VHT80 STBC, M0.1 to M9.1	3	6	-55.8	-54.3	-59.0		-45.2	-21.25	23.9
VHT80 STBC, M0.1 to M9.1	4	6	-55.8	-54.3	-59.0	-55.2	-43.7	-21.25	22.5	

5220	Non HT20, 6 to 54 Mbps	1	6	-55.4				-49.4	-21.25	28.2
	Non HT20, 6 to 54 Mbps	2	6	-55.4	-53.7			-45.5	-21.25	24.2
	Non HT20, 6 to 54 Mbps	3	6	-55.4	-53.7	-54.0		-43.5	-21.25	22.3
	Non HT20, 6 to 54 Mbps	4	6	-55.4	-53.7	-54.0	-52.5	-41.8	-21.25	20.5
	Non HT20 Beam Forming, 6 to 54 Mbps	2	9	-55.4	-53.7			-42.5	-21.25	21.2
	Non HT20 Beam Forming, 6 to 54 Mbps	3	11	-55.4	-53.7	-54.0		-38.7	-21.25	17.5
	Non HT20 Beam Forming, 6 to 54 Mbps	4	12	-55.4	-53.7	-54.0	-52.5	-35.8	-21.25	14.5
	HT/VHT20, M0 to M7	1	6	-59.9				-53.9	-21.25	32.7
	HT/VHT20, M0 to M7	2	6	-59.9	-54.2			-47.2	-21.25	25.9
	HT/VHT20, M8 to M15	2	6	-59.9	-54.2			-47.2	-21.25	25.9
	HT/VHT20, M0 to M7	3	6	-59.9	-54.2	-54.9		-44.9	-21.25	23.7
	HT/VHT20, M8 to M15	3	6	-59.9	-54.2	-54.9		-44.9	-21.25	23.7
	HT/VHT20, M16 to M23	3	6	-59.9	-54.2	-54.9		-44.9	-21.25	23.7
	HT/VHT20, M0 to M7	4	6	-59.9	-54.2	-54.9	-54.4	-43.3	-21.25	22.1
	HT/VHT20, M8 to M15	4	6	-59.9	-54.2	-54.9	-54.4	-43.3	-21.25	22.1
	HT/VHT20, M16 to M23	4	6	-59.9	-54.2	-54.9	-54.4	-43.3	-21.25	22.1
	HT/VHT20 Beam Forming, M0 to M7	2	9	-59.9	-54.2			-44.2	-21.25	22.9
	HT/VHT20 Beam Forming, M8 to M15	2	6	-59.9	-54.2			-47.2	-21.25	25.9
	HT/VHT20 Beam Forming, M0 to M7	3	11	-59.9	-54.2	-54.9		-40.1	-21.25	18.9
	HT/VHT20 Beam Forming, M8 to M15	3	8	-59.9	-54.2	-54.9		-43.1	-21.25	21.9
	HT/VHT20 Beam Forming, M16 to M23	3	6	-59.9	-54.2	-54.9		-44.9	-21.25	23.7
	HT/VHT20 Beam Forming, M0 to M7	4	12	-59.9	-54.2	-54.9	-54.4	-37.3	-21.25	16.1
	HT/VHT20 Beam Forming, M8 to M15	4	9	-59.9	-54.2	-54.9	-54.4	-40.3	-21.25	19.1
HT/VHT20 Beam Forming, M16 to M23	4	7	-59.9	-54.2	-54.9	-54.4	-42.1	-21.25	20.9	
HT/VHT20 STBC, M0 to M7	2	6	-59.9	-54.2			-47.2	-21.25	25.9	
HT/VHT20 STBC, M0 to M7	3	6	-59.9	-54.2	-54.9		-44.9	-21.25	23.7	
HT/VHT20 STBC, M0 to M7	4	6	-59.9	-54.2	-54.9	-54.4	-43.3	-21.25	22.1	
5230	Non HT40, 6 to 54 Mbps	1	6	-60.1				-54.1	-21.25	32.9
	Non HT40, 6 to 54 Mbps	2	6	-60.1	-54.5			-47.4	-21.25	26.2
	Non HT40, 6 to 54 Mbps	3	6	-60.1	-54.5	-54.4		-44.9	-21.25	23.6
	Non HT40, 6 to 54 Mbps	4	6	-60.1	-54.5	-54.4	-53.9	-43.1	-21.25	21.9
	HT/VHT40, M0 to M7	1	6	-56.0				-50.0	-21.25	28.8
	HT/VHT40, M0 to M7	2	6	-56.0	-61.0			-48.8	-21.25	27.6
	HT/VHT40, M8 to M15	2	6	-56.0	-61.0			-48.8	-21.25	27.6
	HT/VHT40, M0 to M7	3	6	-56.0	-61.0	-53.7		-45.2	-21.25	24.0
	HT/VHT40, M8 to M15	3	6	-56.0	-61.0	-53.7		-45.2	-21.25	24.0
	HT/VHT40, M16 to M23	3	6	-56.0	-61.0	-53.7		-45.2	-21.25	24.0
	HT/VHT40, M0 to M7	4	6	-56.0	-61.0	-53.7	-61.2	-44.8	-21.25	23.5
	HT/VHT40, M8 to M15	4	6	-56.0	-61.0	-53.7	-61.2	-44.8	-21.25	23.5
	HT/VHT40, M16 to M23	4	6	-56.0	-61.0	-53.7	-61.2	-44.8	-21.25	23.5

HT/VHT40 Beam Forming, M0 to M7	2	9	-56.0	-61.0				-45.8	-21.25	24.6
HT/VHT40 Beam Forming, M8 to M15	2	6	-56.0	-61.0				-48.8	-21.25	27.6
HT/VHT40 Beam Forming, M0 to M7	3	11	-56.0	-61.0	-53.7			-40.4	-21.25	19.2
HT/VHT40 Beam Forming, M8 to M15	3	8	-56.0	-61.0	-53.7			-43.4	-21.25	22.2
HT/VHT40 Beam Forming, M16 to M23	3	6	-56.0	-61.0	-53.7			-45.2	-21.25	24.0
HT/VHT40 Beam Forming, M0 to M7	4	12	-56.0	-61.0	-53.7	-61.2		-38.8	-21.25	17.5
HT/VHT40 Beam Forming, M8 to M15	4	9	-56.0	-61.0	-53.7	-61.2		-41.8	-21.25	20.5
HT/VHT40 Beam Forming, M16 to M23	4	7	-56.0	-61.0	-53.7	-61.2		-43.6	-21.25	22.3
HT/VHT40 STBC, M0 to M7	2	6	-56.0	-61.0				-48.8	-21.25	27.6
HT/VHT40 STBC, M0 to M7	3	6	-56.0	-61.0	-53.7			-45.2	-21.25	24.0
HT/VHT40 STBC, M0 to M7	4	6	-56.0	-61.0	-53.7	-61.2		-44.8	-21.25	23.5

Non HT20, 6 to 54 Mbps	1	6	-59.5					-53.5	-21.25	32.3
Non HT20, 6 to 54 Mbps	2	6	-59.5	-58.3				-49.8	-21.25	28.6
Non HT20, 6 to 54 Mbps	3	6	-59.5	-58.3	-55.0			-46.4	-21.25	25.1
Non HT20, 6 to 54 Mbps	4	6	-59.5	-58.3	-55.0	-53.4		-43.9	-21.25	22.6
Non HT20 Beam Forming, 6 to 54 Mbps	2	9	-59.5	-58.3				-46.8	-21.25	25.6
Non HT20 Beam Forming, 6 to 54 Mbps	3	11	-59.5	-58.3	-55.0			-41.6	-21.25	20.3
Non HT20 Beam Forming, 6 to 54 Mbps	4	12	-59.5	-58.3	-55.0	-53.4		-37.9	-21.25	16.6
HT/VHT20, M0 to M7	1	6	-59.9					-53.9	-21.25	32.7
HT/VHT20, M0 to M7	2	6	-59.9	-53.9				-46.9	-21.25	25.7
HT/VHT20, M8 to M15	2	6	-59.9	-53.9				-46.9	-21.25	25.7
HT/VHT20, M0 to M7	3	6	-59.9	-53.9	-61.1			-46.3	-21.25	25.1
HT/VHT20, M8 to M15	3	6	-59.9	-53.9	-61.1			-46.3	-21.25	25.1
HT/VHT20, M16 to M23	3	6	-59.9	-53.9	-61.1			-46.3	-21.25	25.1
HT/VHT20, M0 to M7	4	6	-59.9	-53.9	-61.1	-53.5		-43.9	-21.25	22.6
HT/VHT20, M8 to M15	4	6	-59.9	-53.9	-61.1	-53.5		-43.9	-21.25	22.6
HT/VHT20, M16 to M23	4	6	-59.9	-53.9	-61.1	-53.5		-43.9	-21.25	22.6
HT/VHT20 Beam Forming, M0 to M7	2	9	-59.9	-53.9				-43.9	-21.25	22.7
HT/VHT20 Beam Forming, M8 to M15	2	6	-59.9	-53.9				-46.9	-21.25	25.7
HT/VHT20 Beam Forming, M0 to M7	3	11	-59.9	-53.9	-61.1			-41.5	-21.25	20.3
HT/VHT20 Beam Forming, M8 to M15	3	8	-59.9	-53.9	-61.1			-44.5	-21.25	23.3
HT/VHT20 Beam Forming, M16 to M23	3	6	-59.9	-53.9	-61.1			-46.3	-21.25	25.1
HT/VHT20 Beam Forming, M0 to M7	4	12	-59.9	-53.9	-61.1	-53.5		-37.9	-21.25	16.6
HT/VHT20 Beam Forming, M8 to M15	4	9	-59.9	-53.9	-61.1	-53.5		-40.9	-21.25	19.6
HT/VHT20 Beam Forming, M16 to M23	4	7	-59.9	-53.9	-61.1	-53.5		-42.7	-21.25	21.4
HT/VHT20 STBC, M0 to M7	2	6	-59.9	-53.9				-46.9	-21.25	25.7
HT/VHT20 STBC, M0 to M7	3	6	-59.9	-53.9	-61.1			-46.3	-21.25	25.1
HT/VHT20 STBC, M0 to M7	4	6	-59.9	-53.9	-61.1	-53.5		-43.9	-21.25	22.6

Conducted Spurs Average, All Antennas



Conducted Spurs Peak, All Antennas





Conducted Spurs Average, 5180 MHz, Non HT20 Beam Forming, 6 to 54 Mbps



Antenna A



Antenna B

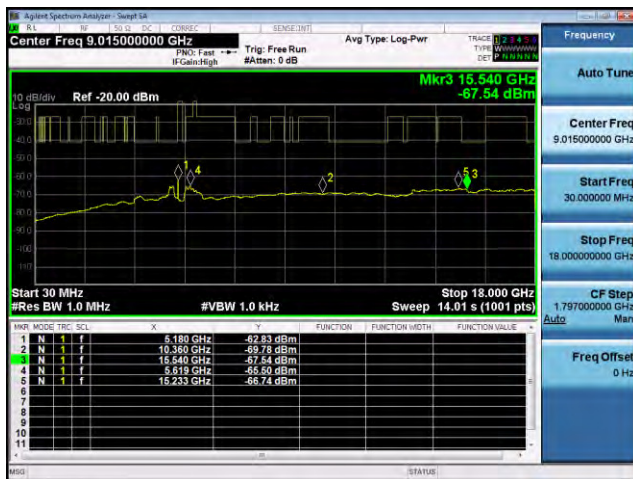

Antenna C



Antenna D

Conducted Spurs Peak, 5220 MHz, Non HT20 Beam Forming, 6 to 54 Mbps

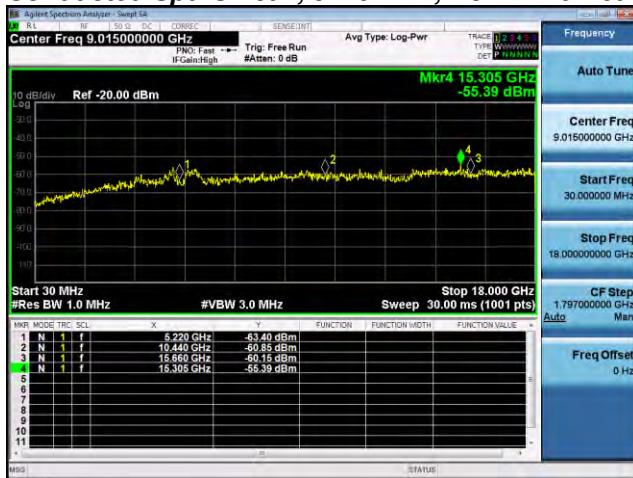

Antenna A

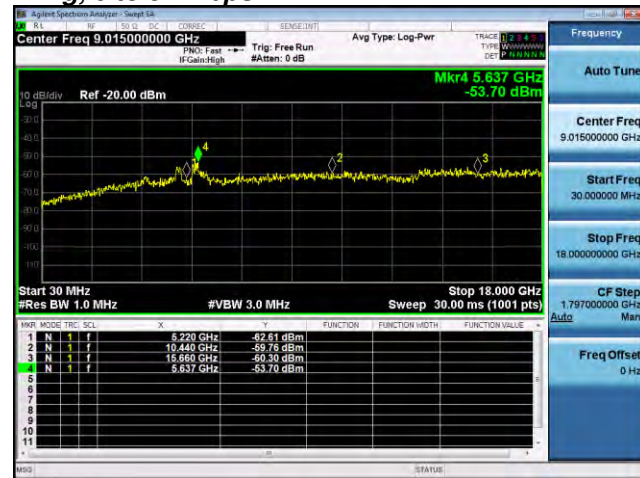

Antenna B

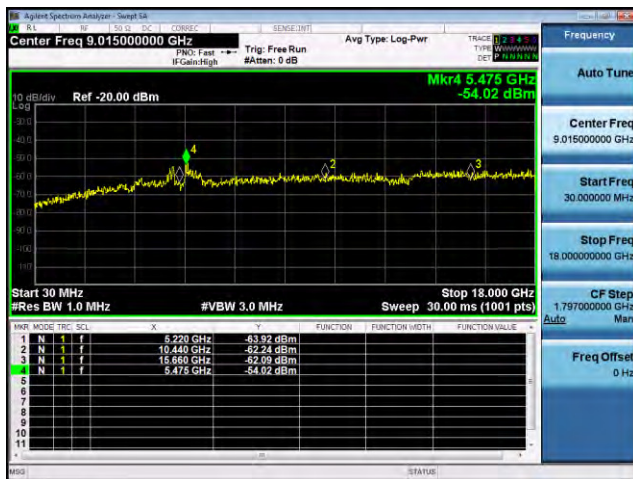

Antenna C

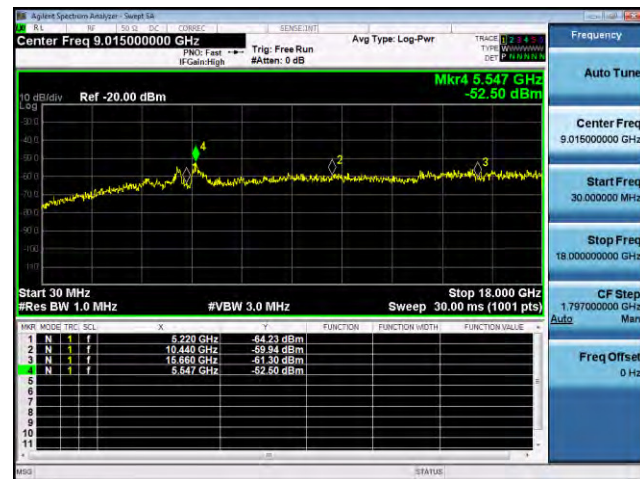

Antenna D

A.4 Conducted Band Edge

15.407 (b) Undesirable emission limits. Except as shown in paragraph (b)(7) of this section, the maximum emissions outside of the frequency bands of operation shall be attenuated in accordance with the following limits:

(1) For transmitters operating in the 5.15-5.25 GHz band: All emissions outside of the 5.15-5.35 GHz band shall not exceed an e.i.r.p. of -27 dBm/MHz.

Radiated emissions which fall in the restricted bands, as defined in Section 15.205(a), must also comply with the radiated emission limits specified in Section 15.209(a) (see Section 15.205(c)).

As specified in § 15.407(b), emissions above 1000 MHz that are outside of the restricted bands are subject to a maximum emission limit of -27 dBm/MHz (or -17 dBm/MHz as specified in § 15.407(b)(4)). **However, an out-of-band emission that complies with both the peak and average limits of § 15.209 is not required to satisfy the -27 dBm/MHz maximum emission limit.**

Use formula below to substitute conducted measurements in place of radiated measurements

$$E[\text{dB}\mu\text{V/m}] = \text{EIRP}[\text{dBm}] - 20 \log(d[\text{meters}]) + 104.77, \text{ where } E = \text{field strength and } d = 3 \text{ meter}$$

- 1) Average Plot, Limit= -41.25 dBm eirp
- 2) Peak plot, Limit = -21.25 dBm eirp

Test Procedure

Ref. ANSI C63.10: 2013

Conducted Bandedge

Test Procedure

1. Connect the antenna port(s) to the spectrum analyzer input.
2. Place the radio in continuous transmit mode. Use the procedures in ANSI C63.10: 2013 to substitute conducted measurements in place of radiated measurements.
3. Configure Spectrum analyzer as per test parameters below (be sure to enter all losses between the transmitter output and the spectrum analyzer).
4. Place a marker at the end of the restricted band closest to the transmit frequency to show compliance. Also measure any emissions in the restricted bands.
5. The "measure-and-sum technique" is used for measuring in-band transmit power of a device. In the measure-and-sum approach, the conducted emission level is measured at each antenna port. The measured results at the various antenna ports are then summed mathematically to determine the total emission level from the device. Summing is performed in linear power units. The worst case output is recorded.
6. Place a marker at the end of the restricted band closest to the transmit frequency to show compliance. Also measure any emissions in the restricted bands
7. Capture graphs and record pertinent measurement data.

Ref. ANSI C63.10: 2013 section 12.7.6 (peak) & 12.7.7.3 (average, Method VB-A (Alternative))

Conducted Bandedge

Test parameters restricted Band

RBW = 1 MHz
 VBW ≥ 3 x RBW for Peak, 100Hz for Average
 Sweep = Auto couple
 Detector = Peak
 Trace = Max Hold.

System Number	Description	Samples	System under test	Support equipment
1	EUT	S01	<input checked="" type="checkbox"/>	<input type="checkbox"/>
	Support	S02	<input type="checkbox"/>	<input checked="" type="checkbox"/>

Tested By :

Jose Aguirre

Date of testing:

01-Jan-16 - 22-Feb-16

Test Result : PASS

See Appendix C for list of test equipment

Frequency (MHz)	Mode	Tx Paths	Correlated Antenna Gain (dBi)	Tx 1 Bandedge Level (dBm)	Tx 2 Bandedge Level (dBm)	Tx 3 Bandedge Level (dBm)	Tx 4 Bandedge Level (dBm)	Total Tx Bandedge Level (dBm)	Limit (dBm)	Margin (dB)
5180	Non HT20, 6 to 54 Mbps	1	6	-55.9				-49.9	-41.25	8.7
	Non HT20, 6 to 54 Mbps	2	6	-55.9	-56.6			-47.2	-41.25	6.0
	Non HT20, 6 to 54 Mbps	3	6	-55.9	-56.6	-57.1		-45.7	-41.25	4.5
	Non HT20, 6 to 54 Mbps	4	6	-55.9	-56.6	-57.1	-56.8	-44.6	-41.25	3.3
	Non HT20 Beam Forming, 6 to 54 Mbps	2	9	-55.9	-56.6			-44.2	-41.25	3.0
	Non HT20 Beam Forming, 6 to 54 Mbps	3	11	-57.5	-58.2	-57.5		-42.1	-41.25	0.9
	Non HT20 Beam Forming, 6 to 54 Mbps	4	12	-59.0	-60.6	-60.1	-59.1	-41.6	-41.25	0.4
	HT/VHT20, M0 to M7	1	6	-55.5				-49.5	-41.25	8.3
	HT/VHT20, M0 to M7	2	6	-55.5	-56.4			-46.9	-41.25	5.7
	HT/VHT20, M8 to M15	2	6	-55.5	-56.4			-46.9	-41.25	5.7
	HT/VHT20, M0 to M7	3	6	-55.5	-56.4	-57.2		-45.5	-41.25	4.3
	HT/VHT20, M8 to M15	3	6	-55.5	-56.4	-57.2		-45.5	-41.25	4.3
	HT/VHT20, M16 to M23	3	6	-55.5	-56.4	-57.2		-45.5	-41.25	4.3
	HT/VHT20, M0 to M7	4	6	-55.5	-56.4	-57.2	-56.5	-44.3	-41.25	3.1
	HT/VHT20, M8 to M15	4	6	-55.5	-56.4	-57.2	-56.5	-44.3	-41.25	3.1
	HT/VHT20, M16 to M23	4	6	-55.5	-56.4	-57.2	-56.5	-44.3	-41.25	3.1
	HT/VHT20 Beam Forming, M0 to M7	2	9	-55.5	-56.4			-43.9	-41.25	2.7
	HT/VHT20 Beam Forming, M8 to M15	2	6	-55.5	-56.4			-46.9	-41.25	5.7
	HT/VHT20 Beam Forming, M0 to M7	3	11	-57.0	-57.8	-57.5		-41.8	-41.25	0.6
	HT/VHT20 Beam Forming, M8 to M15	3	8	-55.5	-56.4	-57.2		-43.7	-41.25	2.5
	HT/VHT20 Beam Forming, M16 to M23	3	6	-55.5	-56.4	-57.2		-45.5	-41.25	4.3
	HT/VHT20 Beam Forming, M0 to M7	4	12	-59.1	-60.5	-60.1	-59.0	-41.6	-41.25	0.4
	HT/VHT20 Beam Forming, M8 to M15	4	9	-55.5	-56.4	-57.2	-56.5	-41.3	-41.25	0.1
	HT/VHT20 Beam Forming, M16 to M23	4	7	-55.5	-56.4	-57.2	-56.5	-43.1	-41.25	1.9
	HT/VHT20 STBC, M0 to M7	2	6	-55.5	-56.4			-46.9	-41.25	5.7
	HT/VHT20 STBC, M0 to M7	3	6	-55.5	-56.4	-57.2		-45.5	-41.25	4.3
	HT/VHT20 STBC, M0 to M7	4	6	-55.5	-56.4	-57.2	-56.5	-44.3	-41.25	3.1
	5190	Non HT40, 6 to 54 Mbps	1	6	-49.9				-43.9	-41.25
Non HT40, 6 to 54 Mbps		2	6	-49.9	-51.2			-41.5	-41.25	0.2
Non HT40, 6 to 54 Mbps		3	6	-52.3	-54.2	-56.7		-43.3	-41.25	2.0
Non HT40, 6 to 54 Mbps		4	6	-54.3	-55.6	-57.0	-56.5	-43.7	-41.25	2.5
HT/VHT40, M0 to M7		1	6	-47.3				-41.3	-41.25	0.0
HT/VHT40, M0 to M7		2	6	-51.4	-53.1			-43.2	-41.25	1.9

	HT/VHT40, M8 to M15	2	6	-51.4	-53.1			-43.2	-41.25	1.9
	HT/VHT40, M0 to M7	3	6	-51.4	-53.1	-55.0		-42.2	-41.25	0.9
	HT/VHT40, M8 to M15	3	6	-51.4	-53.1	-55.0		-42.2	-41.25	0.9
	HT/VHT40, M16 to M23	3	6	-51.4	-53.1	-55.0		-42.2	-41.25	0.9
	HT/VHT40, M0 to M7	4	6	-51.4	-53.1	-55.0	-56.0	-41.5	-41.25	0.2
	HT/VHT40, M8 to M15	4	6	-51.4	-53.1	-55.0	-56.0	-41.5	-41.25	0.2
	HT/VHT40, M16 to M23	4	6	-51.4	-53.1	-55.0	-56.0	-41.5	-41.25	0.2
	HT/VHT40 Beam Forming, M0 to M7	2	9	-53.1	-55.0			-41.9	-41.25	0.7
	HT/VHT40 Beam Forming, M8 to M15	2	6	-51.4	-53.1			-43.2	-41.25	1.9
	HT/VHT40 Beam Forming, M0 to M7	3	11	-56.7	-58.1	-59.3		-42.3	-41.25	1.1
	HT/VHT40 Beam Forming, M8 to M15	3	8	-53.1	-55.0	-56.6		-42.1	-41.25	0.8
	HT/VHT40 Beam Forming, M16 to M23	3	6	-51.4	-53.1	-55.0		-42.2	-41.25	0.9
	HT/VHT40 Beam Forming, M0 to M7	4	12	-58.1	-59.0	-60.2	-60.2	-41.3	-41.25	0.0
	HT/VHT40 Beam Forming, M8 to M15	4	9	-55.2	-56.8	-58.1	-57.7	-41.8	-41.25	0.5
	HT/VHT40 Beam Forming, M16 to M23	4	7	-53.1	-55.0	-56.6	-56.9	-41.9	-41.25	0.7
	HT/VHT40 STBC, M0 to M7	2	6	-51.4	-53.1			-43.2	-41.25	1.9
	HT/VHT40 STBC, M0 to M7	3	6	-51.4	-53.1	-55.0		-42.2	-41.25	0.9
	HT/VHT40 STBC, M0 to M7	4	6	-51.4	-53.1	-55.0	-56.0	-41.5	-41.25	0.2
5210	Non HT80, 6 to 54 Mbps	1	6	-47.3				-41.3	-41.25	0.0
	Non HT80, 6 to 54 Mbps	2	6	-49.1	-52.3			-41.4	-41.25	0.2
	Non HT80, 6 to 54 Mbps	3	6	-50.7	-53.1	-54.4		-41.7	-41.25	0.4
	Non HT80, 6 to 54 Mbps	4	6	-52.0	-53.8	-55.5	-55.6	-41.9	-41.25	0.7
	VHT80, M0.1 to M9.1	1	6	-48.8				-42.8	-41.25	1.6
	VHT80, M0.1 to M9.1	2	6	-50.3	-51.6			-41.9	-41.25	0.6
	VHT80, M0.2 to M9.2	2	6	-50.3	-51.6			-41.9	-41.25	0.6
	VHT80, M0.1 to M9.1	3	6	-51.6	-53.1	-55.7		-42.4	-41.25	1.1
	VHT80, M0.2 to M9.2	3	6	-51.6	-53.1	-55.7		-42.4	-41.25	1.1
	VHT80, M0.3 to M9.3	3	6	-51.6	-53.1	-55.7		-42.4	-41.25	1.1
	VHT80, M0.1 to M9.1	4	6	-51.6	-53.1	-55.7	-55.6	-41.6	-41.25	0.4
	VHT80, M0.2 to M9.2	4	6	-51.6	-53.1	-55.7	-55.6	-41.6	-41.25	0.4
	VHT80, M0.3 to M9.3	4	6	-51.6	-53.1	-55.7	-55.6	-41.6	-41.25	0.4
	VHT80 Beam Forming, M0.1 to M9.1	2	6	-50.3	-51.6			-41.9	-41.25	0.6
	VHT80 Beam Forming, M0.2 to M9.2	2	6	-50.3	-51.6			-41.9	-41.25	0.6
	VHT80 Beam Forming, M0.1 to M9.1	3	6	-51.6	-53.1	-55.7		-42.4	-41.25	1.1
	VHT80 Beam Forming, M0.2 to M9.2	3	6	-51.6	-53.1	-55.7		-42.4	-41.25	1.1
	VHT80 Beam Forming, M0.3 to M9.3	3	6	-51.6	-53.1	-55.7		-42.4	-41.25	1.1
	VHT80 Beam Forming, M0.1 to M9.1	4	6	-51.6	-53.1	-55.7	-55.6	-41.6	-41.25	0.4
	VHT80 Beam Forming, M0.2 to M9.2	4	6	-51.6	-53.1	-55.7	-55.6	-41.6	-41.25	0.4
VHT80 Beam Forming, M0.3 to M9.3	4	6	-51.6	-53.1	-55.7	-55.6	-41.6	-41.25	0.4	
VHT80 STBC, M0.1 to M9.1	2	6	-50.3	-51.6			-41.9	-41.25	0.6	
VHT80 STBC, M0.1 to M9.1	3	6	-51.6	-53.1	-55.7		-42.4	-41.25	1.1	



VHT80 STBC, M0.1 to M9.1	4	6	-51.6	-53.1	-55.7	-55.6	-41.6	-41.25	0.4
--------------------------	---	---	-------	-------	-------	-------	-------	--------	-----

Frequency (MHz)	Mode	Tx Paths	Correlated Antenna Gain (dBi)	Tx 1 Bandedge Level (dBm)	Tx 2 Bandedge Level (dBm)	Tx 3 Bandedge Level (dBm)	Tx 4 Bandedge Level (dBm)	Total Tx Bandedge Level (dBm)	Limit (dBm)	Margin (dB)
5180	Non HT20, 6 to 54 Mbps	1	6	-40.2				-34.2	-21.25	13.0
	Non HT20, 6 to 54 Mbps	2	6	-40.2	-45.0			-33.0	-21.25	11.7
	Non HT20, 6 to 54 Mbps	3	6	-40.2	-45.0	-45.4		-32.1	-21.25	10.8
	Non HT20, 6 to 54 Mbps	4	6	-40.2	-45.0	-45.4	-45.4	-31.3	-21.25	10.1
	Non HT20 Beam Forming, 6 to 54 Mbps	2	9	-40.2	-45.0			-30.0	-21.25	8.7
	Non HT20 Beam Forming, 6 to 54 Mbps	3	11	-46.0	-47.0	-42.9		-29.4	-21.25	8.1
	Non HT20 Beam Forming, 6 to 54 Mbps	4	12	-46.7	-47.2	-47.4	-39.9	-25.9	-21.25	4.7
	HT/VHT20, M0 to M7	1	6	-42.0				-36.0	-21.25	14.8
	HT/VHT20, M0 to M7	2	6	-42.0	-41.0			-32.5	-21.25	11.2
	HT/VHT20, M8 to M15	2	6	-42.0	-41.0			-32.5	-21.25	11.2
	HT/VHT20, M0 to M7	3	6	-42.0	-41.0	-45.1		-31.6	-21.25	10.4
	HT/VHT20, M8 to M15	3	6	-42.0	-41.0	-45.1		-31.6	-21.25	10.4
	HT/VHT20, M16 to M23	3	6	-42.0	-41.0	-45.1		-31.6	-21.25	10.4
	HT/VHT20, M0 to M7	4	6	-42.0	-41.0	-45.1	-43.6	-30.6	-21.25	9.4
	HT/VHT20, M8 to M15	4	6	-42.0	-41.0	-45.1	-43.6	-30.6	-21.25	9.4
	HT/VHT20, M16 to M23	4	6	-42.0	-41.0	-45.1	-43.6	-30.6	-21.25	9.4
	HT/VHT20 Beam Forming, M0 to M7	2	9	-42.0	-41.0			-29.5	-21.25	8.2
	HT/VHT20 Beam Forming, M8 to M15	2	6	-42.0	-41.0			-32.5	-21.25	11.2
	HT/VHT20 Beam Forming, M0 to M7	3	11	-45.9	-36.4	-45.9		-24.7	-21.25	3.5
	HT/VHT20 Beam Forming, M8 to M15	3	8	-42.0	-41.0	-45.1		-29.8	-21.25	8.6
	HT/VHT20 Beam Forming, M16 to M23	3	6	-42.0	-41.0	-45.1		-31.6	-21.25	10.4
	HT/VHT20 Beam Forming, M0 to M7	4	12	-43.2	-46.8	-50.2	-42.3	-26.6	-21.25	5.4
	HT/VHT20 Beam Forming, M8 to M15	4	9	-42.0	-41.0	-45.1	-43.6	-27.6	-21.25	6.4
	HT/VHT20 Beam Forming, M16 to M23	4	7	-42.0	-41.0	-45.1	-43.6	-29.4	-21.25	8.2
	HT/VHT20 STBC, M0 to M7	2	6	-42.0	-41.0			-32.5	-21.25	11.2
	HT/VHT20 STBC, M0 to M7	3	6	-42.0	-41.0	-45.1		-31.6	-21.25	10.4
	HT/VHT20 STBC, M0 to M7	4	6	-42.0	-41.0	-45.1	-43.6	-30.6	-21.25	9.4
	5190	Non HT40, 6 to 54 Mbps	1	6	-32.2				-26.2	-21.25
Non HT40, 6 to 54 Mbps		2	6	-32.2	-33.8			-23.9	-21.25	2.7
Non HT40, 6 to 54 Mbps		3	6	-35.4	-33.6	-36.7		-24.3	-21.25	3.0
Non HT40, 6 to 54 Mbps		4	6	-34.9	-41.3	-41.4	-36.6	-25.6	-21.25	4.4
HT/VHT40, M0 to M7		1	6	-36.6				-30.6	-21.25	9.4
HT/VHT40, M0 to M7		2	6	-39.8	-43.8			-32.3	-21.25	11.1
HT/VHT40, M8 to M15		2	6	-39.8	-43.8			-32.3	-21.25	11.1

	HT/VHT40, M0 to M7	3	6	-39.8	-43.8	-45.7		-31.6	-21.25	10.4
	HT/VHT40, M8 to M15	3	6	-39.8	-43.8	-45.7		-31.6	-21.25	10.4
	HT/VHT40, M16 to M23	3	6	-39.8	-43.8	-45.7		-31.6	-21.25	10.4
	HT/VHT40, M0 to M7	4	6	-39.8	-43.8	-45.7	-42.4	-30.4	-21.25	9.1
	HT/VHT40, M8 to M15	4	6	-39.8	-43.8	-45.7	-42.4	-30.4	-21.25	9.1
	HT/VHT40, M16 to M23	4	6	-39.8	-43.8	-45.7	-42.4	-30.4	-21.25	9.1
	HT/VHT40 Beam Forming, M0 to M7	2	9	-42.8	-45.6			-32.0	-21.25	10.7
	HT/VHT40 Beam Forming, M8 to M15	2	6	-39.8	-43.8			-32.3	-21.25	11.1
	HT/VHT40 Beam Forming, M0 to M7	3	11	-43.2	-49.0	-49.7		-30.7	-21.25	9.4
	HT/VHT40 Beam Forming, M8 to M15	3	8	-42.8	-45.6	-44.8		-31.7	-21.25	10.4
	HT/VHT40 Beam Forming, M16 to M23	3	6	-39.8	-43.8	-45.7		-31.6	-21.25	10.4
	HT/VHT40 Beam Forming, M0 to M7	4	12	-49.6	-44.8	-41.0	-44.5	-26.0	-21.25	4.7
	HT/VHT40 Beam Forming, M8 to M15	4	9	-39.8	-44.7	-49.5	-48.0	-28.8	-21.25	7.6
	HT/VHT40 Beam Forming, M16 to M23	4	7	-42.8	-45.6	-44.8	-45.6	-31.3	-21.25	10.1
	HT/VHT40 STBC, M0 to M7	2	6	-39.8	-43.8			-32.3	-21.25	11.1
	HT/VHT40 STBC, M0 to M7	3	6	-39.8	-43.8	-45.7		-31.6	-21.25	10.4
	HT/VHT40 STBC, M0 to M7	4	6	-39.8	-43.8	-45.7	-42.4	-30.4	-21.25	9.1
5210	Non HT80, 6 to 54 Mbps	1	6	-35.2				-29.2	-21.25	8.0
	Non HT80, 6 to 54 Mbps	2	6	-37.6	-43.2			-30.5	-21.25	9.3
	Non HT80, 6 to 54 Mbps	3	6	-40.7	-47.1	-44.0		-32.4	-21.25	11.2
	Non HT80, 6 to 54 Mbps	4	6	-41.8	-44.9	-43.0	-45.2	-31.5	-21.25	10.2
	VHT80, M0.1 to M9.1	1	6	-41.0				-35.0	-21.25	13.8
	VHT80, M0.1 to M9.1	2	6	-40.5	-39.7			-31.1	-21.25	9.8
	VHT80, M0.2 to M9.2	2	6	-40.5	-39.7			-31.1	-21.25	9.8
	VHT80, M0.1 to M9.1	3	6	-42.4	-43.4	-41.7		-31.7	-21.25	10.4
	VHT80, M0.2 to M9.2	3	6	-42.4	-43.4	-41.7		-31.7	-21.25	10.4
	VHT80, M0.3 to M9.3	3	6	-42.4	-43.4	-41.7		-31.7	-21.25	10.4
	VHT80, M0.1 to M9.1	4	6	-42.4	-43.4	-41.7	-42.3	-30.4	-21.25	9.1
	VHT80, M0.2 to M9.2	4	6	-42.4	-43.4	-41.7	-42.3	-30.4	-21.25	9.1
	VHT80, M0.3 to M9.3	4	6	-42.4	-43.4	-41.7	-42.3	-30.4	-21.25	9.1
	VHT80 Beam Forming, M0.1 to M9.1	2	6	-40.5	-39.7			-31.1	-21.25	9.8
	VHT80 Beam Forming, M0.2 to M9.2	2	6	-40.5	-39.7			-31.1	-21.25	9.8
	VHT80 Beam Forming, M0.1 to M9.1	3	6	-42.4	-43.4	-41.7		-31.7	-21.25	10.4
	VHT80 Beam Forming, M0.2 to M9.2	3	6	-42.4	-43.4	-41.7		-31.7	-21.25	10.4
	VHT80 Beam Forming, M0.3 to M9.3	3	6	-42.4	-43.4	-41.7		-31.7	-21.25	10.4
	VHT80 Beam Forming, M0.1 to M9.1	4	6	-42.4	-43.4	-41.7	-42.3	-30.4	-21.25	9.1
	VHT80 Beam Forming, M0.2 to M9.2	4	6	-42.4	-43.4	-41.7	-42.3	-30.4	-21.25	9.1
	VHT80 Beam Forming, M0.3 to M9.3	4	6	-42.4	-43.4	-41.7	-42.3	-30.4	-21.25	9.1
VHT80 STBC, M0.1 to M9.1	2	6	-40.5	-39.7			-31.1	-21.25	9.8	
VHT80 STBC, M0.1 to M9.1	3	6	-42.4	-43.4	-41.7		-31.7	-21.25	10.4	
VHT80 STBC, M0.1 to M9.1	4	6	-42.4	-43.4	-41.7	-42.3	-30.4	-21.25	9.1	



Conducted Bandedge Average, 5190 MHz, HT/VHT40 Beam Forming, M0 to M7

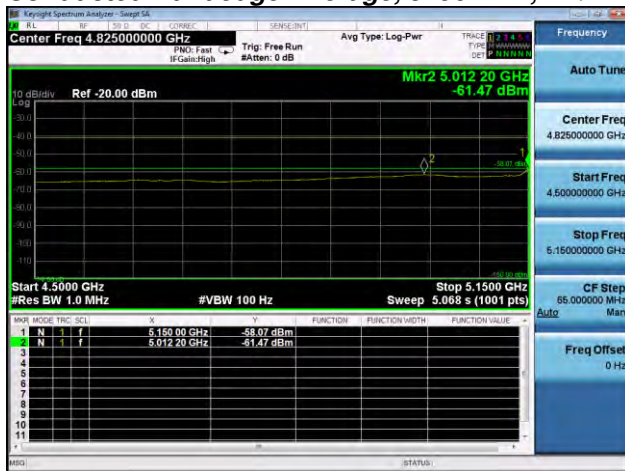

Antenna A

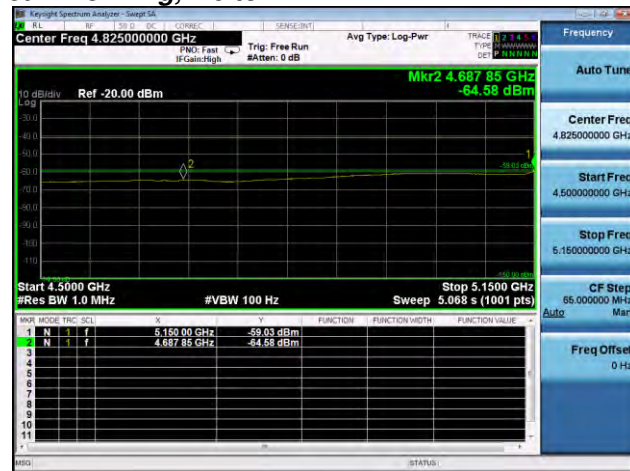

Antenna B

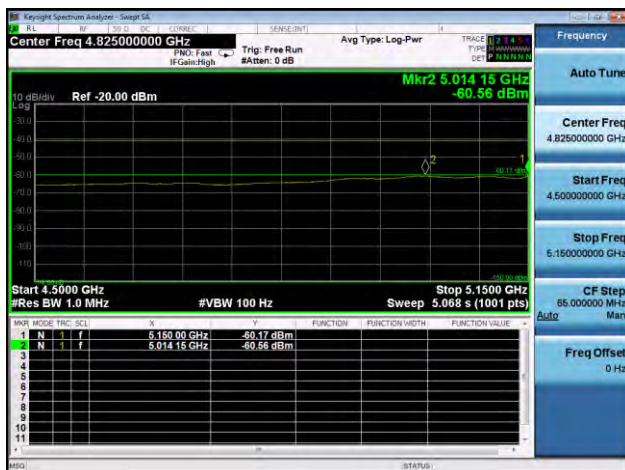

Antenna C



Antenna D



Conducted Bandedge Peak, 5190 MHz, Non HT40, 6 to 54 Mbps

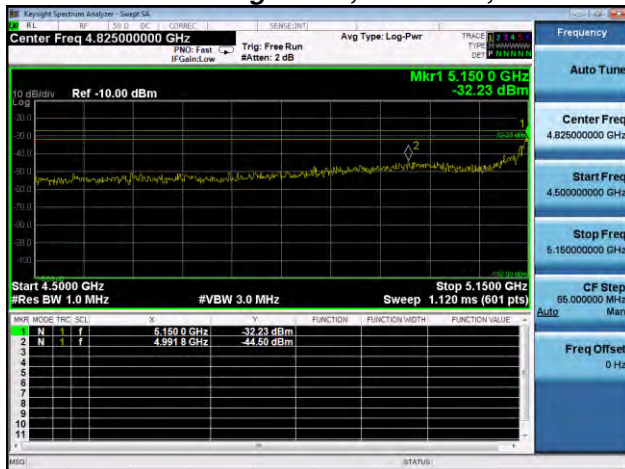

Antenna A

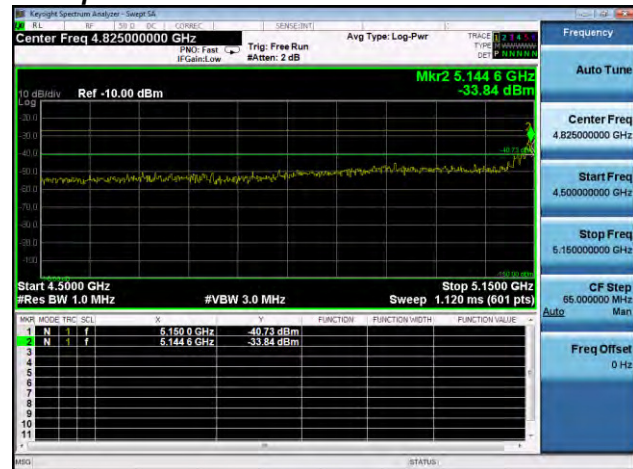

Antenna B

Appendix B: Emission Test Results

Testing Laboratory: Cisco Systems, Inc., 125 West Tasman Drive, San Jose, CA 95134, USA

Radiated Emission Setup Diagram-Below 1G

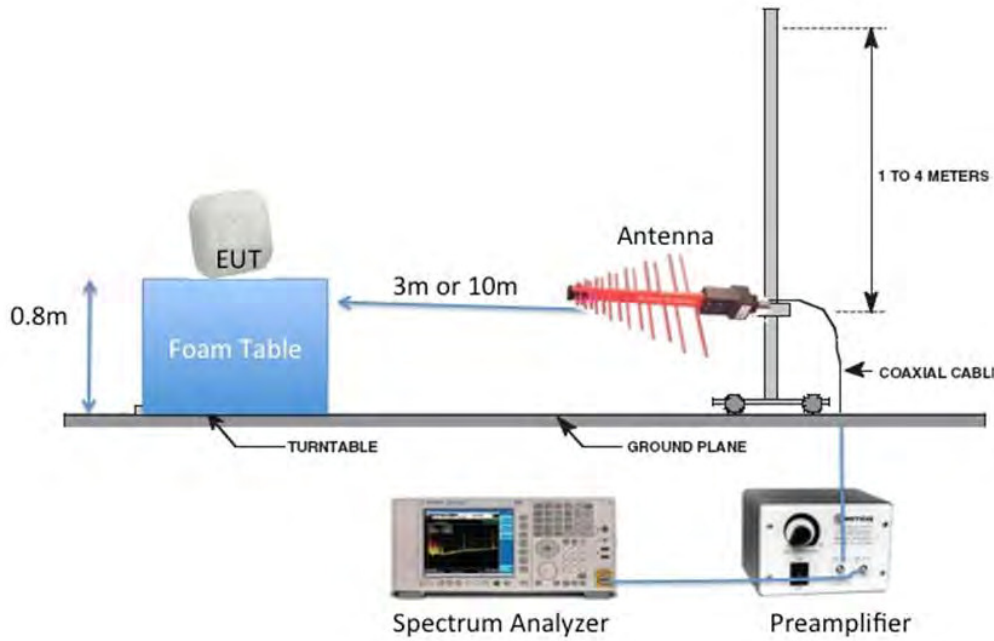

Radiated Emission Setup Diagram-Above 1G

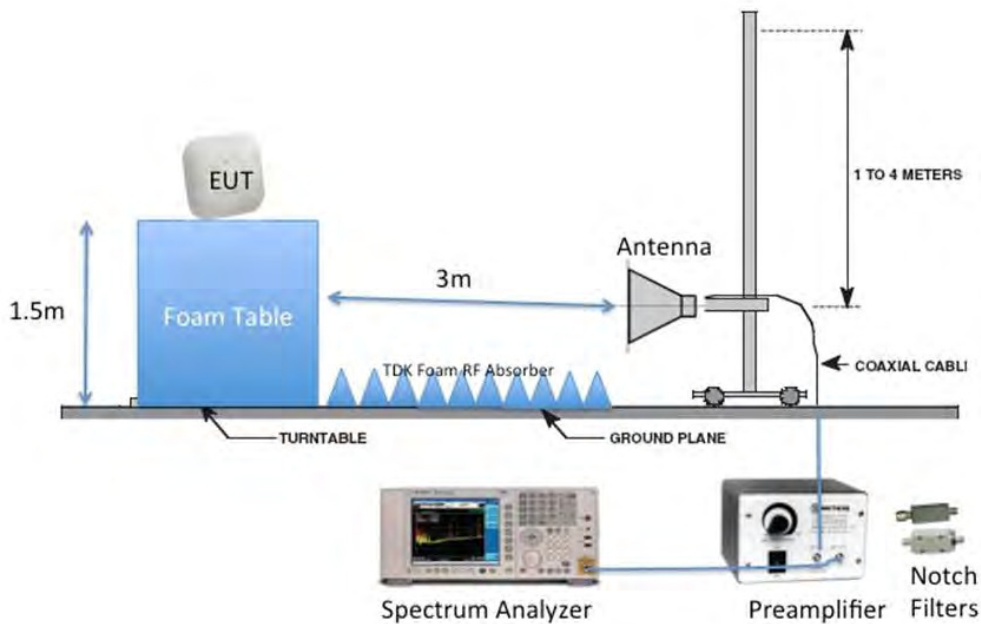

B1 Radiated Spurious Emissions

15.205 / 15.407 Radiated emissions which fall in the restricted bands, as defined in Section 15.205(a), must also comply with the radiated emission limits specified in Section 15.209(a) (see Section 15.205(c)).

Ref. ANSI C63.10: 2013 section 12.7.6 (peak) & 12.7.7.3 (average)

Using Vasona, configure the spectrum analyzer as shown below (be sure to enter all losses between the transmitter output and the spectrum analyzer). Place the radio in continuous transmit mode.

Span: 1GHz – 18 GHz
 Reference Level: 80 dBuV
 Attenuation: 10 dB
 Sweep Time: Coupled
 Resolution Bandwidth: 1MHz
 Video Bandwidth: 3 MHz for peak, 1 kHz for average
 Detector: Peak

Terminate the access Point RF ports with 50 ohm loads.

Maximize Turntable (find worst case table angle), Maximize Antenna (find worst case height)

Save 2 plots: 1) Average Plot (Vertical and Horizontal), Limit= 54dBuV/m @3m
 2) Peak plot (Vertical and Horizontal), Limit = 74dBuV/m @3m

Place a marker at the end of the restricted band closest to the transmit frequency to show compliance. Also measure any emissions in the restricted bands.

This report represents the worst case data for all supported operating modes and antennas. There are no measurable emissions above 18 GHz.

System Number	Description	Samples	System under test	Support equipment
1	EUT	S01	<input checked="" type="checkbox"/>	<input type="checkbox"/>
	Support	S02	<input type="checkbox"/>	<input checked="" type="checkbox"/>

Tested By : Jose Aguirre	Date of testing: 10-Feb-2016 – 22-Feb-2016
Test Result : PASS	

See Appendix C for list of test equipment

B.1.A Transmitter Radiated Spurious Emissions-Average Worst case

Frequency (MHz)	Mode	Data Rate (Mbps)	Spurious Emission Level (dBuV/m)	Limit (dBuV/m)	Margin (dBuV/m)
5180	6 to 54 Mbps	6	49.9	54.0	4.1
5190	HT40, M0 to M23	m0	50.0	54.0	4.0
5200	6 to 54 Mbps	6	50.0	54.0	4.0
5210	HT80, M0 to M23	m0x1	49.8	54.0	4.2
5230	HT40, M0 to M23	m0	50.2	54.0	3.8
5240	6 to 54 Mbps	6	50.1	54.0	3.9
5250	HT80, M0 to M23	m0x1	50.0	54.0	4.0

B.1.A.1 Radiated Transmitter Spurs, 5180 MHz, 6 to 54 Mbps, Average (1-18GHz) Worst Case 20MHz BW



B.1.A.2 Radiated Transmitter Spurs, 5190 MHz, HT40, M0 to M15, Average (1-18GHz) Worst Case 40MHz BW

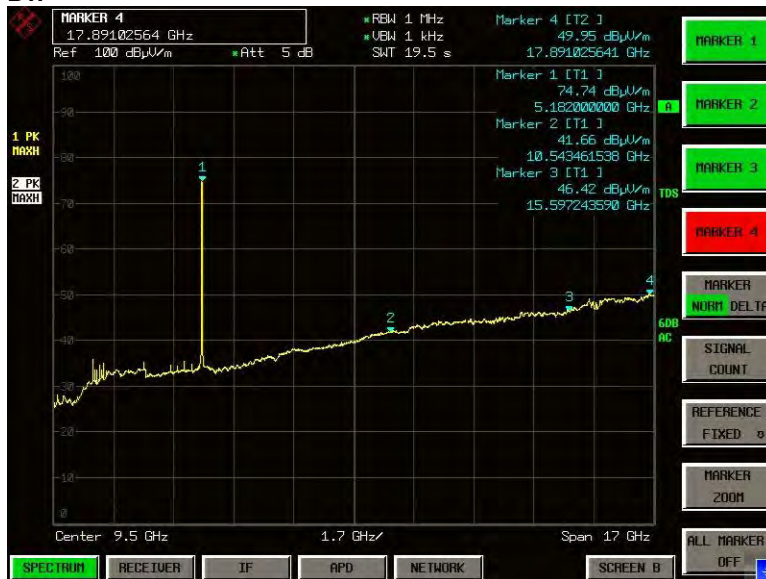



B.1.A.3 Radiated Transmitter Spurs, 5200 MHz, 6 to 54 Mbps , Average (1-18GHz) Worst Case 20MHz BW



B.1.A.4 Radiated Transmitter Spurs, 5210 MHz, HT/VHT80, M0 to M23, Average (1-18GHz) Worst Case 80MHz BW



B.1.A.5 Radiated Transmitter Spurs, 5230 MHz, HT40, M0 to M23, Average (1-18GHz) Worst Case 40MHz BW



B.1.A.6 Radiated Transmitter Spurs, 5240 MHz, 6 to 54 Mbps , Average (1-18GHz) Worst Case 20MHz BW



B.1.A.7 Radiated Transmitter Spurs, 5250 MHz, HT160, M0 to M23, Average (1-18GHz) Worst Case 160MHz BW





B.1.A.7 Radiated Transmitter Spurs, All rate, All modes, Average (18-26.5GHz)

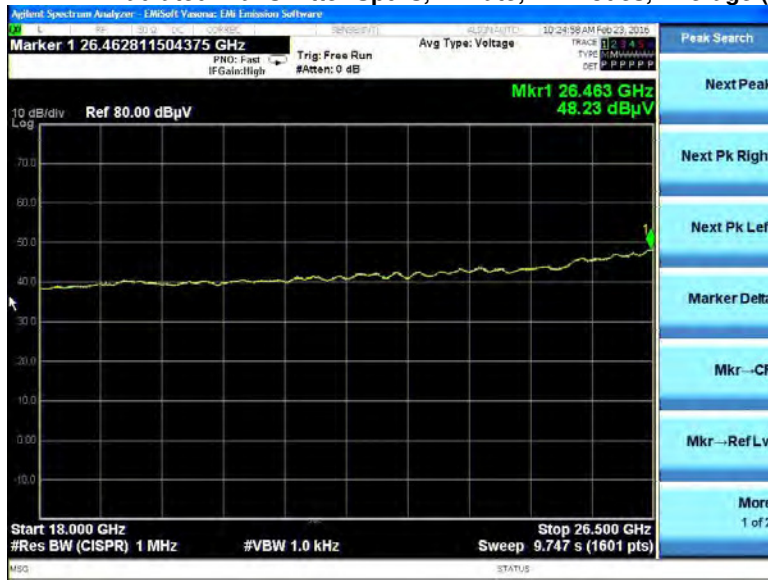

B.1.A.8 Radiated Transmitter Spurs, All rate, All modes, Average (26.5- 40GHz)



B.1.P Transmitter Radiated Spurious Emissions-Peak Worst Case

Frequency (MHz)	Mode	Data Rate (Mbps)	Spurious Emission Level (dBuV/m)	Limit (dBuV/m)	Margin (dBuV/m)
5180	6 to 54 Mbps	6	60.6	74.0	13.4
5190	HT40, M0 to M23	m0	61.4	74.0	12.6
5200	6 to 54 Mbps	6	61.8	74.0	12.2
5210	HT80, M0 to M23	m0x1	61.3	74.0	12.7
5230	HT40, M0 to M23	m0	61.6	74.0	12.4
5240	6 to 54 Mbps	6	61.4	74.0	12.6
5250	HT80, M0 to M23	m0x1	61.6	74.0	12.4

B.1.P.1 Radiated Transmitter Spurs, 5180 MHz, 6 to 54 Mbps, (1-18GHz) Worst Case 20MHz BW

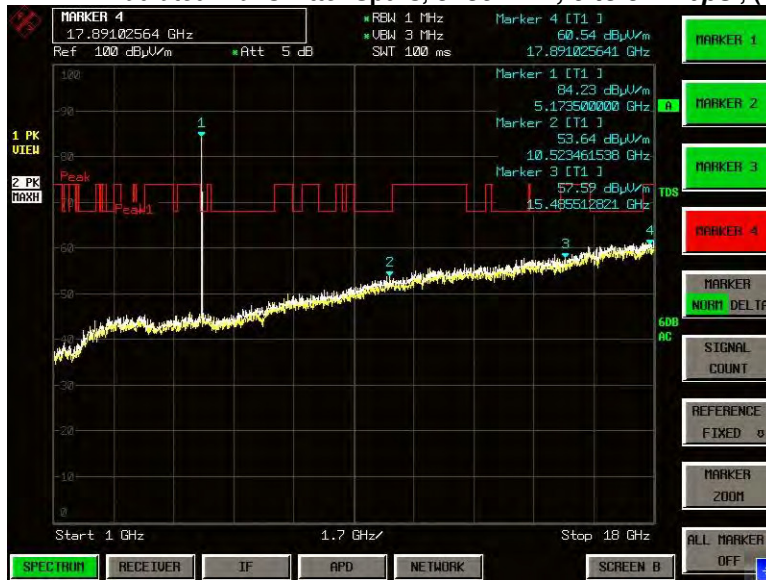

B.1.P.2 Radiated Transmitter Spurs, 5190 MHz, HT40, M0 to M23, Peak (1-18GHz) Worst Case 20MHz BW

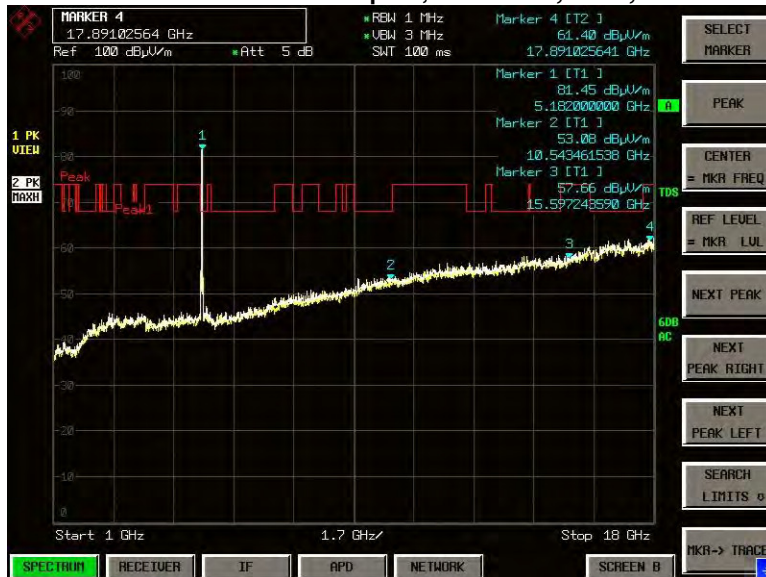

B.1.P.3 Radiated Transmitter Spurs, 5200 MHz, 6 to 54 Mbps, (1-18GHz) Worst Case 20MHz BW

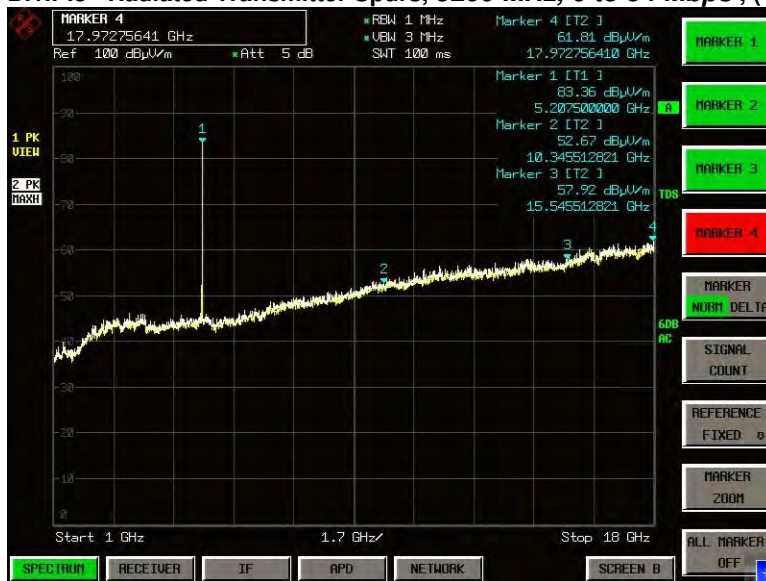

B.1.P.4 Radiated Transmitter Spurs, 5210 MHz, HT80, M0 to M23, Peak (1-18GHz) Worst Case 20MHz BW

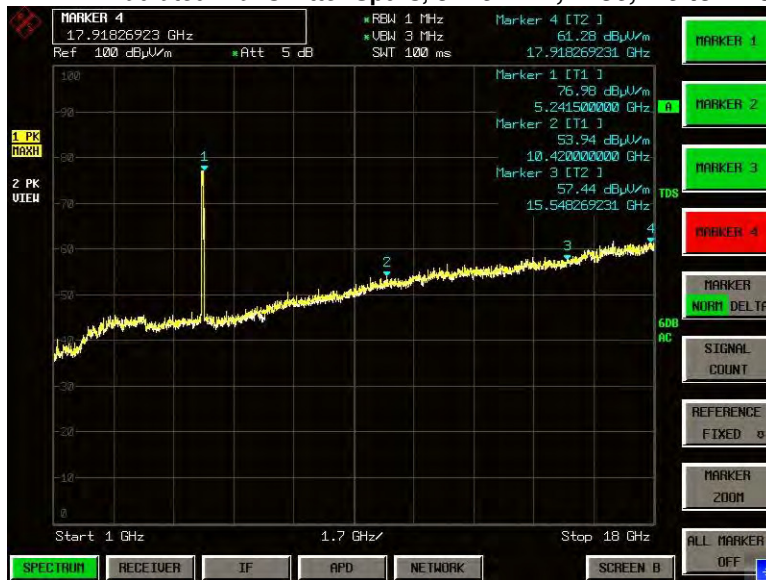

B.1.P.5 Radiated Transmitter Spurs, 5230 MHz, HT40, M0 to M23, Peak (1-18GHz) Worst Case 20MHz BW

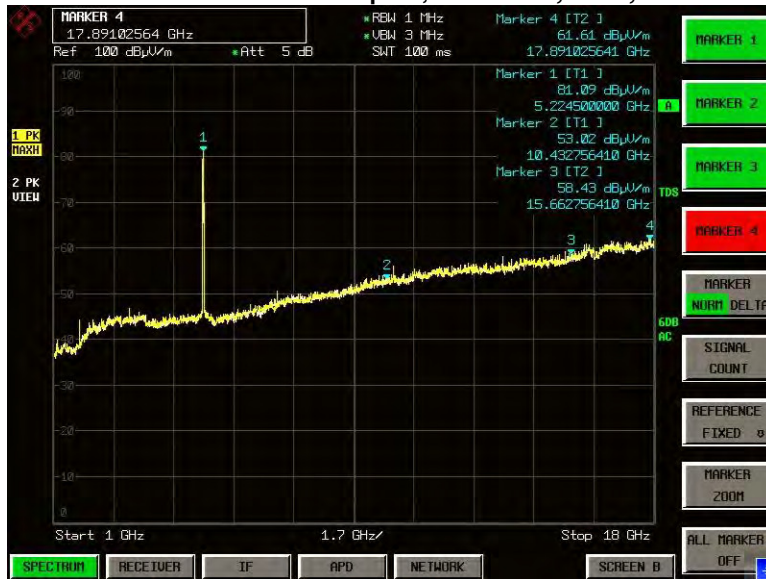

B.1.P.6 Radiated Transmitter Spurs, 5240 MHz, 6 to 54 Mbps, Peak (1-18GHz) Worst Case 20MHz BW

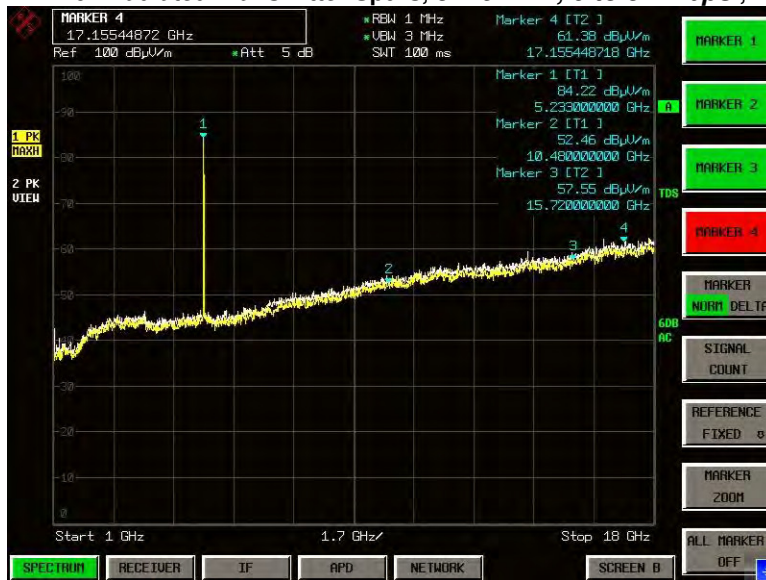

B.1.P.7 Radiated Transmitter Spurs, 5250 MHz, HT160, M0 to M23, Peak (1-18GHz) Worst Case 160MHz BW



B.1.P.7 Radiated Transmitter Spurs, All rate, All modes, Peak (18-26.5GHz)



B.1.P.8 Radiated Transmitter Spurs, All rate, All modes, Peak (26.5-40GHz)



B.2 Radiated Emissions 30MHz to 1GHz

15.209 / 15.205 / 15.407:

Radiated emissions which fall in the restricted bands, as defined in Section 15.205(a), must also comply with the radiated emission limits specified in Section 15.209(a) (see Section 15.205(c)).

Ref. ANSI C63.10: 2013 section 6.5

Using Vasona, configure the spectrum analyzer as shown below (be sure to enter all losses between the transmitter output and the spectrum analyzer). Place the radio in continuous transmit mode.

Span:	30MHz – 1GHz
Reference Level:	80 dBuV
Attenuation:	10 dB
Sweep Time:	Coupled
Resolution Bandwidth:	100kHz
Video Bandwidth:	300kHz
Detector:	Peak for Pre-scan, Quasi-Peak

Compliance shall be determined using CISPR quasi-peak detection; however, peak detection is permitted as an alternative to quasi-peak detection.

Terminate the access Point RF ports with 50 ohm loads.

Maximize Turntable (find worst case table angle), Maximize Antenna (find worst case height)

This report represents the worst case data for all supported operating modes and antennas.

System #	Description	Samples
1	EUT	S01
2	Support Power Supply	S02

Tested By : Jose Aguirre	Date of testing: 10-Feb-2016 – 22-Feb-2016
Test Result : PASS	

See Appendix C for list of test equipment

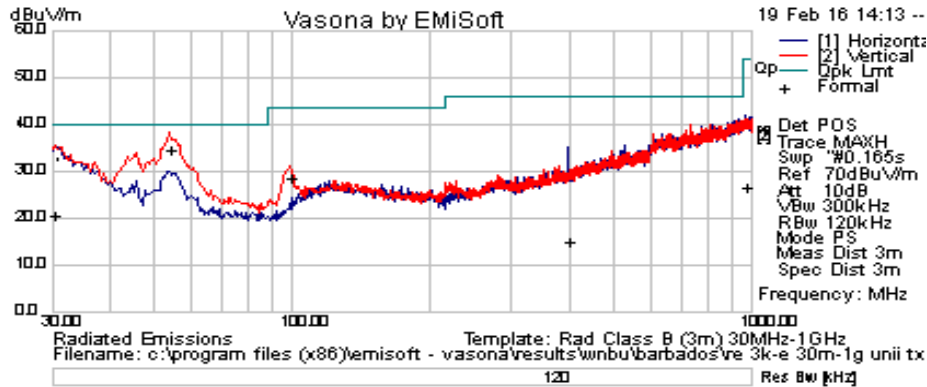

Test Result

Frequency MHz	Raw dBuV	Cable Loss	AF dB	Level dBuV/m	Measurement Type	P o l	Hgt cm	Azt Deg	Limit dBuV/m	Margi n dB	Pass /Fail
967.505	0.54	2.96	23.1	26.6	Quasi Max	H	389	52	54	-27.4	Pass
53.998	26.59	0.7	7.35	34.65	Quasi Max	V	110	142	40	-5.35	Pass
98.87	18.09	0.93	9.89	28.92	Quasi Max	V	157	194	43.5	-14.58	Pass
398.115	-1.71	1.89	15.0 6	15.24	Quasi Max	H	326	200	46	-30.76	Pass
30.485	-0.96	0.49	21.2 7	20.81	Quasi Max	V	355	350	40	-19.19	Pass

B.3 AC Conducted Emissions

15.207

Except when the requirements applicable to a given device state otherwise, for any radio apparatus equipped to operate from the public utility AC power supply, either directly or indirectly (such as with a battery charger), the radio frequency voltage of emissions conducted back onto the AC power lines in the frequency range of 0.15 MHz to 30 MHz shall not exceed the limits shown in the table in these sections. The more stringent limit applies at the frequency range boundaries.

Measurement Procedure

Accordance with ANSI C63.10:2013 section 6.2

Using Vasona, configure the spectrum analyzer as shown below (be sure to enter all losses between the transmitter output and the spectrum analyzer). Place the radio in continuous transmit mode.

Span:	150 KHz – 30 MHz
Attenuation:	10 dB
Sweep Time:	Coupled
Resolution Bandwidth:	9 KHz
Video Bandwidth:	30 KHz
Detector:	Quasi-Peak / Average

This report represents the worst case data for all supported operating modes.

System #	Description	Samples
1	EUT	S01
2	Support Power Supply	S02

Tested By : Jose Aguirre	Date of testing: 10-Feb-2016 – 22-Feb-2016
Test Result : Pass	

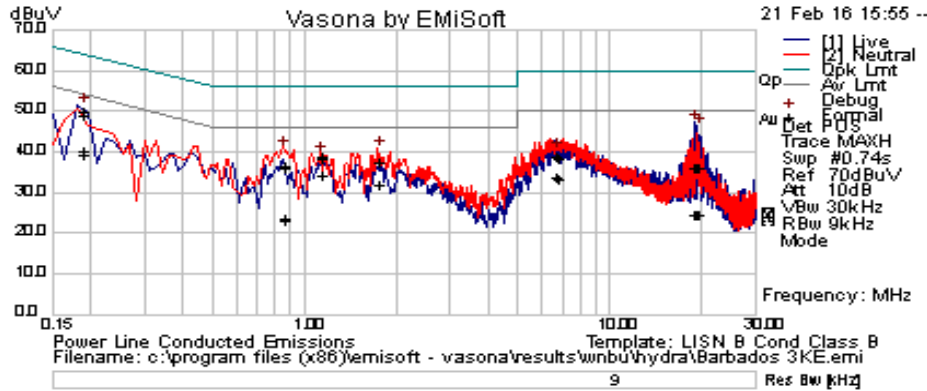

Test Results

Frequency MHz	Raw dBuV	Cable Loss	Factors dB	Level dBuV	Measurement Type	Line	Limit dBuV	Margin dB	Pass /Fail
0.857757	16.19	19.91	0.03	36.14	Quasi Peak	Live	56	-19.86	Pass
0.187244	29.09	20.91	0.06	50.06	Quasi Peak	Live	64.16	-14.1	Pass
19.007406	15.87	20.3	0.2	36.37	Quasi Peak	Live	60	-23.63	Pass
1.755417	17.64	19.9	0.03	37.57	Quasi Peak	Live	56	-18.43	Pass
19.383573	15.92	20.3	0.2	36.42	Quasi Peak	Live	60	-23.58	Pass
6.724028	18.68	20.01	0.07	38.76	Quasi Peak	Live	60	-21.24	Pass
1.131699	18.77	19.9	0.04	38.71	Quasi Peak	Live	56	-17.29	Pass
19.029708	16	20.3	0.2	36.5	Quasi Peak	Neutral	60	-23.5	Pass
0.856911	16.86	19.91	0.03	36.81	Quasi Peak	Neutral	56	-19.19	Pass
19.384527	15.97	20.3	0.2	36.47	Quasi Peak	Neutral	60	-23.53	Pass
0.190178	28.11	20.9	0.06	49.06	Quasi Peak	Neutral	64.03	-14.97	Pass
1.133571	19.28	19.9	0.04	39.22	Quasi Peak	Neutral	56	-16.78	Pass
1.756893	17.73	19.9	0.03	37.66	Quasi Peak	Neutral	56	-18.34	Pass
6.712994	19.08	20.01	0.07	39.16	Quasi Peak	Neutral	60	-20.84	Pass
0.857757	4.02	19.91	0.03	23.97	Average	Live	46	-22.03	Pass
0.187244	19.33	20.91	0.06	40.3	Average	Live	54.16	-13.86	Pass
19.007406	4.14	20.3	0.2	24.65	Average	Live	50	-25.35	Pass
1.755417	12.41	19.9	0.03	32.34	Average	Live	46	-13.66	Pass
19.383573	4.45	20.3	0.2	24.95	Average	Live	50	-25.05	Pass
6.724028	13.39	20.01	0.07	33.47	Average	Live	50	-16.53	Pass
1.131699	14.43	19.9	0.04	34.37	Average	Live	46	-11.63	Pass
19.029708	4.05	20.3	0.2	24.55	Average	Neutral	50	-25.45	Pass
0.856911	3.62	19.91	0.03	23.57	Average	Neutral	46	-22.43	Pass
19.384527	4.22	20.3	0.2	24.72	Average	Neutral	50	-25.28	Pass
0.190178	18.8	20.9	0.06	39.75	Average	Neutral	54.03	-14.28	Pass
1.133571	14.69	19.9	0.04	34.63	Average	Neutral	46	-11.37	Pass
1.756893	12.41	19.9	0.03	32.34	Average	Neutral	46	-13.66	Pass
6.712994	13.86	20.01	0.07	33.94	Average	Neutral	50	-16.06	Pass

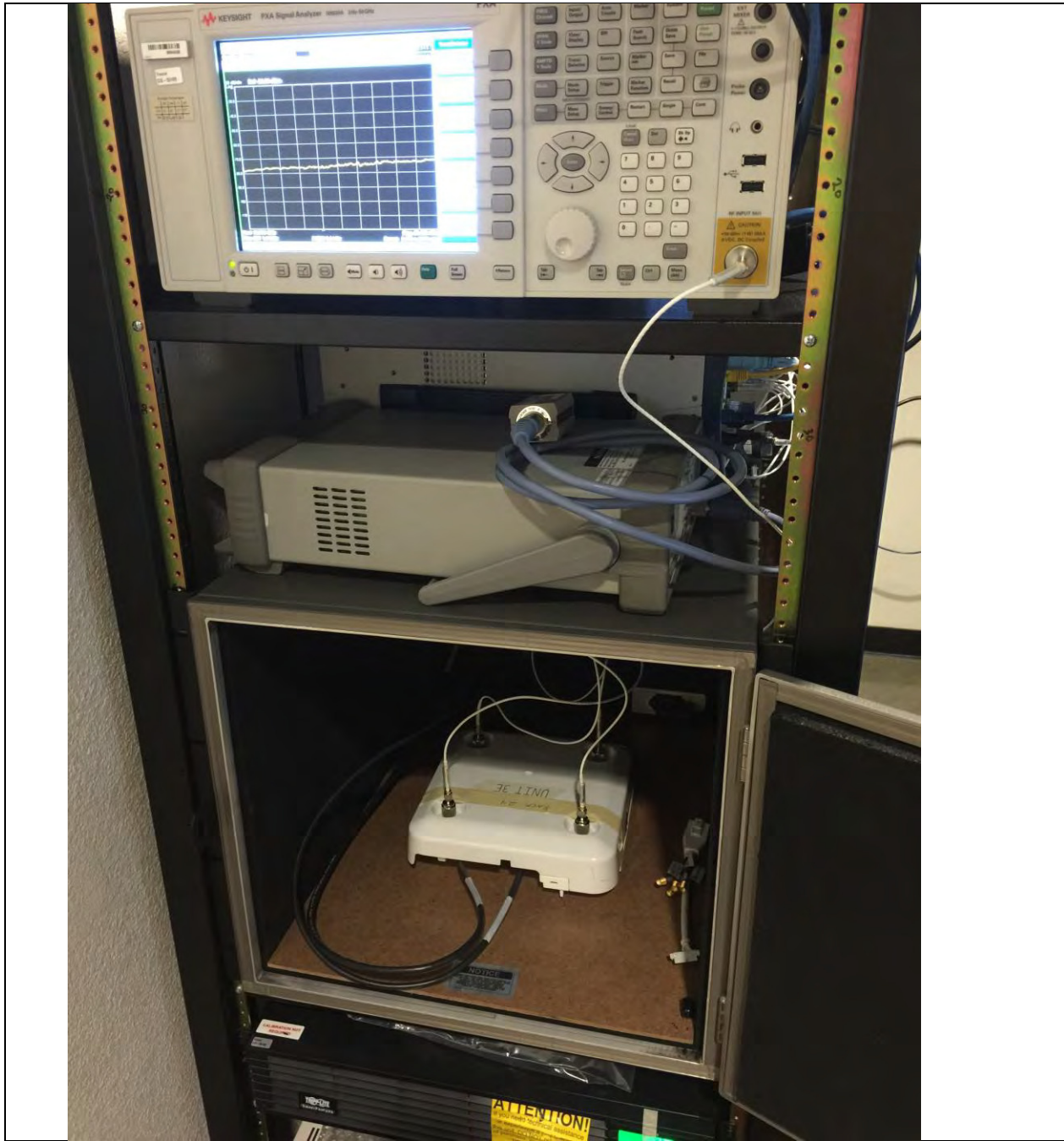
Photographs of setup**Title: Conducted Test Setup**

This is a dual band 2.4GHz / 5GHz device. All ports in this test set up photo are connected as all testing is automated. Section 2.6 of this test report given an overview of the different Tx antenna combinations used by this device.

AIR-AP3802E-B-K9 AC Mains Conducted Emissions setup

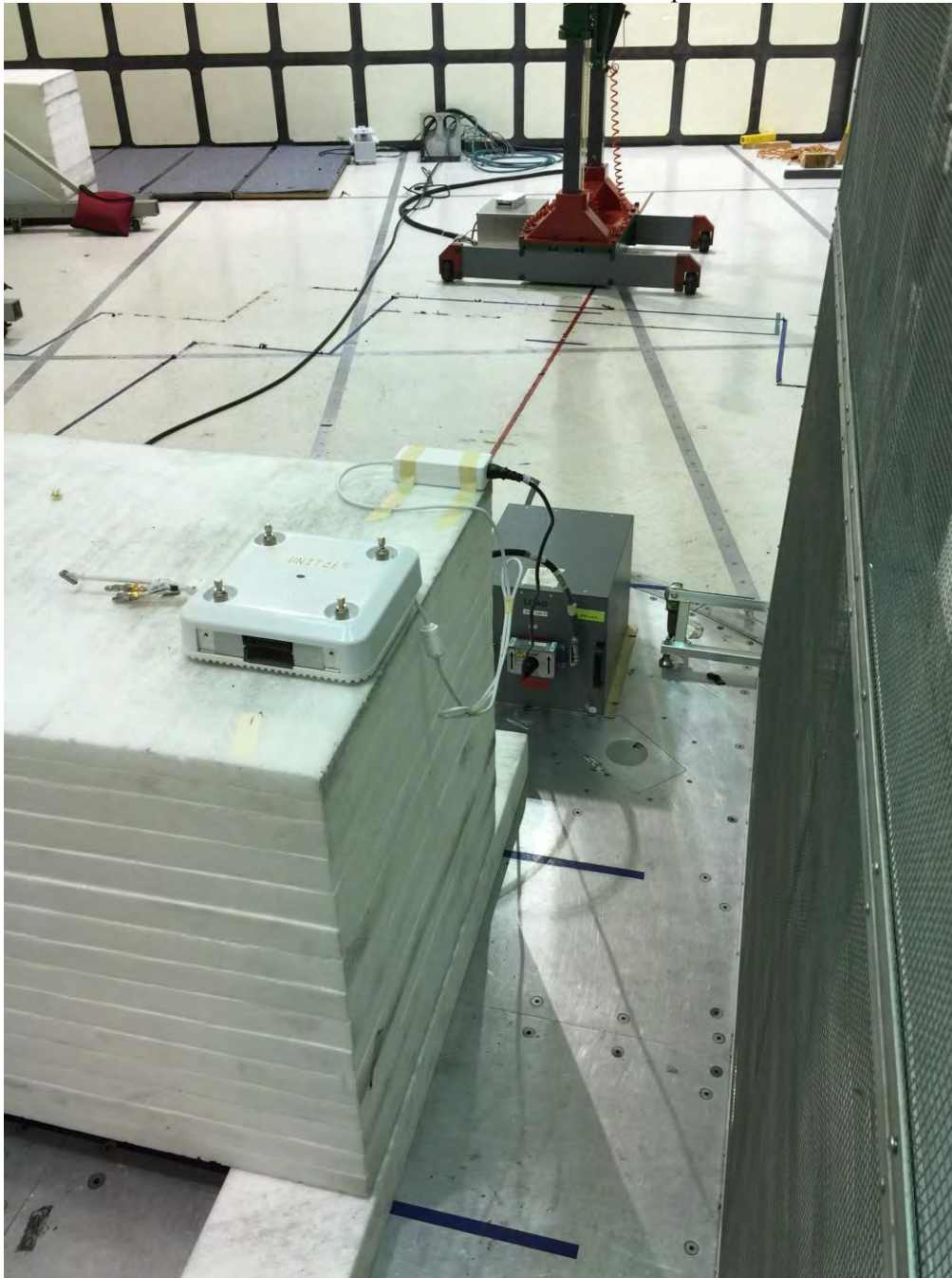

AIR-AP3802E-B-K9 Radiated Emissions setup 30MHz – 1GHz



AIR-AP3802E-B-K9 Radiated Emissions setup above 1GHz

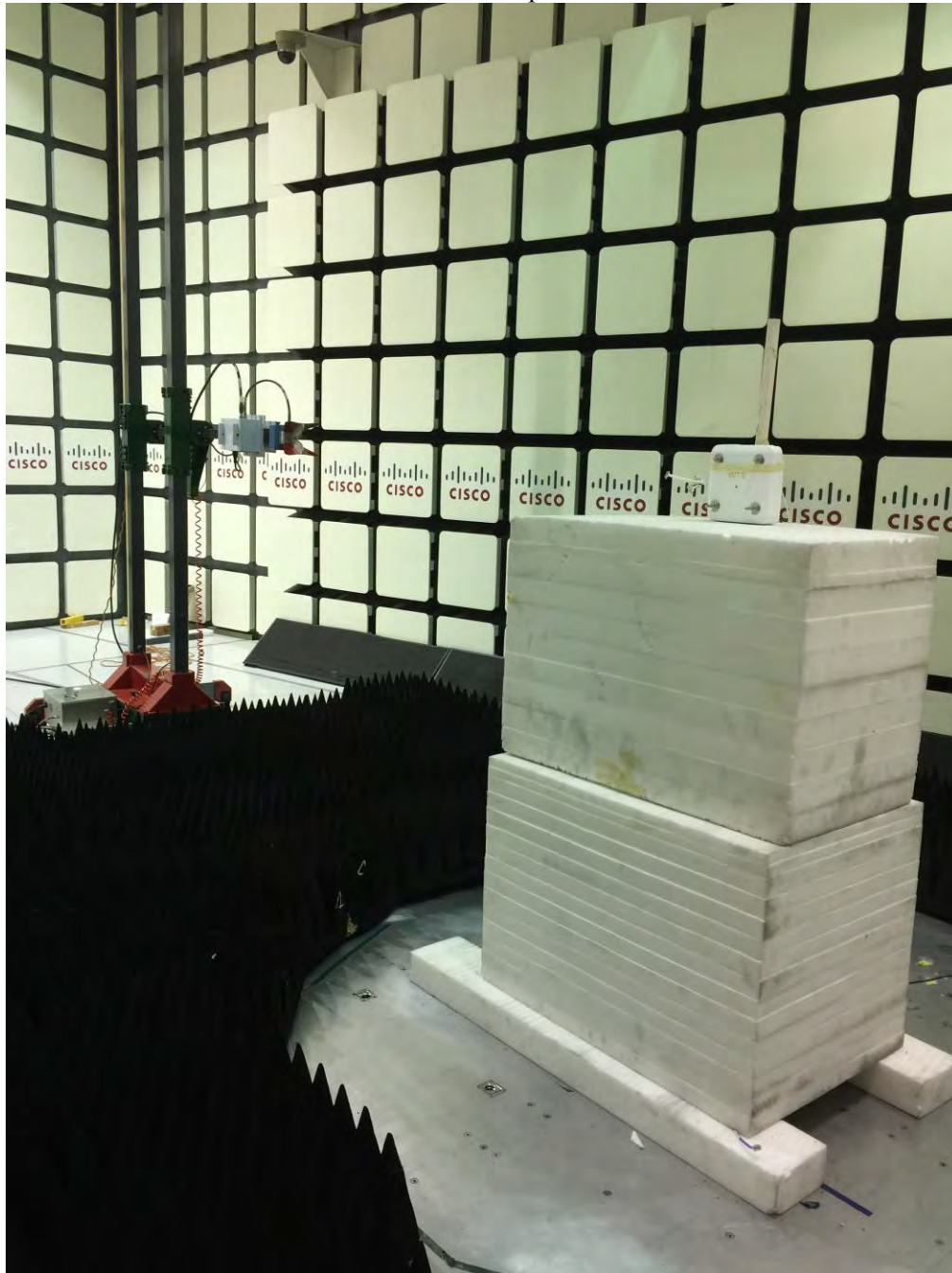

Appendix C: List of Test Equipment Used to perform the test

Equip#	Manufacturer/ Model	Description	Last Cal	Next Due	Test Item
Test Equipment used for Radiated Emissions					
CIS005691	NSP1800-25-S1 Miteq	Broadband Preamplicifier (1-18GHz)	25-Jun-15	25-Jun-16	B.1
CIS008448	NSA 5m Chamber Cisco	NSA 5m Chamber	9-Oct-15	9-Oct-16	B.2
CIS021117	UFB311A-0-2484-520520 Micro-Coax	RF Coaxial Cable, to 18GHz, 248.4 in	24-Aug-15	24-Aug-16	B.1, B.2
CIS034075	RSG 2000 Schaffner	Reference Spectrum Generator, 1-18GHz	Cal Not Required	Cal Not Required	B.1
CIS035284	3117 ETS-Lindgren	Double Ridged Waveguide Horn Antenna	30-Sep-15	30-Sep-16	B.1
CIS037236	50CB-015 JFW	GPIB Control Box	Cal Not Required	Cal Not Required	B.1
CIS040597	Above 1GHz Site Cal Cisco	Above 1GHz Cisprr Site Verification	25-Sep-15	25-Sep-16	B.1
CIS041979	1840 Cisco	18-40GHz EMI Test Head/Verification Fixture	13-Jul-15	13-Jul-16	B.1
CIS042266	JB1 Sunol Sciences	Combination Antenna	21-Apr-15	21-Apr-16	B.2
CIS044940	ESU40 Rohde & Schwarz	EMI Test Receiver, 20Hz-40GHz	2-Nov-15	2-Nov-16	B.1
CIS054230	iBTHP-5-DB9 Newport	5 inch Temp/RH/Press Sensor w/20ft cable	10-Feb-16	10-Feb-17	B.1, B.2

Test Equipment used for AC Mains Conducted Emissions					
Equip No	Model Manufacturer	Description	Last Cal	Next Cal	Test Item
CIS002464	FCC-801-M2-16 Fischer Custom Communications	CDN, 2-LINE, 16A	12-Mar-15	12-Mar-16	B.3
CIS049532	H785-150K-50-21378 TTE	High Pass Filter	8-May-15	8-May-16	B.3
CIS020913	FCC-LISN-PA-NEMA-5-15 Fischer Custom Communications	AC Adapter	8-May-15	8-May-16	B.3
CIS007704	FCC-LISN-50/250-50-2-01 Fischer Custom Communications	LISN	8-May-15	8-May-16	B.3
CIS008185	FCC-450B-2.4-N Fischer Custom Communications	Instrumentation Limiter	28-Jul-15	28-Jul-16	B.3
CIS051756	5-T-MB Bird	5W 50 Ohm BNC Termination 4GHz	6-Aug-15	6-Aug-16	B.3
CIS049563	Sucoflex 106A Huber + Suhner	N Type Cable 18GHz	24-Aug-15	24-Aug-16	B.3
CIS021117	UFB311A-0-2484-520520 Micro-Coax	RF Coaxial Cable, to 18GHz, 248.4 in	24-Aug-15	24-Aug-16	B.3
CIS044940	ESU40 Rohde & Schwarz	EMI Test Receiver, 20Hz-40GHz	2-Nov-15	2-Nov-16	B.3
CIS054647	33-605 Stanley	10meter Measuring Tape	Cal not required	Cal not required	B.3
CIS018963	CNE V York	Comparison Noise Emitter, 30 - 1000MHz	Cal not required	Cal not required	B.3

Test Equipment used for RF Conducted Tests					
Equip No	Model Manufacturer	Description	Last Cal	Next Cal	Test Item
CIS050721	N9030A	PXA Signal Analyzer	13-Apr-15	13-Apr-16	A1 thru A4

	Keysight				
CIS054662	SF18-S1S1-36 MegaPhase	SMA 36" cable	24-Sep-15	24-Sep-16	A1 thru A4
CIS054663	F120-S1S1-48 MegaPhase	SMA 48" Cable	25-Sep-15	25-Sep-16	A1 thru A4
CIS054665	RA08-S1S1-24 MegaPhase	SMA 24" Cable	25-Sep-15	25-Sep-16	A1 thru A4
CIS054666	RA08-S1S1-18 MegaPhase	SMA 18" Cable	25-Sep-15	25-Sep-16	A1 thru A4
CIS054667	RA08-S1S1-18 MegaPhase	SMA 18" Cable	25-Sep-15	25-Sep-16	A1 thru A4
CIS054668	RA08-S1S1-18 MegaPhase	SMA 18" Cable	25-Sep-15	25-Sep-16	A1 thru A4
CIS054669	RA08-S1S1-18 MegaPhase	SMA 18" Cable	25-Sep-15	25-Sep-16	A1 thru A4
CIS054670	RA08-S1S1-12 MegaPhase	SMA 12" Cable	25-Sep-15	25-Sep-16	A1 thru A4
CIS054671	RA08-S1S1-12 MegaPhase	SMA 12" Cable	25-Sep-15	25-Sep-16	A1 thru A4
CIS054672	RA08-S1S1-12 MegaPhase	SMA 12" Cable	25-Sep-15	25-Sep-16	A1 thru A4
CIS054673	RA08-S1S1-12 MegaPhase	SMA 12" Cable	25-Sep-15	25-Sep-16	A1 thru A4
CIS054674	RA08-S1S1-12 MegaPhase	SMA 12" Cable	25-Sep-15	25-Sep-16	A1 thru A4
CIS054675	RA08-S1S1-12 MegaPhase	SMA 12" Cable	25-Sep-15	25-Sep-16	A1 thru A4
CIS054677	RA08-S1S1-12 MegaPhase	SMA 12" Cable	25-Sep-15	25-Sep-16	A1 thru A4
CIS054678	RA08-S1S1-12 MegaPhase	SMA 12" Cable	25-Sep-15	25-Sep-16	A1 thru A4
CIS054686	NI PXI-2796 National Instruments	Plug-in switch module	6-Oct-15	6-Oct-16	A1 thru A4
CIS055094	PXI-1042 National Instruments	Chassis	Cal Not Required	Cal Not Required	A1 thru A4
CIS055117	RFLT2WDC40G RF Lambda	2 Way 40GHz Splitter	11-Nov-15	11-Nov-16	A1 thru A4
CIS055166	RFLT4WDC40GK RF Lambda	4 Way Power Divider 40GHz	23-Nov-15	23-Nov-16	A1 thru A4
CIS054656	BRC50705-02 Micro-Tronics	Band Reject Filter	24-Sep-15	24-Sep-16	A1 thru A4
CIS054655	BRC50704-02 Micro-Tronics	Notch Filter, SB:5.470-5.725GHz, to 12GHz	24-Sep-15	24-Sep-16	A1 thru A4
CIS054654	BRC50703-02 Micro-Tronics	Notch Filter, SB:5.150-5.350GHz, to 11GHz	24-Sep-15	24-Sep-16	A1 thru A4
CIS054653	BRM50702-02 Micro-Tronics	Notch Filter, SB:2.400-2.500GHz, to 18GHz	24-Sep-15	24-Sep-16	A1 thru A4
CIS054637	BWS30-W2/ Aeroflex	SMA 30dB Attenuator	02-June-15	02-June-16	A1 thru A4
CIS054636	BWS20-W2/ Aeroflex	20dB SMA Attenuator	02-June-15	02-June-16	A1 thru A4

Appendix E: Abbreviation Key and Definitions

The following table defines abbreviations used within this test report.

Abbreviation	Description	Abbreviation	Description
EMC	Electro Magnetic Compatibility	°F	Degrees Fahrenheit
EMI	Electro Magnetic Interference	°C	Degrees Celsius
EUT	Equipment Under Test	Temp	Temperature
ITE	Information Technology Equipment	S/N	Serial Number
TAP	Test Assessment Schedule	Qty	Quantity
ESD	Electro Static Discharge	emf	Electromotive force
EFT	Electric Fast Transient	RMS	Root mean square
EDCS	Engineering Document Control System	Qp	Quasi Peak
Config	Configuration	Av	Average
CIS#	Cisco Number (unique identification number for Cisco test equipment)	Pk	Peak
Cal	Calibration	kHz	Kilohertz (1×10^3)
EN	European Norm	MHz	MegaHertz (1×10^6)
IEC	International Electro technical Commission	GHz	Gigahertz (1×10^9)
CISPR	International Special Committee on Radio Interference	H	Horizontal
CDN	Coupling/Decoupling Network	V	Vertical
LISN	Line Impedance Stabilization Network	dB	decibel
PE	Protective Earth	V	Volt
GND	Ground	kV	Kilovolt (1×10^3)
L1	Line 1	μ V	Microvolt (1×10^{-6})
L2	Line2	A	Amp
L3	Line 3	μ A	Micro Amp (1×10^{-6})
DC	Direct Current	mS	Milli Second (1×10^{-3})
RAW	Uncorrected measurement value, as indicated by the measuring device	μ S	Micro Second (1×10^{-6})
RF	Radio Frequency	μ S	Micro Second (1×10^{-6})
SLCE	Signal Line Conducted Emissions	m	Meter
Meas dist	Measurement distance	Spec dist	Specification distance
N/A or NA	Not Applicable	SL	Signal Line (or Telecom Line)
P	Power Line	L	Live Line
N	Neutral Line	R	Return
S	Supply	AC	Alternating Current

End