

Test Report

AIR-AP1832I-B-K9

Cisco Aironet 802.11ac Dual Band Access Points

FCC ID: LDK102098

5470-5725 MHz

Against the following Specifications:

CFR47 Part 15.407



Cisco Systems

170 West Tasman Drive

San Jose, CA 95134

	
Author: Jose Aguirre Tested By: TEST ENGINEER	Approved By: Jim Nicholson Title: Technical Leader, Engineering Revision: 3

This report replaces any previously entered test report under EDCS – **11496964**. This test report has been electronically authorized and archived using the CISCO Engineering Document Control system.

This test report has been electronically authorized and archived using the CISCO Engineering Document Control system.

SECTION 1: OVERVIEW	3
SECTION2: ASSESSMENT INFORMATION	4
2.1 GENERAL	4
2.2 DATE OF TESTING.....	6
2.3 REPORT ISSUE DATE	6
2.4 TESTING FACILITIES	6
2.5 EQUIPMENT ASSESSED (EUT).....	6
2.6 EUT DESCRIPTION.....	7
SECTION 3: RESULT SUMMARY	9
3.1 RESULTS SUMMARY TABLE	9
SECTION 4: SAMPLE DETAILS.....	10
4.1 SAMPLE DETAILS	10
4.2 SYSTEM DETAILS	10
4.3 MODE OF OPERATION DETAILS.....	10
APPENDIX A: EMISSION TEST RESULTS	11
CONDUCTED TEST SETUP DIAGRAM.....	11
TARGET MAXIMUM CHANNEL POWER	11
A.1 99% AND 26DB BANDWIDTH.....	12
A.2 MAXIMUM CONDUCTED OUTPUT POWER/ POWER SPECTRAL DENSITY	27
A.3 CONDUCTED SPURIOUS EMISSIONS	43
A.4 CONDUCTED BANDEDGE.....	57
APPENDIX B: EMISSION TEST RESULTS	68
RADIATED EMISSION SETUP DIAGRAM-BELOW 1G.....	68
B.1 RADIATED SPURIOUS EMISSIONS	69
B.2 RADIATED EMISSIONS 30MHZ TO 1GHZ	70
B.3 AC CONDUCTED EMISSIONS	95
APPENDIX C: LIST OF TEST EQUIPMENT USED TO PERFORM THE TEST	98
APPENDIX E: ABBREVIATION KEY AND DEFINITIONS	101



Section 1: Overview

The samples were assessed against the tests detailed in section 3 under the requirements of the following specifications:

Specifications:
CFR47 Part 15.407

Measurements were made in accordance with

- ANSI C63.10:2013
- KDB 789033 D02 General UNII Test Procedures New Rules v01r03
- KDB 662911 D01 Multiple Transmitter Output v02r01

Section2: Assessment Information

2.1 General

This report contains an assessment of an apparatus against Electromagnetic Compatibility Standards based upon tests carried out on the samples submitted. The testing was performed by and for the use of Cisco systems Inc:

With regard to this assessment, the following points should be noted:

- a) The results contained in this report relate only to the items tested and were obtained in the period between the date of the initial assessment and the date of issue of the report. Manufactured products will not necessarily give identical results due to production and measurement tolerances.
- b) The apparatus was set up and exercised using the configuration and modes of operation defined in this report only.
- c) Where relevant, the apparatus was only assessed using the susceptibility criteria defined in this report and the Test Assessment Plan (TAP).
- d) All testing was performed under the following environmental conditions:

Temperature	15°C to 35°C (54°F to 95°F)
Atmospheric Pressure	860mbar to 1060mbar (25.4" to 31.3")
Humidity	10% to 75*%
- e) All AC testing was performed at one or more of the following supply voltages:
110V 60 Hz (+/-20%)

Units of Measurement

The units of measurements defined in the appendices are reported in specific terms, which are test dependent. Where radiated measurements are concerned these are defined at a particular distance. Basic voltage measurements are defined in units of [dBuV]

As an example, the basic calculation for all measurements is as follows:

$$\text{Emission level [dBuV]} = \text{Indicated voltage level [dBuV]} + \text{Cable Loss [dB]} + \text{Other correction factors [dB]}$$

The combinations of correction factors are dependent upon the exact test configurations [see test equipment lists for further details] and may include:-

Antenna Factors, Pre Amplifier Gain, LISN Loss, Pulse Limiter Loss and Filter Insertion Loss

Note: to convert the results from dBuV/m to uV/m use the following formula:-

$$\text{Level in uV/m} = \text{Common Antilogarithm} [(X \text{ dBuV/m})/20] = Y \text{ uV/m}$$

Measurement Uncertainty Values

voltage and power measurements	± 2 dB
conducted EIRP measurements	± 1.4 dB
radiated measurements	± 3.2 dB
frequency measurements	± 2.4 10 ⁻⁷
temperature measurements	± 0.54°
humidity measurements	± 2.3%
DC and low frequency measurements	± 2.5%

Where relevant measurement uncertainty levels have been estimated for tests performed on the apparatus. This uncertainty represents an expanded uncertainty expressed at approximately the 95% confidence level using a coverage factor of k=2.

Radiated emissions (expanded uncertainty, confidence interval 95%)

30 MHz - 300 MHz	+/- 3.8 dB
300 MHz - 1000 MHz	+/- 4.3 dB
1 GHz - 10 GHz	+/- 4.0 dB
10 GHz - 18GHz	+/- 8.2 dB
18GHz - 26.5GHz	+/- 4.1 dB
26.5GHz - 40GHz	+/- 3.9 dB

Conducted emissions (expanded uncertainty, confidence interval 95%)

30 MHz – 40GHz	+/- 0.38 dB
----------------	-------------

A product is considered to comply with a requirement if the nominal measured value is below the limit line. The product is considered to not be in compliance in case the nominal measured value is above the limit line.

This report must not be reproduced except in full, without written approval of Cisco Systems.

2.2 Date of testing

05-May-16 - 14-Nov-16

2.3 Report Issue Date

17-Nov-16

Cisco uses an electronic system to issue, store and control the revision of test reports. This system is called the Engineering Document Control System 11496964. The actual report issue date is embedded into the original file on EDCS. Any copies of this report, either electronic or paper, that are not on EDCS must be considered uncontrolled.

2.4 Testing facilities

This assessment was performed by:

Testing Laboratory

Cisco Systems, Inc.,
125 West Tasman Drive
San Jose, CA 95134, USA

Registration Numbers for Industry Canada

Cisco System Site	Address	Site Identifier
Building P, 10m Chamber	125 West Tasman Dr San Jose, CA 95134	Company #: 2461N-2
Building P, 5m Chamber	125 West Tasman Dr San Jose, CA 95134	Company #: 2461N-1
Building I, 5m Chamber	285 W. Tasman Drive San Jose, California 95134	Company #: 2461M-1

Test Engineers

Jose Aguirre

2.5 Equipment Assessed (EUT)

AIR-AP1832I-B-K9

2.6 EUT Description

The Cisco Aironet 802.11ac Radio supports the following modes of operation. The modes are further defined in the radio Theory of Operation. The modes included in this report represent the worst case data for all modes.

802.11n/ac - Mode, Tx Paths

802.11n/ac - Non HT20, One Antenna, 6 to 54 Mbps, 1ss
802.11n/ac - Non HT20, Two Antennas, 6 to 54 Mbps, 1ss
802.11n/ac - Non HT20, Three Antennas, 6 to 54 Mbps, 1ss

802.11n/ac - Non HT20 Beam Forming, Two Antennas, 6 to 54 Mbps, 1ss
802.11n/ac - Non HT20 Beam Forming, Three Antennas, 6 to 54 Mbps, 1ss

802.11n/ac - HT/VHT20, One Antenna, M0 to M7, 1ss
802.11n/ac - HT/VHT20, Two Antennas, M0 to M7, 1ss
802.11n/ac - HT/VHT20, Two Antennas, M8 to M15, 2ss
802.11n/ac - HT/VHT20, Three Antennas, M0 to M7, 1ss
802.11n/ac - HT/VHT20, Three Antennas, M8 to M15, 2ss

802.11n/ac - HT/VHT20 Beam Forming, Two Antennas, M0 to M7, 1ss
802.11n/ac - HT/VHT20 Beam Forming, Two Antennas, M8 to M15, 2ss
802.11n/ac - HT/VHT20 Beam Forming, Three Antennas, M0 to M7, 1ss
802.11n/ac - HT/VHT20 Beam Forming, Three Antennas, M8 to M15, 2ss

802.11n/ac - HT/VHT20 STBC, Two Antennas, M0 to M7, 2ss
802.11n/ac - HT/VHT20 STBC, Three Antennas, M0 to M7, 2ss

802.11n/ac - Non HT40 Duplicate, One Antenna, 6 to 54 Mbps, 1ss
802.11n/ac - Non HT40 Duplicate, Two Antennas, 6 to 54 Mbps, 1ss
802.11n/ac - Non HT40 Duplicate, Three Antennas, 6 to 54 Mbps, 1ss

802.11n/ac - HT/VHT40, One Antenna, M0 to M7, 1ss
802.11n/ac - HT/VHT40, Two Antennas, M0 to M7, 1ss
802.11n/ac - HT/VHT40, Two Antennas, M8 to M15, 2ss
802.11n/ac - HT/VHT40, Three Antennas, M0 to M7, 1ss
802.11n/ac - HT/VHT40, Three Antennas, M8 to M15, 2ss

802.11n/ac - HT/VHT40 Beam Forming, Two Antennas, M0 to M7, 1ss
802.11n/ac - HT/VHT40 Beam Forming, Two Antennas, M8 to M15, 2ss
802.11n/ac - HT/VHT40 Beam Forming, Three Antennas, M0 to M7, 1ss
802.11n/ac - HT/VHT40 Beam Forming, Three Antennas, M8 to M15, 2ss

802.11n/ac - HT/VHT40 STBC, Two Antennas, M0 to M7, 2ss
802.11n/ac - HT/VHT40 STBC, Three Antennas, M0 to M7, 2ss

802.11n/ac - Non HT80 Duplicate, One Antenna, 6 to 54 Mbps, 1ss
802.11n/ac - Non HT80 Duplicate, Two Antennas, 6 to 54 Mbps, 1ss
802.11n/ac - Non HT80 Duplicate, Three Antennas, 6 to 54 Mbps, 1ss

802.11ac - VHT80, One Antenna, M0 to M9 1ss
802.11ac - VHT80, Two Antennas, M0 to M9 1ss
802.11ac - VHT80, Two Antennas, M0 to M9 2ss
802.11ac - VHT80, Three Antennas, M0 to M9 1ss
802.11ac - VHT80, Three Antennas, M0 to M9 2ss

802.11ac - VHT80 Beam Forming, Two Antennas, M0 to M9 1ss
802.11ac - VHT80 Beam Forming, Two Antennas, M0 to M9 2ss

802.11ac - VHT80 Beam Forming, Three Antennas, M0 to M9 1ss
802.11ac - VHT80 Beam Forming, Three Antennas, M0 to M9 2ss

802.11ac - VHT80 STBC, Two Antennas, M0 to M9 2ss
802.11ac - VHT80 STBC, Three Antennas, M0 to M9 2ss

The following antennas are supported by this product series.
The data included in this report represent the worst case data for all antennas.

Frequency	Part Number	Antenna Type	Antenna Gain (dBi)
2.4 / 5 GHz	3x3 Internal	Omni	3/5

Section 3: Result Summary

3.1 Results Summary Table

Conducted emissions

Basic Standard	Technical Requirements / Details	Result
FCC 15.407	<p>99% & 26 dB Bandwidth: The 99% occupied bandwidth is the frequency bandwidth such that, below its lower and above its upper frequency limits, the mean powers are each equal to 0.5% of the total mean power of the given emission. There is no limit for 99% OBW.</p> <p>The 26 dB emission is the width of the emission that is constrained by the frequencies associated with the two outermost amplitude points (upper and lower frequencies) that are attenuated by 26 dB relative to the maximum level measured in the fundamental emission.</p>	Pass
FCC 15.407	<p>Output Power: 15.407 (2) For the 5.25-5.35 GHz and 5.47-5.725 GHz bands, the maximum conducted output power over the frequency bands of operation shall not exceed the lesser of 250 mW or 11 dBm + 10 log B, where B is the 26 dB emission bandwidth in megahertz. In addition, the maximum power spectral density shall not exceed 11 dBm in any 1 megahertz band. If transmitting antennas of directional gain greater than 6 dBi are used, both the maximum conducted output power and the maximum power spectral density shall be reduced by the amount in dB that the directional gain of the antenna exceeds 6 dBi.</p>	Pass
FCC 15.407	<p>Power Spectral Density: 15.407 The maximum power spectral density shall not exceed 17 dBm in any 1 megahertz band. If transmitting antennas of directional gain greater than 6 dBi are used, both the maximum conducted output power and the maximum power spectral density shall be reduced by the amount in dB that the directional gain of the antenna exceeds 6 dBi.</p>	Pass
FCC 15.407	<p>Conducted Spurious Emissions / Band-Edge: 15.407 (3) For transmitters operating in the 5.47-5.725 GHz band: All emissions outside of the 5.47-5.725 GHz band shall not exceed an e.i.r.p. of -27 dBm/MHz.</p>	Pass
FCC 15.407 FCC 15.209 FCC 15.205	<p>Restricted band: Unwanted emissions falling within the restricted bands, as defined in FCC 15.205 (a) must also comply with the radiated emission limits specified in FCC 15.209 (a).</p>	Pass

Radiated Emissions (General requirements)

Basic Standard	Technical Requirements / Details	Result
FCC 15.209 FCC 15.205	<p>TX Spurious Emissions: Except as provided elsewhere in this subpart, the emissions from an intentional radiator shall not exceed the field strength levels specified in the filed strength limits table in this section.</p>	Pass
FCC 15.207	<p>AC conducted Emissions: Except when the requirements applicable to a given device state otherwise, for any radio apparatus equipped to operate from the public utility AC power supply, either directly or indirectly (such as with a battery charger), the radio frequency voltage of emissions conducted back onto the AC power lines in the frequency range of 0.15 MHz to 30 MHz shall not exceed the limits shown in the table in these sections. The more stringent limit applies at the frequency range boundaries.</p>	Pass

* MPE calculation is recorded in a separate report

Section 4: Sample Details

Note: Each sample was evaluated to ensure that its condition was suitable to be used as a test sample prior to the commencement of testing.

4.1 Sample Details

Sample No.	Equipment Details	Manufacturer	Hardware Rev.	Firmware Rev.	Software Rev.	Serial Number
S01	AIR-AP1832I-B-K9	Cisco Systems	P2	8.4.1.10	AP1G4 Sept22	RFDP2BHY033
S02*	AIR-PWR-C	Meanwell	A0	NA	NA	EB46E93226

(*) S02 is support equipment Power supply for EUT S01

4.2 System Details

System #	Description	Samples
1	AIR-AP1832I-B-K9	S01
2	AIR-PWR-C	S02

4.3 Mode of Operation Details

Mode#	Description	Comments
1	Continuous Transmitting	Continuous Transmitting $\geq 98\%$ duty cycle

All measurements were made in accordance with

- ANSI C63.10:2013
- KDB 789033 D02 General UNII Test Procedures New Rules v01r03
- KDB 662911 D01 Multiple Transmitter Output v02r01

Appendix A: Emission Test Results

Conducted Test Setup Diagram

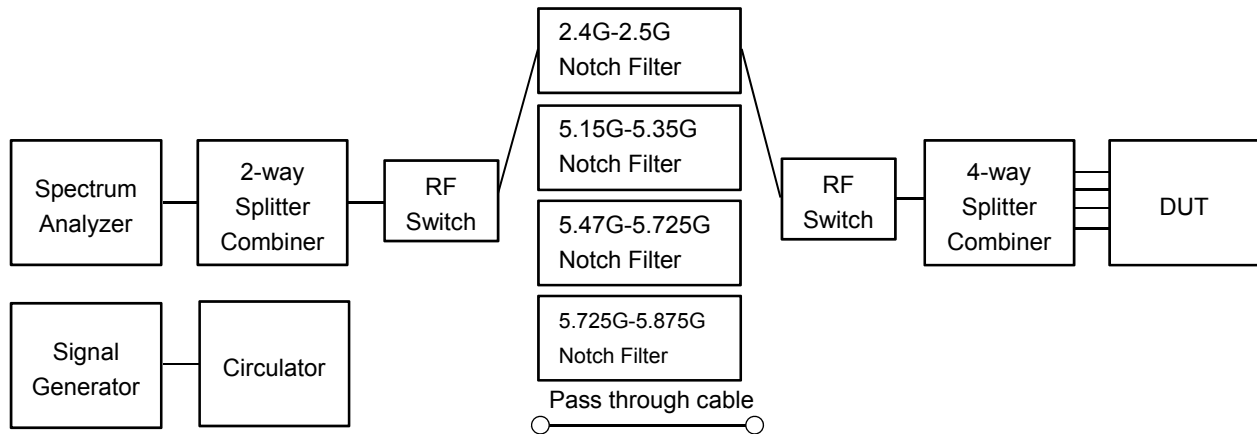

Target Maximum Channel Power

The following table details the maximum supported Total Channel Power for all operating modes.

Operating Mode	Maximum Channel Power (dBm)		
	Frequency (MHz)		
	5500	5560	5660
Non HT20, 6 to 54 Mbps	19	19	19
Non HT20 Beam Forming, 6 to 54 Mbps	19	19	19
HT/VHT20, M0 to M15	21	20	21
HT/VHT20 Beam Forming, M0 to M15	21	20	21
HT/VHT20 STBC, M0 to M7	21	20	21
	5510	5550	5670
Non HT40, 6 to 54 Mbps	19	20	20
HT/VHT40, M0 to M15	19	22	22
HT/VHT40 Beam Forming, M0 to M15	18	22	22
HT/VHT40 STBC, M0 to M7	19	22	22
	5530	5690	
Non HT80, 6 to 54 Mbps	18	22	
VHT80, M0 to M9, M0 to M9 1-1ss	19	22	
VHT80 Beam Forming, M0 to M9, M0 to M9 1-1ss	19	22	
VHT80 STBC, M0 to M9 1ss	19	22	

A.1 99% and 26dB Bandwidth

FCC 15.407 The 99% occupied bandwidth is the frequency bandwidth such that, below its lower and above its upper frequency limits, the mean powers are each equal to 0.5% of the total mean power of the given emission. There is no limit for 99% OBW.

The 26 dB emission is the width of the emission that is constrained by the frequencies associated with the two outermost amplitude points (upper and lower frequencies) that are attenuated by 26 dB relative to the maximum level measured in the fundamental emission.

KDB 644545 D03 v01 section D1b

Band-crossing emissions: For an emission that crosses the boundary between two adjacent U-NII bands, the boundary frequency between the bands serves as one edge for defining the portion of the EBW that falls within a particular U-NII band. However, the -26 dB points are measured relative to the highest point on the contiguous segment—regardless of which band contains that highest point (Figure4).

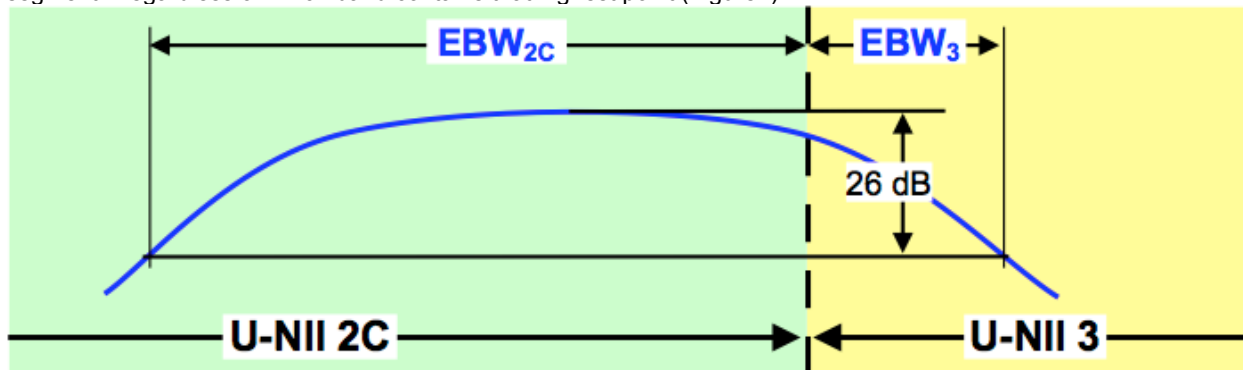

Figure 4. Emission Bandwidth (EBW) within a Band for Band-Crossing Signals

Test Procedure

Ref. ANSI C63.10: 2013 Section 6.9.3

KDB 644545 D03 v01

KDB 789033 D02 General UNII Test Procedures New Rules v01r03

KDB 662911

99% BW and EBW (-26dB)

Test Procedure

1. Set the radio in the continuous transmitting mode.
2. Allow the trace to stabilize.
3. Setting the x-dB bandwidth mode to -26dB and OBW power function to 99% within the measurement set up function.
4. Select the automatic OBW measurement function of an instrument to perform bandwidth measurement.
5. Capture graphs and record pertinent measurement data.

Ref. ANSI C63.10: 2013 Section 6.9.3

99% BW and EBW (-26dB)

Test parameters

X dB BW = -26dB (using the OBW function of the spectrum analyzer)

OBW = 99% (using the OBW function of the spectrum analyzer)

Span = 1.5 x to 5.0 times OBW

RBW = approx. 1% to 5% of the OBW

VBW ≥ 3 x RBW

Detector = Peak or where practical sample shall be used

Trace = Max. Hold



System Number	Description	Samples	System under test	Support equipment
1	EUT	S01	<input checked="" type="checkbox"/>	<input type="checkbox"/>
	Support	S02	<input type="checkbox"/>	<input checked="" type="checkbox"/>

Tested By : Jose Aguirre	Date of testing: 05-May-16 - 06-Jun-16
Test Result : PASS	

See Appendix C for list of test equipment

Frequency (MHz)	Mode	Data Rate (Mbps)	26dB BW (MHz)	99% BW (MHz)
5500	Non HT20, 6 to 54 Mbps	6	21.1	17.254
	HT/VHT20, M0 to M15	m0	21.8	18.148
5510	Non HT40, 6 to 54 Mbps	6	39.7	35.480
	HT/VHT40, M0 to M15	m0	40.8	36.063
5530	Non HT80, 6 to 54 Mbps	6	83.1	75.777
	VHT80, M0 to M9, M0 to M9 1-1ss	m0x1	85.0	76.082
5550	Non HT40, 6 to 54 Mbps	6	39.5	35.425
	HT/VHT40, M0 to M15	m0	40.5	35.978
5560	Non HT20, 6 to 54 Mbps	6	21.1	17.199
	HT/VHT20, M0 to M15	m0	21.6	18.099
5660	Non HT20, 6 to 54 Mbps	6	20.9	17.207
	HT/VHT20, M0 to M15	m0	21.7	18.130
5670	Non HT40, 6 to 54 Mbps	6	39.6	35.456
	HT/VHT40, M0 to M15	m0	40.6	35.986
5690	Non HT80, 6 to 54 Mbps	6	82.3	75.441
	VHT80, M0 to M9, M0 to M9 1-1ss	m0x1	84.4	75.682
5700	Non HT20, 6 to 54 Mbps	6	20.9	17.214
	HT/VHT20, M0 to M15	m0	21.6	18.104
5710	Non HT40, 6 to 54 Mbps	6	39.8	35.400
	HT/VHT40, M0 to M15	m0	40.5	35.940
5720	Non HT20, 6 to 54 Mbps	6	20.9	17.241
	HT/VHT20, M0 to M15	m0	21.8	18.120



26dB / 99% Bandwidth, 5500 MHz, Non HT20, 6 to 54 Mbps

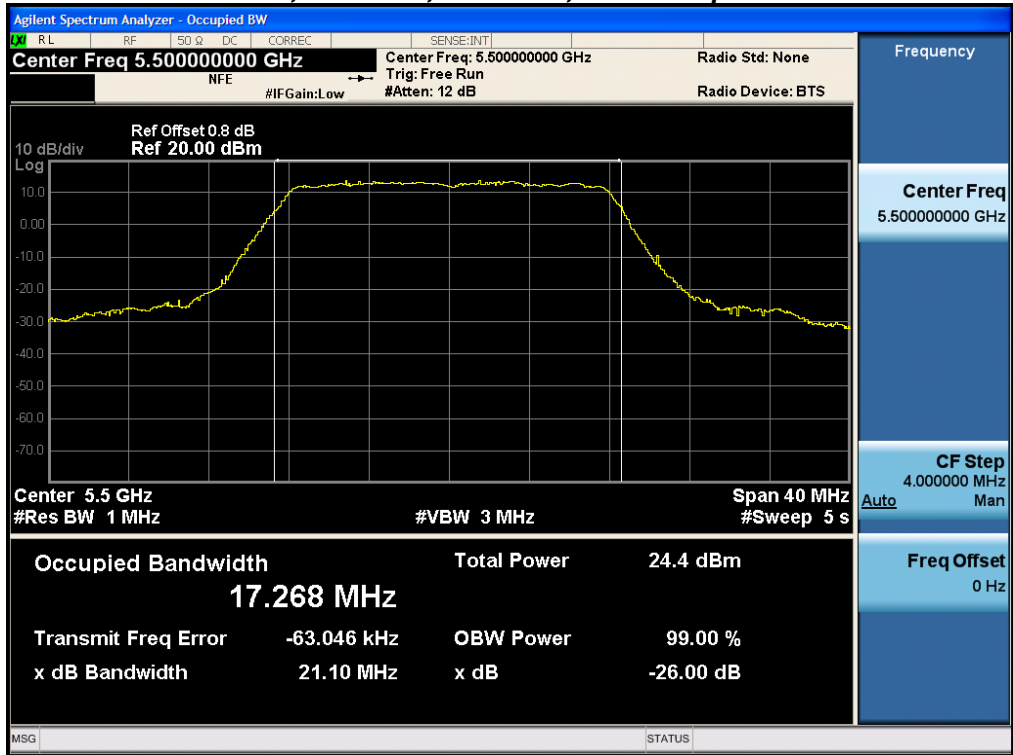

26dB / 99% Bandwidth, 5500 MHz, HT/VHT20, M0 to M15

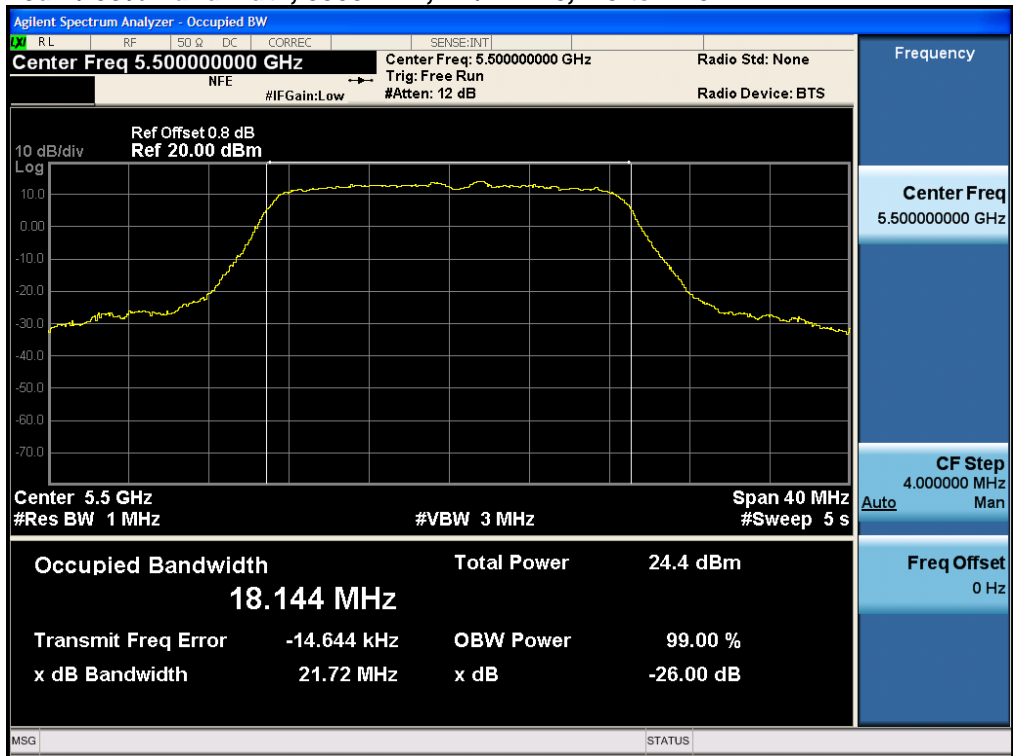



26dB / 99% Bandwidth, 5510 MHz, Non HT40, 6 to 54 Mbps

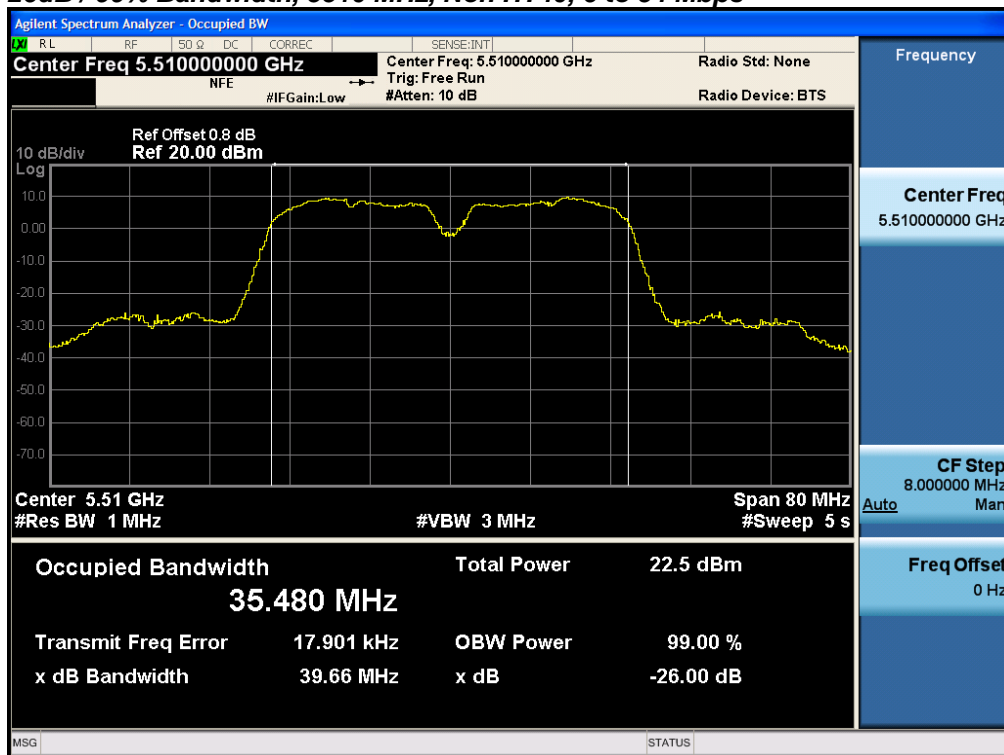

26dB / 99% Bandwidth, 5510 MHz, HT/VHT40, M0 to M15

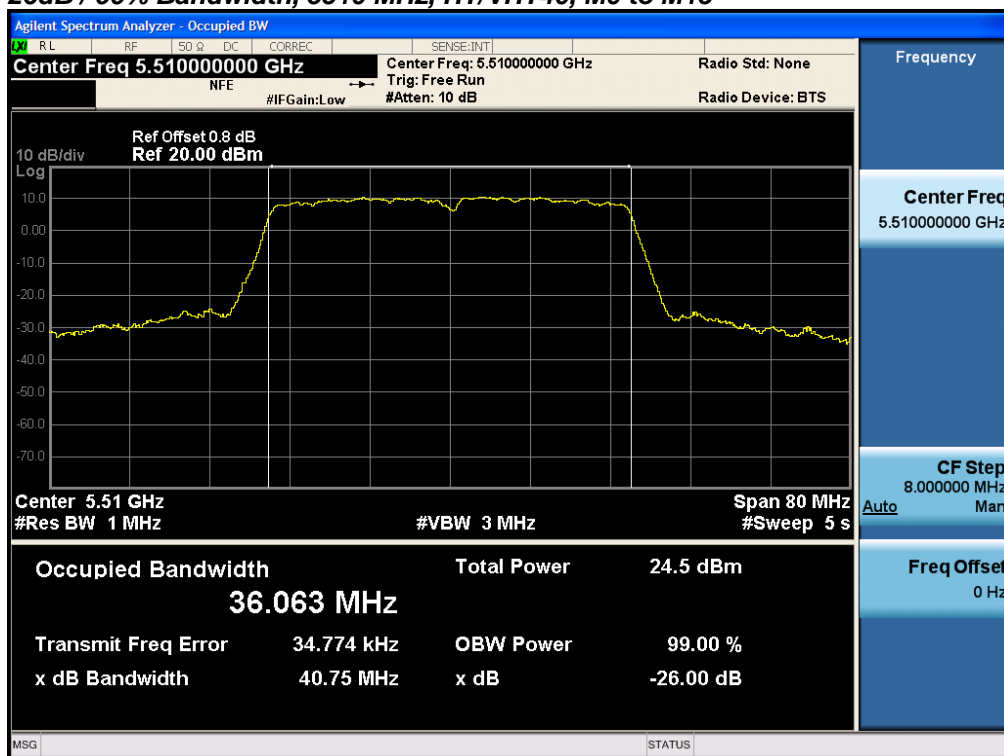



26dB / 99% Bandwidth, 5530 MHz, Non HT80, 6 to 54 Mbps

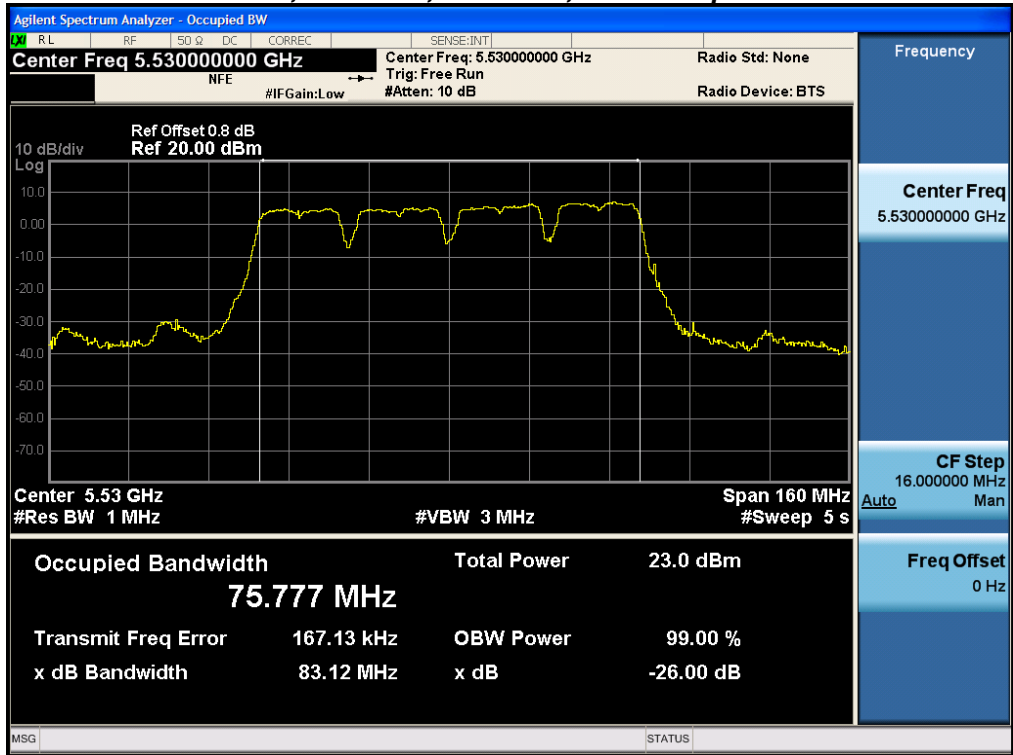

26dB / 99% Bandwidth, 5530 MHz, VHT80, M0 to M9, M0 to M9 1-1ss

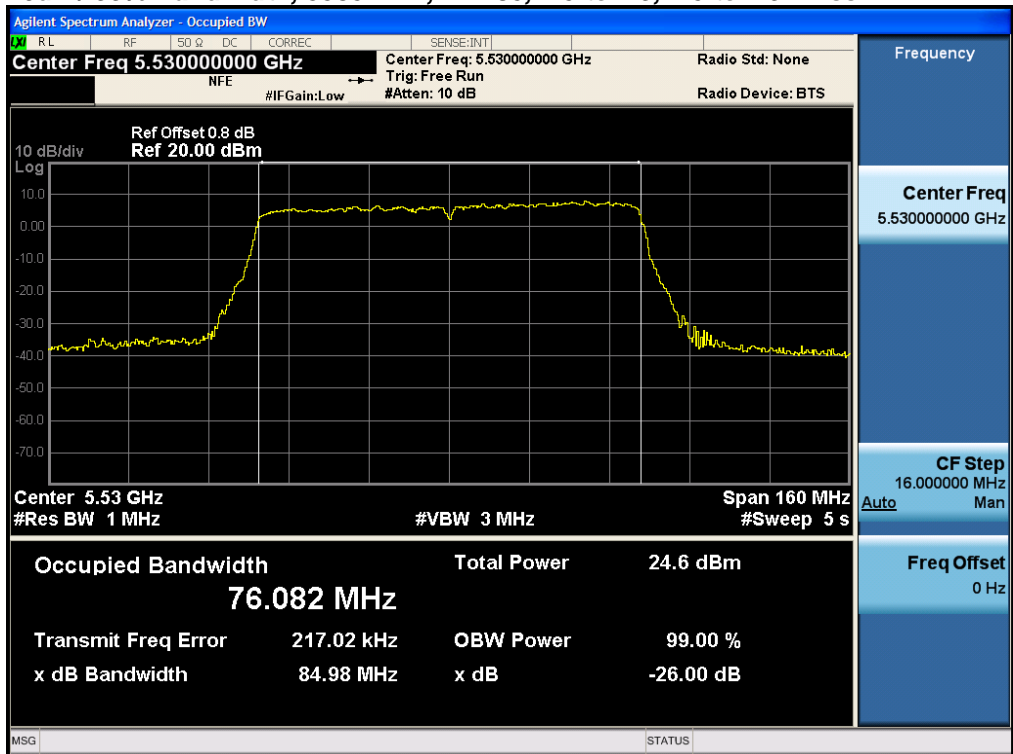



26dB / 99% Bandwidth, 5550 MHz, Non HT40, 6 to 54 Mbps

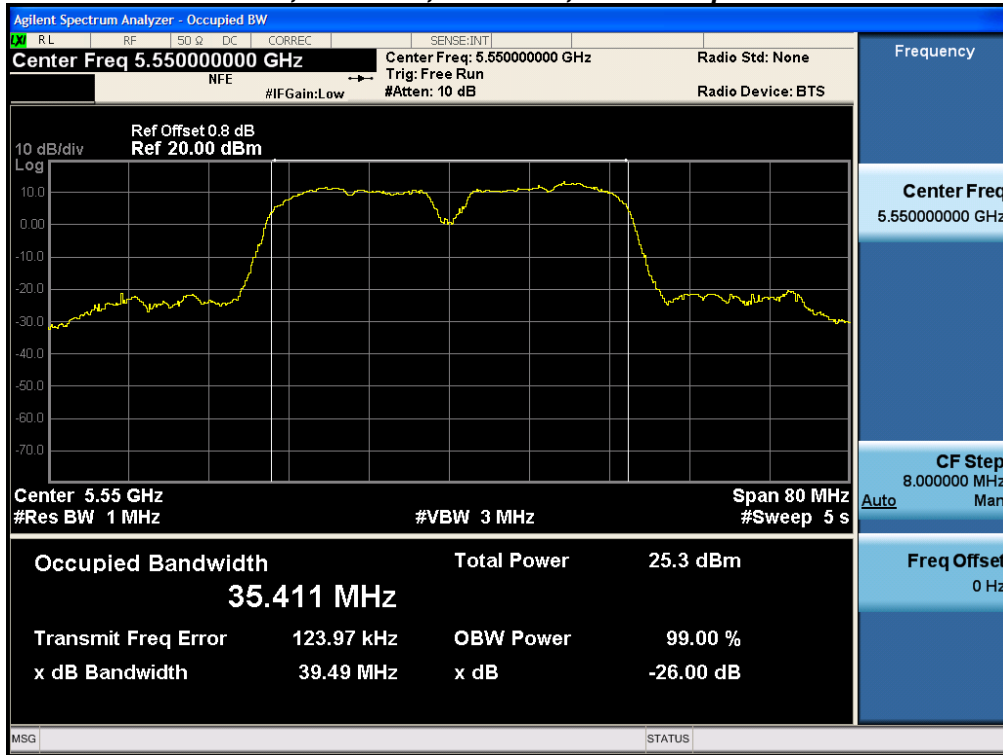

26dB / 99% Bandwidth, 5550 MHz, HT/VHT40, M0 to M15

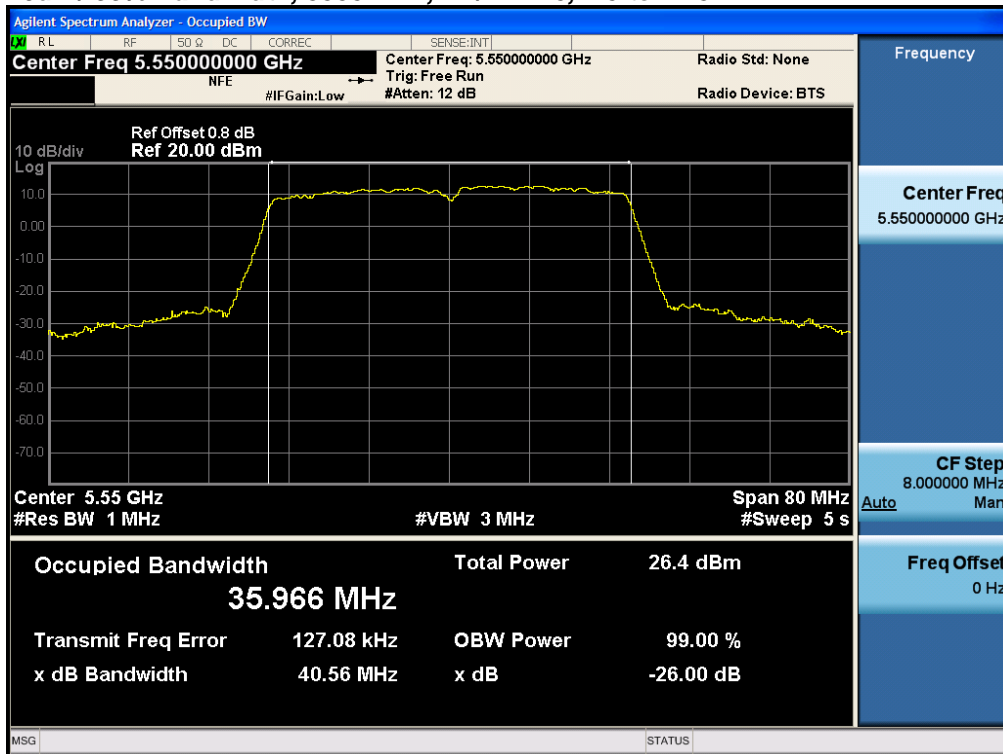



26dB / 99% Bandwidth, 5560 MHz, Non HT20, 6 to 54 Mbps

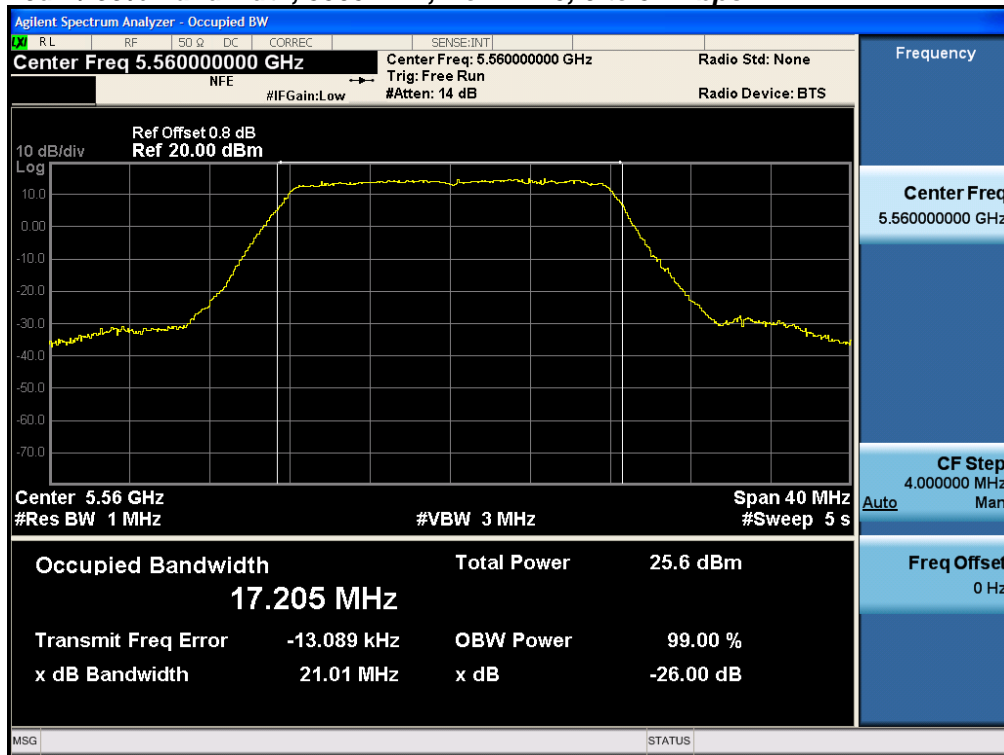

26dB / 99% Bandwidth, 5560 MHz, HT/VHT20, M0 to M15

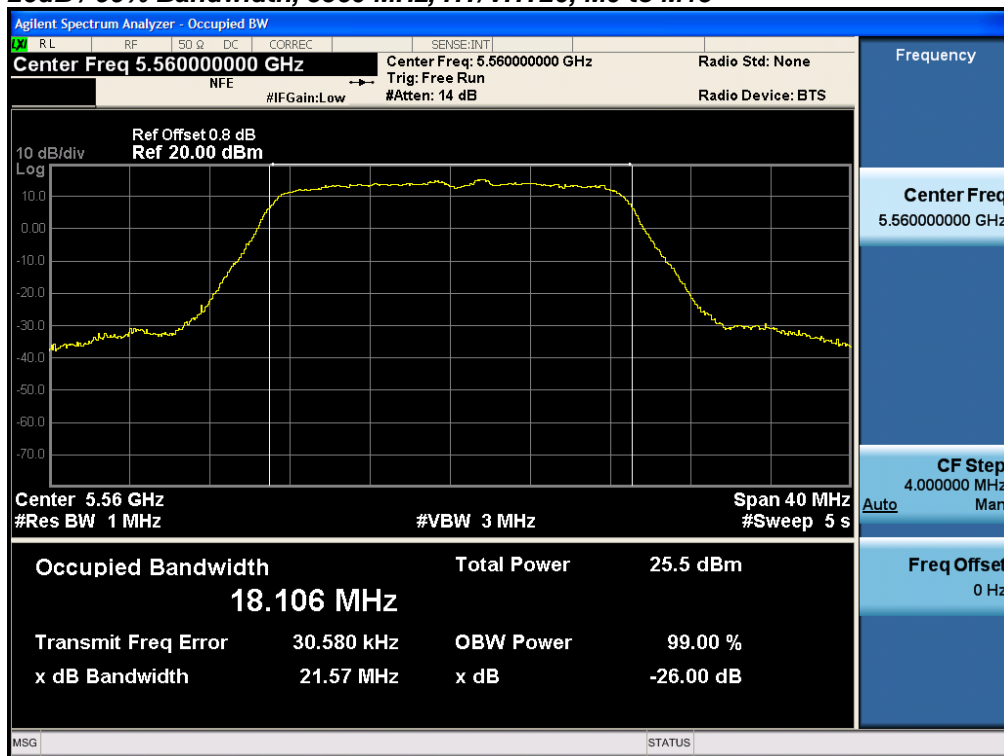



26dB / 99% Bandwidth, 5660 MHz, Non HT20, 6 to 54 Mbps

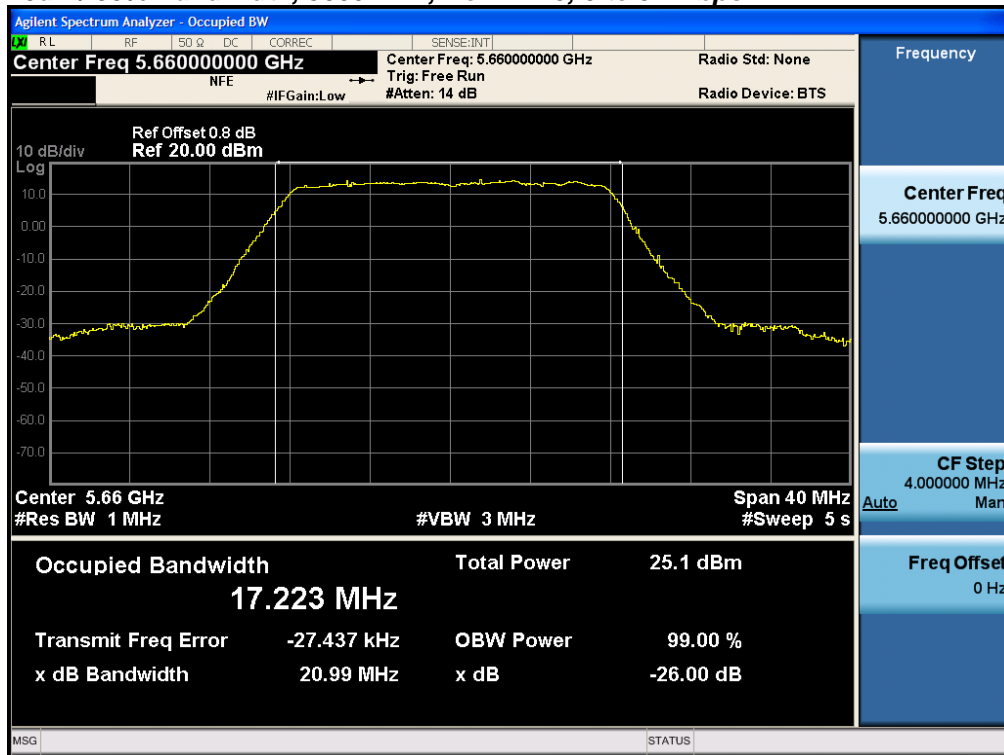

26dB / 99% Bandwidth, 5660 MHz, HT/VHT20, M0 to M15

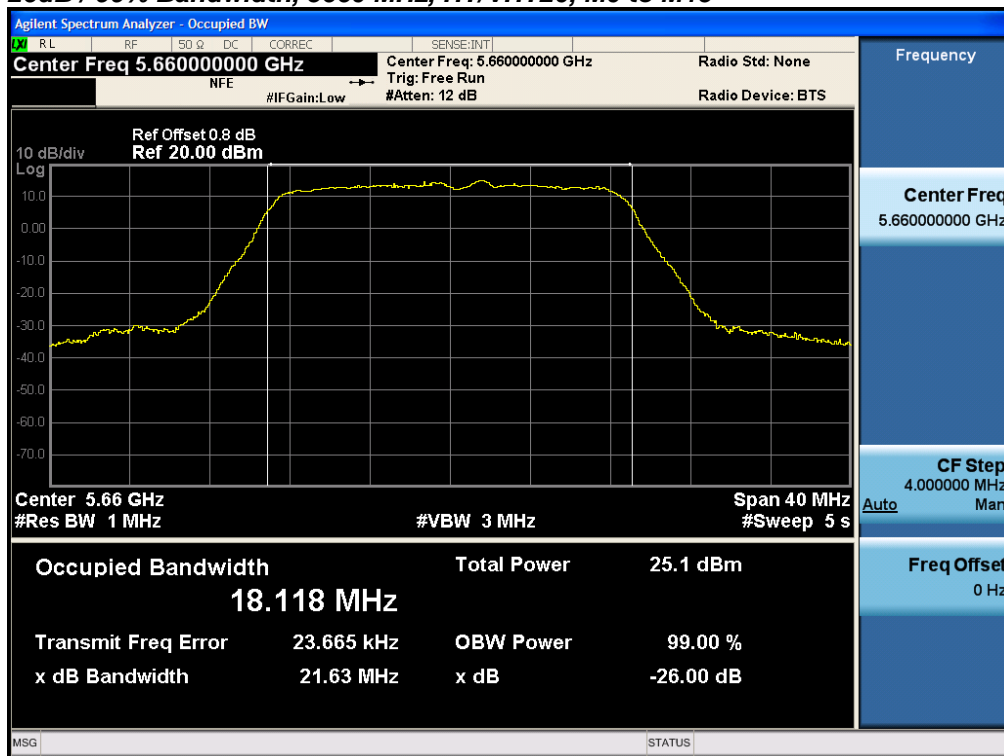



26dB / 99% Bandwidth, 5670 MHz, Non HT40, 6 to 54 Mbps

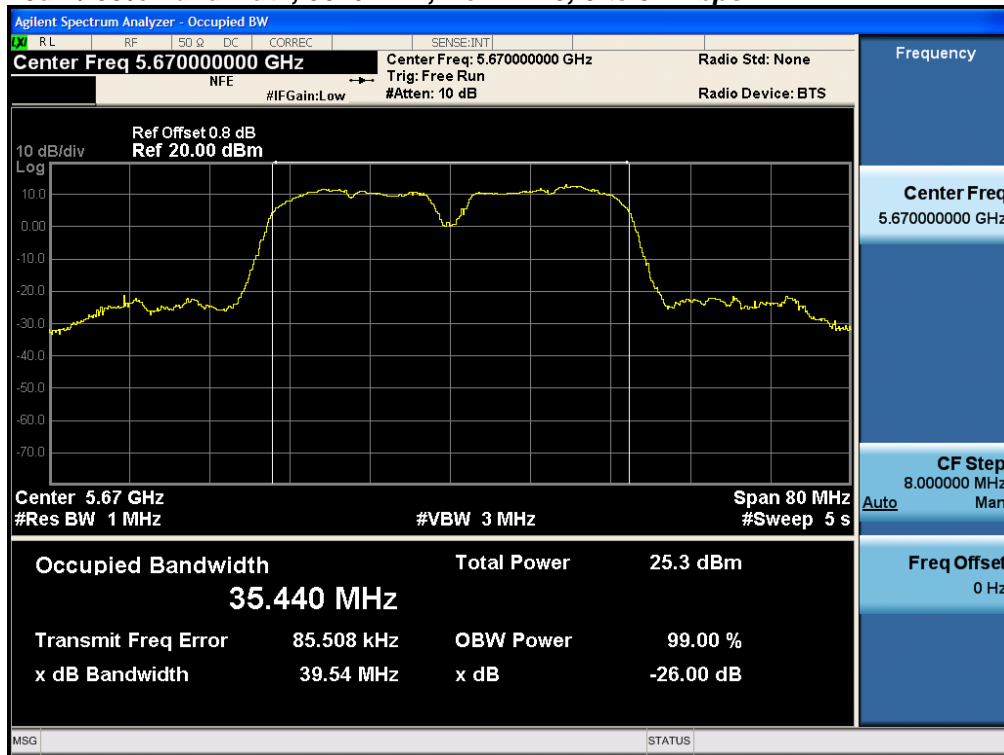

26dB / 99% Bandwidth, 5670 MHz, HT/VHT40, M0 to M15

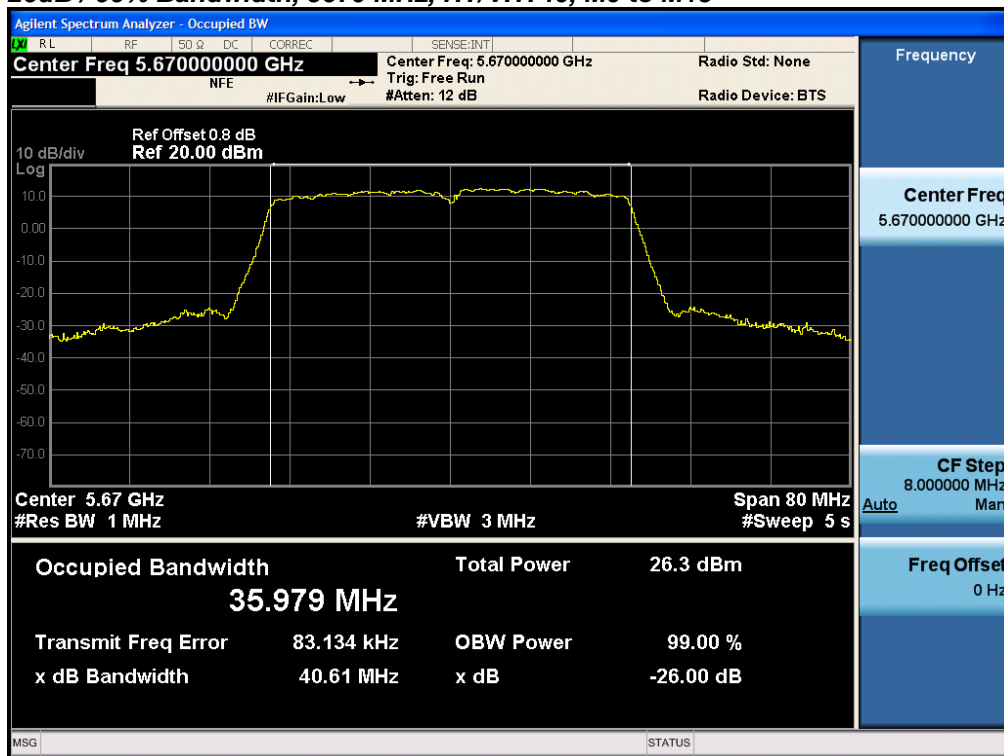



26dB / 99% Bandwidth, 5690 MHz, Non HT80, 6 to 54 Mbps

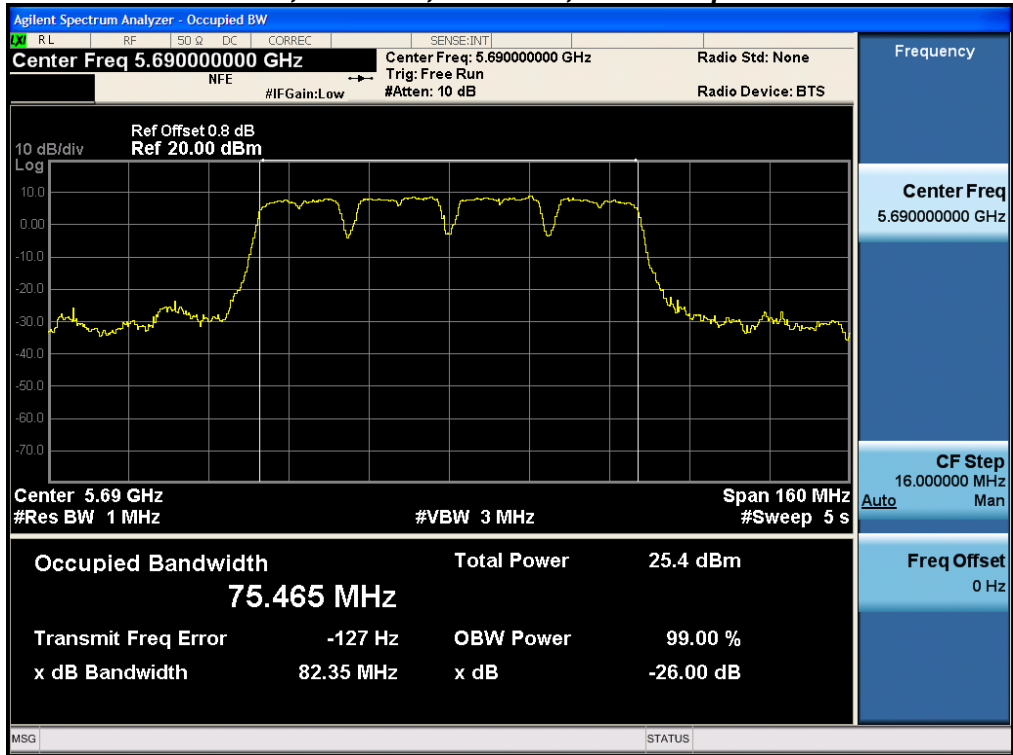

26dB / 99% Bandwidth, 5690 MHz, VHT80, M0 to M9, M0 to M9 1-1ss

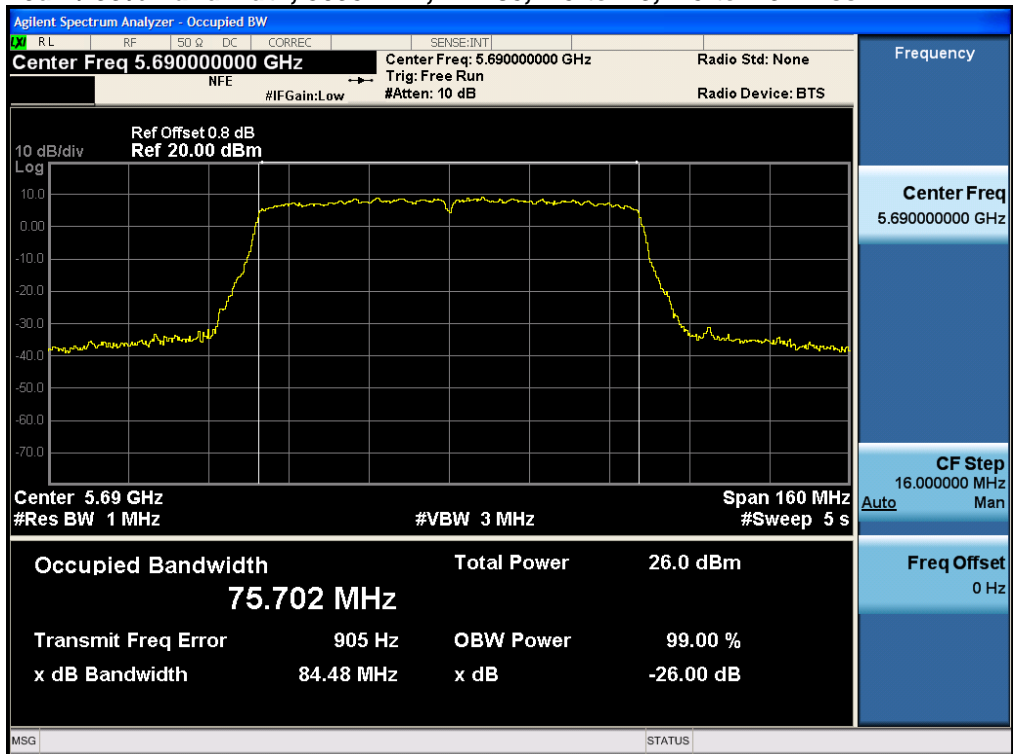



26dB / 99% Bandwidth, 5700 MHz, Non HT20, 6 to 54 Mbps

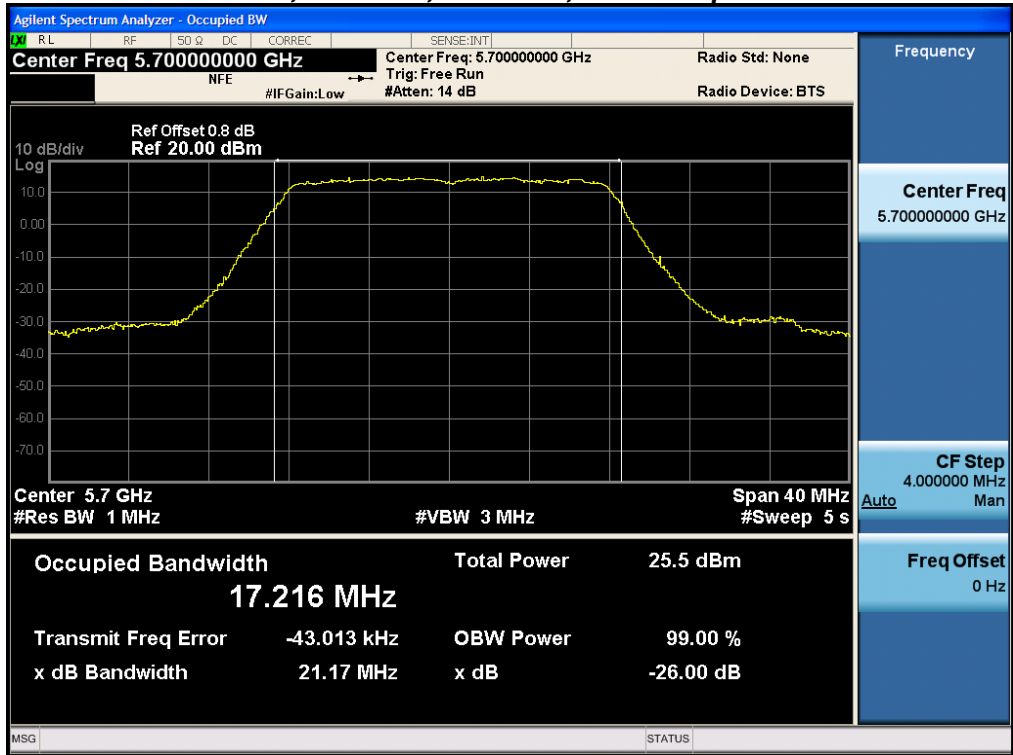

26dB / 99% Bandwidth, 5700 MHz, HT/VHT20, M0 to M15

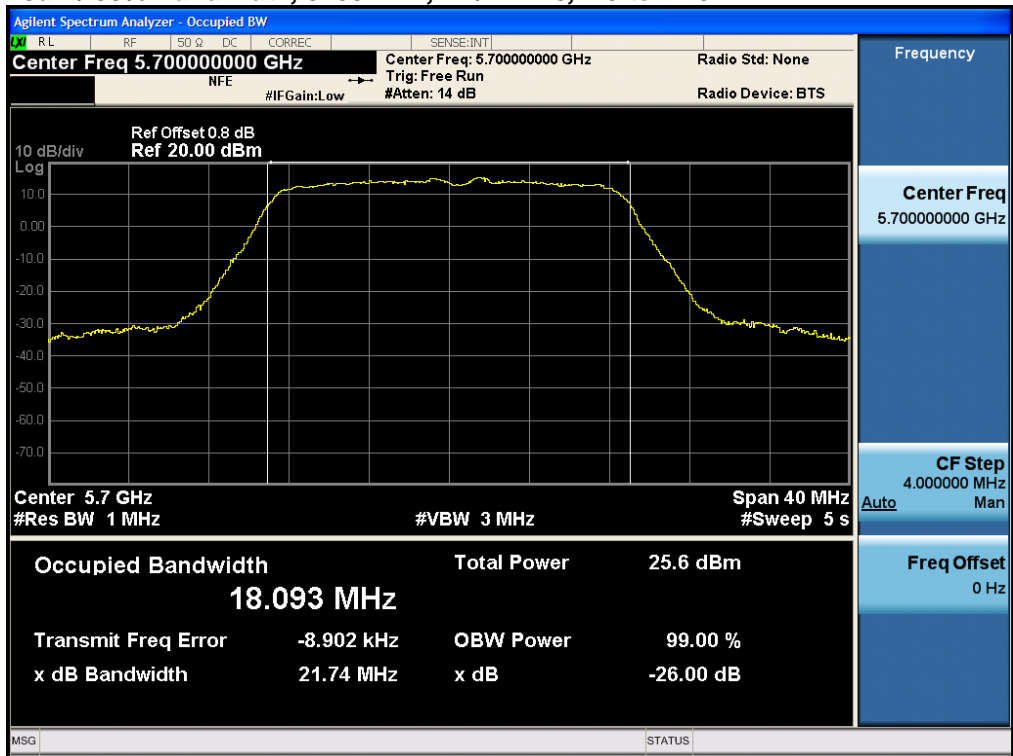



26dB / 99% Bandwidth, 5710 MHz, Non HT40, 6 to 54 Mbps

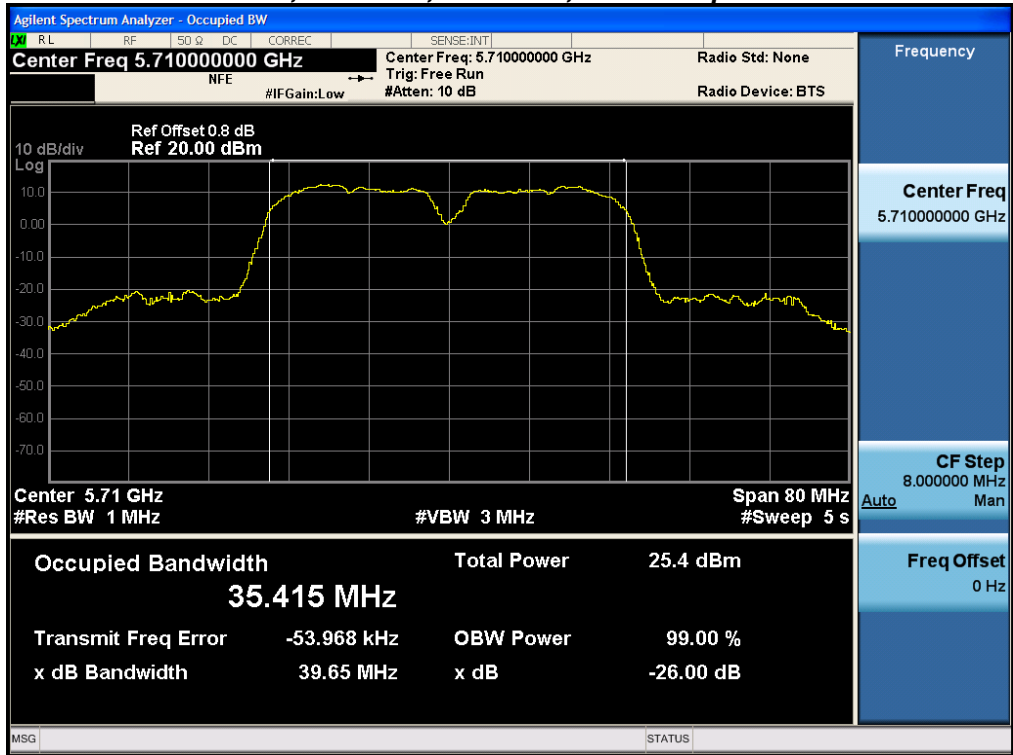

26dB / 99% Bandwidth, 5710 MHz, HT/VHT40, M0 to M15

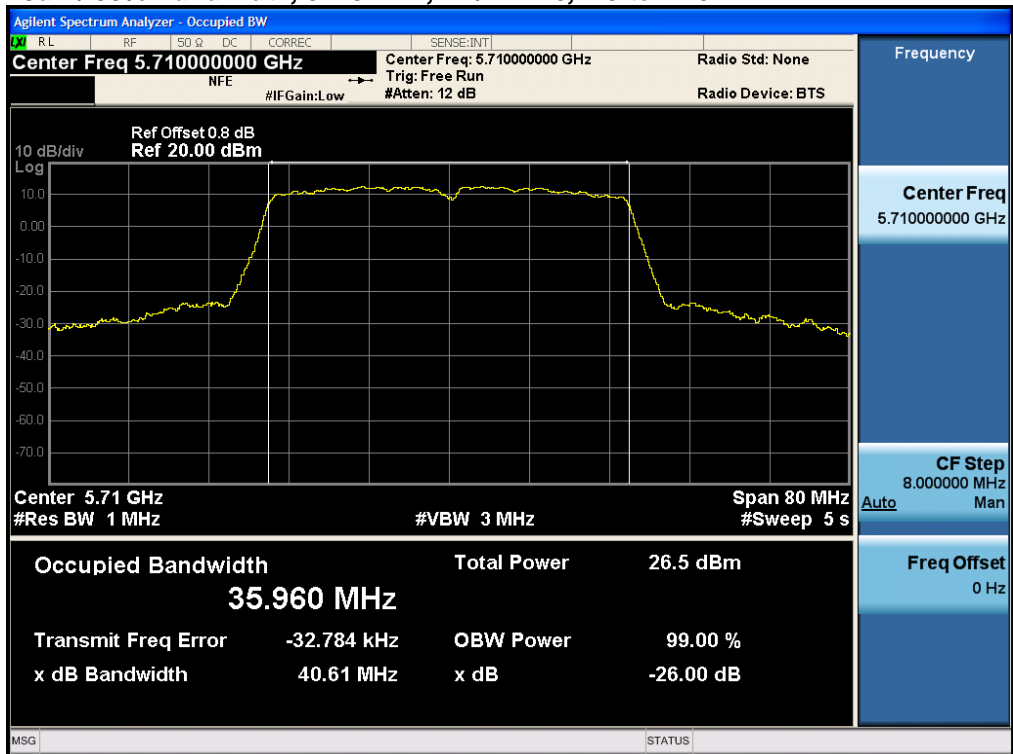



26dB / 99% Bandwidth, 5720 MHz, Non HT20, 6 to 54 Mbps

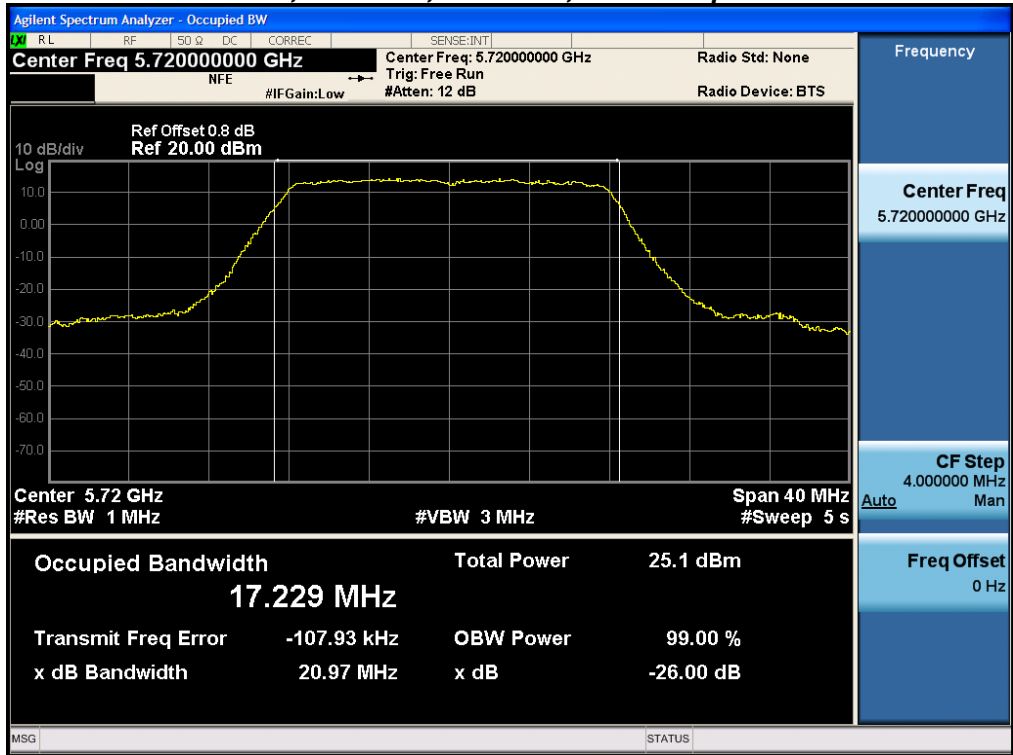

26dB / 99% Bandwidth, 5720 MHz, HT/VHT20, M0 to M15

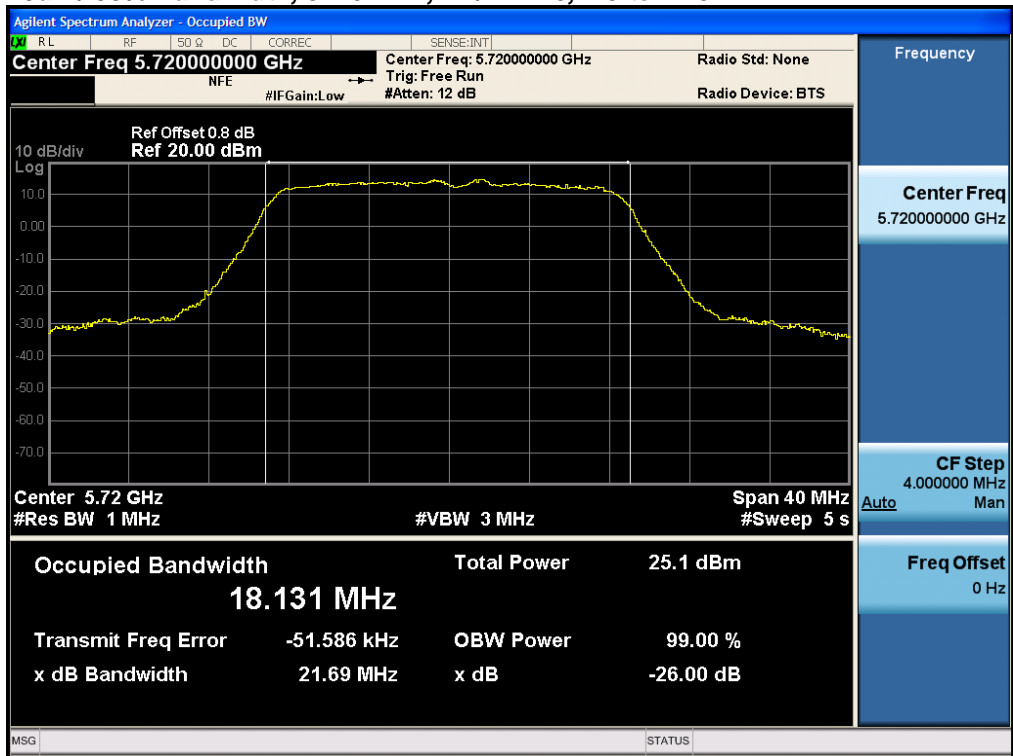

Duty Cycle

EUT transmitting continuously (i.e., with a duty cycle of greater than or equal to 98%)

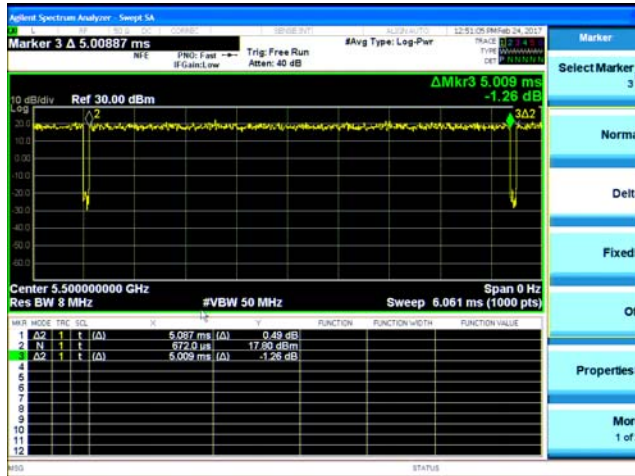

20MHz Channel plan

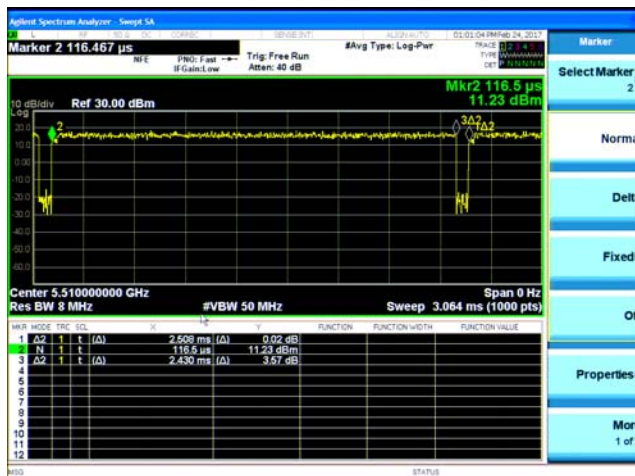

40MHz Channel Plan

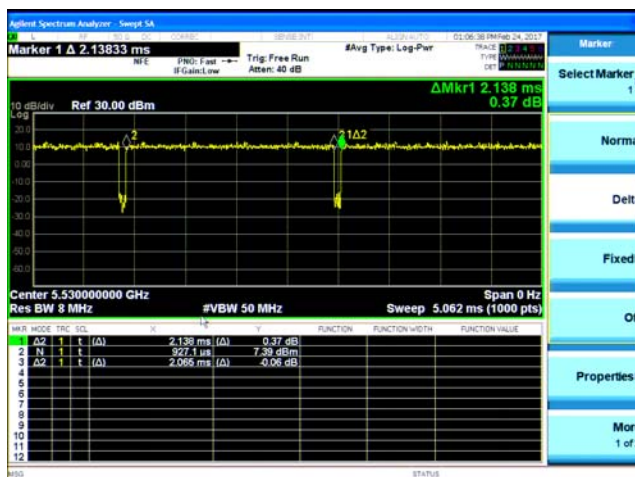

80MHz Channel plan

A.2 Maximum Conducted Output Power/ Power Spectral Density

15.407 (2) For the 5.25-5.35 GHz and 5.47-5.725 GHz bands, the maximum conducted output power over the frequency bands of operation shall not exceed the lesser of 250 mW or $11 \text{ dBm} + 10 \log B$, where B is the 26 dB emission bandwidth in megahertz. In addition, the maximum power spectral density shall not exceed 11 dBm in any 1 megahertz band. If transmitting antennas of directional gain greater than 6 dBi are used, both the maximum conducted output power and the maximum power spectral density shall be reduced by the amount in dB that the directional gain of the antenna exceeds 6 dBi.

15.407 a (3) For the band 5.725-5.85 GHz, the maximum conducted output power over the frequency band of operation shall not exceed 1 W. If transmitting antennas of directional gain greater than 6 dBi are used, both the maximum conducted output power and the maximum power spectral density shall be reduced by the amount in dB that the directional gain of the antenna exceeds 6 dBi. However, fixed point-to-point U-NII devices operating in this band may employ transmitting antennas with directional gain greater than 6 dBi without any corresponding reduction in transmitter conducted power. Fixed, point-to-point operations exclude the use of point-to-multipoint systems, omnidirectional applications, and multiple collocated transmitters transmitting the same information. The operator of the U-NII device, or if the equipment is professionally installed, the installer, is responsible for ensuring that systems employing high gain directional antennas are used exclusively for fixed, point-to-point operations.

The power spectral density shall not exceed 30 dBm in any 500 kHz band. If transmitting antennas of directional gain greater than 6 dBi are used, both the maximum conducted output power and the power spectral density shall be reduced by the amount in dB that the directional gain of the antenna exceeds 6 dBi.

KDB 644545 D03 (section F.2.b.ii)

When measuring the portion of the maximum conducted output power within a single U-NII band, the power shall be integrated across only the portion of the EBW that falls within that band. That is, if an EBW extends across the boundary between two adjacent bands, the boundary frequency between the bands serves as one edge of the frequency range to be integrated. Integration across an entire U-NII band without regard to 26 dB points is also acceptable for determining conducted output power within that band.

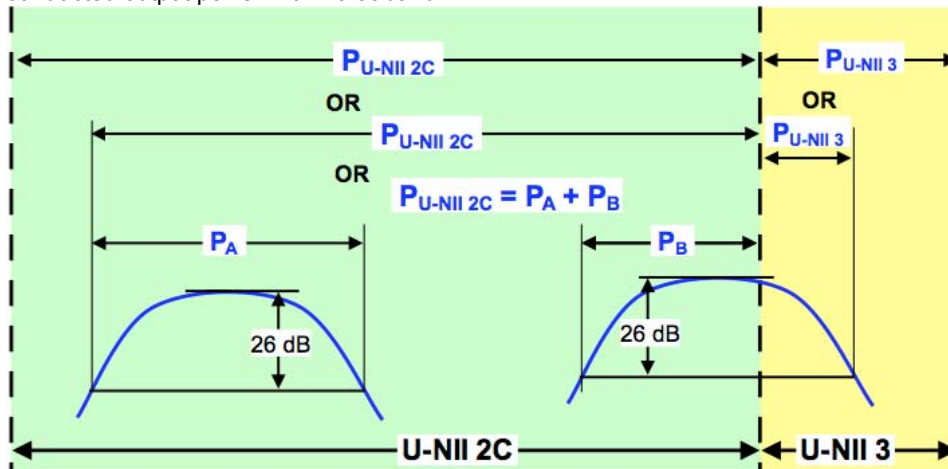

Conducted output power within a U-NII band: Integrate over the band, or integrate over a span including the 26 dB EBWs of transmission segments within the band, or integrate over 26 dB EBW of each transmission segment in the band and sum.

Figure 5. Conducted Output Power Measurement Examples

Note:

The Intentional Beamforming correlated array gain for any number of space time streams is given by the general formula:

$$G_{bf_max} = 10 * \log_{10}(N_{tx}/N_{sts})$$

where N_{tx} is the number of equal power active transmit antennas and N_{sts} is the number of active space time streams.

The maximum unintentional correlation gain (G_{max}) can be shown to be less than or equal to

$$G_{max} = 10 * \log_{10}(N_{tx}/N_{sts})$$

for all points in space, where N_{tx} is the number of active transmit antennas and N_{sts} is the number of space time streams. This formulation is general and can be applied to all non-beamforming modes.

Whenever the number of space-time streams (N_{sts}) is equal to the number of active transmitters (N_{tx}) the spatial expansion is the Identity matrix and therefore the streams are independently sent by each antenna. For these modes the correlation gain will be zero.

The “measure-and-sum technique” is used for measuring in-band transmit power of a device. In the measure-and-sum approach, the conducted emission level is measured at each antenna port. The measured results at the various antenna ports are then summed mathematically to determine the total emission level from the device. Summing is performed in linear power units. (ANSI C63.10: 2013, section 14.3.2.2)

Test Procedure

Ref. KDB 789033 D02 General UNII Test Procedures New Rules v01r03
ANSI C63.10: 2013
KDB 644545 D03 v01

Output Power Test Procedure
<ol style="list-style-type: none"> 1. Set the radio in the continuous transmitting mode at full power 2. Compute power by integrating the spectrum across the EBW (or alternatively entire 99% OBW) of the signal using the instrument’s band power measurement function. The integration shall be performed using the spectrum analyzer band-power measurement function with band limits set equal to the EBW or the OBW band edges. 3. Capture graphs and record pertinent measurement data.

Ref. KDB 789033 D02 General UNII Test Procedures New Rules v01r03
ANSI C63.10: 2013 section 12.3.2.2 Method SA-1

Output Power Test parameters
Span = >1.5 times the OBW RBW = 1MHz VBW ≥ 3 x RBW Sweep = Auto couple Detector = sample Trace = Trace Average 100

The “measure-and-sum technique” is used for measuring in-band transmit power of a device. In the measure-and-sum approach, the conducted emission level is measured at each antenna port. The measured results at the various antenna ports are then summed mathematically to determine the total emission level from the device. Summing is performed in linear power units. (See ANSI C63.10 section 14.3.2.2)

Power Spectral Density (UNII 2C band)	Power Spectral Density (UNII 3 band)
Test parameters ANSI C63.10: 2013 , sec12.3.2.2 Method SA-1	Test parameters KDB 789033 D02 v01 section F.5
Span = >1.5 times the OBW RBW = 1MHz VBW ≥ 3 x RBW Sweep = Auto couple Detector = Sample Trace = Trace Average 100 Marker = Peak Search	Span = >1.5 times the OBW RBW = 500 kHz. VBW ≥ 3 x RBW Sweep = 10s Detector = Peak Trace = Single Sweep Marker = Peak Search



The "Measure and add 10 log(N) dB technique", where N is the number of outputs, is used for measuring in-band Power Spectral Density. With this technique, spectrum measurements are performed at each output of the device, and the quantity 10 log(4) (or 6dB) is added to the worst case spectrum value before comparing to the emission limit. (ANSI C63.10 2013 section 14.3.2.3)

System Number	Description	Samples	System under test	Support equipment
1	EUT	S01	<input checked="" type="checkbox"/>	<input type="checkbox"/>
	Support	S02	<input type="checkbox"/>	<input checked="" type="checkbox"/>

Tested By : Jose Aguirre	Date of testing: 05-May-16 - 06-Jun-16
Test Result : PASS	

See Appendix C for list of test equipment



Rather Than Measure:

- The portion of the signal in the UNII-2C Band , 250 mW or 11 dBm+ 10 log B power / 11dBm/MHz PSD
- The portion of the signal in the UNII-3 Band , 36dBm EIRP power / 30dBm/500kHz PSD

If the band crossing waveforms are typical , then doing the calculations across the full signal bandwidth and comparing it to the lower (UNII-2C) limit should meet our requirements. The only time the band crossing waveforms need to do individual calculations is when they can not meet the more restrictive limit

Maximum Output Power

Frequency (MHz)	Mode	Tx Paths	Correlated Antenna Gain (dBi)	Tx 1 Max Power (dBm)	Tx 2 Max Power (dBm)	Tx 3 Max Power (dBm)	Total Tx Channel Power (dBm)	Limit (dBm)	Margin (dB)
5500	Non HT20, 6 to 54 Mbps	1	5	15.9			15.9	23.4	7.5
	Non HT20, 6 to 54 Mbps	2	5	15.9	15.6		18.8	23.4	4.6
	Non HT20, 6 to 54 Mbps	3	5	12.1	11.5	12.6	16.9	23.4	6.5
	Non HT20 Beam Forming, 6 to 54 Mbps	2	8	15.9	15.6		18.8	21.4	2.6
	Non HT20 Beam Forming, 6 to 54 Mbps	3	10	12.1	11.5	12.6	16.9	19.4	2.5
	HT/VHT20, M0 to M7	1	5	15.6			15.6	23.6	8.0
	HT/VHT20, M0 to M7	2	5	15.6	15.3		18.5	23.6	5.1
	HT/VHT20, M8 to M15	2	5	15.6	15.3		18.5	23.6	5.1
	HT/VHT20, M0 to M7	3	5	12.7	12.3	13.4	17.6	23.6	6.0
	HT/VHT20, M8 to M15	3	5	15.6	15.3	16.4	20.6	23.6	3.0
	HT/VHT20 Beam Forming, M0 to M7	2	8	15.6	15.3		18.5	21.6	3.1
	HT/VHT20 Beam Forming, M8 to M15	2	5	15.6	15.3		18.5	23.6	5.1
	HT/VHT20 Beam Forming, M0 to M7	3	10	12.7	12.3	13.4	17.6	19.6	2.0
	HT/VHT20 Beam Forming, M8 to M15	3	7	15.6	15.3	16.4	20.6	22.6	2.0
	HT/VHT20 STBC, M0 to M7	2	5	15.6	15.3		18.5	23.6	5.1
HT/VHT20 STBC, M0 to M7	3	5	15.6	15.3	16.4	20.6	23.6	3.0	
5510	Non HT40, 6 to 54 Mbps	1	5	14.1			14.1	24.0	9.9
	Non HT40, 6 to 54 Mbps	2	5	14.1	13.6		16.9	24.0	7.1
	Non HT40, 6 to 54 Mbps	3	5	13.1	12.6	13.7	17.9	24.0	6.1
	HT/VHT40, M0 to M7	1	5	15.6			15.6	24.0	8.4
	HT/VHT40, M0 to M7	2	5	14.6	14.1		17.4	24.0	6.6
	HT/VHT40, M8 to M15	2	5	14.6	14.1		17.4	24.0	6.6
	HT/VHT40, M0 to M7	3	5	13.7	13.1	14.2	18.5	24.0	5.5
	HT/VHT40, M8 to M15	3	5	13.7	13.1	14.2	18.5	24.0	5.5
	HT/VHT40 Beam Forming, M0 to M7	2	8	13.7	13.1		16.4	22.0	5.6
	HT/VHT40 Beam Forming, M8 to M15	2	5	14.6	14.1		17.4	24.0	6.6
	HT/VHT40 Beam Forming, M0 to M7	3	10	10.6	10.0	10.9	15.3	20.0	4.7
	HT/VHT40 Beam Forming, M8 to M15	3	7	12.7	12.1	13.1	17.4	23.0	5.6
	HT/VHT40 STBC, M0 to M7	2	5	14.6	14.1		17.4	24.0	6.6
	HT/VHT40 STBC, M0 to M7	3	5	13.7	13.1	14.2	18.5	24.0	5.5

5530	Non HT80, 6 to 54 Mbps	1	5	14.7			14.7	24.0	9.3
	Non HT80, 6 to 54 Mbps	2	5	14.7	14.0		17.4	24.0	6.6
	Non HT80, 6 to 54 Mbps	3	5	12.7	11.9	12.8	17.3	24.0	6.7
	VHT80, M0 to M9 1ss	1	5	15.1			15.1	24.0	8.9
	VHT80, M0 to M9 1ss	2	5	15.1	14.5		17.8	24.0	6.2
	VHT80, M0 to M9 2ss	2	5	15.1	14.5		17.8	24.0	6.2
	VHT80, M0 to M9 1ss	3	5	14.1	13.5	14.4	18.8	24.0	5.2
	VHT80, M0 to M9 2ss	3	5	14.1	13.5	14.4	18.8	24.0	5.2
	VHT80 Beam Forming, M0 to M9 1ss	2	8	14.1	13.5		16.8	22.0	5.2
	VHT80 Beam Forming, M0 to M9 2ss	2	5	15.1	14.5		17.8	24.0	6.2
	VHT80 Beam Forming, M0 to M9 1ss	3	10	10.1	9.5	10.1	14.7	20.0	5.3
	VHT80 Beam Forming, M0 to M9 2ss	3	7	12.2	11.4	12.3	16.8	23.0	6.2
	VHT80 STBC, M0 to M9 1ss	2	5	15.1	14.5		17.8	24.0	6.2
	VHT80 STBC, M0 to M9 1ss	3	5	14.1	13.5	14.4	18.8	24.0	5.2
5550	Non HT40, 6 to 54 Mbps	1	5	17.1			17.1	24.0	6.9
	Non HT40, 6 to 54 Mbps	2	5	17.1	16.5		19.8	24.0	4.2
	Non HT40, 6 to 54 Mbps	3	5	14.0	13.4	14.2	18.7	24.0	5.3
	HT/VHT40, M0 to M7	1	5	17.6			17.6	24.0	6.4
	HT/VHT40, M0 to M7	2	5	17.6	17.0		20.3	24.0	3.7
	HT/VHT40, M8 to M15	2	5	17.6	17.0		20.3	24.0	3.7
	HT/VHT40, M0 to M7	3	5	15.6	14.9	15.8	20.2	24.0	3.8
	HT/VHT40, M8 to M15	3	5	17.6	17.0	17.7	22.2	24.0	1.8
	HT/VHT40 Beam Forming, M0 to M7	2	8	17.6	17.0		20.3	22.0	1.7
	HT/VHT40 Beam Forming, M8 to M15	2	5	17.6	17.0		20.3	24.0	3.7
	HT/VHT40 Beam Forming, M0 to M7	3	10	14.5	13.9	14.7	19.2	20.0	0.8
	HT/VHT40 Beam Forming, M8 to M15	3	7	17.6	17.0	17.7	22.2	23.0	0.8
	HT/VHT40 STBC, M0 to M7	2	5	17.6	17.0		20.3	24.0	3.7
	HT/VHT40 STBC, M0 to M7	3	5	17.6	17.0	17.7	22.2	24.0	1.8
5560	Non HT20, 6 to 54 Mbps	1	5	17.1			17.1	23.4	6.3
	Non HT20, 6 to 54 Mbps	2	5	16.1	15.5		18.8	23.4	4.6
	Non HT20, 6 to 54 Mbps	3	5	12.1	11.4	12.1	16.7	23.4	6.7
	Non HT20 Beam Forming, 6 to 54 Mbps	2	8	16.1	15.5		18.8	21.4	2.6
	Non HT20 Beam Forming, 6 to 54 Mbps	3	10	12.1	11.4	12.1	16.7	19.4	2.7
	HT/VHT20, M0 to M7	1	5	16.8			16.8	23.6	6.8
	HT/VHT20, M0 to M7	2	5	16.8	16.3		19.6	23.6	4.0
	HT/VHT20, M8 to M15	2	5	16.8	16.3		19.6	23.6	4.0
	HT/VHT20, M0 to M7	3	5	12.9	12.2	13.0	17.5	23.6	6.1
	HT/VHT20, M8 to M15	3	5	15.8	15.2	16.0	20.5	23.6	3.1
	HT/VHT20 Beam Forming, M0 to M7	2	8	16.8	16.3		19.6	21.6	2.0
	HT/VHT20 Beam Forming, M8 to M15	2	5	16.8	16.3		19.6	23.6	4.0
	HT/VHT20 Beam Forming, M0 to M7	3	10	12.9	12.2	13.0	17.5	19.6	2.1

	HT/VHT20 Beam Forming, M8 to M15	3	7	15.8	15.2	16.0	20.5	22.6	2.1
	HT/VHT20 STBC, M0 to M7	2	5	16.8	16.3		19.6	23.6	4.0
	HT/VHT20 STBC, M0 to M7	3	5	15.8	15.2	16.0	20.5	23.6	3.1
5660	Non HT20, 6 to 54 Mbps	1	5	16.8			16.8	23.4	6.6
	Non HT20, 6 to 54 Mbps	2	5	16.8	15.9		19.4	23.4	4.0
	Non HT20, 6 to 54 Mbps	3	5	12.7	11.9	13.1	17.4	23.4	6.0
	Non HT20 Beam Forming, 6 to 54 Mbps	2	8	16.8	15.9		19.4	21.4	2.0
	Non HT20 Beam Forming, 6 to 54 Mbps	3	10	12.7	11.9	13.1	17.4	19.4	2.0
	HT/VHT20, M0 to M7	1	5	16.4			16.4	23.6	7.2
	HT/VHT20, M0 to M7	2	5	16.4	15.6		19.0	23.6	4.6
	HT/VHT20, M8 to M15	2	5	16.4	15.6		19.0	23.6	4.6
	HT/VHT20, M0 to M7	3	5	12.4	11.5	12.7	17.0	23.6	6.6
	HT/VHT20, M8 to M15	3	5	16.4	15.6	16.8	21.1	23.6	2.5
	HT/VHT20 Beam Forming, M0 to M7	2	8	16.4	15.6		19.0	21.6	2.6
	HT/VHT20 Beam Forming, M8 to M15	2	5	16.4	15.6		19.0	23.6	4.6
	HT/VHT20 Beam Forming, M0 to M7	3	10	12.4	11.5	12.7	17.0	19.6	2.6
	HT/VHT20 Beam Forming, M8 to M15	3	7	16.4	15.6	16.8	21.1	22.6	1.5
	HT/VHT20 STBC, M0 to M7	2	5	16.4	15.6		19.0	23.6	4.6
HT/VHT20 STBC, M0 to M7	3	5	16.4	15.6	16.8	21.1	23.6	2.5	
5670	Non HT40, 6 to 54 Mbps	1	5	17.0			17.0	24.0	7.0
	Non HT40, 6 to 54 Mbps	2	5	17.0	16.4		19.7	24.0	4.3
	Non HT40, 6 to 54 Mbps	3	5	14.0	13.3	14.6	18.8	24.0	5.2
	HT/VHT40, M0 to M7	1	5	17.4			17.4	24.0	6.6
	HT/VHT40, M0 to M7	2	5	17.4	16.8		20.1	24.0	3.9
	HT/VHT40, M8 to M15	2	5	17.4	16.8		20.1	24.0	3.9
	HT/VHT40, M0 to M7	3	5	15.5	14.8	16.1	20.3	24.0	3.7
	HT/VHT40, M8 to M15	3	5	17.4	16.8	18.1	22.2	24.0	1.8
	HT/VHT40 Beam Forming, M0 to M7	2	8	17.4	16.8		20.1	22.0	1.9
	HT/VHT40 Beam Forming, M8 to M15	2	5	17.4	16.8		20.1	24.0	3.9
	HT/VHT40 Beam Forming, M0 to M7	3	10	14.5	13.7	15.1	19.2	20.0	0.8
	HT/VHT40 Beam Forming, M8 to M15	3	7	17.4	16.8	18.1	22.2	23.0	0.8
	HT/VHT40 STBC, M0 to M7	2	5	17.4	16.8		20.1	24.0	3.9
HT/VHT40 STBC, M0 to M7	3	5	17.4	16.8	18.1	22.2	24.0	1.8	
5690	Non HT80, 6 to 54 Mbps	1	5	17.2			17.2	24.0	6.8
	Non HT80, 6 to 54 Mbps	2	5	17.2	17.0		20.1	24.0	3.9
	Non HT80, 6 to 54 Mbps	3	5	17.2	17.0	17.9	22.2	24.0	1.8
	VHT80, M0 to M9 1ss	1	5	16.7			16.7	24.0	7.3
	VHT80, M0 to M9 1ss	2	5	16.7	16.4		19.6	24.0	4.4
	VHT80, M0 to M9 2ss	2	5	16.7	16.4		19.6	24.0	4.4
	VHT80, M0 to M9 1ss	3	5	16.7	16.4	17.5	21.7	24.0	2.3

	VHT80, M0 to M9 2ss	3	5	16.7	16.4	17.5	21.7	24.0	2.3
	VHT80 Beam Forming, M0 to M9 1ss	2	8	16.7	16.4		19.6	22.0	2.4
	VHT80 Beam Forming, M0 to M9 2ss	2	5	16.7	16.4		19.6	24.0	4.4
	VHT80 Beam Forming, M0 to M9 1ss	3	10	14.7	14.3	15.4	19.6	20.0	0.4
	VHT80 Beam Forming, M0 to M9 2ss	3	7	16.7	16.4	17.5	21.7	23.0	1.3
	VHT80 STBC, M0 to M9 1ss	2	5	16.7	16.4		19.6	24.0	4.4
	VHT80 STBC, M0 to M9 1ss	3	5	16.7	16.4	17.5	21.7	24.0	2.3
5700	Non HT20, 6 to 54 Mbps	1	5	17.1			17.1	23.4	6.3
	Non HT20, 6 to 54 Mbps	2	5	16.1	15.8		19.0	23.4	4.4
	Non HT20, 6 to 54 Mbps	3	5	11.9	11.9	12.8	17.0	23.4	6.4
	Non HT20 Beam Forming, 6 to 54 Mbps	2	8	16.1	15.8		19.0	21.4	2.4
	Non HT20 Beam Forming, 6 to 54 Mbps	3	10	11.9	11.9	12.8	17.0	19.4	2.4
	HT/VHT20, M0 to M7	1	5	16.7			16.7	23.6	6.9
	HT/VHT20, M0 to M7	2	5	16.7	16.7		19.7	23.6	3.9
	HT/VHT20, M8 to M15	2	5	16.7	16.7		19.7	23.6	3.9
	HT/VHT20, M0 to M7	3	5	12.8	12.6	13.6	17.8	23.6	5.8
	HT/VHT20, M8 to M15	3	5	15.8	15.6	16.6	20.8	23.6	2.8
	HT/VHT20 Beam Forming, M0 to M7	2	8	16.7	16.7		19.7	21.6	1.9
	HT/VHT20 Beam Forming, M8 to M15	2	5	16.7	16.7		19.7	23.6	3.9
	HT/VHT20 Beam Forming, M0 to M7	3	10	12.8	12.6	13.6	17.8	19.6	1.8
	HT/VHT20 Beam Forming, M8 to M15	3	7	15.8	15.6	16.6	20.8	22.6	1.8
	HT/VHT20 STBC, M0 to M7	2	5	16.7	16.7		19.7	23.6	3.9
HT/VHT20 STBC, M0 to M7	3	5	15.8	15.6	16.6	20.8	23.6	2.8	
5710	Non HT40, 6 to 54 Mbps	1	5	17.1			17.1	24.0	6.9
	Non HT40, 6 to 54 Mbps	2	5	17.1	17.3		20.2	24.0	3.8
	Non HT40, 6 to 54 Mbps	3	5	14.0	14.2	15.0	19.2	24.0	4.8
	HT/VHT40, M0 to M7	1	5	17.6			17.6	24.0	6.4
	HT/VHT40, M0 to M7	2	5	17.6	17.8		20.7	24.0	3.3
	HT/VHT40, M8 to M15	2	5	17.6	17.8		20.7	24.0	3.3
	HT/VHT40, M0 to M7	3	5	14.5	14.7	15.5	19.7	24.0	4.3
	HT/VHT40, M8 to M15	3	5	17.6	17.8	18.4	22.7	24.0	1.3
	HT/VHT40 Beam Forming, M0 to M7	2	8	17.6	17.8		20.7	22.0	1.3
	HT/VHT40 Beam Forming, M8 to M15	2	5	17.6	17.8		20.7	24.0	3.3
	HT/VHT40 Beam Forming, M0 to M7	3	10	14.5	14.7	15.5	19.7	20.0	0.3
	HT/VHT40 Beam Forming, M8 to M15	3	7	17.6	17.8	18.4	22.7	23.0	0.3
	HT/VHT40 STBC, M0 to M7	2	5	17.6	17.8		20.7	24.0	3.3
	HT/VHT40 STBC, M0 to M7	3	5	17.6	17.8	18.4	22.7	24.0	1.3

5720	Non HT20, 6 to 54 Mbps	1	5	16.7			16.7	23.4	6.7
	Non HT20, 6 to 54 Mbps	2	5	15.7	16.0		18.9	23.4	4.5
	Non HT20, 6 to 54 Mbps	3	5	11.6	12.1	12.2	16.7	23.4	6.7
	Non HT20 Beam Forming, 6 to 54 Mbps	2	8	15.7	16.0		18.9	21.4	2.5
	Non HT20 Beam Forming, 6 to 54 Mbps	3	10	11.6	12.1	12.2	16.7	19.4	2.7
	HT/VHT20, M0 to M7	1	5	16.4			16.4	23.6	7.2
	HT/VHT20, M0 to M7	2	5	16.4	16.8		19.6	23.6	4.0
	HT/VHT20, M8 to M15	2	5	16.4	16.8		19.6	23.6	4.0
	HT/VHT20, M0 to M7	3	5	12.4	12.8	13.0	17.5	23.6	6.1
	HT/VHT20, M8 to M15	3	5	15.5	15.7	16.0	20.5	23.6	3.1
	HT/VHT20 Beam Forming, M0 to M7	2	8	16.4	16.8		19.6	21.6	2.0
	HT/VHT20 Beam Forming, M8 to M15	2	5	16.4	16.8		19.6	23.6	4.0
	HT/VHT20 Beam Forming, M0 to M7	3	10	12.4	12.8	13.0	17.5	19.6	2.1
	HT/VHT20 Beam Forming, M8 to M15	3	7	15.5	15.7	16.0	20.5	22.6	2.1
	HT/VHT20 STBC, M0 to M7	2	5	16.4	16.8		19.6	23.6	4.0
	HT/VHT20 STBC, M0 to M7	3	5	15.5	15.7	16.0	20.5	23.6	3.1

Maximum Transmit Output Power, 5710 MHz, HT/VHT40 Beam Forming, M0 to M7

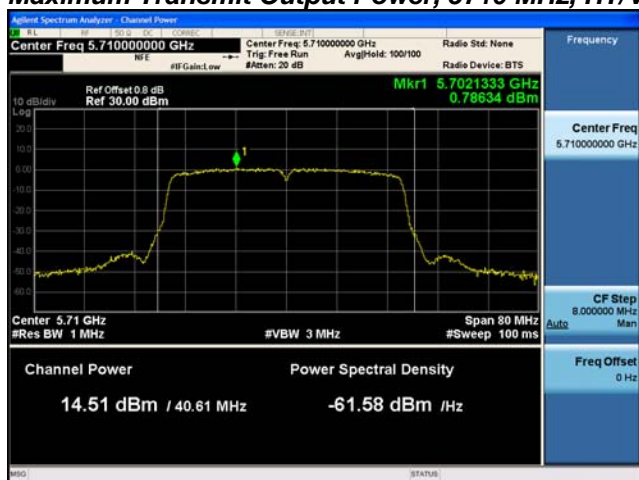

Antenna A

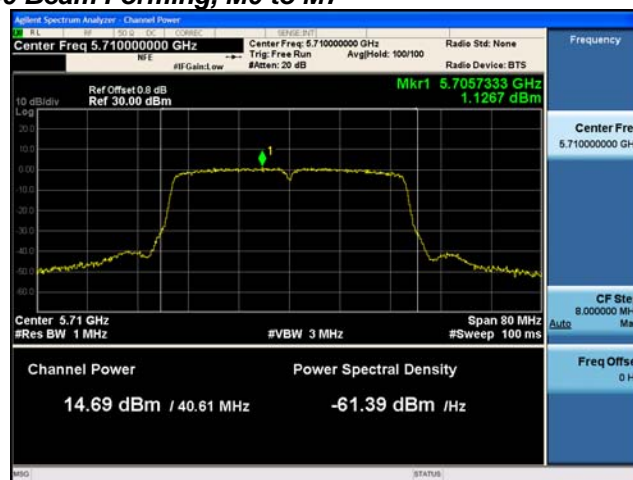

Antenna B

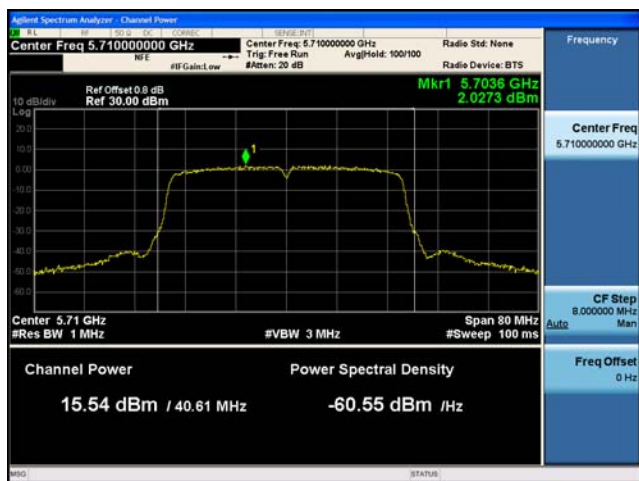

Antenna C

Power Spectral Density

Frequency (MHz)	Mode	Tx Paths	Correlated Antenna Gain (dBi)	Tx 1 PSD (dBm/MHz)	Tx 2 PSD (dBm/MHz)	Tx 3 PSD (dBm/MHz)	Total PSD (dBm/MHz)	Limit (dBm/MHz)	Margin (dB)
5500	Non HT20, 6 to 54 Mbps	1	5	5.2			5.2	11.0	5.8
	Non HT20, 6 to 54 Mbps	2	8	5.2	5.1		8.2	9.0	0.8
	Non HT20, 6 to 54 Mbps	3	10	1.3	0.7	2.1	6.2	7.0	0.8
	Non HT20 Beam Forming, 6 to 54 Mbps	2	8	5.2	5.1		8.2	9.0	0.8
	Non HT20 Beam Forming, 6 to 54 Mbps	3	10	1.3	0.7	2.1	6.2	7.0	0.8
	HT/VHT20, M0 to M7	1	5	4.6			4.6	11.0	6.4
	HT/VHT20, M0 to M7	2	8	4.6	4.4		7.5	9.0	1.5
	HT/VHT20, M8 to M15	2	5	4.6	4.4		7.5	11.0	3.5
	HT/VHT20, M0 to M7	3	10	1.7	1.4	2.7	6.7	7.0	0.3
	HT/VHT20, M8 to M15	3	7	4.6	4.4	5.6	9.7	10.0	0.3
	HT/VHT20 Beam Forming, M0 to M7	2	8	4.6	4.4		7.5	9.0	1.5
	HT/VHT20 Beam Forming, M8 to M15	2	5	4.6	4.4		7.5	11.0	3.5
	HT/VHT20 Beam Forming, M0 to M7	3	10	1.7	1.4	2.7	6.7	7.0	0.3
	HT/VHT20 Beam Forming, M8 to M15	3	7	4.6	4.4	5.6	9.7	10.0	0.3
	HT/VHT20 STBC, M0 to M7	2	5	4.6	4.4		7.5	11.0	3.5
HT/VHT20 STBC, M0 to M7	3	7	4.6	4.4	5.6	9.7	10.0	0.3	
5510	Non HT40, 6 to 54 Mbps	1	5	1.5			1.5	11.0	9.5
	Non HT40, 6 to 54 Mbps	2	8	1.5	1.1		4.3	9.0	4.7
	Non HT40, 6 to 54 Mbps	3	10	1.5	1.1	2.3	6.4	7.0	0.6
	HT/VHT40, M0 to M7	1	5	1.6			1.6	11.0	9.4
	HT/VHT40, M0 to M7	2	8	0.8	0.5		3.7	9.0	5.3
	HT/VHT40, M8 to M15	2	5	0.8	0.5		3.7	11.0	7.3
	HT/VHT40, M0 to M7	3	10	0.8	0.5	1.4	5.7	7.0	1.3
	HT/VHT40, M8 to M15	3	7	0.8	0.5	1.4	5.7	10.0	4.3
	HT/VHT40 Beam Forming, M0 to M7	2	8	-0.4	-0.7		2.5	9.0	6.5
	HT/VHT40 Beam Forming, M8 to M15	2	5	0.8	0.5		3.7	11.0	7.3
	HT/VHT40 Beam Forming, M0 to M7	3	10	-2.1	-2.9	-1.8	2.5	7.0	4.5
	HT/VHT40 Beam Forming, M8 to M15	3	7	-0.4	-0.7	0.4	4.6	10.0	5.4
	HT/VHT40 STBC, M0 to M7	2	5	0.8	0.5		3.7	11.0	7.3
	HT/VHT40 STBC, M0 to M7	3	7	0.8	0.5	1.4	5.7	10.0	4.3

5530	Non HT80, 6 to 54 Mbps	1	5	-1.2			-1.2	11.0	12.2
	Non HT80, 6 to 54 Mbps	2	8	-1.2	-1.4		1.7	9.0	7.3
	Non HT80, 6 to 54 Mbps	3	10	-1.9	-2.6	-2.5	2.4	7.0	4.6
	VHT80, M0 to M9 1ss	1	5	-1.2			-1.2	11.0	12.2
	VHT80, M0 to M9 1ss	2	8	-1.2	-1.8		1.5	9.0	7.5
	VHT80, M0 to M9 2ss	2	5	-1.2	-1.8		1.5	11.0	9.5
	VHT80, M0 to M9 1ss	3	10	-2.7	-2.5	-2.7	2.1	7.0	4.9
	VHT80, M0 to M9 2ss	3	7	-2.7	-2.5	-2.7	2.1	10.0	7.9
	VHT80 Beam Forming, M0 to M9 1ss	2	8	-2.7	-2.5		0.4	9.0	8.6
	VHT80 Beam Forming, M0 to M9 2ss	2	5	-1.2	-1.8		1.5	11.0	9.5
	VHT80 Beam Forming, M0 to M9 1ss	3	10	-4.0	-4.5	-4.7	0.4	7.0	6.6
	VHT80 Beam Forming, M0 to M9 2ss	3	7	-2.7	-2.5	-2.7	2.1	10.0	7.9
	VHT80 STBC, M0 to M9 1ss	2	5	-1.2	-1.8		1.5	11.0	9.5
	VHT80 STBC, M0 to M9 1ss	3	5	-2.7	-2.5	-2.7	2.1	11.0	8.9
5550	Non HT40, 6 to 54 Mbps	1	5	4.7			4.7	11.0	6.3
	Non HT40, 6 to 54 Mbps	2	8	4.7	4.4		7.6	9.0	1.4
	Non HT40, 6 to 54 Mbps	3	10	1.7	1.2	1.7	6.3	7.0	0.7
	HT/VHT40, M0 to M7	1	5	4.1			4.1	11.0	6.9
	HT/VHT40, M0 to M7	2	8	4.1	3.5		6.8	9.0	2.2
	HT/VHT40, M8 to M15	2	5	4.1	3.5		6.8	11.0	4.2
	HT/VHT40, M0 to M7	3	10	2.0	1.7	2.4	6.8	7.0	0.2
	HT/VHT40, M8 to M15	3	7	4.1	3.5	4.3	8.8	10.0	1.2
	HT/VHT40 Beam Forming, M0 to M7	2	8	4.1	3.5		6.8	9.0	2.2
	HT/VHT40 Beam Forming, M8 to M15	2	5	4.1	3.5		6.8	11.0	4.2
	HT/VHT40 Beam Forming, M0 to M7	3	10	1.1	0.5	1.2	5.7	7.0	1.3
	HT/VHT40 Beam Forming, M8 to M15	3	7	4.1	3.5	4.3	8.8	10.0	1.2
	HT/VHT40 STBC, M0 to M7	2	5	4.1	3.5		6.8	11.0	4.2
	HT/VHT40 STBC, M0 to M7	3	7	4.1	3.5	4.3	8.8	10.0	1.2
5560	Non HT20, 6 to 54 Mbps	1	5	6.2			6.2	11.0	4.8
	Non HT20, 6 to 54 Mbps	2	8	5.2	4.8		8.0	9.0	1.0
	Non HT20, 6 to 54 Mbps	3	10	1.5	0.9	1.6	6.1	7.0	0.9
	Non HT20 Beam Forming, 6 to 54 Mbps	2	8	5.2	4.8		8.0	9.0	1.0
	Non HT20 Beam Forming, 6 to 54 Mbps	3	10	1.5	0.9	1.6	6.1	7.0	0.9
	HT/VHT20, M0 to M7	1	5	6.0			6.0	11.0	5.0
	HT/VHT20, M0 to M7	2	8	6.0	5.5		8.8	9.0	0.2
	HT/VHT20, M8 to M15	2	5	6.0	5.5		8.8	11.0	2.2
	HT/VHT20, M0 to M7	3	10	2.1	1.3	2.2	6.7	7.0	0.3
	HT/VHT20, M8 to M15	3	7	5.1	4.5	5.4	9.8	10.0	0.2
	HT/VHT20 Beam Forming, M0 to M7	2	8	6.0	5.5		8.8	9.0	0.2
	HT/VHT20 Beam Forming, M8 to M15	2	5	6.0	5.5		8.8	11.0	2.2
	HT/VHT20 Beam Forming, M0 to M7	3	10	2.1	1.3	2.2	6.7	7.0	0.3

	HT/VHT20 Beam Forming, M8 to M15	3	7	5.1	4.5	5.4	9.8	10.0	0.2
	HT/VHT20 STBC, M0 to M7	2	5	6.0	5.5		8.8	11.0	2.2
	HT/VHT20 STBC, M0 to M7	3	7	5.1	4.5	5.4	9.8	10.0	0.2
5660	Non HT20, 6 to 54 Mbps	1	5	6.5			6.5	11.0	4.5
	Non HT20, 6 to 54 Mbps	2	8	6.5	5.3		9.0	9.0	0.0
	Non HT20, 6 to 54 Mbps	3	10	1.9	1.1	2.3	6.6	7.0	0.4
	Non HT20 Beam Forming, 6 to 54 Mbps	2	8	6.5	5.3		9.0	9.0	0.0
	Non HT20 Beam Forming, 6 to 54 Mbps	3	10	1.9	1.1	2.3	6.6	7.0	0.4
	HT/VHT20, M0 to M7	1	5	5.5			5.5	11.0	5.5
	HT/VHT20, M0 to M7	2	8	5.5	4.5		8.0	9.0	1.0
	HT/VHT20, M8 to M15	2	5	5.5	4.5		8.0	11.0	3.0
	HT/VHT20, M0 to M7	3	10	1.8	0.7	1.9	6.3	7.0	0.7
	HT/VHT20, M8 to M15	3	7	5.5	4.5	5.6	10.0	10.0	0.0
	HT/VHT20 Beam Forming, M0 to M7	2	8	5.5	4.5		8.0	9.0	1.0
	HT/VHT20 Beam Forming, M8 to M15	2	5	5.5	4.5		8.0	11.0	3.0
	HT/VHT20 Beam Forming, M0 to M7	3	10	1.8	0.7	1.9	6.3	7.0	0.7
	HT/VHT20 Beam Forming, M8 to M15	3	7	5.5	4.5	5.6	10.0	10.0	0.0
	HT/VHT20 STBC, M0 to M7	2	5	5.5	4.5		8.0	11.0	3.0
HT/VHT20 STBC, M0 to M7	3	7	5.5	4.5	5.6	10.0	10.0	0.0	
5670	Non HT40, 6 to 54 Mbps	1	5	4.5			4.5	11.0	6.5
	Non HT40, 6 to 54 Mbps	2	8	4.5	3.7		7.1	9.0	1.9
	Non HT40, 6 to 54 Mbps	3	10	1.7	0.8	2.6	6.5	7.0	0.5
	HT/VHT40, M0 to M7	1	5	3.9			3.9	11.0	7.1
	HT/VHT40, M0 to M7	2	8	3.9	3.1		6.5	9.0	2.5
	HT/VHT40, M8 to M15	2	5	3.9	3.1		6.5	11.0	4.5
	HT/VHT40, M0 to M7	3	10	1.8	1.0	2.6	6.6	7.0	0.4
	HT/VHT40, M8 to M15	3	7	3.9	3.1	4.9	8.8	10.0	1.2
	HT/VHT40 Beam Forming, M0 to M7	2	8	3.9	3.1		6.5	9.0	2.5
	HT/VHT40 Beam Forming, M8 to M15	2	5	3.9	3.1		6.5	11.0	4.5
	HT/VHT40 Beam Forming, M0 to M7	3	10	0.8	-0.2	1.6	5.6	7.0	1.4
	HT/VHT40 Beam Forming, M8 to M15	3	7	3.9	3.1	4.9	8.8	10.0	1.2
	HT/VHT40 STBC, M0 to M7	2	5	3.9	3.1		6.5	11.0	4.5
HT/VHT40 STBC, M0 to M7	3	7	3.9	3.1	4.9	8.8	10.0	1.2	
5690	Non HT80, 6 to 54 Mbps	1	5	0.5			0.5	11.0	10.5
	Non HT80, 6 to 54 Mbps	2	8	0.5	0.2		3.4	9.0	5.6
	Non HT80, 6 to 54 Mbps	3	10	0.5	0.2	1.5	5.5	7.0	1.5
	VHT80, M0 to M9 1ss	1	5	0.1			0.1	11.0	10.9
	VHT80, M0 to M9 1ss	2	8	0.1	-0.6		2.8	9.0	6.2
	VHT80, M0 to M9 2ss	2	5	0.1	-0.6		2.8	11.0	8.2
	VHT80, M0 to M9 1ss	3	10	0.1	-0.6	0.7	4.9	7.0	2.1

	VHT80, M0 to M9 2ss	3	7	0.1	-0.6	0.7	4.9	10.0	5.1
	VHT80 Beam Forming, M0 to M9 1ss	2	8	0.1	-0.6		2.8	9.0	6.2
	VHT80 Beam Forming, M0 to M9 2ss	2	5	0.1	-0.6		2.8	11.0	8.2
	VHT80 Beam Forming, M0 to M9 1ss	3	10	-2.1	-2.4	-0.8	3.1	7.0	3.9
	VHT80 Beam Forming, M0 to M9 2ss	3	7	0.1	-0.6	0.7	4.9	10.0	5.1
	VHT80 STBC, M0 to M9 1ss	2	5	0.1	-0.6		2.8	11.0	8.2
	VHT80 STBC, M0 to M9 1ss	3	5	0.1	-0.6	0.7	4.9	11.0	6.1
5700	Non HT20, 6 to 54 Mbps	1	5	6.4			6.4	11.0	4.6
	Non HT20, 6 to 54 Mbps	2	8	5.4	5.0		8.2	9.0	0.8
	Non HT20, 6 to 54 Mbps	3	10	1.4	1.3	2.3	6.5	7.0	0.5
	Non HT20 Beam Forming, 6 to 54 Mbps	2	8	5.4	5.0		8.2	9.0	0.8
	Non HT20 Beam Forming, 6 to 54 Mbps	3	10	1.4	1.3	2.3	6.5	7.0	0.5
	HT/VHT20, M0 to M7	1	5	5.8			5.8	11.0	5.2
	HT/VHT20, M0 to M7	2	8	5.8	5.6		8.7	9.0	0.3
	HT/VHT20, M8 to M15	2	5	5.8	5.6		8.7	11.0	2.3
	HT/VHT20, M0 to M7	3	10	1.9	1.8	2.8	7.0	7.0	0.0
	HT/VHT20, M8 to M15	3	7	4.9	4.5	5.5	9.8	10.0	0.2
	HT/VHT20 Beam Forming, M0 to M7	2	8	5.8	5.6		8.7	9.0	0.3
	HT/VHT20 Beam Forming, M8 to M15	2	5	5.8	5.6		8.7	11.0	2.3
	HT/VHT20 Beam Forming, M0 to M7	3	10	1.9	1.8	2.8	7.0	7.0	0.0
	HT/VHT20 Beam Forming, M8 to M15	3	7	4.9	4.5	5.5	9.8	10.0	0.2
	HT/VHT20 STBC, M0 to M7	2	5	5.8	5.6		8.7	11.0	2.3
HT/VHT20 STBC, M0 to M7	3	7	4.9	4.5	5.5	9.8	10.0	0.2	
5710	Non HT40, 6 to 54 Mbps	1	5	4.5			4.5	11.0	6.5
	Non HT40, 6 to 54 Mbps	2	8	4.5	4.5		7.5	9.0	1.5
	Non HT40, 6 to 54 Mbps	3	10	1.4	2.1	2.1	6.7	7.0	0.3
	HT/VHT40, M0 to M7	1	5	4.0			4.0	11.0	7.0
	HT/VHT40, M0 to M7	2	8	4.0	4.5		7.3	9.0	1.7
	HT/VHT40, M8 to M15	2	5	4.0	4.5		7.3	11.0	3.7
	HT/VHT40, M0 to M7	3	10	0.8	1.1	2.0	6.1	7.0	0.9
	HT/VHT40, M8 to M15	3	7	4.0	4.5	5.1	9.3	10.0	0.7
	HT/VHT40 Beam Forming, M0 to M7	2	8	4.0	4.5		7.3	9.0	1.7
	HT/VHT40 Beam Forming, M8 to M15	2	5	4.0	4.5		7.3	11.0	3.7
	HT/VHT40 Beam Forming, M0 to M7	3	10	0.8	1.1	2.0	6.1	7.0	0.9
	HT/VHT40 Beam Forming, M8 to M15	3	7	4.0	4.5	5.1	9.3	10.0	0.7
	HT/VHT40 STBC, M0 to M7	2	5	4.0	4.5		7.3	11.0	3.7
	HT/VHT40 STBC, M0 to M7	3	7	4.0	4.5	5.1	9.3	10.0	0.7

5720	Non HT20, 6 to 54 Mbps	1	5	6.0			6.0	11.0	5.0
	Non HT20, 6 to 54 Mbps	2	8	5.2	5.3		8.3	9.0	0.7
	Non HT20, 6 to 54 Mbps	3	10	0.7	1.4	1.6	6.0	7.0	1.0
	Non HT20 Beam Forming, 6 to 54 Mbps	2	8	5.2	5.3		8.3	9.0	0.7
	Non HT20 Beam Forming, 6 to 54 Mbps	3	10	0.7	1.4	1.6	6.0	7.0	1.0
	HT/VHT20, M0 to M7	1	5	5.3			5.3	11.0	5.7
	HT/VHT20, M0 to M7	2	8	5.3	5.6		8.5	9.0	0.5
	HT/VHT20, M8 to M15	2	5	5.3	5.6		8.5	11.0	2.5
	HT/VHT20, M0 to M7	3	10	1.7	1.9	2.3	6.7	7.0	0.3
	HT/VHT20, M8 to M15	3	7	4.6	4.8	5.1	9.6	10.0	0.4
	HT/VHT20 Beam Forming, M0 to M7	2	8	5.3	5.6		8.5	9.0	0.5
	HT/VHT20 Beam Forming, M8 to M15	2	5	5.3	5.6		8.5	11.0	2.5
	HT/VHT20 Beam Forming, M0 to M7	3	10	1.7	1.9	2.3	6.7	7.0	0.3
	HT/VHT20 Beam Forming, M8 to M15	3	7	4.6	4.8	5.1	9.6	10.0	0.4
	HT/VHT20 STBC, M0 to M7	2	5	5.3	5.6		8.5	11.0	2.5
	HT/VHT20 STBC, M0 to M7	3	7	4.6	4.8	5.1	9.6	10.0	0.4

Power Spectral Density, 5660 MHz, HT/VHT20, M8 to M15

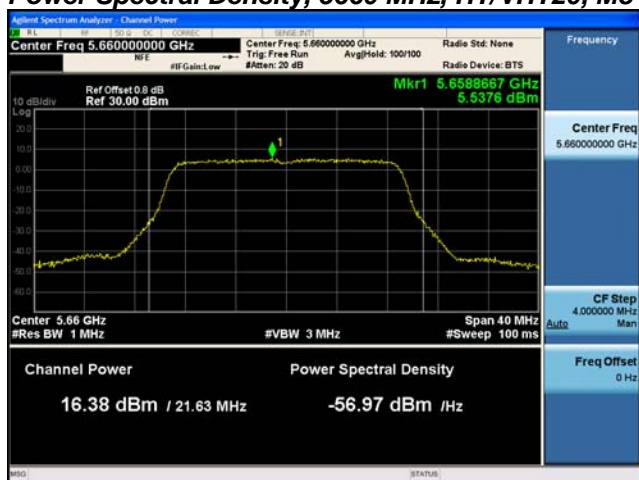

Antenna A



Antenna B

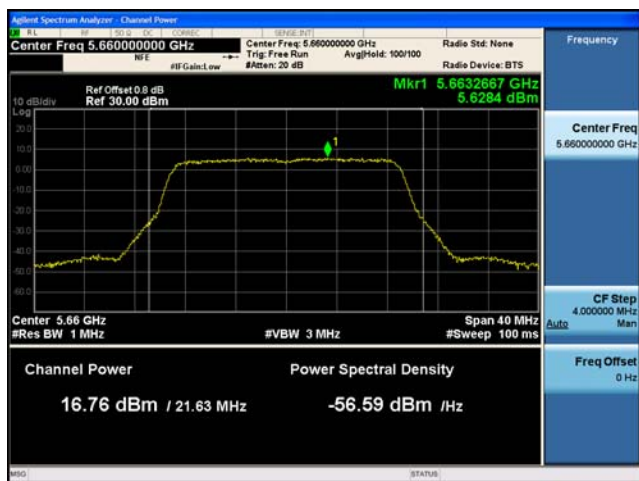

Antenna C

A.3 Conducted Spurious Emissions

15.407 (b) Undesirable emission limits. Except as shown in paragraph (b) (7) of this section, the maximum emissions outside of the frequency bands of operation shall be attenuated in accordance with the following limits:

- (3) For transmitters operating in the 5.47-5.725 GHz band: All emissions outside of the 5.47-5.725 GHz band shall not exceed an e.i.r.p. of -27 dBm/MHz..
- (6) Unwanted emissions below 1 GHz must comply with the general field strength limits set forth in §15.209.
- (7) The provisions of §15.205 apply to intentional radiators operating under this section.

Note:

The Intentional Beamforming correlated array gain for any number of space time streams is given by the general formula:

$$G_{bf_max} = 10 * \log_{10}(N_{tx}/N_{sts})$$

where N_{tx} is the number of equal power active transmit antennas and N_{sts} is the number of active space time streams.

Test Procedure

Ref. KDB 789033 D02 General UNII Test Procedures New Rules v01r03
ANSI C63.10: 2013

Conducted Spurious Emissions Test Procedure
1. Connect the antenna port(s) to the spectrum analyzer input. 2. Place the radio in continuous transmit mode. Use the procedures in KDB 789033 D02 General UNII Test Procedures New Rules v01r03 to substitute conducted measurements in place of radiated measurements. 3. Configure Spectrum analyzer as per test parameters below (be sure to enter all losses between the transmitter output and the spectrum analyzer). 4. Record the marker waveform peak to spur difference. Also measure any emissions in the restricted bands. 5. The "measure-and-sum technique" is used for measuring in-band transmit power of a device. In the measure-and-sum approach, the conducted emission level is measured at each antenna port. The measured results at the various antenna ports are then summed mathematically to determine the total emission level from the device. Summing is performed in linear power units. The worst case output is recorded. 6. Capture graphs and record pertinent measurement data.

Ref. KDB 789033 D02 General UNII Test Procedures New Rules v01r03
ANSI C63.10: 2013 section 12.7.7.3 (average) & 12.7.6 (peak)

Conducted Spurious Emissions Test parameters
Span = 30MHz to 18GHz / 18GHz to 40GHz RBW = 1 MHz VBW ≥ 3 x RBW for Peak, 1kHz for Average Sweep = Auto couple Detector = Peak Trace = Max Hold.

System Number	Description	Samples	System under test	Support equipment
1	EUT	S01	<input checked="" type="checkbox"/>	<input type="checkbox"/>
	Support	S02	<input type="checkbox"/>	<input checked="" type="checkbox"/>

Tested By : Jose Aguirre	Date of testing: 05-May-16 - 06-Jun-16
Test Result : PASS	

See Appendix C for list of test equipment



Conducted Spurs Average Upper, All Antennas

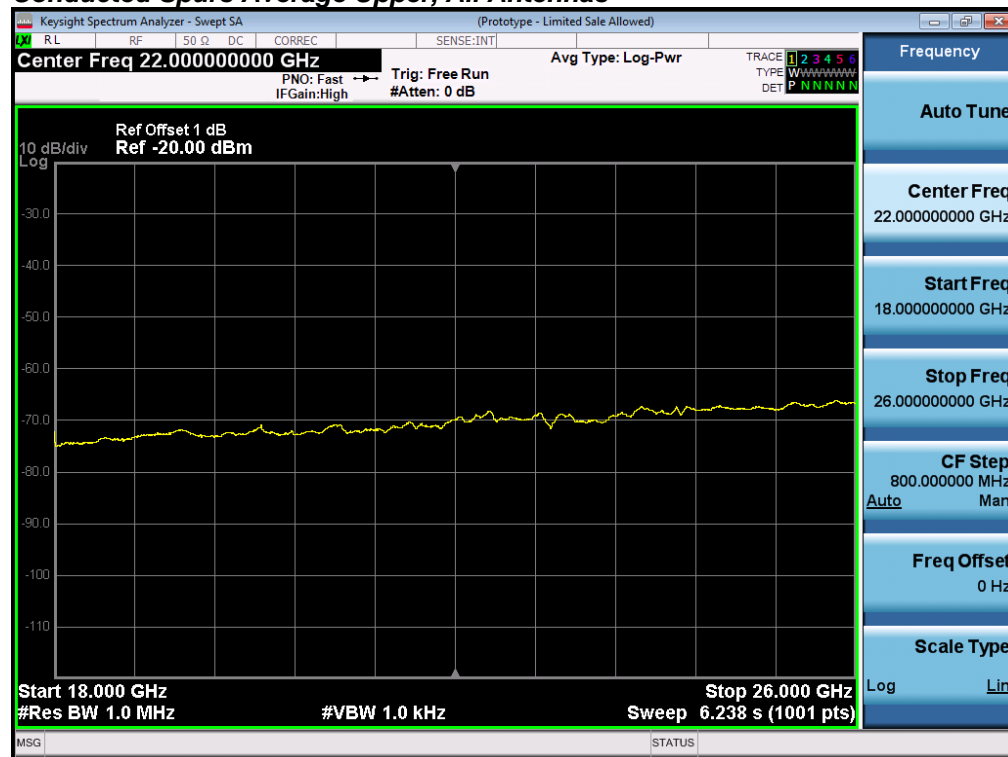

Conducted Spurs Peak Upper, All Antennas



Frequency (MHz)	Mode	Tx Paths	Correlated Antenna Gain (dBi)	Tx 1 Spur Power (dBm)	Tx 2 Spur Power (dBm)	Tx 3 Spur Power (dBm)	Total Conducted Spur (dBm)	Limit (dBm)	Margin (dB)
5500	Non HT20, 6 to 54 Mbps	1	5	-74.6			-69.6	-41.25	28.4
	Non HT20, 6 to 54 Mbps	2	5	-74.6	-69.5		-63.3	-41.25	22.1
	Non HT20, 6 to 54 Mbps	3	5	-74.8	-74.6	-74.6	-64.9	-41.25	23.6
	Non HT20 Beam Forming, 6 to 54 Mbps	2	8	-74.6	-69.5		-60.3	-41.25	19.1
	Non HT20 Beam Forming, 6 to 54 Mbps	3	10	-74.8	-74.6	-74.6	-59.9	-41.25	18.6
	HT/VHT20, M0 to M7	1	5	-74.5			-69.5	-41.25	28.3
	HT/VHT20, M0 to M7	2	5	-74.5	-74.6		-66.5	-41.25	25.3
	HT/VHT20, M8 to M15	2	5	-74.5	-74.6		-66.5	-41.25	25.3
	HT/VHT20, M0 to M7	3	5	-71.0	-74.6	-63.5	-57.5	-41.25	16.3
	HT/VHT20, M8 to M15	3	5	-74.5	-74.6	-70.7	-63.1	-41.25	21.8
	HT/VHT20 Beam Forming, M0 to M7	2	8	-74.5	-74.6		-63.5	-41.25	22.3
	HT/VHT20 Beam Forming, M8 to M15	2	5	-74.5	-74.6		-66.5	-41.25	25.3
	HT/VHT20 Beam Forming, M0 to M7	3	10	-71.0	-74.6	-63.5	-52.5	-41.25	11.3
	HT/VHT20 Beam Forming, M8 to M15	3	7	-74.5	-74.6	-70.7	-61.1	-41.25	19.8
	HT/VHT20 STBC, M0 to M7	2	5	-74.5	-74.6		-66.5	-41.25	25.3
HT/VHT20 STBC, M0 to M7	3	5	-74.5	-74.6	-70.7	-63.1	-41.25	21.8	
5510	Non HT40, 6 to 54 Mbps	1	5	-74.9			-69.9	-41.25	28.7
	Non HT40, 6 to 54 Mbps	2	5	-74.9	-74.4		-66.6	-41.25	25.4
	Non HT40, 6 to 54 Mbps	3	5	-74.9	-74.4	-61.0	-55.6	-41.25	14.4
	HT/VHT40, M0 to M7	1	5	-74.7			-69.7	-41.25	28.5
	HT/VHT40, M0 to M7	2	5	-70.8	-74.4		-64.2	-41.25	23.0
	HT/VHT40, M8 to M15	2	5	-70.8	-74.4		-64.2	-41.25	23.0
	HT/VHT40, M0 to M7	3	5	-70.8	-74.4	-74.5	-63.1	-41.25	21.8
	HT/VHT40, M8 to M15	3	5	-70.8	-74.4	-74.5	-63.1	-41.25	21.8
	HT/VHT40 Beam Forming, M0 to M7	2	8	-74.4	-74.6		-63.5	-41.25	22.2
	HT/VHT40 Beam Forming, M8 to M15	2	5	-70.8	-74.4		-64.2	-41.25	23.0
	HT/VHT40 Beam Forming, M0 to M7	3	10	-74.5	-74.4	-63.0	-52.4	-41.25	11.2
	HT/VHT40 Beam Forming, M8 to M15	3	7	-74.4	-74.6	-63.0	-55.4	-41.25	14.2
	HT/VHT40 STBC, M0 to M7	2	5	-70.8	-74.4		-64.2	-41.25	23.0
HT/VHT40 STBC, M0 to M7	3	5	-70.8	-74.4	-74.5	-63.1	-41.25	21.8	

5530	Non HT80, 6 to 54 Mbps	1	5	-74.9			-69.9	-41.25	28.7
	Non HT80, 6 to 54 Mbps	2	5	-74.9	-74.2		-66.5	-41.25	25.3
	Non HT80, 6 to 54 Mbps	3	5	-71.0	-74.7	-61.6	-55.9	-41.25	14.7
	VHT80, M0 to M9 1ss	1	5	-70.9			-65.9	-41.25	24.7
	VHT80, M0 to M9 1ss	2	5	-70.9	-74.8		-64.4	-41.25	23.2
	VHT80, M0 to M9 2ss	2	5	-70.9	-74.8		-64.4	-41.25	23.2
	VHT80, M0 to M9 1ss	3	5	-71.1	-75.0	-62.2	-56.5	-41.25	15.2
	VHT80, M0 to M9 2ss	3	5	-71.1	-75.0	-62.2	-56.5	-41.25	15.2
	VHT80 Beam Forming, M0 to M9 1ss	2	8	-71.1	-75.0		-61.6	-41.25	20.4
	VHT80 Beam Forming, M0 to M9 2ss	2	5	-70.9	-74.8		-64.4	-41.25	23.2
	VHT80 Beam Forming, M0 to M9 1ss	3	10	-74.9	-74.6	-62.1	-51.7	-41.25	10.4
	VHT80 Beam Forming, M0 to M9 2ss	3	7	-71.1	-75.0	-62.2	-54.5	-41.25	13.2
	VHT80 STBC, M0 to M9 1ss	2	5	-70.9	-74.8		-64.4	-41.25	23.2
	VHT80 STBC, M0 to M9 1ss	3	5	-71.1	-75.0	-62.2	-56.5	-41.25	15.2
5550	Non HT40, 6 to 54 Mbps	1	5	-71.0			-66.0	-41.25	24.8
	Non HT40, 6 to 54 Mbps	2	5	-71.0	-75.0		-64.5	-41.25	23.3
	Non HT40, 6 to 54 Mbps	3	5	-75.1	-74.9	-61.8	-56.4	-41.25	15.2
	HT/VHT40, M0 to M7	1	5	-75.2			-70.2	-41.25	29.0
	HT/VHT40, M0 to M7	2	5	-75.2	-70.4		-64.2	-41.25	22.9
	HT/VHT40, M8 to M15	2	5	-75.2	-70.4		-64.2	-41.25	22.9
	HT/VHT40, M0 to M7	3	5	-75.1	-70.9	-61.6	-55.9	-41.25	14.7
	HT/VHT40, M8 to M15	3	5	-75.2	-70.4	-62.0	-56.2	-41.25	15.0
	HT/VHT40 Beam Forming, M0 to M7	2	8	-75.2	-70.4		-61.2	-41.25	19.9
	HT/VHT40 Beam Forming, M8 to M15	2	5	-75.2	-70.4		-64.2	-41.25	22.9
	HT/VHT40 Beam Forming, M0 to M7	3	10	-74.9	-75.4	-61.6	-51.2	-41.25	10.0
	HT/VHT40 Beam Forming, M8 to M15	3	7	-75.2	-70.4	-62.0	-54.2	-41.25	13.0
	HT/VHT40 STBC, M0 to M7	2	5	-75.2	-70.4		-64.2	-41.25	22.9
	HT/VHT40 STBC, M0 to M7	3	5	-75.2	-70.4	-62.0	-56.2	-41.25	15.0
5560	Non HT20, 6 to 54 Mbps	1	5	-70.9			-65.9	-41.25	24.7
	Non HT20, 6 to 54 Mbps	2	5	-70.7	-75.8		-64.5	-41.25	23.3
	Non HT20, 6 to 54 Mbps	3	5	-75.6	-75.8	-64.8	-59.1	-41.25	17.9
	Non HT20 Beam Forming, 6 to 54 Mbps	2	8	-70.7	-75.8		-61.5	-41.25	20.3
	Non HT20 Beam Forming, 6 to 54 Mbps	3	10	-75.6	-75.8	-64.8	-54.1	-41.25	12.9
	HT/VHT20, M0 to M7	1	5	-75.1			-70.1	-41.25	28.9
	HT/VHT20, M0 to M7	2	5	-75.1	-76.1		-67.6	-41.25	26.3
	HT/VHT20, M8 to M15	2	5	-75.1	-76.1		-67.6	-41.25	26.3
	HT/VHT20, M0 to M7	3	5	-75.2	-71.0	-63.8	-57.8	-41.25	16.5
	HT/VHT20, M8 to M15	3	5	-70.8	-75.6	-64.3	-58.2	-41.25	16.9
	HT/VHT20 Beam Forming, M0 to M7	2	8	-75.1	-76.1		-64.6	-41.25	23.3
	HT/VHT20 Beam Forming, M8 to M15	2	5	-75.1	-76.1		-67.6	-41.25	26.3
	HT/VHT20 Beam Forming, M0 to M7	3	10	-75.2	-71.0	-63.8	-52.8	-41.25	11.5

	HT/VHT20 Beam Forming, M8 to M15	3	7	-70.8	-75.6	-64.3	-56.2	-41.25	14.9
	HT/VHT20 STBC, M0 to M7	2	5	-75.1	-76.1		-67.6	-41.25	26.3
	HT/VHT20 STBC, M0 to M7	3	5	-70.8	-75.6	-64.3	-58.2	-41.25	16.9
5660	Non HT20, 6 to 54 Mbps	1	5	-70.8			-65.8	-41.25	24.6
	Non HT20, 6 to 54 Mbps	2	5	-70.8	-76.0		-64.7	-41.25	23.4
	Non HT20, 6 to 54 Mbps	3	5	-76.5	-76.2	-64.3	-58.8	-41.25	17.5
	Non HT20 Beam Forming, 6 to 54 Mbps	2	8	-70.8	-76.0		-61.7	-41.25	20.4
	Non HT20 Beam Forming, 6 to 54 Mbps	3	10	-76.5	-76.2	-64.3	-53.8	-41.25	12.5
	HT/VHT20, M0 to M7	1	5	-75.4			-70.4	-41.25	29.2
	HT/VHT20, M0 to M7	2	5	-75.4	-76.2		-67.8	-41.25	26.5
	HT/VHT20, M8 to M15	2	5	-75.4	-76.2		-67.8	-41.25	26.5
	HT/VHT20, M0 to M7	3	5	-75.9	-71.0	-76.4	-63.9	-41.25	22.7
	HT/VHT20, M8 to M15	3	5	-75.4	-76.2	-70.8	-63.7	-41.25	22.4
	HT/VHT20 Beam Forming, M0 to M7	2	8	-75.4	-76.2		-64.8	-41.25	23.5
	HT/VHT20 Beam Forming, M8 to M15	2	5	-75.4	-76.2		-67.8	-41.25	26.5
	HT/VHT20 Beam Forming, M0 to M7	3	10	-75.9	-71.0	-76.4	-58.9	-41.25	17.7
	HT/VHT20 Beam Forming, M8 to M15	3	7	-75.4	-76.2	-70.8	-61.7	-41.25	20.4
	HT/VHT20 STBC, M0 to M7	2	5	-75.4	-76.2		-67.8	-41.25	26.5
HT/VHT20 STBC, M0 to M7	3	5	-75.4	-76.2	-70.8	-63.7	-41.25	22.4	
5670	Non HT40, 6 to 54 Mbps	1	5	-76.2			-71.2	-41.25	30.0
	Non HT40, 6 to 54 Mbps	2	5	-76.2	-71.1		-64.9	-41.25	23.7
	Non HT40, 6 to 54 Mbps	3	5	-76.1	-76.3	-61.6	-56.3	-41.25	15.1
	HT/VHT40, M0 to M7	1	5	-76.0			-71.0	-41.25	29.8
	HT/VHT40, M0 to M7	2	5	-76.0	-76.1		-68.0	-41.25	26.8
	HT/VHT40, M8 to M15	2	5	-76.0	-76.1		-68.0	-41.25	26.8
	HT/VHT40, M0 to M7	3	5	-71.2	-71.2	-61.8	-55.9	-41.25	14.7
	HT/VHT40, M8 to M15	3	5	-76.0	-76.1	-61.5	-56.2	-41.25	15.0
	HT/VHT40 Beam Forming, M0 to M7	2	8	-76.0	-76.1		-65.0	-41.25	23.8
	HT/VHT40 Beam Forming, M8 to M15	2	5	-76.0	-76.1		-68.0	-41.25	26.8
	HT/VHT40 Beam Forming, M0 to M7	3	10	-76.0	-76.1	-64.3	-53.8	-41.25	12.5
	HT/VHT40 Beam Forming, M8 to M15	3	7	-76.0	-76.1	-61.5	-54.2	-41.25	13.0
	HT/VHT40 STBC, M0 to M7	2	5	-76.0	-76.1		-68.0	-41.25	26.8
HT/VHT40 STBC, M0 to M7	3	5	-76.0	-76.1	-61.5	-56.2	-41.25	15.0	
5690	Non HT80, 6 to 54 Mbps	1	5	-75.8			-70.8	-41.25	29.6
	Non HT80, 6 to 54 Mbps	2	5	-75.8	-70.9		-64.7	-41.25	23.4
	Non HT80, 6 to 54 Mbps	3	5	-75.8	-70.9	-60.9	-55.4	-41.25	14.1
	VHT80, M0 to M9 1ss	1	5	-75.7			-70.7	-41.25	29.5
	VHT80, M0 to M9 1ss	2	5	-75.7	-75.6		-67.6	-41.25	26.4
	VHT80, M0 to M9 2ss	2	5	-75.7	-75.6		-67.6	-41.25	26.4
	VHT80, M0 to M9 1ss	3	5	-75.7	-75.6	-60.6	-55.3	-41.25	14.1

	VHT80, M0 to M9 2ss	3	5	-75.7	-75.6	-60.6	-55.3	-41.25	14.1
	VHT80 Beam Forming, M0 to M9 1ss	2	8	-75.7	-75.6		-64.6	-41.25	23.4
	VHT80 Beam Forming, M0 to M9 2ss	2	5	-75.7	-75.6		-67.6	-41.25	26.4
	VHT80 Beam Forming, M0 to M9 1ss	3	10	-76.1	-76.4	-63.4	-53.0	-41.25	11.7
	VHT80 Beam Forming, M0 to M9 2ss	3	7	-75.7	-75.6	-60.6	-53.3	-41.25	12.1
	VHT80 STBC, M0 to M9 1ss	2	5	-75.7	-75.6		-67.6	-41.25	26.4
	VHT80 STBC, M0 to M9 1ss	3	5	-75.7	-75.6	-60.6	-55.3	-41.25	14.1
5700	Non HT20, 6 to 54 Mbps	1	5	-74.3			-69.3	-41.25	28.1
	Non HT20, 6 to 54 Mbps	2	5	-74.5	-74.7		-66.6	-41.25	25.3
	Non HT20, 6 to 54 Mbps	3	5	-74.2	-74.5	-66.2	-60.0	-41.25	18.8
	Non HT20 Beam Forming, 6 to 54 Mbps	2	8	-74.5	-74.7		-63.6	-41.25	22.3
	Non HT20 Beam Forming, 6 to 54 Mbps	3	10	-74.2	-74.5	-66.2	-55.0	-41.25	13.8
	HT/VHT20, M0 to M7	1	5	-73.8			-68.8	-41.25	27.6
	HT/VHT20, M0 to M7	2	5	-73.8	-71.0		-64.2	-41.25	22.9
	HT/VHT20, M8 to M15	2	5	-73.8	-71.0		-64.2	-41.25	22.9
	HT/VHT20, M0 to M7	3	5	-70.7	-70.9	-66.1	-58.9	-41.25	17.6
	HT/VHT20, M8 to M15	3	5	-74.9	-73.8	-65.5	-59.5	-41.25	18.2
	HT/VHT20 Beam Forming, M0 to M7	2	8	-73.8	-71.0		-61.2	-41.25	19.9
	HT/VHT20 Beam Forming, M8 to M15	2	5	-73.8	-71.0		-64.2	-41.25	22.9
	HT/VHT20 Beam Forming, M0 to M7	3	10	-70.7	-70.9	-66.1	-53.9	-41.25	12.6
	HT/VHT20 Beam Forming, M8 to M15	3	7	-74.9	-73.8	-65.5	-57.5	-41.25	16.2
	HT/VHT20 STBC, M0 to M7	2	5	-73.8	-71.0		-64.2	-41.25	22.9
HT/VHT20 STBC, M0 to M7	3	5	-74.9	-73.8	-65.5	-59.5	-41.25	18.2	
5710	Non HT40, 6 to 54 Mbps	1	5	-74.5			-69.5	-41.25	28.3
	Non HT40, 6 to 54 Mbps	2	5	-74.5	-71.0		-64.4	-41.25	23.1
	Non HT40, 6 to 54 Mbps	3	5	-74.4	-74.0	-62.5	-56.9	-41.25	15.7
	HT/VHT40, M0 to M7	1	5	-70.9			-65.9	-41.25	24.7
	HT/VHT40, M0 to M7	2	5	-70.9	-75.0		-64.5	-41.25	23.2
	HT/VHT40, M8 to M15	2	5	-70.9	-75.0		-64.5	-41.25	23.2
	HT/VHT40, M0 to M7	3	5	-74.9	-73.9	-64.5	-58.7	-41.25	17.4
	HT/VHT40, M8 to M15	3	5	-70.9	-75.0	-62.5	-56.7	-41.25	15.5
	HT/VHT40 Beam Forming, M0 to M7	2	8	-70.9	-75.0		-61.5	-41.25	20.2
	HT/VHT40 Beam Forming, M8 to M15	2	5	-70.9	-75.0		-64.5	-41.25	23.2
	HT/VHT40 Beam Forming, M0 to M7	3	10	-74.9	-73.9	-64.5	-53.7	-41.25	12.4
	HT/VHT40 Beam Forming, M8 to M15	3	7	-70.9	-75.0	-62.5	-54.7	-41.25	13.5
	HT/VHT40 STBC, M0 to M7	2	5	-70.9	-75.0		-64.5	-41.25	23.2
	HT/VHT40 STBC, M0 to M7	3	5	-70.9	-75.0	-62.5	-56.7	-41.25	15.5

5720	Non HT20, 6 to 54 Mbps	1	5	-73.6			-68.6	-41.25	27.4
	Non HT20, 6 to 54 Mbps	2	5	-73.8	-73.5		-65.6	-41.25	24.4
	Non HT20, 6 to 54 Mbps	3	5	-71.0	-72.7	-66.7	-59.6	-41.25	18.3
	Non HT20 Beam Forming, 6 to 54 Mbps	2	8	-73.8	-73.5		-62.6	-41.25	21.4
	Non HT20 Beam Forming, 6 to 54 Mbps	3	10	-71.0	-72.7	-66.7	-54.6	-41.25	13.3
	HT/VHT20, M0 to M7	1	5	-71.0			-66.0	-41.25	24.8
	HT/VHT20, M0 to M7	2	5	-71.0	-71.0		-63.0	-41.25	21.7
	HT/VHT20, M8 to M15	2	5	-71.0	-71.0		-63.0	-41.25	21.7
	HT/VHT20, M0 to M7	3	5	-73.8	-71.0	-66.8	-59.8	-41.25	18.6
	HT/VHT20, M8 to M15	3	5	-73.9	-74.3	-66.4	-60.1	-41.25	18.9
	HT/VHT20 Beam Forming, M0 to M7	2	8	-71.0	-71.0		-60.0	-41.25	18.7
	HT/VHT20 Beam Forming, M8 to M15	2	5	-71.0	-71.0		-63.0	-41.25	21.7
	HT/VHT20 Beam Forming, M0 to M7	3	10	-73.8	-71.0	-66.8	-54.8	-41.25	13.6
	HT/VHT20 Beam Forming, M8 to M15	3	7	-73.9	-74.3	-66.4	-58.1	-41.25	16.9
	HT/VHT20 STBC, M0 to M7	2	5	-71.0	-71.0		-63.0	-41.25	21.7
	HT/VHT20 STBC, M0 to M7	3	5	-73.9	-74.3	-66.4	-60.1	-41.25	18.9



Conducted Spurs Average, 5550 MHz, HT/VHT40 Beam Forming, M0 to M7



Antenna A



Antenna B

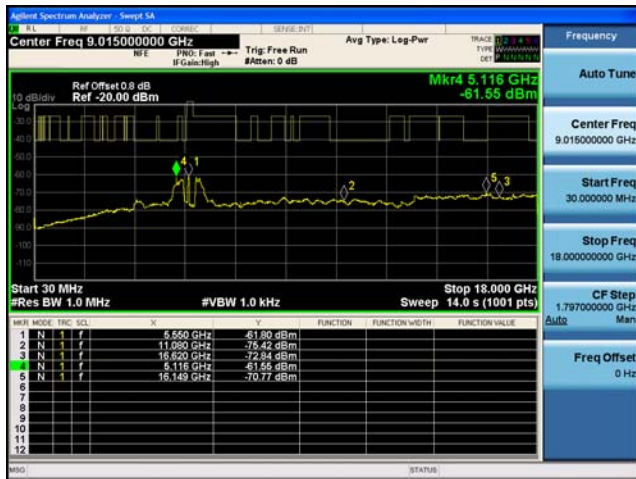

Antenna C

Frequency (MHz)	Mode	Tx Paths	Correlated Antenna Gain (dBi)	Tx 1 Spur Power (dBm)	Tx 2 Spur Power (dBm)	Tx 3 Spur Power (dBm)	Total Conducted Spur (dBm)	Limit (dBm)	Margin (dB)
5500	Non HT20, 6 to 54 Mbps	1	5	-54.6			-49.6	-21.25	28.4
	Non HT20, 6 to 54 Mbps	2	5	-54.6	-49.5		-43.3	-21.25	22.1
	Non HT20, 6 to 54 Mbps	3	5	-53.2	-53.7	-56.9	-44.5	-21.25	23.3
	Non HT20 Beam Forming, 6 to 54 Mbps	2	8	-54.6	-49.5		-40.3	-21.25	19.1
	Non HT20 Beam Forming, 6 to 54 Mbps	3	10	-53.2	-53.7	-56.9	-39.5	-21.25	18.3
	HT/VHT20, M0 to M7	1	5	-50.8			-45.8	-21.25	24.6
	HT/VHT20, M0 to M7	2	5	-50.8	-51.4		-43.1	-21.25	21.8
	HT/VHT20, M8 to M15	2	5	-50.8	-51.4		-43.1	-21.25	21.8
	HT/VHT20, M0 to M7	3	5	-53.6	-52.8	-59.3	-44.7	-21.25	23.4
	HT/VHT20, M8 to M15	3	5	-50.8	-51.4	-50.3	-41.0	-21.25	19.8
	HT/VHT20 Beam Forming, M0 to M7	2	8	-50.8	-51.4		-40.1	-21.25	18.8
	HT/VHT20 Beam Forming, M8 to M15	2	5	-50.8	-51.4		-43.1	-21.25	21.8
	HT/VHT20 Beam Forming, M0 to M7	3	10	-53.6	-52.8	-59.3	-39.7	-21.25	18.4
	HT/VHT20 Beam Forming, M8 to M15	3	7	-50.8	-51.4	-50.3	-39.0	-21.25	17.8
	HT/VHT20 STBC, M0 to M7	2	5	-50.8	-51.4		-43.1	-21.25	21.8
	HT/VHT20 STBC, M0 to M7	3	5	-50.8	-51.4	-50.3	-41.0	-21.25	19.8
5510	Non HT40, 6 to 54 Mbps	1	5	-50.1			-45.1	-21.25	23.9
	Non HT40, 6 to 54 Mbps	2	5	-50.1	-52.0		-42.9	-21.25	21.7
	Non HT40, 6 to 54 Mbps	3	5	-50.1	-52.0	-50.0	-40.8	-21.25	19.6
	HT/VHT40, M0 to M7	1	5	-51.5			-46.5	-21.25	25.3
	HT/VHT40, M0 to M7	2	5	-50.8	-52.7		-43.6	-21.25	22.4
	HT/VHT40, M8 to M15	2	5	-50.8	-52.7		-43.6	-21.25	22.4
	HT/VHT40, M0 to M7	3	5	-50.8	-52.7	-50.1	-41.3	-21.25	20.0
	HT/VHT40, M8 to M15	3	5	-50.8	-52.7	-50.1	-41.3	-21.25	20.0
	HT/VHT40 Beam Forming, M0 to M7	2	8	-52.5	-57.9		-43.4	-21.25	22.1
	HT/VHT40 Beam Forming, M8 to M15	2	5	-50.8	-52.7		-43.6	-21.25	22.4
	HT/VHT40 Beam Forming, M0 to M7	3	10	-58.2	-53.7	-53.1	-39.7	-21.25	18.5
	HT/VHT40 Beam Forming, M8 to M15	3	7	-52.5	-57.9	-53.8	-42.4	-21.25	21.2
	HT/VHT40 STBC, M0 to M7	2	5	-50.8	-52.7		-43.6	-21.25	22.4
	HT/VHT40 STBC, M0 to M7	3	5	-50.8	-52.7	-50.1	-41.3	-21.25	20.0

5530	Non HT80, 6 to 54 Mbps	1	5	-53.2			-48.2	-21.25	27.0
	Non HT80, 6 to 54 Mbps	2	5	-53.2	-52.9		-45.0	-21.25	23.8
	Non HT80, 6 to 54 Mbps	3	5	-53.3	-51.4	-55.9	-43.4	-21.25	22.1
	VHT80, M0 to M9 1ss	1	5	-51.7			-46.7	-21.25	25.5
	VHT80, M0 to M9 1ss	2	5	-51.7	-58.4		-45.9	-21.25	24.6
	VHT80, M0 to M9 2ss	2	5	-51.7	-58.4		-45.9	-21.25	24.6
	VHT80, M0 to M9 1ss	3	5	-52.5	-59.7	-57.8	-45.8	-21.25	24.5
	VHT80, M0 to M9 2ss	3	5	-52.5	-59.7	-57.8	-45.8	-21.25	24.5
	VHT80 Beam Forming, M0 to M9 1ss	2	8	-52.5	-59.7		-43.7	-21.25	22.5
	VHT80 Beam Forming, M0 to M9 2ss	2	5	-51.7	-58.4		-45.9	-21.25	24.6
	VHT80 Beam Forming, M0 to M9 1ss	3	10	-53.9	-54.3	-58.5	-40.4	-21.25	19.1
	VHT80 Beam Forming, M0 to M9 2ss	3	7	-52.5	-59.7	-57.8	-43.8	-21.25	22.5
	VHT80 STBC, M0 to M9 1ss	2	5	-51.7	-58.4		-45.9	-21.25	24.6
	VHT80 STBC, M0 to M9 1ss	3	5	-52.5	-59.7	-57.8	-45.8	-21.25	24.5
5550	Non HT40, 6 to 54 Mbps	1	5	-58.8			-53.8	-21.25	32.6
	Non HT40, 6 to 54 Mbps	2	5	-58.8	-56.2		-49.3	-21.25	28.0
	Non HT40, 6 to 54 Mbps	3	5	-52.3	-60.1	-57.0	-45.5	-21.25	24.3
	HT/VHT40, M0 to M7	1	5	-53.9			-48.9	-21.25	27.7
	HT/VHT40, M0 to M7	2	5	-53.9	-51.1		-44.3	-21.25	23.0
	HT/VHT40, M8 to M15	2	5	-53.9	-51.1		-44.3	-21.25	23.0
	HT/VHT40, M0 to M7	3	5	-51.8	-57.9	-58.9	-45.2	-21.25	24.0
	HT/VHT40, M8 to M15	3	5	-53.9	-51.1	-56.9	-43.6	-21.25	22.3
	HT/VHT40 Beam Forming, M0 to M7	2	8	-53.9	-51.1		-41.3	-21.25	20.0
	HT/VHT40 Beam Forming, M8 to M15	2	5	-53.9	-51.1		-44.3	-21.25	23.0
	HT/VHT40 Beam Forming, M0 to M7	3	10	-52.8	-57.4	-58.0	-40.6	-21.25	19.4
	HT/VHT40 Beam Forming, M8 to M15	3	7	-53.9	-51.1	-56.9	-41.6	-21.25	20.3
	HT/VHT40 STBC, M0 to M7	2	5	-53.9	-51.1		-44.3	-21.25	23.0
	HT/VHT40 STBC, M0 to M7	3	5	-53.9	-51.1	-56.9	-43.6	-21.25	22.3
5560	Non HT20, 6 to 54 Mbps	1	5	-58.3			-53.3	-21.25	32.1
	Non HT20, 6 to 54 Mbps	2	5	-57.2	-58.1		-49.6	-21.25	28.4
	Non HT20, 6 to 54 Mbps	3	5	-56.9	-58.8	-53.1	-45.8	-21.25	24.6
	Non HT20 Beam Forming, 6 to 54 Mbps	2	8	-57.2	-58.1		-46.6	-21.25	25.4
	Non HT20 Beam Forming, 6 to 54 Mbps	3	10	-56.9	-58.8	-53.1	-40.8	-21.25	19.6
	HT/VHT20, M0 to M7	1	5	-58.0			-53.0	-21.25	31.8
	HT/VHT20, M0 to M7	2	5	-58.0	-57.2		-49.6	-21.25	28.3
	HT/VHT20, M8 to M15	2	5	-58.0	-57.2		-49.6	-21.25	28.3
	HT/VHT20, M0 to M7	3	5	-60.5	-58.1	-58.3	-49.1	-21.25	27.8
	HT/VHT20, M8 to M15	3	5	-58.8	-55.3	-59.1	-47.6	-21.25	26.3
	HT/VHT20 Beam Forming, M0 to M7	2	8	-58.0	-57.2		-46.6	-21.25	25.3
	HT/VHT20 Beam Forming, M8 to M15	2	5	-58.0	-57.2		-49.6	-21.25	28.3
	HT/VHT20 Beam Forming, M0 to M7	3	10	-60.5	-58.1	-58.3	-44.1	-21.25	22.8

	HT/VHT20 Beam Forming, M8 to M15	3	7	-58.8	-55.3	-59.1	-45.6	-21.25	24.3
	HT/VHT20 STBC, M0 to M7	2	5	-58.0	-57.2		-49.6	-21.25	28.3
	HT/VHT20 STBC, M0 to M7	3	5	-58.8	-55.3	-59.1	-47.6	-21.25	26.3
5660	Non HT20, 6 to 54 Mbps	1	5	-55.9			-50.9	-21.25	29.7
	Non HT20, 6 to 54 Mbps	2	5	-55.9	-58.9		-49.1	-21.25	27.9
	Non HT20, 6 to 54 Mbps	3	5	-57.9	-56.2	-57.2	-47.3	-21.25	26.0
	Non HT20 Beam Forming, 6 to 54 Mbps	2	8	-55.9	-58.9		-46.1	-21.25	24.9
	Non HT20 Beam Forming, 6 to 54 Mbps	3	10	-57.9	-56.2	-57.2	-42.3	-21.25	21.0
	HT/VHT20, M0 to M7	1	5	-57.9			-52.9	-21.25	31.7
	HT/VHT20, M0 to M7	2	5	-57.9	-57.9		-49.9	-21.25	28.6
	HT/VHT20, M8 to M15	2	5	-57.9	-57.9		-49.9	-21.25	28.6
	HT/VHT20, M0 to M7	3	5	-58.0	-57.8	-56.3	-47.5	-21.25	26.3
	HT/VHT20, M8 to M15	3	5	-57.9	-57.9	-57.9	-48.1	-21.25	26.9
	HT/VHT20 Beam Forming, M0 to M7	2	8	-57.9	-57.9		-46.9	-21.25	25.6
	HT/VHT20 Beam Forming, M8 to M15	2	5	-57.9	-57.9		-49.9	-21.25	28.6
	HT/VHT20 Beam Forming, M0 to M7	3	10	-58.0	-57.8	-56.3	-42.5	-21.25	21.3
	HT/VHT20 Beam Forming, M8 to M15	3	7	-57.9	-57.9	-57.9	-46.1	-21.25	24.9
	HT/VHT20 STBC, M0 to M7	2	5	-57.9	-57.9		-49.9	-21.25	28.6
HT/VHT20 STBC, M0 to M7	3	5	-57.9	-57.9	-57.9	-48.1	-21.25	26.9	
5670	Non HT40, 6 to 54 Mbps	1	5	-54.7			-49.7	-21.25	28.5
	Non HT40, 6 to 54 Mbps	2	5	-54.7	-57.3		-47.8	-21.25	26.5
	Non HT40, 6 to 54 Mbps	3	5	-57.4	-58.5	-59.2	-48.5	-21.25	27.3
	HT/VHT40, M0 to M7	1	5	-53.4			-48.4	-21.25	27.2
	HT/VHT40, M0 to M7	2	5	-53.4	-57.6		-47.0	-21.25	25.8
	HT/VHT40, M8 to M15	2	5	-53.4	-57.6		-47.0	-21.25	25.8
	HT/VHT40, M0 to M7	3	5	-53.5	-58.4	-59.4	-46.5	-21.25	25.3
	HT/VHT40, M8 to M15	3	5	-53.4	-57.6	-52.0	-44.0	-21.25	22.7
	HT/VHT40 Beam Forming, M0 to M7	2	8	-53.4	-57.6		-44.0	-21.25	22.8
	HT/VHT40 Beam Forming, M8 to M15	2	5	-53.4	-57.6		-47.0	-21.25	25.8
	HT/VHT40 Beam Forming, M0 to M7	3	10	-53.7	-58.8	-58.9	-41.6	-21.25	20.4
	HT/VHT40 Beam Forming, M8 to M15	3	7	-53.4	-57.6	-52.0	-42.0	-21.25	20.7
	HT/VHT40 STBC, M0 to M7	2	5	-53.4	-57.6		-47.0	-21.25	25.8
HT/VHT40 STBC, M0 to M7	3	5	-53.4	-57.6	-52.0	-44.0	-21.25	22.7	
5690	Non HT80, 6 to 54 Mbps	1	5	-55.9			-50.9	-21.25	29.7
	Non HT80, 6 to 54 Mbps	2	5	-55.9	-55.9		-47.9	-21.25	26.6
	Non HT80, 6 to 54 Mbps	3	5	-55.9	-55.9	-56.7	-46.4	-21.25	25.1
	VHT80, M0 to M9 1ss	1	5	-57.2			-52.2	-21.25	31.0
	VHT80, M0 to M9 1ss	2	5	-57.2	-58.4		-49.7	-21.25	28.5
	VHT80, M0 to M9 2ss	2	5	-57.2	-58.4		-49.7	-21.25	28.5
	VHT80, M0 to M9 1ss	3	5	-57.2	-58.4	-58.0	-48.1	-21.25	26.8

	VHT80, M0 to M9 2ss	3	5	-57.2	-58.4	-58.0	-48.1	-21.25	26.8
	VHT80 Beam Forming, M0 to M9 1ss	2	8	-57.2	-58.4		-46.7	-21.25	25.5
	VHT80 Beam Forming, M0 to M9 2ss	2	5	-57.2	-58.4		-49.7	-21.25	28.5
	VHT80 Beam Forming, M0 to M9 1ss	3	10	-59.7	-57.6	-58.4	-43.7	-21.25	22.5
	VHT80 Beam Forming, M0 to M9 2ss	3	7	-57.2	-58.4	-58.0	-46.1	-21.25	24.8
	VHT80 STBC, M0 to M9 1ss	2	5	-57.2	-58.4		-49.7	-21.25	28.5
	VHT80 STBC, M0 to M9 1ss	3	5	-57.2	-58.4	-58.0	-48.1	-21.25	26.8
5700	Non HT20, 6 to 54 Mbps	1	5	-58.4			-53.4	-21.25	32.2
	Non HT20, 6 to 54 Mbps	2	5	-56.1	-56.8		-48.4	-21.25	27.2
	Non HT20, 6 to 54 Mbps	3	5	-56.8	-58.3	-56.6	-47.4	-21.25	26.1
	Non HT20 Beam Forming, 6 to 54 Mbps	2	8	-56.1	-56.8		-45.4	-21.25	24.2
	Non HT20 Beam Forming, 6 to 54 Mbps	3	10	-56.8	-58.3	-56.6	-42.4	-21.25	21.1
	HT/VHT20, M0 to M7	1	5	-56.3			-51.3	-21.25	30.1
	HT/VHT20, M0 to M7	2	5	-56.3	-57.5		-48.8	-21.25	27.6
	HT/VHT20, M8 to M15	2	5	-56.3	-57.5		-48.8	-21.25	27.6
	HT/VHT20, M0 to M7	3	5	-57.3	-59.9	-55.9	-47.6	-21.25	26.4
	HT/VHT20, M8 to M15	3	5	-57.6	-56.5	-57.0	-47.2	-21.25	26.0
	HT/VHT20 Beam Forming, M0 to M7	2	8	-56.3	-57.5		-45.8	-21.25	24.6
	HT/VHT20 Beam Forming, M8 to M15	2	5	-56.3	-57.5		-48.8	-21.25	27.6
	HT/VHT20 Beam Forming, M0 to M7	3	10	-57.3	-59.9	-55.9	-42.6	-21.25	21.4
	HT/VHT20 Beam Forming, M8 to M15	3	7	-57.6	-56.5	-57.0	-45.2	-21.25	24.0
	HT/VHT20 STBC, M0 to M7	2	5	-56.3	-57.5		-48.8	-21.25	27.6
HT/VHT20 STBC, M0 to M7	3	5	-57.6	-56.5	-57.0	-47.2	-21.25	26.0	
5710	Non HT40, 6 to 54 Mbps	1	5	-57.8			-52.8	-21.25	31.6
	Non HT40, 6 to 54 Mbps	2	5	-57.8	-58.2		-50.0	-21.25	28.7
	Non HT40, 6 to 54 Mbps	3	5	-56.7	-56.3	-57.5	-47.0	-21.25	25.8
	HT/VHT40, M0 to M7	1	5	-57.2			-52.2	-21.25	31.0
	HT/VHT40, M0 to M7	2	5	-57.2	-57.8		-49.5	-21.25	28.2
	HT/VHT40, M8 to M15	2	5	-57.2	-57.8		-49.5	-21.25	28.2
	HT/VHT40, M0 to M7	3	5	-56.8	-57.2	-57.5	-47.4	-21.25	26.1
	HT/VHT40, M8 to M15	3	5	-57.2	-57.8	-54.6	-46.5	-21.25	25.3
	HT/VHT40 Beam Forming, M0 to M7	2	8	-57.2	-57.8		-46.5	-21.25	25.2
	HT/VHT40 Beam Forming, M8 to M15	2	5	-57.2	-57.8		-49.5	-21.25	28.2
	HT/VHT40 Beam Forming, M0 to M7	3	10	-56.8	-57.2	-57.5	-42.4	-21.25	21.1
	HT/VHT40 Beam Forming, M8 to M15	3	7	-57.2	-57.8	-54.6	-44.5	-21.25	23.3
	HT/VHT40 STBC, M0 to M7	2	5	-57.2	-57.8		-49.5	-21.25	28.2
	HT/VHT40 STBC, M0 to M7	3	5	-57.2	-57.8	-54.6	-46.5	-21.25	25.3

5720	Non HT20, 6 to 54 Mbps	1	5	-55.1			-50.1	-21.25	28.9
	Non HT20, 6 to 54 Mbps	2	5	-57.6	-59.1		-50.3	-21.25	29.0
	Non HT20, 6 to 54 Mbps	3	5	-54.4	-56.8	-57.9	-46.3	-21.25	25.1
	Non HT20 Beam Forming, 6 to 54 Mbps	2	8	-57.6	-59.1		-47.3	-21.25	26.0
	Non HT20 Beam Forming, 6 to 54 Mbps	3	10	-54.4	-56.8	-57.9	-41.3	-21.25	20.1
	HT/VHT20, M0 to M7	1	5	-58.2			-53.2	-21.25	32.0
	HT/VHT20, M0 to M7	2	5	-58.2	-56.3		-49.1	-21.25	27.9
	HT/VHT20, M8 to M15	2	5	-58.2	-56.3		-49.1	-21.25	27.9
	HT/VHT20, M0 to M7	3	5	-55.4	-57.1	-57.9	-46.9	-21.25	25.7
	HT/VHT20, M8 to M15	3	5	-59.0	-58.4	-56.5	-48.1	-21.25	26.8
	HT/VHT20 Beam Forming, M0 to M7	2	8	-58.2	-56.3		-46.1	-21.25	24.9
	HT/VHT20 Beam Forming, M8 to M15	2	5	-58.2	-56.3		-49.1	-21.25	27.9
	HT/VHT20 Beam Forming, M0 to M7	3	10	-55.4	-57.1	-57.9	-41.9	-21.25	20.7
	HT/VHT20 Beam Forming, M8 to M15	3	7	-59.0	-58.4	-56.5	-46.1	-21.25	24.8
	HT/VHT20 STBC, M0 to M7	2	5	-58.2	-56.3		-49.1	-21.25	27.9
	HT/VHT20 STBC, M0 to M7	3	5	-59.0	-58.4	-56.5	-48.1	-21.25	26.8



Conducted Spurs Peak, 5500 MHz, HT/VHT20 Beam Forming, M8 to M15

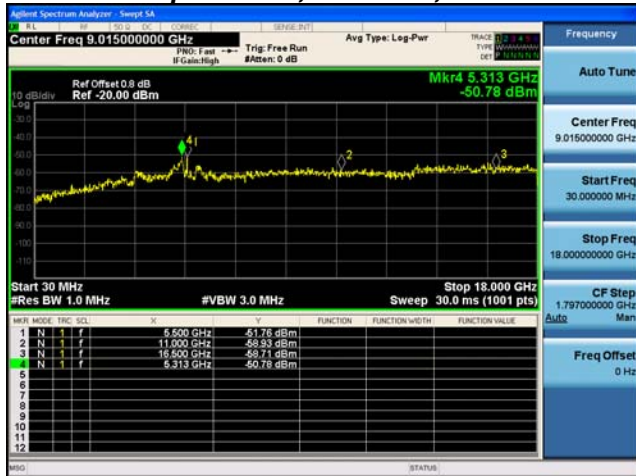

Antenna A

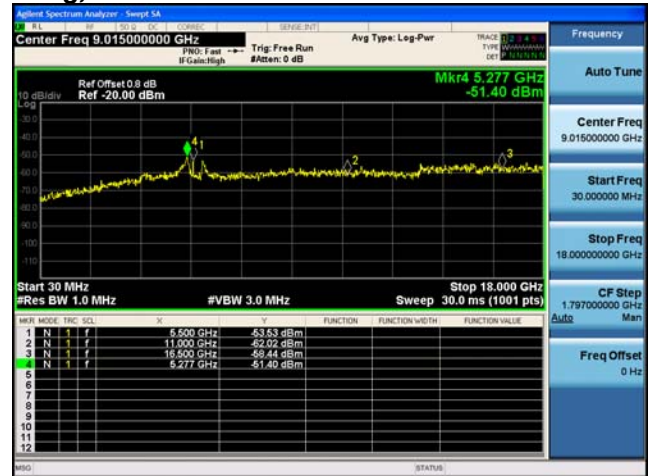

Antenna B

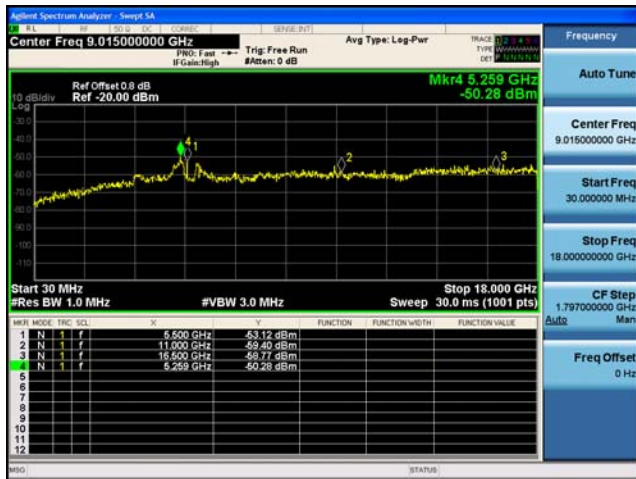

Antenna C

A.4 Conducted Bandedge

15.205 / 15.209 - Radiated emissions which fall in the restricted bands, as defined in Section 15.205(a), must also comply with the radiated emission limits specified in Section 15.209(a) (see Section 15.205(c)).

Use formula below to substitute conducted measurements in place of radiated measurements

$$E[\text{dB}\mu\text{V}/\text{m}] = \text{EIRP}[\text{dBm}] - 20 \log(d[\text{meters}]) + 104.77, \text{ where } E = \text{field strength and } d = 3 \text{ meter}$$

- 1) Average Plot, Limit= -41.25 dBm eirp
- 2) Peak plot, Limit = -21.25 dBm eirp

Note:

The Intentional Beamforming correlated array gain for any number of space time streams is given by the general formula:

$$G_{\text{bf_max}} = 10 * \log_{10}(N_{\text{tx}}/N_{\text{sts}})$$

where N_{tx} is the number of equal power active transmit antennas and N_{sts} is the number of active space time streams.

Test Procedure

Ref. KDB 789033 D02 General UNII Test Procedures New Rules v01r03
ANSI C63.10: 2013

Conducted Bandedge
Test Procedure
<ol style="list-style-type: none"> 1. Connect the antenna port(s) to the spectrum analyzer input. 2. Place the radio in continuous transmit mode. Use the procedures in ANSI C63.10: 2013 to substitute conducted measurements in place of radiated measurements. 3. Configure Spectrum analyzer as per test parameters below (be sure to enter all losses between the transmitter output and the spectrum analyzer). 4. Place a marker at the end of the restricted band closest to the transmit frequency to show compliance. Also measure any emissions in the restricted bands. 5. The "measure-and-sum technique" is used for measuring in-band transmit power of a device. In the measure-and-sum approach, the conducted emission level is measured at each antenna port. The measured results at the various antenna ports are then summed mathematically to determine the total emission level from the device. Summing is performed in linear power units. The worst case output is recorded. 6. Place a marker at the end of the restricted band closest to the transmit frequency to show compliance. Also measure any emissions in the restricted bands 7. Capture graphs and record pertinent measurement data.

Ref. ANSI C63.10: 2013 section 12.7.6 (peak) & 12.7.7.3 (average, Method VB-A (Alternative))

Conducted Bandedge
Test parameters restricted Band
RBW = 1 MHz VBW ≥ 3 x RBW for Peak, 100Hz for Average Sweep = Auto couple Detector = Peak Trace = Max Hold.

System Number	Description	Samples	System under test	Support equipment
1	EUT	S01	<input checked="" type="checkbox"/>	<input type="checkbox"/>
	Support	S02	<input type="checkbox"/>	<input checked="" type="checkbox"/>



Tested By : Jose Aguirre	Date of testing: 05-May-16 - 06-Jun-16
Test Result : PASS	

See Appendix C for list of test equipment

Frequency (MHz)	Mode	Tx Paths	Correlated Antenna Gain (dBi)	Tx 1 Bandedge Level (dBm)	Tx 2 Bandedge Level (dBm)	Tx 3 Bandedge Level (dBm)	Total Tx Bandedge Level (dBm)	Limit (dBm)	Margin (dB)
5500	Non HT20, 6 to 54 Mbps	1	5	-57.1			-52.1	-41.25	10.9
	Non HT20, 6 to 54 Mbps	2	5	-57.1	-56.2		-48.6	-41.25	7.4
	Non HT20, 6 to 54 Mbps	3	5	-61.6	-60.1	-56.0	-48.8	-41.25	7.5
	Non HT20 Beam Forming, 6 to 54 Mbps	2	8	-57.1	-56.2		-45.6	-41.25	4.4
	Non HT20 Beam Forming, 6 to 54 Mbps	3	10	-61.6	-60.1	-56.0	-43.8	-41.25	2.5
	HT/VHT20, M0 to M7	1	5	-57.5			-52.5	-41.25	11.3
	HT/VHT20, M0 to M7	2	5	-57.5	-56.1		-48.7	-41.25	7.5
	HT/VHT20, M8 to M15	2	5	-57.5	-56.1		-48.7	-41.25	7.5
	HT/VHT20, M0 to M7	3	5	-61.1	-60.1	-56.1	-48.8	-41.25	7.5
	HT/VHT20, M8 to M15	3	5	-57.5	-56.1	-53.1	-45.4	-41.25	4.1
	HT/VHT20 Beam Forming, M0 to M7	2	8	-57.5	-56.1		-45.7	-41.25	4.5
	HT/VHT20 Beam Forming, M8 to M15	2	5	-57.5	-56.1		-48.7	-41.25	7.5
	HT/VHT20 Beam Forming, M0 to M7	3	10	-57.5	-59.0	-55.9	-42.5	-41.3	1.3
	HT/VHT20 Beam Forming, M8 to M15	3	7	-53.9	-54.6	-52.9	-42.0	-41.3	0.7
	HT/VHT20 STBC, M0 to M7	2	5	-57.5	-56.1		-48.7	-41.25	7.5
HT/VHT20 STBC, M0 to M7	3	5	-57.5	-56.1	-53.1	-45.4	-41.25	4.1	
5510	Non HT40, 6 to 54 Mbps	1	5	-50.0			-45.0	-41.25	3.8
	Non HT40, 6 to 54 Mbps	2	5	-50.0	-54.4		-43.7	-41.25	2.4
	Non HT40, 6 to 54 Mbps	3	5	-52.5	-53.3	-51.6	-42.6	-41.3	1.4
	HT/VHT40, M0 to M7	1	5	-47.0			-42.0	-41.3	0.8
	HT/VHT40, M0 to M7	2	5	-48.2	-50.9		-41.3	-41.3	0.1
	HT/VHT40, M8 to M15	2	5	-48.2	-50.9		-41.3	-41.3	0.1
	HT/VHT40, M0 to M7	3	5	-54.0	-54.2	-50.4	-42.7	-41.3	1.5
	HT/VHT40, M8 to M15	3	5	-54.0	-54.2	-50.4	-42.7	-41.3	1.5
	HT/VHT40 Beam Forming, M0 to M7	2	8	-53.6	-53.3		-42.4	-41.3	1.2
	HT/VHT40 Beam Forming, M8 to M15	2	5	-48.2	-50.9		-41.3	-41.3	0.1
	HT/VHT40 Beam Forming, M0 to M7	3	10	-57.4	-58.2	-53.9	-41.3	-41.3	0.1
	HT/VHT40 Beam Forming, M8 to M15	3	7	-56.4	-56.6	-51.6	-42.4	-41.3	1.2
	HT/VHT40 STBC, M0 to M7	2	5	-48.2	-50.9		-41.3	-41.3	0.1
	HT/VHT40 STBC, M0 to M7	3	5	-53.6	-54.2	-51.6	-43.2	-41.3	2.0

5530	Non HT80, 6 to 54 Mbps	1	5	-48.1			-43.1	-41.3	1.9
	Non HT80, 6 to 54 Mbps	2	5	-49.3	-51.3		-42.2	-41.3	0.9
	Non HT80, 6 to 54 Mbps	3	5	-52.5	-54.7	-50.8	-42.6	-41.3	1.4
	VHT80, M0 to M9 1ss	1	5	-48.7			-43.7	-41.3	2.5
	VHT80, M0 to M9 1ss	2	5	-49.1	-51.5		-42.1	-41.3	0.9
	VHT80, M0 to M9 2ss	2	5	-49.1	-51.5		-42.1	-41.3	0.9
	VHT80, M0 to M9 1ss	3	5	-51.5	-53.8	-50.4	-41.9	-41.3	0.7
	VHT80, M0 to M9 2ss	3	5	-51.5	-53.8	-50.4	-41.9	-41.3	0.7
	VHT80 Beam Forming, M0 to M9 1ss	2	8	-51.5	-53.8		-41.5	-41.3	0.2
	VHT80 Beam Forming, M0 to M9 2ss	2	5	-49.1	-51.5		-42.1	-41.3	0.9
	VHT80 Beam Forming, M0 to M9 1ss	3	10	-58.6	-57.3	-53.9	-41.4	-41.3	0.1
	VHT80 Beam Forming, M0 to M9 2ss	3	7	-54.7	-56.5	-51.3	-41.8	-41.3	0.6
	VHT80 STBC, M0 to M9 1ss	2	5	-49.1	-51.5		-42.1	-41.3	0.9
	VHT80 STBC, M0 to M9 1ss	3	5	-51.5	-53.8	-50.4	-41.9	-41.3	0.7



Conducted Bandedge Average, 5500 MHz, HT/VHT20 Beam Forming, M8 to M15

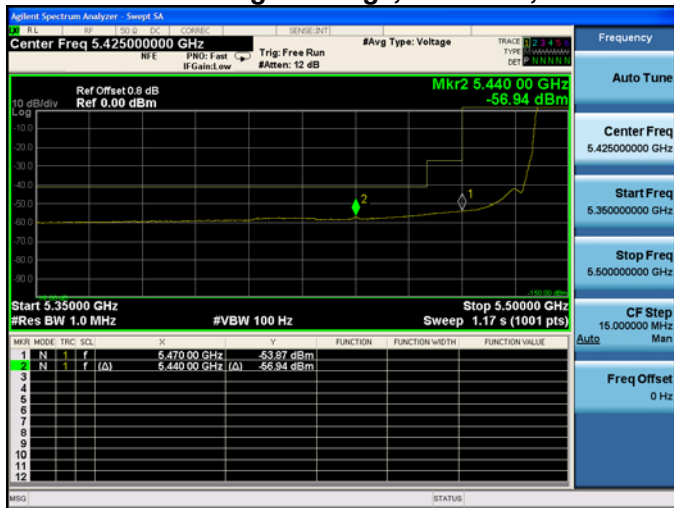

Antenna A

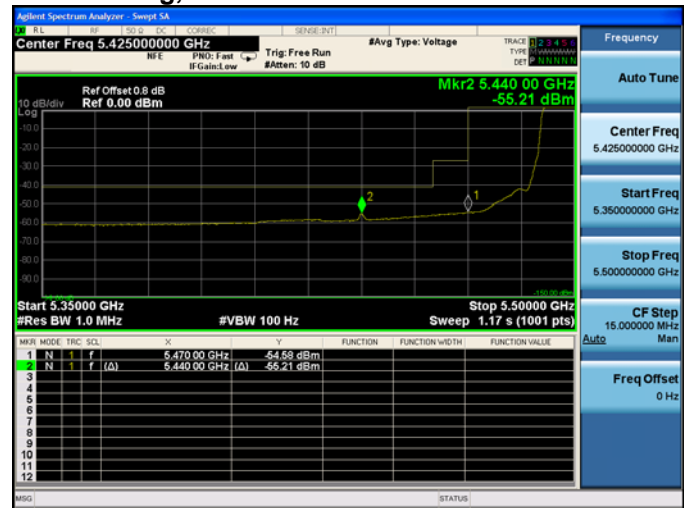

Antenna B

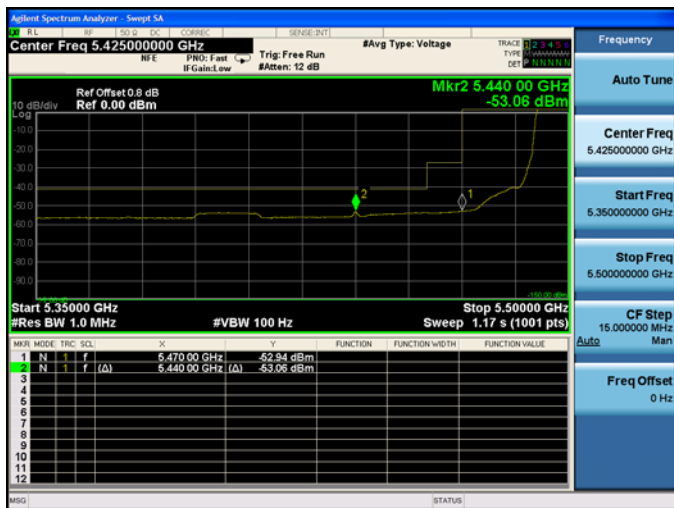

Antenna C



Conducted Bandedge Average, 5510 MHz, HT/VHT40, M0 to M7

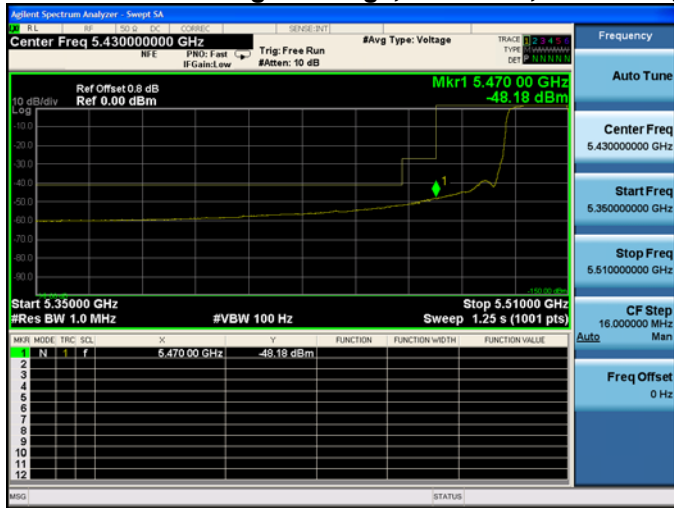

Antenna A

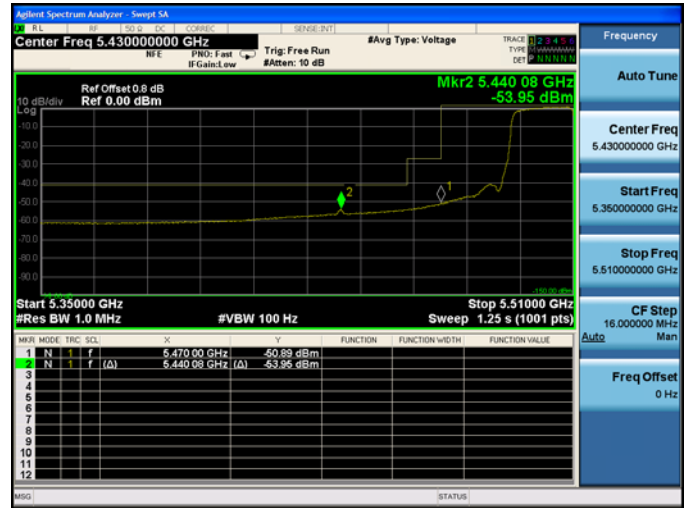

Antenna B



Conducted Bandedge Average, 5530 MHz, VHT80 Beam Forming, M0 to M9 1ss

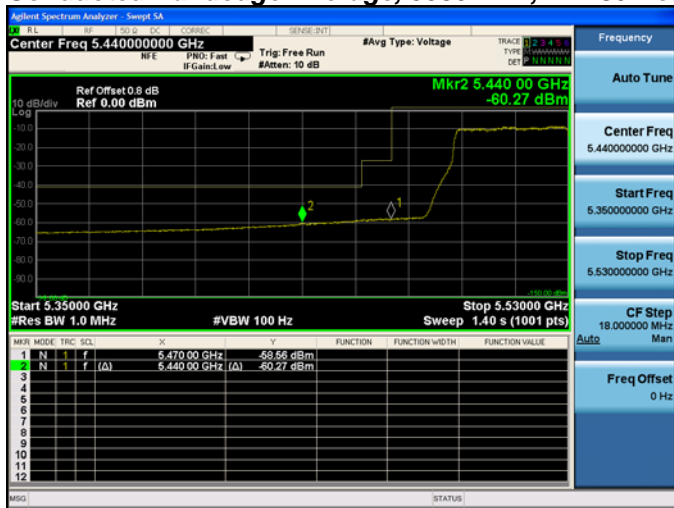

Antenna A



Antenna B

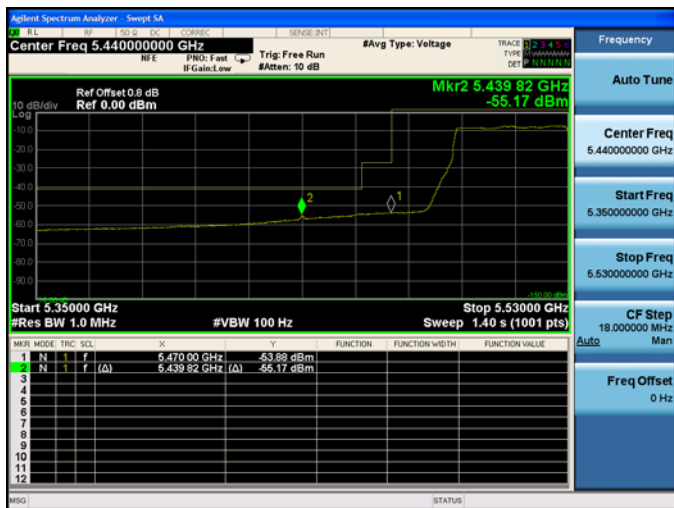

Antenna C

Frequency (MHz)	Mode	Tx Paths	Correlated Antenna Gain (dBi)	Tx 1 Bandedge Level (dBm)	Tx 2 Bandedge Level (dBm)	Tx 3 Bandedge Level (dBm)	Total Tx Bandedge Level (dBm)	Limit (dBm)	Margin (dB)
5500	Non HT20, 6 to 54 Mbps	1	5	-42.7			-37.7	-21.25	16.5
	Non HT20, 6 to 54 Mbps	2	5	-42.7	-42.2		-34.4	-21.25	13.2
	Non HT20, 6 to 54 Mbps	3	5	-43.5	-45.8	-44.5	-34.7	-21.25	13.5
	Non HT20 Beam Forming, 6 to 54 Mbps	2	8	-42.7	-42.2		-31.4	-21.25	10.2
	Non HT20 Beam Forming, 6 to 54 Mbps	3	10	-43.5	-45.8	-44.5	-29.7	-21.25	8.5
	HT/VHT20, M0 to M7	1	5	-41.7			-36.7	-21.25	15.5
	HT/VHT20, M0 to M7	2	5	-41.7	-42.0		-33.8	-21.25	12.6
	HT/VHT20, M8 to M15	2	5	-41.7	-42.0		-33.8	-21.25	12.6
	HT/VHT20, M0 to M7	3	5	-45.4	-46.2	-44.1	-35.4	-21.25	14.1
	HT/VHT20, M8 to M15	3	5	-41.7	-42.0	-41.4	-31.9	-21.25	10.7
	HT/VHT20 Beam Forming, M0 to M7	2	8	-41.7	-42.0		-30.8	-21.25	9.6
	HT/VHT20 Beam Forming, M8 to M15	2	5	-41.7	-42.0		-33.8	-21.25	12.6
	HT/VHT20 Beam Forming, M0 to M7	3	10	-45.4	-46.2	-44.1	-30.4	-21.25	9.1
	HT/VHT20 Beam Forming, M8 to M15	3	7	-41.7	-42.0	-41.4	-29.9	-21.25	8.7
	HT/VHT20 STBC, M0 to M7	2	5	-41.7	-42.0		-33.8	-21.25	12.6
HT/VHT20 STBC, M0 to M7	3	5	-41.7	-42.0	-41.4	-31.9	-21.25	10.7	
5510	Non HT40, 6 to 54 Mbps	1	5	-36.0			-31.0	-21.25	9.8
	Non HT40, 6 to 54 Mbps	2	5	-36.0	-41.3		-29.9	-21.25	8.6
	Non HT40, 6 to 54 Mbps	3	5	-36.0	-41.3	-39.8	-28.7	-21.25	7.4
	HT/VHT40, M0 to M7	1	5	-31.5			-26.5	-21.25	5.3
	HT/VHT40, M0 to M7	2	5	-34.7	-39.3		-28.4	-21.25	7.2
	HT/VHT40, M8 to M15	2	5	-34.7	-39.3		-28.4	-21.25	7.2
	HT/VHT40, M0 to M7	3	5	-34.7	-39.3	-39.5	-27.5	-21.25	6.2
	HT/VHT40, M8 to M15	3	5	-34.7	-39.3	-39.5	-27.5	-21.25	6.2
	HT/VHT40 Beam Forming, M0 to M7	2	8	-39.1	-41.5		-29.1	-21.25	7.9
	HT/VHT40 Beam Forming, M8 to M15	2	5	-34.7	-39.3		-28.4	-21.25	7.2
	HT/VHT40 Beam Forming, M0 to M7	3	10	-42.1	-44.1	-43.0	-28.2	-21.25	7.0
	HT/VHT40 Beam Forming, M8 to M15	3	7	-39.1	-41.5	-40.3	-28.4	-21.25	7.2
	HT/VHT40 STBC, M0 to M7	2	5	-34.7	-39.3		-28.4	-21.25	7.2
	HT/VHT40 STBC, M0 to M7	3	5	-34.7	-39.3	-39.5	-27.5	-21.25	6.2

5530	Non HT80, 6 to 54 Mbps	1	5	-31.2			-26.2	-21.25	5.0
	Non HT80, 6 to 54 Mbps	2	5	-31.2	-41.2		-25.8	-21.25	4.5
	Non HT80, 6 to 54 Mbps	3	5	-38.2	-41.7	-40.5	-30.1	-21.25	8.9
	VHT80, M0 to M9 1ss	1	5	-35.3			-30.3	-21.25	9.1
	VHT80, M0 to M9 1ss	2	5	-35.3	-39.8		-29.0	-21.25	7.7
	VHT80, M0 to M9 2ss	2	5	-35.3	-39.8		-29.0	-21.25	7.7
	VHT80, M0 to M9 1ss	3	5	-39.5	-41.6	-39.5	-30.3	-21.25	9.1
	VHT80, M0 to M9 2ss	3	5	-39.5	-41.6	-39.5	-30.3	-21.25	9.1
	VHT80 Beam Forming, M0 to M9 1ss	2	8	-39.5	-41.6		-29.4	-21.25	8.2
	VHT80 Beam Forming, M0 to M9 2ss	2	5	-35.3	-39.8		-29.0	-21.25	7.7
	VHT80 Beam Forming, M0 to M9 1ss	3	10	-43.8	-43.2	-41.9	-28.1	-21.25	6.9
	VHT80 Beam Forming, M0 to M9 2ss	3	7	-39.5	-41.6	-39.5	-28.3	-21.25	7.1
	VHT80 STBC, M0 to M9 1ss	2	5	-35.3	-39.8		-29.0	-21.25	7.7
	VHT80 STBC, M0 to M9 1ss	3	5	-39.5	-41.6	-39.5	-30.3	-21.25	9.1



Conducted Bandedge Peak, 5530 MHz, Non HT80, 6 to 54 Mbps



Antenna A



Antenna B



Title: Physical Test Arrangement Photograph

This is a dual band 2.4GHz / 5GHz device. All ports in this test set up photo are connected as all testing is automated. Section 2.6 of this test report given an overview of the different Tx antenna combinations used by this device.

Appendix B: Emission Test Results

Testing Laboratory: Cisco Systems, Inc., 125 West Tasman Drive, San Jose, CA 95134, USA

Radiated Emission Setup Diagram-Below 1G

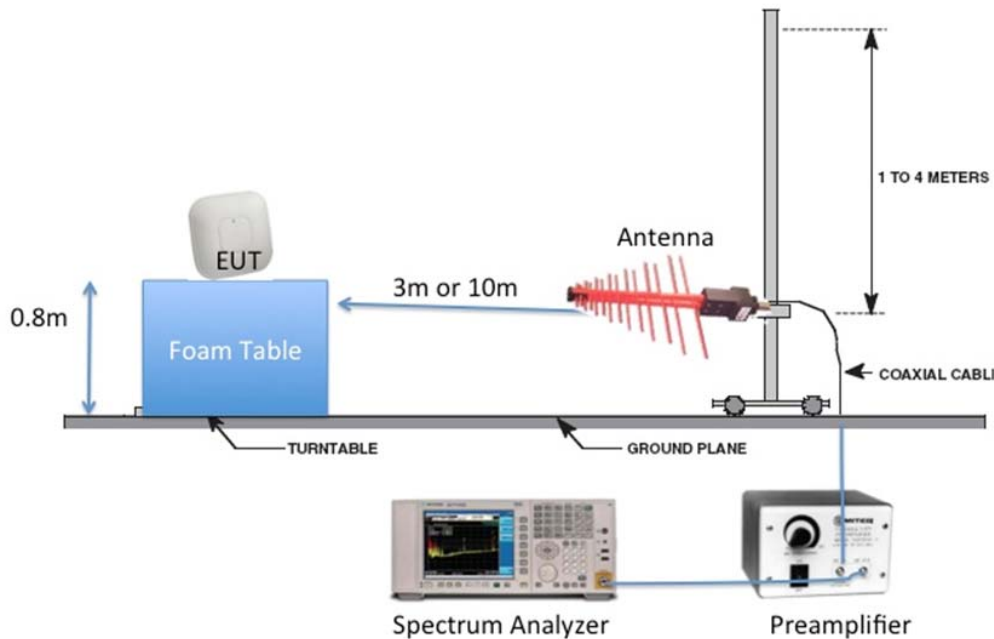

Radiated Emission Setup Diagram-Above 1G

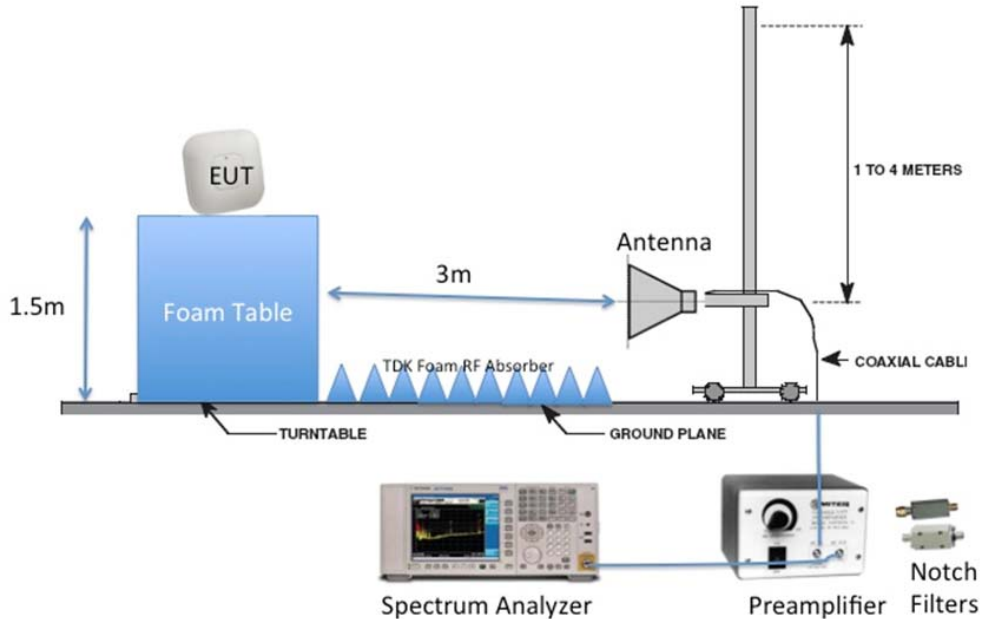



B.1 Radiated Spurious Emissions

15.407 (b) *Undesirable emission limits.* Except as shown in paragraph (b) (7) of this section, the maximum emissions outside of the frequency bands of operation shall be attenuated in accordance with the following limits:

(3) For transmitters operating in the 5.47-5.725 GHz band: All emissions outside of the 5.47-5.725 GHz band shall not exceed an e.i.r.p. of -27 dBm/MHz.

15.205 / 15.209

(7) The provisions of 15.205 apply to intentional radiators operating under this section.

(6) Unwanted emissions below 1 GHz must comply with the general field strength limits set forth in 15.209.

Ref. ANSI C63.10: 2013 section 12.7.6 (peak) & 12.7.7.3 (average)

Using Vasona, configure the spectrum analyzer as shown below (be sure to enter all losses between the transmitter output and the spectrum analyzer). Place the radio in continuous transmit mode.

Span: 1GHz – 18 GHz/18GHz-26G/26GHz-40GHz
 Reference Level: 80 dBuV
 Attenuation: 10 dB
 Sweep Time: Coupled
 Resolution Bandwidth: 1MHz
 Video Bandwidth: 3 MHz for peak, 1 KHz for average
 Detector: Peak

Terminate the access Point RF ports with 50 ohm loads.

Maximize Turntable (find worst case table angle), Maximize Antenna (find worst case height)

Save 2 plots: 1) Average plot (Vertical and Horizontal), Limit= 54dBuV/m @3m
 2) Peak plot (Vertical and Horizontal), Limit = 74dBuV/m @3m

Place a marker at the end of the restricted band closest to the transmit frequency to show compliance. Also measure any emissions in the restricted bands.

This report represents the worst case data for all supported operating modes and antennas. There are no measurable emissions above 18 GHz.

System Number	Description	Samples	System under test	Support equipment
1	EUT	S01	<input checked="" type="checkbox"/>	<input type="checkbox"/>
	Support	S02	<input type="checkbox"/>	<input checked="" type="checkbox"/>

Tested By : Jose Aguirre	Date of testing: 05-May-16 - 06-Jun-16
Test Result : PASS	

See Appendix C for list of test equipment

B.1.A Transmitter Radiated Spurious Emissions-Average Worst Case

Frequency (MHz)	Mode	Data Rate (Mbps)	Spurious Emission Level (dBuV/m)	Limit (dBuV/m)	Margin (dB)
5500	HT/VHT20, M0 to M15	M0	42.1	54	11.9
5510	HT/VHT40, M0 to M15	M0	40.4	54	13.6
5530	VHT80, M0 to M9 2ss	M0x1	40.1	54	13.9
5550	HT/VHT40, M0 to M15	M0	42	54	12
5560	HT/VHT20, M0 to M15	M0	40.2	54	13.8
5670	HT/VHT40, M0 to M15	M0	40.3	54	13.7
5690	VHT80, M0 to M9 2ss	M0x1	40.3	54	13.7
5710	HT/VHT40, M0 to M15	M0	40.4	54	13.6
5720	HT/VHT20, M0 to M15	M0	40.2	54	13.8



B.1.P.1 Radiated Transmitter Spurs, 5500 MHz, HT/VHT20, MO to M23, Average (1-18GHz)

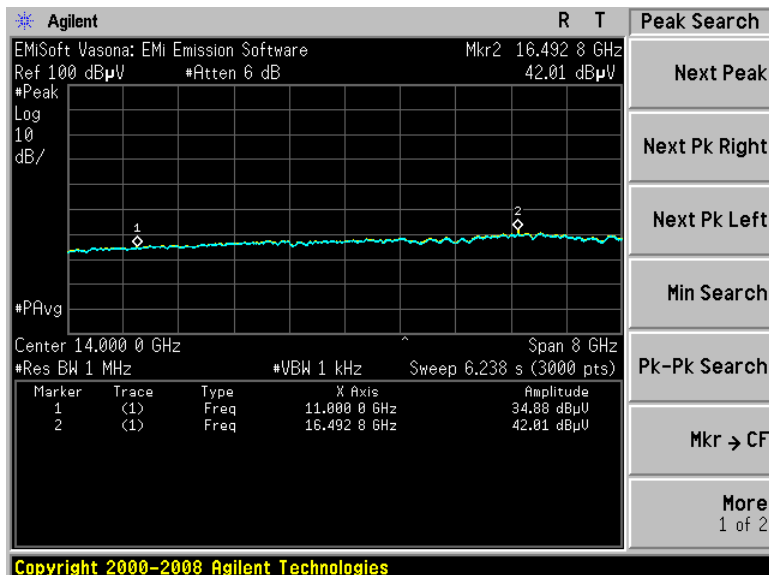
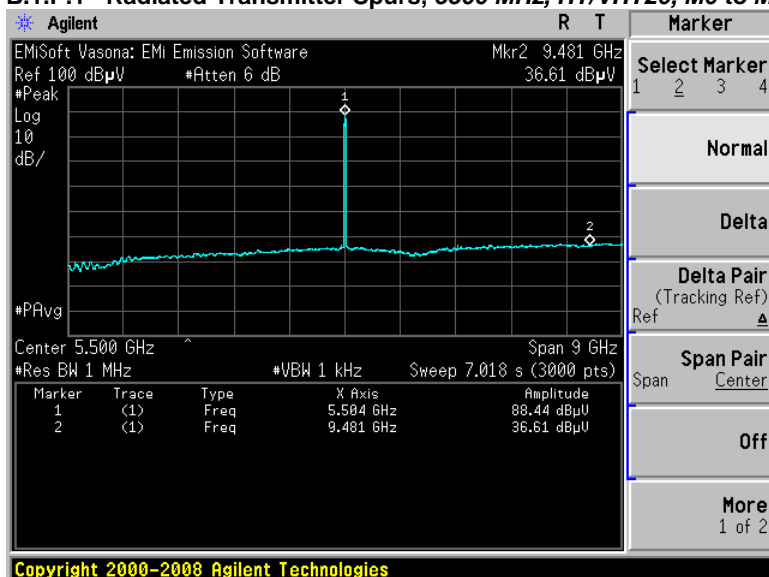



B.1.P.2 Radiated Transmitter Spurs, 5510 MHz, HT/VHT40, M0 to M23, Average (1-18GHz)

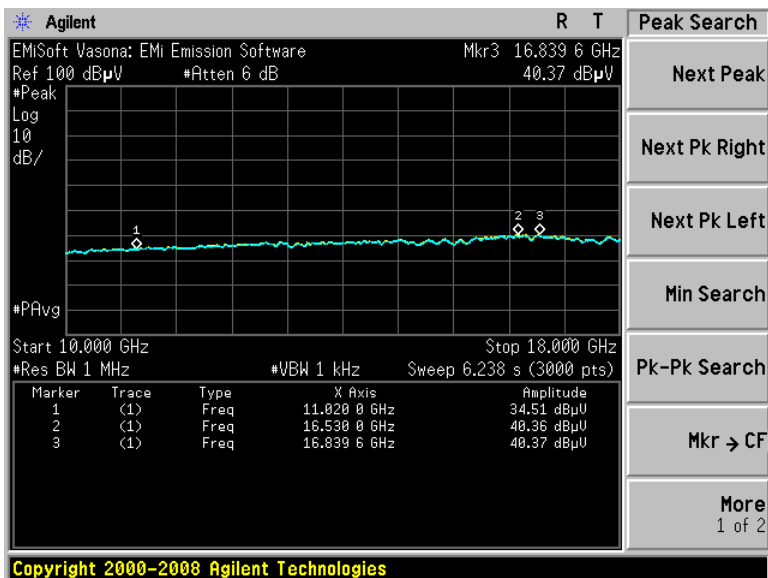
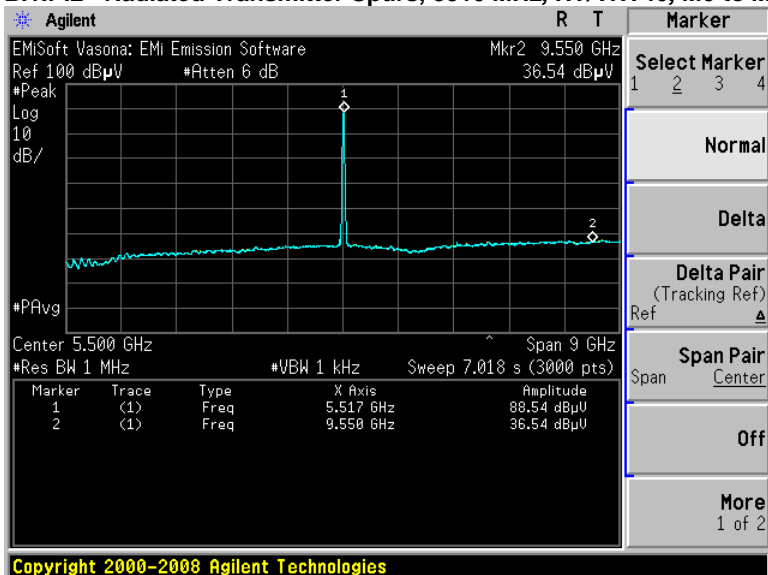

B.1.P.3 Radiated Transmitter Spurs, 5530 MHz, VHT80, M0.1 to M9.3, Average (1-18GHz)

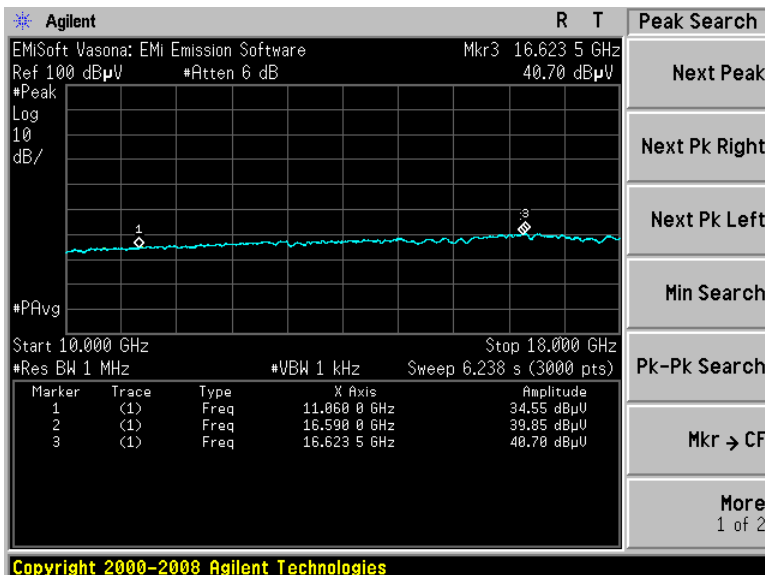
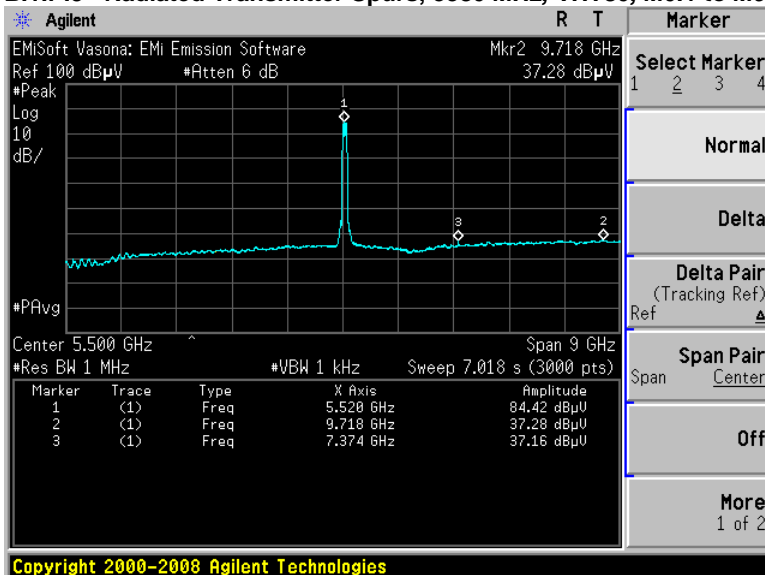

B.1.P.4 Radiated Transmitter Spurs, 5550 MHz, HT/VHT40, MO to M23, Average (1-18GHz)

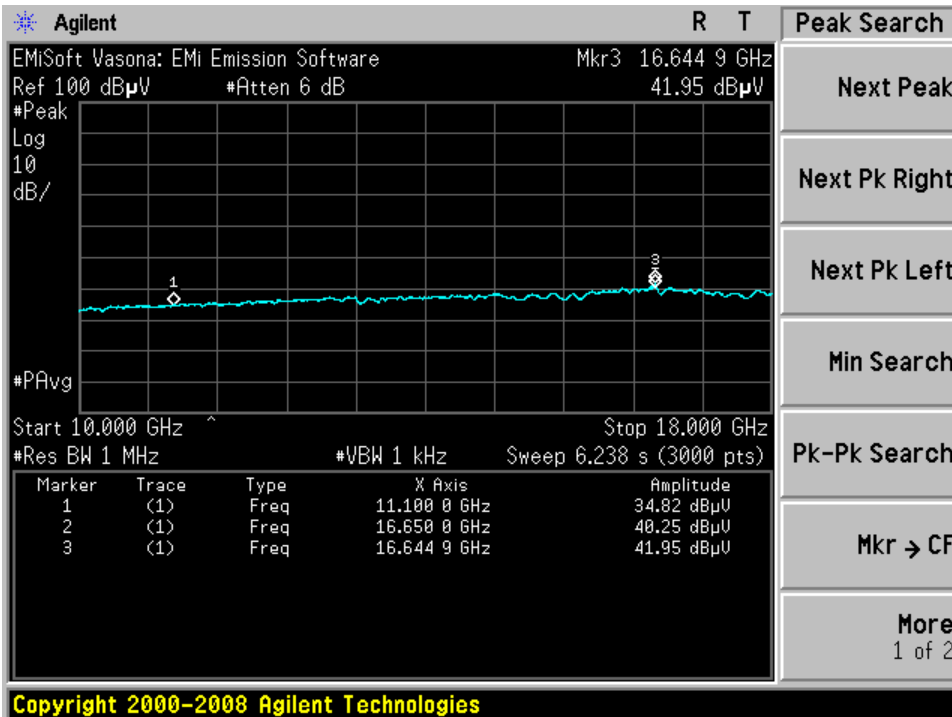
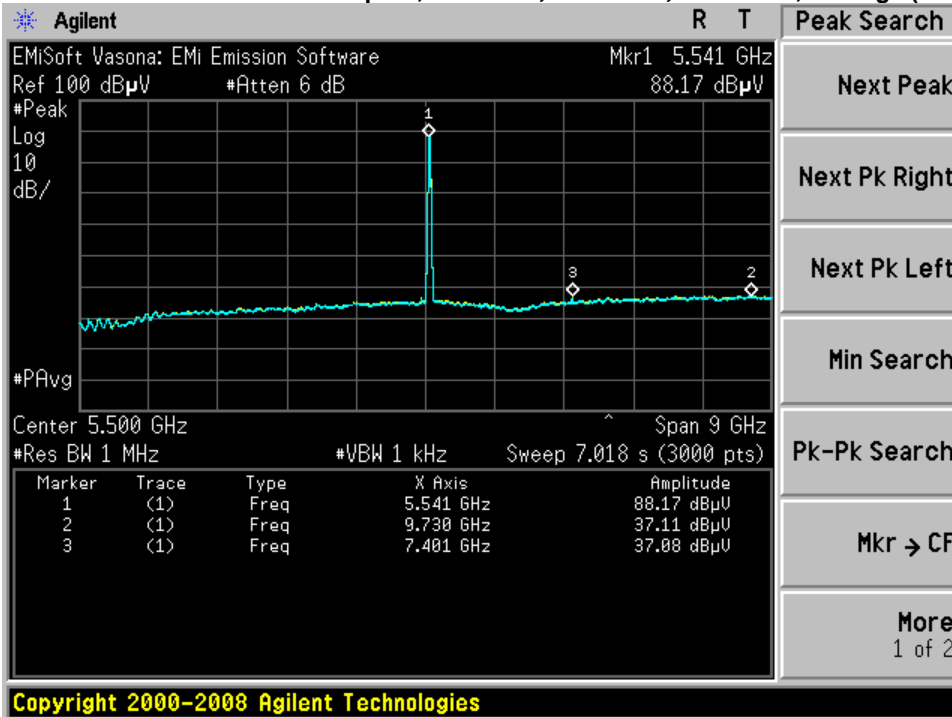

B.1.P.4 Radiated Transmitter Spurs, 5560 MHz, HT/VHT20, MO to M23, Average (1-18GHz)

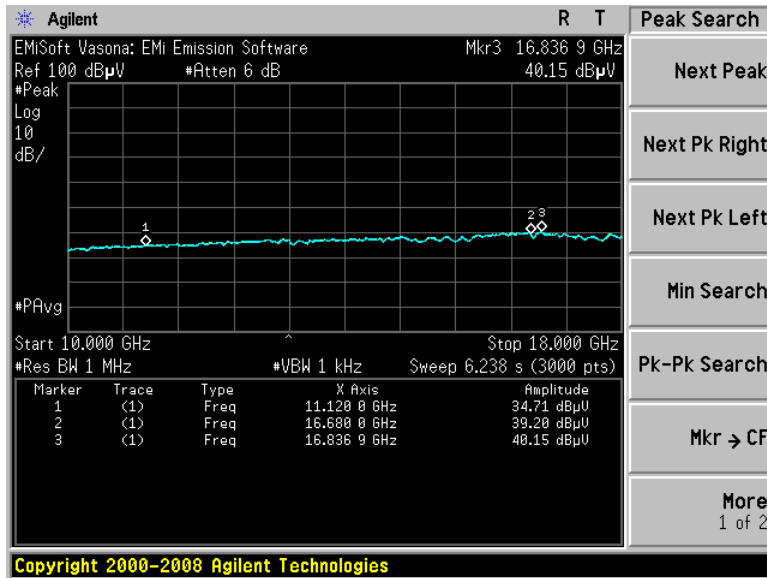
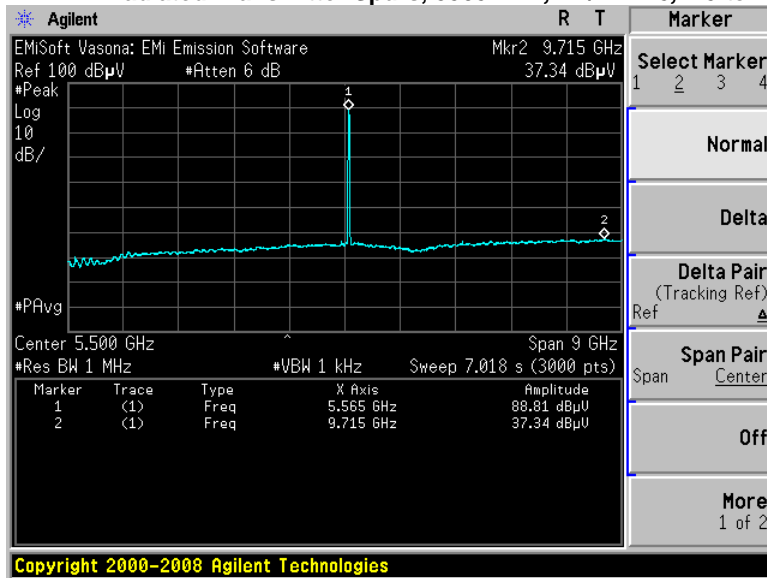



B.1.P.6 Radiated Transmitter Spurs, 5670 MHz, HT/VHT40, M0 to M23, M0.0 to M9.4, Average (1-18GHz)

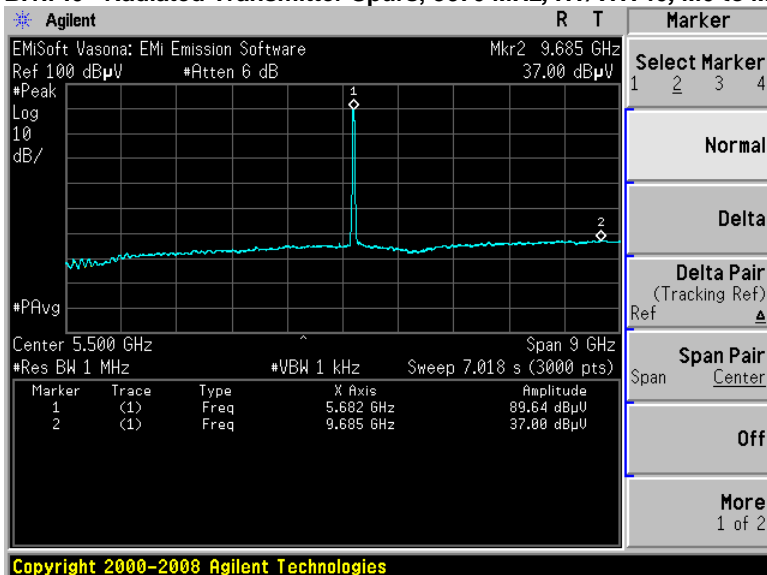

Copyright 2000-2008 Agilent Technologies

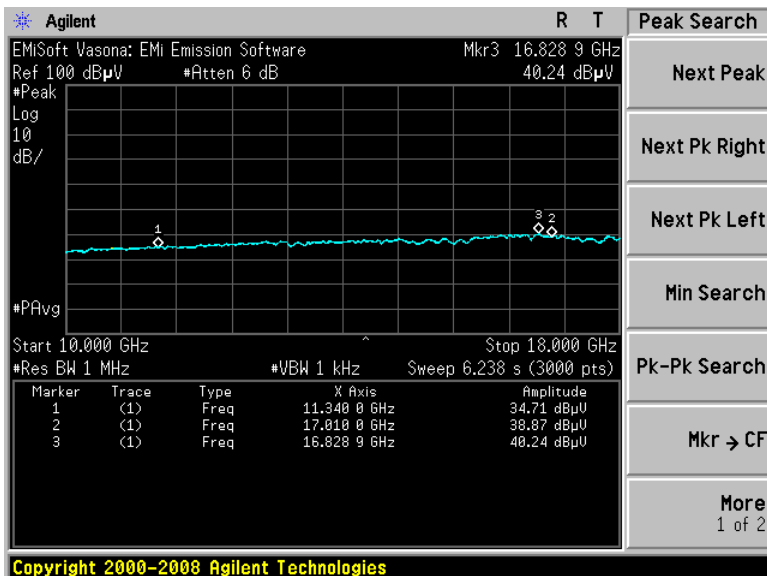

Copyright 2000-2008 Agilent Technologies



B.1.P.7 Radiated Transmitter Spurs, 5690 MHz, VHT80, M0.1 to M9.3, Average (1-18GHz)

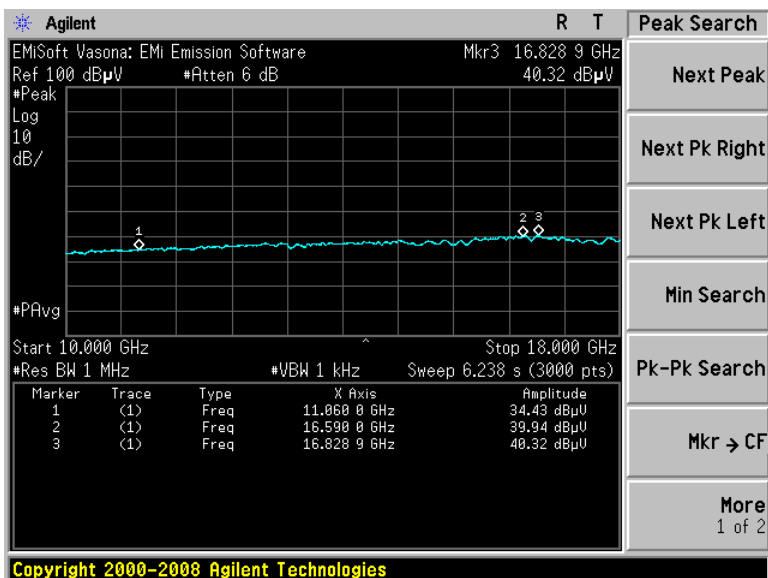
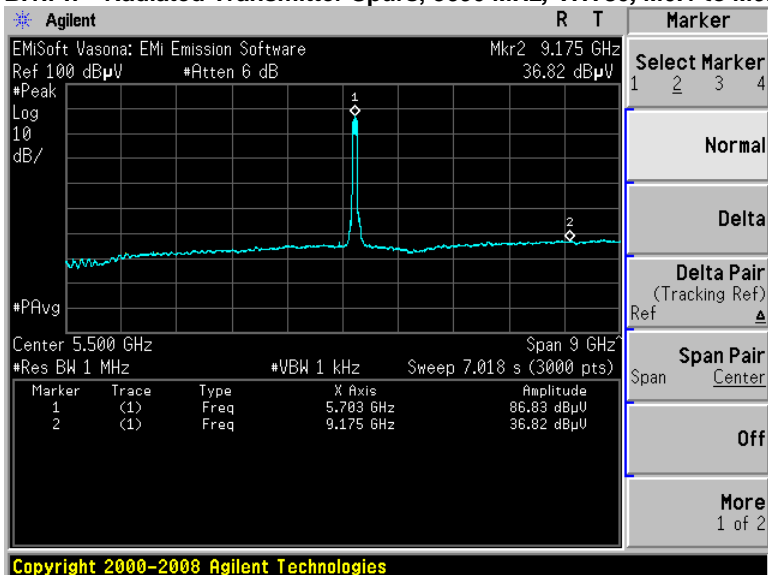

B.1.P.8 Radiated Transmitter Spurs, 5710 MHz, HT/VHT40, M0 to M23, Average (1-18GHz)

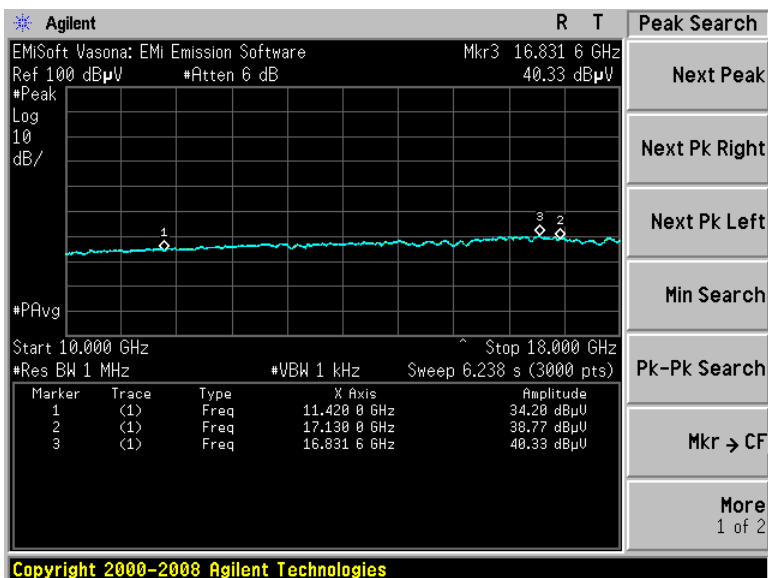
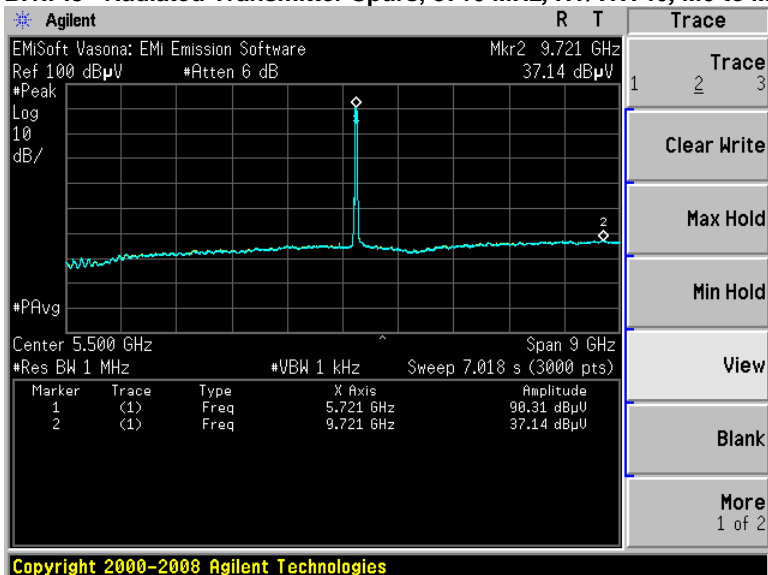



B.1.P.9 Radiated Transmitter Spurs, 5720 MHz, HT/VHT20, M0 to M23, Average (1-18GHz)

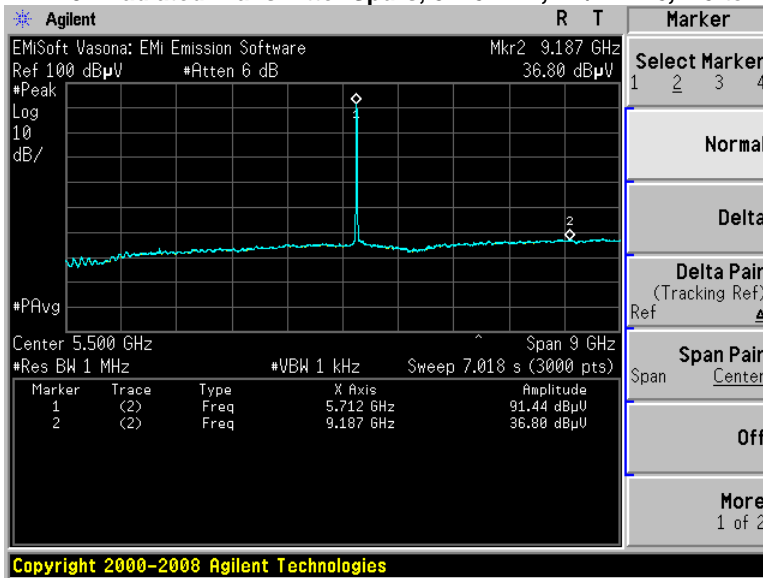

Copyright 2000–2008 Agilent Technologies

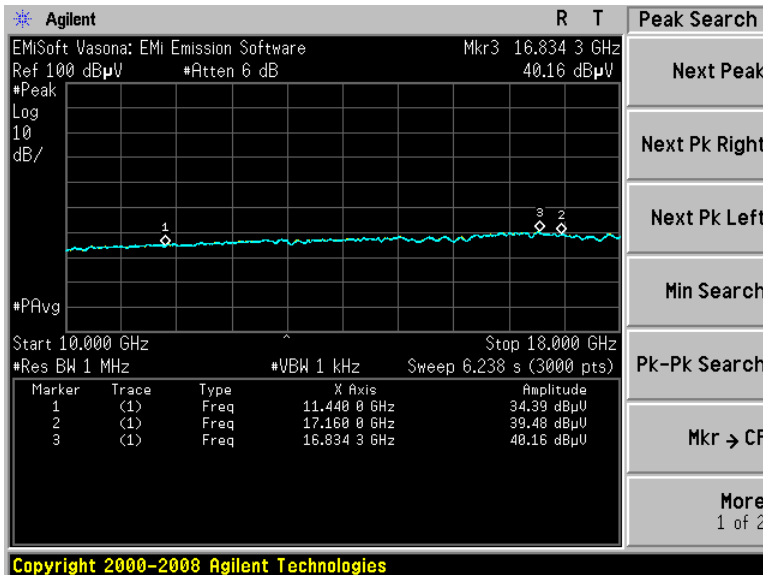

Copyright 2000–2008 Agilent Technologies



B.1.P.10 Radiated Transmitter Spurs, All rate, All modes, Average (18-26.5GHz) Horizontal & Vertical

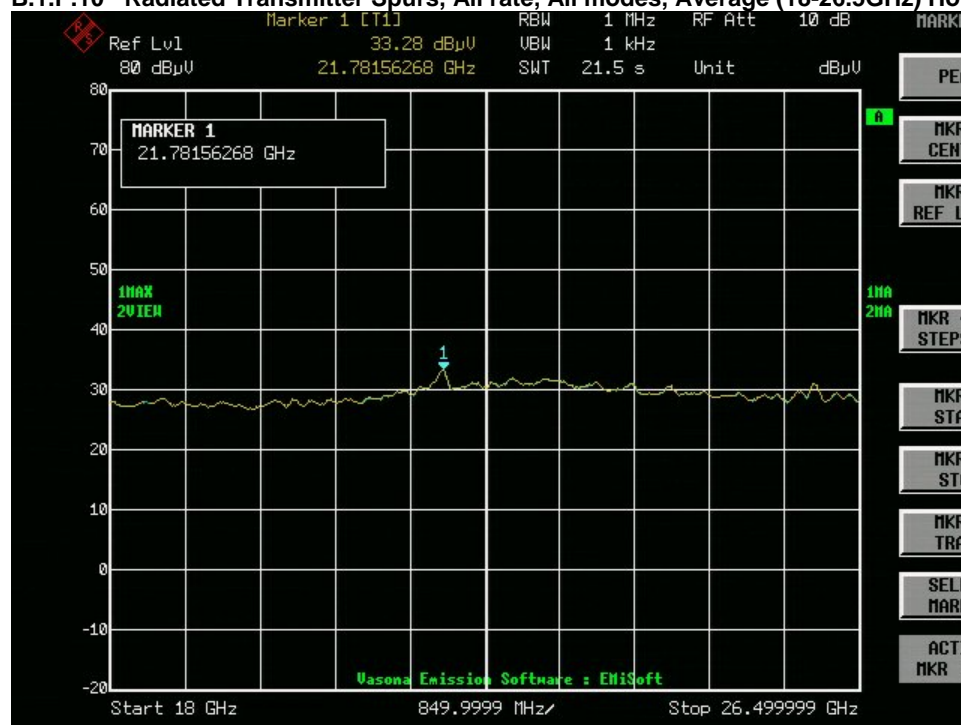

B.1.P.11 Radiated Transmitter Spurs, All rate, All modes, Average (26.5-40GHz) Horizontal & Vertical



No emissions seen above 18GHz. The plots above are representative of all modes tested.

B.1.P Transmitter Radiated Spurious Emissions-Peak worst case

Frequency (MHz)	Mode	Data Rate (Mbps)	Spurious Emission Level (dBuV/m)	Limit (dBuV/m)	Margin (dB)
5500	HT/VHT20, M0 to M15	M0	53.1	74	20.9
5510	HT/VHT40, M0 to M15	M0	49.2	74	24.8
5530	VHT80, M0 to M9 2ss	M0x1	50.2	74	23.8
5550	HT/VHT40, M0 to M15	M0	50.5	74	23.5
5560	HT/VHT20, M0 to M15	M0	51.2	74	22.8
5670	HT/VHT40, M0 to M15	M0	49.9	74	24.1
5690	VHT80, M0 to M9 2ss	M0x1	49.8	74	24.2
5710	HT/VHT40, M0 to M15	M0	50.2	74	23.8
5720	HT/VHT20, M0 to M15	M0	49.9	74	24.1

B.1.P.1 Radiated Transmitter Spurs, 5500 MHz, HT/VHT20, M0 to M23, Peak (1-18GHz)

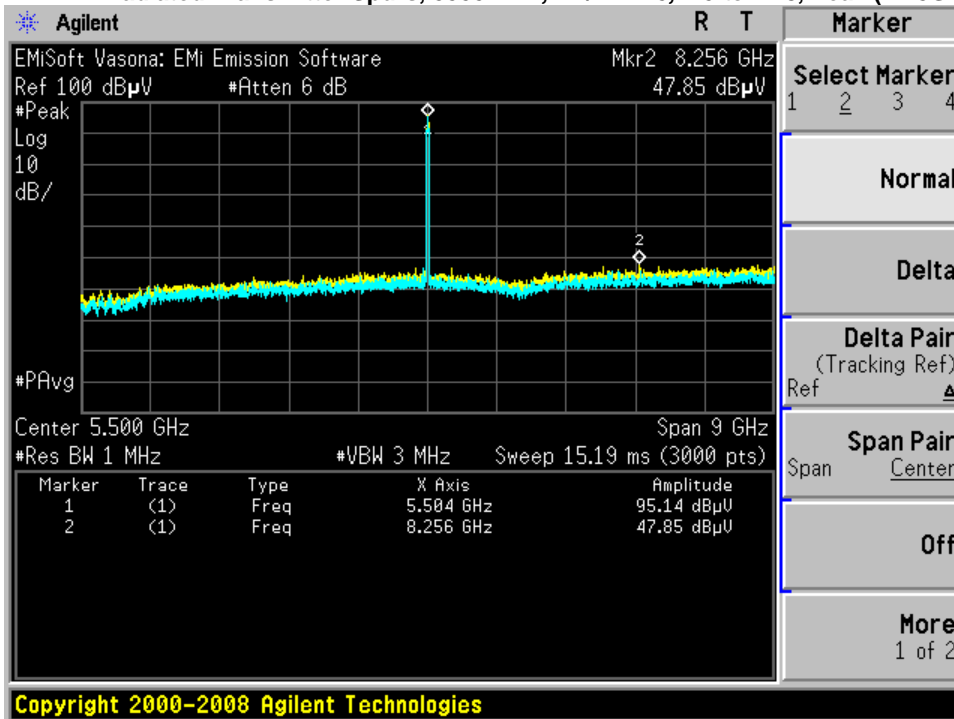

Copyright 2000–2008 Agilent Technologies

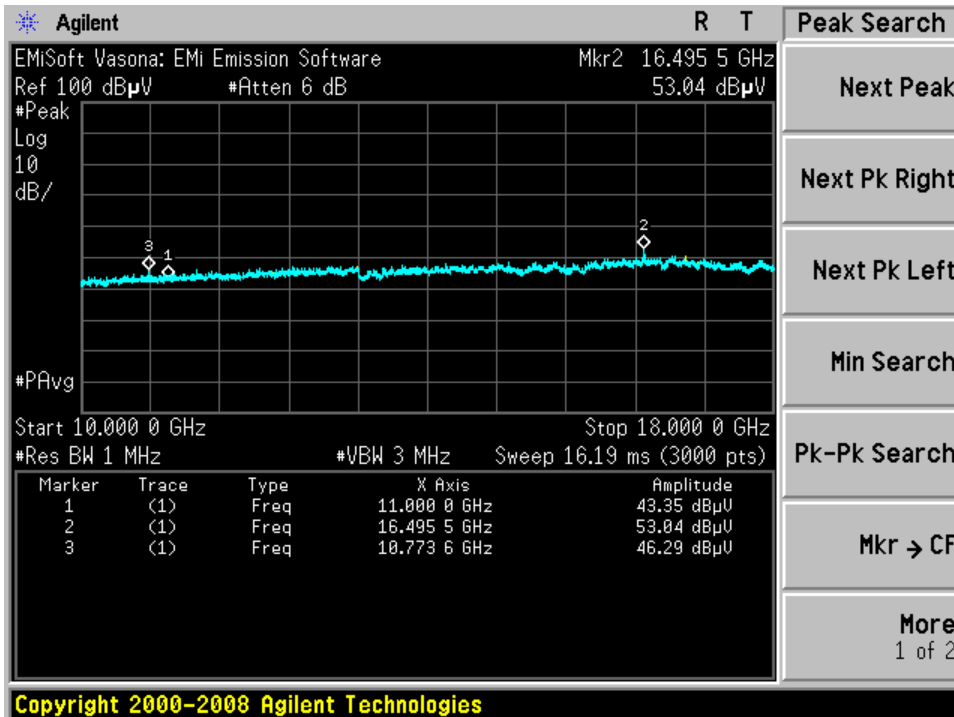

Copyright 2000–2008 Agilent Technologies



B.1.P.2 Radiated Transmitter Spurs, 5510 MHz, HT/VHT40, M0 to M23, Peak (1-18GHz)

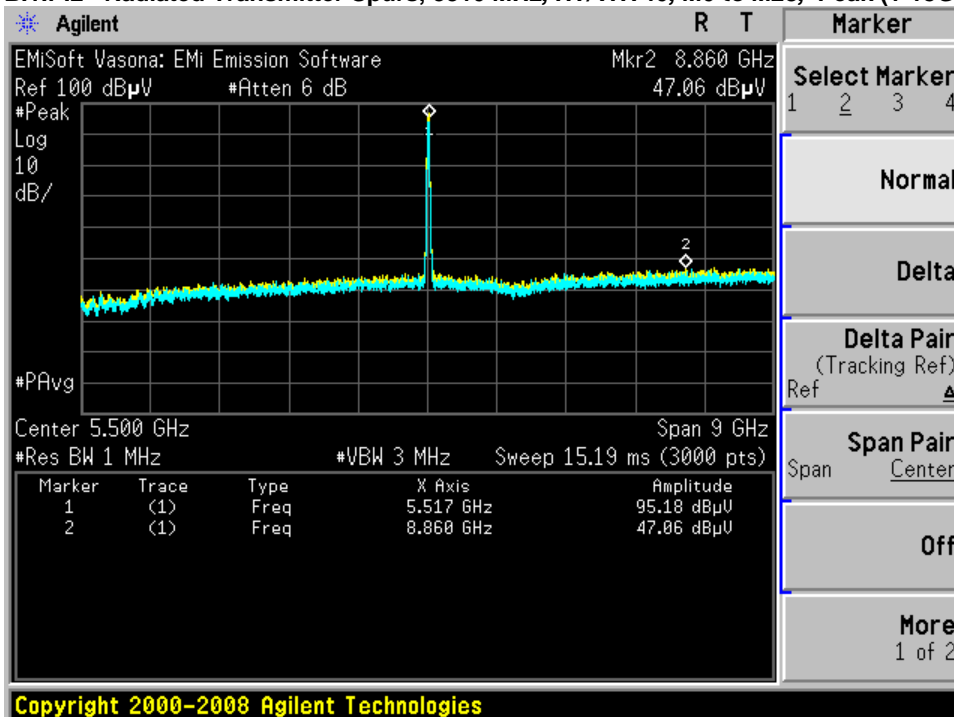

Copyright 2000–2008 Agilent Technologies

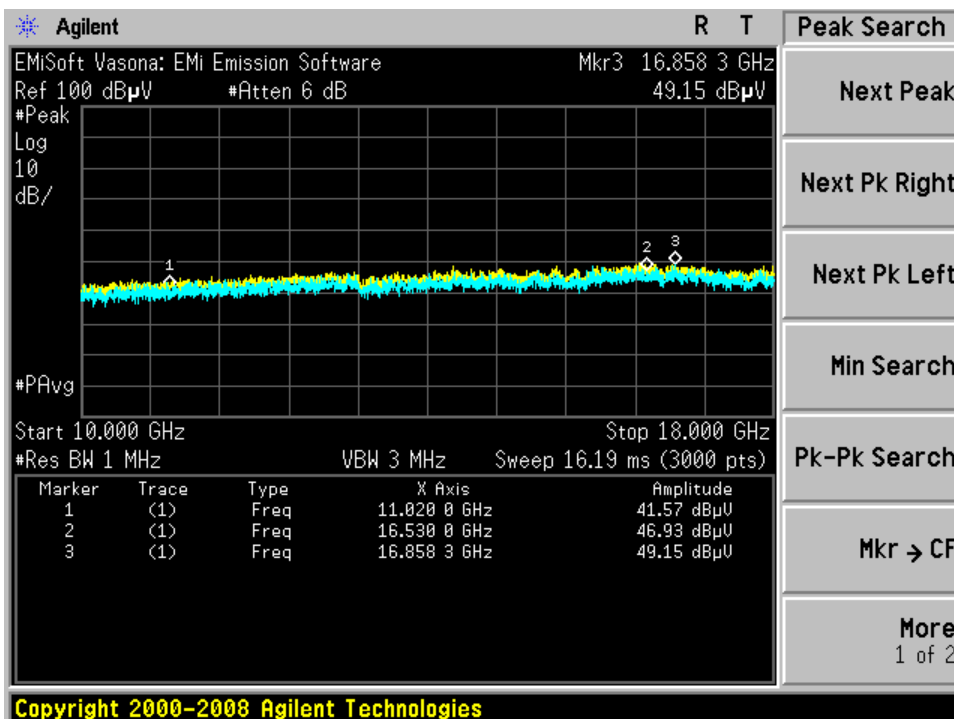

Copyright 2000–2008 Agilent Technologies

B.1.P.3 Radiated Transmitter Spurs, 5530 MHz, VHT80, M0.1 to M9.3, Peak (1-18GHz)

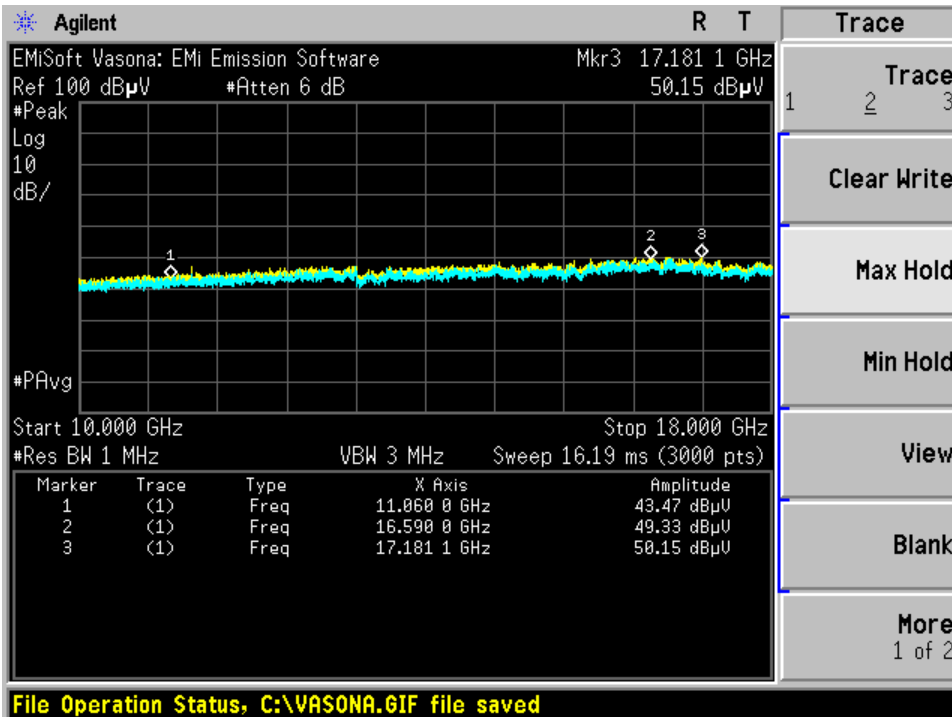
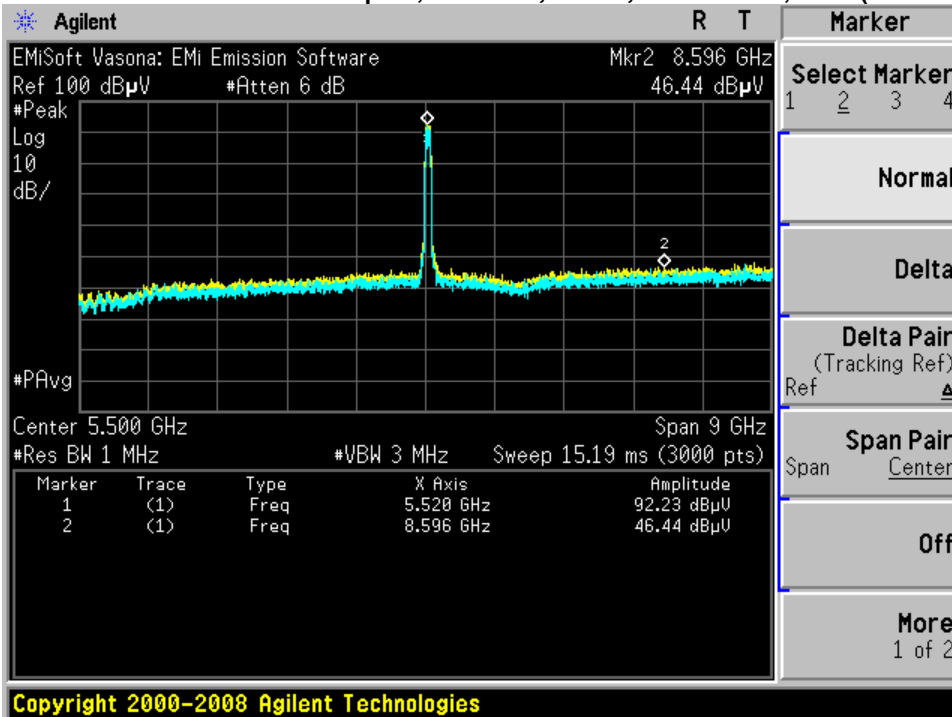

B.1.P.4 Radiated Transmitter Spurs, 5550 MHz, HT/VHT40, M0 to M23, Peak (1-18GHz)

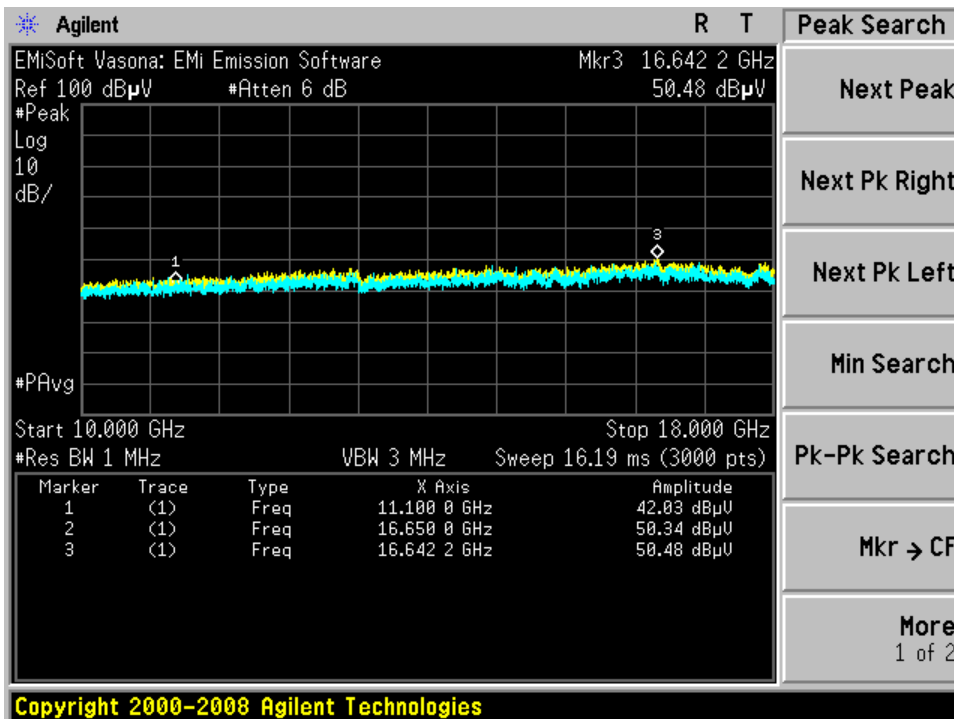
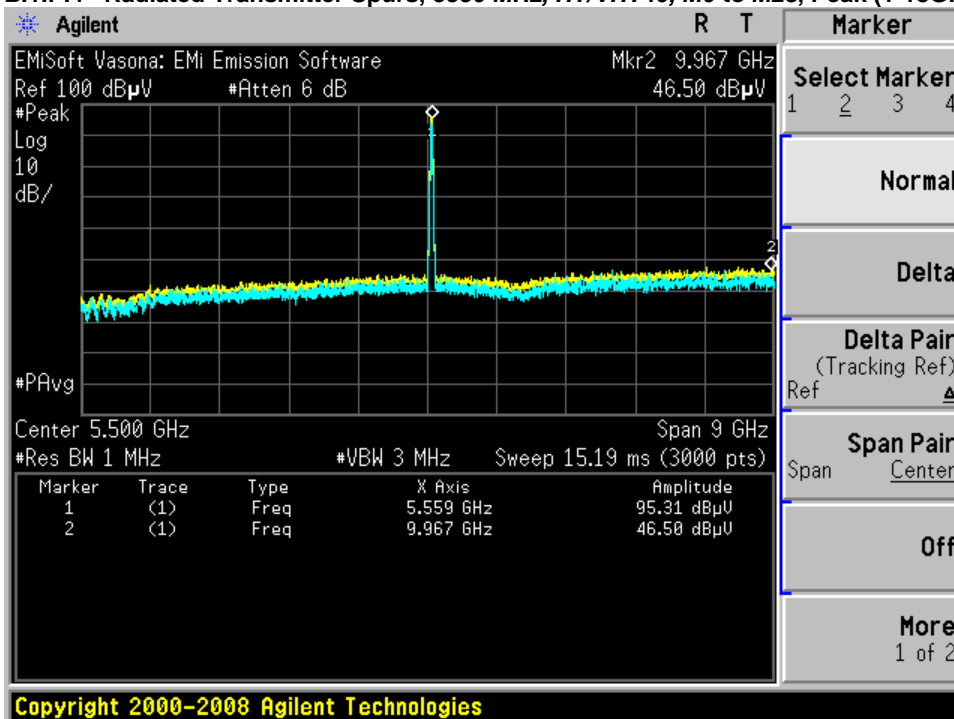

B.1.P.4 Radiated Transmitter Spurs, 5560 MHz, HT/VHT20, M0 to M23, Peak (1-18GHz)

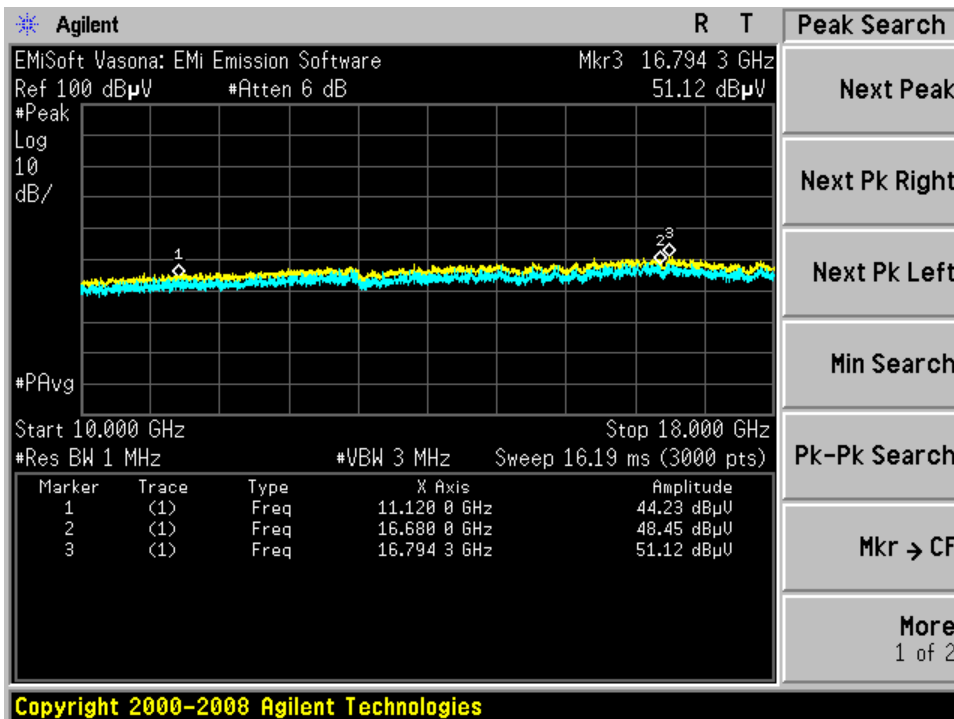
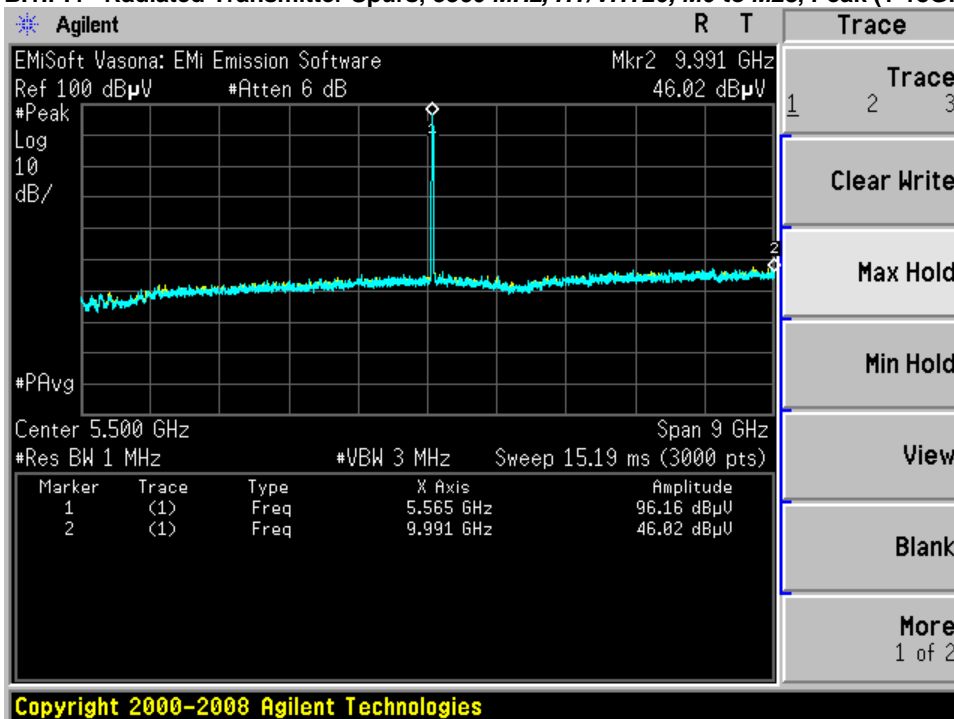

B.1.P.6 Radiated Transmitter Spurs, 5670 MHz, HT/VHT40, M0 to M23, M0.0 to M9.4, Peak (1-18GHz)

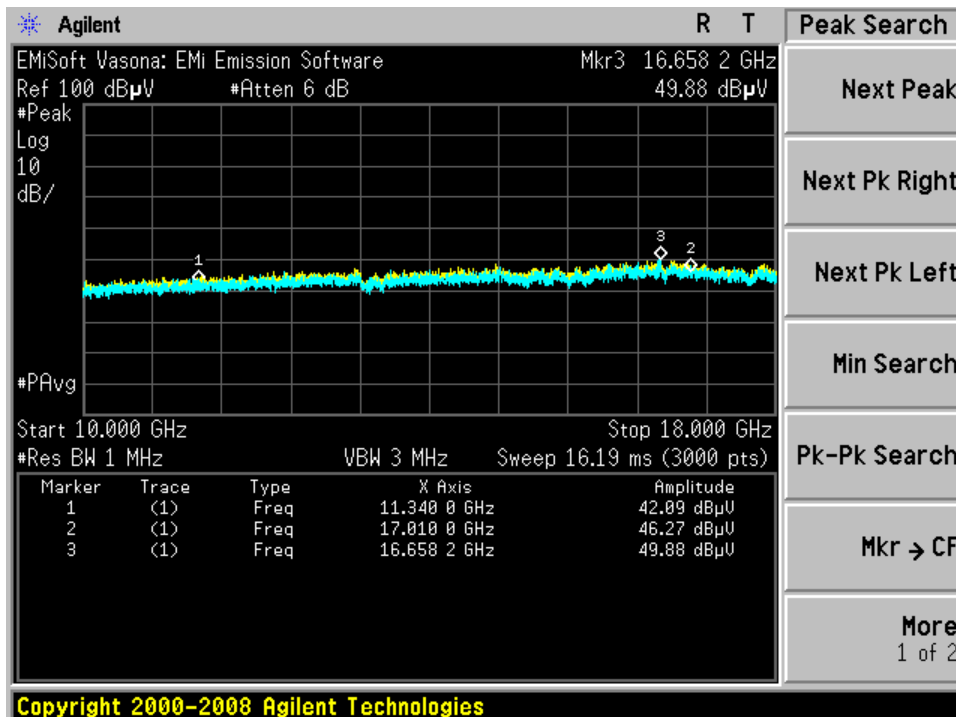
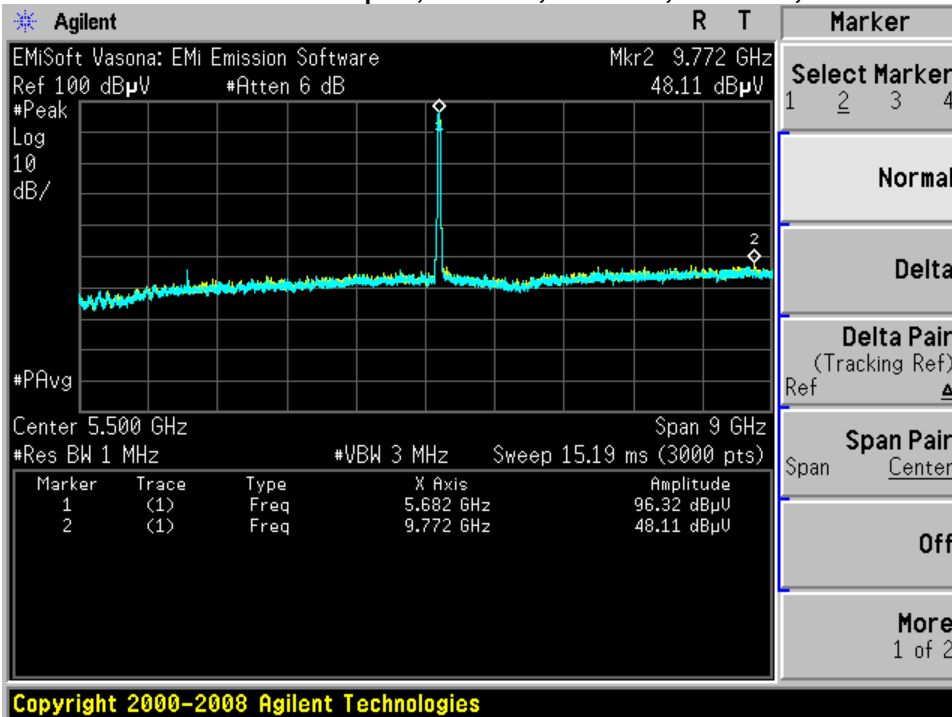

B.1.P.7 Radiated Transmitter Spurs, 5690 MHz, VHT80, M0.1 to M9.3, Peak (1-18GHz)

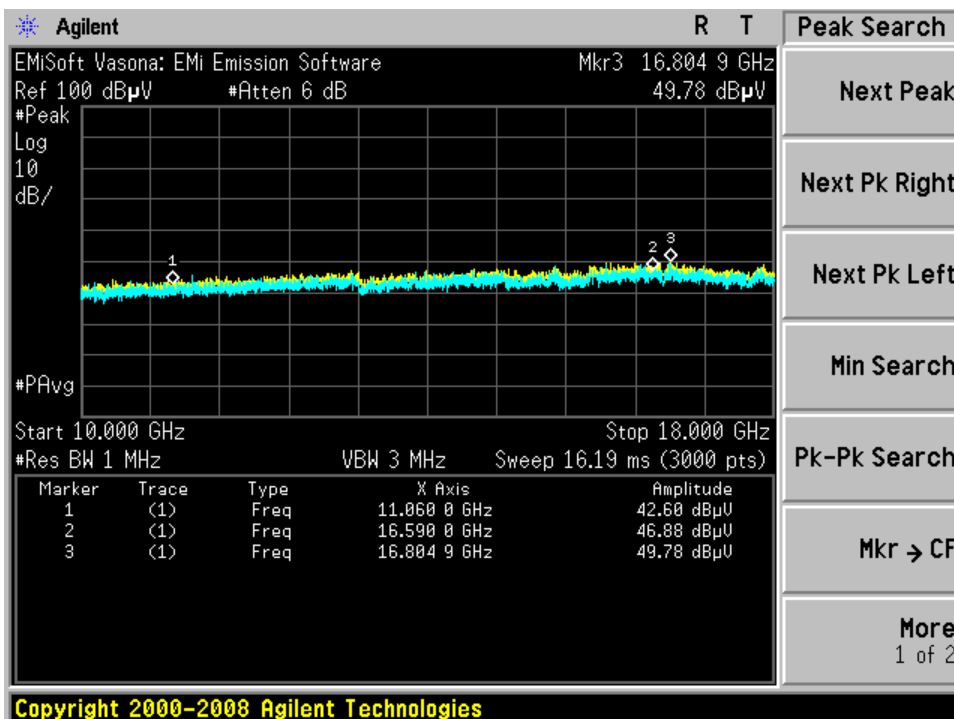
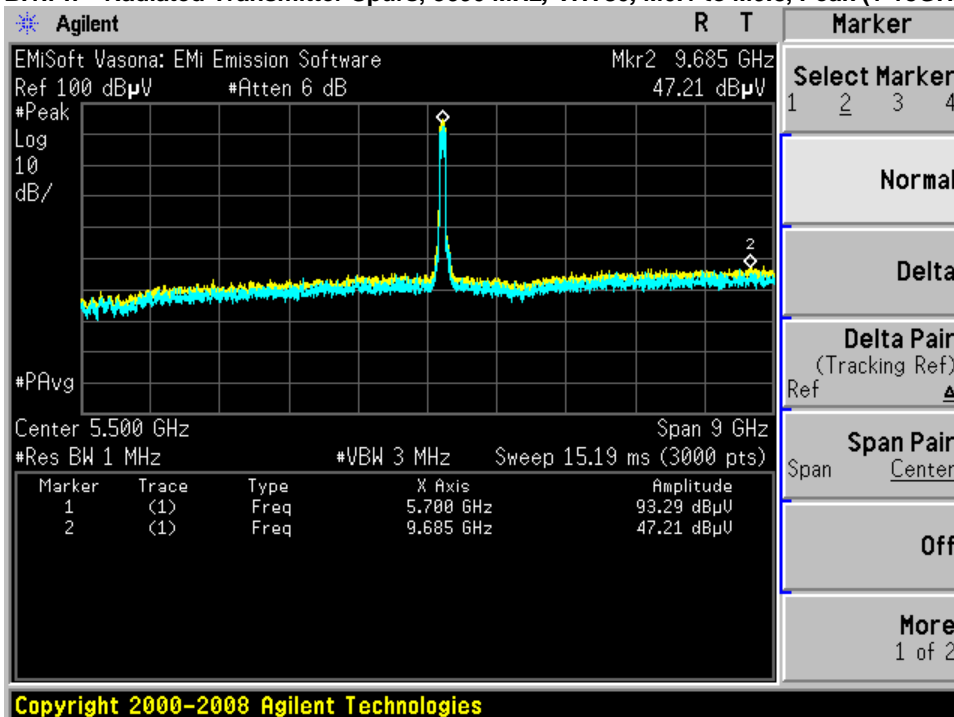

B.1.P.8 Radiated Transmitter Spurs, 5710 MHz, HT/VHT40, M0 to M23, Peak (1-18GHz)

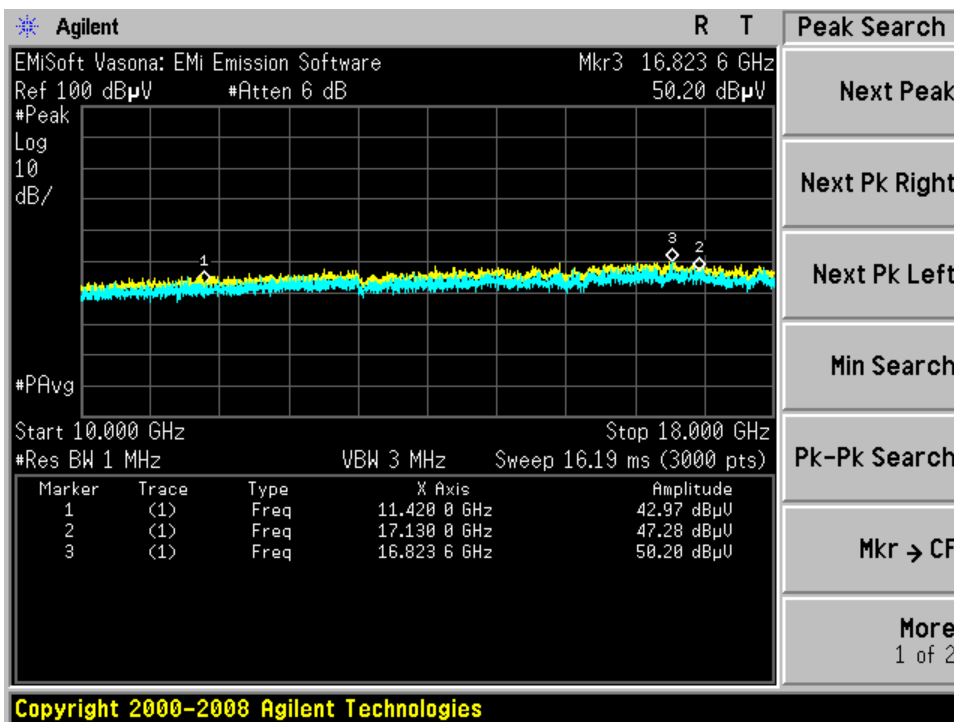
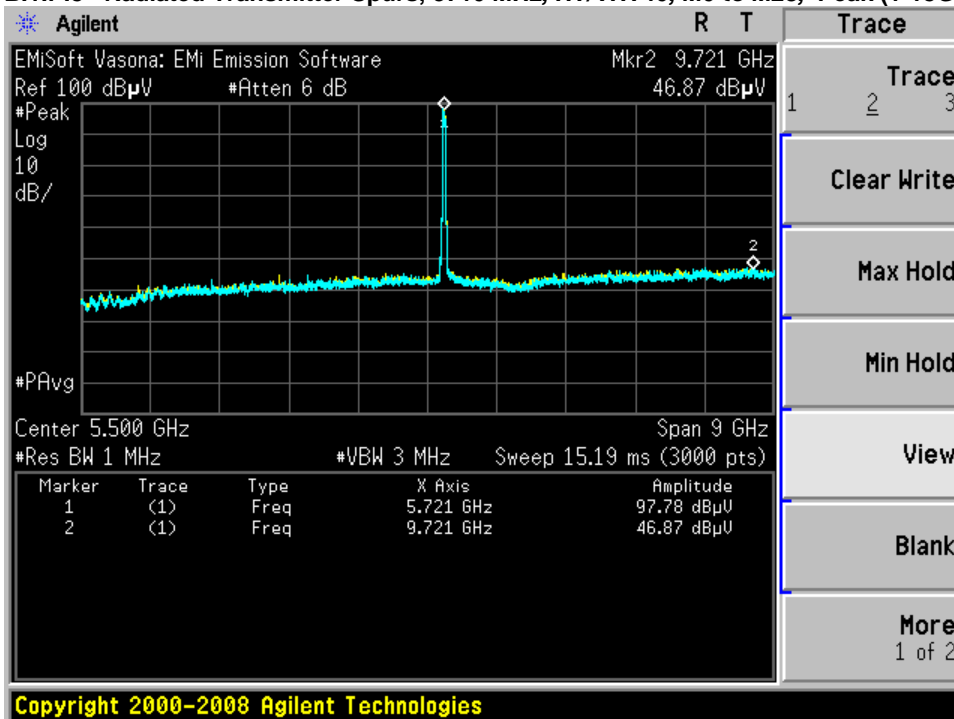

B.1.P.9 Radiated Transmitter Spurs, 5720 MHz, HT/VHT20, M0 to M23, Peak (1-18GHz)

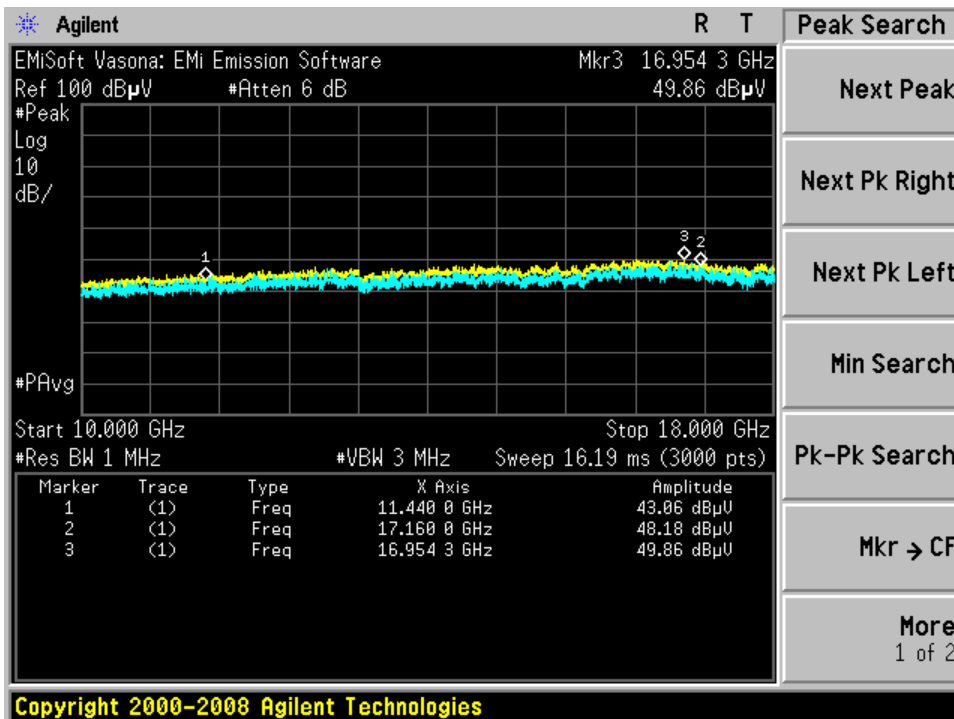
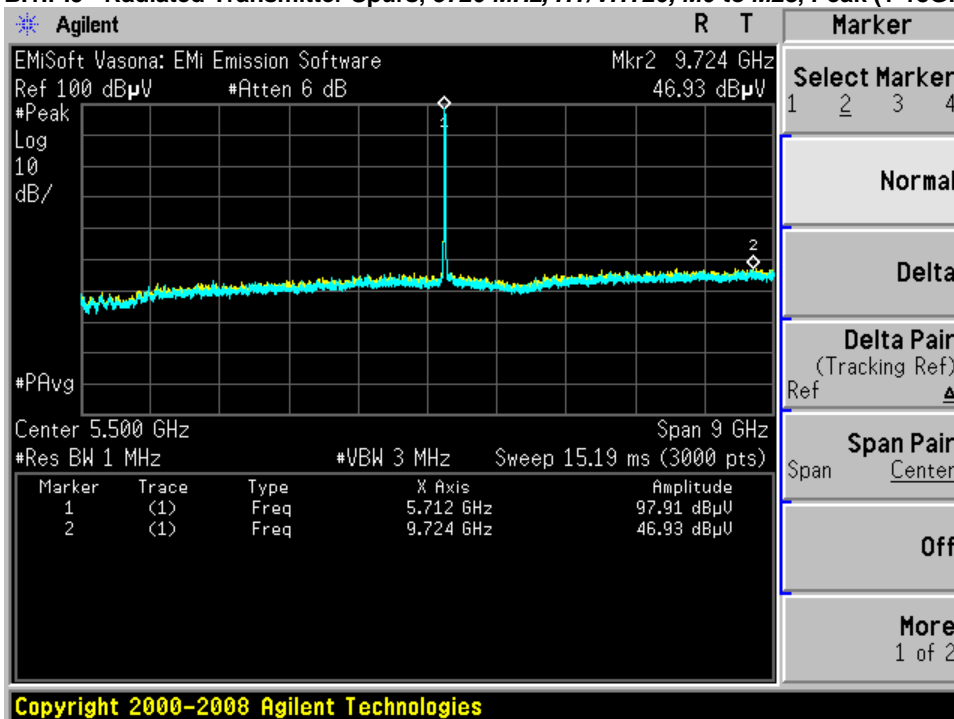

B.1.P.10 Radiated Transmitter Spurs, All rate, All modes, Peak (18-26.5GHz) Horizontal & Vertical

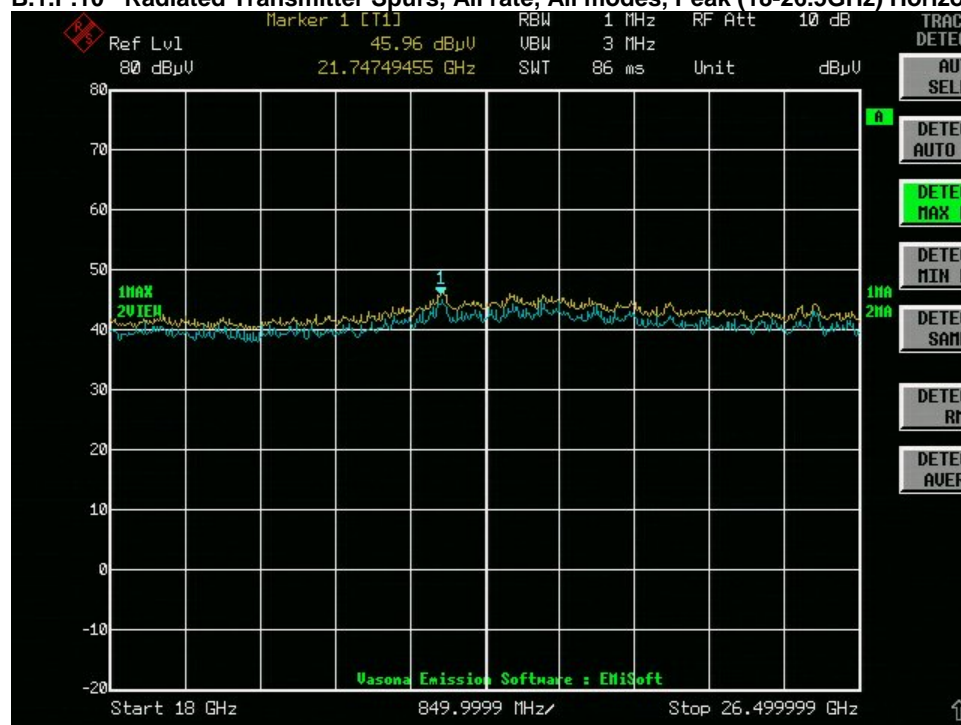

B.1.P.11 Radiated Transmitter Spurs, All rate, All modes, Peak (26.5-40GHz) Horizontal & Vertical

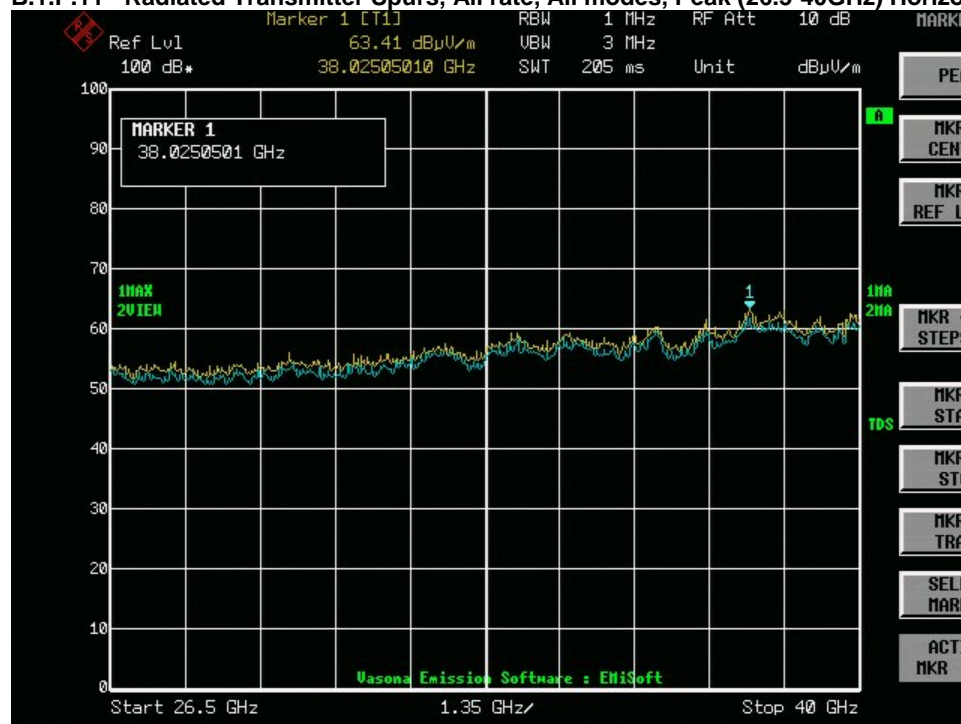

No emissions seen above 18GHz. The plots above are representative of all modes tested.



B.2 Radiated Emissions 30MHz to 1GHz

FCC 15.205 / 15.209

- (7) The provisions of 15.205 apply to intentional radiators operating under this section.
- (6) Unwanted emissions below 1 GHz must comply with the general field strength limits set forth in 15.209.

Ref. ANSI C63.10: 2013 section 6.5

Using Vasona, configure the spectrum analyzer as shown below (be sure to enter all losses between the transmitter output and the spectrum analyzer). Place the radio in continuous transmit mode.

Span:	30MHz – 1GHz
Reference Level:	80 dBuV
Attenuation:	10 dB
Sweep Time:	Coupled
Resolution Bandwidth:	100kHz
Video Bandwidth:	300kHz
Detector:	Peak for Pre-scan, Quasi-Peak

Compliance shall be determined using CISPR quasi-peak detection; however, peak detection is permitted as an alternative to quasi-peak detection.

Terminate the access Point RF ports with 50 ohm loads.

Maximize Turntable (find worst case table angle), Maximize Antenna (find worst case height)

This report represents the worst case data for all supported operating modes and antennas.

System Number	Description	Samples	System under test	Support equipment
1	EUT	S01	<input checked="" type="checkbox"/>	<input type="checkbox"/>
	Support	S02	<input type="checkbox"/>	<input checked="" type="checkbox"/>

Tested By : Jose Aguirre	Date of testing: 10-Nov-16
Test Result : PASS	

See Appendix C for list of test equipment

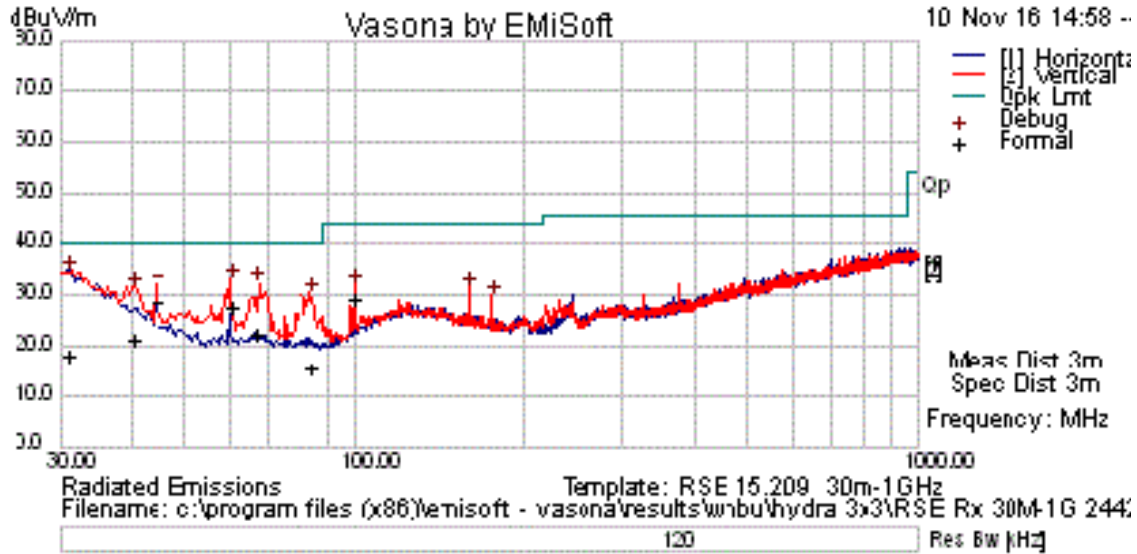

Test Results Table

Frequency MHz	Raw dBuV	Cable Loss	AF dB	Level dBuV/m	Measurement Type	Pol	Hgt cm	Azt Deg	Limit dBuV/m	Margin dB	Pass /Fail
30.97	-2.9	0.5	20.7	18.2	Quasi Max	H	222	186	40	-21.8	Pass
60.003	19.6	0.7	7.4	27.7	Quasi Max	V	146	171	40	-12.3	Pass
66.358	14	0.7	8	22.6	Quasi Max	V	145	39	40	-17.4	Pass
44.236	17.2	0.6	10.8	28.6	Quasi Max	V	105	280	40	-11.4	Pass
40.185	6.9	0.5	13.9	21.3	Quasi Max	V	115	85	40	-18.7	Pass
83.35	7.2	0.8	7.5	15.4	Quasi Max	V	139	228	40	-24.6	Pass
100	18.4	0.8	10.2	29.4	Quasi Max	V	124	352	43.5	-14.1	Pass

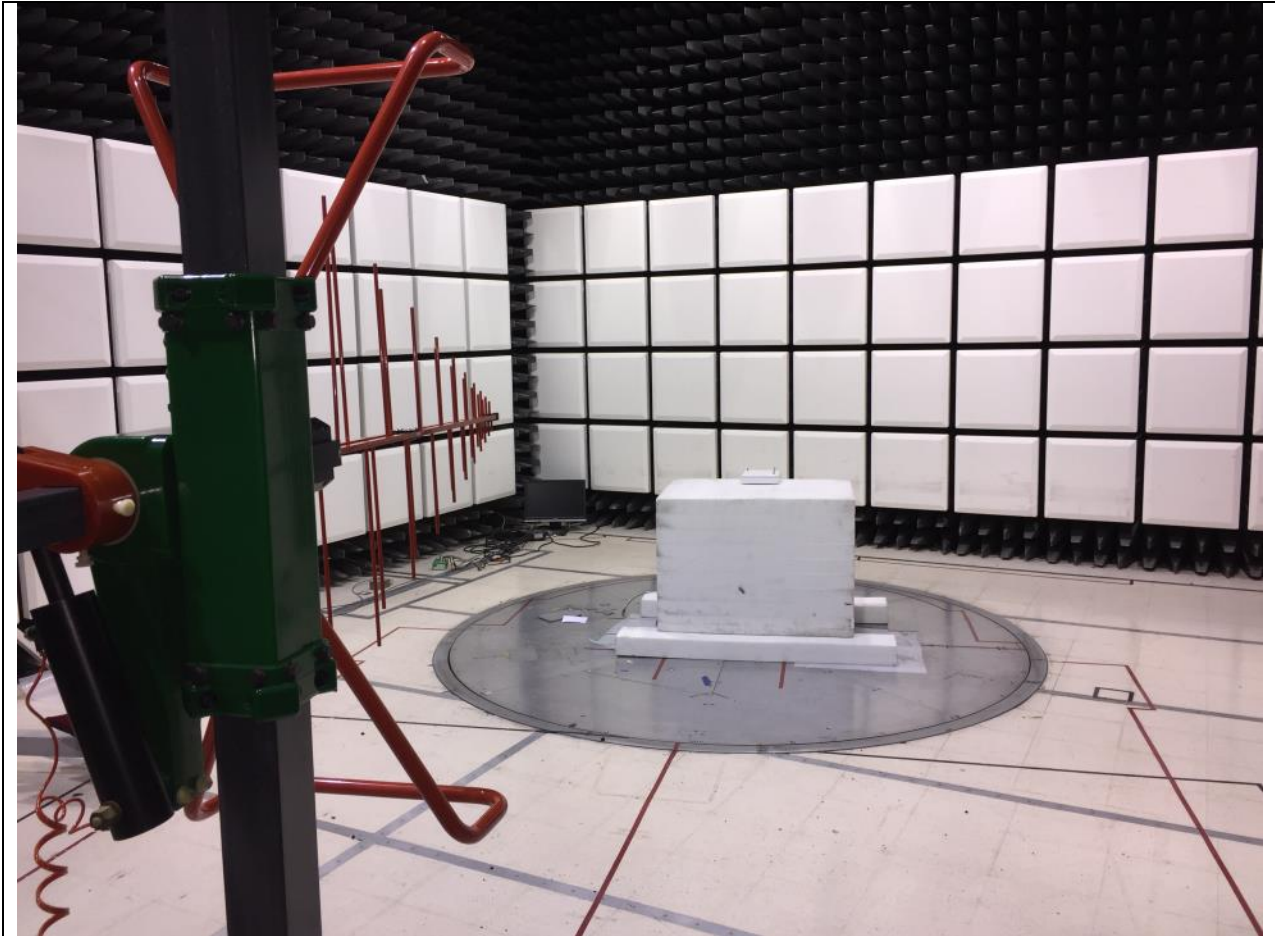

Title: Radiated Emissions Configuration Photograph

B.3 AC Conducted Emissions

FCC 15.207 (a) & RSS-Gen 8.8 / LP0002:2.3 Except when the requirements applicable to a given device state otherwise, for any radio apparatus equipped to operate from the public utility AC power supply, either directly or indirectly (such as with a battery charger), the radio frequency voltage of emissions conducted back onto the AC power lines in the frequency range of 0.15 MHz to 30 MHz shall not exceed the limits shown in the table in these sections. The more stringent limit applies at the frequency range boundaries.

Measurement Procedure

Accordance with ANSI C63.10:2013 section 6.2

Using Vasona, configure the spectrum analyzer as shown below (be sure to enter all losses between the transmitter output and the spectrum analyzer). Place the radio in continuous transmit mode.

Span:	150 KHz – 30 MHz
Attenuation:	10 dB
Sweep Time:	Coupled
Resolution Bandwidth:	9 KHz
Video Bandwidth:	30 KHz
Detector:	Quasi-Peak / Average

System Number	Description	Samples	System under test	Support equipment
1	EUT	S01	<input checked="" type="checkbox"/>	<input type="checkbox"/>
	Support	S02	<input type="checkbox"/>	<input checked="" type="checkbox"/>

Tested By : Jose Aguirre	Date of testing: 14-Nov-16
Test Result : PASS	

See separate EMC test report for test data.

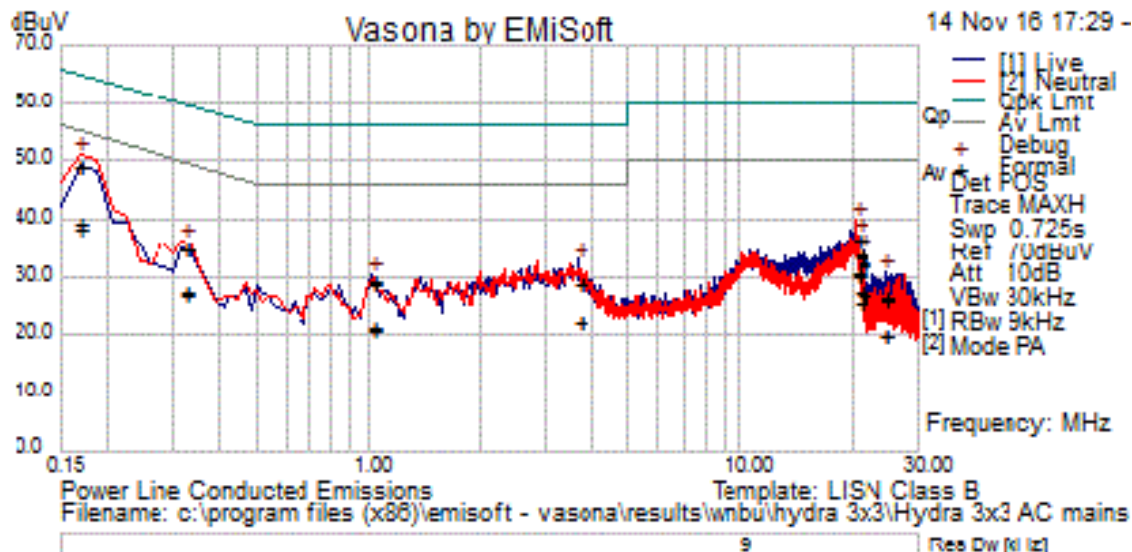

Test Results Table

Frequency MHz	Raw dBuV	Cable Loss	Factors dB	Level dBuV	Measurement Type	Line	Limit dBuV	Margin dB	Pass /Fail
24.552	5.6	20.5	0.3	26.4	Quasi Peak	Live	60	-33.6	Pass
1.027	9	20	0	29	Quasi Peak	Live	56	-27	Pass
20.421	15.7	20.4	0.2	36.4	Quasi Peak	Live	60	-23.6	Pass
0.169	28	21.2	0.1	49.3	Quasi Peak	Live	65	-15.7	Pass
21.145	11.6	20.4	0.2	32.3	Quasi Peak	Live	60	-27.7	Pass
3.657	8.6	20.1	0.1	28.7	Quasi Peak	Live	56	-27.3	Pass
20.668	12.9	20.4	0.2	33.6	Quasi Peak	Live	60	-26.4	Pass
0.324	14.3	20.5	0.1	34.9	Quasi Peak	Live	59.6	-24.7	Pass
0.324	14.4	20.5	0.1	34.9	Quasi Peak	Neutral	59.6	-24.7	Pass
20.668	13.3	20.4	0.2	34	Quasi Peak	Neutral	60	-26	Pass
21.145	11.8	20.4	0.2	32.5	Quasi Peak	Neutral	60	-27.5	Pass
0.169	27.9	21.2	0.1	49.2	Quasi Peak	Neutral	65	-15.8	Pass
1.027	9.1	20	0	29.2	Quasi Peak	Neutral	56	-26.8	Pass
24.552	5.3	20.5	0.3	26.1	Quasi Peak	Neutral	60	-33.9	Pass
20.421	15.9	20.4	0.2	36.6	Quasi Peak	Neutral	60	-23.4	Pass
3.657	8.6	20.1	0.1	28.7	Quasi Peak	Neutral	56	-27.3	Pass
24.552	-0.5	20.5	0.3	20.3	Average	Live	50	-29.7	Pass
1.027	1.2	20	0	21.3	Average	Live	46	-24.7	Pass
20.421	9.9	20.4	0.2	30.6	Average	Live	50	-19.4	Pass
0.169	18	21.2	0.1	39.3	Average	Live	55	-15.7	Pass
21.145	6.3	20.4	0.2	26.9	Average	Live	50	-23.1	Pass
3.657	2.2	20.1	0.1	22.3	Average	Live	46	-23.7	Pass
20.668	5.1	20.4	0.2	25.8	Average	Live	50	-24.2	Pass
0.324	6.6	20.5	0.1	27.2	Average	Live	49.6	-22.4	Pass
0.324	6.8	20.5	0.1	27.3	Average	Neutral	49.6	-22.3	Pass
20.668	7	20.4	0.2	27.7	Average	Neutral	50	-22.3	Pass
21.145	6.4	20.4	0.2	27	Average	Neutral	50	-23	Pass
0.169	17.3	21.2	0.1	38.6	Average	Neutral	55	-16.5	Pass
1.027	1.6	20	0	21.6	Average	Neutral	46	-24.4	Pass
24.552	-0.6	20.5	0.3	20.2	Average	Neutral	50	-29.8	Pass
20.421	9.7	20.4	0.2	30.3	Average	Neutral	50	-19.7	Pass
3.657	2.2	20.1	0.1	22.4	Average	Neutral	46	-23.6	Pass

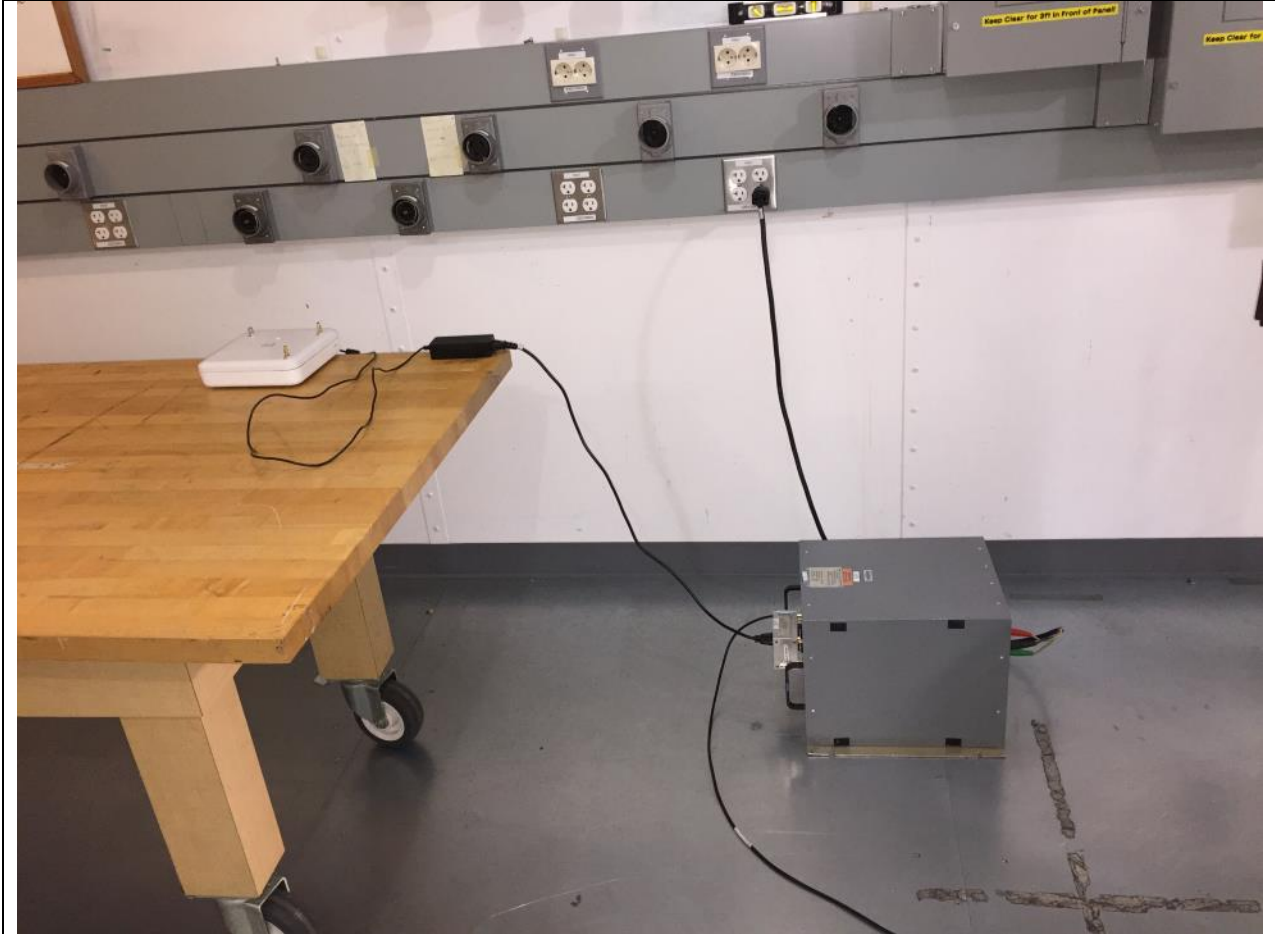

Title: Conducted Emissions Configuration Photograph

Appendix C: List of Test Equipment Used to perform the test

Test Equipment used for Radiated Emissions					
Equip No	Model Manufacturer	Description	Last Cal	Next Cal	Test Item
CIS049413	iBTHP-5-DB9 Newport	5 inch Temp/RH/ Press Sensor	18-Dec-15	18-Dec-16	B.1, B.2, B.3
CIS040523	ESCI Rohde & Schwarz	EMI Test Receiver	30-Dec-15	30-Dec-16	B.3
CIS001937	NSA 5m Chamber Cisco	NSA 5m Chamber	12-Feb-16	12-Feb-17	B.3
CIS049535	Above 1GHz Site Cal Cisco	Above 1GHz CISPR Site Validation	13-Feb-16	13-Feb-17	B.1, B.2
CIS028072	1840 Cisco	18-40GHz EMI Test Head	22-Feb-16	22-Feb-17	B.1, B.2
CIS045588	JB1 Sunol Sciences	Combination Antenna, 30MHz-2GHz	9-Mar-16	9-Mar-17	B.3
CIS042000	E4440A Agilent	Spectrum Analyzer	6-Jul-16	6-Jul-17	B.1, B.2
CIS037581	3117 ETS-Lindgren	Horn Antenna	7-Oct-16	7-Oct-17	B.1, B.2
CIS045098	TH0118 Cisco	Mast Mount Preamplifier Array, 1-18GHz	31-Oct-16	31-Oct-17	B.1, B.2
CIS033602	CSY-NMNM-80-273001 Midwest Microwave	RF Coaxial Cable, to 18GHz	8-Nov-16	8-Nov-17	B.1, B.2, B.3
CIS030443	UFB311A-0-1560-520520 Micro-Coax	RF Coaxial Cable, to 18GHz	8-Nov-16	8-Nov-17	B.1, B.2, B.3
CIS008024	SF106A Huber + Suhner	3 meter Sucoflex cable	8-Nov-16	8-Nov-17	B.1, B.2, B.3
CIS024201	FSEK30 Rohde & Schwarz	Spectrum Analyzer 20Hz - 40GHz	8-Nov-16	8-Nov-17	B.1, B.2
CIS037235	50CB-015 JFW	GPIB Control Box	Cal not Required	Cal not Required	B.1, B.2
CIS035244	926-8ME Klein Tools	8 Meter Tape Measure	Cal not Required	Cal not Required	B.1, B.2, B.3

Test Equipment used for AC Mains Conducted Emissions					
Equip#	Manufacturer/ Model	Description	Last Cal	Next Cal	Test Item
8510	Fischer Custom Communications FCC-450B-2.4-N	Instrumentation Limiter	16-May-16	16-May-17	B.4
23802	Fischer Custom Communications FCC-801-M2-50A	CDN, 2-LINE 50A	12-Jan-16	12-Jan-17	B.4
45995	Fischer Custom Communications F-090527-1009-2	Lisn Adapter	17-Jun-16	17-Jun-17	B.4
49468	Coleman RG223	BNC 25 ft Cable	9-Mar-16	9-Mar-17	B.4
31918	Midwest Microwave TRM-2048-MC-BNC-10	50 Ohm, 5W Terminator, Type BNC	11-Nov-16	11-Nov-17	B.4
49531	TTE H785-150K-50-21378	High Pass Filter	3-May-16	3-May-17	B.4

45994	Fischer Custom Communications F-090527-1009-1	Line Impedance Stabilization Network	17-Jun-16	17-Jun-17	B.4
18963	York CNE V	Comparison Noise Emitter, 30 - 1000MHz	Cal Not Required	Cal Not Required	B.4
45050	Rohde & Schwarz ESCI	EMI Test Receiver	11-Sep-16	11-Sep-17	B.4
51721	Teseq CDN ST08A	Coupling Decoupling Network	7-Jun-16	7-Jun-17	B.4
54231	Newport iBTHP-5-DB9	5 inch Temp/RH/Press Sensor w/20ft cable	10-Feb-16	10-Feb-17	B.4

Test Equipment used for RF Conducted Tests

Equip#	Manufacturer/ Model	Description	Last Cal	Next Cal	Test Item
CIS054666	RA08-S1S1-18 MegaPhase	SMA 18" Cable	25-Sep-15	25-Sep-16	A1 thru A6
CIS054667	RA08-S1S1-18 MegaPhase	SMA 18" Cable	25-Sep-15	25-Sep-16	A1 thru A6
CIS054668	RA08-S1S1-18 MegaPhase	SMA 18" Cable	25-Sep-15	25-Sep-16	A1 thru A6
CIS054669	RA08-S1S1-18 MegaPhase	SMA 18" Cable	25-Sep-15	25-Sep-16	A1 thru A6
CIS054686	NI PXI-2796 National Instruments	Plug-in switch module	6-Oct-15	6-Oct-16	A1 thru A6
CIS055166	RFLT4WDC40GK RF Lambda	4 Way Power Divider 40GHz	23-Nov-15	23-Nov-16	A1 thru A6
CIS054662	RFLT4WDC40GK RF Lambda	SMA 36" cable	24-Sep-15	24-Sep-16	A1 thru A6
CIS054656	BRC50705-02 Micro-Tronics	Band Reject Filter	24-Sep-15	24-Sep-16	A1 thru A6
CIS054655	BRC50704-02 Micro-Tronics	Notch Filter, SB:5.470-5.725GHz, to 12GHz	24-Sep-15	24-Sep-16	A1 thru A6
CIS054654	BRC50703-02 Micro-Tronics	Notch Filter, SB:5.150-5.350GHz, to 11GHz	24-Sep-15	24-Sep-16	A1 thru A6
CIS054653	BRM50702-02 Micro-Tronics	Notch Filter, SB:2.400-2.500GHz, to 18GHz	24-Sep-15	24-Sep-16	A1 thru A6
CIS054678	RA08-S1S1-12 MegaPhase	SMA 12" Cable	25-Sep-15	25-Sep-16	A1 thru A6
CIS054677	RA08-S1S1-12 MegaPhase	SMA 12" Cable	25-Sep-15	25-Sep-16	A1 thru A6
CIS054676	RA08-S1S1-12 MegaPhase	SMA 12" Cable	25-Sep-15	25-Sep-16	A1 thru A6
CIS054675	RA08-S1S1-12 MegaPhase	SMA 12" Cable	25-Sep-15	25-Sep-16	A1 thru A6
CIS054674	RA08-S1S1-12 MegaPhase	SMA 12" Cable	25-Sep-15	25-Sep-16	A1 thru A6
CIS054673	RA08-S1S1-12	SMA 12" Cable	25-Sep-15	25-Sep-16	A1 thru A6

	MegaPhase				
CIS054672	RA08-S1S1-12 MegaPhase	SMA 12" Cable	25-Sep-15	25-Sep-16	A1 thru A6
CIS054671	RA08-S1S1-12 MegaPhase	SMA 12" Cable	25-Sep-15	25-Sep-16	A1 thru A6
CIS054670	RA08-S1S1-12 MegaPhase	SMA 12" Cable	25-Sep-15	25-Sep-16	A1 thru A6
CIS054664	GC12-8181-16 MegaPhase	SMA 16" Cable	25-Sep-15	25-Sep-16	A1 thru A6
CIS054663	F120-S1S1-48 MegaPhase	SMA 48" Cable	25-Sep-15	25-Sep-16	A1 thru A6
CIS054686	NI PXI-2796 National Instruments	Plug-in switch module	6-Oct-15	6-Oct-16	A1 thru A6
CIS042005	BWS30W2+ Mini-Circuits	SMA 30dB Attenuator	16-Oct-15	16-Oct-16	A1 thru A6
CIS041995	BW-S6W2 Mini-Circuits	6dB Attenuator	16-Oct-15	16-Oct-16	A1 thru A6
CIS054695	D3C2060 Ditom	Circulator	20-Oct-15	20-Oct-16	A1 thru A6
CIS055146	RA08-S1S1-12 Megaphase	12" SMA Cable	17-Nov-15	17-Nov-16	A1 thru A6
CIS050721	N9030A Keysight	PXA Signal Analyzer	30-Mar-16	30-Mar-17	A1 thru A6
CIS054303	N5182B Keysight	MXG X-Series RF Vector Signal Generator	6-Apr-16	6-Apr-17	A1 thru A6
CIS055099	SMART2200RM2U Tripp-Lite	Power Supply	Cal Not Required		A1 thru A6
CIS055094	PXI-1042 National Instruments	Chassis	Cal Not Required		A1 thru A6

Appendix E: Abbreviation Key and Definitions

The following table defines abbreviations used within this test report.

Abbreviation	Description	Abbreviation	Description
EMC	Electro Magnetic Compatibility	°F	Degrees Fahrenheit
EMI	Electro Magnetic Interference	°C	Degrees Celsius
EUT	Equipment Under Test	Temp	Temperature
ITE	Information Technology Equipment	S/N	Serial Number
TAP	Test Assessment Schedule	Qty	Quantity
ESD	Electro Static Discharge	emf	Electromotive force
EFT	Electric Fast Transient	RMS	Root mean square
EDCS	Engineering Document Control System	Qp	Quasi Peak
Config	Configuration	Av	Average
CIS#	Cisco Number (unique identification number for Cisco test equipment)	Pk	Peak
Cal	Calibration	kHz	Kilohertz (1×10^3)
EN	European Norm	MHz	MegaHertz (1×10^6)
IEC	International Electro technical Commission	GHz	Gigahertz (1×10^9)
CISPR	International Special Committee on Radio Interference	H	Horizontal
CDN	Coupling/Decoupling Network	V	Vertical
LISN	Line Impedance Stabilization Network	dB	decibel
PE	Protective Earth	V	Volt
GND	Ground	kV	Kilovolt (1×10^3)
L1	Line 1	μ V	Microvolt (1×10^{-6})
L2	Line2	A	Amp
L3	Line 3	μ A	Micro Amp (1×10^{-6})
DC	Direct Current	mS	Milli Second (1×10^{-3})
RAW	Uncorrected measurement value, as indicated by the measuring device	μ S	Micro Second (1×10^{-6})
RF	Radio Frequency	μ S	Micro Second (1×10^{-6})
SLCE	Signal Line Conducted Emissions	m	Meter
Meas dist	Measurement distance	Spec dist	Specification distance
N/A or NA	Not Applicable	SL	Signal Line (or Telecom Line)
P	Power Line	L	Live Line
N	Neutral Line	R	Return
S	Supply	AC	Alternating Current

End