



**Test Report**  
**AIR-AP1810W-x-K9**  
**AIR-OEAP1810-x-K9**  
x=A,B,D,N,T,Z

Cisco Aironet 802.11ac Dual Band Access Points

**FCC ID: LDK102096**  
**IC: 2461B-102096**

**Bluetooth Low Energy (BLE)**

**2400-2483.5 MHz**

Antenna Gain = 2dBi

Against the following Specifications:

CFR47 Part 15.247  
RSS-247  
RSS-Gen  
AS/NZS 4268  
LP0002  
G.S.R 45 (E)

**Cisco Systems**  
170 West Tasman Drive  
San Jose, CA 95134

	
<b>Author:</b> Jose Aguirre <b>Tested By</b>	<b>Approved By:</b> Jim Nicholson <b>Title:</b> Technical Leader, Engineering <b>Revision:</b> 2

This report replaces any previously entered test report under EDCS – **1555971**. This test report has been electronically authorized and archived using the CISCO Engineering Document Control system.



This test report has been electronically authorized and archived using the CISCO Engineering Document Control system.

<b>SECTION 1: OVERVIEW .....</b>	<b>3</b>
<b>SECTION 2: ASSESSMENT INFORMATION .....</b>	<b>4</b>
2.1 GENERAL .....	4
2.2 DATE OF TESTING .....	6
2.3 REPORT ISSUE DATE .....	6
2.4 TESTING FACILITIES .....	6
2.5 EQUIPMENT ASSESSED (EUT) .....	6
2.6 EUT DESCRIPTION .....	7
<b>SECTION 3: RESULT SUMMARY .....</b>	<b>8</b>
<b>SECTION 4: SAMPLE DETAILS .....</b>	<b>10</b>
<b>APPENDIX A: EMISSION TEST RESULTS .....</b>	<b>11</b>
CONDUCTED TEST SETUP DIAGRAM .....	11
TARGET MAXIMUM CHANNEL POWER .....	11
A.1 6dB BANDWIDTH .....	12
A.2 99% AND 26DB BANDWIDTH .....	16
A.3 MAXIMUM CONDUCTED OUTPUT POWER .....	20
A.4 POWER SPECTRAL DENSITY .....	24
A.5 CONDUCTED SPURIOUS EMISSIONS .....	28
A.6 CONDUCTED BANDEDGE .....	35
<b>APPENDIX B: EMISSION TEST RESULTS .....</b>	<b>38</b>
RADIATED EMISSION SETUP DIAGRAM-BELOW 1G .....	38
RADIATED EMISSION SETUP DIAGRAM-ABOVE 1G .....	38
B.1 RADIATED SPURIOUS EMISSIONS .....	39
B.2 RECEIVER SPURIOUS EMISSIONS .....	48
B.3 RADIATED EMISSIONS 30MHZ TO 1GHZ .....	53
B.4 AC CONDUCTED EMISSIONS .....	55
<b>APPENDIX C: LIST OF TEST EQUIPMENT USED TO PERFORM THE TEST .....</b>	<b>61</b>
<b>APPENDIX E: ABBREVIATION KEY AND DEFINITIONS .....</b>	<b>63</b>



## Section 1: Overview

The samples were assessed against the tests under the requirements of the following specifications:

Emission
CFR47 Part 15.247 RSS247 Issue 1: May 2015 RSS-Gen Issue 4: Nov 2014

Measurements were made in accordance with

- ANSI C63.10:2013
- FCC KDB 662911 D01 v02r01
- KDB 558074 D01 Meas Guidance v03r04



## Section 2: Assessment Information

### 2.1 General

This report contains an assessment of an apparatus against Electromagnetic Compatibility Standards based upon tests carried out on the samples submitted. The testing was performed by and for the use of Cisco systems Inc:

With regard to this assessment, the following points should be noted:

- a) The results contained in this report relate only to the items tested and were obtained in the period between the date of the initial assessment and the date of issue of the report. Manufactured products will not necessarily give identical results due to production and measurement tolerances.
- b) The apparatus was set up and exercised using the configuration and modes of operation defined in this report only.
- c) Where relevant, the apparatus was only assessed using the susceptibility criteria defined in this report and the Test Assessment Plan (TAP).
- d) All testing was performed under the following environmental conditions:

Temperature	15°C to 35°C (54°F to 95°F)
Atmospheric Pressure	860mbar to 1060mbar (25.4" to 31.3")
Humidity	10% to 75*%

\*[Where applicable] For ESD testing the humidity limits used were 30% to 60% and for EFT/B tests the humidity limits used were 25% to 75%.
- e) All AC testing was performed at one or more of the following supply voltages:  
110V 60 Hz (+/-20%)

### Units of Measurement

The units of measurements defined in the appendices are reported in specific terms, which are test dependent. Where radiated measurements are concerned these are defined at a particular distance. Basic voltage measurements are defined in units of [dBuV]

As an example, the basic calculation for all measurements is as follows:

$$\text{Emission level [dBuV]} = \text{Indicated voltage level [dBuV]} + \text{Cable Loss [dB]} + \text{Other correction factors [dB]}$$

The combinations of correction factors are dependent upon the exact test configurations [see test equipment lists for further details] and may include:-

Antenna Factors, Pre Amplifier Gain, LISN Loss, Pulse Limiter Loss and Filter Insertion Loss..

Note: to convert the results from dBuV/m to uV/m use the following formula:-

$$\text{Level in uV/m} = \text{Common Antilogarithm} [(X \text{ dBuV/m})/20] = Y \text{ uV/m}$$



## Measurement Uncertainty Values

voltage and power measurements	$\pm 2$ dB
conducted EIRP measurements	$\pm 1.4$ dB
radiated measurements	$\pm 3.2$ dB
frequency measurements	$\pm 2.4 \cdot 10^{-7}$
temperature measurements	$\pm 0.54^{\circ}$
humidity measurements	$\pm 2.3\%$
DC and low frequency measurements	$\pm 2.5\%$

Where relevant measurement uncertainty levels have been estimated for tests performed on the apparatus. This uncertainty represents an expanded uncertainty expressed at approximately the 95% confidence level using a coverage factor of  $k=2$ .

## Radiated emissions (expanded uncertainty, confidence interval 95%)

30 MHz - 300 MHz	+/- 3.8 dB
300 MHz - 1000 MHz	+/- 4.3 dB
1 GHz - 10 GHz	+/- 4.0 dB
10 GHz - 18GHz	+/- 8.2 dB
18GHz - 26.5GHz	+/- 4.1 dB
26.5GHz - 40GHz	+/- 3.9 dB

## Conducted emissions (expanded uncertainty, confidence interval 95%)

30 MHz – 40GHz	+/- 0.38 dB
----------------	-------------

A product is considered to comply with a requirement if the nominal measured value is below the limit line. The product is considered to not be in compliance in case the nominal measured value is above the limit line.

**This report must not be reproduced except in full, without written approval of Cisco Systems.**

**2.2 Date of testing**

18-Feb-16 19-March-16

**2.3 Report Issue Date**

20-March-2016

Cisco uses an electronic system to issue, store and control the revision of test reports. This system is called the Engineering Document Control System (EDCS). The actual report issue date is embedded into the original file on EDCS. Any copies of this report, either electronic or paper, that are not on EDCS must be considered uncontrolled.

**2.4 Testing facilities**

This assessment was performed by:

**Testing Laboratory**

Cisco Systems, Inc.,  
125 West Tasman Drive  
San Jose, CA 95134, USA

**Registration Numbers for Industry Canada**

<b>Cisco System Site</b>	<b>Address</b>	<b>Site Identifier</b>
Building P, 10m Chamber	125 West Tasman Dr San Jose, CA 95134	Company #: 2461N-2
Building P, 5m Chamber	125 West Tasman Dr San Jose, CA 95134	Company #: 2461N-1
Building I, 5m Chamber	285 W. Tasman Drive San Jose, California 95134	Company #: 2461M-1

**Test Engineers**

Jose Aguirre

**2.5 Equipment Assessed (EUT)**

AIR-AP1810W-B-K9



## 2.6 EUT Description

The Cisco Aironet 802.11ac Dual Band Access Points with Bluetooth LE supports the following modes of operation. The modes are further defined in the radio Theory of Operation. The modes included in this report represent the worst case data for all modes. Data is recorded at the lowest supported data rate for each mode. This report covers operation on channel 2402MHz – 2480MHz.

BlueTooth LE v4.0: GFSK(1Mbps)

### WLAN

802.11n/ac - Legacy CCK, One Antenna, 1 to 11 Mbps  
802.11n/ac - Legacy CCK, Two Antennas, 1 to 11 Mbps

802.11n/ac - Non HT20, One Antenna, 6 to 54 Mbps  
802.11n/ac - Non HT20, Two Antennas, 6 to 54 Mbps

802.11n/ac - HT/VHT20, One Antenna, M0 to M7  
802.11n/ac - HT/VHT20, Two Antennas, M0 to M7  
802.11n/ac - HT/VHT20, Two Antennas, M8 to M15

802.11n/ac - HT/VHT20 Beam Forming, Two Antennas, M0 to M7  
802.11n/ac - HT/VHT20 Beam Forming, Two Antennas, M8 to M15

802.11n/ac - HT/VHT20 STBC, Two Antennas, M0 to M7

The following antennas are supported by this product series.  
The data included in this report represent the worst case data for all antennas.

Frequency	Part Number	Antenna Type	Antenna Gain (dBi)
<b>2.4 GHz</b> <b>2.4 / 5 GHz</b>	BlueTooth	Omni	2
	2x2 Internal	Omni	2 / 4

### Section 3: Result Summary

#### 3.1 Results Summary Table

##### Conducted emissions

Basic Standard	Technical Requirements / Details	Result
FCC 15.247 RSS-247 LP0002:3.10.1(6.2.1)	<b>6dB Bandwidth:</b> Systems using digital modulation techniques may operate in the 2400-2483.5MHz band. The minimum 6dB bandwidth shall be at least 500 kHz.	Pass
FCC 15.247 RSS-247	<b>99% &amp; 26 dB Bandwidth:</b> The 99% occupied bandwidth is the frequency bandwidth such that, below its lower and above its upper frequency limits, the mean powers are each equal to 0.5% of the total mean power of the given emission. There is no limit for 99% OBW. The 26 dB emission is the width of the emission that is constrained by the frequencies associated with the two outermost amplitude points (upper and lower frequencies) that are attenuated by 26 dB relative to the maximum level measured in the fundamental emission.	Pass
FCC 15.247 RSS-247 LP0002:3.10.1(2.3)	<b>Output Power:</b> <b>15.247</b> The maximum conducted output power of the intentional radiator for systems using digital modulation in the 2400-2483.5 MHz band shall not exceed 1 Watt (30dBm). If transmitting antennas of directional gain greater than 6 dBi are used, the maximum conducted output power shall be reduced by the amount in dB that the directional gain of the antenna exceeds 6 dBi. <b>RSS-247</b> For DTSs employing digital modulation techniques operating in the band 2400-2483.5 MHz, the maximum peak conducted output power shall not exceed 1W. Except as provided in Section 5.4(5), the e.i.r.p. shall not exceed 4 W.	Pass
FCC 15.247 RSS-247 LP0002:3.10.1(6.2.2)	<b>Power Spectral Density:</b> For digitally modulated systems, the power spectral density conducted from the intentional radiator to the antenna shall not be greater than 8 dBm in any 3 kHz band during any time interval of continuous transmission.	Pass
FCC 15.247 RSS-247 LP0002:3.10.1(5)/2.8	<b>Conducted Spurious Emissions / Band-Edge:</b> In any 100 kHz bandwidth outside the frequency band in which the spread spectrum or digitally modulated intentional radiator is operating, the radio frequency power that is produced by the intentional radiator shall be at least 20 dB below that in the 100 kHz bandwidth within the band that contains the highest level of the desired power, based on either an RF conducted or a radiated measurement, provided the transmitter demonstrates compliance with the peak conducted power limits. If the transmitter complies with the conducted power limits based on the use of RMS averaging over a time interval, as permitted under paragraph (b)(3) of this section, the attenuation required under this paragraph shall be 30 dB instead of 20 dB. Attenuation below the general limits specified in §15.209(a) is not required	Pass
FCC 15.247 RSS-247 FCC 15.205 RSS-Gen	<b>Restricted band:</b> Unwanted emissions falling within the restricted bands, as defined in FCC 15.205 (a) and RSS-Gen 8.10 must also comply with the radiated emission limits specified in FCC 15.209 (a) and RSS-Gen 8.9.	Pass



**Radiated Emissions (General requirements)**

Basic Standard	Technical Requirements / Details	Result
FCC 15.209 RSS-Gen LP0002:3.10.1(5)/2.8	<p><b>TX Spurious Emissions:</b> Except as provided elsewhere in this subpart, the emissions from an intentional radiator shall not exceed the field strength levels specified in the filed strength limits table in this section. Unwanted emissions falling within the restricted bands, as defined in FCC 15.205 (a) and RSS-Gen 8.10 must also comply with the radiated emission limits specified in FCC 15.209 (a) and RSS-Gen 8.9.</p>	Pass
RSS-Gen LP0002:3.10.1(5)2.8	<p><b>RX Spurious Emissions:</b>  <b>RSS-Gen 8.9</b> Except when the requirements applicable to a given device state otherwise, emissions from licence-exempt transmitters shall comply with the field strength limits shown in Table 4 and Table 5 below. Additionally, the level of any transmitter emission shall not exceed the level of the transmitter's fundamental emission.  <b>RSS-Gen 8.10</b> Unwanted emissions that fall into restricted bands of Table 6 shall comply with the limits specified in RSS-Gen; and (c ) Unwanted emissions that do not fall within the restricted frequency bands of Table 6 shall comply either with the limits specified in the applicable RSS or with those specified in this RSS-Gen.</p>	Pass
FCC 15.207 RSS-Gen LP0002:2.3	<p><b>AC conducted Emissions:</b> Except when the requirements applicable to a given device state otherwise, for any radio apparatus equipped to operate from the public utility AC power supply, either directly or indirectly (such as with a battery charger), the radio frequency voltage of emissions conducted back onto the AC power lines in the frequency range of 0.15 MHz to 30 MHz shall not exceed the limits shown in the table in these sections. The more stringent limit applies at the frequency range boundaries.</p>	Pass

\* MPE calculation is recorded in a separate report



#### Section 4: Sample Details

Note: Each sample was evaluated to ensure that its condition was suitable to be used as a test sample prior to the commencement of testing.

##### 4.1 Sample Details

Sample No.	Equipment Details	Manufacturer	Hardware Rev.	Firmware Rev.	Software Rev.	Serial Number
S01	AIR-AP1810W-B-K9	Cisco Systems	01	8.1.10.159	Linux v3.4.103	RFDP2AHY351
S02*	AIR-PWR-C	Meanwell	A0	NA	NA	EB46E93226

(\*) S02 are support equipment Power supplies for EUT S01

##### 4.2 System Details

System #	Description	Samples
1	AIR-AP1810W-B-K9	S01
2	AIR-PWR-C	S02

##### 4.3 Mode of Operation Details

Mode#	Description	Comments
1	Continuous Transmitting	Transmit - BLE (GFSK), 1Mbps

Measurements were made in accordance with

- ANSI C63.10:2013
- KDB 558074 D01 Meas Guidance v03r04



**Appendix A: Emission Test Results**

**Conducted Test Setup Diagram**

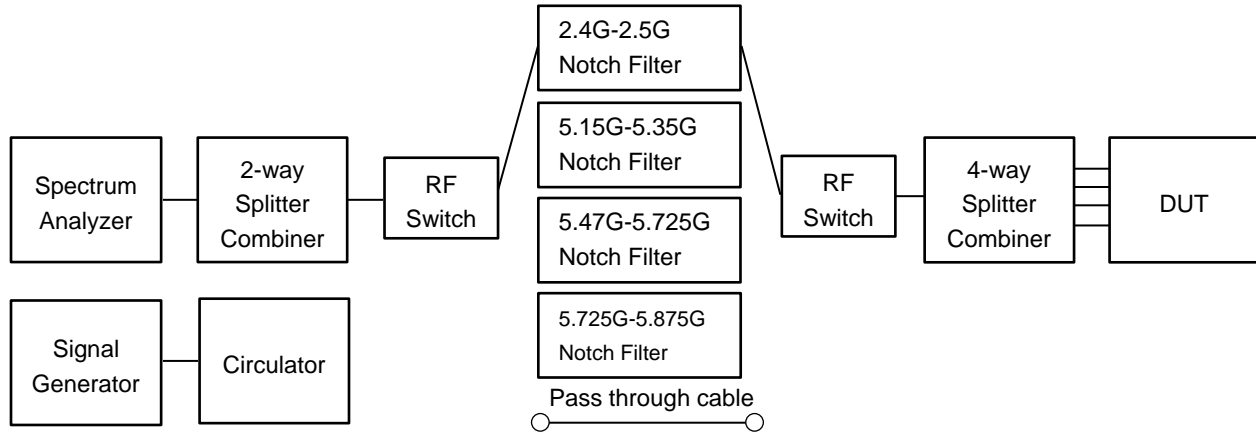

**Target Maximum Channel Power**

The following table details the maximum supported Total Channel Power for all operating modes.

Operating Mode	Maximum Channel Power (dBm)		
	Frequency (MHz)		
	2402	2442	2480
BLE (GFSK)	3.1	2.9	2.5



## A.1 6dB Bandwidth

**15.247 / RSS-247 / LP0002:3.10.1(6.2.1)** Systems using digital modulation techniques may operate in the 2400-2483.5MHz band. The minimum 6dB bandwidth shall be at least 500 kHz.

### Test Procedure

Ref. KDB 558074 D01 DTS Meas Guidance v03r04  
ANSI C63.10: 2013

#### 6 BW

##### Test Procedure

1. Set the radio in the continuous transmitting mode.
2. Allow the trace to stabilize.
3. Setting the x-dB bandwidth mode to -6dB within the measurement set up function.
4. Select the automatic OBW measurement function of an instrument to perform bandwidth measurement.
5. Capture graphs and record pertinent measurement data.

Ref. KDB 558074 D01 DTS Meas Guidance v03r04  
ANSI C63.10: 2013 section 11.8.2 Option 2

#### 6 BW

##### Test parameters

X dB BW = 6dB (using the OBW function of the spectrum analyzer)

Span = Large enough to capture the entire EBW

RBW = 100 KHz

VBW  $\geq$  3 x RBW

Sweep = Auto couple

Detector = Peak or where practical sample shall be used

Trace = Max. Hold

System Number	Description	Samples	System under test	Support equipment
1	EUT	S01	<input checked="" type="checkbox"/>	<input type="checkbox"/>
	Support	S02	<input type="checkbox"/>	<input checked="" type="checkbox"/>

**Tested By :**

Jose Aguirre

**Date of testing:**

18-Feb-16 19-March-16

**Test Result : PASS**

See Appendix C for list of test equipment



Frequency (MHz)	Mode	Data Rate (Mbps)	6dB BW (kHz)	Limit (kHz)	Margin (kHz)
2402	GFSK, 1Mbps	1	736	>500	236
2442	GFSK, 1Mbps	1	760	>500	260
2480	GFSK, 1Mbps	1	780	>500	280



**6dB Bandwidth, 2402 MHz, GFSK, 1Mbps**



**6dB Bandwidth, 2442 MHz, GFSK, 1Mbps**





**6dB Bandwidth, 2480 MHz, GFSK, 1Mbps**





## A.2 99% and 26dB Bandwidth

The 99% occupied bandwidth is the frequency bandwidth such that, below its lower and above its upper frequency limits, the mean powers are each equal to 0.5% of the total mean power of the given emission. There is no limit for 99% OBW.

The 26 dB emission is the width of the emission that is constrained by the frequencies associated with the two outermost amplitude points (upper and lower frequencies) that are attenuated by 26 dB relative to the maximum level measured in the fundamental emission.

### Test Procedure

Ref. ANSI C63.10: 2013

#### 26 BW & 99% BW

Test Procedure

1. Set the radio in the continuous transmitting mode.
2. Allow the trace to stabilize.
3. Setting the x-dB bandwidth mode to -26dB & OBW to 99% within the measurement set up function.
4. Select the automatic OBW measurement function of an instrument to perform bandwidth measurement.
5. Capture graphs and record pertinent measurement data.

Ref. ANSI C63.10: 2013 section 6.9.3

#### 26 BW & 99% BW

Test parameters

X dB BW = -26dB (using the OBW function of the spectrum analyzer)

OBW = 99%

Span = 1.5 to 5 times the OBW

RBW = 1% to 5% of the OBW

VBW  $\geq$  3 x RBW

Sweep = Auto couple

Detector = Peak or where practical sample shall be used

Trace = Max. Hold

System Number	Description	Samples	System under test	Support equipment
1	EUT	S01	<input checked="" type="checkbox"/>	<input type="checkbox"/>
	Support	S02	<input type="checkbox"/>	<input checked="" type="checkbox"/>

**Tested By :**

Jose Aguirre

**Date of testing:**

18-Feb-16 19-March-16

**Test Result : PASS**

See Appendix C for list of test equipment





Frequency (MHz)	Mode	Data Rate (Mbps)	26dB BW (MHz)	99% BW (MHz)
2402	GFSK, 1Mbps	1	1.33	1.05
2442	GFSK, 1Mbps	1	1.34	1.07
2480	GFSK, 1Mbps	1	1.33	1.07



**26dB / 99% Bandwidth, 2402 MHz, GFSK, 1Mbps**



**26dB / 99% Bandwidth, 2442 MHz, GFSK, 1Mbps**





**26dB / 99% Bandwidth, 2480 MHz, GFSK, 1Mbps**





## A.3 Maximum Conducted Output Power

**15.247 / LP0002:3.10.1(2.3)** The maximum conducted output power of the intentional radiator for systems using digital modulation in the 2400-2483.5 MHz band shall not exceed 1 Watt (30dBm). If transmitting antennas of directional gain greater than 6 dBi are used, the maximum conducted output power shall be reduced by the amount in dB that the directional gain of the antenna exceeds 6 dBi.

**RSS-247 section 5.4** For DTSs employing digital modulation techniques operating in the bands 2400-2483.5 MHz, the maximum peak conducted output power shall not exceed 1W. Except as provided in Section 5.4(5), the e.i.r.p. shall not exceed 4 W.

The maximum supported antenna gain is 2dBi. The peak correlated gain for each mode is listed in the table below. See the Theory of Operation for details on the correlated gain for each mode.

### Test Procedure

Ref. KDB\_D01 DTS Meas Guidance v03r04  
ANSI C63.10: 2013

#### Maximum Conducted Output power

Test Procedure

1. Set the radio in the continuous transmitting mode at full power
2. Compute power by integrating the spectrum across the EBW (or alternatively entire 99% OBW) of the signal using the instrument's band power measurement function. The integration shall be performed using the spectrum analyzer band-power measurement function with band limits set equal to the EBW or the OBW band edges.
3. Capture graphs and record pertinent measurement data.

Ref. 558074 D01 DTS Meas Guidance v03r04 section 9.1.1  $RBW \geq DTS \text{ Bandwidth}$

ANSI C63.10: 2013 section 11.9.1  $RBW \geq DTS \text{ Bandwidth}$

#### Maximum Conducted Output power

Test parameters

Span = >1.5 times the OBW  
RBW = 3MHz  
VBW  $\geq 3 \times RBW$   
Sweep = Auto couple  
Detector = Peak  
Trace = Max Hold  
Allow trace to fully stabilize  
Use peak marker function to determine the Peak amplitude level

System Number	Description	Samples	System under test	Support equipment
1	EUT	S01	<input checked="" type="checkbox"/>	<input type="checkbox"/>
	Support	S02	<input type="checkbox"/>	<input checked="" type="checkbox"/>

**Tested By :**

Jose Aguirre

**Date of testing:**

18-Feb-16 19-March-16

**Test Result : PASS**

See Appendix C for list of test equipment



Frequency (MHz)	Mode	Tx Paths	Correlated Antenna Gain (dBi)	Tx 1 Max Power (dBm)	Total Tx Channel Power (dBm) EIRP	Limit (dBm) EIRP	Margin (dB)
2402	GFSK, 1Mbps	1	2	3.1	5.1	36.0	30.9
2442	GFSK, 1Mbps	1	2	2.9	4.9	36.0	31.1
2480	GFSK, 1Mbps	1	2	2.5	4.5	36.0	31.5



**Peak Output Power, 2402 MHz, GFSK, 1Mbps**



**Peak Output Power, 2442 MHz, GFSK, 1Mbps**

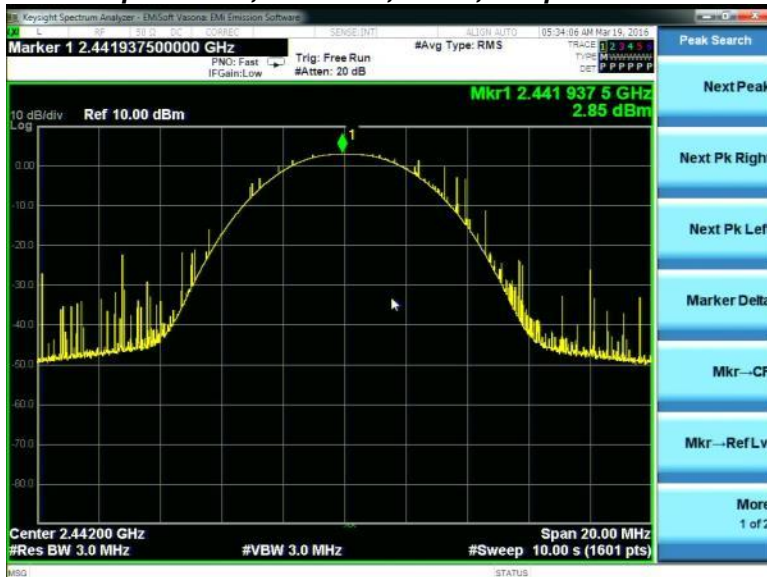



**Peak Output Power, 2480 MHz, GFSK, 1Mbps**

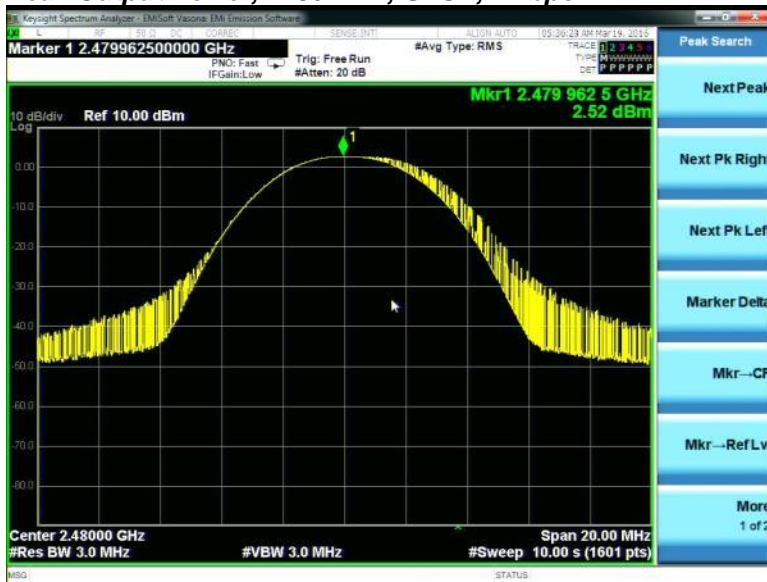



## A.4 Power Spectral Density

**15.247 / RSS-247 / LP0002:3.10.1(6.2.2)** For digitally modulated systems, the peak power spectral density conducted from the intentional radiator to the antenna shall not be greater than 8 dBm in any 3 kHz band during any time interval of continuous transmission.

### Test Procedure

Ref. KDB 558074 D01 DTS Meas Guidance v03r04  
ANSI C63.10: 2013

#### Power Spectral Density

Test Procedure

1. Set the radio in the continuous transmitting mode at full power
2. Configure Spectrum analyzer as per test parameters below and Peak search marker
3. Capture graphs and record pertinent measurement data.

Ref. 558074 D01 DTS Meas Guidance v03r04 section 10.2 Peak PSD  
ANSI C63.10: 2013 section 11.10.2 Peak PSD

#### Power Spectral Density

Test parameters

Span = >1.5 times the OBW  
 RBW = 3 kHz ≤ RBW ≤ 100 kHz.  
 VBW ≥ 3 x RBW  
 Sweep = Auto couple  
 Detector = Peak  
 Trace = Max Hold  
 Allow trace to fully stabilize  
 Use Peak Marker function to determin max amplitude level

System Number	Description	Samples	System under test	Support equipment
1	EUT	S01	<input checked="" type="checkbox"/>	<input type="checkbox"/>
	Support	S02	<input type="checkbox"/>	<input checked="" type="checkbox"/>

**Tested By :**

Jose Aguirre

**Date of testing:**

18-Feb-16 19-March-16

**Test Result : PASS**

See Appendix C for list of test equipment





Frequency (MHz)	Mode	Data Rate (Mbps)	PSD / Antenna (dBm/3kHz)	Total PSD (dBm/3kHz)	Limit (dBm/3kHz)	Margin (dB)
2402	GFSK, 1Mbps	1	-7.3	-7.3	8.0	15.3
2442	GFSK, 1Mbps	1	-8.1	-8.3	8.0	16.3
2480	GFSK, 1Mbps	1	-7.5	-7.5	8.0	15.5



### Power Spectral Density, 2402 MHz, GFSK, 1Mbps



### Power Spectral Density, 2442 MHz, GFSK, 1Mbps





### Power Spectral Density, 2480 MHz, GFSK, 1Mbps

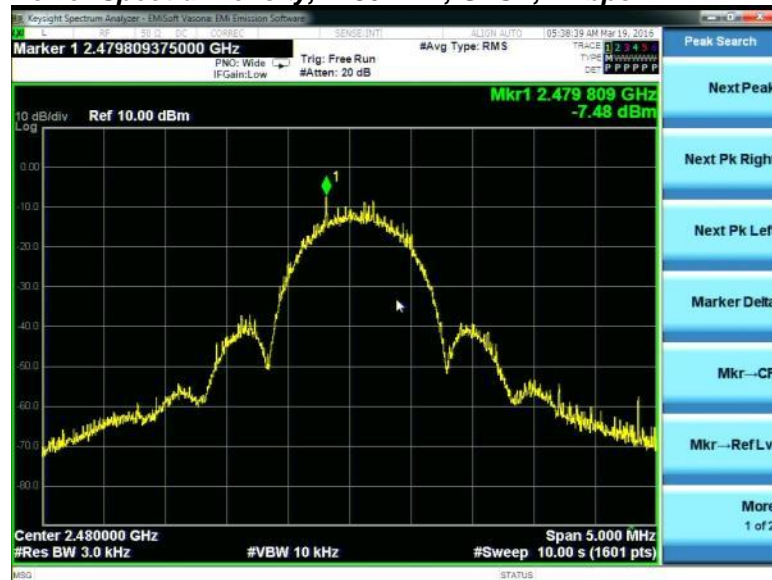



## A.5 Conducted Spurious Emissions

**15.205 / RSS-Gen / LP0002:3.10.1(5) & 2.8** Radiated emissions which fall in the restricted bands, as defined in Section 15.205(a) and RSS-Gen section 8.10, must also comply with the radiated emission limits specified in Section 15.209(a) (see Section 15.205(c)) and RSS-Gen section 8.9.

**RSS-Gen 8.9** Except when the requirements applicable to a given device state otherwise, emissions from licence-exempt transmitters shall comply with the field strength limits shown in Table 4 and Table 5 below. Additionally, the level of any transmitter emission shall not exceed the level of the transmitter's fundamental emission.

**RSS-Gen 8.10** Unwanted emissions that fall into restricted bands of Table 6 shall comply with the limits specified in RSS-Gen; and (c) Unwanted emissions that do not fall within the restricted frequency bands of Table 6 shall comply either with the limits specified in the applicable RSS or with those specified in this RSS-Gen.

### Test Procedure

Ref. KDB 558074 D01 DTS Meas Guidance v03r04  
ANSI C63.10: 2013

#### Conducted Spurious Emissions

##### Test Procedure

1. Connect the antenna port(s) to the spectrum analyzer input.
2. Place the radio in continuous transmit mode
3. Configure Spectrum analyzer as per test parameters below (be sure to enter all losses between the transmitter output and the spectrum analyzer).
4. Use the peak marker function to determine the maximum spurs amplitude level.
5. The "measure-and-sum technique" is used for measuring in-band transmit power of a device. In the measure-and-sum approach, the conducted emission level is measured at each antenna port. The measured results at the various antenna ports are then summed mathematically to determine the total emission level from the device. Summing is performed in linear power units. The worst case output is recorded. (see ANSI C63.10 2013 section 14.3.2.2)
6. Capture graphs and record pertinent measurement data.

Ref. 558074 D01 DTS Meas Guidance v03r04 section 11.1b, 11.2-3, 12.2.4 & 12.2.5.3  
ANSI C63.10: 2013 section 11.10.3 & 11.12.2.4 & 11.12.2.5.3

#### Conduct Conducted Spurious Emissions

Test parameters restricted Band

KDB 558074 D01 v03r04 section 12.2.4 & 12.2.5.3 also see ANSI C63.10: 2013 section 11.12.4 & 11.12.5.3

RBW = 1 MHz  
VBW  $\geq 3 \times$  RBW for Peak, 1kHz for Average  
Sweep = Auto couple  
Detector = Peak  
Trace = Max Hold.

KDB: 558074 D01 DTS Meas Guidance v03r04 section 12.2.2 © add the max antenna gain + ground reflection factor (4.7 dB for frequencies between 30 MHz and 1000 MHz, and 0 dB for frequencies > 1000 MHz).

System Number	Description	Samples	System under test	Support equipment
1	EUT	S01	<input checked="" type="checkbox"/>	<input type="checkbox"/>
	Support	S02	<input type="checkbox"/>	<input checked="" type="checkbox"/>

**Tested By :**

Jose Aguirre

**Date of testing:**

18-Feb-16 19-March-16

**Test Result : PASS**

See Appendix C for list of test equipment

**Average Measurements**

Frequency (MHz)	Mode	Tx Paths	Correlated Antenna Gain (dBi)	Tx 1 Emission Level (dBm)	Total Emission Level (dBm)	Limit (dBm)	Margin (dB)
2402	GFSK, 1Mbps	1	2	-47.9	-45.9	-41.25	4.6
2442	GFSK, 1Mbps	1	2	-51.8	-49.8	-41.25	8.5
2480	GFSK, 1Mbps	1	2	-52.4	-50.4	-41.25	9.1



**Conducted Spurs, 2402 MHz, GFSK 1Mbps, Average Plot**



**Conducted Spurs, 2442 MHz, GFSK 1Mbps, Average Plot**





**Conducted Spurs, 2480 MHz, GFSK 1Mbps, Average Plot**



**Peak Measurements**

Frequency (MHz)	Mode	Tx Paths	Correlated Antenna Gain (dBi)	Tx 1 Emission Level (dBm)	Total Emission Level (dBm)	Limit (dBm)	Margin (dB)
2402	GFSK, 1Mbps	1	2	-44.8	-42.8	-21.25	21.5
2442	GFSK, 1Mbps	1	2	-48.0	-46.0	-21.25	24.7
2480	GFSK, 1Mbps	1	2	-47.0	-45.0	-21.25	23.7





**Conducted Spurs, 2402 MHz, GFSK 1Mbps, Peak Plot**

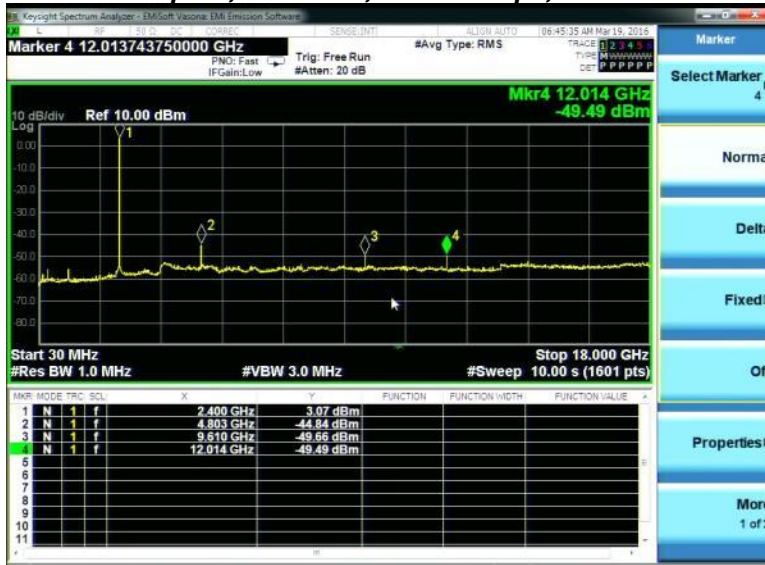

**Conducted Spurs, 2442 MHz, GFSK 1Mbps, Peak Plot**





**Conducted Spurs, 2480 MHz, GFSK 1Mbps, Peak Plot**





## A.6 Conducted Bandedge

**15.205 / 15.247 / RSS-Gen / RSS-247 / LP0002:3.10.1(5) & 2.8** In any 100 kHz bandwidth outside the frequency band in which the digitally modulated intentional radiator is operating, the radio frequency power that is produced by the intentional radiator shall be at least 30 dB below that in the 100 kHz bandwidth within the band that contains the highest level of the desired power.

### Test Procedure

Ref. KDB 558074 D01 DTS Meas Guidance v03r04  
ANSI C63.10: 2013

<b>Conducted Band edge</b>
Test Procedure
<ol style="list-style-type: none"> <li>1. Connect the antenna port(s) to the spectrum analyzer input.</li> <li>2. Place the radio in continuous transmit mode. Use the procedures in KDB 558074 D01 DTS Meas Guidance v03r04 to substitute conducted measurements in place of radiated measurements.</li> <li>3. Configure Spectrum analyzer as per test parameters below (be sure to enter all losses between the transmitter output and the spectrum analyzer).</li> <li>4. Place a marker at the end of the restricted band closest to the transmit frequency to show compliance. Also measure any emissions in the restricted bands..</li> <li>5. The "measure-and-sum technique" is used for measuring in-band transmit power of a device. In the measure-and-sum approach, the conducted emission level is measured at each antenna port. The measured results at the various antenna ports are then summed mathematically to determine the total emission level from the device. Summing is performed in linear power units. The worst case output is recorded.</li> <li>6. Place a marker at the end of the restricted band closest to the transmit frequency to show compliance. Also measure any emissions in the restricted bands</li> <li>7. Capture graphs and record pertinent measurement data.</li> </ol>

<b>Conducted Bandedge</b>
Test parameters KDB 558074 D01 v03r04 section 11.1b, 11.2-3, also see ANSI C63.10: 2013 section 11.10.3
RBW = 100 kHz VBW ≥ 3 x RBW Sweep = Auto couple Detector = Peak Trace = Max Hold.

<b>System Number</b>	<b>Description</b>	<b>Samples</b>	<b>System under test</b>	<b>Support equipment</b>
1	EUT	S01	<input checked="" type="checkbox"/>	<input type="checkbox"/>
	Support	S02	<input type="checkbox"/>	<input checked="" type="checkbox"/>

<b>Tested By :</b> Jose Aguirre	<b>Date of testing:</b> 18-Feb-16 19-March-16
<b>Test Result : PASS</b>	

See Appendix C for list of test equipment



Frequency (MHz)	Mode	Tx Paths	In Band PSD level @ 100kHz (dBm)	Tx 1 Bandedge Level (dBm)	Total Tx Bandedge Level (dBc)	Limit (dBc)	Margin (dB)
2412	GFSK, 1Mbps	1	2.53	-48.41	50.82	>30dBc	20.82
2462	GFSK, 1Mbps	1	1.88	-47.70	49.58	>30dBc	19.58



**Conducted Bandedge, 2402 MHz, GFSK 1Mbps**



**Conducted Bandedge, 2480 MHz, GFSK 1Mbps**



### Appendix B: Emission Test Results

Testing Laboratory: Cisco Systems, Inc., 125 West Tasman Drive, San Jose, CA 95134, USA

#### Radiated Emission Setup Diagram-Below 1G

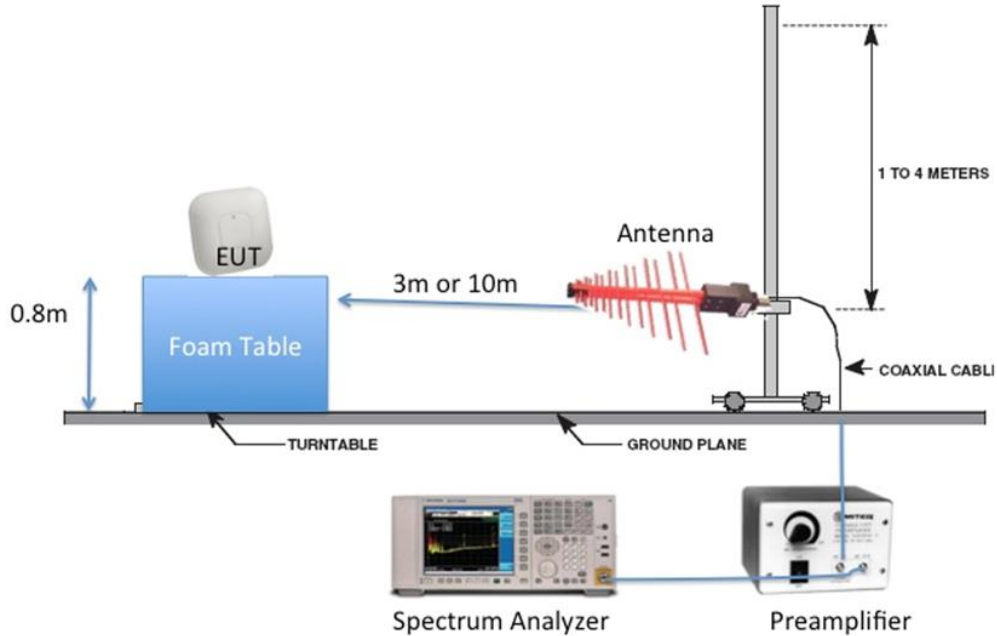

#### Radiated Emission Setup Diagram-Above 1G

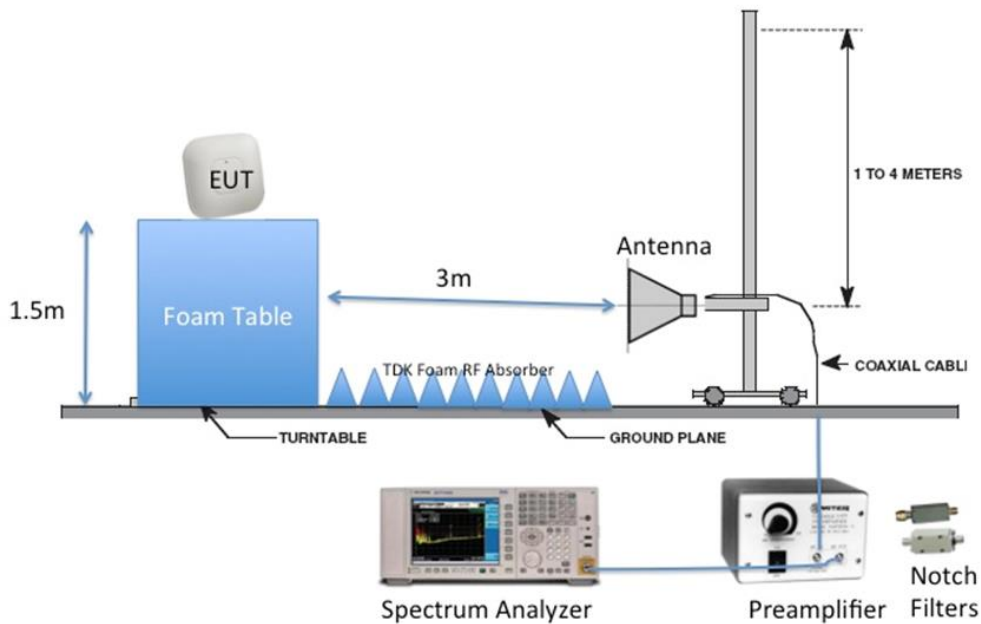



## B.1 Radiated Spurious Emissions

**15.205 / RSS-Gen / LP0002:3.10.1(5)/2.8** Radiated emissions which fall in the restricted bands, as defined in Section 15.205(a) and RSS-Gen 8.10, must also comply with the radiated emission limits specified in Section 15.209(a) (see Section 15.205(c)) and RSS-Gen 8.9.

**Ref.** ANSI C63.10: 2013 section 4.1.4.2.2, 4.1.4.2.3, 6.6.4 & 11.12.2

Using Vasona, configure the spectrum analyzer as shown below (be sure to enter all losses between the transmitter output and the spectrum analyzer). Place the radio in continuous transmit mode.

Span:	1GHz – 18 GHz
Reference Level:	80 dBuV
Attenuation:	10 dB
Sweep Time:	Coupled
Resolution Bandwidth:	1MHz
Video Bandwidth:	3 MHz for peak, 1 KHz for average
Detector:	Peak

Terminate the access Point RF ports with 50 ohm loads.

Maximize Turntable (find worst case table angle), Maximize Antenna (find worst case height)

Save 2 plots:     1) Average plot, Limit= 54dBuV/m @3m  
                       2) Peak plot, Limit = 74dBuV/m @3m

Place a marker at the end of the restricted band closest to the transmit frequency to show compliance. Also measure any emissions in the restricted bands.

This report represents the worst case data for all supported operating modes and antennas. There are no measurable emissions above 18 GHz.

System Number	Description	Samples	System under test	Support equipment
1	EUT	S01	<input checked="" type="checkbox"/>	<input type="checkbox"/>
	Support	S02	<input type="checkbox"/>	<input checked="" type="checkbox"/>

<b>Tested By :</b> Jose Aguirre	<b>Date of testing:</b> 18-Feb-16 19-March-16
<b>Test Result : PASS</b>	

See Appendix C for list of test equipment





### B.1.A Transmitter Radiated Spurious Emissions-Average

Frequency (MHz)	Mode	Data Rate (Mbps)	Spurious Emission Level (dBuV/m)	Limit (dBuV/m)	Margin (MHz)
2402	GFSK 1Mbps	1	39.5	54	14.5
2442	GFSK 1Mbps	1	39.4	54	14.6
2480	GFSK 1Mbps	1	39.2	54	14.8

Radiated Spurs, 2402 MHz, GFSK 1Mbps, Average (1-10GHz)



Radiated Spurs, 2402 MHz, GFSK 1Mbps, Average (10-18GHz)







**Radiated Spurs, 2442 MHz, GFSK 1Mbps, Average (1-10GHz)**



**Radiated Spurs, 2442 MHz, GFSK 1Mbps, Average (10-18GHz)**





**Radiated Spurs, 2480 MHz, GFSK 1Mbps, Average (1-10GHz)**



**Radiated Spurs, 2480 MHz, GFSK 1Mbps, Average (10-18GHz)**





### Radiated Spurs, All Rates, All Modes, Average



no emissions seen above 18GHz. The plot above is representative of all modes tested



**B.1.P Transmitter Radiated Spurious Emissions-Peak**

Frequency (MHz)	Mode	Data Rate (Mbps)	Spurious Emission Level (dBuV/m)	Limit (dBuV/m)	Margin (MHz)
2402	GFSK 1Mbps	1	50.5	74	23.5
2442	GFSK 1Mbps	1	50.7	74	23.3
2480	GFSK 1Mbps	1	50.6	74	23.4

**Radiated Spurs, 2402 MHz, GFSK 1Mbps, Peak (1-10GHz)**



**Radiated Spurs, 2402 MHz, GFSK 1Mbps, Peak (10-18GHz)**





**Radiated Spurs, 2442 MHz, GFSK 1Mbps, Peak (1-10GHz)**



**Radiated Spurs, 2442 MHz, GFSK 1Mbps, Peak (10-18GHz)**





**Radiated Spurs, 2480 MHz, GFSK 1Mbps , Peak (1-10GHz)**

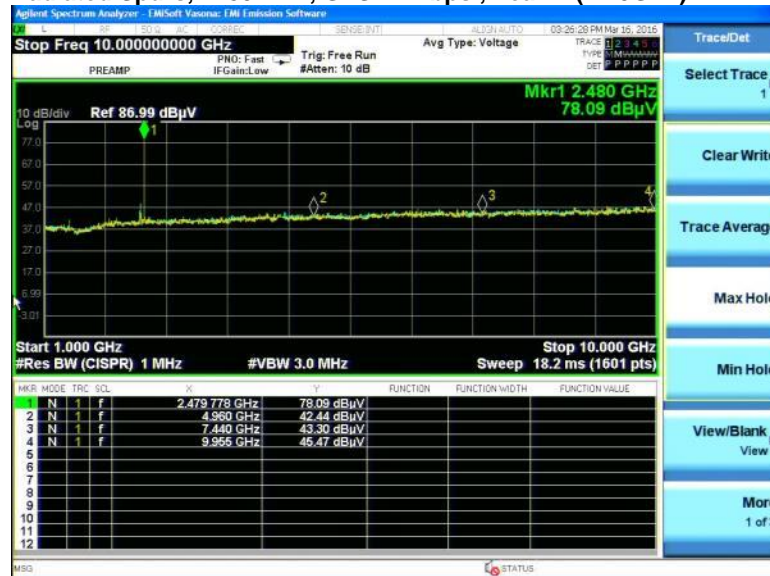

**Radiated Spurs, 2480 MHz, GFSK 1Mbps , Peak (10-18GHz)**

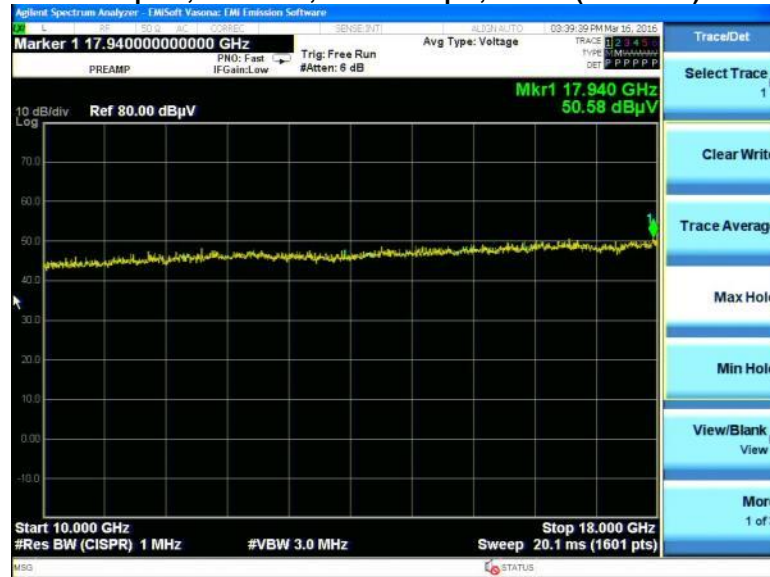





### Radiated Spurs, All channels, Peak

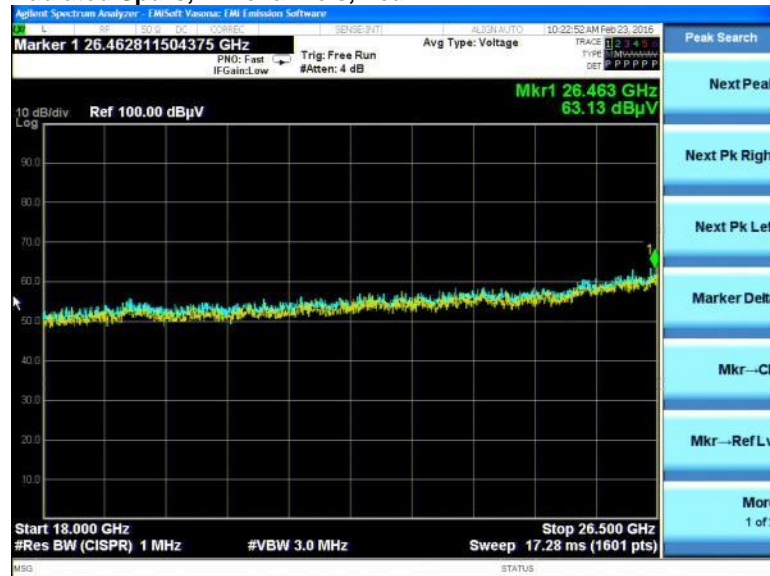

No emissions seen above 18GHz. The above plot is representative of all 3 channels tested



## B.2 Receiver Spurious Emissions

**RSS-Gen** Receivers are required to comply with the limits of spurious emissions as set out in this section. Receiver emission measurements are to be performed as per the normative test method referenced in Section 3.

Radiated emissions which fall in the restricted bands, as defined in RSS-Gen section 8.10, must also comply with the radiated emission limits specified in RSS-Gen section 8.9.

For emissions at frequencies below 1 GHz, measurements shall be performed using a CISPR quasi-peak detector and the related measurement bandwidth. At frequencies above 1 GHz, measurements shall be performed using a linear average detector with a minimum resolution bandwidth of 1 MHz.

**Ref.** RSS-Gen section 8.9 & 8.10  
ANSI C63.10: 2013 section 4.1.4.2.2, 4.1.4.2.3, 6.6.4 & 11.12.2

Using Vasona, configure the spectrum analyzer as shown below (be sure to enter all losses between the transmitter output and the spectrum analyzer). Place the radio in continuous transmit mode.

Span:	1GHz – 18 GHz
Reference Level:	80 dBuV
Attenuation:	10 dB
Sweep Time:	Coupled
Resolution Bandwidth:	1MHz
Video Bandwidth:	3MHz for Peak, 1 kHz for average
Detector:	Peak

Radiated emission measurements shall be performed with the receiver antenna connected to the receiver antenna terminals.

Maximize Turntable (find worst case table angle), Maximize Antenna (find worst case height)

Save plot: 1) Average Plot (Vertical and Horizontal), Limit= 54dBuV/m @3m  
2) Peak Plot (Vertical and Horizontal), Limit= 74dBuV/m @3m

This report represents the worst case data for all supported operating modes and antennas. There are no measurable emissions above 18 GHz.

System Number	Description	Samples	System under test	Support equipment
1	EUT	S01	<input checked="" type="checkbox"/>	<input type="checkbox"/>
	Support	S02	<input type="checkbox"/>	<input checked="" type="checkbox"/>

<b>Tested By :</b> Jose Aguirre	<b>Date of testing:</b> 18-Feb-16 19-March-16
<b>Test Result : PASS</b>	

See Appendix C for list of test equipment





## B.2.A Receiver Radiated Spurious Emissions (Average Measurements)

### B.2.A.1 Radiated Receiver Spurs, All rates, All Mode, Average (1-10GHz)



### B.2.A.1 Radiated Receiver Spurs, All rates, All Mode, Average (10-18GHz)





**B.2.P.2 Radiated Receiver Spurs, All rates, All Mode, Average (18-26.5GHz)**





## B.2.P Receiver Radiated Spurious Emissions (Peak Measurements)

### B.2.P.1 Radiated Receiver Spurs, All rates, All Mode, Peak (1-10GHz)

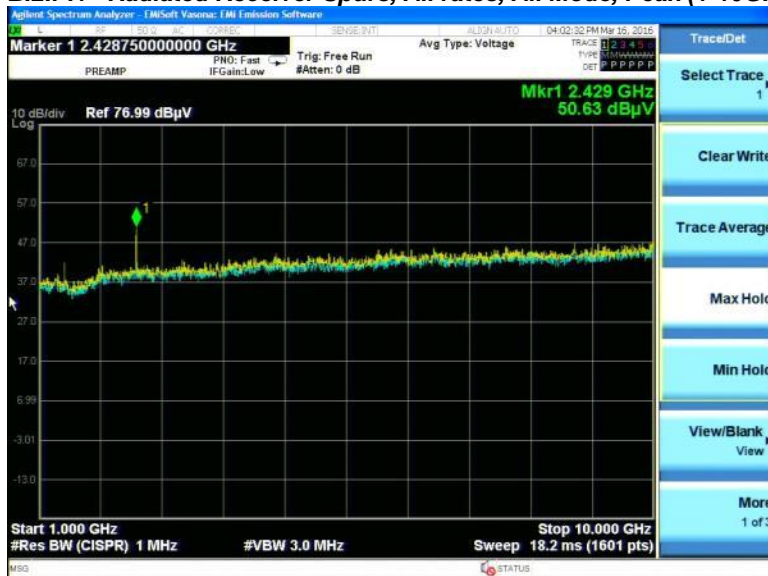

### B.2.P.1 Radiated Receiver Spurs, All rates, All Mode, Peak (10-18GHz)





**B.2.P.2 Radiated Receiver Spurs, All rates, All Mode, Peak (18-26.5GHz)**





## B.3 Radiated Emissions 30MHz to 1GHz

**15.205 / 15.209 / RSS-Gen / LP0002:3.10.1(5)/2.8** Radiated emissions which fall in the restricted bands, as defined in Section 15.205(a), must also comply with the radiated emission limits specified in Section 15.209(a) (see Section 15.205(c)) and RSS-Gen section 8.9.

**Ref.** ANSI C63.10: 2013 section 6.5

Using Vasona, configure the spectrum analyzer as shown below (be sure to enter all losses between the transmitter output and the spectrum analyzer). Place the radio in continuous transmit mode.

Span:	30MHz – 1GHz
Reference Level:	80 dBuV
Attenuation:	10 dB
Sweep Time:	Coupled
Resolution Bandwidth:	100kHz
Video Bandwidth:	300kHz
Detector:	Peak for Pre-scan, Quasi-Peak

Compliance shall be determined using CISPR quasi-peak detection; however, peak detection is permitted as an alternative to quasi-peak detection.

Terminate the access Point RF ports with 50 ohm loads.

Maximize Turntable (find worst case table angle), Maximize Antenna (find worst case height)

This report represents the worst case data for all supported operating modes and antennas.

System Number	Description	Samples	System under test	Support equipment
1	EUT	S01	<input checked="" type="checkbox"/>	<input type="checkbox"/>
	Support	S02	<input type="checkbox"/>	<input checked="" type="checkbox"/>

<b>Tested By :</b> Jose Aguirre	<b>Date of testing:</b> 18-Feb-16 19-March-16
<b>Test Result : PASS</b>	

See Appendix C for list of test equipment



**Graphical Test Results**

Note that the data displayed on the plots detailed in this appendix were measured using a 'Peak Detector'. Please refer to the results table for the detectors used during formal measurements

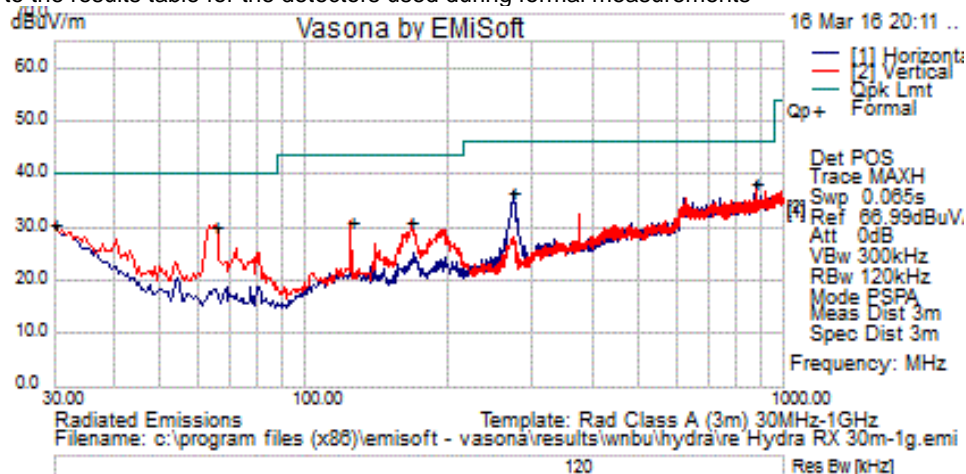

**Test Results Table**

Frequency MHz	Raw dBuV	Cable Loss	AF dB	Level dBuV/m	Measurement Type	Pol	Hgt cm	Azt Deg	Limit dBuV/m	Margin dB	Pass /Fail
875.113	14.1	2.8	21.7	38.6	Quasi Peak.	H	100	67	46	-7.4	Pass
30	8.5	0.5	21.7	30.7	Quasi Peak.	V	400	15	40	-9.3	Pass
273.106	21.8	1.6	13.2	36.6	Quasi Peak.	H	100	42	46	-9.4	Pass
65.163	21.4	0.8	8.1	30.2	Quasi Peak.	V	200	109	40	-9.8	Pass
167.013	18.2	1.2	11.8	31.2	Quasi Peak.	V	100	290	43.5	-12.3	Pass
125.181	16.1	1.1	13.9	31	Quasi Peak.	V	100	48	43.5	-12.5	Pass



## B.4 AC Conducted Emissions

**FCC 15.207 (a) & RSS-Gen 8.8 / LP0002:2.3** Except when the requirements applicable to a given device state otherwise, for any radio apparatus equipped to operate from the public utility AC power supply, either directly or indirectly (such as with a battery charger), the radio frequency voltage of emissions conducted back onto the AC power lines in the frequency range of 0.15 MHz to 30 MHz shall not exceed the limits shown in the table in these sections. The more stringent limit applies at the frequency range boundaries.

Measurement Procedure  
 Accordance with ANSI C63.10:2013 section 6.2

Using Vasona, configure the spectrum analyzer as shown below (be sure to enter all losses between the transmitter output and the spectrum analyzer). Place the radio in continuous transmit mode.

Span: 150 KHz – 30 MHz  
 Attenuation: 10 dB  
 Sweep Time: Coupled  
 Resolution Bandwidth: 9 KHz  
 Video Bandwidth: 30 KHz  
 Detector: Quasi-Peak / Average

System Number	Description	Samples	System under test	Support equipment
1	EUT	S01	<input checked="" type="checkbox"/>	<input type="checkbox"/>
	Support	S02	<input type="checkbox"/>	<input checked="" type="checkbox"/>

<b>Tested By :</b> Jose Aguirre	<b>Date of testing:</b> 18 Feb 16 – 22 Feb 16
<b>Test Result : PASS</b>	

See separate EMC test report for test data.



**Graphical Test Results**

Note that the data displayed on the plots detailed in this appendix were measured using a 'Peak Detector'. Please refer to the results table for the detectors used during formal measurements

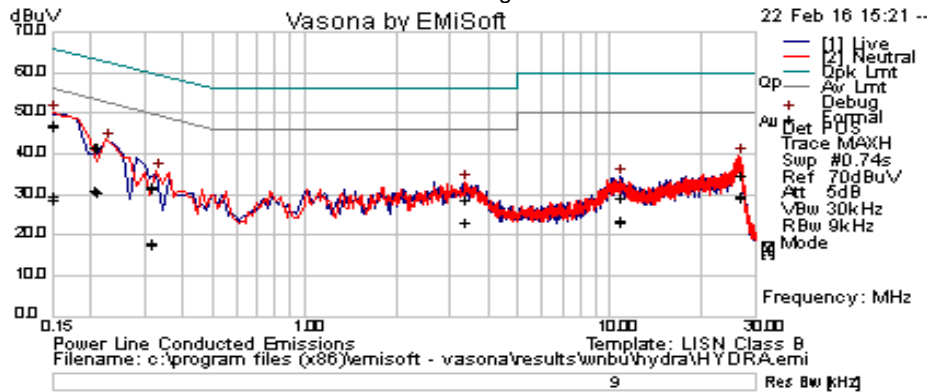

**Test Results**

Frequency MHz	Raw dBuV	Cable Loss	Factors dB	Level dBuV	Measurement Type	Line	Limit dBuV	Margin dB	Pass /Fail
3.328074	8.87	19.94	0.05	28.87	Quasi Peak	Live	56	-27.13	Pass
0.206625	20.9	20.8	0.05	41.76	Quasi Peak	Live	63.34	-21.58	Pass
0.150119	25.75	21.16	0.08	46.98	Quasi Peak	Live	65.99	-19.01	Pass
26.520726	14.4	20.44	0.28	35.11	Quasi Peak	Live	60	-24.89	Pass
10.79433	9.38	20.09	0.08	29.55	Quasi Peak	Live	60	-30.45	Pass
0.312792	11.36	20.34	0.04	31.74	Quasi Peak	Live	59.9	-28.15	Pass
0.209523	20.96	20.79	0.05	41.8	Quasi Peak	Neutral	63.22	-21.42	Pass
0.150339	26.11	21.16	0.08	47.35	Quasi Peak	Neutral	65.98	-18.63	Pass
26.513274	14.07	20.44	0.28	34.78	Quasi Peak	Neutral	60	-25.22	Pass
0.313386	11.62	20.34	0.04	32	Quasi Peak	Neutral	59.88	-27.88	Pass
3.355524	8.79	19.94	0.05	28.78	Quasi Peak	Neutral	56	-27.22	Pass
10.791576	9.2	20.09	0.08	29.37	Quasi Peak	Neutral	60	-30.63	Pass
3.328074	3.5	19.94	0.05	23.5	Average	Live	46	-22.5	Pass
0.206625	10.25	20.8	0.05	31.1	Average	Live	53.34	-22.24	Pass
0.150119	7.65	21.16	0.08	28.88	Average	Live	55.99	-27.11	Pass
26.520726	9.1	20.44	0.28	29.81	Average	Live	50	-20.19	Pass
10.79433	3.56	20.09	0.08	23.73	Average	Live	50	-26.27	Pass
0.312792	-2.8	20.34	0.04	17.59	Average	Live	49.9	-32.31	Pass
0.209523	9.94	20.79	0.05	30.78	Average	Neutral	53.22	-22.45	Pass
0.150339	8.39	21.16	0.08	29.62	Average	Neutral	55.98	-26.36	Pass
26.513274	8.64	20.44	0.28	29.36	Average	Neutral	50	-20.64	Pass
0.313386	-2.14	20.34	0.04	18.24	Average	Neutral	49.88	-31.64	Pass
3.355524	3.46	19.94	0.05	23.45	Average	Neutral	46	-22.55	Pass
10.791576	3.16	20.09	0.08	23.33	Average	Neutral	50	-26.67	Pass



Photographs of setup



Title: Conducted Test Setup

**AIR-AP1810W-x-K9** AC Mains Conducted Emissions setup

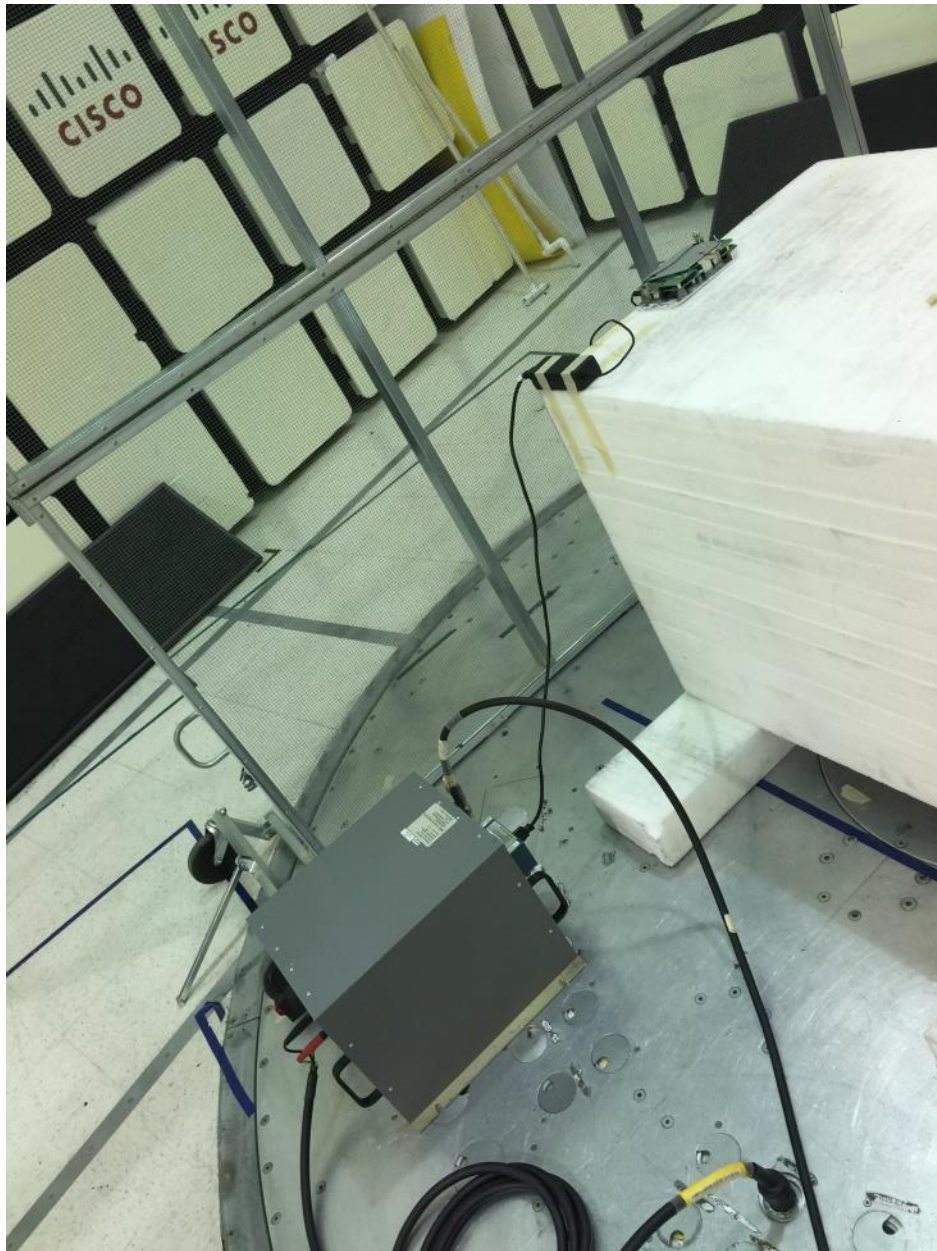

**AIR-AP1810W-x-K9 Radiated Emissions setup 30MHz – 1GHz**

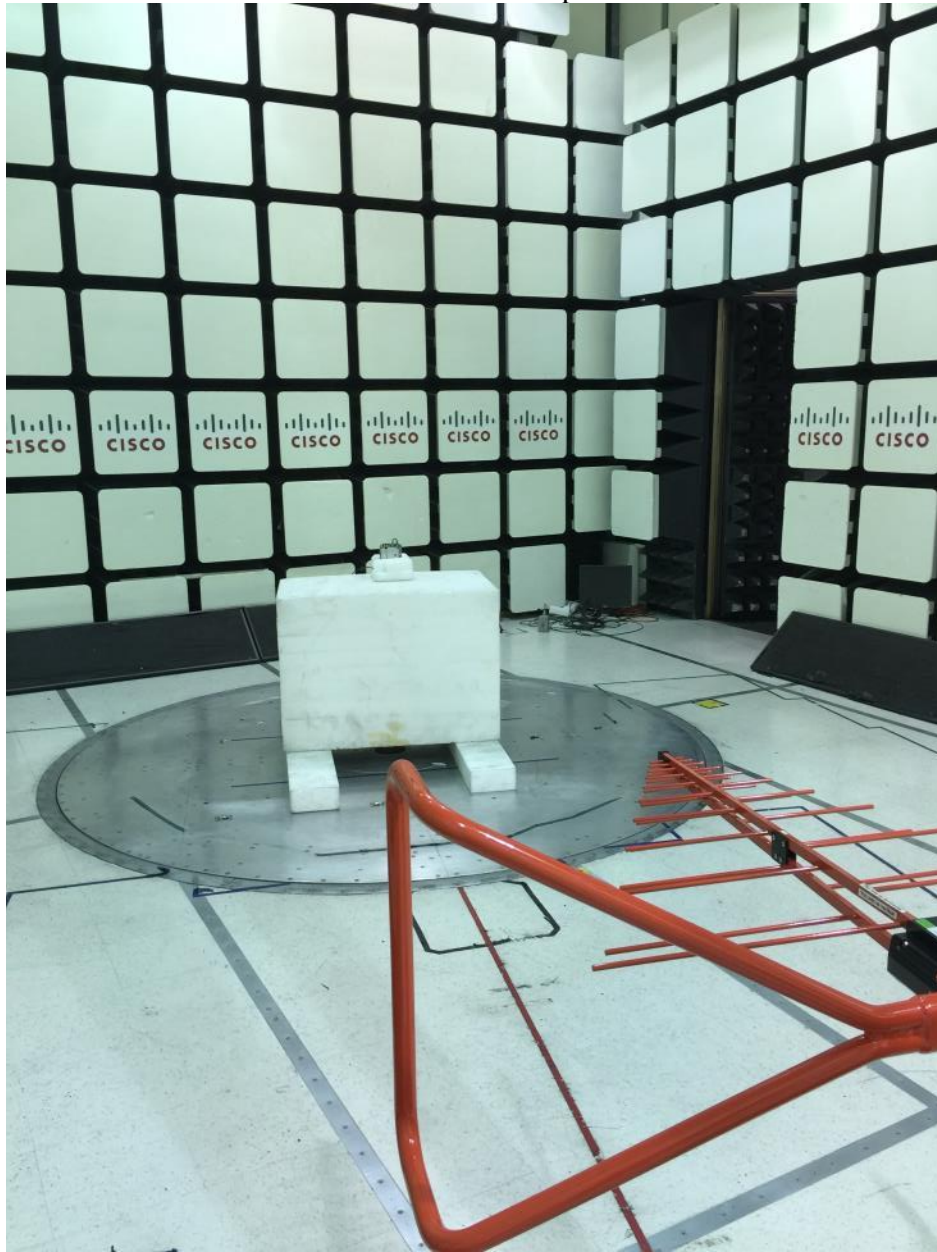



**AIR-AP1810W-x-K9 Radiated Emissions setup above 1GHz**

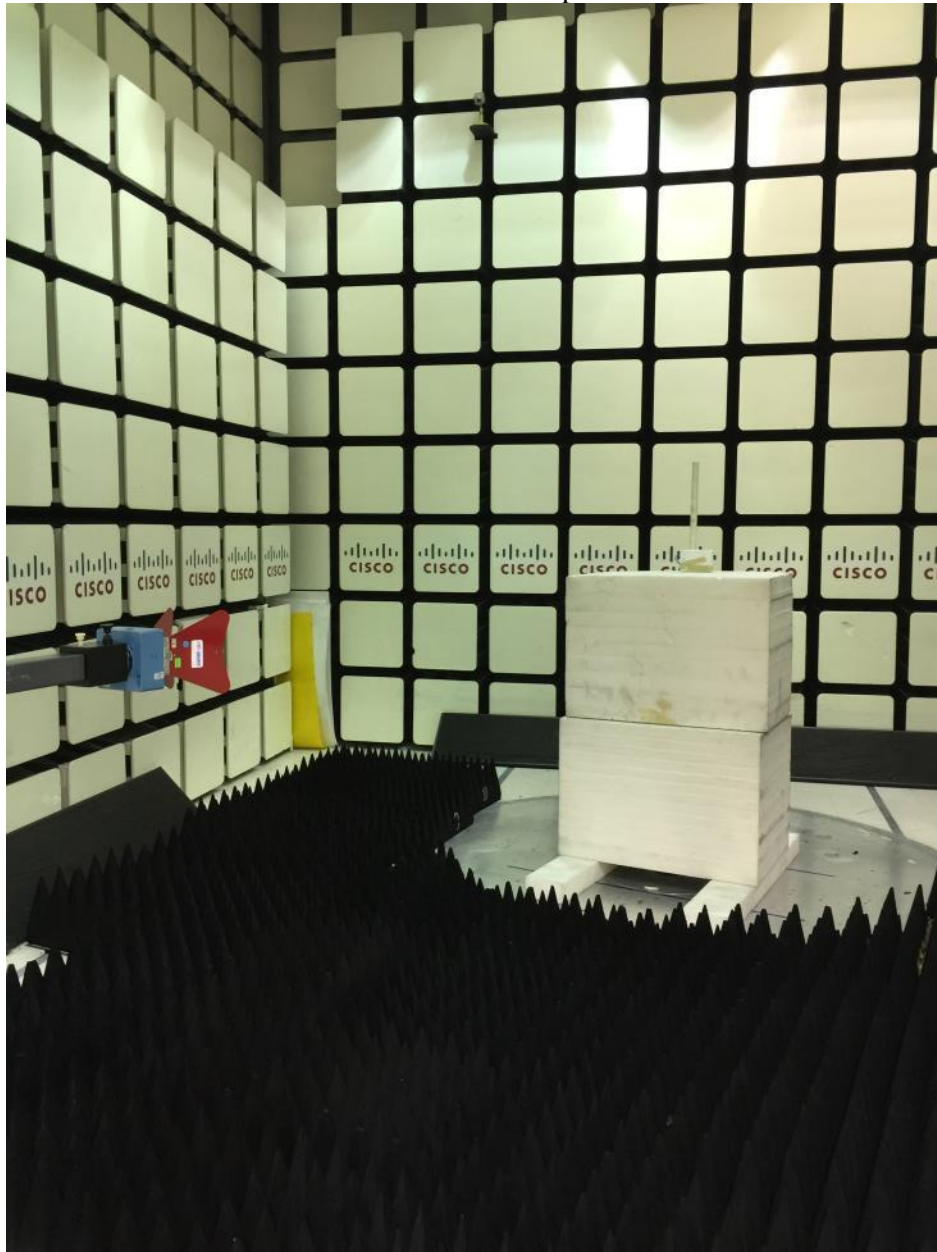



## Appendix C: List of Test Equipment Used to perform the test

Equip#	Manufacturer/ Model	Description	Last Cal	Next Due	Test Item
<b>Test Equipment used for Radiated Emissions</b>					
CIS005691	NSP1800-25-S1 Miteq	Broadband Preamplifier (1-18GHz)	25-Jun-15	25-Jun-16	B.1, B.2
CIS008448	NSA 5m Chamber Cisco	NSA 5m Chamber	9-Oct-15	9-Oct-16	B.1, B.2, B.3
CIS021117	UFB311A-0-2484-520520 Micro-Coax	RF Coaxial Cable, to 18GHz, 248.4 in	24-Aug-15	24-Aug-16	B.1, B.2, B.3
CIS034075	RSG 2000 Schaffner	Reference Spectrum Generator, 1-18GHz	Cal Not Required	Cal Not Required	B.1, B.2
CIS035284	3117 ETS-Lindgren	Double Ridged Waveguide Horn Antenna	30-Sep-15	30-Sep-16	B.1, B.2
CIS037236	50CB-015 JFW	GPIB Control Box	Cal Not Required	Cal Not Required	B.1, B.2
CIS040597	Above 1GHz Site Cal Cisco	Above 1GHz Cispr Site Verification	25-Sep-15	25-Sep-16	B.1, B.2
CIS041979	1840 Cisco	18-40GHz EMI Test Head/Verification Fixture	13-Jul-15	13-Jul-16	B.1, B.2
CIS042266	JB1 Sunol Sciences	Combination Antenna	21-Apr-15	21-Apr-16	B.3
CIS044940	ESU40 Rohde & Schwarz	EMI Test Receiver, 20Hz-40GHz	2-Nov-15	2-Nov-16	B.1, B.2, B.3
CIS054230	iBTHP-5-DB9 Newport	5 inch Temp/RH/Press Sensor w/20ft cable	10-Feb-16	10-Feb-17	B.1, B.2, B3
CIS041979	1840 Cisco	18-40GHz EMI Test Head/Verification Fixture	13-Jul-15	13-Jul-16	B.1, B.2
CIS047299	N9030A Agilent Technologies	PXA Signal Analyzer	23-Oct-15	23-Oct-16	B.1, B.2
CIS037236	50CB-015 JFW	GPIB Control Box	Cal Not Required	Cal Not Required	B.1, B.2
CIS034075	RSG 2000 Schaffner	Reference Spectrum Generator, 1-18GHz	Cal Not Required	Cal Not Required	B.1, B.2
CIS049563	Sucoflex 106A Huber + Suhner	N Type Cable 18GHz	24-Aug-15	24-Aug-16	B.1, B.2, B3

<b>Test Equipment used for AC Mains Conducted Emissions</b>					
Equip No	Model Manufacturer	Description	Last Cal	Next Cal	Test Item
CIS002464	FCC-801-M2-16 Fischer Custom Communications	CDN, 2-LINE, 16A	12-Mar-15	12-Mar-16	B.4
CIS049532	H785-150K-50-21378 TTE	High Pass Filter	8-May-15	8-May-16	B.4
CIS020913	FCC-LISN-PA-NEMA-5-15 Fischer Custom Communications	AC Adapter	8-May-15	8-May-16	B.4
CIS007704	FCC-LISN-50/250-50-2-01 Fischer Custom Communications	LISN	8-May-15	8-May-16	B.4
CIS008185	FCC-450B-2.4-N Fischer Custom Communications	Instrumentation Limiter	28-Jul-15	28-Jul-16	B.4
CIS051756	5-T-MB Bird	5W 50 Ohm BNC Termination 4GHz	6-Aug-15	6-Aug-16	B.4
CIS049563	Sucoflex 106A Huber + Suhner	N Type Cable 18GHz	24-Aug-15	24-Aug-16	B.4



CIS021117	UFB311A-0-2484-520520 Micro-Coax	RF Coaxial Cable, to 18GHz, 248.4 in	24-Aug-15	24-Aug-16	B.4
CIS044940	ESU40 Rohde & Schwarz	EMI Test Receiver, 20Hz-40GHz	2-Nov-15	2-Nov-16	B.4
CIS054647	33-605 Stanley	10meter Measuring Tape	Cal not required	Cal not required	B.4
CIS018963	CNE V York	Comparison Noise Emitter, 30 - 1000MHz	Cal not required	Cal not required	B.4

**Test Equipment used for RF Conducted Tests**

<b>Equip No</b>	<b>Model Manufacturer</b>	<b>Description</b>	<b>Last Cal</b>	<b>Next Cal</b>	<b>Test Item</b>
CIS050721	N9030A Keysight	PXA Signal Analyzer	13-Apr-15	13-Apr-16	A1 thru A6
CIS054662	SF18-S1S1-36 MegaPhase	SMA 36" cable	24-Sep-15	24-Sep-16	A1 thru A6
CIS054663	F120-S1S1-48 MegaPhase	SMA 48" Cable	25-Sep-15	25-Sep-16	A1 thru A6
CIS054665	RA08-S1S1-24 MegaPhase	SMA 24" Cable	25-Sep-15	25-Sep-16	A1 thru A6
CIS054666	RA08-S1S1-18 MegaPhase	SMA 18" Cable	25-Sep-15	25-Sep-16	A1 thru A6
CIS054686	NI PXI-2796 National Instruments	Plug-in switch module	6-Oct-15	6-Oct-16	A1 thru A6
CIS055094	PXI-1042 National Instruments	Chassis	Cal Not Required	Cal Not Required	A1 thru A6



## Appendix E: Abbreviation Key and Definitions

The following table defines abbreviations used within this test report.

Abbreviation	Description	Abbreviation	Description
EMC	Electro Magnetic Compatibility	°F	Degrees Fahrenheit
EMI	Electro Magnetic Interference	°C	Degrees Celsius
EUT	Equipment Under Test	Temp	Temperature
ITE	Information Technology Equipment	S/N	Serial Number
TAP	Test Assessment Schedule	Qty	Quantity
ESD	Electro Static Discharge	emf	Electromotive force
EFT	Electric Fast Transient	RMS	Root mean square
EDCS	Engineering Document Control System	Qp	Quasi Peak
Config	Configuration	Av	Average
CIS#	Cisco Number (unique identification number for Cisco test equipment)	Pk	Peak
Cal	Calibration	kHz	Kilohertz ( $1 \times 10^3$ )
EN	European Norm	MHz	MegaHertz ( $1 \times 10^6$ )
IEC	International Electro technical Commission	GHz	Gigahertz ( $1 \times 10^9$ )
CISPR	International Special Committee on Radio Interference	H	Horizontal
CDN	Coupling/Decoupling Network	V	Vertical
LISN	Line Impedance Stabilization Network	dB	decibel
PE	Protective Earth	V	Volt
GND	Ground	kV	Kilovolt ( $1 \times 10^3$ )
L1	Line 1	$\mu$ V	Microvolt ( $1 \times 10^{-6}$ )
L2	Line2	A	Amp
L3	Line 3	$\mu$ A	Micro Amp ( $1 \times 10^{-6}$ )
DC	Direct Current	mS	Milli Second ( $1 \times 10^{-3}$ )
RAW	Uncorrected measurement value, as indicated by the measuring device	$\mu$ S	Micro Second ( $1 \times 10^{-6}$ )
RF	Radio Frequency	$\mu$ S	Micro Second ( $1 \times 10^{-6}$ )
SLCE	Signal Line Conducted Emissions	m	Meter
Meas dist	Measurement distance	Spec dist	Specification distance
N/A or NA	Not Applicable	SL	Signal Line (or Telecom Line)
P	Power Line	L	Live Line
N	Neutral Line	R	Return
S	Supply	AC	Alternating Current



**End**