

Test Report

AIR-AP1572xxx-B-K9

(Where x = model options not effecting the radio module)

FCC ID: LDK102093P

5725-5850 MHz

Against the following Specifications:

CFR47 Part 15.407

Antenna Gain = 4dBi

Cisco Systems

170 West Tasman Drive

San Jose, CA 95134

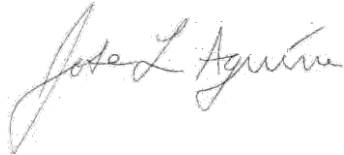
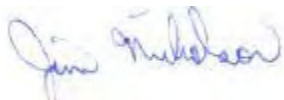
| | |
|---|---|
|  |  |
| Author: Jose Aguirre Tested By | Approved By: Jim Nicolson Title: Technical Leader, Engineering Revision: 3 |

This report replaces any previously entered test report under EDCS – **1435254**. This test report has been electronically authorized and archived using the CISCO Engineering Document Control system.

This test report has been electronically authorized and archived using the CISCO Engineering Document Control system.

| | |
|---|-----------|
| SECTION 1: OVERVIEW | 3 |
| SECTION 2: ASSESSMENT INFORMATION | 4 |
| 2.1 GENERAL | 4 |
| 2.2 DATE OF TESTING..... | 6 |
| 2.3 REPORT ISSUE DATE | 6 |
| 2.4 TESTING FACILITIES | 6 |
| 2.5 EQUIPMENT ASSESSED (EUT)..... | 6 |
| 2.6 EUT DESCRIPTION..... | 7 |
| SECTION 3: RESULT SUMMARY..... | 10 |
| 3.1 RESULTS SUMMARY TABLE | 10 |
| SECTION 4: SAMPLE DETAILS..... | 11 |
| APPENDIX A: EMISSION TEST RESULTS | 12 |
| CONDUCTED TEST SETUP DIAGRAM..... | 12 |
| TARGET MAXIMUM CHANNEL POWER | 12 |
| A.1 6dB BANDWIDTH | 13 |
| A.2 99% AND 26dB BANDWIDTH..... | 21 |
| A.3 MAXIMUM CONDUCTED OUTPUT POWER..... | 29 |
| A.4 POWER SPECTRAL DENSITY | 36 |
| A.5 CONDUCTED SPURIOUS EMISSIONS | 42 |
| A.6 CONDUCTED BANDEDGE | 55 |
| APPENDIX B: EMISSION TEST RESULTS..... | 63 |
| RADIATED EMISSION SETUP DIAGRAM-BELOW 1G | 63 |
| RADIATED EMISSION SETUP DIAGRAM-ABOVE 1G | 63 |
| B.1 RADIATED SPURIOUS EMISSIONS..... | 64 |
| B.2 RADIATED EMISSIONS 30MHZ TO 1GHZ..... | 75 |
| B.3 AC CONDUCTED EMISSIONS..... | 77 |
| APPENDIX C: LIST OF TEST EQUIPMENT USED TO PERFORM THE TEST..... | 82 |
| APPENDIX E: ABBREVIATION KEY AND DEFINITIONS | 83 |

Section 1: Overview

The samples were assessed against the tests detailed in section 3 under the requirements of the following specifications:

| |
|------------------------|
| Specifications: |
| CFR47 Part 15.407 |

Measurements were made in accordance with

- ANSI C63.10:2013
- KDB 789033 D02 General UNII Test Procedures New Rules v01
- KDB 662911 D01 Multiple Transmitter Output

Section 2: Assessment Information

2.1 General

This report contains an assessment of an apparatus against Electromagnetic Compatibility Standards based upon tests carried out on the samples submitted. The testing was performed by and for the use of Cisco systems Inc:

With regard to this assessment, the following points should be noted:

- a) The results contained in this report relate only to the items tested and were obtained in the period between the date of the initial assessment and the date of issue of the report. Manufactured products will not necessarily give identical results due to production and measurement tolerances.
- b) The apparatus was set up and exercised using the configuration and modes of operation defined in this report only.
- c) Where relevant, the apparatus was only assessed using the susceptibility criteria defined in this report and the Test Assessment Plan (TAP).
- d) All testing was performed under the following environmental conditions:

| | |
|----------------------|--------------------------------------|
| Temperature | 15°C to 35°C (54°F to 95°F) |
| Atmospheric Pressure | 860mbar to 1060mbar (25.4" to 31.3") |
| Humidity | 10% to 75*% |
- e) All AC testing was performed at one or more of the following supply voltages:
110V 60 Hz (+/-20%)

Units of Measurement

The units of measurements defined in the appendices are reported in specific terms, which are test dependent. Where radiated measurements are concerned these are defined at a particular distance. Basic voltage measurements are defined in units of [dBuV]

As an example, the basic calculation for all measurements is as follows:

$$\text{Emission level [dBuV]} = \text{Indicated voltage level [dBuV]} + \text{Cable Loss [dB]} + \text{Other correction factors [dB]}$$

The combinations of correction factors are dependent upon the exact test configurations [see test equipment lists for further details] and may include:-

Antenna Factors, Pre Amplifier Gain, LISN Loss, Pulse Limiter Loss and Filter Insertion Loss

Note: to convert the results from dBuV/m to uV/m use the following formula:-

$$\text{Level in uV/m} = \text{Common Antilogarithm} [(X \text{ dBuV/m})/20] = Y \text{ uV/m}$$

Measurement Uncertainty Values

| | |
|-----------------------------------|------------------------|
| voltage and power measurements | ± 2 dB |
| conducted EIRP measurements | ± 1.4 dB |
| radiated measurements | ± 3.2 dB |
| frequency measurements | ± 2.4 10 ⁻⁷ |
| temperature measurements | ± 0.54° |
| humidity measurements | ± 2.3% |
| DC and low frequency measurements | ± 2.5% |

Where relevant measurement uncertainty levels have been estimated for tests performed on the apparatus. This uncertainty represents an expanded uncertainty expressed at approximately the 95% confidence level using a coverage factor of k=2.

Radiated emissions (expanded uncertainty, confidence interval 95%)

| | |
|--------------------|------------|
| 30 MHz - 300 MHz | +/- 3.8 dB |
| 300 MHz - 1000 MHz | +/- 4.3 dB |
| 1 GHz - 10 GHz | +/- 4.0 dB |
| 10 GHz - 18GHz | +/- 8.2 dB |
| 18GHz - 26.5GHz | +/- 4.1 dB |
| 26.5GHz - 40GHz | +/- 3.9 dB |

Conducted emissions (expanded uncertainty, confidence interval 95%)

| | |
|----------------|-------------|
| 30 MHz – 40GHz | +/- 0.38 dB |
|----------------|-------------|

A product is considered to comply with a requirement if the nominal measured value is below the limit line. The product is considered to not be in compliance in case the nominal measured value is above the limit line.

This report must not be reproduced except in full, without written approval of Cisco Systems.

2.2 Date of testing

25-Aug-15 - 11-Nov-15

2.3 Report Issue Date

16-November-2015

Cisco uses an electronic system to issue, store and control the revision of test reports. This system is called the Engineering Document Control System (EDCS). The actual report issue date is embedded into the original file on EDCS. Any copies of this report, either electronic or paper, that are not on EDCS must be considered uncontrolled.

2.4 Testing facilities

This assessment was performed by:

Testing Laboratory

Cisco Systems, Inc.,
125 West Tasman Drive
San Jose, CA 95134, USA

Registration Numbers for Industry Canada

| Cisco System Site | Address | Site Identifier |
|--------------------------|---|------------------------|
| Building P, 10m Chamber | 125 West Tasman Dr San Jose, CA 95134 | Company #: 2461N-2 |
| Building P, 5m Chamber | 125 West Tasman Dr San Jose, CA 95134 | Company #: 2461N-1 |
| Building I, 5m Chamber | 285 W. Tasman Drive San Jose, California 95134 | Company #: 2461M-1 |

Test Engineers

Jose Aguirre

2.5 Equipment Assessed (EUT)

AIR-AP1572EAC-B-K9

2.6 EUT Description

The AIR-AP1572EAC-B-K9

Cisco Aironet 802.11ac Radio supports the following modes of operation. The modes are further defined in the radio Theory of Operation. The modes included in this report represent the worst case data for all modes.

802.11n/ac - Non HT/VHT20, One Antenna, 6 to 54 Mbps
802.11n/ac - Non HT/VHT20, Two Antennas, 6 to 54 Mbps
802.11n/ac - Non HT/VHT20, Three Antennas, 6 to 54 Mbps
802.11n/ac - Non HT/VHT20, Four Antennas, 6 to 54 Mbps

802.11n/ac - Non HT/VHT20 Beam Forming, Two Antennas, 6 to 54 Mbps
802.11n/ac - Non HT/VHT20 Beam Forming, Three Antennas, 6 to 54 Mbps
802.11n/ac - Non HT/VHT20 Beam Forming, Four Antennas, 6 to 54 Mbps

802.11n/ac - HT/VHT20, One Antenna, M0 to M7, M0 to M9 1ss
802.11n/ac - HT/VHT20, Two Antennas, M0 to M7, M0 to M9 1ss
802.11n/ac - HT/VHT20, Two Antennas, M8 to M15, M0 to M9 2ss
802.11n/ac - HT/VHT20, Three Antennas, M0 to M7, M0 to M9 1ss
802.11n/ac - HT/VHT20, Three Antennas, M8 to M15, M0 to M9 2ss
802.11n/ac - HT/VHT20, Three Antennas, M16 to M23, M0 to M9 3ss
802.11n/ac - HT/VHT20, Four Antennas, M0 to M7, M0 to M9 1ss
802.11n/ac - HT/VHT20, Four Antennas, M8 to M15, M0 to M9 2ss
802.11n/ac - HT/VHT20, Four Antennas, M16 to M23, M0 to M9 3ss

802.11n/ac - HT/VHT20 Beam Forming, Two Antennas, M0 to M7, M0 to M9 1ss
802.11n/ac - HT/VHT20 Beam Forming, Two Antennas, M8 to M15, M0 to M9 2ss
802.11n/ac - HT/VHT20 Beam Forming, Three Antennas, M0 to M7, M0 to M9 1ss
802.11n/ac - HT/VHT20 Beam Forming, Three Antennas, M8 to M15, M0 to M9 2ss
802.11n/ac - HT/VHT20 Beam Forming, Three Antennas, M16 to M23, M0 to M9 3ss
802.11n/ac - HT/VHT20 Beam Forming, Four Antennas, M0 to M7, M0 to M9 1ss
802.11n/ac - HT/VHT20 Beam Forming, Four Antennas, M8 to M15, M0 to M9 2ss
802.11n/ac - HT/VHT20 Beam Forming, Four Antennas, M16 to M23, M0 to M9 3ss

802.11n/ac - HT/VHT20 STBC, Two Antennas, M0 to M7, M0 to M9 1ss
802.11n/ac - HT/VHT20 STBC, Three Antennas, M0 to M7, M0 to M9 1ss
802.11n/ac - HT/VHT20 STBC, Four Antennas, M0 to M7, M0 to M9 1ss

802.11n/ac - Non HT/VHT40 Duplicate, One Antenna, 6 to 54 Mbps
802.11n/ac - Non HT/VHT40 Duplicate, Two Antennas, 6 to 54 Mbps
802.11n/ac - Non HT/VHT40 Duplicate, Three Antennas, 6 to 54 Mbps
802.11n/ac - Non HT/VHT40 Duplicate, Four Antennas, 6 to 54 Mbps

802.11n/ac - HT/VHT40, One Antenna, M0 to M7, M0 to M9 1ss
802.11n/ac - HT/VHT40, Two Antennas, M0 to M7, M0 to M9 1ss
802.11n/ac - HT/VHT40, Two Antennas, M8 to M15, M0 to M9 2ss
802.11n/ac - HT/VHT40, Three Antennas, M0 to M7, M0 to M9 1ss
802.11n/ac - HT/VHT40, Three Antennas, M8 to M15, M0 to M9 2ss
802.11n/ac - HT/VHT40, Three Antennas, M16 to M23, M0 to M9 3ss
802.11n/ac - HT/VHT40, Four Antennas, M0 to M7, M0 to M9 1ss
802.11n/ac - HT/VHT40, Four Antennas, M8 to M15, M0 to M9 2ss
802.11n/ac - HT/VHT40, Four Antennas, M16 to M23, M0 to M9 3ss

802.11n/ac - HT/VHT40 Beam Forming, Two Antennas, M0 to M7, M0 to M9 1ss
 802.11n/ac - HT/VHT40 Beam Forming, Two Antennas, M8 to M15, M0 to M9 2ss
 802.11n/ac - HT/VHT40 Beam Forming, Three Antennas, M0 to M7, M0 to M9 1ss
 802.11n/ac - HT/VHT40 Beam Forming, Three Antennas, M8 to M15, M0 to M9 2ss
 802.11n/ac - HT/VHT40 Beam Forming, Three Antennas, M16 to M23, M0 to M9 3ss
 802.11n/ac - HT/VHT40 Beam Forming, Four Antennas, M0 to M7, M0 to M9 1ss
 802.11n/ac - HT/VHT40 Beam Forming, Four Antennas, M8 to M15, M0 to M9 2ss
 802.11n/ac - HT/VHT40 Beam Forming, Four Antennas, M16 to M23, M0 to M9 3ss

802.11n/ac - HT/VHT40 STBC, Two Antennas, M0 to M7, M0 to M9 1ss
 802.11n/ac - HT/VHT40 STBC, Three Antennas, M0 to M7, M0 to M9 1ss
 802.11n/ac - HT/VHT40 STBC, Four Antennas, M0 to M7, M0 to M9 1ss

802.11n/ac - Non HT/VHT80 Duplicate, One Antenna, 6 to 54 Mbps
 802.11n/ac - Non HT/VHT80 Duplicate, Two Antennas, 6 to 54 Mbps
 802.11n/ac - Non HT/VHT80 Duplicate, Three Antennas, 6 to 54 Mbps
 802.11n/ac - Non HT/VHT80 Duplicate, Four Antennas, 6 to 54 Mbps

802.11n/ac - HT/VHT80, One Antenna, M0 to M7, M0 to M9 1ss
 802.11n/ac - HT/VHT80, Two Antennas, M0 to M7, M0 to M9 1ss
 802.11n/ac - HT/VHT80, Two Antennas, M8 to M15, M0 to M9 2ss
 802.11n/ac - HT/VHT80, Three Antennas, M0 to M7, M0 to M9 1ss
 802.11n/ac - HT/VHT80, Three Antennas, M8 to M15, M0 to M9 2ss
 802.11n/ac - HT/VHT80, Three Antennas, M16 to M23, M0 to M9 3ss
 802.11n/ac - HT/VHT80, Four Antennas, M0 to M7, M0 to M9 1ss
 802.11n/ac - HT/VHT80, Four Antennas, M8 to M15, M0 to M9 2ss
 802.11n/ac - HT/VHT80, Four Antennas, M16 to M23, M0 to M9 3ss

802.11n/ac - HT/VHT80 Beam Forming, Two Antennas, M0 to M7, M0 to M9 1ss
 802.11n/ac - HT/VHT80 Beam Forming, Two Antennas, M8 to M15, M0 to M9 2ss
 802.11n/ac - HT/VHT80 Beam Forming, Three Antennas, M0 to M7, M0 to M9 1ss
 802.11n/ac - HT/VHT80 Beam Forming, Three Antennas, M8 to M15, M0 to M9 2ss
 802.11n/ac - HT/VHT80 Beam Forming, Three Antennas, M16 to M23, M0 to M9 3ss
 802.11n/ac - HT/VHT80 Beam Forming, Four Antennas, M0 to M7, M0 to M9 1ss
 802.11n/ac - HT/VHT80 Beam Forming, Four Antennas, M8 to M15, M0 to M9 2ss
 802.11n/ac - HT/VHT80 Beam Forming, Four Antennas, M16 to M23, M0 to M9 3ss

802.11n/ac - HT/VHT80 STBC, Two Antennas, M0 to M7, M0 to M9 1ss
 802.11n/ac - HT/VHT80 STBC, Three Antennas, M0 to M7, M0 to M9 1ss
 802.11n/ac - HT/VHT80 STBC, Four Antennas, M0 to M7, M0 to M9 1ss

The following antennas are supported by this product series.

The data included in this report represent the worst case data for all antennas.

| Frequency | Part Number | Antenna Type | Antenna Gain (dBi) | >30 degree 5 GHz Antenna Gain (dBi) | Comment |
|------------------|-------------------|-----------------------|--------------------|-------------------------------------|--------------------------|
| 5 GHz | AIR-ANT5140V-N | 5GHZ Omni | 4 | -2 | |
| | AIR-ANT5180V-N | 5GHZ Omni | 8 | -3 | |
| | AIR-ANT5114P-N | 5GHz Patch | 14 | -4 | |
| | AIR-ANT5114P2M-N | Patch, dual polarized | 14 | 5 | |
| Dual Band | AIR-ANT2547V(G)-N | Dual Band Omni | 4/7 | -6 | |
| | AIR-ANT2568V(G)-N | Dual Band Omni | 6/8 | 3 | (G) indicates gray color |

| | | | | | |
|--|------------------|--|-------|----|--------------------------|
| | AIR-ANT2513P4M-N | Dual-Band Polarization Diverse Patch Array | 13/13 | -5 | (G) indicates gray color |
| | AIR-ANT2588P3M-N | Dual Band 3 element DIRECTIONAL | 8/8 | 1 | |
| | Internal | Omni | 4/6 | -1 | |

Section 3: Result Summary

3.1 Results Summary Table

Conducted emissions

| Basic Standard | Technical Requirements / Details | Result |
|--|--|--------|
| FCC 15.407 | 6dB Bandwidth: Systems using digital modulation techniques may operate in the 2400-2483.5MHz band. The minimum 6dB bandwidth shall be at least 500 kHz. | Pass |
| FCC 15.407 | 99% & 26 dB Bandwidth: The 99% occupied bandwidth is the frequency bandwidth such that, below its lower and above its upper frequency limits, the mean powers are each equal to 0.5% of the total mean power of the given emission. There is no limit for 99% OBW. The 26 dB emission is the width of the emission that is constrained by the frequencies associated with the two outermost amplitude points (upper and lower frequencies) that are attenuated by 26 dB relative to the maximum level measured in the fundamental emission. | Pass |
| FCC 15.407 | Output Power: For the band 5.725-5.85 GHz, the maximum conducted output power over the frequency band of operation shall not exceed 1 W. | Pass |
| FCC 15.407 | Power Spectral Density: 15.407 The maximum power spectral density shall not exceed 30 dBm in any 500-kHz band. | Pass |
| FCC 15.407 | Conducted Spurious Emissions / Band-Edge: For transmitters operating in the 5.725-5.85 GHz band: All emissions within the frequency range from the band edge to 10 MHz above or below the band edge shall not exceed an e.i.r.p. of -17 dBm/MHz; for frequencies 10 MHz or greater above or below the band edge, emissions shall not exceed an e.i.r.p. of -27 dBm/MHz. | Pass |
| FCC 15.407 FCC 15.209 FCC 152.05 | Restricted band: Unwanted emissions falling within the restricted bands, as defined in FCC 15.205 (a) must also comply with the radiated emission limits specified in FCC 15.209 (a). | Pass |

Radiated Emissions (General requirements)

| Basic Standard | Technical Requirements / Details | Result |
|--|--|--------|
| FCC 15.407 FCC 15.209 FCC 15.205 | TX Spurious Emissions: Except as provided elsewhere in this subpart, the emissions from an intentional radiator shall not exceed the field strength levels specified in the filed strength limits table in this section. | Pass |
| FCC 15.207 | AC conducted Emissions: Except when the requirements applicable to a given device state otherwise, for any radio apparatus equipped to operate from the public utility AC power supply, either directly or indirectly (such as with a battery charger), the radio frequency voltage of emissions conducted back onto the AC power lines in the frequency range of 0.15 MHz to 30 MHz shall not exceed the limits shown in the table in these sections. The more stringent limit applies at the frequency range boundaries. | Pass |

* MPE calculation is recorded in a separate report

Section 4: Sample Details

Note: Each sample was evaluated to ensure that its condition was suitable to be used as a test sample prior to the commencement of testing.

4.1 Sample Details

| Sample No. | Equipment Details | Manufacturer | Hardware Rev. | Firmware Rev. | Software Rev. | Serial Number |
|------------|--------------------|---------------|---------------|---------------|---------------|---------------|
| S01 | AIR-AP1572EAC-B-K9 | Cisco Systems | V01 | AP3G2-K9W7-M | IOS 15.3 | FTX1912P048 |

4.2 System Details

| System # | Description | Samples |
|----------|-------------|---------|
| 1 | EUT | S01 |

4.3 Mode of Operation Details

| Mode# | Description | Comments |
|-------|-------------------------|---|
| 1 | Continuous Transmitting | Continuous Transmitting duty cycle >98% |

Measurements were made in accordance with

- ANSI C63.10:2013,
- KDB 789033 D02 General UNII Test Procedures New Rules v01
- KDB 662911 D01 Multiple Transmitter Output

Appendix A: Emission Test Results

Conducted Test Setup Diagram

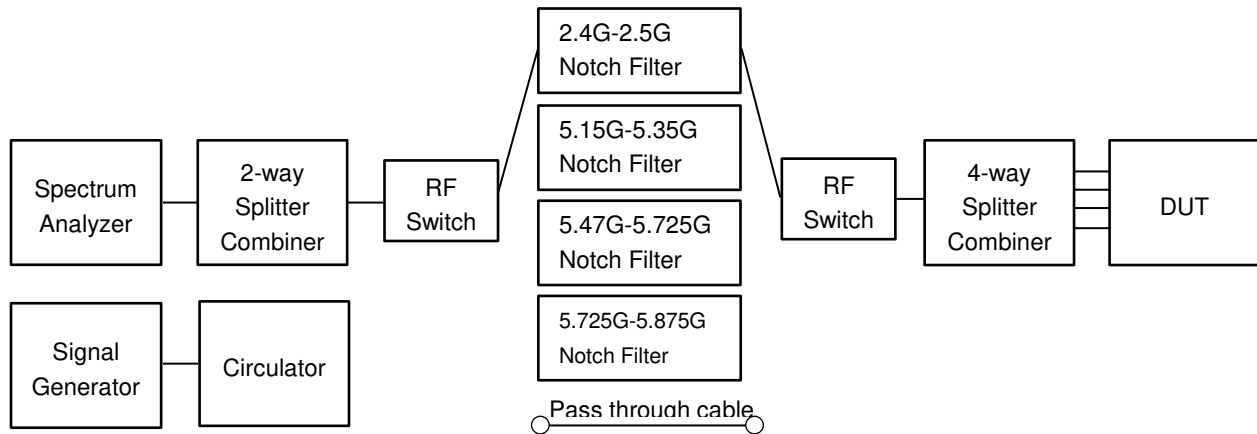

Target Maximum Channel Power

The following table details the maximum supported Total Channel Power for all operating modes.

| Operating Mode | Maximum Channel Power (dBm) | | |
|--|-----------------------------|------|------|
| | Frequency (MHz) | | |
| | 5745 | 5785 | 5825 |
| Non HT/VHT20, 6 to 54 Mbps | 25 | 29 | 24 |
| Non HT/VHT20 Beam Forming, 6 to 54 Mbps | 22 | 26 | 21 |
| HT/VHT20, M0 to M23, M0 to M9 1-3ss | 24 | 29 | 24 |
| HT/VHT20 Beam Forming, M0 to M23, M0 to M9 1-3ss | 23 | 28 | 24 |
| HT/VHT20 STBC, M0 to M7, M0 to M9 1-1ss | 24 | 29 | 24 |
| | 5755 | 5795 | |
| Non HT/VHT40, 6 to 54 Mbps | 21 | 22 | |
| HT/VHT40, M0 to M23, M0 to M9 1-3ss | 21 | 24 | |
| HT/VHT40 Beam Forming, M0 to M23, M0 to M9 1-3ss | 21 | 24 | |
| HT/VHT40 STBC, M0 to M7, M0 to M9 1-1ss | 21 | 24 | |
| | 5775 | | |
| Non HT/VHT80, 6 to 54 Mbps | 17 | | |
| HT/VHT80, M0 to M23, M0 to M9 1-3ss | 18 | | |
| HT/VHT80 Beam Forming, M0 to M23, M0 to M9 1-3ss | 18 | | |
| HT/VHT80 STBC, M0 to M7, M0 to M9 1-1ss | 18 | | |

A.1 6dB Bandwidth

15.407 Within the 5.725-5.85 GHz band, the minimum 6 dB bandwidth of U-NII devices shall be at least 500 kHz.

Test Procedure

Ref. KDB 789033 D02 General UNII Test Procedures New Rules v01
ANSI C63.10: 2013

6 BW

Test Procedure

1. Set the radio in the continuous transmitting mode.
2. Allow the trace to stabilize.
3. Setting the x-dB bandwidth mode to -6dB within the measurement set up function.
4. Select the automatic OBW measurement function of an instrument to perform bandwidth measurement.
5. Capture graphs and record pertinent measurement data.

Ref. KDB 789033 D02 General UNII Test Procedures New Rules v01
ANSI C63.10: 2013 section 11.8.2 Option 2

6 BW

Test parameters

X dB BW = 6dB (using the OBW function of the spectrum analyzer)
Span = Large enough to capture the entire EBW
RBW = 100 KHz
VBW \geq 3 x RBW
Sweep = Auto couple
Detector = Peak or where practical sample shall be used
Trace = Max. Hold

| System Number | Description | Samples | System under test | Support equipment |
|---------------|-------------|---------|-------------------------------------|-------------------------------------|
| 1 | EUT | S01 | <input checked="" type="checkbox"/> | <input type="checkbox"/> |
| | Support | S02 | <input type="checkbox"/> | <input checked="" type="checkbox"/> |

Tested By :

Jose Aguirre

Date of testing:

10-Oct-15 - 11-Nov-15

Test Result : PASS

See Appendix C for list of test equipment

| Frequency (MHz) | Mode | Data Rate (Mbps) | 6dB BW (MHz) | Limit (kHz) | Margin (MHz) |
|-----------------|-------------------------------------|------------------|--------------|-------------|--------------|
| 5745 | Non HT/VHT20, 6 to 54 Mbps | 6 | 16.4 | >500 | 15.9 |
| | HT/VHT20, M0 to M23, M0 to M9 1-3ss | m0 | 17.3 | >500 | 16.8 |
| 5755 | Non HT/VHT40, 6 to 54 Mbps | 6 | 35.6 | >500 | 35.1 |
| | HT/VHT40, M0 to M23, M0 to M9 1-3ss | m0 | 35.3 | >500 | 34.8 |
| 5775 | Non HT/VHT80, 6 to 54 Mbps | 6 | 76.4 | >500 | 75.9 |
| | HT/VHT80, M0 to M23, M0 to M9 1-3ss | m0x1 | 76.3 | >500 | 75.8 |
| 5785 | Non HT/VHT20, 6 to 54 Mbps | 6 | 16.4 | >500 | 15.9 |
| | HT/VHT20, M0 to M23, M0 to M9 1-3ss | m0 | 17.1 | >500 | 16.6 |
| 5795 | Non HT/VHT40, 6 to 54 Mbps | 6 | 35.6 | >500 | 35.1 |
| | HT/VHT40, M0 to M23, M0 to M9 1-3ss | m0 | 35.3 | >500 | 34.8 |
| 5825 | Non HT/VHT20, 6 to 54 Mbps | 6 | 16.4 | >500 | 15.9 |
| | HT/VHT20, M0 to M23, M0 to M9 1-3ss | m0 | 17.1 | >500 | 16.6 |

6dB Bandwidth, 5745 MHz, Non HT/VHT20, 6 to 54 Mbps

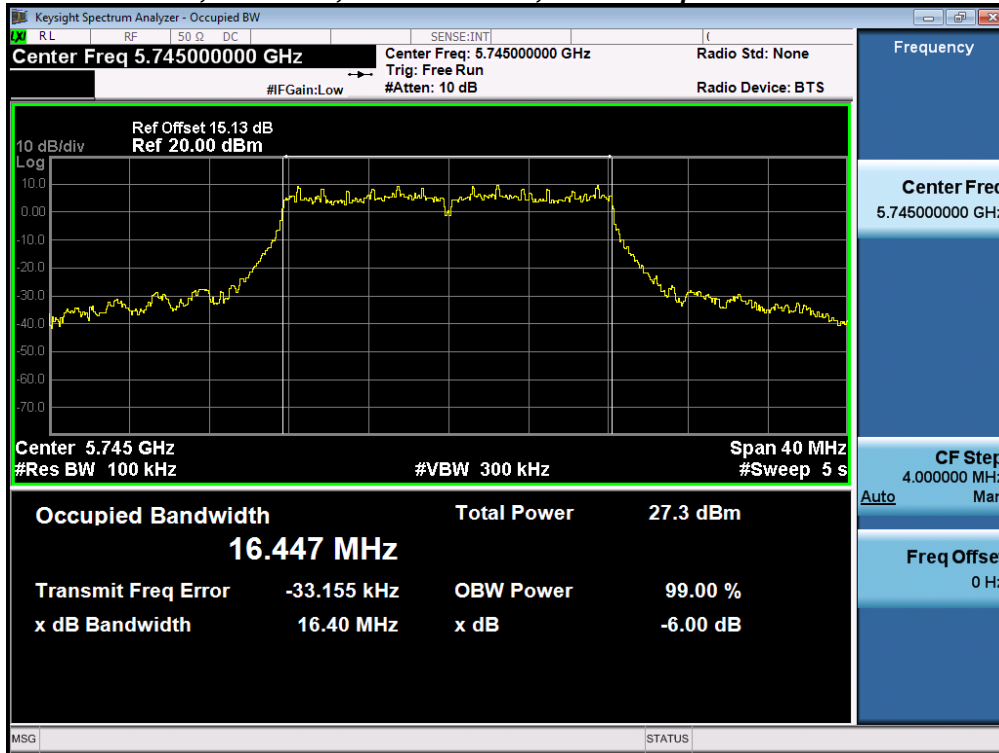

6dB Bandwidth, 5745 MHz, HT/VHT20, M0 to M23, M0 to M9 1-3ss

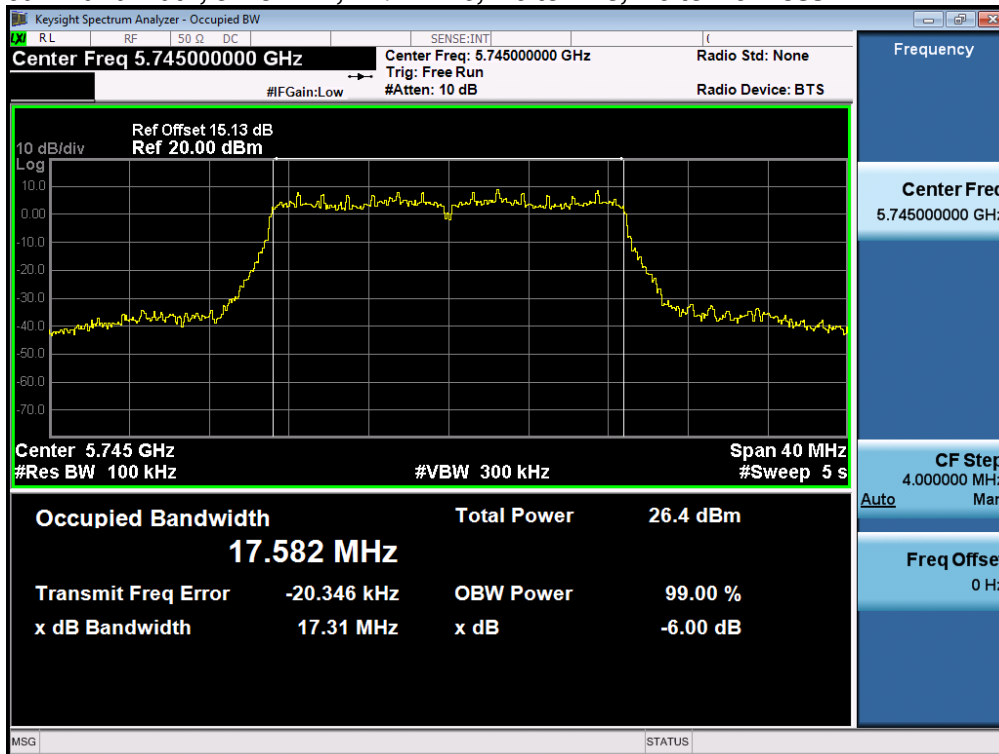

6dB Bandwidth, 5755 MHz, Non HT/VHT40, 6 to 54 Mbps

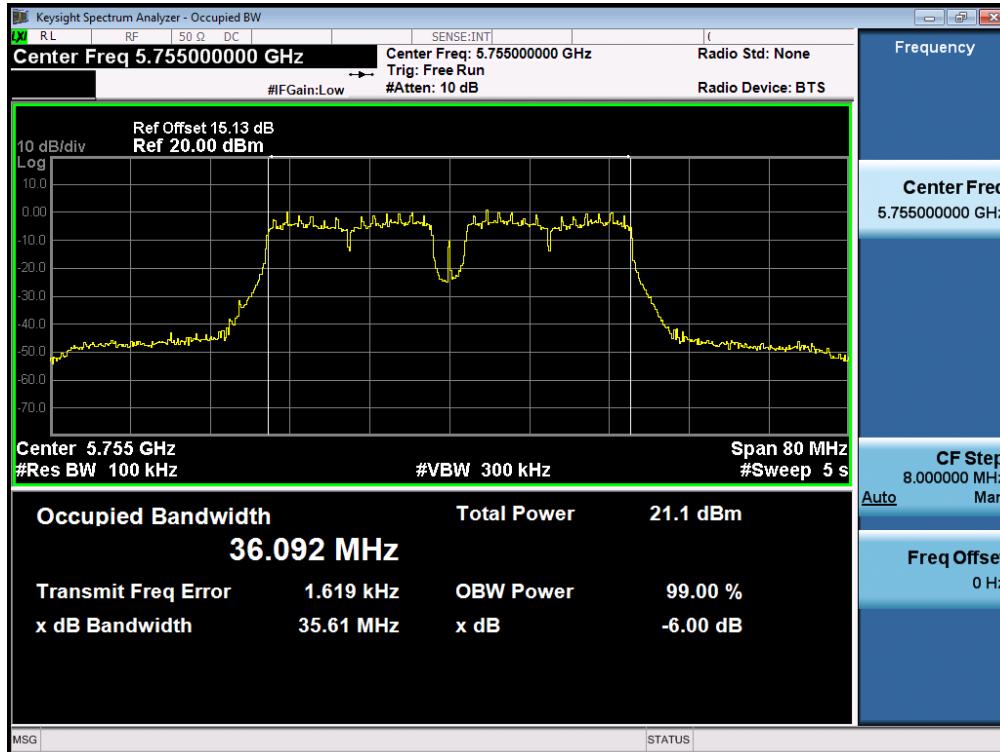

6dB Bandwidth, 5755 MHz, HT/VHT40, M0 to M23, M0 to M9 1-3ss

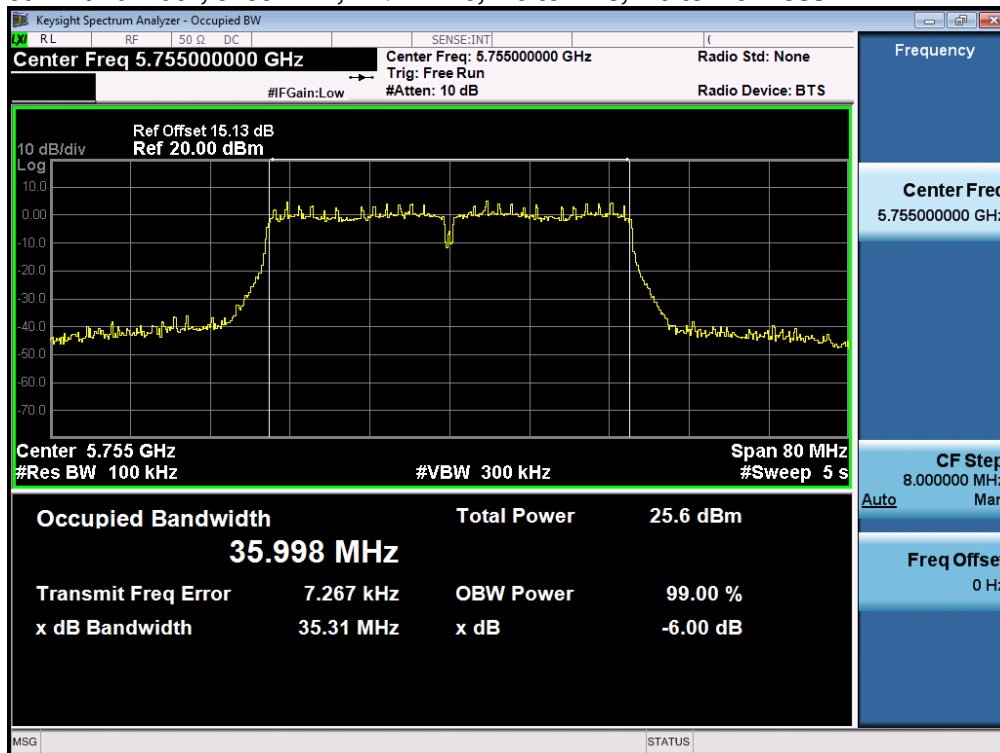

6dB Bandwidth, 5775 MHz, Non HT/VHT80, 6 to 54 Mbps

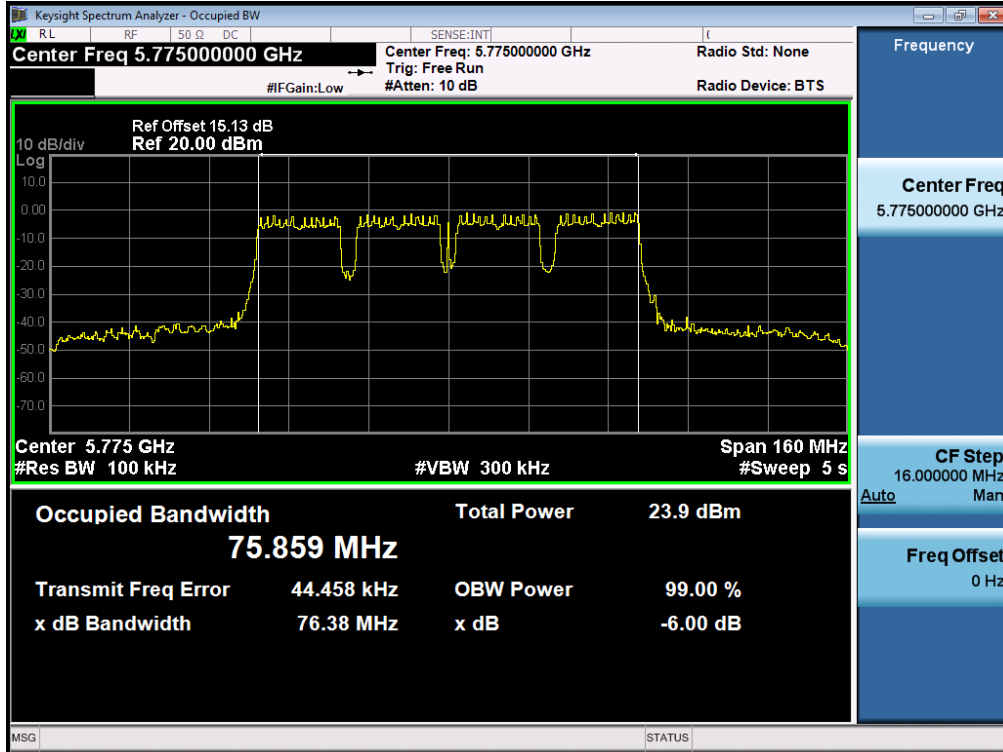

6dB Bandwidth, 5775 MHz, HT/VHT80, M0 to M23, M0 to M9 1-3ss

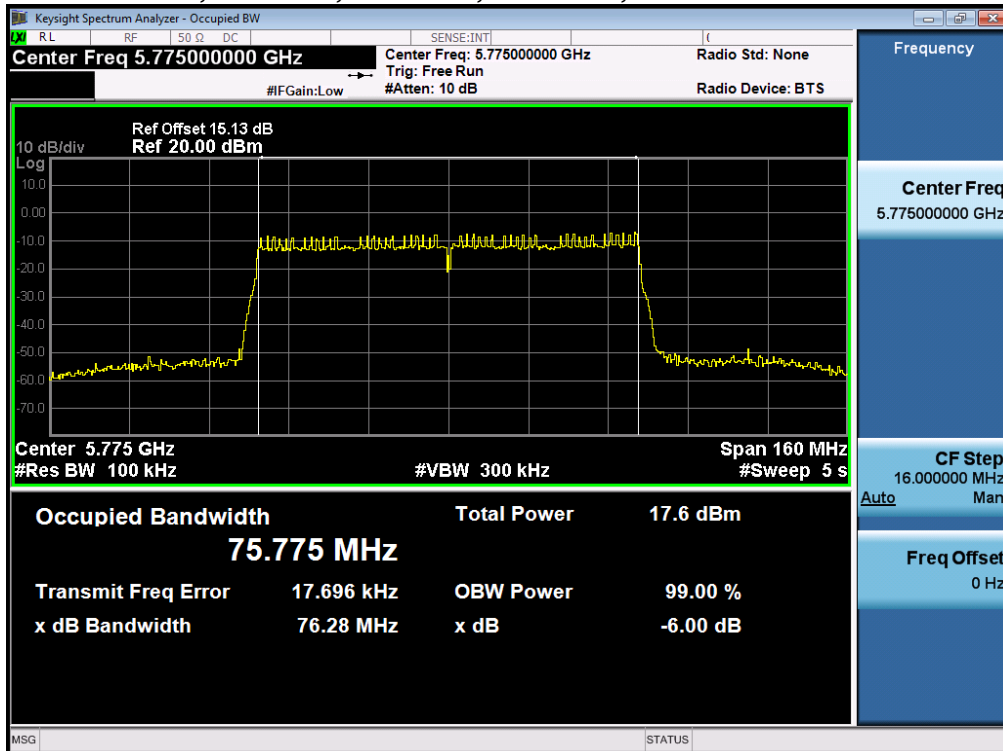

6dB Bandwidth, 5785 MHz, Non HT/VHT20, 6 to 54 Mbps

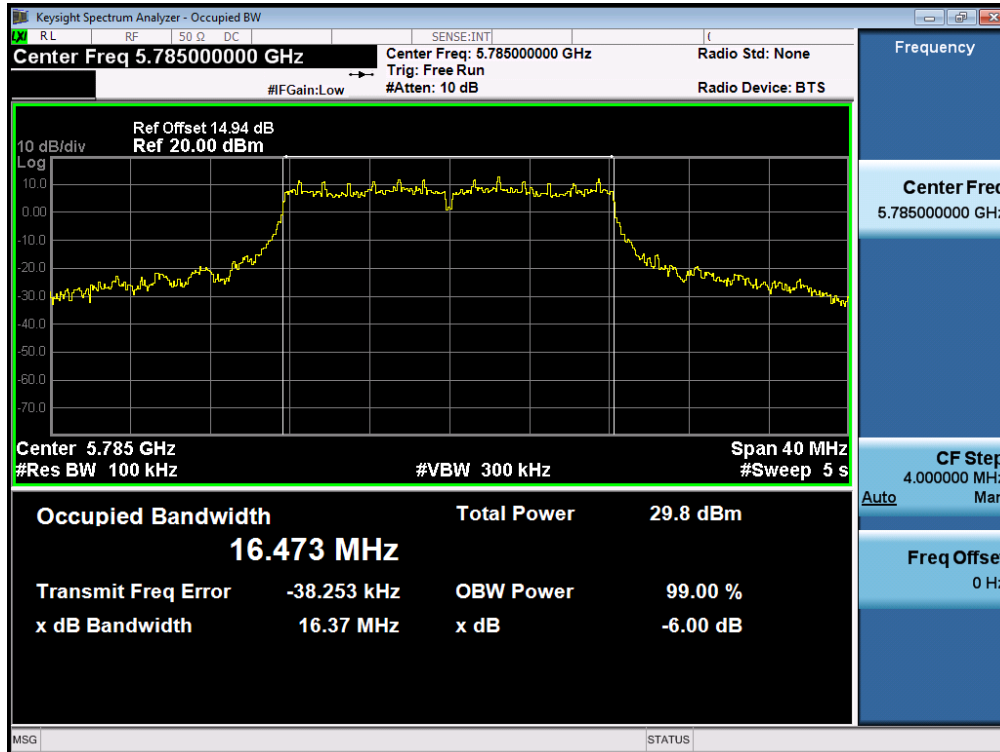

6dB Bandwidth, 5785 MHz, HT/VHT20, M0 to M23, M0 to M9 1-3ss

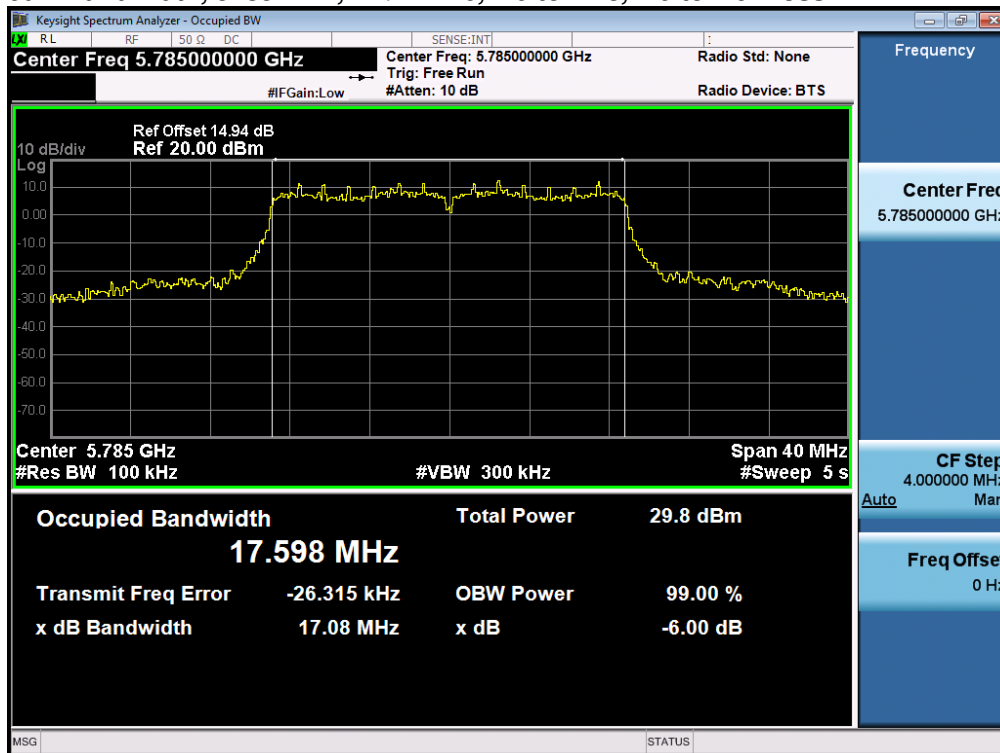

6dB Bandwidth, 5795 MHz, Non HT/VHT40, 6 to 54 Mbps

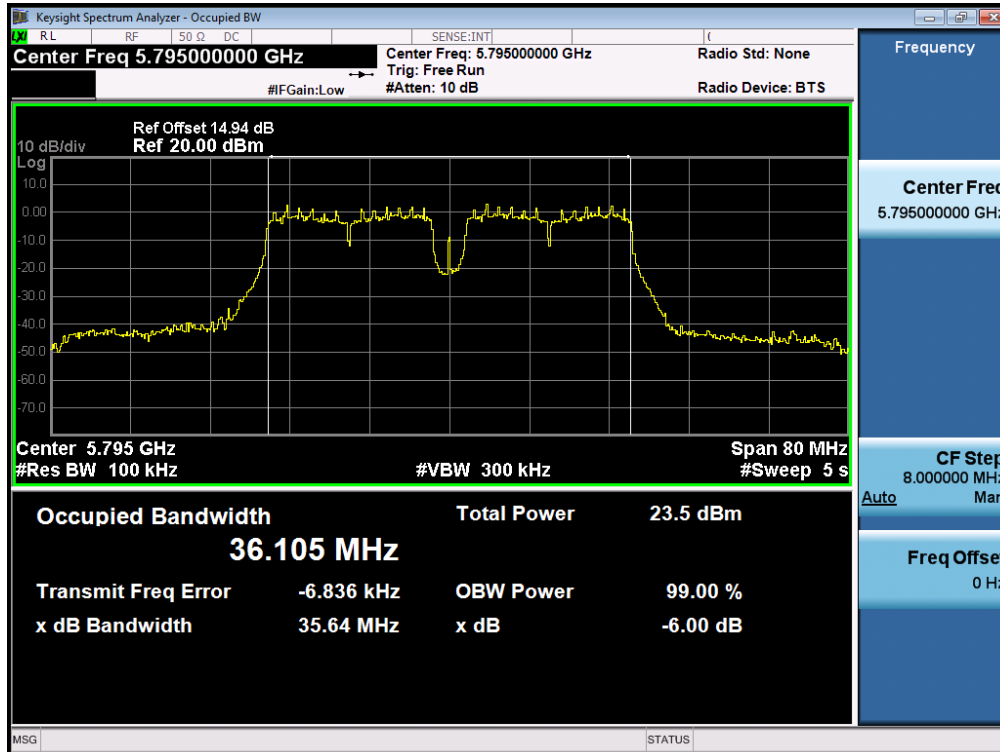

6dB Bandwidth, 5795 MHz, HT/VHT40, M0 to M23, M0 to M9 1-3ss

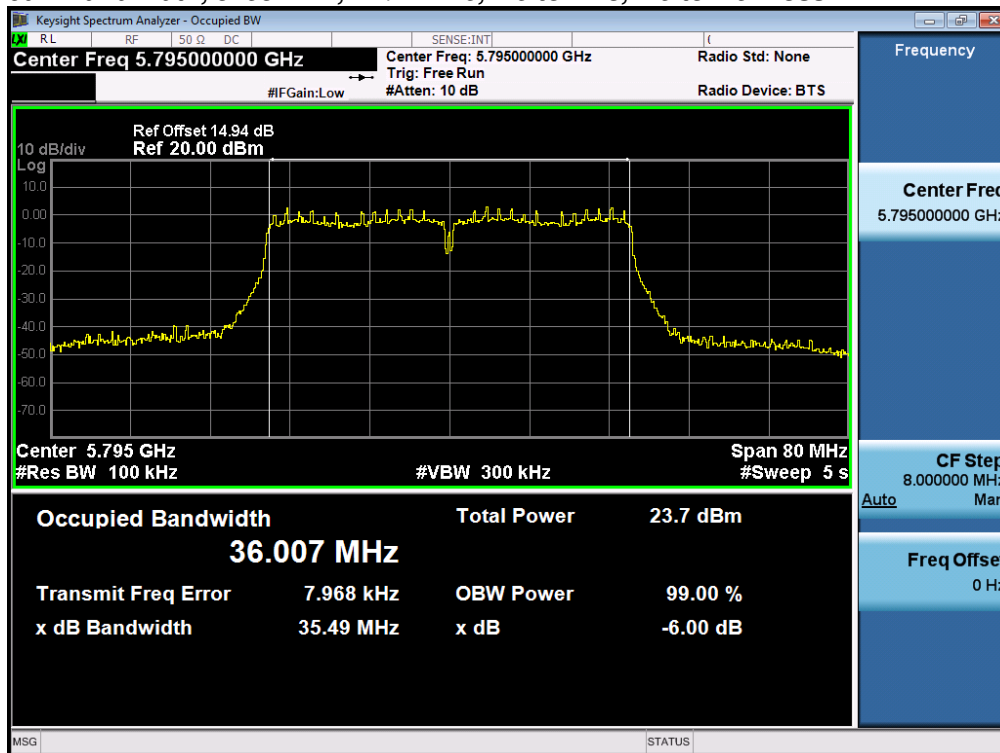

6dB Bandwidth, 5825 MHz, Non HT/VHT20, 6 to 54 Mbps

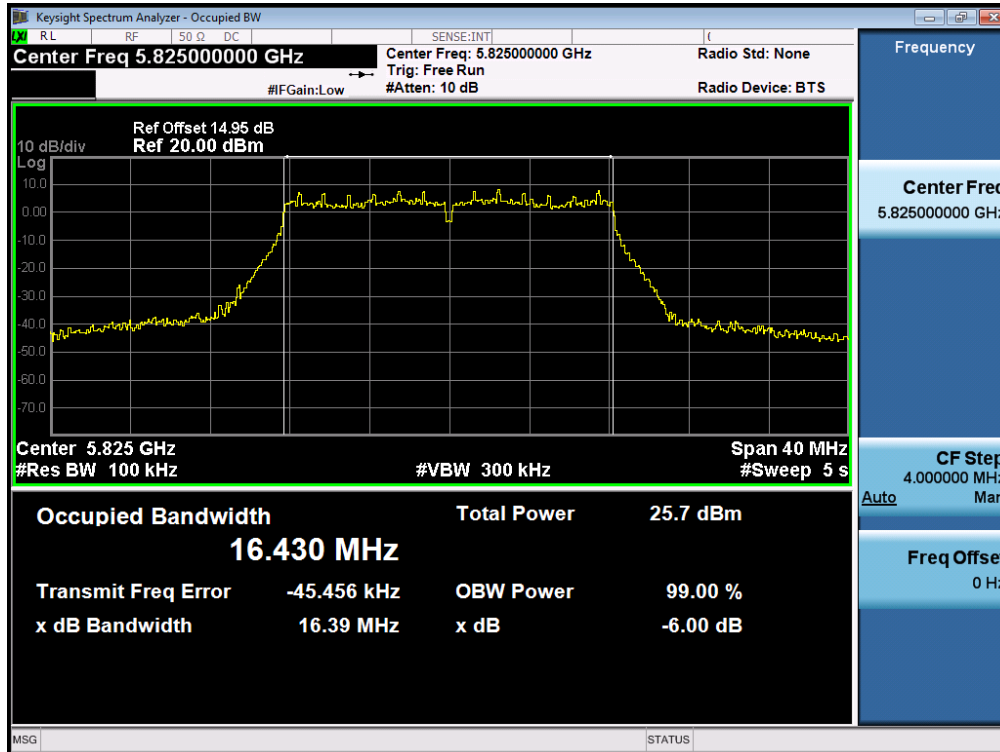

6dB Bandwidth, 5825 MHz, HT/VHT20, M0 to M23, M0 to M9 1-3ss

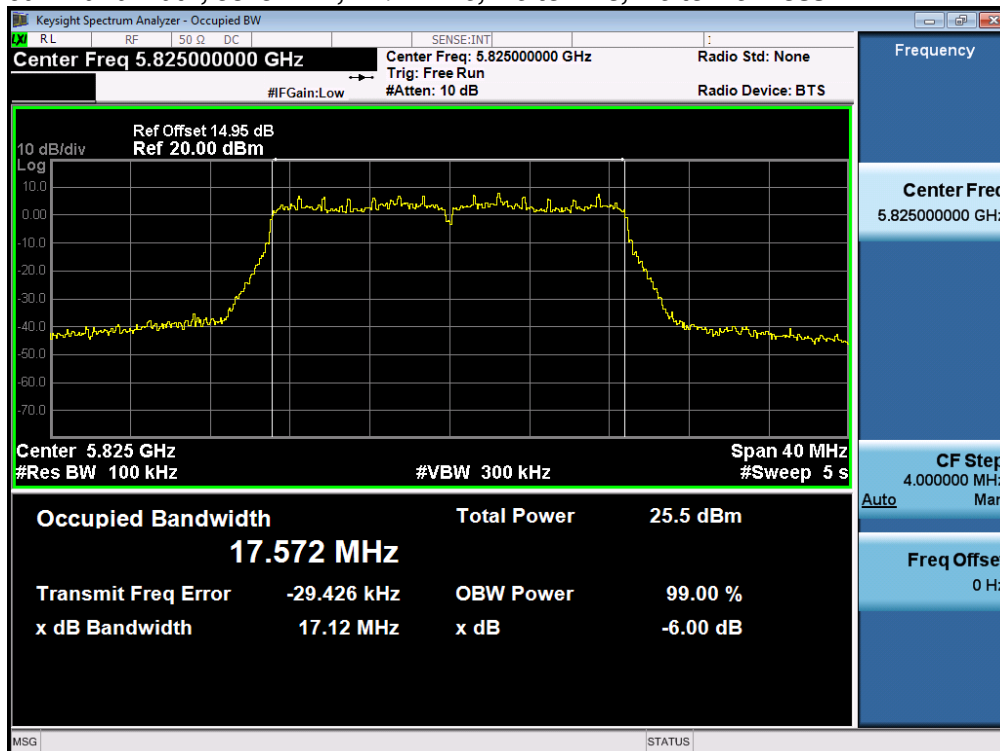

A.2 99% and 26dB Bandwidth

FCC 15.407 The 99% occupied bandwidth is the frequency bandwidth such that, below its lower and above its upper frequency limits, the mean powers are each equal to 0.5% of the total mean power of the given emission. There is no limit for 99% OBW.

The 26 dB emission is the width of the emission that is constrained by the frequencies associated with the two outermost amplitude points (upper and lower frequencies) that are attenuated by 26 dB relative to the maximum level measured in the fundamental emission.

Test Procedure

Ref. ANSI C63.10: 2013 Section 6.9.3

99% BW and EBW (-26dB)

Test Procedure

1. Set the radio in the continuous transmitting mode.
2. Allow the trace to stabilize.
3. Setting the x-dB bandwidth mode to -26dB and OBW power function to 99% within the measurement set up function.
4. Select the automatic OBW measurement function of an instrument to perform bandwidth measurement.
5. Capture graphs and record pertinent measurement data.

Ref. ANSI C63.10: 2013 Section 6.9.3

99% BW and EBW (-26dB)

Test parameters

Span = 1.5 x to 5.0 times OBW

RBW = approx. 1% to 5% of the OBW

VBW \geq 3 x RBW

Detector = Peak or where practical sample shall be used

Trace = Max. Hold

| System Number | Description | Samples | System under test | Support equipment |
|---------------|-------------|---------|-------------------------------------|-------------------------------------|
| 1 | EUT | S01 | <input checked="" type="checkbox"/> | <input type="checkbox"/> |
| | Support | S02 | <input type="checkbox"/> | <input checked="" type="checkbox"/> |

Tested By :

Jose Aguirre

Date of testing:

10-Oct-15 - 11-Nov-15

Test Result : PASS

See Appendix C for list of test equipment

| Frequency (MHz) | Mode | Data Rate (Mbps) | 26dB BW (MHz) | 99% BW (MHz) |
|-----------------|-------------------------------------|------------------|---------------|--------------|
| 5745 | Non HT/VHT20, 6 to 54 Mbps | 6 | 19.5 | 16.6 |
| | HT/VHT20, M0 to M23, M0 to M9 1-3ss | m0 | 19.8 | 17.6 |
| 5755 | Non HT/VHT40, 6 to 54 Mbps | 6 | 40.6 | 36.2 |
| | HT/VHT40, M0 to M23, M0 to M9 1-3ss | m0 | 40.5 | 36.1 |
| 5775 | Non HT/VHT80, 6 to 54 Mbps | 6 | 85.3 | 76.3 |
| | HT/VHT80, M0 to M23, M0 to M9 1-3ss | m0x1 | 82.0 | 76.6 |
| 5785 | Non HT/VHT20, 6 to 54 Mbps | 6 | 20.9 | 16.6 |
| | HT/VHT20, M0 to M23, M0 to M9 1-3ss | m0 | 20.1 | 17.6 |
| 5795 | Non HT/VHT40, 6 to 54 Mbps | 6 | 40.7 | 36.3 |
| | HT/VHT40, M0 to M23, M0 to M9 1-3ss | m0 | 40.5 | 36.1 |
| 5825 | Non HT/VHT20, 6 to 54 Mbps | 6 | 19.5 | 16.6 |
| | HT/VHT20, M0 to M23, M0 to M9 1-3ss | m0 | 19.9 | 17.6 |

26dB / 99% Bandwidth, 5745 MHz, Non HT/VHT20, 6 to 54 Mbps

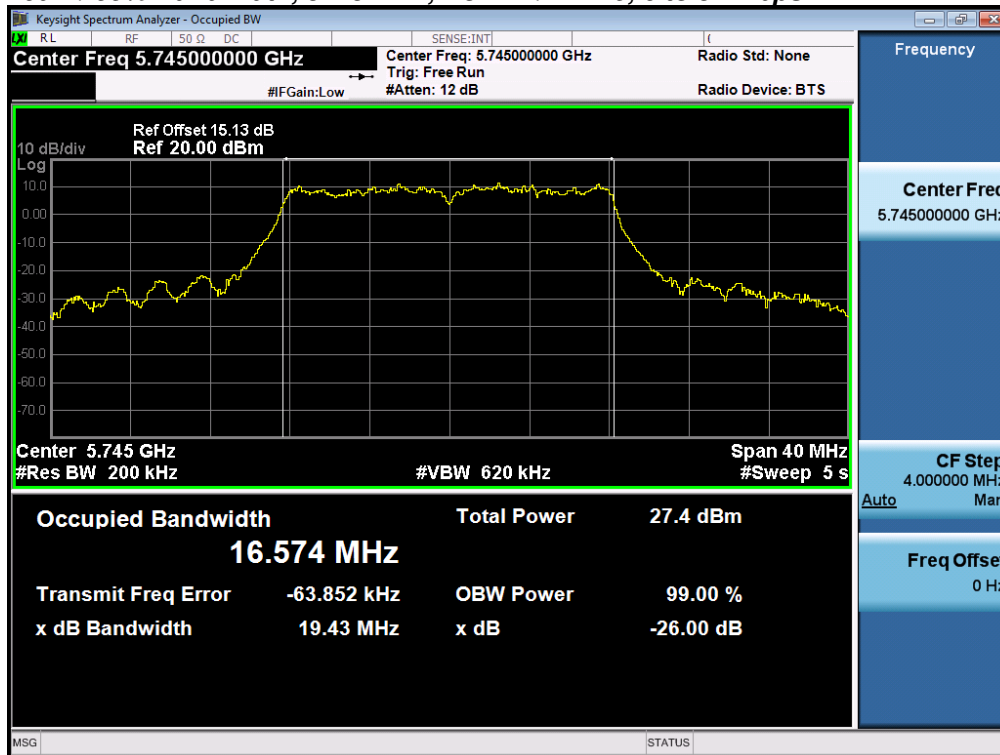

26dB / 99% Bandwidth, 5745 MHz, HT/VHT20, M0 to M23, M0 to M9 1-3ss

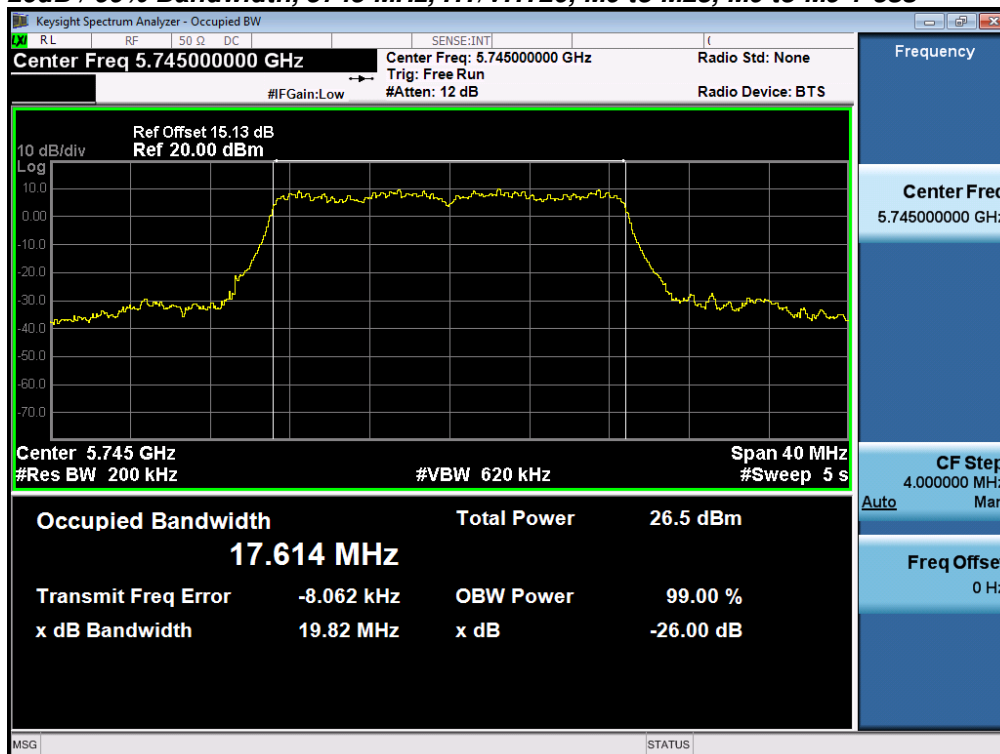

26dB / 99% Bandwidth, 5755 MHz, Non HT/VHT40, 6 to 54 Mbps

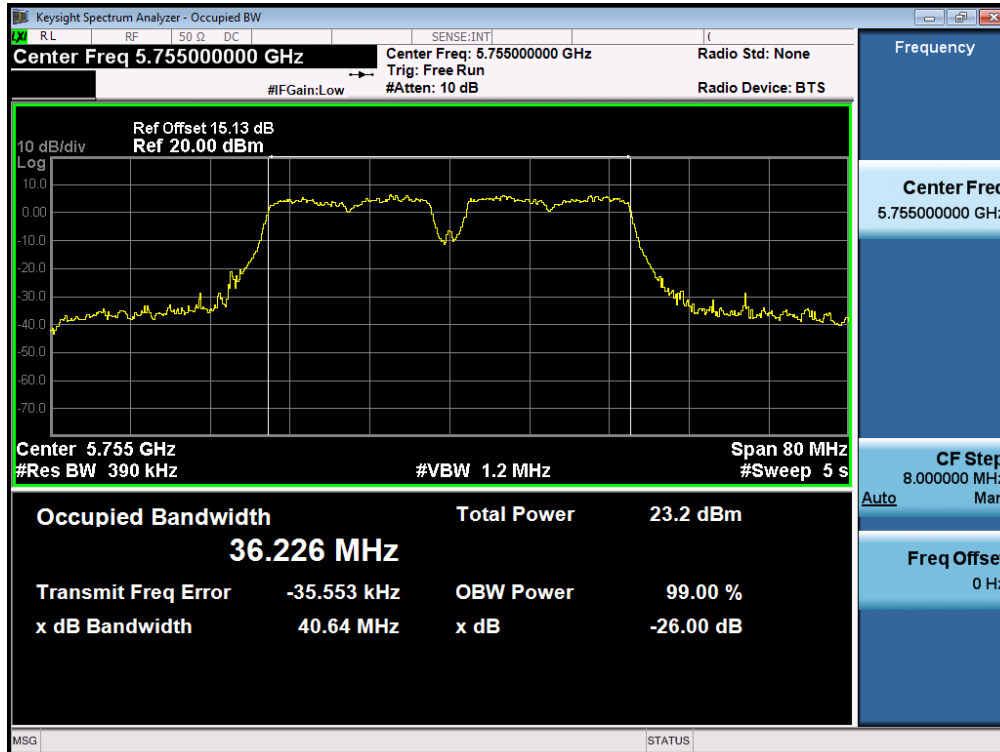

26dB / 99% Bandwidth, 5755 MHz, HT/VHT40, M0 to M23, M0 to M9 1-3ss

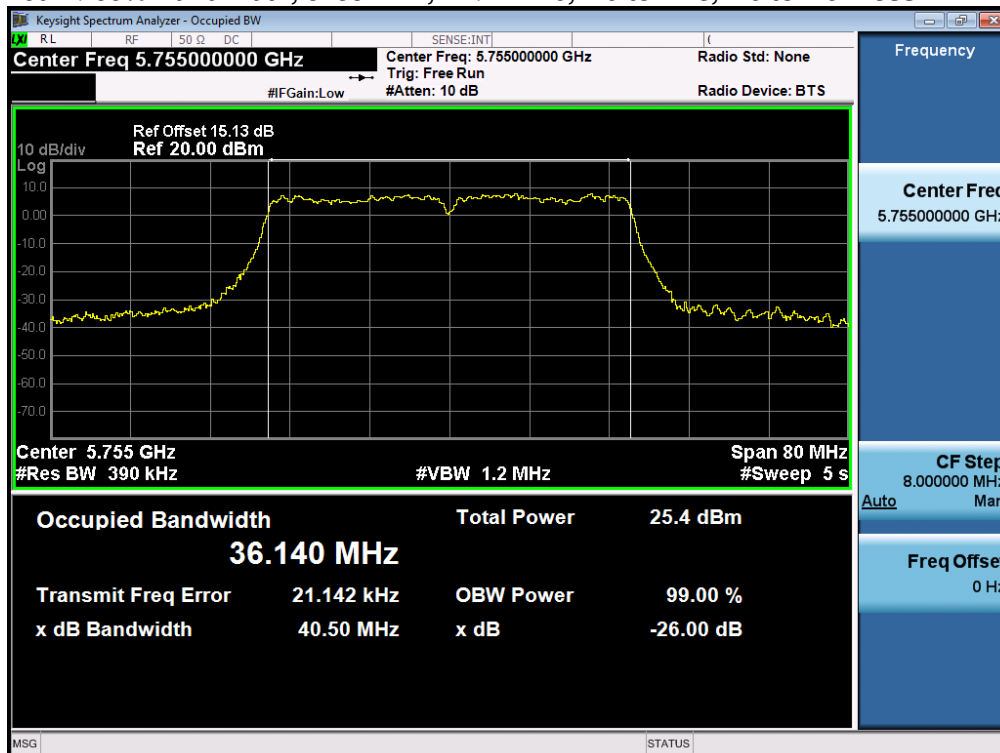

26dB / 99% Bandwidth, 5775 MHz, Non HT/VHT80, 6 to 54 Mbps

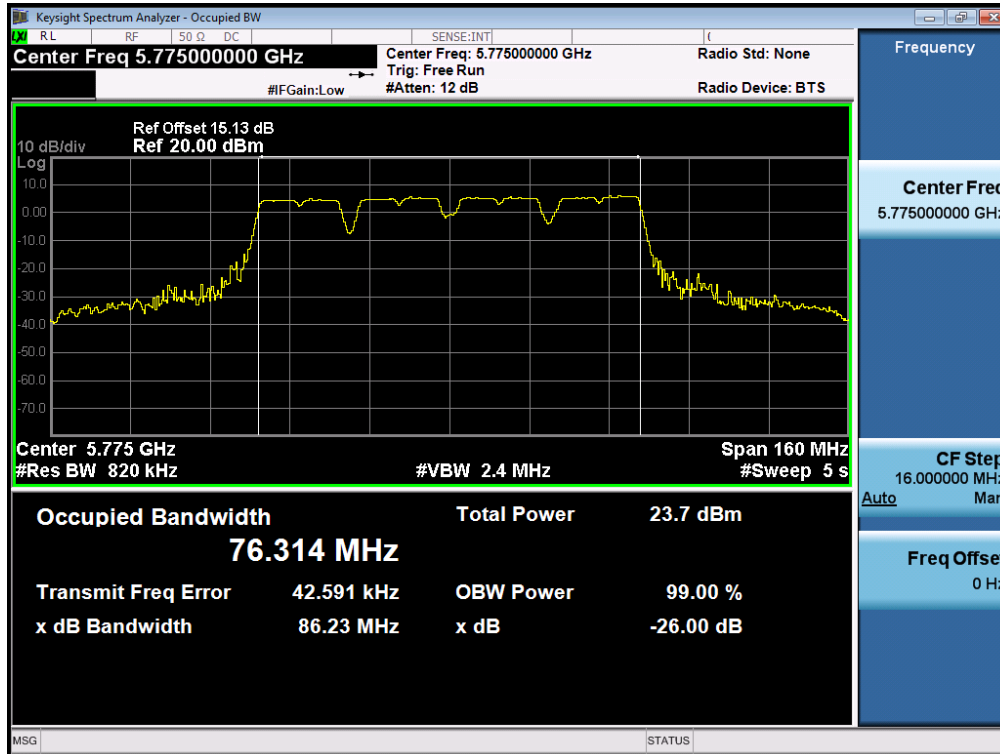

26dB / 99% Bandwidth, 5775 MHz, HT/VHT80, M0 to M23, M0 to M9 1-3ss

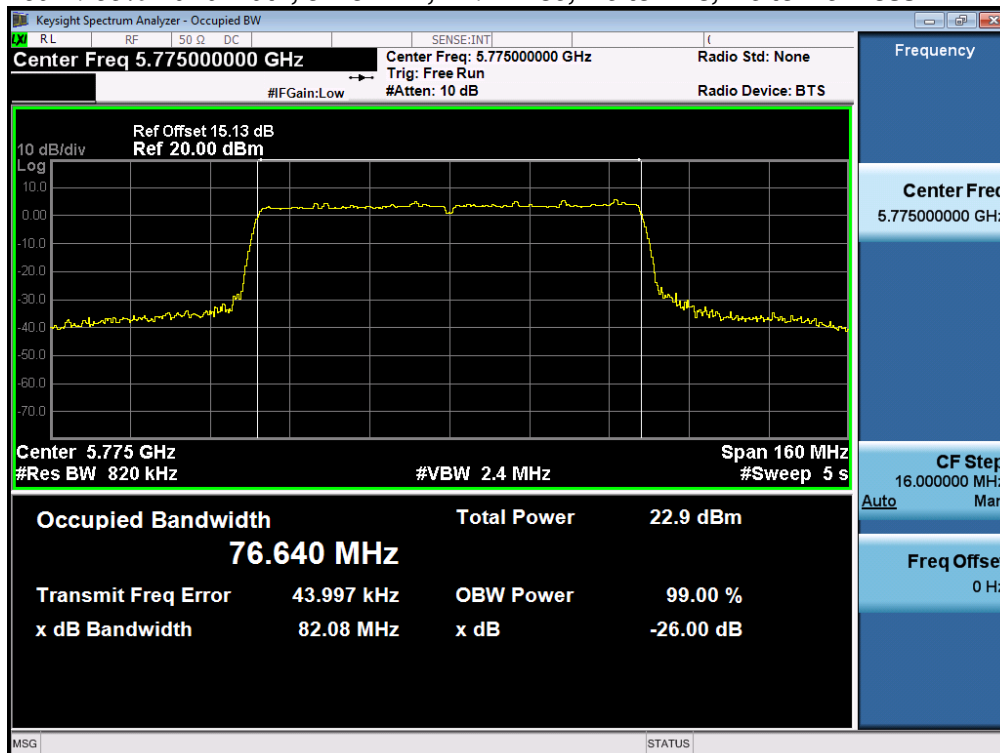

26dB / 99% Bandwidth, 5785 MHz, Non HT/VHT20, 6 to 54 Mbps

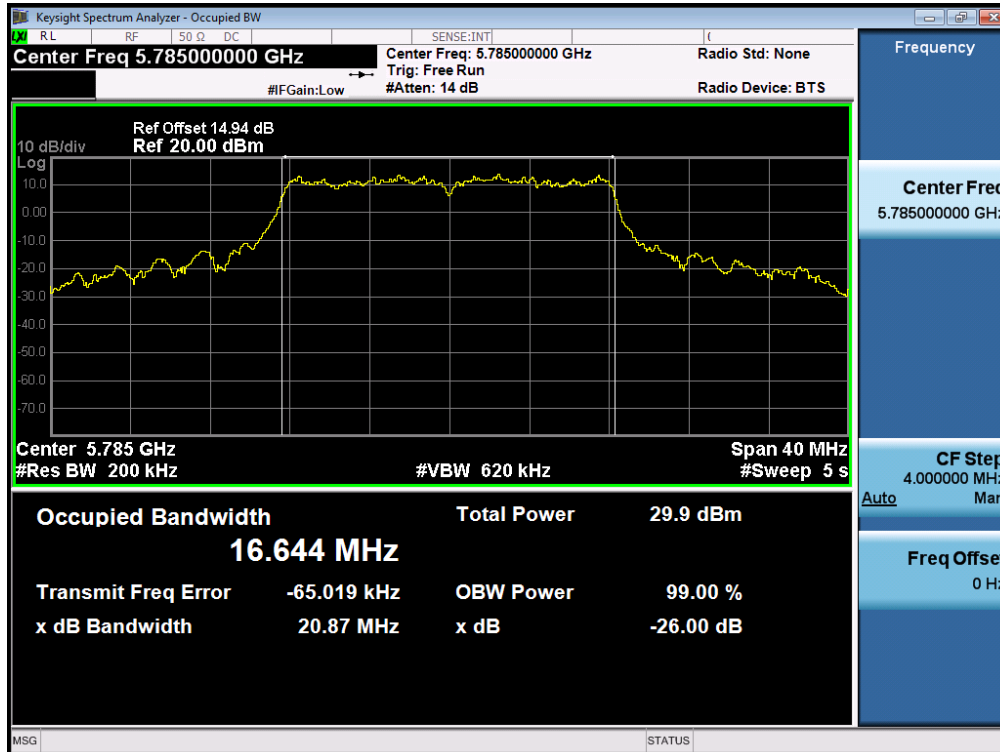

26dB / 99% Bandwidth, 5785 MHz, HT/VHT20, M0 to M23, M0 to M9 1-3ss

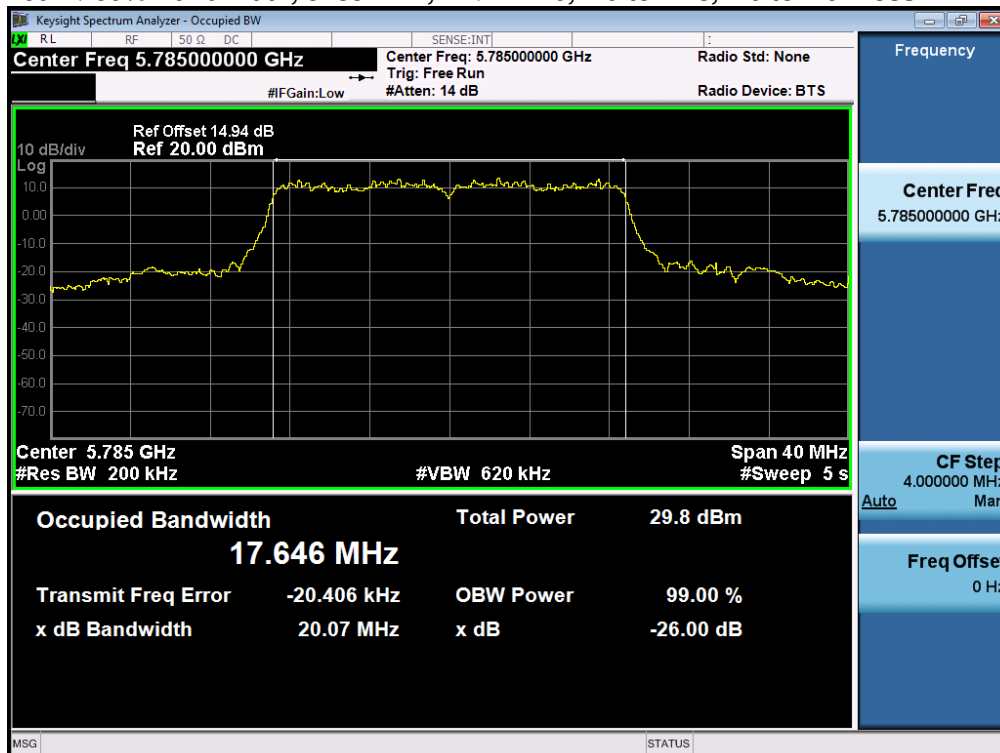

26dB / 99% Bandwidth, 5795 MHz, Non HT/VHT40, 6 to 54 Mbps

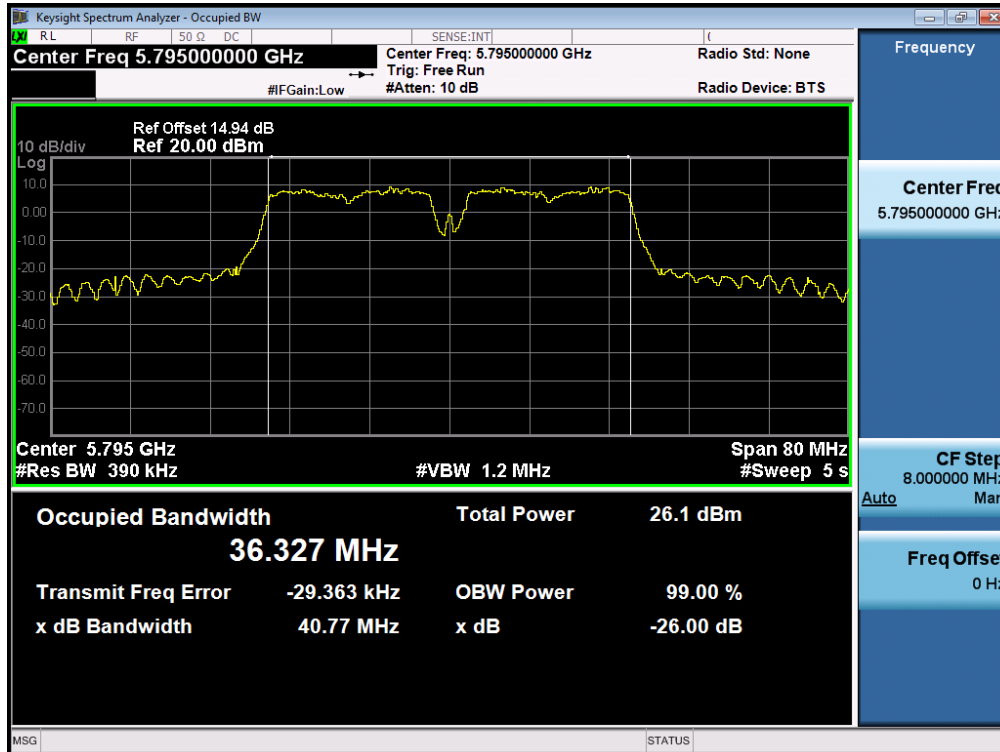

26dB / 99% Bandwidth, 5795 MHz, HT/VHT40, M0 to M23, M0 to M9 1-3ss

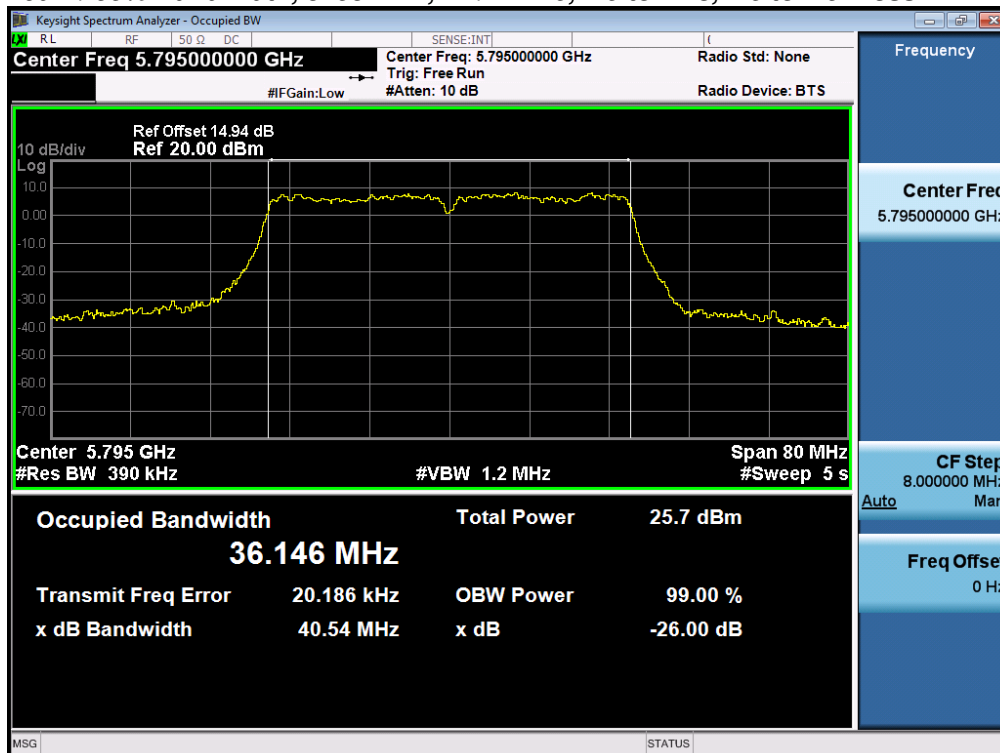

26dB / 99% Bandwidth, 5825 MHz, Non HT/VHT20, 6 to 54 Mbps

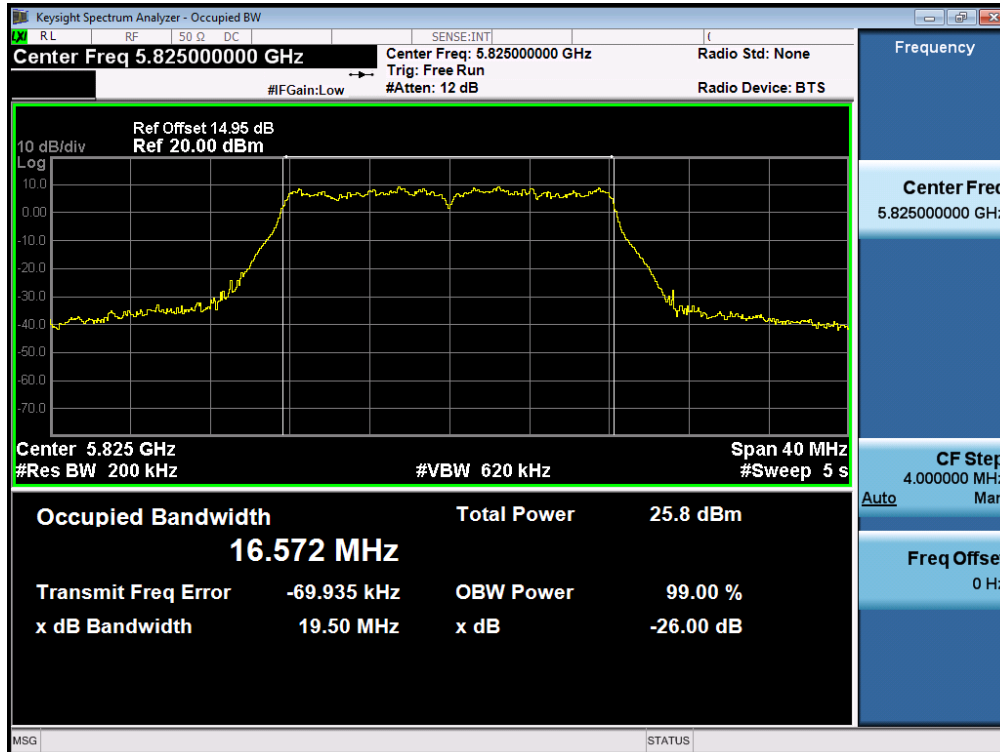

26dB / 99% Bandwidth, 5825 MHz, HT/VHT20, M0 to M23, M0 to M9 1-3ss

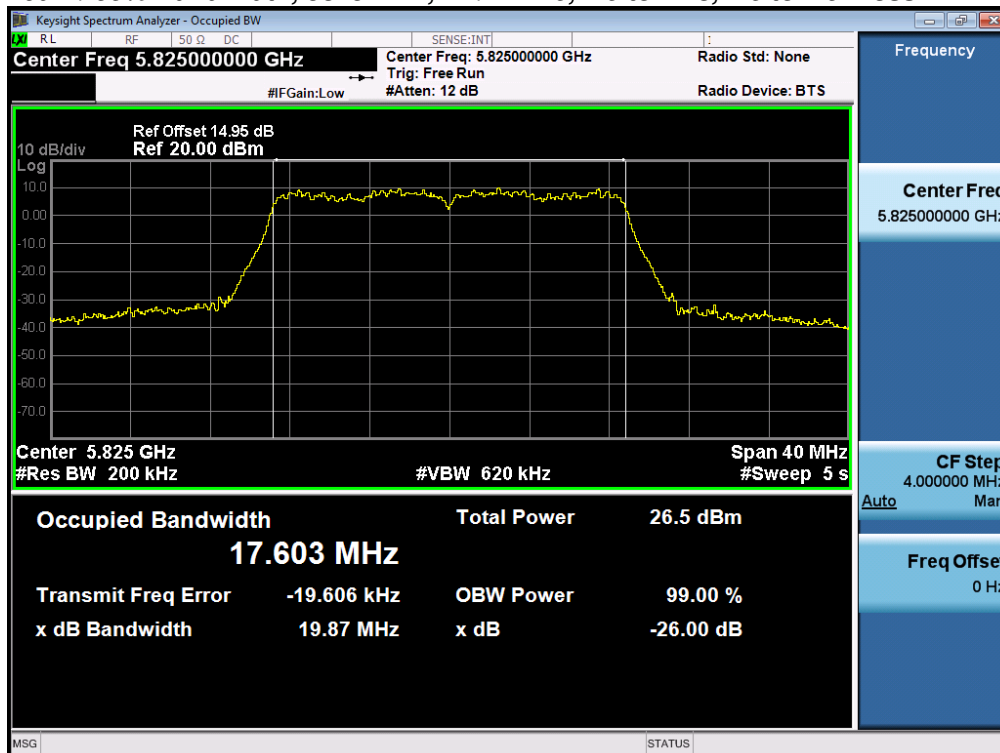

A.3 Maximum Conducted Output Power

15.407 a.3

(3) For the band 5.725-5.85 GHz, the maximum conducted output power over the frequency band of operation shall not exceed 1 W. If transmitting antennas of directional gain greater than 6 dBi are used, both the maximum conducted output power and the maximum power spectral density shall be reduced by the amount in dB that the directional gain of the antenna exceeds 6 dBi. However, fixed point-to-point U-NII devices operating in this band may employ transmitting antennas with directional gain greater than 6 dBi without any corresponding reduction in transmitter conducted power. Fixed, point-to-point operations exclude the use of point-to-multipoint systems, omnidirectional applications, and multiple collocated transmitters transmitting the same information. The operator of the U-NII device, or if the equipment is professionally installed, the installer, is responsible for ensuring that systems employing high gain directional antennas are used exclusively for fixed, point-to-point operations.

The maximum supported antenna gain is 6dBi. The peak correlated gain for each mode is listed in the table below. See the Theory of Operation for details on the correlated gain for each mode.

Test Procedure

Ref. KDB 789033 D02 General UNII Test Procedures New Rules v01
ANSI C63.10: 2013

Maximum Conducted Output power

Test Procedure

1. Set the radio in the continuous transmitting mode at full power
2. Compute power by integrating the spectrum across the EBW (or alternatively entire 99% OBW) of the signal using the instrument's band power measurement function. The integration shall be performed using the spectrum analyzer band-power measurement function with band limits set equal to the EBW or the OBW band edges.
3. Capture graphs and record pertinent measurement data.

Ref. KDB 789033 D02 General UNII Test Procedures New Rules v01
ANSI C63.10: 2013 section 11.9.2 **Method AVGSA-1**

Maximum Conducted Output power

Test parameters

Span = >1.5 times the OBW
 RBW = 1MHz
 VBW \geq 3 x RBW
 Sweep = Auto couple
 Detector = Sample
 Trace = Trace Average 100

The "measure-and-sum technique" is used for measuring in-band transmit power of a device. In the measure-and-sum approach, the conducted emission level is measured at each antenna port. The measured results at the various antenna ports are then summed mathematically to determine the total emission level from the device. Summing is performed in linear power units. (ANSI C63.10: 2013, section 14.3.2.2)

| System Number | Description | Samples | System under test | Support equipment |
|---------------|-------------|---------|-------------------------------------|--------------------------|
| 1 | EUT | S01 | <input checked="" type="checkbox"/> | <input type="checkbox"/> |

| | |
|------------------------------------|--|
| Tested By : Jose Aguirre | Date of testing: 10-Oct-15 - 11-Nov-15 |
| Test Result : PASS | |

See Appendix C for list of test equipment

| Frequency (MHz) | Mode | Tx Paths | Correlated Antenna Gain (dBi) | Tx 1 Max Power (dBm) | Tx 2 Max Power (dBm) | Tx 3 Max Power (dBm) | Tx 4 Max Power (dBm) | Total Tx Channel Power (dBm) | Limit (dBm) | Margin (dB) |
|---------------------------------------|---|----------|-------------------------------|----------------------|----------------------|----------------------|----------------------|------------------------------|-------------|-------------|
| 5745 | Non HT/VHT20, 6 to 54 Mbps | 1 | 4 | 20.4 | | | | 20.4 | 30.0 | 9.6 |
| | Non HT/VHT20, 6 to 54 Mbps | 2 | 4 | 19.2 | 19.8 | | | 22.5 | 30.0 | 7.5 |
| | Non HT/VHT20, 6 to 54 Mbps | 3 | 4 | 19.2 | 19.8 | 19.1 | | 24.1 | 30.0 | 5.9 |
| | Non HT/VHT20, 6 to 54 Mbps | 4 | 4 | 18.4 | 18.9 | 18.2 | 18.7 | 24.6 | 30.0 | 5.4 |
| | Non HT/VHT20 Beam Forming, 6 to 54 Mbps | 2 | 7 | 18.4 | 18.9 | | | 21.7 | 29.0 | 7.3 |
| | Non HT/VHT20 Beam Forming, 6 to 54 Mbps | 3 | 9 | 16.7 | 16.9 | 16.3 | | 21.4 | 27.2 | 5.8 |
| | Non HT/VHT20 Beam Forming, 6 to 54 Mbps | 4 | 10 | 15.8 | 15.9 | 15.3 | 15.7 | 21.7 | 26.0 | 4.3 |
| | HT/VHT20, M0 to M7, M0 to M9 1ss | 1 | 4 | 19.3 | | | | 19.3 | 30.0 | 10.7 |
| | HT/VHT20, M0 to M7, M0 to M9 1ss | 2 | 4 | 17.7 | 18.1 | | | 20.9 | 30.0 | 9.1 |
| | HT/VHT20, M8 to M15, M0 to M9 2ss | 2 | 4 | 17.7 | 18.1 | | | 20.9 | 30.0 | 9.1 |
| | HT/VHT20, M0 to M7, M0 to M9 1ss | 3 | 4 | 17.7 | 18.1 | 17.3 | | 22.5 | 30.0 | 7.5 |
| | HT/VHT20, M8 to M15, M0 to M9 2ss | 3 | 4 | 17.7 | 18.1 | 17.3 | | 22.5 | 30.0 | 7.5 |
| | HT/VHT20, M16 to M23, M0 to M9 3ss | 3 | 4 | 17.7 | 18.1 | 17.3 | | 22.5 | 30.0 | 7.5 |
| | HT/VHT20, M0 to M7, M0 to M9 1ss | 4 | 4 | 17.7 | 18.1 | 17.3 | 17.9 | 23.8 | 30.0 | 6.2 |
| | HT/VHT20, M8 to M15, M0 to M9 2ss | 4 | 4 | 17.7 | 18.1 | 17.3 | 17.9 | 23.8 | 30.0 | 6.2 |
| | HT/VHT20, M16 to M23, M0 to M9 3ss | 4 | 4 | 17.7 | 18.1 | 17.3 | 17.9 | 23.8 | 30.0 | 6.2 |
| | HT/VHT20 Beam Forming, M0 to M7, M0 to M9 1ss | 2 | 7 | 16.7 | 16.7 | | | 19.7 | 29.0 | 9.3 |
| | HT/VHT20 Beam Forming, M8 to M15, M0 to M9 2ss | 2 | 4 | 17.7 | 18.1 | | | 20.9 | 30.0 | 9.1 |
| | HT/VHT20 Beam Forming, M0 to M7, M0 to M9 1ss | 3 | 9 | 16.7 | 16.7 | 16.4 | | 21.4 | 27.2 | 5.8 |
| | HT/VHT20 Beam Forming, M8 to M15, M0 to M9 2ss | 3 | 6 | 16.7 | 16.7 | 16.4 | | 21.4 | 30.0 | 8.6 |
| | HT/VHT20 Beam Forming, M16 to M23, M0 to M9 3ss | 3 | 4 | 17.7 | 18.1 | 17.3 | | 22.5 | 30.0 | 7.5 |
| | HT/VHT20 Beam Forming, M0 to M7, M0 to M9 1ss | 4 | 10 | 15.7 | 15.6 | 15.3 | 15.7 | 21.6 | 26.0 | 4.4 |
| | HT/VHT20 Beam Forming, M8 to M15, M0 to M9 2ss | 4 | 7 | 16.7 | 16.7 | 16.4 | 16.7 | 22.6 | 29.0 | 6.4 |
| | HT/VHT20 Beam Forming, M16 to M23, M0 to M9 3ss | 4 | 5 | 16.7 | 16.7 | 16.4 | 16.7 | 22.6 | 30.0 | 7.4 |
| | HT/VHT20 STBC, M0 to M7, M0 to M9 1ss | 2 | 4 | 17.7 | 18.1 | | | 20.9 | 30.0 | 9.1 |
| | HT/VHT20 STBC, M0 to M7, M0 to M9 1ss | 3 | 4 | 17.7 | 18.1 | 17.3 | | 22.5 | 30.0 | 7.5 |
| HT/VHT20 STBC, M0 to M7, M0 to M9 1ss | 4 | 4 | 17.7 | 18.1 | 17.3 | 17.9 | 23.8 | 30.0 | 6.2 | |
| 5755 | Non HT/VHT40, 6 to 54 Mbps | 1 | 4 | 15.9 | | | | 15.9 | 30.0 | 14.1 |
| | Non HT/VHT40, 6 to 54 Mbps | 2 | 4 | 15.9 | 16.1 | | | 19.0 | 30.0 | 11.0 |
| | Non HT/VHT40, 6 to 54 Mbps | 3 | 4 | 15.9 | 16.1 | 15.6 | | 20.6 | 30.0 | 9.4 |
| | Non HT/VHT40, 6 to 54 Mbps | 4 | 4 | 13.8 | 14.0 | 13.5 | 14.0 | 19.9 | 30.0 | 10.1 |
| | HT/VHT40, M0 to M7, M0 to M9 1ss | 1 | 4 | 18.3 | | | | 18.3 | 30.0 | 11.7 |
| | HT/VHT40, M0 to M7, M0 to M9 1ss | 2 | 4 | 17.1 | 17.0 | | | 20.1 | 30.0 | 9.9 |
| | HT/VHT40, M8 to M15, M0 to M9 2ss | 2 | 4 | 17.1 | 17.0 | | | 20.1 | 30.0 | 9.9 |

| | | | | | | | | | | |
|---------------------------------------|---|---|------|------|------|------|------|------|------|------|
| | HT/VHT40, M0 to M7, M0 to M9 1ss | 3 | 4 | 16.1 | 15.9 | 15.6 | | 20.6 | 30.0 | 9.4 |
| | HT/VHT40, M8 to M15, M0 to M9 2ss | 3 | 4 | 16.1 | 15.9 | 15.6 | | 20.6 | 30.0 | 9.4 |
| | HT/VHT40, M16 to M23, M0 to M9 3ss | 3 | 4 | 16.1 | 15.9 | 15.6 | | 20.6 | 30.0 | 9.4 |
| | HT/VHT40, M0 to M7, M0 to M9 1ss | 4 | 4 | 12.6 | 12.8 | 12.6 | 13.2 | 18.8 | 30.0 | 11.2 |
| | HT/VHT40, M8 to M15, M0 to M9 2ss | 4 | 4 | 12.6 | 12.8 | 12.6 | 13.2 | 18.8 | 30.0 | 11.2 |
| | HT/VHT40, M16 to M23, M0 to M9 3ss | 4 | 4 | 12.6 | 12.8 | 12.6 | 13.2 | 18.8 | 30.0 | 11.2 |
| | HT/VHT40 Beam Forming, M0 to M7, M0 to M9 1ss | 2 | 7 | 15.3 | 15.4 | | | 18.4 | 29.0 | 10.6 |
| | HT/VHT40 Beam Forming, M8 to M15, M0 to M9 2ss | 2 | 4 | 17.1 | 17.0 | | | 20.1 | 30.0 | 9.9 |
| | HT/VHT40 Beam Forming, M0 to M7, M0 to M9 1ss | 3 | 9 | 11.6 | 12.3 | 11.6 | | 16.6 | 27.2 | 10.6 |
| | HT/VHT40 Beam Forming, M8 to M15, M0 to M9 2ss | 3 | 6 | 15.3 | 15.4 | 14.8 | | 19.9 | 30.0 | 10.1 |
| | HT/VHT40 Beam Forming, M16 to M23, M0 to M9 3ss | 3 | 4 | 16.1 | 15.9 | 15.6 | | 20.6 | 30.0 | 9.4 |
| | HT/VHT40 Beam Forming, M0 to M7, M0 to M9 1ss | 4 | 10 | 10.5 | 10.9 | 10.6 | 11.0 | 16.8 | 26.0 | 9.2 |
| | HT/VHT40 Beam Forming, M8 to M15, M0 to M9 2ss | 4 | 7 | 11.6 | 12.3 | 11.6 | 12.2 | 18.0 | 29.0 | 11.0 |
| | HT/VHT40 Beam Forming, M16 to M23, M0 to M9 3ss | 4 | 5 | 11.6 | 12.3 | 11.6 | 12.2 | 18.0 | 30.0 | 12.0 |
| | HT/VHT40 STBC, M0 to M7, M0 to M9 1ss | 2 | 4 | 17.1 | 17.0 | | | 20.1 | 30.0 | 9.9 |
| | HT/VHT40 STBC, M0 to M7, M0 to M9 1ss | 3 | 4 | 16.1 | 15.9 | 15.6 | | 20.6 | 30.0 | 9.4 |
| | HT/VHT40 STBC, M0 to M7, M0 to M9 1ss | 4 | 4 | 12.6 | 12.8 | 12.6 | 13.2 | 18.8 | 30.0 | 11.2 |
| | | | | | | | | | | |
| 5775 | Non HT/VHT80, 6 to 54 Mbps | 1 | 4 | 16.1 | | | | 16.1 | 30.0 | 13.9 |
| | Non HT/VHT80, 6 to 54 Mbps | 2 | 4 | 12.6 | 12.9 | | | 15.8 | 30.0 | 14.2 |
| | Non HT/VHT80, 6 to 54 Mbps | 3 | 4 | 11.6 | 12.2 | 11.9 | | 16.7 | 30.0 | 13.3 |
| | Non HT/VHT80, 6 to 54 Mbps | 4 | 4 | 10.5 | 10.7 | 10.5 | 10.9 | 16.7 | 30.0 | 13.3 |
| | HT/VHT80, M0 to M7, M0 to M9 1ss | 1 | 4 | 18.0 | | | | 18.0 | 30.0 | 12.0 |
| | HT/VHT80, M0 to M7, M0 to M9 1ss | 2 | 4 | 15.0 | 15.1 | | | 18.1 | 30.0 | 11.9 |
| | HT/VHT80, M8 to M15, M0 to M9 2ss | 2 | 4 | 15.0 | 15.1 | | | 18.1 | 30.0 | 11.9 |
| | HT/VHT80, M0 to M7, M0 to M9 1ss | 3 | 4 | 13.7 | 13.7 | 13.6 | | 18.4 | 30.0 | 11.6 |
| | HT/VHT80, M8 to M15, M0 to M9 2ss | 3 | 4 | 13.7 | 13.7 | 13.6 | | 18.4 | 30.0 | 11.6 |
| | HT/VHT80, M16 to M23, M0 to M9 3ss | 3 | 4 | 13.7 | 13.7 | 13.6 | | 18.4 | 30.0 | 11.6 |
| | HT/VHT80, M0 to M7, M0 to M9 1ss | 4 | 4 | 11.5 | 12.0 | 11.6 | 12.2 | 17.9 | 30.0 | 12.1 |
| | HT/VHT80, M8 to M15, M0 to M9 2ss | 4 | 4 | 11.5 | 12.0 | 11.6 | 12.2 | 17.9 | 30.0 | 12.1 |
| | HT/VHT80, M16 to M23, M0 to M9 3ss | 4 | 4 | 11.5 | 12.0 | 11.6 | 12.2 | 17.9 | 30.0 | 12.1 |
| | HT/VHT80 Beam Forming, M0 to M7, M0 to M9 1ss | 2 | 7 | 11.5 | 12.0 | | | 14.8 | 29.0 | 14.2 |
| | HT/VHT80 Beam Forming, M8 to M15, M0 to M9 2ss | 2 | 4 | 15.0 | 15.1 | | | 18.1 | 30.0 | 11.9 |
| | HT/VHT80 Beam Forming, M0 to M7, M0 to M9 1ss | 3 | 9 | 10.3 | 10.7 | 10.5 | | 15.3 | 27.2 | 11.9 |
| | HT/VHT80 Beam Forming, M8 to M15, M0 to M9 2ss | 3 | 6 | 11.5 | 12.0 | 11.6 | | 16.5 | 30.0 | 13.5 |
| | HT/VHT80 Beam Forming, M16 to M23, M0 to M9 3ss | 3 | 4 | 13.7 | 13.7 | 13.6 | | 18.4 | 30.0 | 11.6 |
| | HT/VHT80 Beam Forming, M0 to M7, M0 to M9 1ss | 4 | 10 | 9.4 | 9.7 | 9.5 | 9.7 | 15.6 | 26.0 | 10.4 |
| | HT/VHT80 Beam Forming, M8 to M15, M0 to M9 2ss | 4 | 7 | 10.3 | 10.7 | 10.5 | 10.7 | 16.6 | 29.0 | 12.4 |
| | HT/VHT80 Beam Forming, M16 to M23, M0 to M9 3ss | 4 | 5 | 11.5 | 12.0 | 11.6 | 12.2 | 17.9 | 30.0 | 12.1 |
| | HT/VHT80 STBC, M0 to M7, M0 to M9 1ss | 2 | 4 | 15.0 | 15.1 | | | 18.1 | 30.0 | 11.9 |
| | HT/VHT80 STBC, M0 to M7, M0 to M9 1ss | 3 | 4 | 13.7 | 13.7 | 13.6 | | 18.4 | 30.0 | 11.6 |
| HT/VHT80 STBC, M0 to M7, M0 to M9 1ss | 4 | 4 | 11.5 | 12.0 | 11.6 | 12.2 | 17.9 | 30.0 | 12.1 | |

| | | | | | | | | | | |
|---------------------------------------|---|----------|----------|-------------|-------------|-------------|-------------|-------------|-------------|------------|
| 5785 | Non HT/VHT20, 6 to 54 Mbps | 1 | 4 | 22.8 | | | | 22.8 | 30.0 | 7.2 |
| | Non HT/VHT20, 6 to 54 Mbps | 2 | 4 | 22.8 | 23.6 | | | 26.2 | 30.0 | 3.8 |
| | Non HT/VHT20, 6 to 54 Mbps | 3 | 4 | 22.8 | 23.6 | 23.5 | | 28.1 | 30.0 | 1.9 |
| | Non HT/VHT20, 6 to 54 Mbps | 4 | 4 | 22.8 | 23.6 | 23.5 | 24.0 | 29.5 | 30.0 | 0.5 |
| | Non HT/VHT20 Beam Forming, 6 to 54 Mbps | 2 | 7 | 22.8 | 23.6 | | | 26.2 | 29.0 | 2.8 |
| | Non HT/VHT20 Beam Forming, 6 to 54 Mbps | 3 | 9 | 21.2 | 21.7 | 21.8 | | 26.3 | 27.2 | 0.9 |
| | Non HT/VHT20 Beam Forming, 6 to 54 Mbps | 4 | 10 | 18.6 | 18.8 | 18.7 | 19.1 | 24.8 | 26.0 | 1.2 |
| | HT/VHT20, M0 to M7, M0 to M9 1ss | 1 | 4 | 22.7 | | | | 22.7 | 30.0 | 7.3 |
| | HT/VHT20, M0 to M7, M0 to M9 1ss | 2 | 4 | 22.7 | 23.7 | | | 26.2 | 30.0 | 3.8 |
| | HT/VHT20, M8 to M15, M0 to M9 2ss | 2 | 4 | 22.7 | 23.7 | | | 26.2 | 30.0 | 3.8 |
| | HT/VHT20, M0 to M7, M0 to M9 1ss | 3 | 4 | 22.7 | 23.7 | 23.3 | | 28.0 | 30.0 | 2.0 |
| | HT/VHT20, M8 to M15, M0 to M9 2ss | 3 | 4 | 22.7 | 23.7 | 23.3 | | 28.0 | 30.0 | 2.0 |
| | HT/VHT20, M16 to M23, M0 to M9 3ss | 3 | 4 | 22.7 | 23.7 | 23.3 | | 28.0 | 30.0 | 2.0 |
| | HT/VHT20, M0 to M7, M0 to M9 1ss | 4 | 4 | 22.7 | 23.7 | 23.3 | 23.9 | 29.4 | 30.0 | 0.6 |
| | HT/VHT20, M8 to M15, M0 to M9 2ss | 4 | 4 | 22.7 | 23.7 | 23.3 | 23.9 | 29.4 | 30.0 | 0.6 |
| | HT/VHT20, M16 to M23, M0 to M9 3ss | 4 | 4 | 22.7 | 23.7 | 23.3 | 23.9 | 29.4 | 30.0 | 0.6 |
| | HT/VHT20 Beam Forming, M0 to M7, M0 to M9 1ss | 2 | 7 | 22.7 | 23.7 | | | 26.2 | 29.0 | 2.8 |
| | HT/VHT20 Beam Forming, M8 to M15, M0 to M9 2ss | 2 | 4 | 22.7 | 23.7 | | | 26.2 | 30.0 | 3.8 |
| | HT/VHT20 Beam Forming, M0 to M7, M0 to M9 1ss | 3 | 9 | 21.2 | 21.7 | 21.6 | | 26.3 | 27.2 | 0.9 |
| | HT/VHT20 Beam Forming, M8 to M15, M0 to M9 2ss | 3 | 6 | 22.7 | 23.7 | 23.3 | | 28.0 | 30.0 | 2.0 |
| | HT/VHT20 Beam Forming, M16 to M23, M0 to M9 3ss | 3 | 4 | 22.7 | 23.7 | 23.3 | | 28.0 | 30.0 | 2.0 |
| | HT/VHT20 Beam Forming, M0 to M7, M0 to M9 1ss | 4 | 10 | 18.6 | 18.8 | 18.5 | 18.8 | 24.7 | 26.0 | 1.3 |
| | HT/VHT20 Beam Forming, M8 to M15, M0 to M9 2ss | 4 | 7 | 21.2 | 21.7 | 21.6 | 21.9 | 27.6 | 29.0 | 1.4 |
| | HT/VHT20 Beam Forming, M16 to M23, M0 to M9 3ss | 4 | 5 | 22.7 | 23.7 | 23.3 | 23.9 | 29.4 | 30.0 | 0.6 |
| HT/VHT20 STBC, M0 to M7, M0 to M9 1ss | 2 | 4 | 22.7 | 23.7 | | | 26.2 | 30.0 | 3.8 | |
| HT/VHT20 STBC, M0 to M7, M0 to M9 1ss | 3 | 4 | 22.7 | 23.7 | 23.3 | | 28.0 | 30.0 | 2.0 | |
| HT/VHT20 STBC, M0 to M7, M0 to M9 1ss | 4 | 4 | 22.7 | 23.7 | 23.3 | 23.9 | 29.4 | 30.0 | 0.6 | |
| 5795 | Non HT/VHT40, 6 to 54 Mbps | 1 | 4 | 18.9 | | | | 18.9 | 30.0 | 11.1 |
| | Non HT/VHT40, 6 to 54 Mbps | 2 | 4 | 18.2 | 18.3 | | | 21.3 | 30.0 | 8.7 |
| | Non HT/VHT40, 6 to 54 Mbps | 3 | 4 | 16.2 | 16.2 | 15.9 | | 20.9 | 30.0 | 9.1 |
| | Non HT/VHT40, 6 to 54 Mbps | 4 | 4 | 16.2 | 16.2 | 15.9 | 16.3 | 22.2 | 30.0 | 7.8 |
| | HT/VHT40, M0 to M7, M0 to M9 1ss | 1 | 4 | 20.8 | | | | 20.8 | 30.0 | 9.2 |
| | HT/VHT40, M0 to M7, M0 to M9 1ss | 2 | 4 | 20.8 | 21.2 | | | 24.0 | 30.0 | 6.0 |
| | HT/VHT40, M8 to M15, M0 to M9 2ss | 2 | 4 | 20.8 | 21.2 | | | 24.0 | 30.0 | 6.0 |
| | HT/VHT40, M0 to M7, M0 to M9 1ss | 3 | 4 | 18.4 | 18.1 | 18.1 | | 23.0 | 30.0 | 7.0 |
| | HT/VHT40, M8 to M15, M0 to M9 2ss | 3 | 4 | 18.4 | 18.1 | 18.1 | | 23.0 | 30.0 | 7.0 |
| | HT/VHT40, M16 to M23, M0 to M9 3ss | 3 | 4 | 18.4 | 18.1 | 18.1 | | 23.0 | 30.0 | 7.0 |
| | HT/VHT40, M0 to M7, M0 to M9 1ss | 4 | 4 | 18.4 | 18.1 | 18.1 | 18.3 | 24.2 | 30.0 | 5.8 |
| | HT/VHT40, M8 to M15, M0 to M9 2ss | 4 | 4 | 18.4 | 18.1 | 18.1 | 18.3 | 24.2 | 30.0 | 5.8 |
| | HT/VHT40, M16 to M23, M0 to M9 3ss | 4 | 4 | 18.4 | 18.1 | 18.1 | 18.3 | 24.2 | 30.0 | 5.8 |

| | | | | | | | | | | |
|------|---|---|----|------|------|------|------|------|------|------|
| | HT/VHT40 Beam Forming, M0 to M7, M0 to M9 1ss | 2 | 7 | 18.4 | 18.1 | | | 21.3 | 29.0 | 7.7 |
| | HT/VHT40 Beam Forming, M8 to M15, M0 to M9 2ss | 2 | 4 | 20.8 | 21.2 | | | 24.0 | 30.0 | 6.0 |
| | HT/VHT40 Beam Forming, M0 to M7, M0 to M9 1ss | 3 | 9 | 16.3 | 16.1 | 16.1 | | 20.9 | 27.2 | 6.3 |
| | HT/VHT40 Beam Forming, M8 to M15, M0 to M9 2ss | 3 | 6 | 18.4 | 18.1 | 18.1 | | 23.0 | 30.0 | 7.0 |
| | HT/VHT40 Beam Forming, M16 to M23, M0 to M9 3ss | 3 | 4 | 18.4 | 18.1 | 18.1 | | 23.0 | 30.0 | 7.0 |
| | HT/VHT40 Beam Forming, M0 to M7, M0 to M9 1ss | 4 | 10 | 16.3 | 16.1 | 16.1 | 16.0 | 22.1 | 26.0 | 3.9 |
| | HT/VHT40 Beam Forming, M8 to M15, M0 to M9 2ss | 4 | 7 | 16.3 | 16.1 | 16.1 | 16.0 | 22.1 | 29.0 | 6.9 |
| | HT/VHT40 Beam Forming, M16 to M23, M0 to M9 3ss | 4 | 5 | 18.4 | 18.1 | 18.1 | 18.3 | 24.2 | 30.0 | 5.8 |
| | HT/VHT40 STBC, M0 to M7, M0 to M9 1ss | 2 | 4 | 20.8 | 21.2 | | | 24.0 | 30.0 | 6.0 |
| | HT/VHT40 STBC, M0 to M7, M0 to M9 1ss | 3 | 4 | 18.4 | 18.1 | 18.1 | | 23.0 | 30.0 | 7.0 |
| | HT/VHT40 STBC, M0 to M7, M0 to M9 1ss | 4 | 4 | 18.4 | 18.1 | 18.1 | 18.3 | 24.2 | 30.0 | 5.8 |
| | | | | | | | | | | |
| 5825 | Non HT/VHT20, 6 to 54 Mbps | 1 | 4 | 18.7 | | | | 18.7 | 30.0 | 11.3 |
| | Non HT/VHT20, 6 to 54 Mbps | 2 | 4 | 18.7 | 18.7 | | | 21.7 | 30.0 | 8.3 |
| | Non HT/VHT20, 6 to 54 Mbps | 3 | 4 | 18.7 | 18.7 | 18.0 | | 23.3 | 30.0 | 6.7 |
| | Non HT/VHT20, 6 to 54 Mbps | 4 | 4 | 18.2 | 18.0 | 17.4 | 17.9 | 23.9 | 30.0 | 6.1 |
| | Non HT/VHT20 Beam Forming, 6 to 54 Mbps | 2 | 7 | 18.2 | 18.0 | | | 21.1 | 29.0 | 7.9 |
| | Non HT/VHT20 Beam Forming, 6 to 54 Mbps | 3 | 9 | 16.8 | 16.7 | 16.1 | | 21.3 | 27.2 | 5.9 |
| | Non HT/VHT20 Beam Forming, 6 to 54 Mbps | 4 | 10 | 13.7 | 13.7 | 13.1 | 13.5 | 19.5 | 26.0 | 6.5 |
| | HT/VHT20, M0 to M7, M0 to M9 1ss | 1 | 4 | 19.4 | | | | 19.4 | 30.0 | 10.6 |
| | HT/VHT20, M0 to M7, M0 to M9 1ss | 2 | 4 | 19.4 | 19.4 | | | 22.4 | 30.0 | 7.6 |
| | HT/VHT20, M8 to M15, M0 to M9 2ss | 2 | 4 | 19.4 | 19.4 | | | 22.4 | 30.0 | 7.6 |
| | HT/VHT20, M0 to M7, M0 to M9 1ss | 3 | 4 | 18.4 | 18.4 | 17.9 | | 23.0 | 30.0 | 7.0 |
| | HT/VHT20, M8 to M15, M0 to M9 2ss | 3 | 4 | 18.4 | 18.4 | 17.9 | | 23.0 | 30.0 | 7.0 |
| | HT/VHT20, M16 to M23, M0 to M9 3ss | 3 | 4 | 18.4 | 18.4 | 17.9 | | 23.0 | 30.0 | 7.0 |
| | HT/VHT20, M0 to M7, M0 to M9 1ss | 4 | 4 | 18.4 | 18.4 | 17.9 | 18.3 | 24.3 | 30.0 | 5.7 |
| | HT/VHT20, M8 to M15, M0 to M9 2ss | 4 | 4 | 18.4 | 18.4 | 17.9 | 18.3 | 24.3 | 30.0 | 5.7 |
| | HT/VHT20, M16 to M23, M0 to M9 3ss | 4 | 4 | 18.4 | 18.4 | 17.9 | 18.3 | 24.3 | 30.0 | 5.7 |
| | HT/VHT20 Beam Forming, M0 to M7, M0 to M9 1ss | 2 | 7 | 18.4 | 18.4 | | | 21.4 | 29.0 | 7.6 |
| | HT/VHT20 Beam Forming, M8 to M15, M0 to M9 2ss | 2 | 4 | 19.4 | 19.4 | | | 22.4 | 30.0 | 7.6 |
| | HT/VHT20 Beam Forming, M0 to M7, M0 to M9 1ss | 3 | 9 | 16.7 | 16.4 | 15.9 | | 21.1 | 27.2 | 6.1 |
| | HT/VHT20 Beam Forming, M8 to M15, M0 to M9 2ss | 3 | 6 | 18.4 | 18.4 | 17.9 | | 23.0 | 30.0 | 7.0 |
| | HT/VHT20 Beam Forming, M16 to M23, M0 to M9 3ss | 3 | 4 | 18.4 | 18.4 | 17.9 | | 23.0 | 30.0 | 7.0 |
| | HT/VHT20 Beam Forming, M0 to M7, M0 to M9 1ss | 4 | 10 | 15.7 | 15.4 | 14.9 | 15.4 | 21.4 | 26.0 | 4.6 |
| | HT/VHT20 Beam Forming, M8 to M15, M0 to M9 2ss | 4 | 7 | 16.7 | 16.4 | 15.9 | 16.4 | 22.4 | 29.0 | 6.6 |
| | HT/VHT20 Beam Forming, M16 to M23, M0 to M9 3ss | 4 | 5 | 17.9 | 18.0 | 17.2 | 17.7 | 23.7 | 30.0 | 6.3 |
| | HT/VHT20 STBC, M0 to M7, M0 to M9 1ss | 2 | 4 | 19.4 | 19.4 | | | 22.4 | 30.0 | 7.6 |
| | HT/VHT20 STBC, M0 to M7, M0 to M9 1ss | 3 | 4 | 18.4 | 18.4 | 17.9 | | 23.0 | 30.0 | 7.0 |
| | HT/VHT20 STBC, M0 to M7, M0 to M9 1ss | 4 | 4 | 18.4 | 18.4 | 17.9 | 18.3 | 24.3 | 30.0 | 5.7 |

Peak Output Power, 5785 MHz, Non HT/VHT20, 6 to 54 Mbps

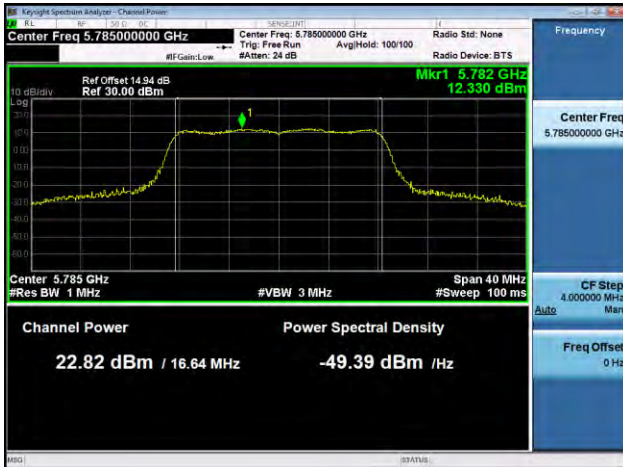

Antenna A

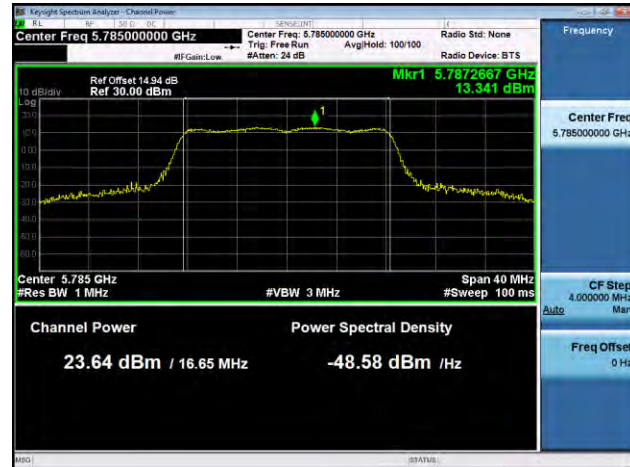

Antenna B

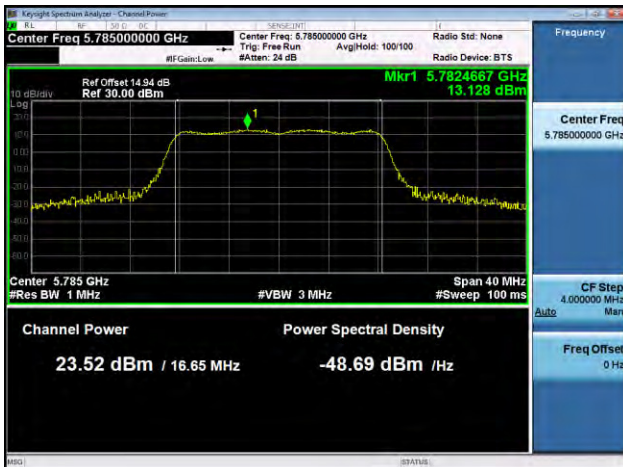

Antenna C

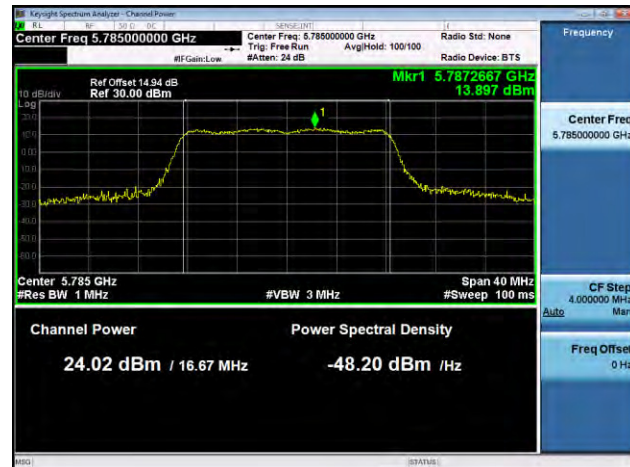

Antenna D

A.4 Power Spectral Density

15.407

The power spectral density shall not exceed 30 dBm in any 500 kHz band. If transmitting antennas of directional gain greater than 6 dBi are used, both the maximum conducted output power and the power spectral density shall be reduced by the amount in dB that the directional gain of the antenna exceeds 6 dBi.

Test Procedure

Ref. KDB 789033 D02 General UNII Test Procedures New Rules v01

| |
|--|
| Power Spectral Density Test Procedure |
| 1. Connect the antenna port(s) to the spectrum analyzer input. 2. Set the radio in the continuous transmitting mode at full power 3. Configure Spectrum analyzer as per test parameters below and Peak search marker 4. Capture graphs and record pertinent measurement data. |

Ref. KDB 789033 D02 v01 section F.5

| |
|---|
| Power Spectral Density Test parameters |
| Span = >1.5 times the OBW RBW = 500 kHz. VBW \geq 3 x RBW Sweep = 10s Detector = Peak Trace = Single Sweep Marker = Peak Search |

The "Measure and add 10 log(N) dB technique", where N is the number of outputs, is used for measuring in-band Power Spectral Density. With this technique, spectrum measurements are performed at each output of the device, and the quantity 10 log(4) (or 6dB) is added to the worst case spectrum value before comparing to the emission limit. (ANSI C63.10 2013 section 14.3.2.3)

| System Number | Description | Samples | System under test | Support equipment |
|---------------|-------------|---------|-------------------------------------|--------------------------|
| 1 | EUT | S01 | <input checked="" type="checkbox"/> | <input type="checkbox"/> |
| | | | | |

| | |
|------------------------------------|--|
| Tested By : Jose Aguirre | Date of testing: 10-Oct-15 - 11-Nov-15 |
| Test Result : PASS | |

See Appendix C for list of test equipment

| Frequency (MHz) | Mode | Tx Paths | Correlated Antenna Gain (dBi) | Tx 1 PSD (dBm/500kHz) | Tx 2 PSD (dBm/500kHz) | Tx 3 PSD (dBm/500kHz) | Tx 4 PSD (dBm/500kHz) | Total PSD (dBm/500kHz) | Limit (dBm/500kHz) | Margin (dB) |
|-----------------------------------|---|----------------------------|-------------------------------|-----------------------|-----------------------|-----------------------|-----------------------|------------------------|--------------------|-------------|
| 5745 | Non HT/VHT20, 6 to 54 Mbps | 1 | 4 | 7.3 | | | | 7.3 | 30.0 | 22.7 |
| | Non HT/VHT20, 6 to 54 Mbps | 2 | 4 | 6.0 | 6.8 | | | 9.4 | 30.0 | 20.6 |
| | Non HT/VHT20, 6 to 54 Mbps | 3 | 4 | 6.0 | 6.8 | 5.8 | | 11.0 | 30.0 | 19.0 |
| | Non HT/VHT20, 6 to 54 Mbps | 4 | 4 | 5.3 | 5.7 | 5.0 | 5.4 | 11.4 | 30.0 | 18.6 |
| | Non HT/VHT20 Beam Forming, 6 to 54 Mbps | 2 | 7 | 5.3 | 5.7 | | | 8.5 | 29.0 | 20.5 |
| | Non HT/VHT20 Beam Forming, 6 to 54 Mbps | 3 | 9 | 3.7 | 3.9 | 3.1 | | 8.4 | 27.2 | 18.8 |
| | Non HT/VHT20 Beam Forming, 6 to 54 Mbps | 4 | 10 | 2.9 | 2.5 | 1.9 | 2.4 | 8.5 | 26.0 | 17.5 |
| | HT/VHT20, M0 to M7, M0 to M9 1ss | 1 | 4 | 5.8 | | | | 5.8 | 30.0 | 24.2 |
| | HT/VHT20, M0 to M7, M0 to M9 1ss | 2 | 4 | 4.0 | 4.6 | | | 7.3 | 30.0 | 22.7 |
| | HT/VHT20, M8 to M15, M0 to M9 2ss | 2 | 4 | 4.0 | 4.6 | | | 7.3 | 30.0 | 22.7 |
| | HT/VHT20, M0 to M7, M0 to M9 1ss | 3 | 4 | 4.0 | 4.6 | 3.7 | | 8.9 | 30.0 | 21.1 |
| | HT/VHT20, M8 to M15, M0 to M9 2ss | 3 | 4 | 4.0 | 4.6 | 3.7 | | 8.9 | 30.0 | 21.1 |
| | HT/VHT20, M16 to M23, M0 to M9 3ss | 3 | 4 | 4.0 | 4.6 | 3.7 | | 8.9 | 30.0 | 21.1 |
| | HT/VHT20, M0 to M7, M0 to M9 1ss | 4 | 4 | 4.0 | 4.6 | 3.7 | 4.3 | 10.2 | 30.0 | 19.8 |
| | HT/VHT20, M8 to M15, M0 to M9 2ss | 4 | 4 | 4.0 | 4.6 | 3.7 | 4.3 | 10.2 | 30.0 | 19.8 |
| | HT/VHT20, M16 to M23, M0 to M9 3ss | 4 | 4 | 4.0 | 4.6 | 3.7 | 4.3 | 10.2 | 30.0 | 19.8 |
| | HT/VHT20 Beam Forming, M0 to M7, M0 to M9 1ss | 2 | 7 | 3.3 | 3.0 | | | 6.2 | 29.0 | 22.8 |
| | HT/VHT20 Beam Forming, M8 to M15, M0 to M9 2ss | 2 | 4 | 4.0 | 4.6 | | | 7.3 | 30.0 | 22.7 |
| | HT/VHT20 Beam Forming, M0 to M7, M0 to M9 1ss | 3 | 9 | 3.3 | 3.0 | 2.9 | | 7.8 | 27.2 | 19.4 |
| | HT/VHT20 Beam Forming, M8 to M15, M0 to M9 2ss | 3 | 6 | 3.3 | 3.0 | 2.9 | | 7.8 | 30.0 | 22.2 |
| | HT/VHT20 Beam Forming, M16 to M23, M0 to M9 3ss | 3 | 4 | 4.0 | 4.6 | 3.7 | | 8.9 | 30.0 | 21.1 |
| | HT/VHT20 Beam Forming, M0 to M7, M0 to M9 1ss | 4 | 10 | 2.1 | 2.4 | 1.7 | 2.1 | 8.1 | 26.0 | 17.9 |
| | HT/VHT20 Beam Forming, M8 to M15, M0 to M9 2ss | 4 | 7 | 3.3 | 3.0 | 2.9 | 3.3 | 9.1 | 29.0 | 19.9 |
| | HT/VHT20 Beam Forming, M16 to M23, M0 to M9 3ss | 4 | 5 | 3.3 | 3.0 | 2.9 | 3.3 | 9.1 | 30.0 | 20.9 |
| | HT/VHT20 STBC, M0 to M7, M0 to M9 1ss | 2 | 4 | 4.0 | 4.6 | | | 7.3 | 30.0 | 22.7 |
| | HT/VHT20 STBC, M0 to M7, M0 to M9 1ss | 3 | 4 | 4.0 | 4.6 | 3.7 | | 8.9 | 30.0 | 21.1 |
| | HT/VHT20 STBC, M0 to M7, M0 to M9 1ss | 4 | 4 | 4.0 | 4.6 | 3.7 | 4.3 | 10.2 | 30.0 | 19.8 |
| | 5755 | Non HT/VHT40, 6 to 54 Mbps | 1 | 4 | -0.3 | | | | -0.3 | 30.0 |
| Non HT/VHT40, 6 to 54 Mbps | | 2 | 4 | -0.3 | -0.4 | | | 2.7 | 30.0 | 27.3 |
| Non HT/VHT40, 6 to 54 Mbps | | 3 | 4 | -0.3 | -0.4 | -0.5 | | 4.4 | 30.0 | 25.6 |
| Non HT/VHT40, 6 to 54 Mbps | | 4 | 4 | -2.6 | -2.2 | -2.7 | -1.5 | 3.8 | 30.0 | 26.2 |
| HT/VHT40, M0 to M7, M0 to M9 1ss | | 1 | 4 | 1.8 | | | | 1.8 | 30.0 | 28.2 |
| HT/VHT40, M0 to M7, M0 to M9 1ss | | 2 | 4 | 0.8 | 0.5 | | | 3.7 | 30.0 | 26.3 |
| HT/VHT40, M8 to M15, M0 to M9 2ss | | 2 | 4 | 0.8 | 0.5 | | | 3.7 | 30.0 | 26.3 |

| | | | | | | | | | | |
|---------------------------------------|---|---|------|-------|-------|-------|-------|------|------|------|
| | HT/VHT40, M0 to M7, M0 to M9 1ss | 3 | 4 | -0.5 | -0.7 | -1.0 | | 4.0 | 30.0 | 26.0 |
| | HT/VHT40, M8 to M15, M0 to M9 2ss | 3 | 4 | -0.5 | -0.7 | -1.0 | | 4.0 | 30.0 | 26.0 |
| | HT/VHT40, M16 to M23, M0 to M9 3ss | 3 | 4 | -0.5 | -0.7 | -1.0 | | 4.0 | 30.0 | 26.0 |
| | HT/VHT40, M0 to M7, M0 to M9 1ss | 4 | 4 | -3.7 | -3.8 | -4.0 | -3.3 | 2.3 | 30.0 | 27.7 |
| | HT/VHT40, M8 to M15, M0 to M9 2ss | 4 | 4 | -3.7 | -3.8 | -4.0 | -3.3 | 2.3 | 30.0 | 27.7 |
| | HT/VHT40, M16 to M23, M0 to M9 3ss | 4 | 4 | -3.7 | -3.8 | -4.0 | -3.3 | 2.3 | 30.0 | 27.7 |
| | HT/VHT40 Beam Forming, M0 to M7, M0 to M9 1ss | 2 | 7 | -1.0 | -0.9 | | | 2.1 | 29.0 | 26.9 |
| | HT/VHT40 Beam Forming, M8 to M15, M0 to M9 2ss | 2 | 4 | 0.8 | 0.5 | | | 3.7 | 30.0 | 26.3 |
| | HT/VHT40 Beam Forming, M0 to M7, M0 to M9 1ss | 3 | 9 | -4.8 | -4.2 | -4.2 | | 0.4 | 27.2 | 26.8 |
| | HT/VHT40 Beam Forming, M8 to M15, M0 to M9 2ss | 3 | 6 | -1.0 | -0.9 | -1.7 | | 3.6 | 30.0 | 26.4 |
| | HT/VHT40 Beam Forming, M16 to M23, M0 to M9 3ss | 3 | 4 | -0.5 | -0.7 | -1.0 | | 4.0 | 30.0 | 26.0 |
| | HT/VHT40 Beam Forming, M0 to M7, M0 to M9 1ss | 4 | 10 | -5.9 | -5.5 | -6.3 | -5.4 | 0.3 | 26.0 | 25.7 |
| | HT/VHT40 Beam Forming, M8 to M15, M0 to M9 2ss | 4 | 7 | -4.8 | -4.2 | -4.2 | -4.3 | 1.7 | 29.0 | 27.3 |
| | HT/VHT40 Beam Forming, M16 to M23, M0 to M9 3ss | 4 | 5 | -4.8 | -4.2 | -4.2 | -4.3 | 1.7 | 30.0 | 28.3 |
| | HT/VHT40 STBC, M0 to M7, M0 to M9 1ss | 2 | 4 | 0.8 | 0.5 | | | 3.7 | 30.0 | 26.3 |
| | HT/VHT40 STBC, M0 to M7, M0 to M9 1ss | 3 | 4 | -0.5 | -0.7 | -1.0 | | 4.0 | 30.0 | 26.0 |
| | HT/VHT40 STBC, M0 to M7, M0 to M9 1ss | 4 | 4 | -3.7 | -3.8 | -4.0 | -3.3 | 2.3 | 30.0 | 27.7 |
| | | | | | | | | | | |
| 5775 | Non HT/VHT80, 6 to 54 Mbps | 1 | 4 | -3.2 | | | | -3.2 | 30.0 | 33.2 |
| | Non HT/VHT80, 6 to 54 Mbps | 2 | 4 | -6.9 | -6.6 | | | -3.7 | 30.0 | 33.7 |
| | Non HT/VHT80, 6 to 54 Mbps | 3 | 4 | -7.9 | -7.3 | -7.6 | | -2.8 | 30.0 | 32.8 |
| | Non HT/VHT80, 6 to 54 Mbps | 4 | 4 | -8.6 | -8.9 | -8.9 | -8.9 | -2.8 | 30.0 | 32.8 |
| | HT/VHT80, M0 to M7, M0 to M9 1ss | 1 | 4 | -1.9 | | | | -1.9 | 30.0 | 31.9 |
| | HT/VHT80, M0 to M7, M0 to M9 1ss | 2 | 4 | -4.9 | -4.8 | | | -1.8 | 30.0 | 31.8 |
| | HT/VHT80, M8 to M15, M0 to M9 2ss | 2 | 4 | -4.9 | -4.8 | | | -1.8 | 30.0 | 31.8 |
| | HT/VHT80, M0 to M7, M0 to M9 1ss | 3 | 4 | -5.7 | -6.4 | -6.4 | | -1.4 | 30.0 | 31.4 |
| | HT/VHT80, M8 to M15, M0 to M9 2ss | 3 | 4 | -5.7 | -6.4 | -6.4 | | -1.4 | 30.0 | 31.4 |
| | HT/VHT80, M16 to M23, M0 to M9 3ss | 3 | 4 | -5.7 | -6.4 | -6.4 | | -1.4 | 30.0 | 31.4 |
| | HT/VHT80, M0 to M7, M0 to M9 1ss | 4 | 4 | -8.5 | -7.9 | -8.6 | -7.8 | -2.2 | 30.0 | 32.2 |
| | HT/VHT80, M8 to M15, M0 to M9 2ss | 4 | 4 | -8.5 | -7.9 | -8.6 | -7.8 | -2.2 | 30.0 | 32.2 |
| | HT/VHT80, M16 to M23, M0 to M9 3ss | 4 | 4 | -8.5 | -7.9 | -8.6 | -7.8 | -2.2 | 30.0 | 32.2 |
| | HT/VHT80 Beam Forming, M0 to M7, M0 to M9 1ss | 2 | 7 | -8.5 | -7.9 | | | -5.2 | 29.0 | 34.2 |
| | HT/VHT80 Beam Forming, M8 to M15, M0 to M9 2ss | 2 | 4 | -4.9 | -4.8 | | | -1.8 | 30.0 | 31.8 |
| | HT/VHT80 Beam Forming, M0 to M7, M0 to M9 1ss | 3 | 9 | -9.7 | -9.4 | -9.2 | | -4.7 | 27.2 | 31.9 |
| | HT/VHT80 Beam Forming, M8 to M15, M0 to M9 2ss | 3 | 6 | -8.5 | -7.9 | -8.6 | | -3.6 | 30.0 | 33.6 |
| | HT/VHT80 Beam Forming, M16 to M23, M0 to M9 3ss | 3 | 4 | -5.7 | -6.4 | -6.4 | | -1.4 | 30.0 | 31.4 |
| | HT/VHT80 Beam Forming, M0 to M7, M0 to M9 1ss | 4 | 10 | -10.5 | -10.3 | -10.5 | -10.4 | -4.4 | 26.0 | 30.4 |
| | HT/VHT80 Beam Forming, M8 to M15, M0 to M9 2ss | 4 | 7 | -9.7 | -9.4 | -9.2 | -9.4 | -3.4 | 29.0 | 32.4 |
| | HT/VHT80 Beam Forming, M16 to M23, M0 to M9 3ss | 4 | 5 | -8.5 | -7.9 | -8.6 | -7.8 | -2.2 | 30.0 | 32.2 |
| | HT/VHT80 STBC, M0 to M7, M0 to M9 1ss | 2 | 4 | -4.9 | -4.8 | | | -1.8 | 30.0 | 31.8 |
| HT/VHT80 STBC, M0 to M7, M0 to M9 1ss | 3 | 4 | -5.7 | -6.4 | -6.4 | | -1.4 | 30.0 | 31.4 | |
| HT/VHT80 STBC, M0 to M7, M0 to M9 1ss | 4 | 4 | -8.5 | -7.9 | -8.6 | -7.8 | -2.2 | 30.0 | 32.2 | |

| | | | | | | | | | | |
|---------------------------------------|---|----------|----------|------------|-------------|-------------|-------------|-------------|-------------|-------------|
| 5785 | Non HT/VHT20, 6 to 54 Mbps | 1 | 4 | 9.9 | | | | 9.9 | 30.0 | 20.1 |
| | Non HT/VHT20, 6 to 54 Mbps | 2 | 4 | 9.9 | 10.3 | | | 13.1 | 30.0 | 16.9 |
| | Non HT/VHT20, 6 to 54 Mbps | 3 | 4 | 9.9 | 10.3 | 10.4 | | 15.0 | 30.0 | 15.0 |
| | Non HT/VHT20, 6 to 54 Mbps | 4 | 4 | 9.9 | 10.3 | 10.4 | 10.8 | 16.4 | 30.0 | 13.6 |
| | Non HT/VHT20 Beam Forming, 6 to 54 Mbps | 2 | 7 | 9.9 | 10.3 | | | 13.1 | 29.0 | 15.9 |
| | Non HT/VHT20 Beam Forming, 6 to 54 Mbps | 3 | 9 | 7.8 | 8.4 | 8.4 | | 13.0 | 27.2 | 14.2 |
| | Non HT/VHT20 Beam Forming, 6 to 54 Mbps | 4 | 10 | 5.3 | 5.7 | 5.8 | 5.9 | 11.7 | 26.0 | 14.3 |
| | HT/VHT20, M0 to M7, M0 to M9 1ss | 1 | 4 | 9.2 | | | | 9.2 | 30.0 | 20.8 |
| | HT/VHT20, M0 to M7, M0 to M9 1ss | 2 | 4 | 9.2 | 10.1 | | | 12.7 | 30.0 | 17.3 |
| | HT/VHT20, M8 to M15, M0 to M9 2ss | 2 | 4 | 9.2 | 10.1 | | | 12.7 | 30.0 | 17.3 |
| | HT/VHT20, M0 to M7, M0 to M9 1ss | 3 | 4 | 9.2 | 10.1 | 9.8 | | 14.5 | 30.0 | 15.5 |
| | HT/VHT20, M8 to M15, M0 to M9 2ss | 3 | 4 | 9.2 | 10.1 | 9.8 | | 14.5 | 30.0 | 15.5 |
| | HT/VHT20, M16 to M23, M0 to M9 3ss | 3 | 4 | 9.2 | 10.1 | 9.8 | | 14.5 | 30.0 | 15.5 |
| | HT/VHT20, M0 to M7, M0 to M9 1ss | 4 | 4 | 9.2 | 10.1 | 9.8 | 10.3 | 15.9 | 30.0 | 14.1 |
| | HT/VHT20, M8 to M15, M0 to M9 2ss | 4 | 4 | 9.2 | 10.1 | 9.8 | 10.3 | 15.9 | 30.0 | 14.1 |
| | HT/VHT20, M16 to M23, M0 to M9 3ss | 4 | 4 | 9.2 | 10.1 | 9.8 | 10.3 | 15.9 | 30.0 | 14.1 |
| | HT/VHT20 Beam Forming, M0 to M7, M0 to M9 1ss | 2 | 7 | 9.2 | 10.1 | | | 12.7 | 29.0 | 16.3 |
| | HT/VHT20 Beam Forming, M8 to M15, M0 to M9 2ss | 2 | 4 | 9.2 | 10.1 | | | 12.7 | 30.0 | 17.3 |
| | HT/VHT20 Beam Forming, M0 to M7, M0 to M9 1ss | 3 | 9 | 7.8 | 8.2 | 7.9 | | 12.7 | 27.2 | 14.5 |
| | HT/VHT20 Beam Forming, M8 to M15, M0 to M9 2ss | 3 | 6 | 9.2 | 10.1 | 9.8 | | 14.5 | 30.0 | 15.5 |
| | HT/VHT20 Beam Forming, M16 to M23, M0 to M9 3ss | 3 | 4 | 9.2 | 10.1 | 9.8 | | 14.5 | 30.0 | 15.5 |
| | HT/VHT20 Beam Forming, M0 to M7, M0 to M9 1ss | 4 | 10 | 4.9 | 5.5 | 5.2 | 5.2 | 11.2 | 26.0 | 14.8 |
| | HT/VHT20 Beam Forming, M8 to M15, M0 to M9 2ss | 4 | 7 | 7.8 | 8.2 | 7.9 | 8.2 | 14.0 | 29.0 | 15.0 |
| | HT/VHT20 Beam Forming, M16 to M23, M0 to M9 3ss | 4 | 5 | 9.2 | 10.1 | 9.8 | 10.3 | 15.9 | 30.0 | 14.1 |
| HT/VHT20 STBC, M0 to M7, M0 to M9 1ss | 2 | 4 | 9.2 | 10.1 | | | 12.7 | 30.0 | 17.3 | |
| HT/VHT20 STBC, M0 to M7, M0 to M9 1ss | 3 | 4 | 9.2 | 10.1 | 9.8 | | 14.5 | 30.0 | 15.5 | |
| HT/VHT20 STBC, M0 to M7, M0 to M9 1ss | 4 | 4 | 9.2 | 10.1 | 9.8 | 10.3 | 15.9 | 30.0 | 14.1 | |
| 5795 | Non HT/VHT40, 6 to 54 Mbps | 1 | 4 | 2.4 | | | | 2.4 | 30.0 | 27.6 |
| | Non HT/VHT40, 6 to 54 Mbps | 2 | 4 | 1.9 | 2.0 | | | 5.0 | 30.0 | 25.0 |
| | Non HT/VHT40, 6 to 54 Mbps | 3 | 4 | 0.0 | -0.2 | -0.5 | | 4.5 | 30.0 | 25.5 |
| | Non HT/VHT40, 6 to 54 Mbps | 4 | 4 | 0.0 | -0.2 | -0.5 | 0.1 | 5.9 | 30.0 | 24.1 |
| | HT/VHT40, M0 to M7, M0 to M9 1ss | 1 | 4 | 4.3 | | | | 4.3 | 30.0 | 25.7 |
| | HT/VHT40, M0 to M7, M0 to M9 1ss | 2 | 4 | 4.3 | 4.7 | | | 7.5 | 30.0 | 22.5 |
| | HT/VHT40, M8 to M15, M0 to M9 2ss | 2 | 4 | 4.3 | 4.7 | | | 7.5 | 30.0 | 22.5 |
| | HT/VHT40, M0 to M7, M0 to M9 1ss | 3 | 4 | 1.7 | 1.3 | 1.7 | | 6.3 | 30.0 | 23.7 |
| | HT/VHT40, M8 to M15, M0 to M9 2ss | 3 | 4 | 1.7 | 1.3 | 1.7 | | 6.3 | 30.0 | 23.7 |
| | HT/VHT40, M16 to M23, M0 to M9 3ss | 3 | 4 | 1.7 | 1.3 | 1.7 | | 6.3 | 30.0 | 23.7 |
| | HT/VHT40, M0 to M7, M0 to M9 1ss | 4 | 4 | 1.7 | 1.3 | 1.7 | 2.0 | 7.7 | 30.0 | 22.3 |
| | HT/VHT40, M8 to M15, M0 to M9 2ss | 4 | 4 | 1.7 | 1.3 | 1.7 | 2.0 | 7.7 | 30.0 | 22.3 |
| | HT/VHT40, M16 to M23, M0 to M9 3ss | 4 | 4 | 1.7 | 1.3 | 1.7 | 2.0 | 7.7 | 30.0 | 22.3 |

| | | | | | | | | | | |
|------|---|---|----|------|------|------|------|------|------|------|
| | HT/VHT40 Beam Forming, M0 to M7, M0 to M9 1ss | 2 | 7 | 1.7 | 1.3 | | | 4.5 | 29.0 | 24.5 |
| | HT/VHT40 Beam Forming, M8 to M15, M0 to M9 2ss | 2 | 4 | 4.3 | 4.7 | | | 7.5 | 30.0 | 22.5 |
| | HT/VHT40 Beam Forming, M0 to M7, M0 to M9 1ss | 3 | 9 | -0.2 | -0.5 | -0.3 | | 4.4 | 27.2 | 22.8 |
| | HT/VHT40 Beam Forming, M8 to M15, M0 to M9 2ss | 3 | 6 | 1.7 | 1.3 | 1.7 | | 6.3 | 30.0 | 23.7 |
| | HT/VHT40 Beam Forming, M16 to M23, M0 to M9 3ss | 3 | 4 | 1.7 | 1.3 | 1.7 | | 6.3 | 30.0 | 23.7 |
| | HT/VHT40 Beam Forming, M0 to M7, M0 to M9 1ss | 4 | 10 | -0.2 | -0.5 | -0.3 | -0.1 | 5.7 | 26.0 | 20.3 |
| | HT/VHT40 Beam Forming, M8 to M15, M0 to M9 2ss | 4 | 7 | -0.2 | -0.5 | -0.3 | -0.1 | 5.7 | 29.0 | 23.3 |
| | HT/VHT40 Beam Forming, M16 to M23, M0 to M9 3ss | 4 | 5 | 1.7 | 1.3 | 1.7 | 2.0 | 7.7 | 30.0 | 22.3 |
| | HT/VHT40 STBC, M0 to M7, M0 to M9 1ss | 2 | 4 | 4.3 | 4.7 | | | 7.5 | 30.0 | 22.5 |
| | HT/VHT40 STBC, M0 to M7, M0 to M9 1ss | 3 | 4 | 1.7 | 1.3 | 1.7 | | 6.3 | 30.0 | 23.7 |
| | HT/VHT40 STBC, M0 to M7, M0 to M9 1ss | 4 | 4 | 1.7 | 1.3 | 1.7 | 2.0 | 7.7 | 30.0 | 22.3 |
| | | | | | | | | | | |
| 5825 | Non HT/VHT20, 6 to 54 Mbps | 1 | 4 | 5.3 | | | | 5.3 | 30.0 | 24.7 |
| | Non HT/VHT20, 6 to 54 Mbps | 2 | 4 | 5.3 | 5.5 | | | 8.4 | 30.0 | 21.6 |
| | Non HT/VHT20, 6 to 54 Mbps | 3 | 4 | 5.3 | 5.5 | 4.7 | | 10.0 | 30.0 | 20.0 |
| | Non HT/VHT20, 6 to 54 Mbps | 4 | 4 | 5.0 | 4.7 | 4.1 | 4.7 | 10.7 | 30.0 | 19.3 |
| | Non HT/VHT20 Beam Forming, 6 to 54 Mbps | 2 | 7 | 5.0 | 4.7 | | | 7.9 | 29.0 | 21.1 |
| | Non HT/VHT20 Beam Forming, 6 to 54 Mbps | 3 | 9 | 3.6 | 3.4 | 2.7 | | 8.0 | 27.2 | 19.2 |
| | Non HT/VHT20 Beam Forming, 6 to 54 Mbps | 4 | 10 | 0.7 | 0.2 | -0.1 | 0.7 | 6.4 | 26.0 | 19.6 |
| | HT/VHT20, M0 to M7, M0 to M9 1ss | 1 | 4 | 5.9 | | | | 5.9 | 30.0 | 24.1 |
| | HT/VHT20, M0 to M7, M0 to M9 1ss | 2 | 4 | 5.9 | 5.9 | | | 8.9 | 30.0 | 21.1 |
| | HT/VHT20, M8 to M15, M0 to M9 2ss | 2 | 4 | 5.9 | 5.9 | | | 8.9 | 30.0 | 21.1 |
| | HT/VHT20, M0 to M7, M0 to M9 1ss | 3 | 4 | 4.8 | 4.8 | 4.1 | | 9.4 | 30.0 | 20.6 |
| | HT/VHT20, M8 to M15, M0 to M9 2ss | 3 | 4 | 4.8 | 4.8 | 4.1 | | 9.4 | 30.0 | 20.6 |
| | HT/VHT20, M16 to M23, M0 to M9 3ss | 3 | 4 | 4.8 | 4.8 | 4.1 | | 9.4 | 30.0 | 20.6 |
| | HT/VHT20, M0 to M7, M0 to M9 1ss | 4 | 4 | 4.8 | 4.8 | 4.1 | 4.8 | 10.7 | 30.0 | 19.3 |
| | HT/VHT20, M8 to M15, M0 to M9 2ss | 4 | 4 | 4.8 | 4.8 | 4.1 | 4.8 | 10.7 | 30.0 | 19.3 |
| | HT/VHT20, M16 to M23, M0 to M9 3ss | 4 | 4 | 4.8 | 4.8 | 4.1 | 4.8 | 10.7 | 30.0 | 19.3 |
| | HT/VHT20 Beam Forming, M0 to M7, M0 to M9 1ss | 2 | 7 | 4.8 | 4.8 | | | 7.8 | 29.0 | 21.2 |
| | HT/VHT20 Beam Forming, M8 to M15, M0 to M9 2ss | 2 | 4 | 5.9 | 5.9 | | | 8.9 | 30.0 | 21.1 |
| | HT/VHT20 Beam Forming, M0 to M7, M0 to M9 1ss | 3 | 9 | 3.2 | 2.8 | 2.6 | | 7.6 | 27.2 | 19.6 |
| | HT/VHT20 Beam Forming, M8 to M15, M0 to M9 2ss | 3 | 6 | 4.8 | 4.8 | 4.1 | | 9.4 | 30.0 | 20.6 |
| | HT/VHT20 Beam Forming, M16 to M23, M0 to M9 3ss | 3 | 4 | 4.8 | 4.8 | 4.1 | | 9.4 | 30.0 | 20.6 |
| | HT/VHT20 Beam Forming, M0 to M7, M0 to M9 1ss | 4 | 10 | 2.3 | 1.9 | 1.5 | 2.0 | 8.0 | 26.0 | 18.0 |
| | HT/VHT20 Beam Forming, M8 to M15, M0 to M9 2ss | 4 | 7 | 3.2 | 2.8 | 2.6 | 3.0 | 8.9 | 29.0 | 20.1 |
| | HT/VHT20 Beam Forming, M16 to M23, M0 to M9 3ss | 4 | 5 | 4.2 | 4.2 | 3.7 | 4.1 | 10.1 | 30.0 | 19.9 |
| | HT/VHT20 STBC, M0 to M7, M0 to M9 1ss | 2 | 4 | 5.9 | 5.9 | | | 8.9 | 30.0 | 21.1 |
| | HT/VHT20 STBC, M0 to M7, M0 to M9 1ss | 3 | 4 | 4.8 | 4.8 | 4.1 | | 9.4 | 30.0 | 20.6 |
| | HT/VHT20 STBC, M0 to M7, M0 to M9 1ss | 4 | 4 | 4.8 | 4.8 | 4.1 | 4.8 | 10.7 | 30.0 | 19.3 |

Power Spectral Density, 5785 MHz, Non HT/VHT20, 6 to 54 Mbps



Antenna A

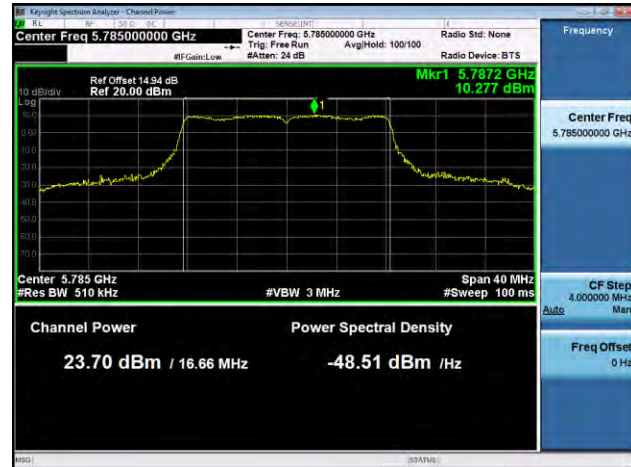

Antenna B

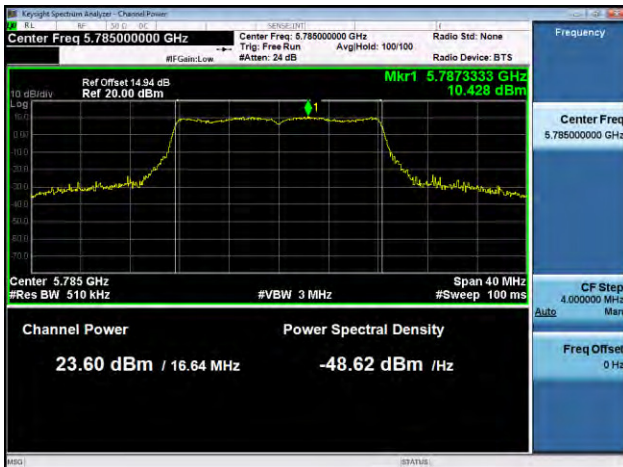

Antenna C

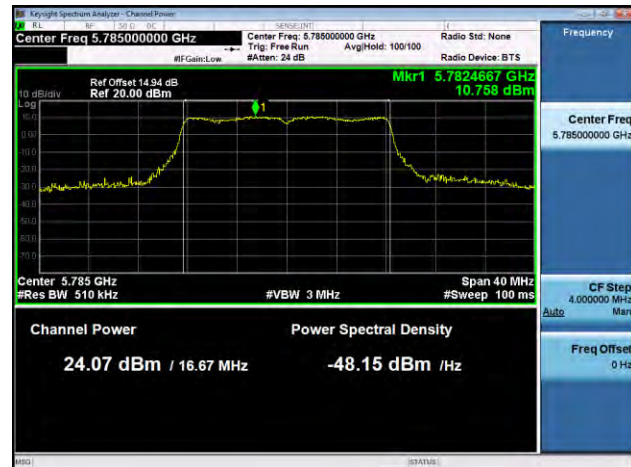

Antenna D

A.5 Conducted Spurious Emissions

15.407 (b) *Undesirable emission limits.* Except as shown in paragraph (b)(7) of this section, the maximum emissions outside of the frequency bands of operation shall be attenuated in accordance with the following limits:

(4) For transmitters operating in the 5.725-5.85 GHz band: All emissions within the frequency range from the band edge to 10 MHz above or below the band edge shall not exceed an e.i.r.p. of -17 dBm/MHz; for frequencies 10 MHz or greater above or below the band edge, emissions shall not exceed an e.i.r.p. of -27 dBm/MHz.

(6) Unwanted emissions below 1 GHz must comply with the general field strength limits set forth in §15.209.

(7) The provisions of §15.205 apply to intentional radiators operating under this section.

Test Procedure

Ref. KDB 789033 D02 General UNII Test Procedures New Rules v01
ANSI C63.10: 2013

Conducted Spurious Emissions

Test Procedure

1. Connect the antenna port(s) to the spectrum analyzer input.
2. Place the radio in continuous transmit mode. Use the procedures in KDB 789033 D02 General UNII Test Procedures New Rules v01 to substitute conducted measurements in place of radiated measurements.
3. Configure Spectrum analyzer as per test parameters below (be sure to enter all losses between the transmitter output and the spectrum analyzer).
4. Record the marker waveform peak to spur difference. Also measure any emissions in the restricted bands.
5. The "measure-and-sum technique" is used for measuring in-band transmit power of a device. In the measure-and-sum approach, the conducted emission level is measured at each antenna port. The measured results at the various antenna ports are then summed mathematically to determine the total emission level from the device. Summing is performed in linear power units. The worst case output is recorded.
6. Capture graphs and record pertinent measurement data.

Ref. KDB 789033 D02 General UNII Test Procedures New Rules v01
ANSI C63.10: 2013 section 12.7.7.3 (average) & 12.7.6 (peak)

Conducted Spurious Emissions

Test parameters

Span = 30MHz to 18GHz / 18GHz to 40GHz
 RBW = 1 MHz
 VBW ≥ 3 x RBW for Peak, 1kHz for Average
 Sweep = Auto couple
 Detector = Peak
 Trace = Max Hold.

| System Number | Description | Samples | System under test | Support equipment |
|---------------|-------------|---------|-------------------------------------|--------------------------|
| 1 | EUT | S01 | <input checked="" type="checkbox"/> | <input type="checkbox"/> |
| | | | | |

| | |
|------------------------------------|--|
| Tested By : Jose Aguirre | Date of testing: 10-Oct-15 - 11-Nov-15 |
| Test Result : PASS | |

See Appendix C for list of test equipment

| Frequency (MHz) | Mode | Tx Paths | Correlated Antenna Gain (dBi) | Tx 1 Spur Power (dBm) | Tx 2 Spur Power (dBm) | Tx 3 Spur Power (dBm) | Tx 4 Spur Power (dBm) | Total Conducted Spur (dBm) | Limit (dBm) | Margin (dB) |
|---------------------------------------|---|----------|-------------------------------|-----------------------|-----------------------|-----------------------|-----------------------|----------------------------|-------------|-------------|
| 5745 | Non HT/VHT20, 6 to 54 Mbps | 1 | 4 | -69.7 | | | | -65.7 | -41.25 | 24.5 |
| | Non HT/VHT20, 6 to 54 Mbps | 2 | 4 | -70.0 | -70.2 | | | -63.1 | -41.25 | 21.8 |
| | Non HT/VHT20, 6 to 54 Mbps | 3 | 4 | -70.0 | -70.2 | -70.5 | | -61.5 | -41.25 | 20.2 |
| | Non HT/VHT20, 6 to 54 Mbps | 4 | 4 | -70.0 | -70.3 | -70.3 | -69.9 | -60.1 | -41.25 | 18.9 |
| | Non HT/VHT20 Beam Forming, 6 to 54 Mbps | 2 | 7 | -70.0 | -70.3 | | | -60.1 | -41.25 | 18.9 |
| | Non HT/VHT20 Beam Forming, 6 to 54 Mbps | 3 | 9 | -63.7 | -70.3 | -70.3 | | -53.3 | -41.25 | 12.1 |
| | Non HT/VHT20 Beam Forming, 6 to 54 Mbps | 4 | 10 | -63.8 | -62.2 | -70.4 | -70.1 | -49.2 | -41.25 | 7.9 |
| | HT/VHT20, M0 to M7, M0 to M9 1ss | 1 | 4 | -69.9 | | | | -65.9 | -41.25 | 24.7 |
| | HT/VHT20, M0 to M7, M0 to M9 1ss | 2 | 4 | -70.3 | -70.2 | | | -63.2 | -41.25 | 22.0 |
| | HT/VHT20, M8 to M15, M0 to M9 2ss | 2 | 4 | -70.3 | -70.2 | | | -63.2 | -41.25 | 22.0 |
| | HT/VHT20, M0 to M7, M0 to M9 1ss | 3 | 4 | -70.3 | -70.2 | -70.3 | | -61.5 | -41.25 | 20.2 |
| | HT/VHT20, M8 to M15, M0 to M9 2ss | 3 | 4 | -70.3 | -70.2 | -70.3 | | -61.5 | -41.25 | 20.2 |
| | HT/VHT20, M16 to M23, M0 to M9 3ss | 3 | 4 | -70.3 | -70.2 | -70.3 | | -61.5 | -41.25 | 20.2 |
| | HT/VHT20, M0 to M7, M0 to M9 1ss | 4 | 4 | -70.3 | -70.2 | -70.3 | -70.1 | -60.2 | -41.25 | 19.0 |
| | HT/VHT20, M8 to M15, M0 to M9 2ss | 4 | 4 | -70.3 | -70.2 | -70.3 | -70.1 | -60.2 | -41.25 | 19.0 |
| | HT/VHT20, M16 to M23, M0 to M9 3ss | 4 | 4 | -70.3 | -70.2 | -70.3 | -70.1 | -60.2 | -41.25 | 19.0 |
| | HT/VHT20 Beam Forming, M0 to M7, M0 to M9 1ss | 2 | 7 | -70.2 | -62.4 | | | -54.7 | -41.25 | 13.5 |
| | HT/VHT20 Beam Forming, M8 to M15, M0 to M9 2ss | 2 | 4 | -70.3 | -70.2 | | | -63.2 | -41.25 | 22.0 |
| | HT/VHT20 Beam Forming, M0 to M7, M0 to M9 1ss | 3 | 9 | -70.2 | -62.4 | -70.3 | | -52.4 | -41.25 | 11.1 |
| | HT/VHT20 Beam Forming, M8 to M15, M0 to M9 2ss | 3 | 6 | -70.2 | -62.4 | -70.3 | | -55.4 | -41.25 | 14.1 |
| | HT/VHT20 Beam Forming, M16 to M23, M0 to M9 3ss | 3 | 4 | -70.3 | -70.2 | -70.3 | | -61.5 | -41.25 | 20.2 |
| | HT/VHT20 Beam Forming, M0 to M7, M0 to M9 1ss | 4 | 10 | -64.1 | -61.9 | -70.3 | -70.4 | -49.1 | -41.25 | 7.9 |
| | HT/VHT20 Beam Forming, M8 to M15, M0 to M9 2ss | 4 | 7 | -70.2 | -62.4 | -70.3 | -70.2 | -53.7 | -41.25 | 12.4 |
| | HT/VHT20 Beam Forming, M16 to M23, M0 to M9 3ss | 4 | 5 | -70.2 | -62.4 | -70.3 | -70.2 | -55.5 | -41.25 | 14.2 |
| | HT/VHT20 STBC, M0 to M7, M0 to M9 1ss | 2 | 4 | -70.3 | -70.2 | | | -63.2 | -41.25 | 22.0 |
| | HT/VHT20 STBC, M0 to M7, M0 to M9 1ss | 3 | 4 | -70.3 | -70.2 | -70.3 | | -61.5 | -41.25 | 20.2 |
| HT/VHT20 STBC, M0 to M7, M0 to M9 1ss | 4 | 4 | -70.3 | -70.2 | -70.3 | -70.1 | -60.2 | -41.25 | 19.0 | |
| 5755 | Non HT/VHT40, 6 to 54 Mbps | 1 | 4 | -70.4 | | | | -66.4 | -41.25 | 25.2 |
| | Non HT/VHT40, 6 to 54 Mbps | 2 | 4 | -70.4 | -61.8 | | | -57.2 | -41.25 | 16.0 |
| | Non HT/VHT40, 6 to 54 Mbps | 3 | 4 | -70.4 | -61.8 | -70.4 | | -56.7 | -41.25 | 15.5 |
| | Non HT/VHT40, 6 to 54 Mbps | 4 | 4 | -64.2 | -61.4 | -70.4 | -70.2 | -54.9 | -41.25 | 13.6 |
| | HT/VHT40, M0 to M7, M0 to M9 1ss | 1 | 4 | -70.0 | | | | -66.0 | -41.25 | 24.8 |
| | HT/VHT40, M0 to M7, M0 to M9 1ss | 2 | 4 | -70.3 | -61.9 | | | -57.3 | -41.25 | 16.1 |
| | HT/VHT40, M8 to M15, M0 to M9 2ss | 2 | 4 | -70.3 | -61.9 | | | -57.3 | -41.25 | 16.1 |

| | | | | | | | | | | |
|---------------------------------------|--|----------|-----------|--------------|--------------|--------------|--------------|--------------|---------------|------------|
| | HT/VHT40, M0 to M7, M0 to M9 1ss | 3 | 4 | -70.3 | -62.4 | -70.4 | | -57.2 | -41.25 | 15.9 |
| | HT/VHT40, M8 to M15, M0 to M9 2ss | 3 | 4 | -70.3 | -62.4 | -70.4 | | -57.2 | -41.25 | 15.9 |
| | HT/VHT40, M16 to M23, M0 to M9 3ss | 3 | 4 | -70.3 | -62.4 | -70.4 | | -57.2 | -41.25 | 15.9 |
| | HT/VHT40, M0 to M7, M0 to M9 1ss | 4 | 4 | -63.7 | -60.7 | -70.5 | -70.3 | -54.4 | -41.25 | 13.1 |
| | HT/VHT40, M8 to M15, M0 to M9 2ss | 4 | 4 | -63.7 | -60.7 | -70.5 | -70.3 | -54.4 | -41.25 | 13.1 |
| | HT/VHT40, M16 to M23, M0 to M9 3ss | 4 | 4 | -63.7 | -60.7 | -70.5 | -70.3 | -54.4 | -41.25 | 13.1 |
| | HT/VHT40 Beam Forming, M0 to M7, M0 to M9 1ss | 2 | 7 | -70.4 | -62.2 | | | -54.6 | -41.25 | 13.3 |
| | HT/VHT40 Beam Forming, M8 to M15, M0 to M9 2ss | 2 | 4 | -70.3 | -61.9 | | | -57.3 | -41.25 | 16.1 |
| | HT/VHT40 Beam Forming, M0 to M7, M0 to M9 1ss | 3 | 9 | -64.2 | -61.1 | -70.4 | | -50.2 | -41.25 | 9.0 |
| | HT/VHT40 Beam Forming, M8 to M15, M0 to M9 2ss | 3 | 6 | -70.4 | -62.2 | -70.4 | | -55.3 | -41.25 | 14.0 |
| | HT/VHT40 Beam Forming, M16 to M23, M0 to M9 3ss | 3 | 4 | -70.3 | -62.4 | -70.4 | | -57.2 | -41.25 | 15.9 |
| | HT/VHT40 Beam Forming, M0 to M7, M0 to M9 1ss | 4 | 10 | -63.9 | -61.0 | -70.1 | -70.2 | -48.6 | -41.25 | 7.3 |
| | HT/VHT40 Beam Forming, M8 to M15, M0 to M9 2ss | 4 | 7 | -64.2 | -61.1 | -70.4 | -70.4 | -51.7 | -41.25 | 10.5 |
| | HT/VHT40 Beam Forming, M16 to M23, M0 to M9 3ss | 4 | 5 | -64.2 | -61.1 | -70.4 | -70.4 | -53.5 | -41.25 | 12.3 |
| | HT/VHT40 STBC, M0 to M7, M0 to M9 1ss | 2 | 4 | -70.3 | -61.9 | | | -57.3 | -41.25 | 16.1 |
| | HT/VHT40 STBC, M0 to M7, M0 to M9 1ss | 3 | 4 | -70.3 | -62.4 | -70.4 | | -57.2 | -41.25 | 15.9 |
| | HT/VHT40 STBC, M0 to M7, M0 to M9 1ss | 4 | 4 | -63.7 | -60.7 | -70.5 | -70.3 | -54.4 | -41.25 | 13.1 |
| 5775 | Non HT/VHT80, 6 to 54 Mbps | 1 | 4 | -70.4 | | | | -66.4 | -41.25 | 25.2 |
| | Non HT/VHT80, 6 to 54 Mbps | 2 | 4 | -63.4 | -61.6 | | | -55.4 | -41.25 | 14.1 |
| | Non HT/VHT80, 6 to 54 Mbps | 3 | 4 | -63.6 | -62.0 | -70.4 | | -55.4 | -41.25 | 14.1 |
| | Non HT/VHT80, 6 to 54 Mbps | 4 | 4 | -63.3 | -61.3 | -70.3 | -70.5 | -54.6 | -41.25 | 13.3 |
| | HT/VHT80, M0 to M7, M0 to M9 1ss | 1 | 4 | -70.4 | | | | -66.4 | -41.25 | 25.2 |
| | HT/VHT80, M0 to M7, M0 to M9 1ss | 2 | 4 | -64.2 | -62.0 | | | -56.0 | -41.25 | 14.7 |
| | HT/VHT80, M8 to M15, M0 to M9 2ss | 2 | 4 | -64.2 | -62.0 | | | -56.0 | -41.25 | 14.7 |
| | HT/VHT80, M0 to M7, M0 to M9 1ss | 3 | 4 | -64.0 | -61.6 | -70.3 | | -55.3 | -41.25 | 14.0 |
| | HT/VHT80, M8 to M15, M0 to M9 2ss | 3 | 4 | -64.0 | -61.6 | -70.3 | | -55.3 | -41.25 | 14.0 |
| | HT/VHT80, M16 to M23, M0 to M9 3ss | 3 | 4 | -64.0 | -61.6 | -70.3 | | -55.3 | -41.25 | 14.0 |
| | HT/VHT80, M0 to M7, M0 to M9 1ss | 4 | 4 | -63.2 | -61.5 | -70.3 | -70.2 | -54.6 | -41.25 | 13.4 |
| | HT/VHT80, M8 to M15, M0 to M9 2ss | 4 | 4 | -63.2 | -61.5 | -70.3 | -70.2 | -54.6 | -41.25 | 13.4 |
| | HT/VHT80, M16 to M23, M0 to M9 3ss | 4 | 4 | -63.2 | -61.5 | -70.3 | -70.2 | -54.6 | -41.25 | 13.4 |
| | HT/VHT80 Beam Forming, M0 to M7, M0 to M9 1ss | 2 | 7 | -63.2 | -61.5 | | | -52.3 | -41.25 | 11.0 |
| | HT/VHT80 Beam Forming, M8 to M15, M0 to M9 2ss | 2 | 4 | -64.2 | -62.0 | | | -56.0 | -41.25 | 14.7 |
| | HT/VHT80 Beam Forming, M0 to M7, M0 to M9 1ss | 3 | 9 | -63.7 | -61.3 | -70.4 | | -50.2 | -41.25 | 8.9 |
| | HT/VHT80 Beam Forming, M8 to M15, M0 to M9 2ss | 3 | 6 | -63.2 | -61.5 | -70.3 | | -53.1 | -41.25 | 11.9 |
| | HT/VHT80 Beam Forming, M16 to M23, M0 to M9 3ss | 3 | 4 | -64.0 | -61.6 | -70.3 | | -55.3 | -41.25 | 14.0 |
| | HT/VHT80 Beam Forming, M0 to M7, M0 to M9 1ss | 4 | 10 | -63.6 | -61.3 | -70.3 | -70.3 | -48.7 | -41.25 | 7.4 |
| | HT/VHT80 Beam Forming, M8 to M15, M0 to M9 2ss | 4 | 7 | -63.7 | -61.3 | -70.4 | -70.5 | -51.7 | -41.25 | 10.5 |
| | HT/VHT80 Beam Forming, M16 to M23, M0 to M9 3ss | 4 | 5 | -63.2 | -61.5 | -70.3 | -70.2 | -53.4 | -41.25 | 12.2 |
| HT/VHT80 STBC, M0 to M7, M0 to M9 1ss | 2 | 4 | -64.2 | -62.0 | | | -56.0 | -41.25 | 14.7 | |
| HT/VHT80 STBC, M0 to M7, M0 to M9 1ss | 3 | 4 | -64.0 | -61.6 | -70.3 | | -55.3 | -41.25 | 14.0 | |
| HT/VHT80 STBC, M0 to M7, M0 to M9 1ss | 4 | 4 | -63.2 | -61.5 | -70.3 | -70.2 | -54.6 | -41.25 | 13.4 | |

| | | | | | | | | | | |
|---------------------------------------|---|---|-------|-------|-------|-------|-------|--------|--------|------|
| 5785 | Non HT/VHT20, 6 to 54 Mbps | 1 | 4 | -70.1 | | | | -66.1 | -41.25 | 24.9 |
| | Non HT/VHT20, 6 to 54 Mbps | 2 | 4 | -70.1 | -70.0 | | | -63.0 | -41.25 | 21.8 |
| | Non HT/VHT20, 6 to 54 Mbps | 3 | 4 | -70.1 | -70.0 | -70.0 | | -61.3 | -41.25 | 20.0 |
| | Non HT/VHT20, 6 to 54 Mbps | 4 | 4 | -70.1 | -70.0 | -70.0 | -69.8 | -60.0 | -41.25 | 18.7 |
| | Non HT/VHT20 Beam Forming, 6 to 54 Mbps | 2 | 7 | -70.1 | -70.0 | | | -60.0 | -41.25 | 18.8 |
| | Non HT/VHT20 Beam Forming, 6 to 54 Mbps | 3 | 9 | -70.4 | -70.5 | -70.4 | | -56.9 | -41.25 | 15.6 |
| | Non HT/VHT20 Beam Forming, 6 to 54 Mbps | 4 | 10 | -70.6 | -70.6 | -70.7 | -70.6 | -54.6 | -41.25 | 13.4 |
| | HT/VHT20, M0 to M7, M0 to M9 1ss | 1 | 4 | -70.2 | | | | -66.2 | -41.25 | 25.0 |
| | HT/VHT20, M0 to M7, M0 to M9 1ss | 2 | 4 | -70.2 | -70.2 | | | -63.2 | -41.25 | 21.9 |
| | HT/VHT20, M8 to M15, M0 to M9 2ss | 2 | 4 | -70.2 | -70.2 | | | -63.2 | -41.25 | 21.9 |
| | HT/VHT20, M0 to M7, M0 to M9 1ss | 3 | 4 | -70.2 | -70.2 | -70.5 | | -61.5 | -41.25 | 20.3 |
| | HT/VHT20, M8 to M15, M0 to M9 2ss | 3 | 4 | -70.2 | -70.2 | -70.5 | | -61.5 | -41.25 | 20.3 |
| | HT/VHT20, M16 to M23, M0 to M9 3ss | 3 | 4 | -70.2 | -70.2 | -70.5 | | -61.5 | -41.25 | 20.3 |
| | HT/VHT20, M0 to M7, M0 to M9 1ss | 4 | 4 | -70.2 | -70.2 | -70.5 | -69.9 | -60.2 | -41.25 | 18.9 |
| | HT/VHT20, M8 to M15, M0 to M9 2ss | 4 | 4 | -70.2 | -70.2 | -70.5 | -69.9 | -60.2 | -41.25 | 18.9 |
| | HT/VHT20, M16 to M23, M0 to M9 3ss | 4 | 4 | -70.2 | -70.2 | -70.5 | -69.9 | -60.2 | -41.25 | 18.9 |
| | HT/VHT20 Beam Forming, M0 to M7, M0 to M9 1ss | 2 | 7 | -70.2 | -70.2 | | | -60.2 | -41.25 | 18.9 |
| | HT/VHT20 Beam Forming, M8 to M15, M0 to M9 2ss | 2 | 4 | -70.2 | -70.2 | | | -63.2 | -41.25 | 21.9 |
| | HT/VHT20 Beam Forming, M0 to M7, M0 to M9 1ss | 3 | 9 | -70.4 | -70.5 | -70.3 | | -56.8 | -41.25 | 15.6 |
| | HT/VHT20 Beam Forming, M8 to M15, M0 to M9 2ss | 3 | 6 | -70.2 | -70.2 | -70.5 | | -59.7 | -41.25 | 18.5 |
| | HT/VHT20 Beam Forming, M16 to M23, M0 to M9 3ss | 3 | 4 | -70.2 | -70.2 | -70.5 | | -61.5 | -41.25 | 20.3 |
| | HT/VHT20 Beam Forming, M0 to M7, M0 to M9 1ss | 4 | 10 | -70.6 | -70.5 | -70.5 | -70.6 | -54.5 | -41.25 | 13.3 |
| | HT/VHT20 Beam Forming, M8 to M15, M0 to M9 2ss | 4 | 7 | -70.4 | -70.5 | -70.3 | -70.3 | -57.4 | -41.25 | 16.1 |
| | HT/VHT20 Beam Forming, M16 to M23, M0 to M9 3ss | 4 | 5 | -70.2 | -70.2 | -70.5 | -69.9 | -59.0 | -41.25 | 17.7 |
| HT/VHT20 STBC, M0 to M7, M0 to M9 1ss | 2 | 4 | -70.2 | -70.2 | | | -63.2 | -41.25 | 21.9 | |
| HT/VHT20 STBC, M0 to M7, M0 to M9 1ss | 3 | 4 | -70.2 | -70.2 | -70.5 | | -61.5 | -41.25 | 20.3 | |
| HT/VHT20 STBC, M0 to M7, M0 to M9 1ss | 4 | 4 | -70.2 | -70.2 | -70.5 | -69.9 | -60.2 | -41.25 | 18.9 | |
| 5795 | Non HT/VHT40, 6 to 54 Mbps | 1 | 4 | -70.6 | | | | -66.6 | -41.25 | 25.4 |
| | Non HT/VHT40, 6 to 54 Mbps | 2 | 4 | -70.5 | -62.1 | | | -57.5 | -41.25 | 16.3 |
| | Non HT/VHT40, 6 to 54 Mbps | 3 | 4 | -64.0 | -62.1 | -70.7 | | -55.6 | -41.25 | 14.3 |
| | Non HT/VHT40, 6 to 54 Mbps | 4 | 4 | -64.0 | -62.1 | -70.7 | -70.5 | -55.2 | -41.25 | 14.0 |
| | HT/VHT40, M0 to M7, M0 to M9 1ss | 1 | 4 | -70.7 | | | | -66.7 | -41.25 | 25.5 |
| | HT/VHT40, M0 to M7, M0 to M9 1ss | 2 | 4 | -70.7 | -70.5 | | | -63.6 | -41.25 | 22.3 |
| | HT/VHT40, M8 to M15, M0 to M9 2ss | 2 | 4 | -70.7 | -70.5 | | | -63.6 | -41.25 | 22.3 |
| | HT/VHT40, M0 to M7, M0 to M9 1ss | 3 | 4 | -70.5 | -62.4 | -70.6 | | -57.2 | -41.25 | 16.0 |
| | HT/VHT40, M8 to M15, M0 to M9 2ss | 3 | 4 | -70.5 | -62.4 | -70.6 | | -57.2 | -41.25 | 16.0 |
| | HT/VHT40, M16 to M23, M0 to M9 3ss | 3 | 4 | -70.5 | -62.4 | -70.6 | | -57.2 | -41.25 | 16.0 |
| | HT/VHT40, M0 to M7, M0 to M9 1ss | 4 | 4 | -70.5 | -62.4 | -70.6 | -70.6 | -56.8 | -41.25 | 15.5 |
| | HT/VHT40, M8 to M15, M0 to M9 2ss | 4 | 4 | -70.5 | -62.4 | -70.6 | -70.6 | -56.8 | -41.25 | 15.5 |
| | HT/VHT40, M16 to M23, M0 to M9 3ss | 4 | 4 | -70.5 | -62.4 | -70.6 | -70.6 | -56.8 | -41.25 | 15.5 |

| | | | | | | | | | | |
|---------------------------------------|---|---|-------|-------|-------|-------|-------|--------|--------|------|
| | HT/VHT40 Beam Forming, M0 to M7, M0 to M9 1ss | 2 | 7 | -70.5 | -62.4 | | | -54.8 | -41.25 | 13.5 |
| | HT/VHT40 Beam Forming, M8 to M15, M0 to M9 2ss | 2 | 4 | -70.7 | -70.5 | | | -63.6 | -41.25 | 22.3 |
| | HT/VHT40 Beam Forming, M0 to M7, M0 to M9 1ss | 3 | 9 | -70.6 | -62.7 | -70.7 | | -52.7 | -41.25 | 11.4 |
| | HT/VHT40 Beam Forming, M8 to M15, M0 to M9 2ss | 3 | 6 | -70.5 | -62.4 | -70.6 | | -55.4 | -41.25 | 14.2 |
| | HT/VHT40 Beam Forming, M16 to M23, M0 to M9 3ss | 3 | 4 | -70.5 | -62.4 | -70.6 | | -57.2 | -41.25 | 16.0 |
| | HT/VHT40 Beam Forming, M0 to M7, M0 to M9 1ss | 4 | 10 | -70.6 | -62.7 | -70.7 | -70.6 | -51.0 | -41.25 | 9.7 |
| | HT/VHT40 Beam Forming, M8 to M15, M0 to M9 2ss | 4 | 7 | -70.6 | -62.7 | -70.7 | -70.6 | -54.0 | -41.25 | 12.7 |
| | HT/VHT40 Beam Forming, M16 to M23, M0 to M9 3ss | 4 | 5 | -70.5 | -62.4 | -70.6 | -70.6 | -55.6 | -41.25 | 14.3 |
| | HT/VHT40 STBC, M0 to M7, M0 to M9 1ss | 2 | 4 | -70.7 | -70.5 | | | -63.6 | -41.25 | 22.3 |
| | HT/VHT40 STBC, M0 to M7, M0 to M9 1ss | 3 | 4 | -70.5 | -62.4 | -70.6 | | -57.2 | -41.25 | 16.0 |
| | HT/VHT40 STBC, M0 to M7, M0 to M9 1ss | 4 | 4 | -70.5 | -62.4 | -70.6 | -70.6 | -56.8 | -41.25 | 15.5 |
| | | | | | | | | | | |
| 5825 | Non HT/VHT20, 6 to 54 Mbps | 1 | 4 | -71.2 | | | | -67.2 | -41.25 | 26.0 |
| | Non HT/VHT20, 6 to 54 Mbps | 2 | 4 | -71.2 | -71.0 | | | -64.1 | -41.25 | 22.8 |
| | Non HT/VHT20, 6 to 54 Mbps | 3 | 4 | -71.2 | -71.0 | -71.0 | | -62.3 | -41.25 | 21.0 |
| | Non HT/VHT20, 6 to 54 Mbps | 4 | 4 | -63.7 | -71.1 | -71.0 | -71.0 | -57.8 | -41.25 | 16.5 |
| | Non HT/VHT20 Beam Forming, 6 to 54 Mbps | 2 | 7 | -63.7 | -71.1 | | | -56.0 | -41.25 | 14.7 |
| | Non HT/VHT20 Beam Forming, 6 to 54 Mbps | 3 | 9 | -71.1 | -70.9 | -71.0 | | -57.4 | -41.25 | 16.2 |
| | Non HT/VHT20 Beam Forming, 6 to 54 Mbps | 4 | 10 | -63.9 | -62.0 | -71.1 | -71.0 | -49.2 | -41.25 | 8.0 |
| | HT/VHT20, M0 to M7, M0 to M9 1ss | 1 | 4 | -71.0 | | | | -67.0 | -41.25 | 25.8 |
| | HT/VHT20, M0 to M7, M0 to M9 1ss | 2 | 4 | -71.0 | -71.1 | | | -64.0 | -41.25 | 22.8 |
| | HT/VHT20, M8 to M15, M0 to M9 2ss | 2 | 4 | -71.0 | -71.1 | | | -64.0 | -41.25 | 22.8 |
| | HT/VHT20, M0 to M7, M0 to M9 1ss | 3 | 4 | -71.1 | -71.0 | -70.9 | | -62.2 | -41.25 | 21.0 |
| | HT/VHT20, M8 to M15, M0 to M9 2ss | 3 | 4 | -71.1 | -71.0 | -70.9 | | -62.2 | -41.25 | 21.0 |
| | HT/VHT20, M16 to M23, M0 to M9 3ss | 3 | 4 | -71.1 | -71.0 | -70.9 | | -62.2 | -41.25 | 21.0 |
| | HT/VHT20, M0 to M7, M0 to M9 1ss | 4 | 4 | -71.1 | -71.0 | -70.9 | -71.2 | -61.0 | -41.25 | 19.8 |
| | HT/VHT20, M8 to M15, M0 to M9 2ss | 4 | 4 | -71.1 | -71.0 | -70.9 | -71.2 | -61.0 | -41.25 | 19.8 |
| | HT/VHT20, M16 to M23, M0 to M9 3ss | 4 | 4 | -71.1 | -71.0 | -70.9 | -71.2 | -61.0 | -41.25 | 19.8 |
| | HT/VHT20 Beam Forming, M0 to M7, M0 to M9 1ss | 2 | 7 | -71.1 | -71.0 | | | -61.0 | -41.25 | 19.8 |
| | HT/VHT20 Beam Forming, M8 to M15, M0 to M9 2ss | 2 | 4 | -71.0 | -71.1 | | | -64.0 | -41.25 | 22.8 |
| | HT/VHT20 Beam Forming, M0 to M7, M0 to M9 1ss | 3 | 9 | -63.9 | -62.3 | -71.0 | | -50.9 | -41.25 | 9.6 |
| | HT/VHT20 Beam Forming, M8 to M15, M0 to M9 2ss | 3 | 6 | -71.1 | -71.0 | -70.9 | | -60.4 | -41.25 | 19.2 |
| | HT/VHT20 Beam Forming, M16 to M23, M0 to M9 3ss | 3 | 4 | -71.1 | -71.0 | -70.9 | | -62.2 | -41.25 | 21.0 |
| | HT/VHT20 Beam Forming, M0 to M7, M0 to M9 1ss | 4 | 10 | -64.1 | -62.6 | -71.1 | -71.1 | -49.6 | -41.25 | 8.4 |
| | HT/VHT20 Beam Forming, M8 to M15, M0 to M9 2ss | 4 | 7 | -63.9 | -62.3 | -71.0 | -71.1 | -52.4 | -41.25 | 11.1 |
| | HT/VHT20 Beam Forming, M16 to M23, M0 to M9 3ss | 4 | 5 | -71.0 | -71.0 | -70.8 | -71.1 | -59.8 | -41.25 | 18.5 |
| | HT/VHT20 STBC, M0 to M7, M0 to M9 1ss | 2 | 4 | -71.0 | -71.1 | | | -64.0 | -41.25 | 22.8 |
| | HT/VHT20 STBC, M0 to M7, M0 to M9 1ss | 3 | 4 | -71.1 | -71.0 | -70.9 | | -62.2 | -41.25 | 21.0 |
| HT/VHT20 STBC, M0 to M7, M0 to M9 1ss | 4 | 4 | -71.1 | -71.0 | -70.9 | -71.2 | -61.0 | -41.25 | 19.8 | |

| Frequency (MHz) | Mode | Tx Paths | Correlated Antenna Gain (dBi) | Tx 1 Spur Power (dBm) | Tx 2 Spur Power (dBm) | Tx 3 Spur Power (dBm) | Tx 4 Spur Power (dBm) | Total Conducted Spur (dBm) | Limit (dBm) | Margin (dB) |
|---------------------------------------|---|----------|-------------------------------|-----------------------|-----------------------|-----------------------|-----------------------|----------------------------|-------------|-------------|
| 5745 | Non HT/VHT20, 6 to 54 Mbps | 1 | 4 | -60.7 | | | | -56.7 | -21.25 | 35.5 |
| | Non HT/VHT20, 6 to 54 Mbps | 2 | 4 | -61.0 | -60.9 | | | -53.9 | -21.25 | 32.7 |
| | Non HT/VHT20, 6 to 54 Mbps | 3 | 4 | -61.0 | -60.9 | -60.2 | | -51.9 | -21.25 | 30.7 |
| | Non HT/VHT20, 6 to 54 Mbps | 4 | 4 | -61.0 | -60.8 | -62.6 | -58.2 | -50.3 | -21.25 | 29.1 |
| | Non HT/VHT20 Beam Forming, 6 to 54 Mbps | 2 | 7 | -61.0 | -60.8 | | | -50.9 | -21.25 | 29.6 |
| | Non HT/VHT20 Beam Forming, 6 to 54 Mbps | 3 | 9 | -59.0 | -60.8 | -61.0 | | -46.6 | -21.25 | 25.3 |
| | Non HT/VHT20 Beam Forming, 6 to 54 Mbps | 4 | 10 | -62.0 | -61.4 | -62.5 | -60.9 | -45.6 | -21.25 | 24.4 |
| | HT/VHT20, M0 to M7, M0 to M9 1ss | 1 | 4 | -61.3 | | | | -57.3 | -21.25 | 36.1 |
| | HT/VHT20, M0 to M7, M0 to M9 1ss | 2 | 4 | -60.9 | -62.2 | | | -54.5 | -21.25 | 33.2 |
| | HT/VHT20, M8 to M15, M0 to M9 2ss | 2 | 4 | -60.9 | -62.2 | | | -54.5 | -21.25 | 33.2 |
| | HT/VHT20, M0 to M7, M0 to M9 1ss | 3 | 4 | -60.9 | -62.2 | -60.2 | | -52.3 | -21.25 | 31.0 |
| | HT/VHT20, M8 to M15, M0 to M9 2ss | 3 | 4 | -60.9 | -62.2 | -60.2 | | -52.3 | -21.25 | 31.0 |
| | HT/VHT20, M16 to M23, M0 to M9 3ss | 3 | 4 | -60.9 | -62.2 | -60.2 | | -52.3 | -21.25 | 31.0 |
| | HT/VHT20, M0 to M7, M0 to M9 1ss | 4 | 4 | -60.9 | -62.2 | -60.2 | -62.4 | -51.3 | -21.25 | 30.1 |
| | HT/VHT20, M8 to M15, M0 to M9 2ss | 4 | 4 | -60.9 | -62.2 | -60.2 | -62.4 | -51.3 | -21.25 | 30.1 |
| | HT/VHT20, M16 to M23, M0 to M9 3ss | 4 | 4 | -60.9 | -62.2 | -60.2 | -62.4 | -51.3 | -21.25 | 30.1 |
| | HT/VHT20 Beam Forming, M0 to M7, M0 to M9 1ss | 2 | 7 | -61.1 | -62.9 | | | -51.9 | -21.25 | 30.6 |
| | HT/VHT20 Beam Forming, M8 to M15, M0 to M9 2ss | 2 | 4 | -60.9 | -62.2 | | | -54.5 | -21.25 | 33.2 |
| | HT/VHT20 Beam Forming, M0 to M7, M0 to M9 1ss | 3 | 9 | -61.1 | -62.9 | -62.1 | | -48.4 | -21.25 | 27.1 |
| | HT/VHT20 Beam Forming, M8 to M15, M0 to M9 2ss | 3 | 6 | -61.1 | -62.9 | -62.1 | | -51.4 | -21.25 | 30.1 |
| | HT/VHT20 Beam Forming, M16 to M23, M0 to M9 3ss | 3 | 4 | -60.9 | -62.2 | -60.2 | | -52.3 | -21.25 | 31.0 |
| | HT/VHT20 Beam Forming, M0 to M7, M0 to M9 1ss | 4 | 10 | -61.4 | -61.8 | -61.0 | -60.1 | -45.0 | -21.25 | 23.8 |
| | HT/VHT20 Beam Forming, M8 to M15, M0 to M9 2ss | 4 | 7 | -61.1 | -62.9 | -62.1 | -61.8 | -48.9 | -21.25 | 27.7 |
| | HT/VHT20 Beam Forming, M16 to M23, M0 to M9 3ss | 4 | 5 | -61.1 | -62.9 | -62.1 | -61.8 | -50.7 | -21.25 | 29.5 |
| | HT/VHT20 STBC, M0 to M7, M0 to M9 1ss | 2 | 4 | -60.9 | -62.2 | | | -54.5 | -21.25 | 33.2 |
| | HT/VHT20 STBC, M0 to M7, M0 to M9 1ss | 3 | 4 | -60.9 | -62.2 | -60.2 | | -52.3 | -21.25 | 31.0 |
| HT/VHT20 STBC, M0 to M7, M0 to M9 1ss | 4 | 4 | -60.9 | -62.2 | -60.2 | -62.4 | -51.3 | -21.25 | 30.1 | |
| 5755 | Non HT/VHT40, 6 to 54 Mbps | 1 | 4 | -58.0 | | | | -54.0 | -21.25 | 32.8 |
| | Non HT/VHT40, 6 to 54 Mbps | 2 | 4 | -58.0 | -61.0 | | | -52.2 | -21.25 | 31.0 |
| | Non HT/VHT40, 6 to 54 Mbps | 3 | 4 | -58.0 | -61.0 | -62.7 | | -51.4 | -21.25 | 30.1 |
| | Non HT/VHT40, 6 to 54 Mbps | 4 | 4 | -61.3 | -60.6 | -61.6 | -60.7 | -51.0 | -21.25 | 29.8 |
| | HT/VHT40, M0 to M7, M0 to M9 1ss | 1 | 4 | -60.1 | | | | -56.1 | -21.25 | 34.9 |
| | HT/VHT40, M0 to M7, M0 to M9 1ss | 2 | 4 | -61.3 | -60.8 | | | -54.0 | -21.25 | 32.8 |
| | HT/VHT40, M8 to M15, M0 to M9 2ss | 2 | 4 | -61.3 | -60.8 | | | -54.0 | -21.25 | 32.8 |

| | | | | | | | | | | |
|---------------------------------------|---|---|-------|-------|-------|-------|-------|--------|--------|------|
| | HT/VHT40, M0 to M7, M0 to M9 1ss | 3 | 4 | -59.7 | -60.8 | -61.1 | | -51.7 | -21.25 | 30.5 |
| | HT/VHT40, M8 to M15, M0 to M9 2ss | 3 | 4 | -59.7 | -60.8 | -61.1 | | -51.7 | -21.25 | 30.5 |
| | HT/VHT40, M16 to M23, M0 to M9 3ss | 3 | 4 | -59.7 | -60.8 | -61.1 | | -51.7 | -21.25 | 30.5 |
| | HT/VHT40, M0 to M7, M0 to M9 1ss | 4 | 4 | -61.7 | -62.2 | -62.8 | -61.1 | -51.9 | -21.25 | 30.6 |
| | HT/VHT40, M8 to M15, M0 to M9 2ss | 4 | 4 | -61.7 | -62.2 | -62.8 | -61.1 | -51.9 | -21.25 | 30.6 |
| | HT/VHT40, M16 to M23, M0 to M9 3ss | 4 | 4 | -61.7 | -62.2 | -62.8 | -61.1 | -51.9 | -21.25 | 30.6 |
| | HT/VHT40 Beam Forming, M0 to M7, M0 to M9 1ss | 2 | 7 | -60.9 | -59.0 | | | -49.8 | -21.25 | 28.6 |
| | HT/VHT40 Beam Forming, M8 to M15, M0 to M9 2ss | 2 | 4 | -61.3 | -60.8 | | | -54.0 | -21.25 | 32.8 |
| | HT/VHT40 Beam Forming, M0 to M7, M0 to M9 1ss | 3 | 9 | -61.1 | -61.8 | -59.2 | | -47.0 | -21.25 | 25.7 |
| | HT/VHT40 Beam Forming, M8 to M15, M0 to M9 2ss | 3 | 6 | -60.9 | -59.0 | -62.8 | | -50.1 | -21.25 | 28.8 |
| | HT/VHT40 Beam Forming, M16 to M23, M0 to M9 3ss | 3 | 4 | -59.7 | -60.8 | -61.1 | | -51.7 | -21.25 | 30.5 |
| | HT/VHT40 Beam Forming, M0 to M7, M0 to M9 1ss | 4 | 10 | -61.0 | -61.5 | -62.6 | -62.4 | -45.8 | -21.25 | 24.6 |
| | HT/VHT40 Beam Forming, M8 to M15, M0 to M9 2ss | 4 | 7 | -61.1 | -61.8 | -59.2 | -60.6 | -47.5 | -21.25 | 26.3 |
| | HT/VHT40 Beam Forming, M16 to M23, M0 to M9 3ss | 4 | 5 | -61.1 | -61.8 | -59.2 | -60.6 | -49.3 | -21.25 | 28.1 |
| | HT/VHT40 STBC, M0 to M7, M0 to M9 1ss | 2 | 4 | -61.3 | -60.8 | | | -54.0 | -21.25 | 32.8 |
| | HT/VHT40 STBC, M0 to M7, M0 to M9 1ss | 3 | 4 | -59.7 | -60.8 | -61.1 | | -51.7 | -21.25 | 30.5 |
| | HT/VHT40 STBC, M0 to M7, M0 to M9 1ss | 4 | 4 | -61.7 | -62.2 | -62.8 | -61.1 | -51.9 | -21.25 | 30.6 |
| | | | | | | | | | | |
| 5775 | Non HT/VHT80, 6 to 54 Mbps | 1 | 4 | -60.6 | | | | -56.6 | -21.25 | 35.4 |
| | Non HT/VHT80, 6 to 54 Mbps | 2 | 4 | -61.7 | -61.5 | | | -54.6 | -21.25 | 33.3 |
| | Non HT/VHT80, 6 to 54 Mbps | 3 | 4 | -59.1 | -60.4 | -60.3 | | -51.1 | -21.25 | 29.9 |
| | Non HT/VHT80, 6 to 54 Mbps | 4 | 4 | -60.0 | -61.5 | -60.4 | -61.9 | -50.9 | -21.25 | 29.6 |
| | HT/VHT80, M0 to M7, M0 to M9 1ss | 1 | 4 | -62.3 | | | | -58.3 | -21.25 | 37.1 |
| | HT/VHT80, M0 to M7, M0 to M9 1ss | 2 | 4 | -61.6 | -61.7 | | | -54.6 | -21.25 | 33.4 |
| | HT/VHT80, M8 to M15, M0 to M9 2ss | 2 | 4 | -61.6 | -61.7 | | | -54.6 | -21.25 | 33.4 |
| | HT/VHT80, M0 to M7, M0 to M9 1ss | 3 | 4 | -61.3 | -59.9 | -61.3 | | -52.0 | -21.25 | 30.8 |
| | HT/VHT80, M8 to M15, M0 to M9 2ss | 3 | 4 | -61.3 | -59.9 | -61.3 | | -52.0 | -21.25 | 30.8 |
| | HT/VHT80, M16 to M23, M0 to M9 3ss | 3 | 4 | -61.3 | -59.9 | -61.3 | | -52.0 | -21.25 | 30.8 |
| | HT/VHT80, M0 to M7, M0 to M9 1ss | 4 | 4 | -61.8 | -60.4 | -62.3 | -60.9 | -51.3 | -21.25 | 30.0 |
| | HT/VHT80, M8 to M15, M0 to M9 2ss | 4 | 4 | -61.8 | -60.4 | -62.3 | -60.9 | -51.3 | -21.25 | 30.0 |
| | HT/VHT80, M16 to M23, M0 to M9 3ss | 4 | 4 | -61.8 | -60.4 | -62.3 | -60.9 | -51.3 | -21.25 | 30.0 |
| | HT/VHT80 Beam Forming, M0 to M7, M0 to M9 1ss | 2 | 7 | -61.8 | -60.4 | | | -51.0 | -21.25 | 29.8 |
| | HT/VHT80 Beam Forming, M8 to M15, M0 to M9 2ss | 2 | 4 | -61.6 | -61.7 | | | -54.6 | -21.25 | 33.4 |
| | HT/VHT80 Beam Forming, M0 to M7, M0 to M9 1ss | 3 | 9 | -60.3 | -59.5 | -61.2 | | -46.7 | -21.25 | 25.5 |
| | HT/VHT80 Beam Forming, M8 to M15, M0 to M9 2ss | 3 | 6 | -61.8 | -60.4 | -62.3 | | -50.9 | -21.25 | 29.6 |
| | HT/VHT80 Beam Forming, M16 to M23, M0 to M9 3ss | 3 | 4 | -61.3 | -59.9 | -61.3 | | -52.0 | -21.25 | 30.8 |
| | HT/VHT80 Beam Forming, M0 to M7, M0 to M9 1ss | 4 | 10 | -62.4 | -60.4 | -59.8 | -60.8 | -44.7 | -21.25 | 23.5 |
| | HT/VHT80 Beam Forming, M8 to M15, M0 to M9 2ss | 4 | 7 | -60.3 | -59.5 | -61.2 | -60.6 | -47.3 | -21.25 | 26.1 |
| | HT/VHT80 Beam Forming, M16 to M23, M0 to M9 3ss | 4 | 5 | -61.8 | -60.4 | -62.3 | -60.9 | -50.1 | -21.25 | 28.8 |
| HT/VHT80 STBC, M0 to M7, M0 to M9 1ss | 2 | 4 | -61.6 | -61.7 | | | -54.6 | -21.25 | 33.4 | |
| HT/VHT80 STBC, M0 to M7, M0 to M9 1ss | 3 | 4 | -61.3 | -59.9 | -61.3 | | -52.0 | -21.25 | 30.8 | |
| HT/VHT80 STBC, M0 to M7, M0 to M9 1ss | 4 | 4 | -61.8 | -60.4 | -62.3 | -60.9 | -51.3 | -21.25 | 30.0 | |

| | | | | | | | | | | |
|---------------------------------------|---|----------|-----------|--------------|--------------|--------------|--------------|--------------|---------------|-------------|
| 5785 | Non HT/VHT20, 6 to 54 Mbps | 1 | 4 | -62.6 | | | | -58.6 | -21.25 | 37.4 |
| | Non HT/VHT20, 6 to 54 Mbps | 2 | 4 | -62.6 | -60.4 | | | -54.4 | -21.25 | 33.1 |
| | Non HT/VHT20, 6 to 54 Mbps | 3 | 4 | -62.6 | -60.4 | -62.2 | | -52.9 | -21.25 | 31.6 |
| | Non HT/VHT20, 6 to 54 Mbps | 4 | 4 | -62.6 | -60.4 | -62.2 | -61.1 | -51.5 | -21.25 | 30.2 |
| | Non HT/VHT20 Beam Forming, 6 to 54 Mbps | 2 | 7 | -62.6 | -60.4 | | | -51.4 | -21.25 | 30.1 |
| | Non HT/VHT20 Beam Forming, 6 to 54 Mbps | 3 | 9 | -61.7 | -60.2 | -60.2 | | -47.1 | -21.25 | 25.8 |
| | Non HT/VHT20 Beam Forming, 6 to 54 Mbps | 4 | 10 | -61.1 | -61.1 | -58.0 | -61.0 | -44.1 | -21.25 | 22.8 |
| | HT/VHT20, M0 to M7, M0 to M9 1ss | 1 | 4 | -60.6 | | | | -56.6 | -21.25 | 35.4 |
| | HT/VHT20, M0 to M7, M0 to M9 1ss | 2 | 4 | -60.6 | -61.4 | | | -54.0 | -21.25 | 32.7 |
| | HT/VHT20, M8 to M15, M0 to M9 2ss | 2 | 4 | -60.6 | -61.4 | | | -54.0 | -21.25 | 32.7 |
| | HT/VHT20, M0 to M7, M0 to M9 1ss | 3 | 4 | -60.6 | -61.4 | -62.2 | | -52.6 | -21.25 | 31.3 |
| | HT/VHT20, M8 to M15, M0 to M9 2ss | 3 | 4 | -60.6 | -61.4 | -62.2 | | -52.6 | -21.25 | 31.3 |
| | HT/VHT20, M16 to M23, M0 to M9 3ss | 3 | 4 | -60.6 | -61.4 | -62.2 | | -52.6 | -21.25 | 31.3 |
| | HT/VHT20, M0 to M7, M0 to M9 1ss | 4 | 4 | -60.6 | -61.4 | -62.2 | -60.0 | -51.0 | -21.25 | 29.7 |
| | HT/VHT20, M8 to M15, M0 to M9 2ss | 4 | 4 | -60.6 | -61.4 | -62.2 | -60.0 | -51.0 | -21.25 | 29.7 |
| | HT/VHT20, M16 to M23, M0 to M9 3ss | 4 | 4 | -60.6 | -61.4 | -62.2 | -60.0 | -51.0 | -21.25 | 29.7 |
| | HT/VHT20 Beam Forming, M0 to M7, M0 to M9 1ss | 2 | 7 | -60.6 | -61.4 | | | -51.0 | -21.25 | 29.7 |
| | HT/VHT20 Beam Forming, M8 to M15, M0 to M9 2ss | 2 | 4 | -60.6 | -61.4 | | | -54.0 | -21.25 | 32.7 |
| | HT/VHT20 Beam Forming, M0 to M7, M0 to M9 1ss | 3 | 9 | -61.8 | -62.0 | -61.8 | | -48.3 | -21.25 | 27.0 |
| | HT/VHT20 Beam Forming, M8 to M15, M0 to M9 2ss | 3 | 6 | -60.6 | -61.4 | -62.2 | | -50.8 | -21.25 | 29.5 |
| | HT/VHT20 Beam Forming, M16 to M23, M0 to M9 3ss | 3 | 4 | -60.6 | -61.4 | -62.2 | | -52.6 | -21.25 | 31.3 |
| | HT/VHT20 Beam Forming, M0 to M7, M0 to M9 1ss | 4 | 10 | -62.5 | -61.8 | -61.6 | -60.8 | -45.6 | -21.25 | 24.4 |
| | HT/VHT20 Beam Forming, M8 to M15, M0 to M9 2ss | 4 | 7 | -61.8 | -62.0 | -61.8 | -60.9 | -48.6 | -21.25 | 27.3 |
| | HT/VHT20 Beam Forming, M16 to M23, M0 to M9 3ss | 4 | 5 | -60.6 | -61.4 | -62.2 | -60.0 | -49.8 | -21.25 | 28.5 |
| HT/VHT20 STBC, M0 to M7, M0 to M9 1ss | 2 | 4 | -60.6 | -61.4 | | | -54.0 | -21.25 | 32.7 | |
| HT/VHT20 STBC, M0 to M7, M0 to M9 1ss | 3 | 4 | -60.6 | -61.4 | -62.2 | | -52.6 | -21.25 | 31.3 | |
| HT/VHT20 STBC, M0 to M7, M0 to M9 1ss | 4 | 4 | -60.6 | -61.4 | -62.2 | -60.0 | -51.0 | -21.25 | 29.7 | |
| 5795 | Non HT/VHT40, 6 to 54 Mbps | 1 | 4 | -60.0 | | | | -56.0 | -21.25 | 34.8 |
| | Non HT/VHT40, 6 to 54 Mbps | 2 | 4 | -58.8 | -62.0 | | | -53.1 | -21.25 | 31.9 |
| | Non HT/VHT40, 6 to 54 Mbps | 3 | 4 | -59.9 | -60.5 | -61.0 | | -51.7 | -21.25 | 30.4 |
| | Non HT/VHT40, 6 to 54 Mbps | 4 | 4 | -59.9 | -60.5 | -61.0 | -60.4 | -50.4 | -21.25 | 29.2 |
| | HT/VHT40, M0 to M7, M0 to M9 1ss | 1 | 4 | -61.4 | | | | -57.4 | -21.25 | 36.2 |
| | HT/VHT40, M0 to M7, M0 to M9 1ss | 2 | 4 | -61.4 | -60.3 | | | -53.8 | -21.25 | 32.6 |
| | HT/VHT40, M8 to M15, M0 to M9 2ss | 2 | 4 | -61.4 | -60.3 | | | -53.8 | -21.25 | 32.6 |
| | HT/VHT40, M0 to M7, M0 to M9 1ss | 3 | 4 | -61.1 | -62.1 | -61.8 | | -52.9 | -21.25 | 31.6 |
| | HT/VHT40, M8 to M15, M0 to M9 2ss | 3 | 4 | -61.1 | -62.1 | -61.8 | | -52.9 | -21.25 | 31.6 |
| | HT/VHT40, M16 to M23, M0 to M9 3ss | 3 | 4 | -61.1 | -62.1 | -61.8 | | -52.9 | -21.25 | 31.6 |
| | HT/VHT40, M0 to M7, M0 to M9 1ss | 4 | 4 | -61.1 | -62.1 | -61.8 | -60.6 | -51.3 | -21.25 | 30.1 |
| | HT/VHT40, M8 to M15, M0 to M9 2ss | 4 | 4 | -61.1 | -62.1 | -61.8 | -60.6 | -51.3 | -21.25 | 30.1 |
| | HT/VHT40, M16 to M23, M0 to M9 3ss | 4 | 4 | -61.1 | -62.1 | -61.8 | -60.6 | -51.3 | -21.25 | 30.1 |

| | | | | | | | | | | |
|---------------------------------------|---|---|-------|-------|-------|-------|-------|--------|--------|------|
| | HT/VHT40 Beam Forming, M0 to M7, M0 to M9 1ss | 2 | 7 | -61.1 | -62.1 | | | -51.6 | -21.25 | 30.3 |
| | HT/VHT40 Beam Forming, M8 to M15, M0 to M9 2ss | 2 | 4 | -61.4 | -60.3 | | | -53.8 | -21.25 | 32.6 |
| | HT/VHT40 Beam Forming, M0 to M7, M0 to M9 1ss | 3 | 9 | -60.6 | -61.7 | -63.0 | | -48.1 | -21.25 | 26.8 |
| | HT/VHT40 Beam Forming, M8 to M15, M0 to M9 2ss | 3 | 6 | -61.1 | -62.1 | -61.8 | | -51.1 | -21.25 | 29.8 |
| | HT/VHT40 Beam Forming, M16 to M23, M0 to M9 3ss | 3 | 4 | -61.1 | -62.1 | -61.8 | | -52.9 | -21.25 | 31.6 |
| | HT/VHT40 Beam Forming, M0 to M7, M0 to M9 1ss | 4 | 10 | -60.6 | -61.7 | -63.0 | -62.3 | -45.8 | -21.25 | 24.5 |
| | HT/VHT40 Beam Forming, M8 to M15, M0 to M9 2ss | 4 | 7 | -60.6 | -61.7 | -63.0 | -62.3 | -48.8 | -21.25 | 27.5 |
| | HT/VHT40 Beam Forming, M16 to M23, M0 to M9 3ss | 4 | 5 | -61.1 | -62.1 | -61.8 | -60.6 | -50.1 | -21.25 | 28.9 |
| | HT/VHT40 STBC, M0 to M7, M0 to M9 1ss | 2 | 4 | -61.4 | -60.3 | | | -53.8 | -21.25 | 32.6 |
| | HT/VHT40 STBC, M0 to M7, M0 to M9 1ss | 3 | 4 | -61.1 | -62.1 | -61.8 | | -52.9 | -21.25 | 31.6 |
| | HT/VHT40 STBC, M0 to M7, M0 to M9 1ss | 4 | 4 | -61.1 | -62.1 | -61.8 | -60.6 | -51.3 | -21.25 | 30.1 |
| | | | | | | | | | | |
| 5825 | Non HT/VHT20, 6 to 54 Mbps | 1 | 4 | -61.6 | | | | -57.6 | -21.25 | 36.4 |
| | Non HT/VHT20, 6 to 54 Mbps | 2 | 4 | -61.6 | -62.2 | | | -54.9 | -21.25 | 33.6 |
| | Non HT/VHT20, 6 to 54 Mbps | 3 | 4 | -61.6 | -62.2 | -60.6 | | -52.6 | -21.25 | 31.4 |
| | Non HT/VHT20, 6 to 54 Mbps | 4 | 4 | -60.3 | -61.4 | -61.6 | -60.5 | -50.9 | -21.25 | 29.6 |
| | Non HT/VHT20 Beam Forming, 6 to 54 Mbps | 2 | 7 | -60.3 | -61.4 | | | -50.8 | -21.25 | 29.6 |
| | Non HT/VHT20 Beam Forming, 6 to 54 Mbps | 3 | 9 | -61.5 | -62.1 | -60.1 | | -47.6 | -21.25 | 26.3 |
| | Non HT/VHT20 Beam Forming, 6 to 54 Mbps | 4 | 10 | -61.7 | -60.0 | -61.3 | -63.5 | -45.4 | -21.25 | 24.2 |
| | HT/VHT20, M0 to M7, M0 to M9 1ss | 1 | 4 | -62.1 | | | | -58.1 | -21.25 | 36.9 |
| | HT/VHT20, M0 to M7, M0 to M9 1ss | 2 | 4 | -62.1 | -61.7 | | | -54.9 | -21.25 | 33.6 |
| | HT/VHT20, M8 to M15, M0 to M9 2ss | 2 | 4 | -62.1 | -61.7 | | | -54.9 | -21.25 | 33.6 |
| | HT/VHT20, M0 to M7, M0 to M9 1ss | 3 | 4 | -61.2 | -61.8 | -61.5 | | -52.7 | -21.25 | 31.5 |
| | HT/VHT20, M8 to M15, M0 to M9 2ss | 3 | 4 | -61.2 | -61.8 | -61.5 | | -52.7 | -21.25 | 31.5 |
| | HT/VHT20, M16 to M23, M0 to M9 3ss | 3 | 4 | -61.2 | -61.8 | -61.5 | | -52.7 | -21.25 | 31.5 |
| | HT/VHT20, M0 to M7, M0 to M9 1ss | 4 | 4 | -61.2 | -61.8 | -61.5 | -62.0 | -51.6 | -21.25 | 30.3 |
| | HT/VHT20, M8 to M15, M0 to M9 2ss | 4 | 4 | -61.2 | -61.8 | -61.5 | -62.0 | -51.6 | -21.25 | 30.3 |
| | HT/VHT20, M16 to M23, M0 to M9 3ss | 4 | 4 | -61.2 | -61.8 | -61.5 | -62.0 | -51.6 | -21.25 | 30.3 |
| | HT/VHT20 Beam Forming, M0 to M7, M0 to M9 1ss | 2 | 7 | -61.2 | -61.8 | | | -51.5 | -21.25 | 30.2 |
| | HT/VHT20 Beam Forming, M8 to M15, M0 to M9 2ss | 2 | 4 | -62.1 | -61.7 | | | -54.9 | -21.25 | 33.6 |
| | HT/VHT20 Beam Forming, M0 to M7, M0 to M9 1ss | 3 | 9 | -60.0 | -61.3 | -61.3 | | -47.3 | -21.25 | 26.0 |
| | HT/VHT20 Beam Forming, M8 to M15, M0 to M9 2ss | 3 | 6 | -61.2 | -61.8 | -61.5 | | -50.9 | -21.25 | 29.7 |
| | HT/VHT20 Beam Forming, M16 to M23, M0 to M9 3ss | 3 | 4 | -61.2 | -61.8 | -61.5 | | -52.7 | -21.25 | 31.5 |
| | HT/VHT20 Beam Forming, M0 to M7, M0 to M9 1ss | 4 | 10 | -62.1 | -60.4 | -61.4 | -61.8 | -45.4 | -21.25 | 24.1 |
| | HT/VHT20 Beam Forming, M8 to M15, M0 to M9 2ss | 4 | 7 | -60.0 | -61.3 | -61.3 | -62.1 | -48.1 | -21.25 | 26.8 |
| | HT/VHT20 Beam Forming, M16 to M23, M0 to M9 3ss | 4 | 5 | -60.3 | -61.0 | -62.0 | -60.6 | -49.7 | -21.25 | 28.5 |
| | HT/VHT20 STBC, M0 to M7, M0 to M9 1ss | 2 | 4 | -62.1 | -61.7 | | | -54.9 | -21.25 | 33.6 |
| | HT/VHT20 STBC, M0 to M7, M0 to M9 1ss | 3 | 4 | -61.2 | -61.8 | -61.5 | | -52.7 | -21.25 | 31.5 |
| HT/VHT20 STBC, M0 to M7, M0 to M9 1ss | 4 | 4 | -61.2 | -61.8 | -61.5 | -62.0 | -51.6 | -21.25 | 30.3 | |

Conducted Spurs Average, All Antennas

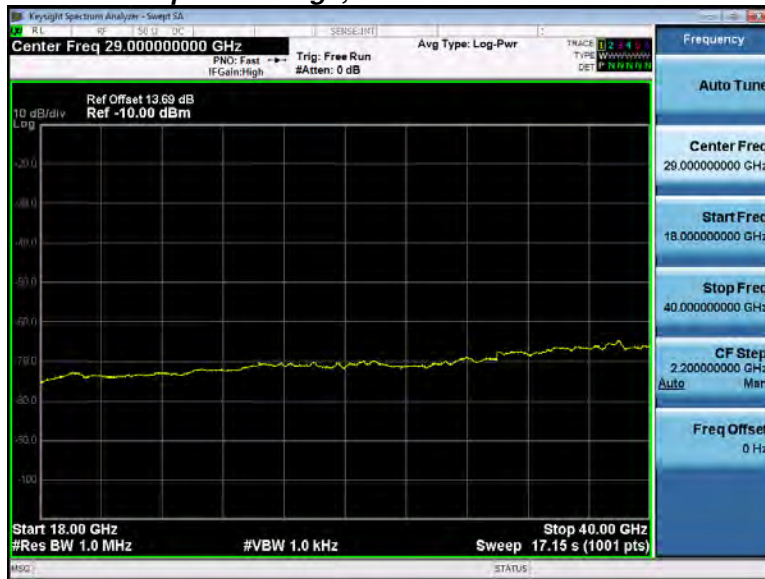

Conducted Spurs Peak, All Antennas



Conducted Spurs Average, 5755 MHz, HT/VHT40 Beam Forming, M0 to M7, M0 to M9 1ss



Antenna A



Antenna B



Antenna C



Antenna D

Conducted Spurs Peak, 5785 MHz, Non HT/VHT20 Beam Forming, 6 to 54 Mbps

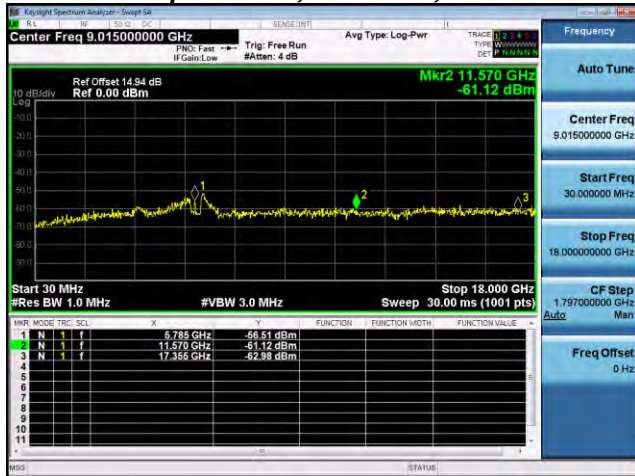

Antenna A

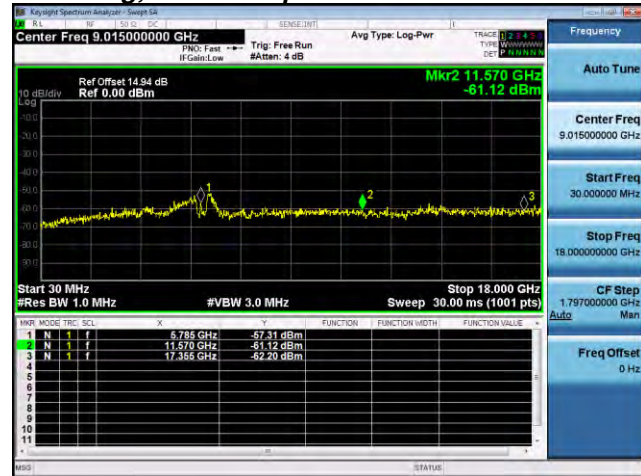

Antenna B



Antenna C

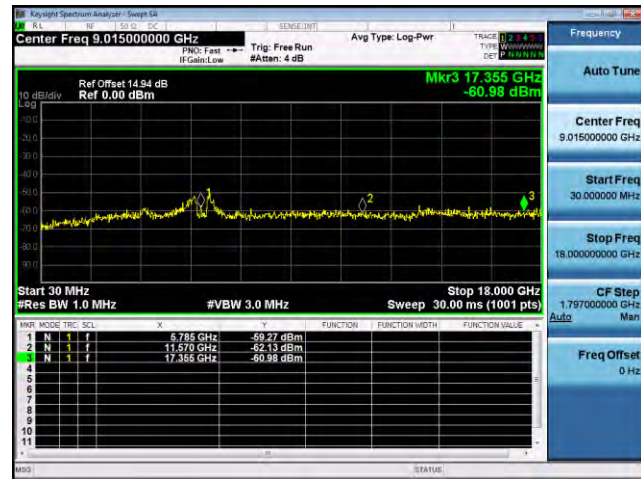

Antenna D

A.6 Conducted Bandedge

15.407 (b) *Undesirable emission limits.* Except as shown in paragraph (b) (7) of this section, the maximum emissions outside of the frequency bands of operation shall be attenuated in accordance with the following limits:

(4) For transmitters operating in the 5.725-5.85 GHz band: All emissions within the frequency range from the band edge to 10 MHz above or below the band edge shall not exceed an e.i.r.p. of -17 dBm/MHz; for frequencies 10 MHz or greater above or below the band edge, emissions shall not exceed an e.i.r.p. of -27 dBm/MHz.

(6) Unwanted emissions below 1 GHz must comply with the general field strength limits set forth in 15.209.

(7) The provisions of §15.205 apply to intentional radiators operating under this section.

(8) When measuring the emission limits, the nominal carrier frequency shall be adjusted as close to the upper and lower frequency band edges as the design of the equipment permits

Test Procedure

Ref. KDB 789033 D02 General UNII Test Procedures New Rules v01
ANSI C63.10: 2013

Conducted Bandedge

Test Procedure

1. Connect the antenna port(s) to the spectrum analyzer input.
2. Place the radio in continuous transmit mode. Use the procedures in ANSI C63.10: 2013 to substitute conducted measurements in place of radiated measurements.
3. Configure Spectrum analyzer as per test parameters below (be sure to enter all losses between the transmitter output and the spectrum analyzer).
4. Place a marker at the end of the restricted band closest to the transmit frequency to show compliance. Also measure any emissions in the restricted bands.
5. The “measure-and-sum technique” is used for measuring in-band transmit power of a device. In the measure-and-sum approach, the conducted emission level is measured at each antenna port. The measured results at the various antenna ports are then summed mathematically to determine the total emission level from the device. Summing is performed in linear power units. The worst case output is recorded.
6. Place a marker at the end of the restricted band closest to the transmit frequency to show compliance. Also measure any emissions in the restricted bands
7. Capture graphs and record pertinent measurement data.

Ref. ANSI C63.10: 2013 section 12.7.6 (peak) & 12.7.7.3 (average, Method VB-A (Alternative))

Conducted Bandedge

Test parameters restricted Band

RBW = 1 MHz
VBW \geq 3 x RBW for Peak, 100Hz for Average
Sweep = Auto couple
Detector = Peak
Trace = Max Hold.

| System Number | Description | Samples | System under test | Support equipment |
|---------------|-------------|---------|-------------------------------------|--------------------------|
| 1 | EUT | S01 | <input checked="" type="checkbox"/> | <input type="checkbox"/> |
| | | | | |

| | |
|------------------------------------|--|
| Tested By : Jose Aguirre | Date of testing: 10-Oct-15 - 11-Nov-15 |
| Test Result : PASS | |

See Appendix C for list of test equipment

| Frequency (MHz) | Mode | Tx Paths | Correlated Antenna Gain (dBi) | Tx 1 Bandedge Level (dBm) | Tx 2 Bandedge Level (dBm) | Tx 3 Bandedge Level (dBm) | Tx 4 Bandedge Level (dBm) | Total Tx Bandedge Level (dBm) | Limit (dBm) | Margin (dB) |
|---------------------------------------|---|----------|-------------------------------|---------------------------|---------------------------|---------------------------|---------------------------|-------------------------------|-------------|-------------|
| 5745 | Non HT/VHT20, 6 to 54 Mbps | 1 | 4 | -32.1 | | | | -28.1 | -27.00 | 1.1 |
| | Non HT/VHT20, 6 to 54 Mbps | 2 | 4 | -37.8 | -34.7 | | | -29.0 | -27.00 | 2.0 |
| | Non HT/VHT20, 6 to 54 Mbps | 3 | 4 | -37.8 | -34.7 | -38.9 | | -28.0 | -27.00 | 1.0 |
| | Non HT/VHT20, 6 to 54 Mbps | 4 | 4 | -37.7 | -38.7 | -39.8 | -34.3 | -27.1 | -27.00 | 0.1 |
| | Non HT/VHT20 Beam Forming, 6 to 54 Mbps | 2 | 7 | -27.1 | -28.3 | | | -17.6 | -17.00 | 0.6 |
| | Non HT/VHT20 Beam Forming, 6 to 54 Mbps | 3 | 9 | -42.2 | -44.7 | -44.2 | | -30.0 | -27.00 | 3.0 |
| | Non HT/VHT20 Beam Forming, 6 to 54 Mbps | 4 | 10 | -45.8 | -45.2 | -45.6 | -44.5 | -29.2 | -27.00 | 2.2 |
| | HT/VHT20, M0 to M7, M0 to M9 1ss | 1 | 4 | -31.0 | | | | -27.0 | -27.00 | 0.0 |
| | HT/VHT20, M0 to M7, M0 to M9 1ss | 2 | 4 | -34.7 | -38.1 | | | -29.1 | -27.00 | 2.1 |
| | HT/VHT20, M8 to M15, M0 to M9 2ss | 2 | 4 | -34.7 | -38.1 | | | -29.1 | -27.00 | 2.1 |
| | HT/VHT20, M0 to M7, M0 to M9 1ss | 3 | 4 | -34.7 | -38.1 | -40.4 | | -28.3 | -27.00 | 1.3 |
| | HT/VHT20, M8 to M15, M0 to M9 2ss | 3 | 4 | -34.7 | -38.1 | -40.4 | | -28.3 | -27.00 | 1.3 |
| | HT/VHT20, M16 to M23, M0 to M9 3ss | 3 | 4 | -34.7 | -38.1 | -40.4 | | -28.3 | -27.00 | 1.3 |
| | HT/VHT20, M0 to M7, M0 to M9 1ss | 4 | 4 | -34.7 | -38.1 | -40.4 | -37.6 | -27.2 | -27.00 | 0.2 |
| | HT/VHT20, M8 to M15, M0 to M9 2ss | 4 | 4 | -34.7 | -38.1 | -40.4 | -37.6 | -27.2 | -27.00 | 0.2 |
| | HT/VHT20, M16 to M23, M0 to M9 3ss | 4 | 4 | -34.7 | -38.1 | -40.4 | -37.6 | -27.2 | -27.00 | 0.2 |
| | HT/VHT20 Beam Forming, M0 to M7, M0 to M9 1ss | 2 | 7 | -42.2 | -42.7 | | | -32.4 | -27.00 | 5.4 |
| | HT/VHT20 Beam Forming, M8 to M15, M0 to M9 2ss | 2 | 4 | -34.7 | -38.1 | | | -29.1 | -27.00 | 2.1 |
| | HT/VHT20 Beam Forming, M0 to M7, M0 to M9 1ss | 3 | 9 | -31.3 | -34.0 | -31.7 | | -18.6 | -17.00 | 1.6 |
| | HT/VHT20 Beam Forming, M8 to M15, M0 to M9 2ss | 3 | 6 | -31.3 | -34.0 | -31.7 | | -21.6 | -17.00 | 4.6 |
| | HT/VHT20 Beam Forming, M16 to M23, M0 to M9 3ss | 3 | 4 | -34.7 | -38.1 | -40.4 | | -28.3 | -27.00 | 1.3 |
| | HT/VHT20 Beam Forming, M0 to M7, M0 to M9 1ss | 4 | 10 | -44.1 | -44.2 | -45.9 | -44.4 | -28.6 | -27.00 | 1.6 |
| | HT/VHT20 Beam Forming, M8 to M15, M0 to M9 2ss | 4 | 7 | -31.3 | -34.0 | -31.7 | -33.7 | -19.5 | -17.00 | 2.5 |
| | HT/VHT20 Beam Forming, M16 to M23, M0 to M9 3ss | 4 | 5 | -31.3 | -34.0 | -31.7 | -33.7 | -21.3 | -17.00 | 4.3 |
| HT/VHT20 STBC, M0 to M7, M0 to M9 1ss | 2 | 4 | -34.7 | -38.1 | | | -29.1 | -27.00 | 2.1 | |
| HT/VHT20 STBC, M0 to M7, M0 to M9 1ss | 3 | 4 | -34.7 | -38.1 | -40.4 | | -28.3 | -27.00 | 1.3 | |
| HT/VHT20 STBC, M0 to M7, M0 to M9 1ss | 4 | 4 | -34.7 | -38.1 | -40.4 | -37.6 | -27.2 | -27.00 | 0.2 | |
| 5755 | Non HT/VHT40, 6 to 54 Mbps | 1 | 4 | -34.5 | | | | -30.5 | -27.00 | 3.5 |
| | Non HT/VHT40, 6 to 54 Mbps | 2 | 4 | -34.5 | -37.6 | | | -28.8 | -27.00 | 1.8 |
| | Non HT/VHT40, 6 to 54 Mbps | 3 | 4 | -34.5 | -37.6 | -36.2 | | -27.1 | -27.00 | 0.1 |
| | Non HT/VHT40, 6 to 54 Mbps | 4 | 4 | -39.3 | -41.5 | -40.2 | -36.8 | -29.1 | -27.00 | 2.1 |
| | HT/VHT40, M0 to M7, M0 to M9 1ss | 1 | 4 | -31.2 | | | | -27.2 | -27.00 | 0.2 |
| | HT/VHT40, M0 to M7, M0 to M9 1ss | 2 | 4 | -33.6 | -35.3 | | | -27.4 | -27.00 | 0.4 |

| | | | | | | | | | | |
|------|---|---|----|-------|-------|-------|-------|-------|--------|-----|
| | HT/VHT40, M8 to M15, M0 to M9 2ss | 2 | 4 | -33.6 | -35.3 | | | -27.4 | -27.00 | 0.4 |
| | HT/VHT40, M0 to M7, M0 to M9 1ss | 3 | 4 | -35.3 | -37.6 | -35.2 | | -27.1 | -27.00 | 0.1 |
| | HT/VHT40, M8 to M15, M0 to M9 2ss | 3 | 4 | -35.3 | -37.6 | -35.2 | | -27.1 | -27.00 | 0.1 |
| | HT/VHT40, M16 to M23, M0 to M9 3ss | 3 | 4 | -35.3 | -37.6 | -35.2 | | -27.1 | -27.00 | 0.1 |
| | HT/VHT40, M0 to M7, M0 to M9 1ss | 4 | 4 | -39.8 | -39.2 | -36.6 | -37.7 | -28.1 | -27.00 | 1.1 |
| | HT/VHT40, M8 to M15, M0 to M9 2ss | 4 | 4 | -39.8 | -39.2 | -36.6 | -37.7 | -28.1 | -27.00 | 1.1 |
| | HT/VHT40, M16 to M23, M0 to M9 3ss | 4 | 4 | -39.8 | -39.2 | -36.6 | -37.7 | -28.1 | -27.00 | 1.1 |
| | HT/VHT40 Beam Forming, M0 to M7, M0 to M9 1ss | 2 | 7 | -37.0 | -38.1 | | | -27.5 | -27.00 | 0.5 |
| | HT/VHT40 Beam Forming, M8 to M15, M0 to M9 2ss | 2 | 4 | -33.6 | -35.3 | | | -27.4 | -27.00 | 0.4 |
| | HT/VHT40 Beam Forming, M0 to M7, M0 to M9 1ss | 3 | 9 | -42.2 | -40.5 | -39.6 | | -27.1 | -27.00 | 0.1 |
| | HT/VHT40 Beam Forming, M8 to M15, M0 to M9 2ss | 3 | 6 | -37.0 | -38.1 | -37.8 | | -27.0 | -27.00 | 0.0 |
| | HT/VHT40 Beam Forming, M16 to M23, M0 to M9 3ss | 3 | 4 | -35.3 | -37.6 | -35.2 | | -27.1 | -27.00 | 0.1 |
| | HT/VHT40 Beam Forming, M0 to M7, M0 to M9 1ss | 4 | 10 | -44.8 | -44.6 | -42.2 | -44.2 | -27.8 | -27.00 | 0.8 |
| | HT/VHT40 Beam Forming, M8 to M15, M0 to M9 2ss | 4 | 7 | -42.2 | -40.5 | -39.6 | -40.5 | -27.6 | -27.00 | 0.6 |
| | HT/VHT40 Beam Forming, M16 to M23, M0 to M9 3ss | 4 | 5 | -42.2 | -40.5 | -39.6 | -40.5 | -29.4 | -27.00 | 2.4 |
| | HT/VHT40 STBC, M0 to M7, M0 to M9 1ss | 2 | 4 | -33.6 | -35.3 | | | -27.4 | -27.00 | 0.4 |
| | HT/VHT40 STBC, M0 to M7, M0 to M9 1ss | 3 | 4 | -35.3 | -37.6 | -35.2 | | -27.1 | -27.00 | 0.1 |
| | HT/VHT40 STBC, M0 to M7, M0 to M9 1ss | 4 | 4 | -39.8 | -39.2 | -36.6 | -37.7 | -28.1 | -27.00 | 1.1 |
| | | | | | | | | | | |
| 5775 | Non HT/VHT80, 6 to 54 Mbps | 1 | 4 | -31.4 | | | | -27.4 | -27.00 | 0.4 |
| | Non HT/VHT80, 6 to 54 Mbps | 2 | 4 | -37.9 | -34.1 | | | -28.6 | -27.00 | 1.6 |
| | Non HT/VHT80, 6 to 54 Mbps | 3 | 4 | -36.8 | -38.2 | -35.2 | | -27.8 | -27.00 | 0.8 |
| | Non HT/VHT80, 6 to 54 Mbps | 4 | 4 | -39.5 | -34.7 | -39.1 | -39.3 | -27.6 | -27.00 | 0.6 |
| | HT/VHT80, M0 to M7, M0 to M9 1ss | 1 | 4 | -31.8 | | | | -27.8 | -27.00 | 0.8 |
| | HT/VHT80, M0 to M7, M0 to M9 1ss | 2 | 4 | -36.4 | -34.7 | | | -28.5 | -27.00 | 1.5 |
| | HT/VHT80, M8 to M15, M0 to M9 2ss | 2 | 4 | -36.4 | -34.7 | | | -28.5 | -27.00 | 1.5 |
| | HT/VHT80, M0 to M7, M0 to M9 1ss | 3 | 4 | -37.4 | -36.6 | -34.9 | | -27.4 | -27.00 | 0.4 |
| | HT/VHT80, M8 to M15, M0 to M9 2ss | 3 | 4 | -37.4 | -36.6 | -34.9 | | -27.4 | -27.00 | 0.4 |
| | HT/VHT80, M16 to M23, M0 to M9 3ss | 3 | 4 | -37.4 | -36.6 | -34.9 | | -27.4 | -27.00 | 0.4 |
| | HT/VHT80, M0 to M7, M0 to M9 1ss | 4 | 4 | -39.3 | -40.4 | -39.1 | -38.7 | -29.3 | -27.00 | 2.3 |
| | HT/VHT80, M8 to M15, M0 to M9 2ss | 4 | 4 | -39.3 | -40.4 | -39.1 | -38.7 | -29.3 | -27.00 | 2.3 |
| | HT/VHT80, M16 to M23, M0 to M9 3ss | 4 | 4 | -39.3 | -40.4 | -39.1 | -38.7 | -29.3 | -27.00 | 2.3 |
| | HT/VHT80 Beam Forming, M0 to M7, M0 to M9 1ss | 2 | 7 | -39.3 | -40.4 | | | -29.8 | -27.00 | 2.8 |
| | HT/VHT80 Beam Forming, M8 to M15, M0 to M9 2ss | 2 | 4 | -36.4 | -34.7 | | | -28.5 | -27.00 | 1.5 |
| | HT/VHT80 Beam Forming, M0 to M7, M0 to M9 1ss | 3 | 9 | -42.5 | -42.3 | -40.4 | | -28.1 | -27.00 | 1.1 |
| | HT/VHT80 Beam Forming, M8 to M15, M0 to M9 2ss | 3 | 6 | -39.3 | -40.4 | -39.1 | | -29.0 | -27.00 | 2.0 |
| | HT/VHT80 Beam Forming, M16 to M23, M0 to M9 3ss | 3 | 4 | -37.4 | -36.6 | -34.9 | | -27.4 | -27.00 | 0.4 |
| | HT/VHT80 Beam Forming, M0 to M7, M0 to M9 1ss | 4 | 10 | -44.2 | -43.0 | -43.2 | -42.8 | -27.2 | -27.00 | 0.2 |
| | HT/VHT80 Beam Forming, M8 to M15, M0 to M9 2ss | 4 | 7 | -42.5 | -42.3 | -40.4 | -41.4 | -28.5 | -27.00 | 1.5 |
| | HT/VHT80 Beam Forming, M16 to M23, M0 to M9 3ss | 4 | 5 | -39.3 | -40.4 | -39.1 | -38.7 | -28.1 | -27.00 | 1.1 |
| | HT/VHT80 STBC, M0 to M7, M0 to M9 1ss | 2 | 4 | -36.4 | -34.7 | | | -28.5 | -27.00 | 1.5 |
| | HT/VHT80 STBC, M0 to M7, M0 to M9 1ss | 3 | 4 | -37.4 | -36.6 | -34.9 | | -27.4 | -27.00 | 0.4 |

| | | | | | | | | | | |
|--|---|----------|--------------|--------------|--------------|--------------|--------------|---------------|------------|-----|
| | HT/VHT80 STBC, M0 to M7, M0 to M9 1ss | 4 | 4 | -39.3 | -40.4 | -39.1 | -38.7 | -29.3 | -27.00 | 2.3 |
| 5795 | Non HT/VHT40, 6 to 54 Mbps | 1 | 4 | -31.4 | | | | -27.4 | -27.00 | 0.4 |
| | Non HT/VHT40, 6 to 54 Mbps | 2 | 4 | -33.9 | -37.9 | | | -28.4 | -27.00 | 1.4 |
| | Non HT/VHT40, 6 to 54 Mbps | 3 | 4 | -34.6 | -41.9 | -43.2 | | -29.4 | -27.00 | 2.4 |
| | Non HT/VHT40, 6 to 54 Mbps | 4 | 4 | -34.6 | -41.9 | -43.2 | -40.6 | -28.6 | -27.00 | 1.6 |
| | HT/VHT40, M0 to M7, M0 to M9 1ss | 1 | 4 | -32.8 | | | | -28.8 | -27.00 | 1.8 |
| | HT/VHT40, M0 to M7, M0 to M9 1ss | 2 | 4 | -32.8 | -36.0 | | | -27.1 | -27.00 | 0.1 |
| | HT/VHT40, M8 to M15, M0 to M9 2ss | 2 | 4 | -32.8 | -36.0 | | | -27.1 | -27.00 | 0.1 |
| | HT/VHT40, M0 to M7, M0 to M9 1ss | 3 | 4 | -35.3 | -42.9 | -39.4 | | -29.4 | -27.00 | 2.4 |
| | HT/VHT40, M8 to M15, M0 to M9 2ss | 3 | 4 | -35.3 | -42.9 | -39.4 | | -29.4 | -27.00 | 2.4 |
| | HT/VHT40, M16 to M23, M0 to M9 3ss | 3 | 4 | -35.3 | -42.9 | -39.4 | | -29.4 | -27.00 | 2.4 |
| | HT/VHT40, M0 to M7, M0 to M9 1ss | 4 | 4 | -35.3 | -42.9 | -39.4 | -38.6 | -28.2 | -27.00 | 1.2 |
| | HT/VHT40, M8 to M15, M0 to M9 2ss | 4 | 4 | -35.3 | -42.9 | -39.4 | -38.6 | -28.2 | -27.00 | 1.2 |
| | HT/VHT40, M16 to M23, M0 to M9 3ss | 4 | 4 | -35.3 | -42.9 | -39.4 | -38.6 | -28.2 | -27.00 | 1.2 |
| | HT/VHT40 Beam Forming, M0 to M7, M0 to M9 1ss | 2 | 7 | -35.3 | -42.9 | | | -27.6 | -27.00 | 0.6 |
| | HT/VHT40 Beam Forming, M8 to M15, M0 to M9 2ss | 2 | 4 | -32.8 | -36.0 | | | -27.1 | -27.00 | 0.1 |
| | HT/VHT40 Beam Forming, M0 to M7, M0 to M9 1ss | 3 | 9 | -42.5 | -45.5 | -44.1 | | -30.3 | -27.00 | 3.3 |
| | HT/VHT40 Beam Forming, M8 to M15, M0 to M9 2ss | 3 | 6 | -35.3 | -42.9 | -39.4 | | -27.6 | -27.00 | 0.6 |
| | HT/VHT40 Beam Forming, M16 to M23, M0 to M9 3ss | 3 | 4 | -35.3 | -42.9 | -39.4 | | -29.4 | -27.00 | 2.4 |
| | HT/VHT40 Beam Forming, M0 to M7, M0 to M9 1ss | 4 | 10 | -42.5 | -45.5 | -44.1 | -43.9 | -27.8 | -27.00 | 0.8 |
| | HT/VHT40 Beam Forming, M8 to M15, M0 to M9 2ss | 4 | 7 | -42.5 | -45.5 | -44.1 | -43.9 | -30.8 | -27.00 | 3.8 |
| HT/VHT40 Beam Forming, M16 to M23, M0 to M9 3ss | 4 | 5 | -35.3 | -42.9 | -39.4 | -38.6 | -27.0 | -27.00 | 0.0 | |
| HT/VHT40 STBC, M0 to M7, M0 to M9 1ss | 2 | 4 | -32.8 | -36.0 | | | -27.1 | -27.00 | 0.1 | |
| HT/VHT40 STBC, M0 to M7, M0 to M9 1ss | 3 | 4 | -35.3 | -42.9 | -39.4 | | -29.4 | -27.00 | 2.4 | |
| HT/VHT40 STBC, M0 to M7, M0 to M9 1ss | 4 | 4 | -35.3 | -42.9 | -39.4 | -38.6 | -28.2 | -27.00 | 1.2 | |
| 5825 | Non HT/VHT20, 6 to 54 Mbps | 1 | 4 | -33.4 | | | | -29.4 | -27.00 | 2.4 |
| | Non HT/VHT20, 6 to 54 Mbps | 2 | 4 | -33.4 | -40.7 | | | -28.7 | -27.00 | 1.7 |
| | Non HT/VHT20, 6 to 54 Mbps | 3 | 4 | -33.4 | -40.7 | -39.6 | | -27.9 | -27.00 | 0.9 |
| | Non HT/VHT20, 6 to 54 Mbps | 4 | 4 | -34.8 | -42.5 | -40.2 | -38.7 | -28.1 | -27.00 | 1.1 |
| | Non HT/VHT20 Beam Forming, 6 to 54 Mbps | 2 | 7 | -34.8 | -42.5 | | | -27.1 | -27.00 | 0.1 |
| | Non HT/VHT20 Beam Forming, 6 to 54 Mbps | 3 | 9 | -40.6 | -41.5 | -42.4 | | -27.9 | -27.00 | 0.9 |
| | Non HT/VHT20 Beam Forming, 6 to 54 Mbps | 4 | 10 | -44.7 | -44.3 | -46.1 | -46.9 | -29.4 | -27.00 | 2.4 |
| | HT/VHT20, M0 to M7, M0 to M9 1ss | 1 | 4 | -32.9 | | | | -28.9 | -27.00 | 1.9 |
| | HT/VHT20, M0 to M7, M0 to M9 1ss | 2 | 4 | -32.9 | -36.9 | | | -27.4 | -27.00 | 0.4 |
| | HT/VHT20, M8 to M15, M0 to M9 2ss | 2 | 4 | -32.9 | -36.9 | | | -27.4 | -27.00 | 0.4 |
| | HT/VHT20, M0 to M7, M0 to M9 1ss | 3 | 4 | -35.6 | -39.7 | -40.9 | | -29.3 | -27.00 | 2.3 |
| | HT/VHT20, M8 to M15, M0 to M9 2ss | 3 | 4 | -35.6 | -39.7 | -40.9 | | -29.3 | -27.00 | 2.3 |
| | HT/VHT20, M16 to M23, M0 to M9 3ss | 3 | 4 | -35.6 | -39.7 | -40.9 | | -29.3 | -27.00 | 2.3 |
| | HT/VHT20, M0 to M7, M0 to M9 1ss | 4 | 4 | -35.6 | -39.7 | -40.9 | -36.3 | -27.6 | -27.00 | 0.6 |
| HT/VHT20, M8 to M15, M0 to M9 2ss | 4 | 4 | -35.6 | -39.7 | -40.9 | -36.3 | -27.6 | -27.00 | 0.6 | |

| | | | | | | | | | |
|---|---|----|-------|-------|-------|-------|-------|--------|-----|
| HT/VHT20, M16 to M23, M0 to M9 3ss | 4 | 4 | -35.6 | -39.7 | -40.9 | -36.3 | -27.6 | -27.00 | 0.6 |
| HT/VHT20 Beam Forming, M0 to M7, M0 to M9 1ss | 2 | 7 | -35.6 | -39.7 | | | -27.2 | -27.00 | 0.2 |
| HT/VHT20 Beam Forming, M8 to M15, M0 to M9 2ss | 2 | 4 | -32.9 | -36.9 | | | -27.4 | -27.00 | 0.4 |
| HT/VHT20 Beam Forming, M0 to M7, M0 to M9 1ss | 3 | 9 | -40.8 | -41.6 | -42.9 | | -28.1 | -27.00 | 1.1 |
| HT/VHT20 Beam Forming, M8 to M15, M0 to M9 2ss | 3 | 6 | -35.6 | -39.7 | -40.9 | | -27.5 | -27.00 | 0.5 |
| HT/VHT20 Beam Forming, M16 to M23, M0 to M9 3ss | 3 | 4 | -35.6 | -39.7 | -40.9 | | -29.3 | -27.00 | 2.3 |
| HT/VHT20 Beam Forming, M0 to M7, M0 to M9 1ss | 4 | 10 | -42.7 | -42.5 | -44.1 | -44.3 | -27.3 | -27.00 | 0.3 |
| HT/VHT20 Beam Forming, M8 to M15, M0 to M9 2ss | 4 | 7 | -40.8 | -41.6 | -42.9 | -41.1 | -28.5 | -27.00 | 1.5 |
| HT/VHT20 Beam Forming, M16 to M23, M0 to M9 3ss | 4 | 5 | -37.6 | -38.6 | -42.7 | -36.6 | -27.1 | -27.00 | 0.1 |
| HT/VHT20 STBC, M0 to M7, M0 to M9 1ss | 2 | 4 | -32.9 | -36.9 | | | -27.4 | -27.00 | 0.4 |
| HT/VHT20 STBC, M0 to M7, M0 to M9 1ss | 3 | 4 | -35.6 | -39.7 | -40.9 | | -29.3 | -27.00 | 2.3 |
| HT/VHT20 STBC, M0 to M7, M0 to M9 1ss | 4 | 4 | -35.6 | -39.7 | -40.9 | -36.3 | -27.6 | -27.00 | 0.6 |

Conducted Bandedge Peak, 5745 MHz, HT/VHT20, M0 to M7, M0 to M9 1ss



Antenna A

Conducted Bandedge Peak, 5795 MHz, HT/VHT40 Beam Forming, M16 to M23, M0 to M9 3ss



Antenna A

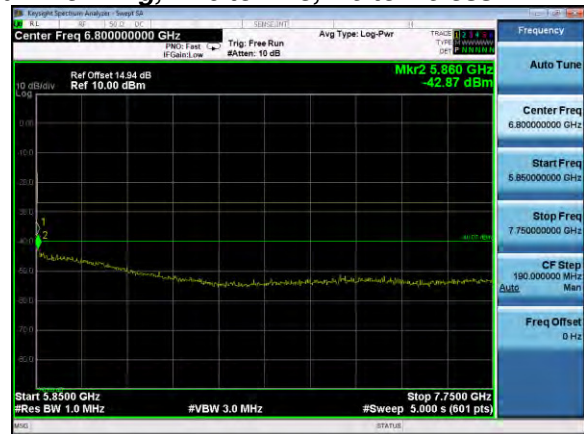

Antenna B



Antenna C



Antenna D

Appendix B: Emission Test Results

Testing Laboratory: Cisco Systems, Inc., 170 West Tasman Drive, San Jose, CA 95134, USA

Radiated Emission Setup Diagram-Below 1G

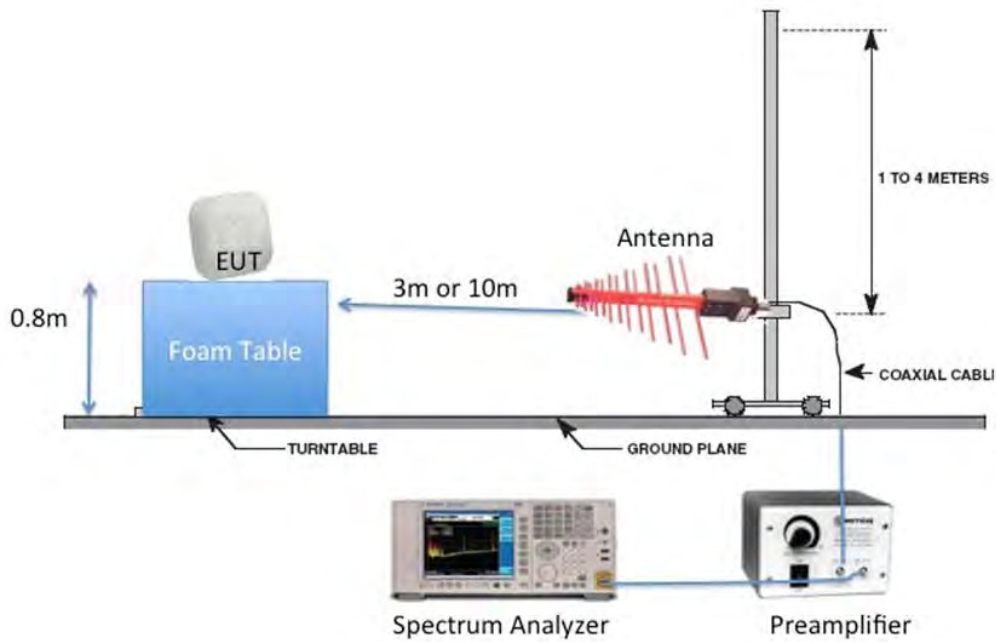

Radiated Emission Setup Diagram-Above 1G

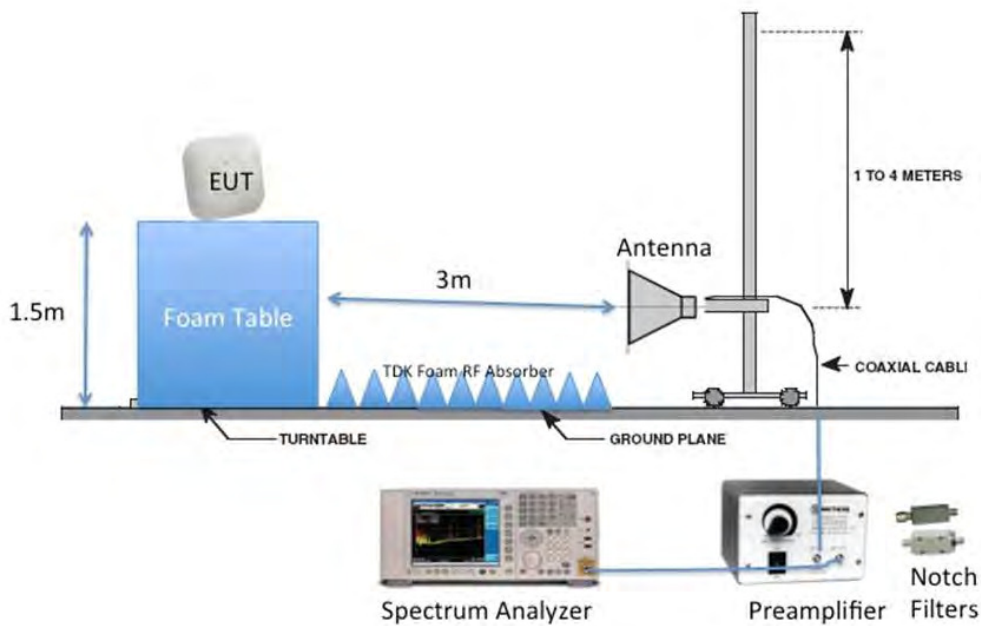

B.1 Radiated Spurious Emissions

15.407(b) Undesirable emission limits. Except as shown in paragraph (b)(7) of this section, the maximum emissions outside of the frequency bands of operation shall be attenuated in accordance with the following limits:

- (4) For transmitters operating in the 5.725-5.85 GHz band: All emissions within the frequency range from the band edge to 10 MHz above or below the band edge shall not exceed an e.i.r.p. of -17 dBm/MHz; for frequencies 10 MHz or greater above or below the band edge, emissions shall not exceed an e.i.r.p. of -27 dBm/MHz.
- (6) Unwanted emissions below 1 GHz must comply with the general field strength limits set forth in §15.209.
- (7) The provisions of §15.205 apply to intentional radiators operating under this section.
- (8) When measuring the emission limits, the nominal carrier frequency shall be adjusted as close to the upper and lower frequency band edges as the design of the equipment permits

Ref. ANSI C63.10: 2013 section 12.7.6 & 12.7.7.3 & 6.6

Using Vasona, configure the spectrum analyzer as shown below (be sure to enter all losses between the transmitter output and the spectrum analyzer). Place the radio in continuous transmit mode.

| | |
|-----------------------|-----------------------------------|
| Span: | 1GHz – 18 GHz |
| Reference Level: | 80 dBuV |
| Attenuation: | 10 dB |
| Sweep Time: | Coupled |
| Resolution Bandwidth: | 1MHz |
| Video Bandwidth: | 1 MHz for peak, 1 kHz for average |
| Detector: | Peak |

Terminate the access Point RF ports with 50 ohm loads.

Maximize Turntable (find worst case table angle), Maximize Antenna (find worst case height)

Save 2 plots: 1) Average Plot (Vertical and Horizontal), Limit= 54dBuV/m @3m
2) Peak plot (Vertical and Horizontal), Limit = 74dBuV/m @3m

Place a marker at the end of the restricted band closest to the transmit frequency to show compliance. Also measure any emissions in the restricted bands.

This report represents the worst case data for all supported operating modes and antennas. There are no measurable emissions above 18 GHz.

| System # | Description | Samples |
|----------|-------------|---------|
| 1 | EUT | S01 |

| | |
|------------------------------------|--|
| Tested By : Jose Aguirre | Date of testing: 27-Oct-2015 |
| Test Result : PASS | |

See Appendix C for list of test equipment

B.1.A Transmitter Radiated Spurious Emissions-Average Worst Case

| Frequency (MHz) | Mode | Data Rate (Mbps) | Spurious Emission Level (dBuV/m) | Limit (dBuV/m) | Margin (dB) |
|-----------------|-----------------------------------|------------------|----------------------------------|----------------|-------------|
| 5745 | 6 to 54 Mbps | 6 | 48.5 | 54 | 5.5 |
| 5755 | HT/VHT40, M0 to M23, M0.0 to M9.4 | m0 | 48.8 | 54 | 5.2 |
| 5775 | HT/VHT80, M0 to M23, M0.0 to M9.4 | m0x1 | 48.7 | 54 | 5.3 |
| 5785 | 6 to 54 Mbps | 6 | 48.4 | 54 | 5.6 |
| 5795 | HT/VHT40, M0 to M23, M0.0 to M9.4 | m0 | 48.4 | 54 | 5.6 |
| 5825 | 6 to 54 Mbps | 6 | 48.4 | 54 | 5.6 |

B.1.A.1 Radiated Transmitter Spurs, 5745 MHz, 6 to 54 Mbps, Average (1-18GHz)



B.1.A.2 Radiated Transmitter Spurs, 5755 MHz , HT/VHT40, M0 to M23, M0.0 to M9.4, Average (1-18GHz)

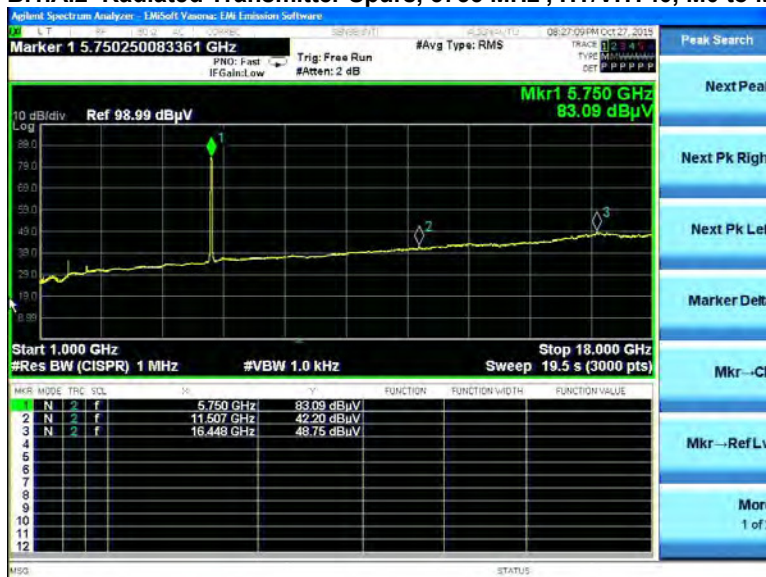

B.1.A.3 Radiated Transmitter Spurs, 5775 MHz , HT/VHT80, M0 to M23, M0.0 to M9.4, Average (1-18GHz)



B.1.A.4 Radiated Transmitter Spurs, 5785 MHz, 6 to 54 Mbps, Average (1-18GHz)



B.1.A.5 Radiated Transmitter Spurs, 5795 MHz , HT/VHT40, M0 to M23, M0.0 to M9.4, Average (1-18GHz)



B.1.A.6 Radiated Transmitter Spurs, 5825MHz, 6 to 54 Mbps, Average (1-18GHz)



B.1.A.7 Radiated Transmitter Spurs, All rate, All modes, Average (18GHz – 26.5GHz)



B.1.A.8 Radiated Transmitter Spurs, All rate, All modes, Average (26.5GHz – 40GHz)



B.1.P Transmitter Radiated Spurious Emissions-Peak Worst Case

| Frequency (MHz) | Mode | Data Rate (Mbps) | Spurious Emission Level (dBuV/m) | Limit (dBuV/m) | Margin (dB) |
|-----------------|-----------------------------------|------------------|----------------------------------|----------------|-------------|
| 5745 | 6 to 54 Mbps | 6 | 58.7 | 74 | 15.3 |
| 5755 | HT/VHT40, M0 to M23, M0.0 to M9.4 | m0 | 58.8 | 74 | 15.2 |
| 5775 | HT/VHT40, M0 to M23, M0.0 to M9.4 | m0x1 | 57.3 | 74 | 16.7 |
| 5785 | 6 to 54 Mbps | 6 | 59.0 | 74 | 15.0 |
| 5795 | HT/VHT40, M0 to M23, M0.0 to M9.4 | m0 | 57.7 | 74 | 16.3 |
| 5825 | 6 to 54 Mbps | 6 | 57.5 | 74 | 16.5 |

B.1.P.1 Radiated Transmitter Spurs, 5745 MHz, 6 to 54 Mbps, Peak (1-18GHz)



B.1.P.2 Radiated Transmitter Spurs, 5755 MHz , HT/VHT40, M0 to M23, M0.0 to M9.4, Peak (1-18GHz)



B.1.P.3 Radiated Transmitter Spurs, 5775 MHz, HT/VHT40, M0 to M23, M0.0 to M9.4, Peak (1-18GHz)

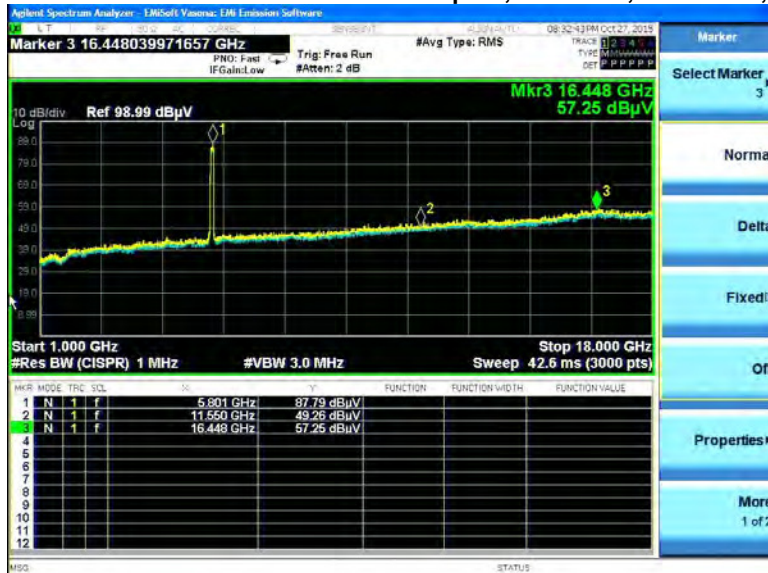

B.1.P.4 Radiated Transmitter Spurs, 5785 MHz , 6 to 54 Mbps, Peak (1-18GHz)

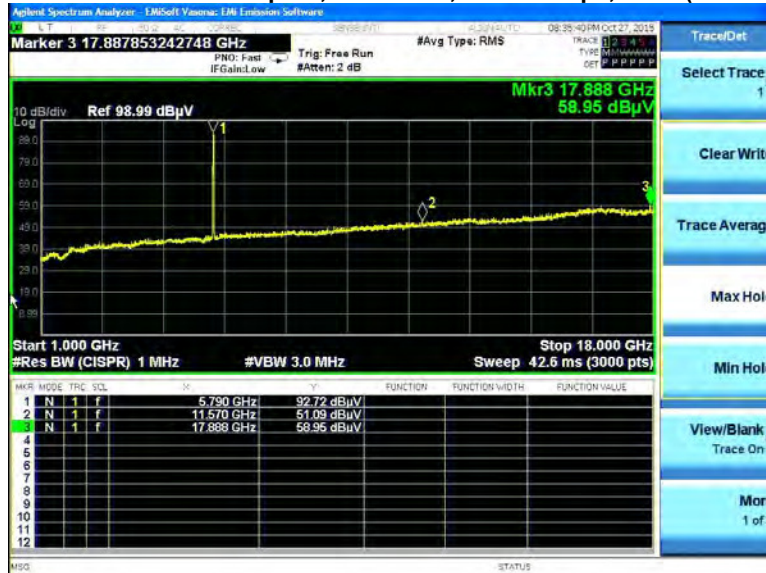

B.1.P.5 Radiated Transmitter Spurs, 5795 MHz, HT/VHT40, M0 to M23, M0.0 to M9.4, Peak (1-18GHz)

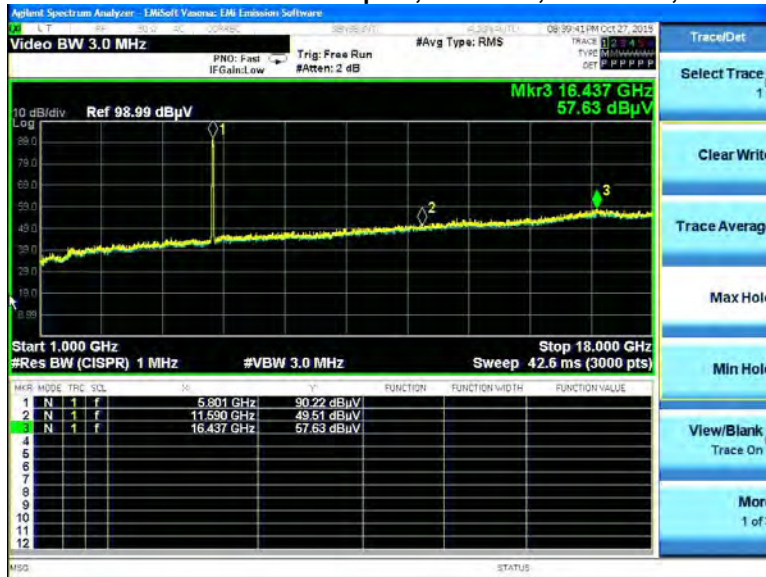

B.1.P.6 Radiated Transmitter Spurs, 5825 MHz, 6 to 54 Mbps, Peak (1-18GHz)



B.1.P.7 Radiated Transmitter Spurs, All rate, All modes, Peak (18GHz – 26.5GHz)

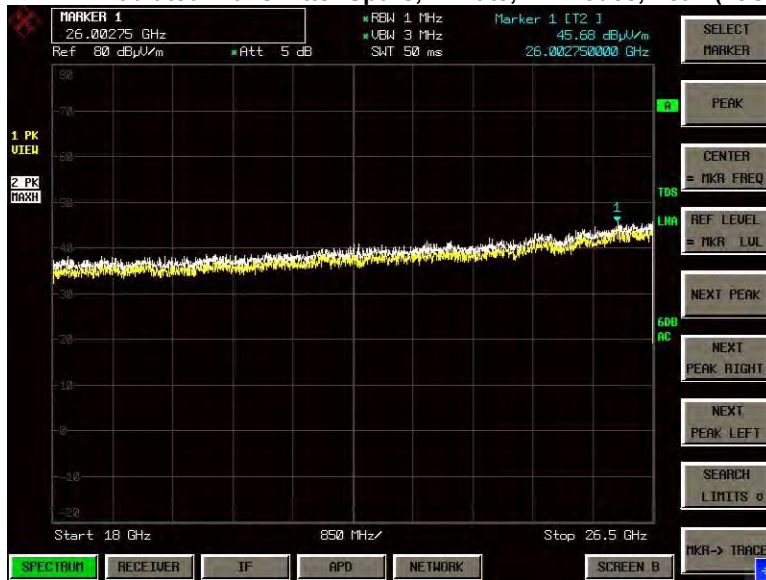

B.1.P.8 Radiated Transmitter Spurs, All rate, All modes, Peak (26.5-40GHz)



B.2 Radiated Emissions 30MHz to 1GHz

15.209 / 15.205 / 15.407:

Radiated emissions which fall in the restricted bands, as defined in Section 15.205(a), must also comply with the radiated emission limits specified in Section 15.209(a) (see Section 15.205(c)).

Ref. ANSI C63.10: 2013 section 6.5

Using Vsona, configure the spectrum analyzer as shown below (be sure to enter all losses between the transmitter output and the spectrum analyzer). Place the radio in continuous transmit mode.

Span: 30MHz – 1GHz
 Reference Level: 80 dBuV
 Attenuation: 10 dB
 Sweep Time: Coupled
 Resolution Bandwidth: 100kHz
 Video Bandwidth: 300kHz
 Detector: Peak for Pre-scan, Quasi-Peak
 Compliance shall be determined using CISPR quasi-peak detection; however, peak detection is permitted as an alternative to quasi-peak detection.

Terminate the access Point RF ports with 50 ohm loads.

Maximize Turntable (find worst case table angle), Maximize Antenna (find worst case height)

This report represents the worst case data for all supported operating modes and antennas.

| System # | Description | Samples |
|----------|-------------|---------|
| 1 | EUT | S01 |

| | |
|------------------------------------|--|
| Tested By : Jose Aguirre | Date of testing: 01-Oct-2015 |
| Test Result : PASS | |

See Appendix C for list of test equipment

Graphical Test Results

Note that the data displayed on the plots detailed in this appendix were measured using a 'Peak Detector'. Please refer to the results table for the detectors used during formal measurements

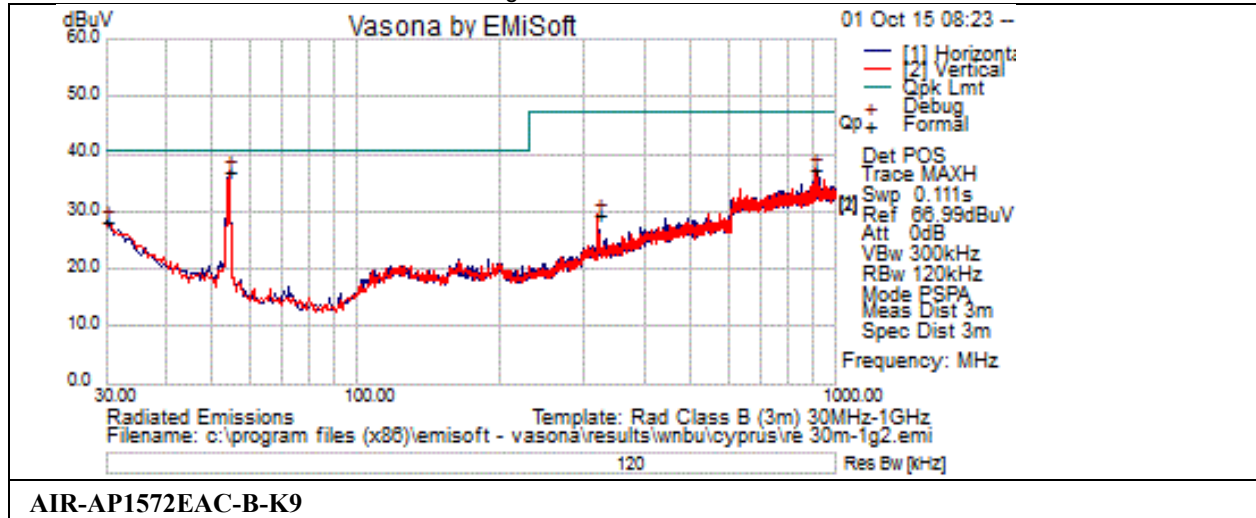

Test Results Table

| Frequency MHz | Raw dBuV | Cable Loss | AF dB | Level dBuV | Measurement Type | Pol | Hgt cm | Azt Deg | Limit dBuV | Margin dB | Pass /Fail | Comments |
|---------------|----------|------------|-------|------------|------------------|-----|--------|---------|------------|-----------|------------|----------|
| 54.25 | 29.1 | 0.7 | 7.3 | 37.1 | Peak | V | 100 | 230 | 40.5 | -3.4 | Pass | |
| 908.456 | 12.3 | 2.9 | 22.4 | 37.6 | Peak | V | 100 | 73 | 47.5 | -9.9 | Pass | |
| 30 | 6.8 | 0.5 | 21.1 | 28.4 | Peak | H | 100 | 139 | 40.5 | -12.1 | Pass | |
| 319.788 | 14 | 1.7 | 13.9 | 29.6 | Peak | V | 100 | 355 | 47.5 | -17.9 | Pass | |

B.3 AC Conducted Emissions

15.207

Except when the requirements applicable to a given device state otherwise, for any radio apparatus equipped to operate from the public utility AC power supply, either directly or indirectly (such as with a battery charger), the radio frequency voltage of emissions conducted back onto the AC power lines in the frequency range of 0.15 MHz to 30 MHz shall not exceed the limits shown in the table in these sections. The more stringent limit applies at the frequency range boundaries.

Measurement Procedure

Accordance with ANSI C63.10:2013 section 6.2

Using Vasona, configure the spectrum analyzer as shown below (be sure to enter all losses between the transmitter output and the spectrum analyzer). Place the radio in continuous transmit mode.

| | |
|-----------------------|----------------------|
| Span: | 150 KHz – 30 MHz |
| Attenuation: | 10 dB |
| Sweep Time: | Coupled |
| Resolution Bandwidth: | 9 KHz |
| Video Bandwidth: | 30 KHz |
| Detector: | Quasi-Peak / Average |

| System # | Description | Samples |
|----------|-------------|---------|
| 1 | EUT | S01 |

| | |
|------------------------------------|--|
| Tested By : Jose Aguirre | Date of testing: 25-Aug-2015 |
| Test Result : Pass | |

Graphical Test Results

Note that the data displayed on the plots detailed in this appendix were measured using a 'Peak Detector'. Please refer to the results table for the detectors used during formal measurements

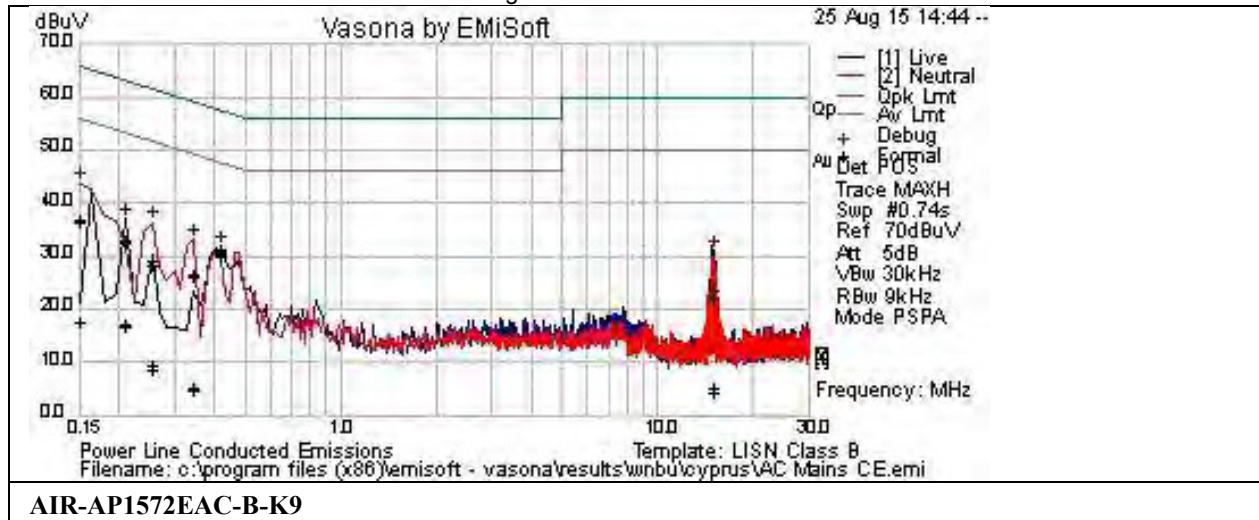

Test Results Table

| Frequency MHz | Raw dBuV | Cable Loss | Factors dB | Level dBuV | Measurement Type | Line | Limit dBuV | Margin dB | Pass /Fail | Comments |
|---------------|----------|------------|------------|------------|------------------|------|------------|-----------|------------|----------|
| 0.344025 | 6.1 | 20.3 | 0 | 26.5 | Qp | L | 59.1 | -32.6 | Pass | |
| 0.15 | 15.6 | 21.1 | 0.1 | 36.7 | Qp | L | 66 | -29.3 | Pass | |
| 0.254475 | 8.4 | 20.6 | 0 | 29 | Qp | L | 61.6 | -32.6 | Pass | |
| 14.883 | 3.1 | 20.2 | 0.2 | 23.5 | Qp | L | 60 | -36.5 | Pass | |
| 0.415 | 11.1 | 20.1 | 0 | 31.3 | Qp | L | 57.6 | -26.3 | Pass | |
| 0.2097 | 12.3 | 20.8 | 0 | 33.1 | Qp | L | 63.2 | -30.1 | Pass | |
| 0.254475 | 7.6 | 20.6 | 0 | 28.3 | Qp | N | 61.6 | -33.3 | Pass | |
| 0.15 | 15.2 | 21.1 | 0.1 | 36.3 | Qp | N | 66 | -29.7 | Pass | |
| 0.2097 | 12 | 20.8 | 0 | 32.8 | Qp | N | 63.2 | -30.4 | Pass | |
| 0.415 | 10.4 | 20.1 | 0 | 30.5 | Qp | N | 57.6 | -27 | Pass | |
| 0.344025 | 5.8 | 20.3 | 0 | 26.1 | Qp | N | 59.1 | -33 | Pass | |
| 14.883 | 2.1 | 20.2 | 0.2 | 22.4 | Qp | N | 60 | -37.6 | Pass | |
| 0.344025 | -15.1 | 20.3 | 0 | 5.3 | Av | L | 49.1 | -43.8 | Pass | |
| 0.15 | -3.7 | 21.1 | 0.1 | 17.4 | Av | L | 56 | -38.6 | Pass | |
| 0.254475 | -11.2 | 20.6 | 0 | 9.4 | Av | L | 51.6 | -42.2 | Pass | |
| 14.883 | -15.9 | 20.2 | 0.2 | 4.4 | Av | L | 50 | -45.6 | Pass | |
| 0.415 | 10.8 | 20.1 | 0 | 31 | Av | L | 47.6 | -16.6 | Pass | |
| 0.2097 | -4.1 | 20.8 | 0 | 16.7 | Av | L | 53.2 | -36.5 | Pass | |
| 0.254475 | -12.2 | 20.6 | 0 | 8.4 | Av | N | 51.6 | -43.2 | Pass | |
| 0.15 | -3.4 | 21.1 | 0.1 | 17.8 | Av | N | 56 | -38.2 | Pass | |
| 0.2097 | -3.8 | 20.8 | 0 | 17.1 | Av | N | 53.2 | -36.2 | Pass | |
| 0.415 | 9.8 | 20.1 | 0 | 29.9 | Av | N | 47.6 | -17.6 | Pass | |
| 0.344025 | -15.4 | 20.3 | 0 | 4.9 | Av | N | 49.1 | -44.2 | Pass | |
| 14.883 | -15.2 | 20.2 | 0.2 | 5.2 | Av | N | 50 | -44.8 | Pass | |

Photographs of setup



This is a dual band 2.4GHz / 5GHz device. All ports in this test set up photo are connected as all testing is automated. Section 2.6 of this test report given an overview of the different Tx antenna combinations used by this device.

AIR-AP1572EAC-B-K9 Radiated Emissions setup 30MHz to 1GHz



AIR-AP1572EAC-B-K9 Radiated Emissions setup above 1GHz

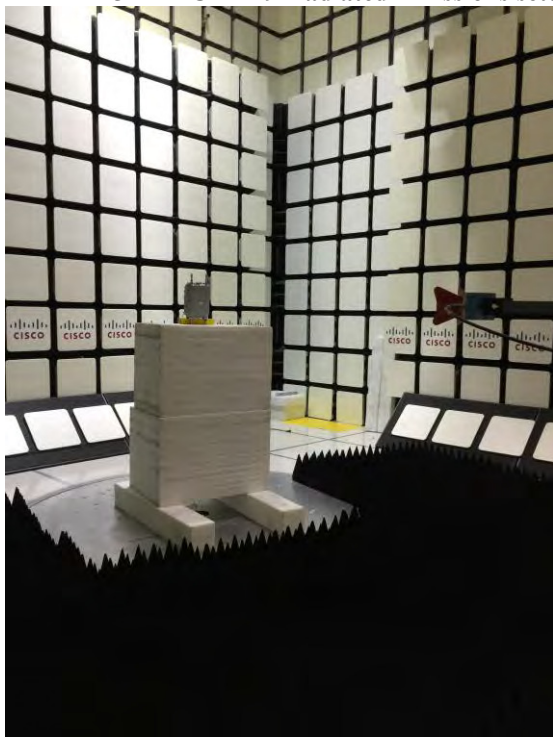

AIR-AP1572EAC-B-K9 AC Conducted Emissions setup



Appendix C: List of Test Equipment Used to perform the test

| Equip# | Manufacturer/ Model | Description | Last Cal | Next Due | Test Item |
|---|---|---|-----------|-----------|---------------|
| Test Equipment used for Radiated Emissions | | | | | |
| CIS008447 | Cisco / NSA 10m Chamber | NSA 10m Chamber | 14-Oct-14 | 14-Oct-15 | B.1 |
| CIS008447 | Cisco / NSA 10m Chamber | NSA 10m Chamber | 14-Oct-15 | 14-Oct-16 | B.1 |
| CIS008448 | Cisco / NSA 5m Chamber | NSA 5m Chamber | 09-Oct-15 | 09-Oct-16 | B.3 |
| CIS030652 | Sunol Sciences / JB1 | Combination Antenna, 30MHz-2GHz | 5-Nov-14 | 5-Nov-15 | B.3 |
| CIS030654 | Sunol Sciences / JB1 | Combination Antenna, 30MHz-2GHz | 12-Dec-14 | 12-Dec-15 | B.3 |
| CIS033988 | Agilent /E4446A | PSA Spectrum Analyzer | 9-Dec-14 | 9-Dec-15 | B.1, B.2 |
| CIS044940 | ROHDE & SCHWARZ / ESU40 | EMI RECEIVER, 40GHZ | 27-May-15 | 27-May-16 | B.1 |
| CIS041929 | Newport /iBTHP-5-DB9 | 5 inch Temp/RH/Press Sensor w/20ft cable | 20-Dec-14 | 20-Dec-15 | B.1, B.2, B.3 |
| CIS024998 | MICRO-COAX / UFB197C-1-0240-504504 | Coaxial RF Cable, 26.5 GHz | 11-Mar-15 | 11-Mar-16 | B.1, B.2 |
| CIS035284 | ETS Lindgren / 3117 | Double Ridged Horn Antenna | 16-Sep-14 | 16-Sep-15 | B.1, B.2 |
| CIS004882 | EMC Test Systems / 3115 | Double Ridge Guide Horn Antenna | 24-Jul-15 | 24-Jul-16 | B.1, B.2 |
| CIS035285 | ETS Lindgren / 3117 | Double Ridged Horn Antenna | 30-Sep-15 | 30-Sep-16 | B.1, B.2 |
| CIS049516 | Keysight / N9030A | PXA Spectrum Analyzer | 12-Nov-14 | 12-Nov-15 | B.1, B.2 |
| CIS043124 | Cisco /Above 1GHz Site Cal | Above 1GHz Cispr Site Verification | 15-Jan-15 | 15-Jan-16 | B.1, B.2 |
| CIS008166 | HP / 8491B Opt 010 | 10dB Attenuator | 2-Feb-15 | 2-Feb-16 | B.1, B.2 |
| CIS020975 | Micro-Coax / UFB311A-0-1344-520520 | RF Coaxial Cable, to 18GHz, 134.4 in | 18-Feb-15 | 18-Feb-16 | B.1, B.2, B.3 |
| CIS030559 | Micro-Coax / UFB311A-1-0950-504504 | RF Coaxial Cable, to 18GHz, 95 in | 20-Feb-15 | 20-Feb-16 | B.1, B.2, B.3 |
| CIS003003 | HP / 83731B | Synthesized Signal Generator | 13-Mar-15 | 13-Mar-16 | B.1 |
| CIS005691 | Miteq / NSP1800-25-S1 | Broadband Preamplifier (1-18GHz) | 25-Jun-15 | 25-Jun-16 | B.1 |
| CIS041979 | Cisco / 1840 | 18-40GHz EMI Test Head/Verification Fixture | 13-Jul-15 | 13-Jul-16 | B.1 |
| CIS047410 | Agilent / N9038A | EMI Receiver | 17-Feb-15 | 17-Feb-16 | B.1, B.2, B.3 |
| CIS051642 | Huber+Suhner / Sucoflex 106PA | RF N Type Cable 8.5m | 10-Feb-15 | 10-Feb-16 | B.1, B.2, B.3 |
| Test Equipment used for AC Mains Conducted Emissions | | | | | |
| CIS019206 | TTE / H785-150K-50-21378 | High Pas Filter,Fo=150kHz | 09-SEP-14 | 09-SEP-15 | B.3 |
| CIS030562 | Micro-Coax / UFB311A-1-0950-504504 | RF Coaxial Cable, to 18GHz, 95 in | 26-JUN-15 | 26-JUN-16 | B.3 |
| CIS041929 | Newport / iBTHP-5-DB9 | 5 inch Temp/RH/Press Sensor | 20-DEC-14 | 20-DEC-15 | B.3 |
| CIS045015 | Huber + Suhner/ Sucoflex 106PA | Sucoflex N Type Black 7ft cable | 28-OCT-14 | 28-OCT-15 | B.3 |
| CIS047300 | Agilent Technologies / N9038A | MXE EMI Receiver 20Hz to 26.5 Ghz | 13-Jan-15 | 13-Jan-16 | B.3 |
| CIS008471 | Bird 5-T-MB | 50 Ohm, 5W Terminator,Type BNC | 18-SEP-14 | 18-SEP-15 | B.3 |
| CIS019337 | Fischer Custom Communications FCC-LISN-50/250-50-2-01 | LISN | 08-SEP-14 | 08-SEP-15 | B.3 |
| CIS019136 | Fischer Custom Communications FCC-801-M3-32A | Power Line Coupling/Decoupling Network | 12-NOV-14 | 12-NOV-15 | B.3 |

| RF Conducted at output antenna port | | | | | |
|--|--------------------------------|------------------------------|------------|------------|------------|
| CIS050378 | Agilent / N9030A | PXA Spectrum Analyzer | 05 Jan 15 | 05 Jan 16 | A1 thru A6 |
| CIS051695 | Dynaware / 5400-9810-6251 | SMA 50 Ohm Termination 18GHz | 29-May-15 | 29-May-16 | A1 thru A6 |
| CIS051684 | Dynaware / 5400-9810-6251 | SMA 50 Ohm Termination 18GHz | 29-May-15 | 29-May-16 | A1 thru A6 |
| CIS051690 | Dynaware / 5400-9810-6251 | SMA 50 Ohm Termination 18GHz | 29-May-15 | 29-May-16 | A1 thru A6 |
| CIS051685 | Dynaware / 5400-9810-6251 | SMA 50 Ohm Termination 18GHz | 29-May-15 | 29-May-16 | A1 thru A6 |
| CIS051686 | Dynaware / 5400-9810-6251 | SMA 50 Ohm Termination 18GHz | 29-May-15 | 29-May-16 | A1 thru A6 |
| CIS051687 | Dynaware / 5400-9810-6251 | SMA 50 Ohm Termination 18GHz | 29-May-15 | 29-May-16 | A1 thru A6 |
| CIS047282 | Huber + Suhner / Sucoflex 102E | 40GHz Cable K Connector | 01-Jun-15 | 01-Jun-16 | A1 thru A6 |
| CIS030666 | Micro-Tronics / BRM50702-02 | 2.4-2.5G Notch Filter | 01-Sept-15 | 01-Sept-16 | A1 thru A6 |
| CIS034302 | Micro-Tronics / BRM50704-02 | 5.470-5.725G Notch Filter | 09-Jul-15 | 09-Jul-16 | A1 thru A6 |
| CIS035609 | Micro-Tronics / BRM50703-02 | 5.15-5.35G Notch Filter | 09-Jul-15 | 09-Jul-16 | A1 thru A6 |
| CIS031700 | Micro-Tronics / BRM50705-02 | 5.725-5.875G Notch Filter | 01-Sept-15 | 01-Sept-16 | A1 thru A6 |
| CIS054609 | ZFSC-2-10G /Mini-Circuits | Splitter | 30-Jul-15 | 30-Jul-16 | A1 thru A6 |
| CIS054608 | D3C2060 / Ditom | Splitter | 20 Oct 15 | 20 Oct 16 | A1 thru A6 |
| CIS054607 | PS4-09-452/4S/ Pulsar | Splitter | 30-Jul-15 | 30-Jul-16 | A1 thru A6 |
| CIS054637 | BWS30-W2/ Aeroflex | SMA 30dB Attenuator | 31-Jul-15 | 31-Jul-16 | A1 thru A6 |
| CIS054636 | BWS20-W2/ Aeroflex | 20dB SMA Attenuator | 31-Jul-15 | 31-Jul-16 | A1 thru A6 |
| CIS054625 | RA08-S1S1-24/Megaphase | SMA cable 24" | 31-Jul-15 | 31-Jul-16 | A1 thru A6 |
| CIS054624 | RA08-S1S1-18/Megaphase | SMA cable 18" | 31-Jul-15 | 31-Jul-16 | A1 thru A6 |
| CIS054623 | RA08-S1S1-18/Megaphase | SMA cable 18" | 31-Jul-15 | 31-Jul-16 | A1 thru A6 |
| CIS054622 | RA08-S1S1-18/Megaphase | SMA cable 18" | 31-Jul-15 | 31-Jul-16 | A1 thru A6 |
| CIS054621 | RA08-S1S1-18/Megaphase | SMA cable 18" | 31-Jul-15 | 31-Jul-16 | A1 thru A6 |

Appendix E: Abbreviation Key and Definitions

The following table defines abbreviations used within this test report.

| Abbreviation | Description | Abbreviation | Description |
|--------------|--|--------------|-------------------------------------|
| EMC | Electro Magnetic Compatibility | °F | Degrees Fahrenheit |
| EMI | Electro Magnetic Interference | °C | Degrees Celsius |
| EUT | Equipment Under Test | Temp | Temperature |
| ITE | Information Technology Equipment | S/N | Serial Number |
| TAP | Test Assessment Schedule | Qty | Quantity |
| ESD | Electro Static Discharge | emf | Electromotive force |
| EFT | Electric Fast Transient | RMS | Root mean square |
| EDCS | Engineering Document Control System | Qp | Quasi Peak |
| Config | Configuration | Av | Average |
| CIS# | Cisco Number (unique identification number for Cisco test equipment) | Pk | Peak |
| Cal | Calibration | kHz | Kilohertz (1×10^3) |
| EN | European Norm | MHz | MegaHertz (1×10^6) |
| IEC | International Electro technical Commission | GHz | Gigahertz (1×10^9) |
| CISPR | International Special Committee on Radio Interference | H | Horizontal |
| CDN | Coupling/Decoupling Network | V | Vertical |
| LISN | Line Impedance Stabilization Network | dB | decibel |
| PE | Protective Earth | V | Volt |
| GND | Ground | kV | Kilovolt (1×10^3) |
| L1 | Line 1 | μ V | Microvolt (1×10^{-6}) |
| L2 | Line2 | A | Amp |
| L3 | Line 3 | μ A | Micro Amp (1×10^{-6}) |
| DC | Direct Current | mS | Milli Second (1×10^{-3}) |
| RAW | Uncorrected measurement value, as indicated by the measuring device | μ S | Micro Second (1×10^{-6}) |
| RF | Radio Frequency | μ S | Micro Second (1×10^{-6}) |
| SLCE | Signal Line Conducted Emissions | m | Meter |
| Meas dist | Measurement distance | Spec dist | Specification distance |
| N/A or NA | Not Applicable | SL | Signal Line (or Telecom Line) |
| P | Power Line | L | Live Line |
| N | Neutral Line | R | Return |
| S | Supply | AC | Alternating Current |

END