

Test Report
AIR-CAP1532I-B-K9

Cisco Aironet 802.11n Dual Band Mesh Access Points

FCC ID: LDK102090P

5180-5240 MHz



Against the following Specifications:

CFR47 Part 15.407

Cisco Systems

170 West Tasman Drive

San Jose, CA 95134

	
Author: Jose Aguirre Tested By	Approved By: Jim Nicolson Title: Technical Leader, Engineering Revision: 3

This report replaces any previously entered test report under **EDCS-1539150**. This test report has been electronically authorized and archived using the CISCO Engineering Document Control system.

This test report has been electronically authorized and archived using the CISCO Engineering Document Control system.

SECTION 1: OVERVIEW	3
SECTION 2: ASSESSMENT INFORMATION	4
2.1 GENERAL	4
2.2 DATE OF TESTING.....	6
2.3 REPORT ISSUE DATE	6
2.4 TESTING FACILITIES	6
2.5 EQUIPMENT ASSESSED (EUT).....	6
2.6 EUT DESCRIPTION.....	7
SECTION 3: RESULT SUMMARY.....	8
3.1 RESULTS SUMMARY TABLE	8
SECTION 4: SAMPLE DETAILS.....	10
APPENDIX A: EMISSION TEST RESULTS.....	11
CONDUCTED TEST SETUP DIAGRAM.....	11
TARGET MAXIMUM CHANNEL POWER	11
A.1 99% AND 26dB BANDWIDTH	12
A.2 MAXIMUM CONDUCTED OUTPUT POWER/ POWER SPECTRAL DENSITY	18
A.3 CONDUCTED SPURIOUS EMISSIONS.....	26
A.4 CONDUCTED BAND EDGE.....	31
APPENDIX B: EMISSION TEST RESULTS.....	36
RADIATED EMISSION SETUP DIAGRAM-BELOW 1G	36
RADIATED EMISSION SETUP DIAGRAM-ABOVE 1G	36
B.1 RADIATED SPURIOUS EMISSIONS	37
B.2 RADIATED EMISSIONS 30MHZ TO 1GHZ.....	46
B.3 AC CONDUCTED EMISSIONS.....	48
PHOTOGRAPHS OF SETUP	50
APPENDIX C: LIST OF TEST EQUIPMENT USED TO PERFORM THE TEST.....	54
APPENDIX E: ABBREVIATION KEY AND DEFINITIONS	56

Section 1: Overview

The samples were assessed against the tests detailed in section 3 under the requirements of the following specifications:

Specifications:
CFR47 Part 15.407

Measurements were made in accordance with

- ANSI C63.10:2013
- KDB 789033 D02 General UNII Test Procedures New Rules v01
- KDB 662911 D01 Multiple Transmitter Output

Section 2: Assessment Information

2.1 General

This report contains an assessment of an apparatus against Electromagnetic Compatibility Standards based upon tests carried out on the samples submitted. The testing was performed by and for the use of Cisco systems Inc:

With regard to this assessment, the following points should be noted:

- a) The results contained in this report relate only to the items tested and were obtained in the period between the date of the initial assessment and the date of issue of the report. Manufactured products will not necessarily give identical results due to production and measurement tolerances.
- b) The apparatus was set up and exercised using the configuration and modes of operation defined in this report only.
- c) Where relevant, the apparatus was only assessed using the susceptibility criteria defined in this report and the Test Assessment Plan (TAP).
- d) All testing was performed under the following environmental conditions:

Temperature	15°C to 35°C (54°F to 95°F)
Atmospheric Pressure	860mbar to 1060mbar (25.4" to 31.3")
Humidity	10% to 75*%
- e) All AC testing was performed at one or more of the following supply voltages:
110V 60 Hz (+/-20%)

Units of Measurement

The units of measurements defined in the appendices are reported in specific terms, which are test dependent. Where radiated measurements are concerned these are defined at a particular distance. Basic voltage measurements are defined in units of [dBuV]

As an example, the basic calculation for all measurements is as follows:

$$\text{Emission level [dBuV]} = \text{Indicated voltage level [dBuV]} + \text{Cable Loss [dB]} + \text{Other correction factors [dB]}$$

The combinations of correction factors are dependent upon the exact test configurations [see test equipment lists for further details] and may include:-

Antenna Factors, Pre Amplifier Gain, LISN Loss, Pulse Limiter Loss and Filter Insertion Loss..

Note: to convert the results from dBuV/m to uV/m use the following formula:-

$$\text{Level in uV/m} = \text{Common Antilogarithm} [(X \text{ dBuV/m})/20] = Y \text{ uV/m}$$

Measurement Uncertainty Values

voltage and power measurements	± 2 dB
conducted EIRP measurements	± 1.4 dB
radiated measurements	± 3.2 dB
frequency measurements	$\pm 2.4 \cdot 10^{-7}$
temperature measurements	$\pm 0.54^{\circ}$
humidity measurements	$\pm 2.3\%$
DC and low frequency measurements	$\pm 2.5\%$

Where relevant measurement uncertainty levels have been estimated for tests performed on the apparatus. This uncertainty represents an expanded uncertainty expressed at approximately the 95% confidence level using a coverage factor of $k=2$.

Radiated emissions (expanded uncertainty, confidence interval 95%)

30 MHz - 300 MHz	+/- 3.8 dB
300 MHz - 1000 MHz	+/- 4.3 dB
1 GHz - 10 GHz	+/- 4.0 dB
10 GHz - 18GHz	+/- 8.2 dB
18GHz - 26.5GHz	+/- 4.1 dB
26.5GHz - 40GHz	+/- 3.9 dB

Conducted emissions (expanded uncertainty, confidence interval 95%)

30 MHz – 40GHz	+/- 0.38 dB
----------------	-------------

A product is considered to comply with a requirement if the nominal measured value is below the limit line. The product is considered to not be in compliance in case the nominal measured value is above the limit line.

This report must not be reproduced except in full, without written approval of Cisco Systems.

2.2 Date of testing

07-Jul-15 - 08-Aug-15

2.3 Report Issue Date

18-August-2015

Cisco uses an electronic system to issue, store and control the revision of test reports. This system is called the Engineering Document Control System (EDCS). The actual report issue date is embedded into the original file on EDCS. Any copies of this report, either electronic or paper, that are not on EDCS must be considered uncontrolled.

2.4 Testing facilities

This assessment was performed by:

Testing Laboratory

Cisco Systems, Inc.,
125 West Tasman Drive
San Jose, CA 95134, USA

Test Engineers

Jose Aguirre

2.5 Equipment Assessed (EUT)

AIR-CAP1532I-B-K9

2.6 EUT Description

The 1532I Series Cisco Aironet 802.11n Dual Band Mesh Access Points support the following modes of operation. The modes are further defined in the radio Theory of Operation. The modes included in this report represent the worst case data for all modes.

Non HT/VHT-20, One Antenna, 6 to 54 Mbps
Non HT/VHT-20, Two Antennas, 6 to 54 Mbps

HT/VHT-20, One Antenna, M0 to M7
HT/VHT-20, Two Antennas, M0 to M15

HT/VHT-20 STBC, Two Antennas, M0 to M7

Non HT/VHT-40 Duplicate, One Antenna, 6-54 Mbps
Non HT/VHT-40 Duplicate, Two Antennas, 6-54 Mbps

HT/VHT-40, One Antenna, M0 to M7
HT/VHT-40, Two Antennas, M0 to M15

HT/VHT-40 STBC, Two Antennas, M0 to M7

The following antennas are supported by this product series.

The data included in this report represent the worst case data for all antennas.

Frequency	Part Number	Antenna Type	Antenna Gain (dBi)	>30 degree 5GHz Antenna Gain (dBi)
2.4/5 GHz	Internal	Dual-resonant Omni	3 / 5	2

Section 3: Result Summary

3.1 Results Summary Table

Conducted emissions

Basic Standard	Technical Requirements / Details	Result
FCC 15.407	<p>99% & 26 dB Bandwidth:</p> <p>The 99% occupied bandwidth is the frequency bandwidth such that, below its lower and above its upper frequency limits, the mean powers are each equal to 0.5% of the total mean power of the given emission. There is no limit for 99% OBW.</p> <p>The 26 dB emission is the width of the emission that is constrained by the frequencies associated with the two outermost amplitude points (upper and lower frequencies) that are attenuated by 26 dB relative to the maximum level measured in the fundamental emission.</p>	Pass
FCC 15.407	<p>Output Power:</p> <p>15.407: (i) For an outdoor access point operating in the band 5.15-5.25 GHz, the maximum conducted output power over the frequency band of operation shall not exceed 1 W provided the maximum antenna gain does not exceed 6 dBi. In addition, the maximum power spectral density shall not exceed 17 dBm in any 1 megahertz band. If transmitting antennas of directional gain greater than 6 dBi are used, both the maximum conducted output power and the maximum power spectral density shall be reduced by the amount in dB that the directional gain of the antenna exceeds 6 dBi. The maximum e.i.r.p. at any elevation angle above 30 degrees as measured from the horizon must not exceed 125 mW (21 dBm).</p> <p>(ii) For an indoor access point operating in the band 5.15-5.25 GHz, the maximum conducted output power over the frequency band of operation shall not exceed 1 W provided the maximum antenna gain does not exceed 6 dBi. If transmitting antennas of directional gain greater than 6 dBi are used, the maximum conducted output power shall be reduced by the amount in dB that the directional gain of the antenna exceeds 6 dBi.</p>	Pass
FCC 15.407	<p>Power Spectral Density:</p> <p>15.407 The maximum power spectral density shall not exceed 17 dBm in any 1 megahertz band. If transmitting antennas of directional gain greater than 6 dBi are used, both the maximum conducted output power and the maximum power spectral density shall be reduced by the amount in dB that the directional gain of the antenna exceeds 6 dBi.</p>	Pass
FCC 15.407	<p>Conducted Spurious Emissions / Band-Edge:</p> <p>For transmitters operating in the 5.15-5.25 GHz band: all emissions outside of the 5.15-5.25 GHz band shall not exceed an EIRP of -27dBm/MHz.</p>	Pass
FCC 15.407 FCC 15.209 FCC 152.05	<p>Restricted band:</p> <p>Unwanted emissions falling within the restricted bands, as defined in FCC 15.205 (a) must also comply with the radiated emission limits specified in FCC 15.209 (a).</p>	Pass

Radiated Emissions (General requirements)

Basic Standard	Technical Requirements / Details	Result
FCC 15.209 FCC 15.205	TX Spurious Emissions: Except as provided elsewhere in this subpart, the emissions from an intentional radiator shall not exceed the field strength levels specified in the filed strength limits table in this section.	Pass
FCC 15.207	AC conducted Emissions: Except when the requirements applicable to a given device state otherwise, for any radio apparatus equipped to operate from the public utility AC power supply, either directly or indirectly (such as with a battery charger), the radio frequency voltage of emissions conducted back onto the AC power lines in the frequency range of 0.15 MHz to 30 MHz shall not exceed the limits shown in the table in these sections. The more stringent limit applies at the frequency range boundaries.	Pass

* MPE calculation is recorded in a separate report

Section 4: Sample Details

Note: Each sample was evaluated to ensure that its condition was suitable to be used as a test sample prior to the commencement of testing.

4.1 Sample Details

Sample No.	Equipment Details	Manufacturer	Hardware Rev.	Firmware Rev.	Software Rev.	Serial Number
S01	AIR-CAP1532I-B-K9	Cisco Systems	A0	ap1g3-k9w7-mx.153	Cisco IOS 15.3	RFDPP1AE004
S02*	AIR-PWR-C	Meanwell	A0	NA	NA	EB46E93226

(*) S02 are support equipment Power supplies for EUT S01

4.2 System Details

System #	Description	Samples
1	AIR-CAP1532I-B-K9	S01
	AIR-PWR-C	S02

4.3 Mode of Operation Details

Mode#	Description	Comments
1	Continuous Transmitting	Continuous Transmitting, > 98% Duty Cycle

All measurements were made in accordance with

- ANSI C63.10:2013
- KDB 789033 D02 General UNII Test Procedures New Rules v01
- KDB 662911 D01 Multiple Transmitter Output

Appendix A: Emission Test Results

Conducted Test Setup Diagram

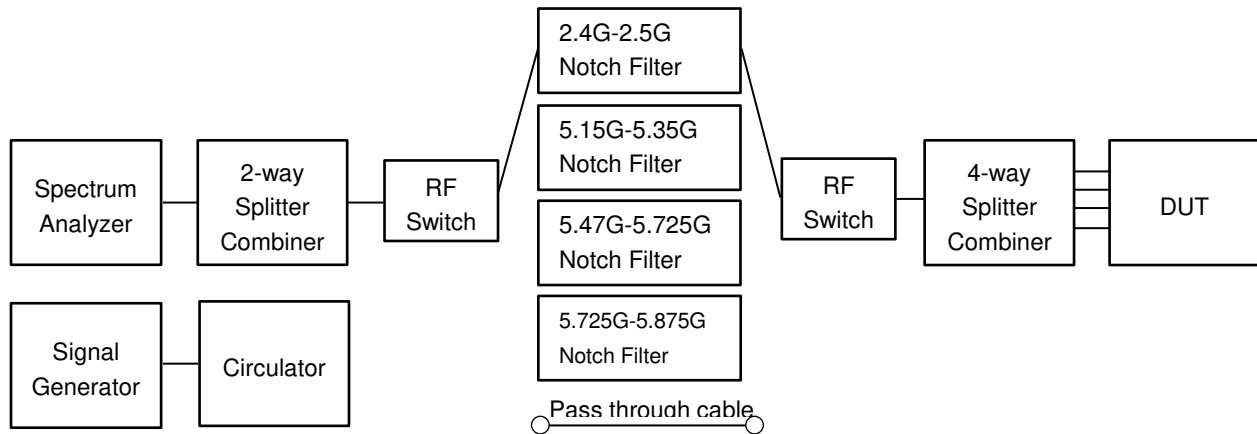

Target Maximum Channel Power

The following table details the maximum supported Total Channel Power for all operating modes.

Operating Mode	Maximum Channel Power (dBm)	
	Frequency (MHz)	
	5180	5240
Non HT-20, 6 to 54 Mbps	18	19
Non HT-20 Beam Forming, 6 to 54 Mbps	15	16
HT-20, M0 to M15, M0 to M9 1-0ss	19	18
HT-20 Beam Forming, M0 to M15, M0 to M9 1-0ss	19	18
HT-20 STBC, M0 to M7	19	18
	5190	5230
Non HT-40, 6 to 54 Mbps	18	19
HT-40, M0 to M15, M0 to M9 1-0ss	16	19
HT-40 Beam Forming, M0 to M15, M0 to M9 1-0ss	16	19
HT-40 STBC, M0 to M7	16	19



A.1 99% and 26dB Bandwidth

FCC 15.407 The 99% occupied bandwidth is the frequency bandwidth such that, below its lower and above its upper frequency limits, the mean powers are each equal to 0.5% of the total mean power of the given emission. There is no limit for 99% OBW.

The 26 dB emission is the width of the emission that is constrained by the frequencies associated with the two outermost amplitude points (upper and lower frequencies) that are attenuated by 26 dB relative to the maximum level measured in the fundamental emission.

Test Procedure

Ref. ANSI C63.10: 2013 Section 6.9.3

<p>99% BW and EBW (-26dB) Test Procedure</p> <ol style="list-style-type: none"> 1. Set the radio in the continuous transmitting mode. 2. Allow the trace to stabilize. 3. Setting the x-dB bandwidth mode to -26dB and OBW power function to 99% within the measurement set up function. 4. Select the automatic OBW measurement function of an instrument to perform bandwidth measurement. 5. Capture graphs and record pertinent measurement data.

Ref. ANSI C63.10: 2013 Section 6.9.3

<p>99% BW and EBW (-26dB) Test parameters</p> <p>Span = 1.5 x to 5.0 times OBW RBW = approx. 1% to 5% of the OBW VBW ≥ 3 x RBW Detector = Peak or where practical sample shall be used Trace = Max. Hold</p>

System Number	Description	Samples	System under test	Support equipment
1	EUT	S01	<input checked="" type="checkbox"/>	<input type="checkbox"/>
	Support	S02	<input type="checkbox"/>	<input checked="" type="checkbox"/>

<p>Tested By : Jose Aguirre</p>	<p>Date of testing: 07-Jul-15 - 08-Aug-15</p>
<p>Test Result : PASS</p>	

See Appendix C for list of test equipment

Frequency (MHz)	Mode	Data Rate (Mbps)	26dB BW (MHz)	99% BW (MHz)
5180	Non HT-20, 6 to 54 Mbps	6	25.0	18.3
	HT-20, M0 to M15, M0 to M9 1-0ss	m0	26.3	19.1
5190	Non HT-40, 6 to 54 Mbps	6	47.3	37.3
	HT-40, M0 to M15, M0 to M9 1-0ss	m0	50.3	37.6
5230	Non HT-40, 6 to 54 Mbps	6	48.0	37.6
	HT-40, M0 to M15, M0 to M9 1-0ss	m0	50.9	37.8
5240	Non HT-20, 6 to 54 Mbps	6	21.4	16.6
	HT-20, M0 to M15, M0 to M9 1-0ss	m0	22.5	17.7

26dB / 99% Bandwidth, 5180 MHz, Non HT-20, 6 to 54 Mbps

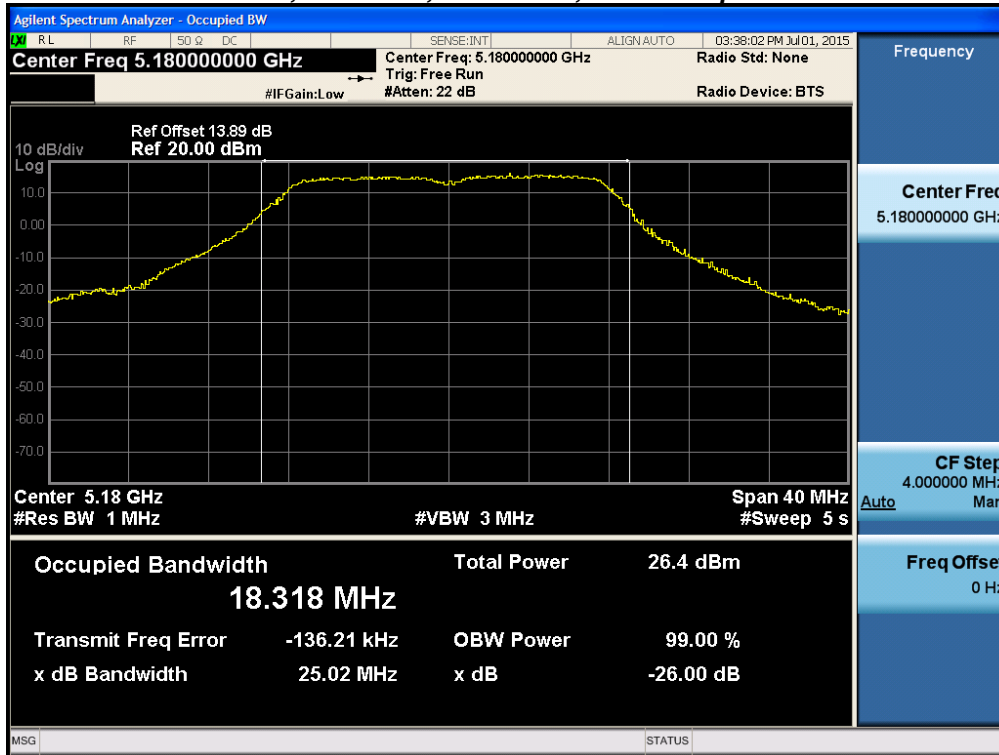

26dB / 99% Bandwidth, 5180 MHz, HT-20, M0 to M15, M0 to M9 1-0ss

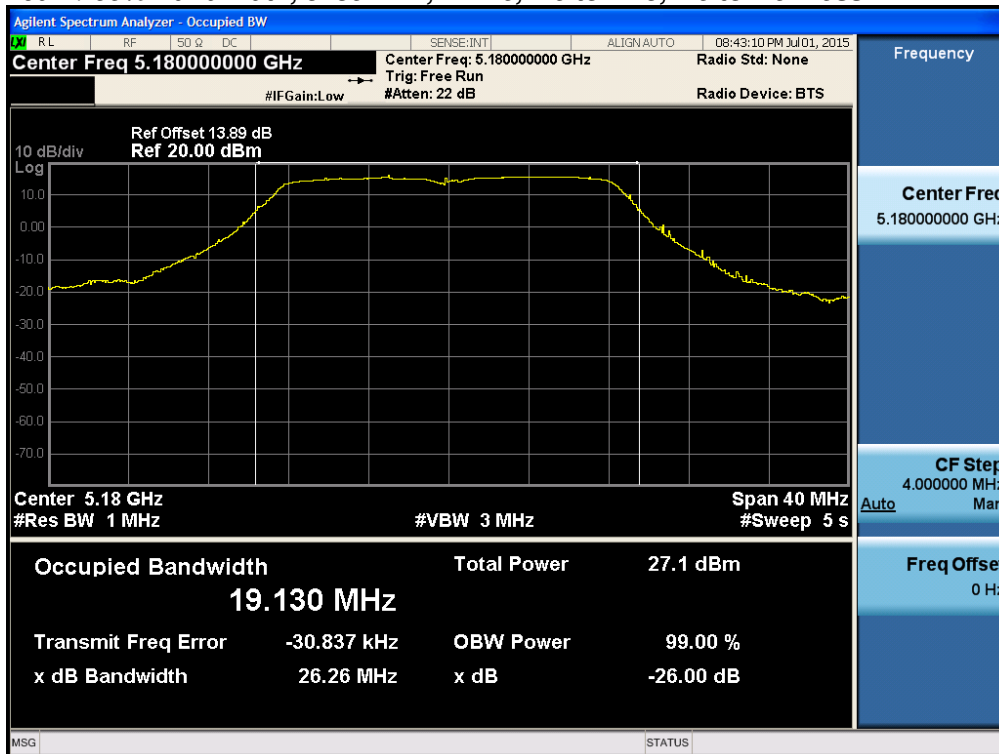

26dB / 99% Bandwidth, 5190 MHz, Non HT-40, 6 to 54 Mbps

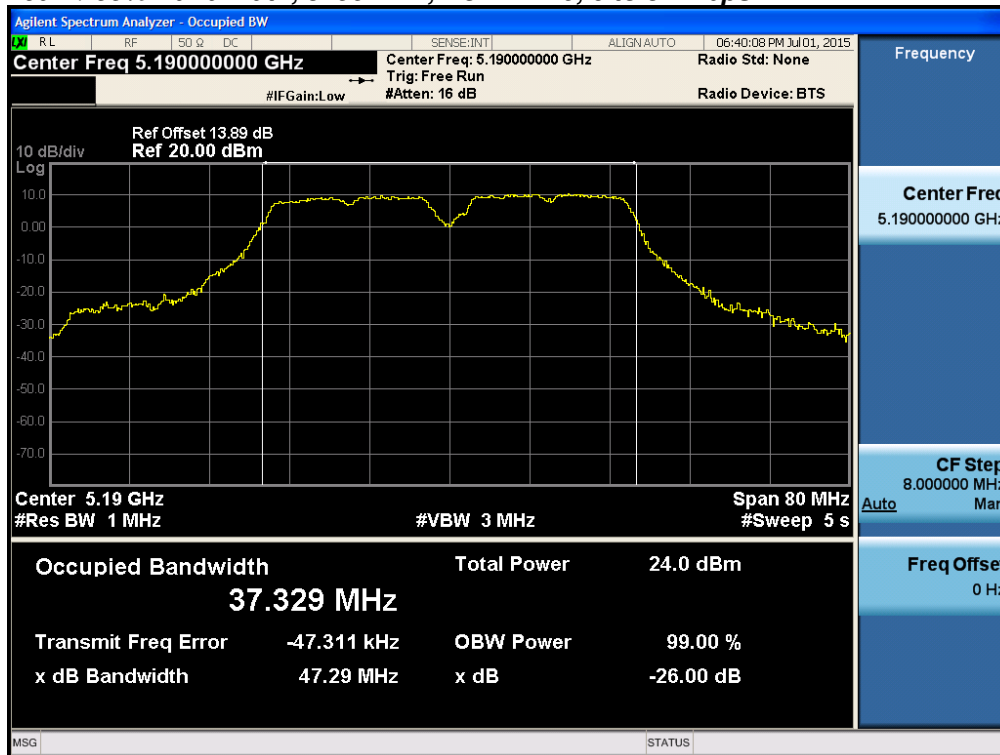

26dB / 99% Bandwidth, 5190 MHz, HT-40, M0 to M15, M0 to M9 1-0ss

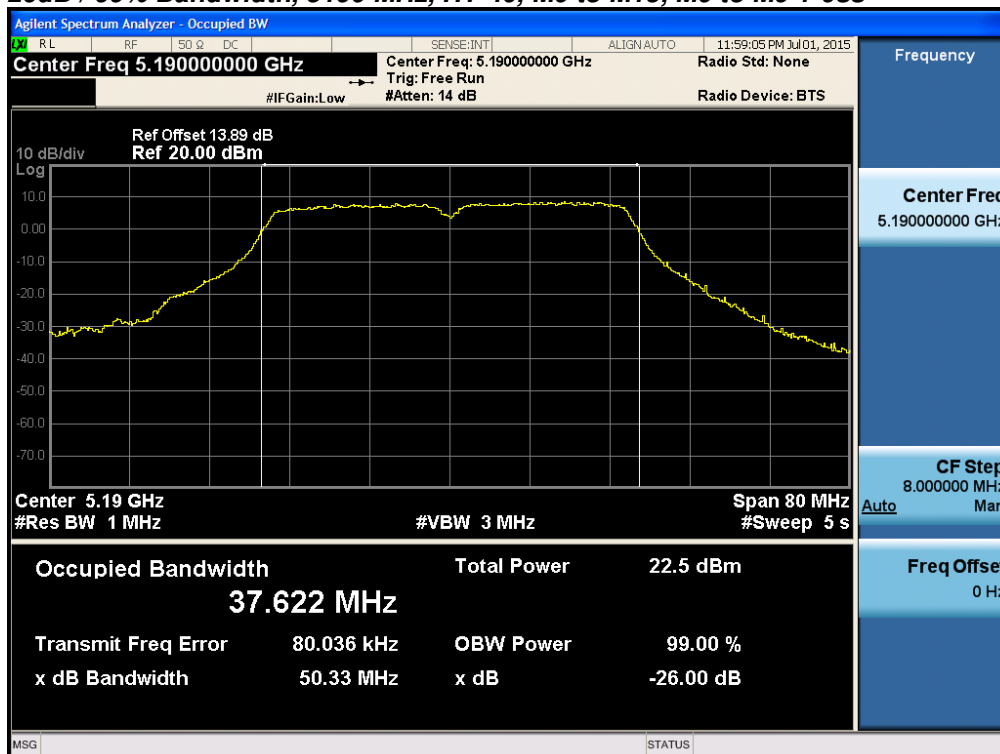



26dB / 99% Bandwidth, 5230 MHz, Non HT-40, 6 to 54 Mbps

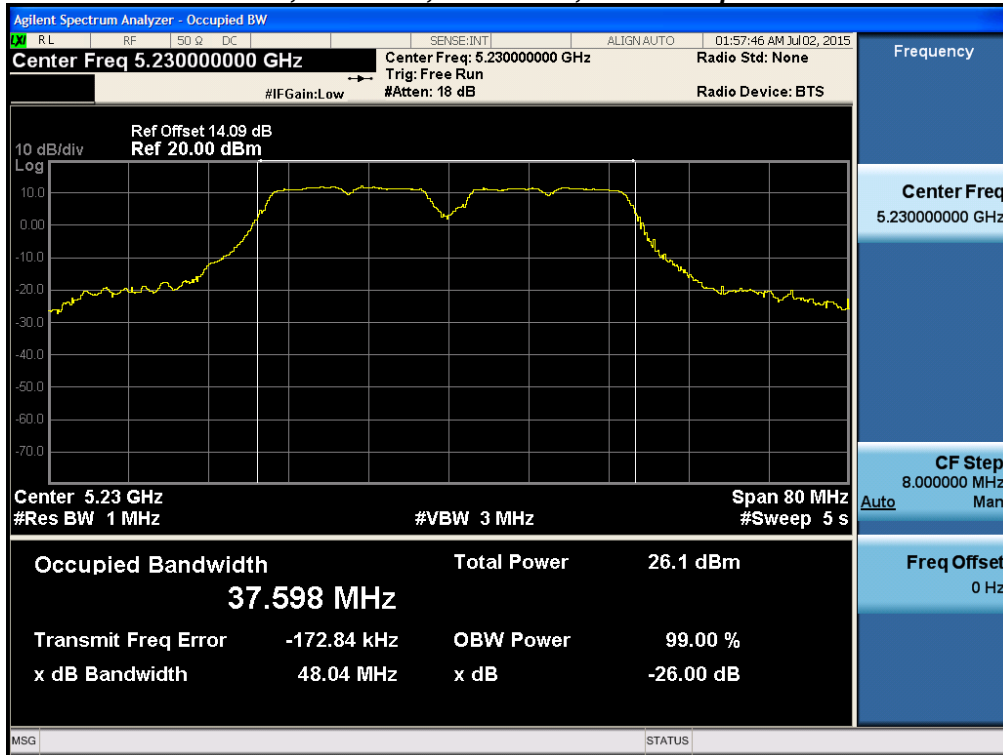

26dB / 99% Bandwidth, 5230 MHz, HT-40, M0 to M15, M0 to M9 1-0ss

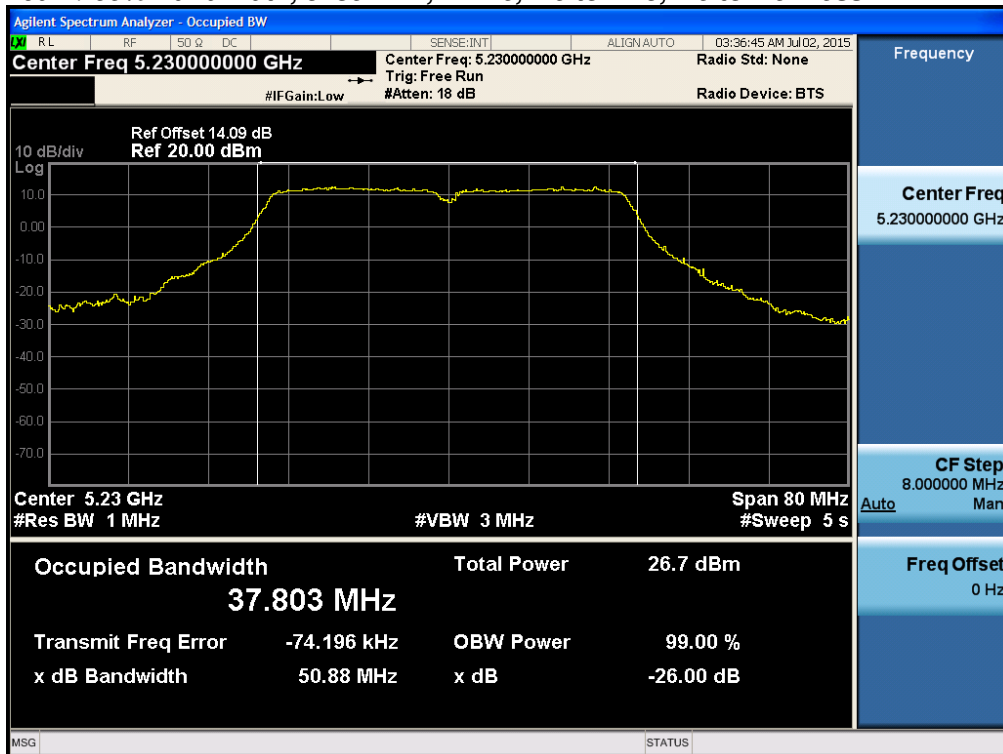

26dB / 99% Bandwidth, 5240 MHz, Non HT-20, 6 to 54 Mbps

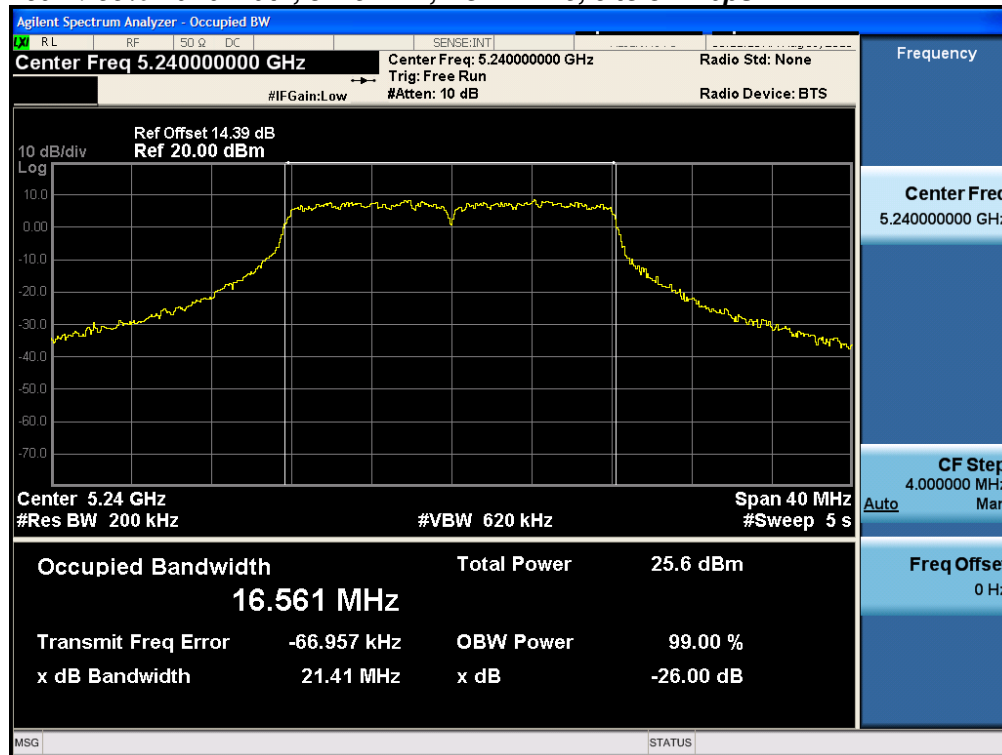

26dB / 99% Bandwidth, 5240 MHz, HT-20, M0 to M15, M0 to M9 1-0ss

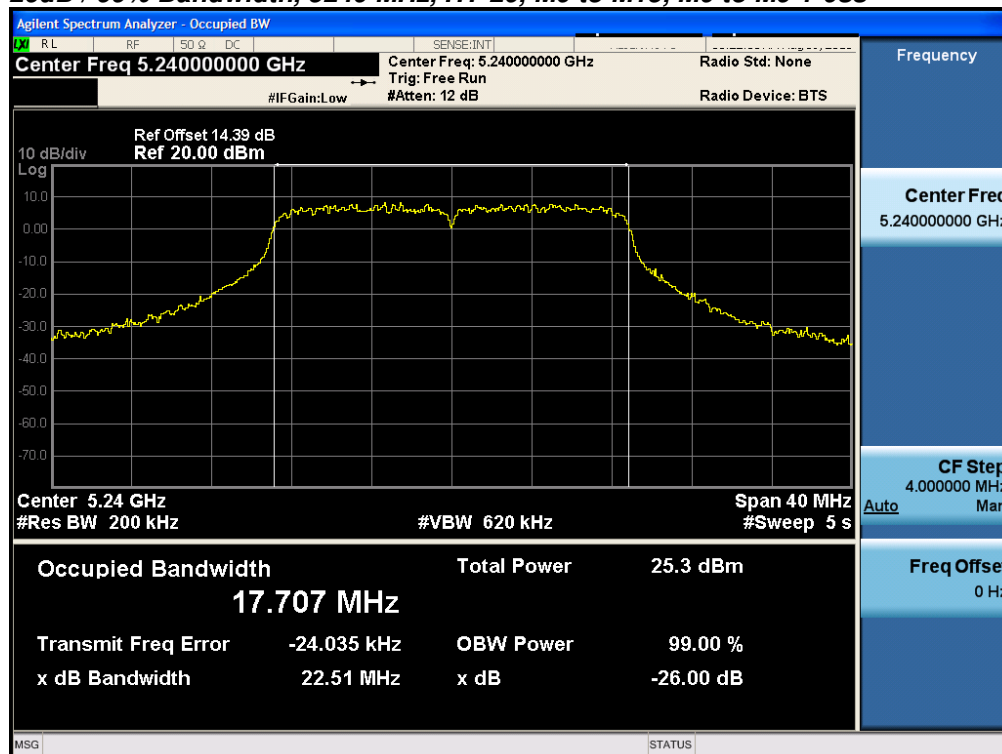



A.2 Maximum Conducted Output Power/ Power Spectral Density

15.407 (i) For an outdoor access point operating in the band 5.15-5.25 GHz, the maximum conducted output power over the frequency band of operation shall not exceed 1 W provided the maximum antenna gain does not exceed 6 dBi. In addition, the maximum power spectral density shall not exceed 17 dBm in any 1 megahertz band. If transmitting antennas of directional gain greater than 6 dBi are used, both the maximum conducted output power and the maximum power spectral density shall be reduced by the amount in dB that the directional gain of the antenna exceeds 6 dBi. The maximum e.i.r.p. at any elevation angle above 30 degrees as measured from the horizon must not exceed 125 mW (21 dBm).

(ii) For an indoor access point operating in the band 5.15-5.25 GHz, the maximum conducted output power over the frequency band of operation shall not exceed 1 W provided the maximum antenna gain does not exceed 6 dBi. In addition, the maximum power spectral density shall not exceed 17 dBm in any 1 megahertz band. If transmitting antennas of directional gain greater than 6 dBi are used, both the maximum conducted output power and the maximum power spectral density shall be reduced by the amount in dB that the directional gain of the antenna exceeds 6 dBi.

Test Procedure

Ref. KDB 789033 D02 General UNII Test Procedures New Rules v01
ANSI C63.10: 2013

Output Power
Test Procedure
<ol style="list-style-type: none"> 1. Set the radio in the continuous transmitting mode at full power 2. Compute power by integrating the spectrum across the EBW (or alternatively entire 99% OBW) of the signal using the instrument's band power measurement function. The integration shall be performed using the spectrum analyzer band-power measurement function with band limits set equal to the EBW or the OBW band edges. 3. Capture graphs and record pertinent measurement data.

Ref. KDB 789033 D02 General UNII Test Procedures New Rules v01
ANSI C63.10: 2013 section 12.3.2.2 Method SA-1

Output Power
Test parameters
Span = >1.5 times the OBW RBW = 1MHz VBW ≥ 3 x RBW Sweep = Auto couple Detector = sample Trace = Trace Average 100

The "measure-and-sum technique" is used for measuring in-band transmit power of a device. In the measure-and-sum approach, the conducted emission level is measured at each antenna port. The measured results at the various antenna ports are then summed mathematically to determine the total emission level from the device. Summing is performed in linear power units. (See ANSI C63.10 section 14.3.2.2)

System Number	Description	Samples	System under test	Support equipment
1	EUT	S01	<input checked="" type="checkbox"/>	<input type="checkbox"/>
	Support	S02	<input type="checkbox"/>	<input checked="" type="checkbox"/>

Tested By : Jose Aguirre	Date of testing: 07-Jul-15 - 08-Aug-15
Test Result : PASS	

See Appendix C for list of test equipment

Frequency (MHz)	Mode	Tx Paths	Correlated Antenna Gain (dBi)	Tx 1 Max Power (dBm)	Tx 2 Max Power (dBm)	Total Tx Channel Power (dBm)	Limit (dBm)	Margin (dB)
5180	Non HT-20, 6 to 54 Mbps	1	5	18.2		18.2	30.0	11.8
	Non HT-20, 6 to 54 Mbps	2	5	15.4	15.1	18.3	30.0	11.7
	Non HT-20 Beam Forming, 6 to 54 Mbps	2	8	12.1	12.4	15.3	28.0	12.7
	HT-20, M0 to M7	1	5	19.0		19.0	30.0	11.0
	HT-20, M0 to M7	2	5	15.7	16.1	18.9	30.0	11.1
	HT-20, M8 to M15	2	5	15.7	16.1	18.9	30.0	11.1
	HT-20 Beam Forming, M0 to M7	2	8	11.0	11.3	14.2	28.0	13.8
	HT-20 Beam Forming, M8 to M15	2	5	15.7	16.1	18.9	30.0	11.1
	HT-20 STBC, M0 to M7	2	5	15.7	16.1	18.9	30.0	11.1
5190	Non HT-40, 6 to 54 Mbps	1	5	15.8		15.8	30.0	14.2
	Non HT-40, 6 to 54 Mbps	2	5	14.8	15.1	18.0	30.0	12.0
	HT-40, M0 to M7	1	5	14.2		14.2	30.0	15.8
	HT-40, M0 to M7	2	5	12.1	13.0	15.6	30.0	14.4
	HT-40, M8 to M15	2	5	12.1	13.0	15.6	30.0	14.4
	HT-40 Beam Forming, M0 to M7	2	8	10.5	11.1	13.8	28.0	14.2
	HT-40 Beam Forming, M8 to M15	2	5	12.1	13.0	15.6	30.0	14.4
	HT-40 STBC, M0 to M7	2	5	12.1	13.0	15.6	30.0	14.4
5230	Non HT-40, 6 to 54 Mbps	1	5	18.0		18.0	30.0	12.0
	Non HT-40, 6 to 54 Mbps	2	5	16.1	15.9	19.0	30.0	11.0
	HT-40, M0 to M7	1	5	18.5		18.5	30.0	11.5
	HT-40, M0 to M7	2	5	15.5	16.3	18.9	30.0	11.1
	HT-40, M8 to M15	2	5	15.5	16.3	18.9	30.0	11.1
	HT-40 Beam Forming, M0 to M7	2	8	11.8	12.7	15.3	28.0	12.7
	HT-40 Beam Forming, M8 to M15	2	5	15.5	16.3	18.9	30.0	11.1
	HT-40 STBC, M0 to M7	2	5	15.5	16.3	18.9	30.0	11.1
5240	Non HT-20, 6 to 54 Mbps	1	5	18.6		18.6	30.0	11.4
	Non HT-20, 6 to 54 Mbps	2	5	14.7	15.7	18.2	30.0	11.8
	Non HT-20 Beam Forming, 6 to 54 Mbps	2	8	12.1	13.1	15.6	28.0	12.4
	HT-20, M0 to M7	1	5	18.5		18.5	30.0	11.5
	HT-20, M0 to M7	2	5	14.6	15.5	18.1	30.0	11.9
	HT-20, M8 to M15	2	5	14.6	15.5	18.1	30.0	11.9
	HT-20 Beam Forming, M0 to M7	2	8	12.0	12.9	15.5	28.0	12.5

HT-20 Beam Forming, M8 to M15	2	5	14.6	15.5	18.1	30.0	11.9
HT-20 STBC, M0 to M7	2	5	14.6	15.5	18.1	30.0	11.9



Frequency (MHz)	Mode	Tx Paths	Correlated Antenna Gain (dBi)	Tx 1 PSD (dBm/MHz)	Tx 2 PSD (dBm/MHz)	Total PSD (dBm/MHz)	Limit (dBm/MHz)	Margin (dB)
5180	Non HT-20, 6 to 54 Mbps	1	5	7.7		7.7	17.0	9.3
	Non HT-20, 6 to 54 Mbps	2	5	4.7	4.5	7.6	17.0	9.4
	Non HT-20 Beam Forming, 6 to 54 Mbps	2	8	1.6	2.0	4.8	15.0	10.2
	HT-20, M0 to M7	1	5	8.6		8.6	17.0	8.4
	HT-20, M0 to M7	2	5	4.9	5.3	8.1	17.0	8.9
	HT-20, M8 to M15	2	5	4.9	5.3	8.1	17.0	8.9
	HT-20 Beam Forming, M0 to M7	2	8	0.3	0.7	3.5	15.0	11.5
	HT-20 Beam Forming, M8 to M15	2	5	4.9	5.3	8.1	17.0	8.9
	HT-20 STBC, M0 to M7	2	5	4.9	5.3	8.1	17.0	8.9
5190	Non HT-40, 6 to 54 Mbps	1	5	2.2		2.2	17.0	14.8
	Non HT-40, 6 to 54 Mbps	2	5	1.7	1.7	4.7	17.0	12.3
	HT-40, M0 to M7	1	5	0.4		0.4	17.0	16.6
	HT-40, M0 to M7	2	5	-1.9	-0.5	1.9	17.0	15.1
	HT-40, M8 to M15	2	5	-1.9	-0.5	1.9	17.0	15.1
	HT-40 Beam Forming, M0 to M7	2	8	-3.5	-2.5	0.0	15.0	15.0
	HT-40 Beam Forming, M8 to M15	2	5	-1.9	-0.5	1.9	17.0	15.1
	HT-40 STBC, M0 to M7	2	5	-1.9	-0.5	1.9	17.0	15.1
5230	Non HT-40, 6 to 54 Mbps	1	5	4.4		4.4	17.0	12.6
	Non HT-40, 6 to 54 Mbps	2	5	2.3	3.2	5.8	17.0	11.2
	HT-40, M0 to M7	1	5	4.3		4.3	17.0	12.7
	HT-40, M0 to M7	2	5	1.4	2.6	5.1	17.0	11.9
	HT-40, M8 to M15	2	5	1.4	2.6	5.1	17.0	11.9
	HT-40 Beam Forming, M0 to M7	2	8	-2.4	-1.2	1.3	15.0	13.7
	HT-40 Beam Forming, M8 to M15	2	5	1.4	2.6	5.1	17.0	11.9
	HT-40 STBC, M0 to M7	2	5	1.4	2.6	5.1	17.0	11.9
5240	Non HT-20, 6 to 54 Mbps	1	5	7.9		7.9	17.0	9.1
	Non HT-20, 6 to 54 Mbps	2	5	4.3	5.1	7.7	17.0	9.3
	Non HT-20 Beam Forming, 6 to 54 Mbps	2	8	1.2	2.5	4.9	15.0	10.1
	HT-20, M0 to M7	1	5	7.7		7.7	17.0	9.3
	HT-20, M0 to M7	2	5	3.8	4.7	7.3	17.0	9.7
	HT-20, M8 to M15	2	5	3.8	4.7	7.3	17.0	9.7
	HT-20 Beam Forming, M0 to M7	2	8	1.0	2.3	4.7	15.0	10.3



HT-20 Beam Forming, M8 to M15	2	5	3.8	4.7	7.3	17.0	9.7
HT-20 STBC, M0 to M7	2	5	3.8	4.7	7.3	17.0	9.7



Frequency (MHz)	Mode	Tx Paths	Correlated Antenna Gain (dBi)	Tx 1 Max Power (dBm)	Tx 2 Max Power (dBm)	Total Radiated Channel Power (dBm)	Limit (dBm)	Margin (dB)
5180	Non HT-20, 6 to 54 Mbps	1	2	18.2		20.2	21.0	0.8
	Non HT-20, 6 to 54 Mbps	2	2	15.4	15.1	20.3	21.0	0.7
	Non HT-20 Beam Forming, 6 to 54 Mbps	2	5	12.1	12.4	20.3	21.0	0.7
	HT-20, M0 to M7	1	2	19.0		21.0	21.0	0.0
	HT-20, M0 to M7	2	2	15.7	16.1	20.9	21.0	0.1
	HT-20, M8 to M15	2	2	15.7	16.1	20.9	21.0	0.1
	HT-20 Beam Forming, M0 to M7	2	5	11.0	11.3	19.2	21.0	1.8
	HT-20 Beam Forming, M8 to M15	2	2	15.7	16.1	20.9	21.0	0.1
HT-20 STBC, M0 to M7	2	2	15.7	16.1	20.9	21.0	0.1	

5190	Non HT-40, 6 to 54 Mbps	1	2	15.8		17.8	21.0	3.2
	Non HT-40, 6 to 54 Mbps	2	2	14.8	15.1	20.0	21.0	1.0
	HT-40, M0 to M7	1	2	14.2		16.2	21.0	4.8
	HT-40, M0 to M7	2	2	12.1	13.0	17.6	21.0	3.4
	HT-40, M8 to M15	2	2	12.1	13.0	17.6	21.0	3.4
	HT-40 Beam Forming, M0 to M7	2	5	10.5	11.1	18.8	21.0	2.2
	HT-40 Beam Forming, M8 to M15	2	2	12.1	13.0	17.6	21.0	3.4
	HT-40 STBC, M0 to M7	2	2	12.1	13.0	17.6	21.0	3.4

5230	Non HT-40, 6 to 54 Mbps	1	2	18.0		20.0	21.0	1.0
	Non HT-40, 6 to 54 Mbps	2	2	16.1	15.9	21.0	21.0	0.0
	HT-40, M0 to M7	1	2	18.5		20.5	21.0	0.5
	HT-40, M0 to M7	2	2	15.5	16.3	20.9	21.0	0.1
	HT-40, M8 to M15	2	2	15.5	16.3	20.9	21.0	0.1
	HT-40 Beam Forming, M0 to M7	2	5	11.8	12.7	20.3	21.0	0.7
	HT-40 Beam Forming, M8 to M15	2	2	15.5	16.3	20.9	21.0	0.1
	HT-40 STBC, M0 to M7	2	2	15.5	16.3	20.9	21.0	0.1

5240	Non HT-20, 6 to 54 Mbps	1	2	18.6		20.6	21.0	0.4
	Non HT-20, 6 to 54 Mbps	2	2	14.7	15.7	20.2	21.0	0.8
	Non HT-20 Beam Forming, 6 to 54 Mbps	2	5	12.1	13.1	20.6	21.0	0.4
	HT-20, M0 to M7	1	2	18.5		20.5	21.0	0.5
	HT-20, M0 to M7	2	2	14.6	15.5	20.1	21.0	0.9
	HT-20, M8 to M15	2	2	14.6	15.5	20.1	21.0	0.9
	HT-20 Beam Forming, M0 to M7	2	5	12.0	12.9	20.5	21.0	0.5

	HT-20 Beam Forming, M8 to M15	2	2	14.6	15.5	20.1	21.0	0.9
	HT-20 STBC, M0 to M7	2	2	14.6	15.5	20.1	21.0	0.9

Peak Output Power, 5180 MHz, HT-20, 6 to 54 Mbps

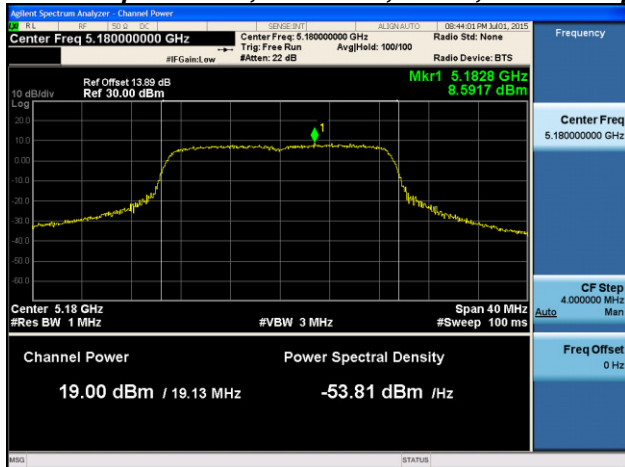

Antenna A

Power Spectral Density, 5180 MHz, HT-20, 6 to 54 Mbps

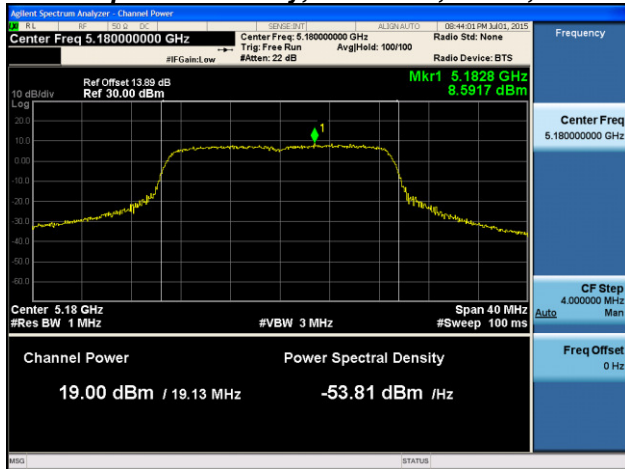

Antenna A

A.3 Conducted Spurious Emissions

15.407 (b) Undesirable emission limits. Except as shown in paragraph (b)(7) of this section, the maximum emissions outside of the frequency bands of operation shall be attenuated in accordance with the following limits:

(1) For transmitters operating in the 5.15-5.25 GHz band: All emissions outside of the 5.15-5.35 GHz band shall not exceed an e.i.r.p. of -27 dBm/MHz.

Radiated emissions which fall in the restricted bands, as defined in Section 15.205(a), must also comply with the radiated emission limits specified in Section 15.209(a) (see Section 15.205(c)).

Test Procedure

Ref. KDB 789033 D02 General UNII Test Procedures New Rules v01
ANSI C63.10: 2013

Conducted Spurious Emissions

Test Procedure

1. Connect the antenna port(s) to the spectrum analyzer input.
2. Place the radio in continuous transmit mode. Use the procedures in KDB 789033 D02 General UNII Test Procedures New Rules v01 to substitute conducted measurements in place of radiated measurements.
3. Configure Spectrum analyzer as per test parameters below (be sure to enter all losses between the transmitter output and the spectrum analyzer).
4. Record the marker waveform peak to spur difference. Also measure any emissions in the restricted bands.
5. The "measure-and-sum technique" is used for measuring in-band transmit power of a device. In the measure-and-sum approach, the conducted emission level is measured at each antenna port. The measured results at the various antenna ports are then summed mathematically to determine the total emission level from the device. Summing is performed in linear power units. The worst case output is recorded.
6. Capture graphs and record pertinent measurement data.

Ref. KDB 789033 D02 General UNII Test Procedures New Rules v01
ANSI C63.10: 2013 section 12.7.7.3 (average) & 12.7.6 (peak)

Conducted Spurious Emissions

Test parameters

Span = 30MHz to 18GHz / 18GHz to 40GHz
RBW = 1 MHz
VBW ≥ 3 x RBW for Peak, 1kHz for Average
Sweep = Auto couple
Detector = Peak
Trace = Max Hold.

System Number	Description	Samples	System under test	Support equipment
1	EUT	S01	<input checked="" type="checkbox"/>	<input type="checkbox"/>
	Support	S02	<input type="checkbox"/>	<input checked="" type="checkbox"/>

Tested By :

Jose Aguirre

Date of testing:

07-Jul-15 - 08-Aug-15

Test Result : PASS

See Appendix C for list of test equipment

Frequency (MHz)	Mode	Tx Paths	Correlated Antenna Gain (dBi)	Tx 1 Spur Power (dBm)	Tx 2 Spur Power (dBm)	Total Conducted Spur (dBm)	Limit (dBm)	Margin (dB)
5180	Non HT-20, 6 to 54 Mbps	1	5	-60.7		-55.7	-27.00	28.7
	Non HT-20, 6 to 54 Mbps	2	5	-62.6	-62.8	-54.7	-27.00	27.7
	Non HT-20 Beam Forming, 6 to 54 Mbps	2	8	-63.3	-63.3	-52.3	-27.00	25.3
	HT-20, M0 to M7	1	5	-61.3		-56.3	-27.00	29.3
	HT-20, M0 to M7	2	5	-62.7	-60.7	-53.6	-27.00	26.6
	HT-20, M8 to M15	2	5	-62.7	-60.7	-53.6	-27.00	26.6
	HT-20 Beam Forming, M0 to M7	2	8	-62.6	-61.9	-51.2	-27.00	24.2
	HT-20 Beam Forming, M8 to M15	2	5	-62.7	-60.7	-53.6	-27.00	26.6
	HT-20 STBC, M0 to M7	2	5	-62.7	-60.7	-53.6	-27.00	26.6
5190	Non HT-40, 6 to 54 Mbps	1	5	-61.0		-56.0	-27.00	29.0
	Non HT-40, 6 to 54 Mbps	2	5	-64.4	-61.7	-54.8	-27.00	27.8
	HT-40, M0 to M7	1	5	-63.2		-58.2	-27.00	31.2
	HT-40, M0 to M7	2	5	-63.0	-61.3	-54.1	-27.00	27.1
	HT-40, M8 to M15	2	5	-63.0	-61.3	-54.1	-27.00	27.1
	HT-40 Beam Forming, M0 to M7	2	8	-63.1	-63.3	-52.2	-27.00	25.2
	HT-40 Beam Forming, M8 to M15	2	5	-63.0	-61.3	-54.1	-27.00	27.1
	HT-40 STBC, M0 to M7	2	5	-63.0	-61.3	-54.1	-27.00	27.1
5230	Non HT-40, 6 to 54 Mbps	1	5	-61.1		-56.1	-27.00	29.1
	Non HT-40, 6 to 54 Mbps	2	5	-61.9	-62.7	-54.3	-27.00	27.3
	HT-40, M0 to M7	1	5	-62.7		-57.7	-27.00	30.7
	HT-40, M0 to M7	2	5	-64.8	-64.7	-56.7	-27.00	29.7
	HT-40, M8 to M15	2	5	-64.8	-64.7	-56.7	-27.00	29.7
	HT-40 Beam Forming, M0 to M7	2	8	-62.1	-61.3	-50.7	-27.00	23.7
	HT-40 Beam Forming, M8 to M15	2	5	-64.8	-64.7	-56.7	-27.00	29.7
	HT-40 STBC, M0 to M7	2	5	-64.8	-64.7	-56.7	-27.00	29.7
5240	Non HT-20, 6 to 54 Mbps	1	5	-62.9		-57.9	-27.00	30.9
	Non HT-20, 6 to 54 Mbps	2	5	-63.4	-64.7	-56.0	-27.00	29.0
	Non HT-20 Beam Forming, 6 to 54 Mbps	2	8	-62.0	-61.2	-50.6	-27.00	23.6
	HT-20, M0 to M7	1	5	-60.9		-55.9	-27.00	28.9
	HT-20, M0 to M7	2	5	-63.7	-62.2	-54.9	-27.00	27.9
	HT-20, M8 to M15	2	5	-63.7	-62.2	-54.9	-27.00	27.9
	HT-20 Beam Forming, M0 to M7	2	8	-62.7	-63.3	-52.0	-27.00	25.0



HT-20 Beam Forming, M8 to M15	2	5	-63.7	-62.2	-54.9	-27.00	27.9
HT-20 STBC, M0 to M7	2	5	-63.7	-62.2	-54.9	-27.00	27.9

Conducted Spurs Average, All Antennas

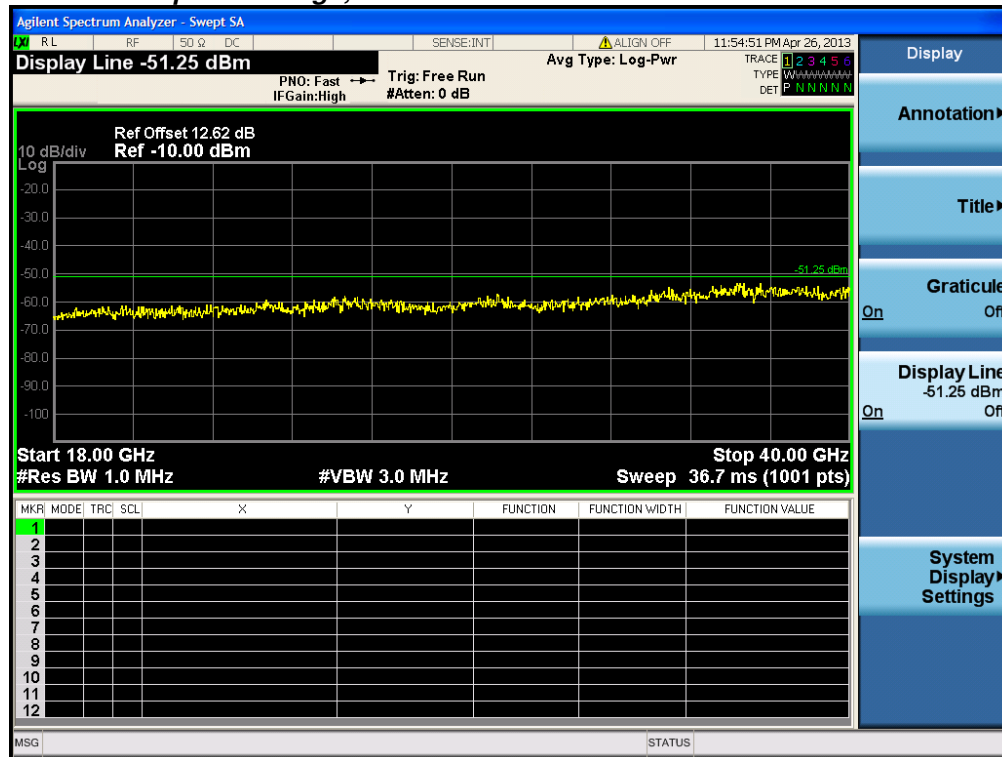

Conducted Spurs Peak, All Antennas

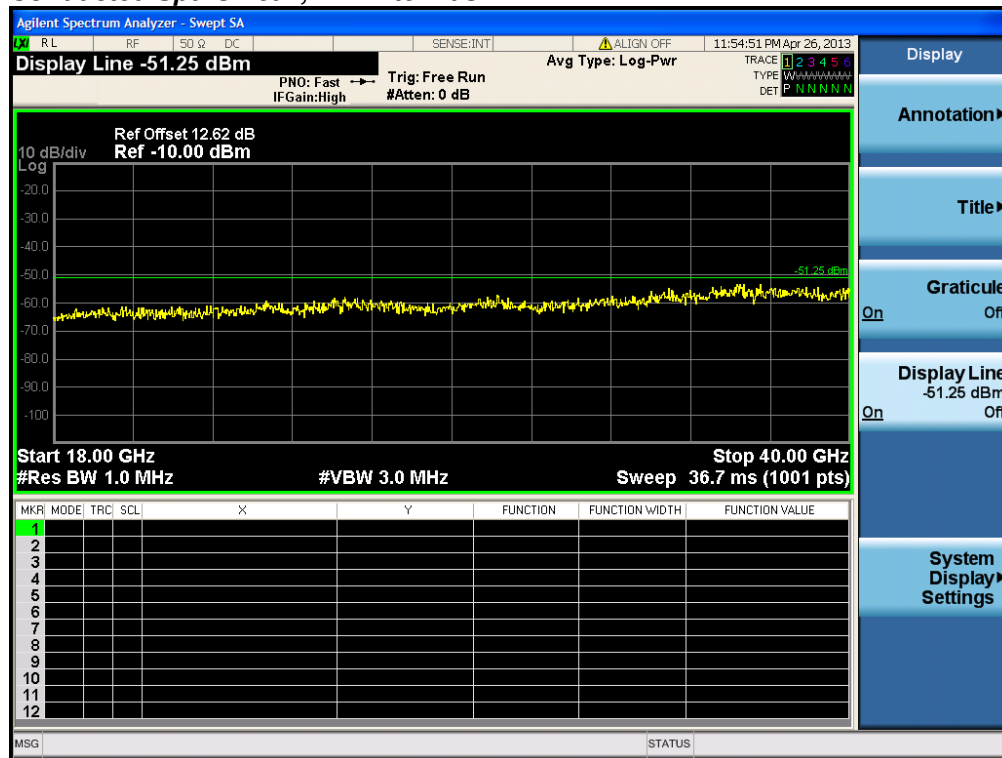



Conducted Spurs Peak, 5240 MHz, Non HT-20 Beam Forming, 6 to 54 Mbps

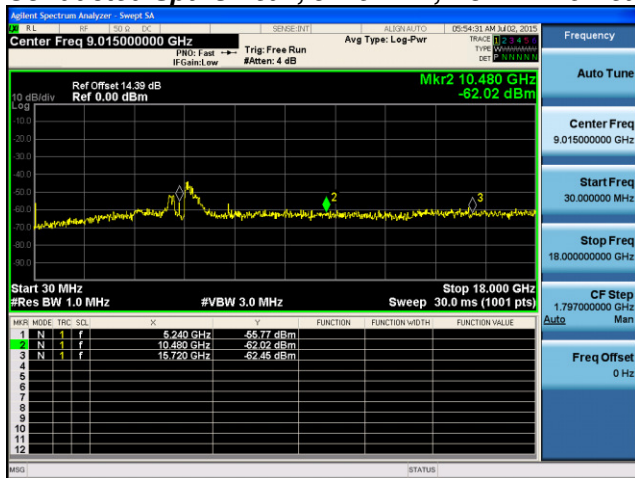

Antenna A

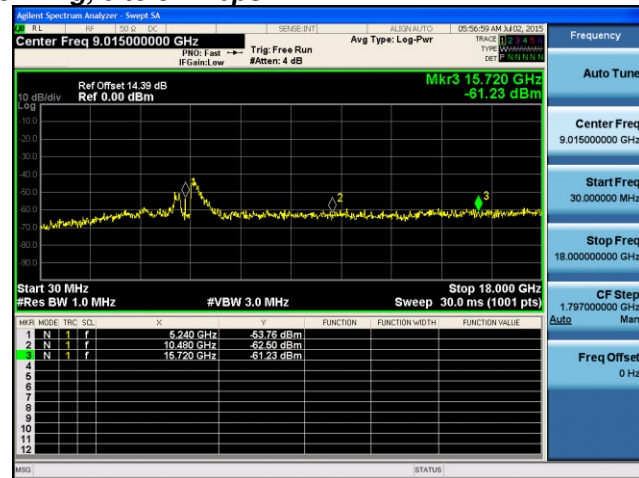

Antenna B



A.4 Conducted Band edge

15.407 (b) Undesirable emission limits. Except as shown in paragraph (b)(7) of this section, the maximum emissions outside of the frequency bands of operation shall be attenuated in accordance with the following limits:

(1) For transmitters operating in the 5.15-5.25 GHz band: All emissions outside of the 5.15-5.35 GHz band shall not exceed an e.i.r.p. of -27 dBm/MHz.

Radiated emissions which fall in the restricted bands, as defined in Section 15.205(a), must also comply with the radiated emission limits specified in Section 15.209(a) (see Section 15.205(c)).

As specified in § 15.407(b), emissions above 1000 MHz that are outside of the restricted bands are subject to a maximum emission limit of -27 dBm/MHz (or -17 dBm/MHz as specified in § 15.407(b)(4)). **However, an out-of-band emission that complies with both the peak and average limits of § 15.209 is not required to satisfy the -27 dBm/MHz maximum emission limit.**

Use formula below to substitute conducted measurements in place of radiated measurements

$$E[\text{dB}\mu\text{V}/\text{m}] = \text{EIRP}[\text{dBm}] - 20 \log(d[\text{meters}]) + 104.77, \text{ where } E = \text{field strength and } d = 3 \text{ meter}$$

- 1) Average Plot, Limit= -41.25 dBm eirp
- 2) Peak plot, Limit = -21.25 dBm eirp

Test Procedure

Ref. ANSI C63.10: 2013

<p>Conducted Bandedge Test Procedure</p> <ol style="list-style-type: none"> 1. Connect the antenna port(s) to the spectrum analyzer input. 2. Place the radio in continuous transmit mode. Use the procedures in ANSI C63.10: 2013 to substitute conducted measurements in place of radiated measurements. 3. Configure Spectrum analyzer as per test parameters below (be sure to enter all losses between the transmitter output and the spectrum analyzer). 4. Place a marker at the end of the restricted band closest to the transmit frequency to show compliance. Also measure any emissions in the restricted bands. 5. The “measure-and-sum technique” is used for measuring in-band transmit power of a device. In the measure-and-sum approach, the conducted emission level is measured at each antenna port. The measured results at the various antenna ports are then summed mathematically to determine the total emission level from the device. Summing is performed in linear power units. The worst case output is recorded. 6. Place a marker at the end of the restricted band closest to the transmit frequency to show compliance. Also measure any emissions in the restricted bands 7. Capture graphs and record pertinent measurement data.
--

Ref. ANSI C63.10: 2013 section 12.7.6 (peak) & 12.7.7.3 (average, Method VB-A (Alternative))

<p>Conducted Bandedge Test parameters restricted Band</p> <p>RBW = 1 MHz VBW ≥ 3 x RBW for Peak, 100Hz for Average Sweep = Auto couple Detector = Peak Trace = Max Hold.</p>

System Number	Description	Samples	System under test	Support equipment
1	EUT	S01	<input checked="" type="checkbox"/>	<input type="checkbox"/>
	Support	S02	<input type="checkbox"/>	<input checked="" type="checkbox"/>

<p>Tested By : Jose Aguirre</p>	<p>Date of testing: 07-Jul-15 - 08-Aug-15</p>
<p>Test Result : PASS</p>	

See Appendix C for list of test equipment

Frequency (MHz)	Mode	Tx Paths	Correlated Antenna Gain (dBi)	Tx 1 Bandedge Level (dBm)	Tx 2 Bandedge Level (dBm)	Total Tx Bandedge Level (dBm)	Limit (dBm)	Margin (dB)
5180	Non HT-20, 6 to 54 Mbps	1	5	-50.3		-45.3	-41.25	4.1
	Non HT-20, 6 to 54 Mbps	2	5	-50.3	-55.0	-44.0	-41.25	2.8
	Non HT-20 Beam Forming, 6 to 54 Mbps	2	8	-50.5	-59.5	-42.0	-41.25	0.7
	HT-20, M0 to M7	1	5	-48.3		-43.3	-41.25	2.1
	HT-20, M0 to M7	2	5	-50.0	-53.7	-43.5	-41.25	2.2
	HT-20, M8 to M15	2	5	-50.0	-53.7	-43.5	-41.25	2.2
	HT-20 Beam Forming, M0 to M7	2	8	-53.4	-59.9	-44.5	-41.25	3.3
	HT-20 Beam Forming, M8 to M15	2	5	-50.0	-53.7	-43.5	-41.25	2.2
	HT-20 STBC, M0 to M7	2	5	-50.0	-53.7	-43.5	-41.25	2.2
5190	Non HT-40, 6 to 54 Mbps	1	5	-47.3		-42.3	-41.25	1.1
	Non HT-40, 6 to 54 Mbps	2	5	-49.9	-50.8	-42.3	-41.25	1.1
	HT-40, M0 to M7	1	5	-46.6		-41.6	-41.25	0.4
	HT-40, M0 to M7	2	5	-49.9	-49.7	-41.8	-41.25	0.5
	HT-40, M8 to M15	2	5	-49.9	-49.7	-41.8	-41.25	0.5
	HT-40 Beam Forming, M0 to M7	2	8	-53.3	-53.7	-42.5	-41.25	1.2
	HT-40 Beam Forming, M8 to M15	2	5	-49.9	-49.7	-41.8	-41.25	0.5
	HT-40 STBC, M0 to M7	2	5	-49.9	-49.7	-41.8	-41.25	0.5

Frequency (MHz)	Mode	Tx Paths	Correlated Antenna Gain (dBi)	Tx 1 Bandedge Level (dBm)	Tx 2 Bandedge Level (dBm)	Total Tx Bandedge Level (dBm)	Limit (dBm)	Margin (dB)
5180	Non HT-20, 6 to 54 Mbps	1	5	-43.4		-38.4	-21.25	17.2
	Non HT-20, 6 to 54 Mbps	2	5	-46.3	-43.6	-36.7	-21.25	15.5
	Non HT-20 Beam Forming, 6 to 54 Mbps	2	8	-46.0	-47.3	-35.6	-21.25	14.3
	HT-20, M0 to M7	1	5	-41.4		-36.4	-21.25	15.2
	HT-20, M0 to M7	2	5	-42.0	-44.5	-35.1	-21.25	13.8
	HT-20, M8 to M15	2	5	-42.0	-44.5	-35.1	-21.25	13.8
	HT-20 Beam Forming, M0 to M7	2	8	-46.6	-47.1	-35.8	-21.25	14.6
	HT-20 Beam Forming, M8 to M15	2	5	-42.0	-44.5	-35.1	-21.25	13.8
	HT-20 STBC, M0 to M7	2	5	-42.0	-44.5	-35.1	-21.25	13.8
5190	Non HT-40, 6 to 54 Mbps	1	5	-38.7		-33.7	-21.25	12.5
	Non HT-40, 6 to 54 Mbps	2	5	-42.5	-41.7	-34.1	-21.25	12.8
	HT-40, M0 to M7	1	5	-37.0		-32.0	-21.25	10.8
	HT-40, M0 to M7	2	5	-41.2	-38.1	-31.4	-21.25	10.1
	HT-40, M8 to M15	2	5	-41.2	-38.1	-31.4	-21.25	10.1
	HT-40 Beam Forming, M0 to M7	2	8	-44.3	-45.3	-33.8	-21.25	12.5
	HT-40 Beam Forming, M8 to M15	2	5	-41.2	-38.1	-31.4	-21.25	10.1
	HT-40 STBC, M0 to M7	2	5	-41.2	-38.1	-31.4	-21.25	10.1

Conducted Bandedge Average, 5190 MHz, HT-40, M0 to M7

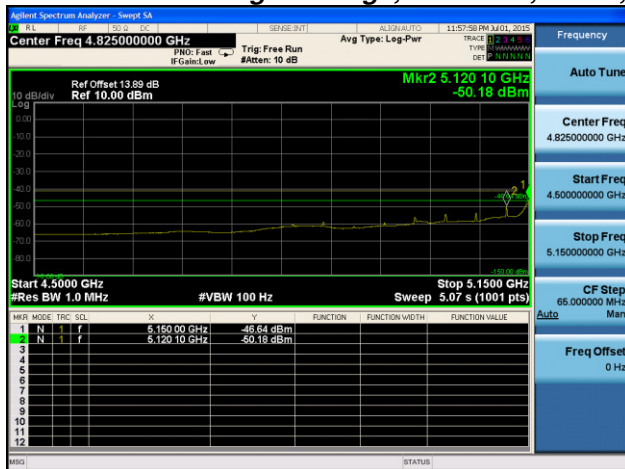

Antenna A

Conducted Bandedge Peak, 5190 MHz, HT-40, M0 to M7

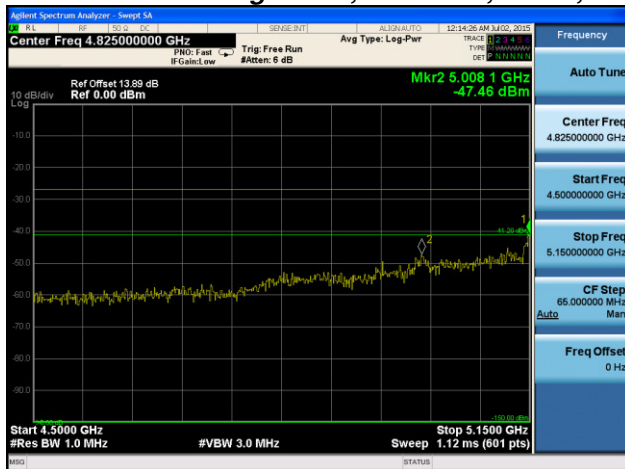

Antenna A

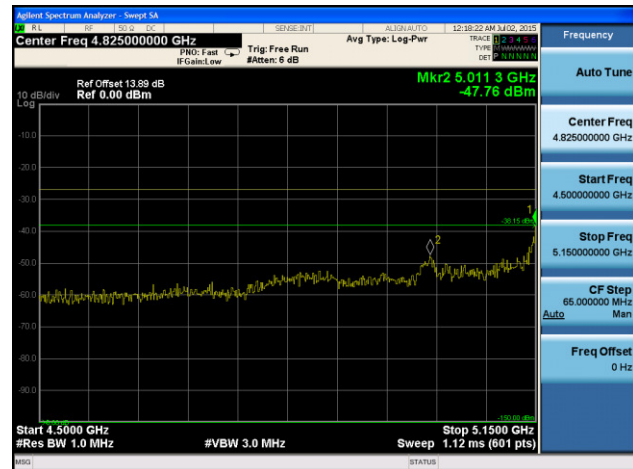

Antenna B

Appendix B: Emission Test Results

Testing Laboratory: Cisco Systems, Inc., 125 West Tasman Drive, San Jose, CA 95134, USA

Radiated Emission Setup Diagram-Below 1G

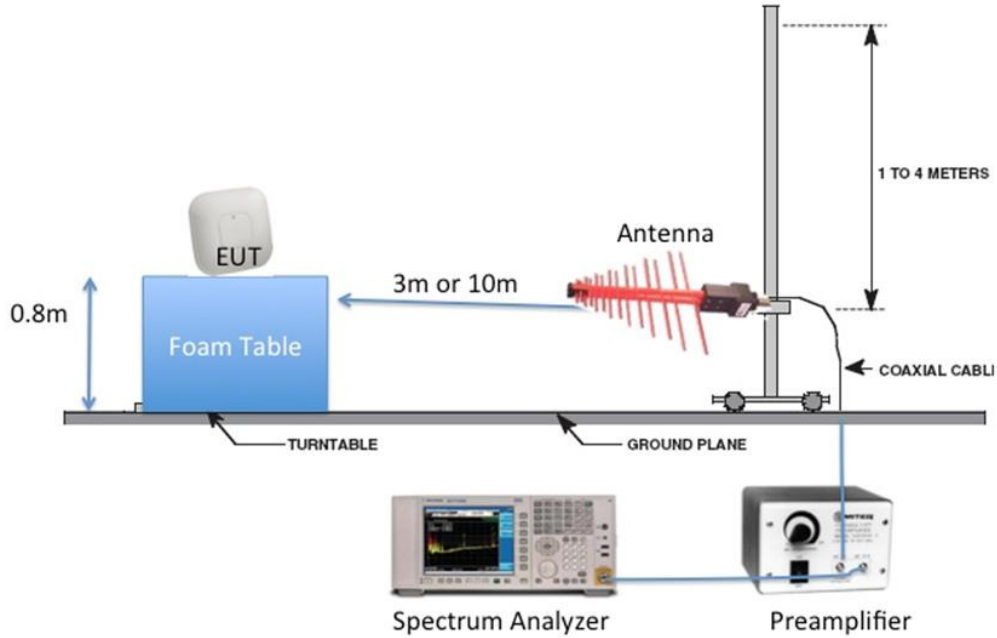

Radiated Emission Setup Diagram-Above 1G

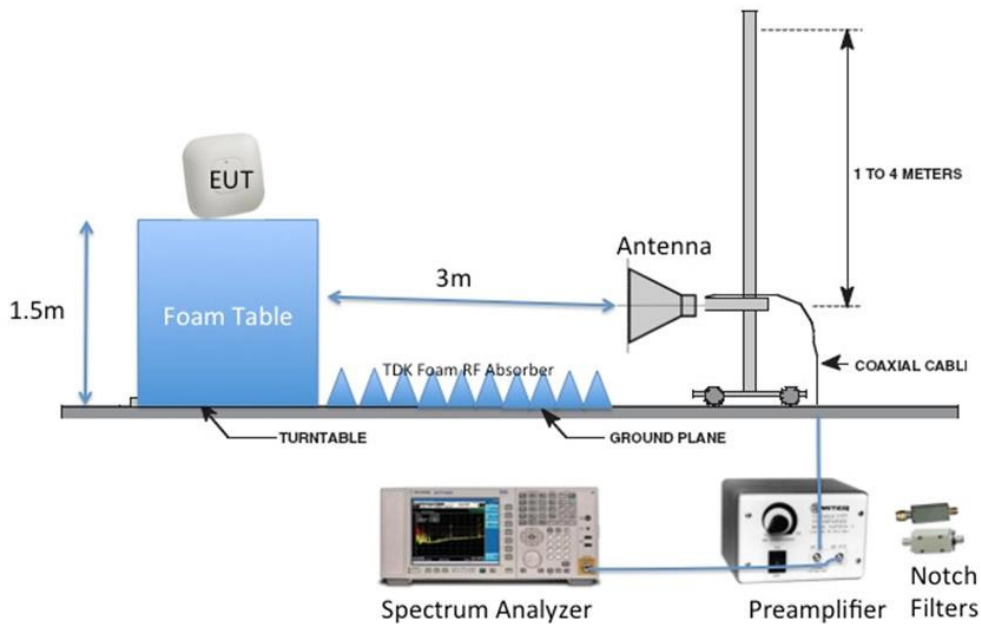

B.1 Radiated Spurious Emissions

FCC 15.205 / 15.407 Radiated emissions which fall in the restricted bands, as defined in Section 15.205(a), must also comply with the radiated emission limits specified in Section 15.209(a) (see Section 15.205(c)).

Ref. ANSI C63.10: 2013 section 12.7.6 (peak) & 12.7.7.3 (average)

Using Vasona, configure the spectrum analyzer as shown below (be sure to enter all losses between the transmitter output and the spectrum analyzer). Place the radio in continuous transmit mode.

Span:	1GHz – 18 GHz/18GHz-26G/26GHz-40GHz
Reference Level:	80 dBuV
Attenuation:	10 dB
Sweep Time:	Coupled
Resolution Bandwidth:	1MHz
Video Bandwidth:	3 MHz for peak, 1 KHz for average
Detector:	Peak

Terminate the access Point RF ports with 50 ohm loads.

Maximize Turntable (find worst case table angle), Maximize Antenna (find worst case height)

Save 2 plots: 1) Average plot (Vertical and Horizontal), Limit= 54dBuV/m @3m
 2) Peak plot (Vertical and Horizontal), Limit = 74dBuV/m @3m

Place a marker at the end of the restricted band closest to the transmit frequency to show compliance. Also measure any emissions in the restricted bands.

This report represents the worst case data for all supported operating modes and antennas. There are no measurable emissions above 18 GHz.

System Number	Description	Samples	System under test	Support equipment
1	EUT	S01	<input checked="" type="checkbox"/>	<input type="checkbox"/>
	Support	S02	<input type="checkbox"/>	<input checked="" type="checkbox"/>

Tested By : Jose Aguirre	Date of testing: 07-Jul-15 - 08-Aug-15
Test Result : PASS	

See Appendix C for list of test equipment

B.1.A Transmitter Radiated Spurious Emissions-Average worst case

Frequency (MHz)	Mode	Data Rate (Mbps)	Spurious Emission Level (dBuV/m)	Limit (dBuV/m)	Margin (MHz)
5180	Non HT-20, 6 to 54 Mbps	6	51.7	54	2.3
5190	Non HT-40, 6 to 54 Mbps	6	51.8	54	2.2
5230	Non HT-40, 6 to 54 Mbps	6	50.2	54	3.8
5240	Non HT-20, 6 to 54 Mbps	6	50.9	54	3.1



B.1.A.1 Radiated Transmitter Spurs, 5180 MHz, 6 to 54 Mbps , Average (1-18GHz)

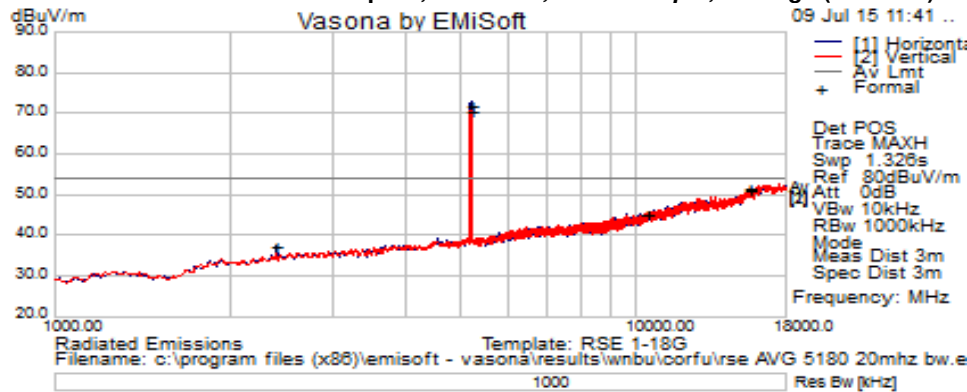

Frequency MHz	Raw dBuV	Cable Loss	AF dB	Level dBuV/m	Measurement Type	Pol	Hgt cm	Azt Deg	Limit dBuV/m	Margin dB	Pass /Fail
5182.688	63.99	9.4	-2.91	70.48	Average.	H	145	171	--	--	--
5182.844	65.31	9.4	-2.91	71.8	Average.	V	176	95	--	--	--
10360.453	28	13.5	3.8	45.3	Average.	H	145	171	54	-8.7	Pass
10360.568	27.9	13.5	3.8	45.2	Average.	V	176	95	54	-8.8	Pass
15537.256	30	17.2	4.5	51.7	Average.	H	145	171	54	-2.3	Pass
15537.859	29.4	17.2	4.5	51.1	Average.	V	176	95	54	-2.9	Pass
2402.727	32.73	6.35	-1.58	37.5	Average.	H	145	171	54	-16.5	Pass

B.1.A.2 Radiated Transmitter Spurs, 5190 MHz, HT/VHT40, M0 to M15, Average (1-18GHz)

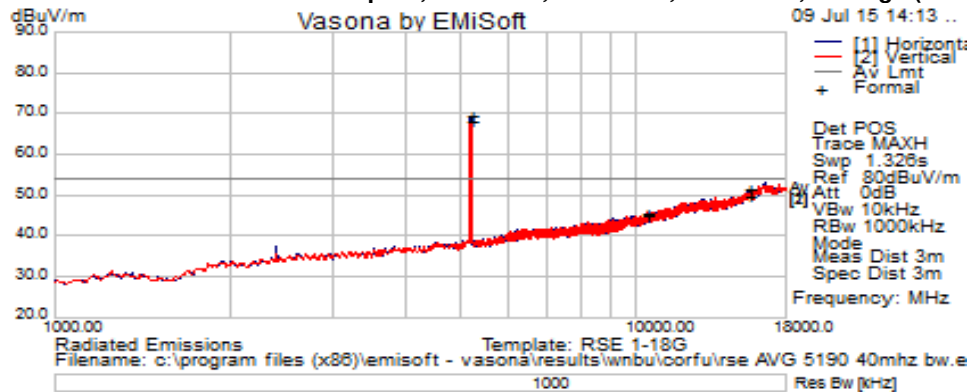

Frequency MHz	Raw dBuV	Cable Loss	AF dB	Level dBuV/m	Measurement Type	Pol	Hgt cm	Azt Deg	Limit dBuV/m	Margin dB	Pass /Fail
5185.433	63	9.4	-2.9	69.5	Average.	H	111	185	--	--	--
5187.868	61.7	9.4	-2.9	68.2	Average.	V	106	45	--	--	--
10381.49	28.3	13.5	3.8	45.7	Average.	V	106	45	54	-8.3	Pass
10382.548	27.6	13.5	3.8	45	Average.	H	111	185	54	-9	Pass
15568.894	28.3	17.2	4.4	49.8	Average.	H	111	185	54	-4.2	Pass
15569.018	30.3	17.2	4.4	51.8	Average.	V	106	45	54	-2.2	Pass



B.1.A.5 Radiated Transmitter Spurs, 5240 MHz, 6 to 54 Mbps , Average (1-18GHz)

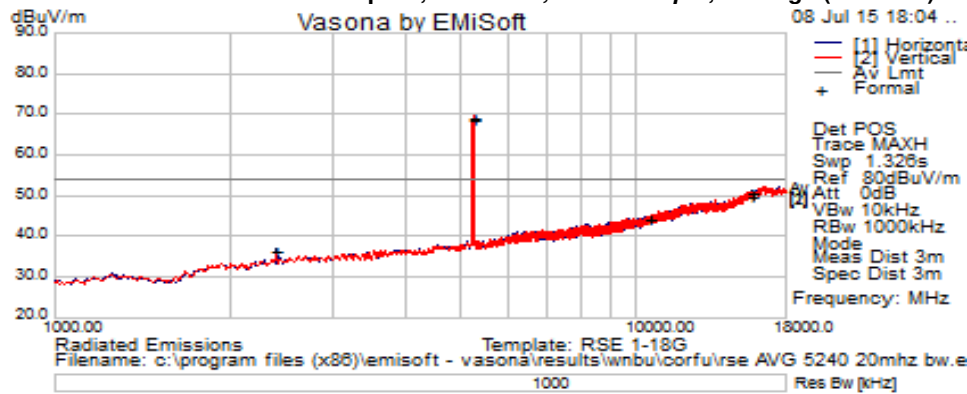

Frequency MHz	Raw dBuV	Cable Loss	AF dB	Level dBuV/m	Measurement Type	P ol	Hgt cm	Azt Deg	Limit dBuV/m	Margin dB	Pass /Fail
5242.905	62	9.5	-2.8	68.7	Average.	H	123	157	--	--	--
5246.27	62.4	9.5	-2.8	69.1	Average.	V	188	68	--	--	--
10478.992	26.3	13.6	4.4	44.3	Average.	H	124	157	54	-9.7	Pass
10480.3	26.5	13.6	4.3	44.5	Average.	V	188	68	54	-9.5	Pass
15718.208	29.1	17.3	4.5	50.9	Average.	H	124	157	54	-3.1	Pass
15719.792	27.7	17.3	4.5	49.6	Average.	V	188	68	54	-4.4	Pass
2403.171	31.8	6.35	-1.5	36.58	Average.	H	100	360	54	-17.42	Pass

B.1.A.6 Radiated Transmitter Spurs, 5230 MHz, HT/VHT40, M0 to M23, M0.0 to M9.4, Average (1-18GHz)

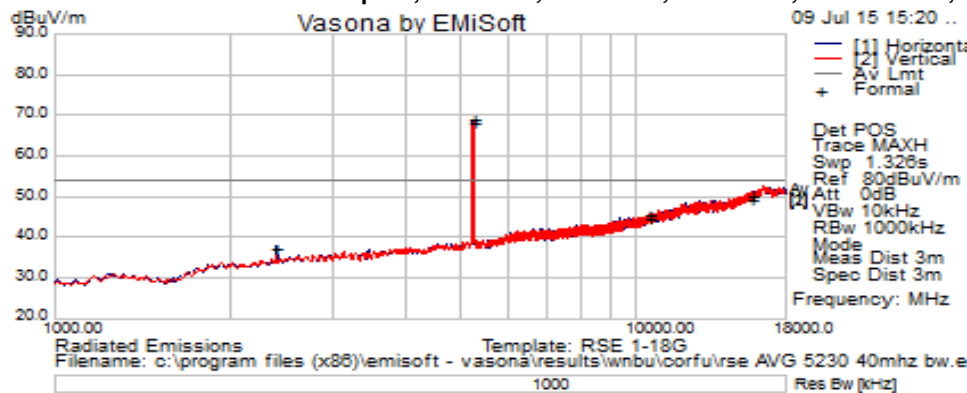

Frequency MHz	Raw dBuV	Cable Loss	AF dB	Level dBuV/m	Measurement Type	P ol	Hgt cm	Azt Deg	Limit dBuV/m	Margin dB	Pass /Fail
5228.125	62.7	9.5	-2.8	69.4	Average.	H	100	196	--	--	--
5243.438	61.4	9.5	-2.8	68.1	Average.	V	101	360	--	--	--
10461.254	27.5	13.6	4.3	45.5	Average.	H	101	360	54	-8.5	Pass
10462.129	26.61	13.62	4.35	44.58	Average.	V	101	360	54	-9.42	Pass
15689.691	28.6	17.3	4.3	50.2	Average.	H	101	360	54	-3.8	Pass
15690.933	27.58	17.3	4.33	49.21	Average.	V	101	360	54	-4.79	Pass
2402.705	32.8	6.35	-1.58	37.57	Average.	H	101	196	54	-16.43	Pass

B.1.A.7 Radiated Transmitter Spurs, All rate, All modes, Average (18-26.5GHz) Vertical

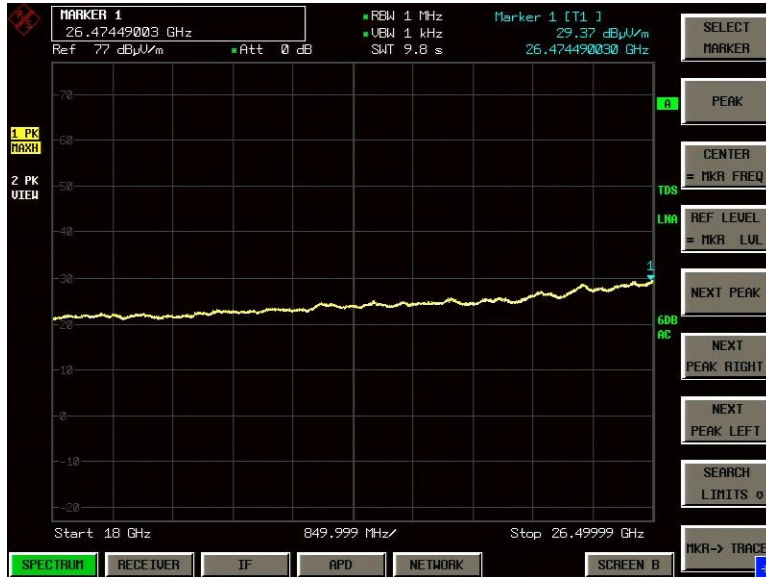

B.1.A.9 Radiated Transmitter Spurs, All rate, All modes, Average (26.5- 40GHz)



B.1.P Transmitter Radiated Spurious Emissions-Peak worst case

Frequency (MHz)	Mode	Data Rate (Mbps)	Spurious Emission Level (dBuV/m)	Limit (dBuV/m)	Margin (MHz)
5180	Non HT-20, 6 to 54 Mbps	6	63.9	74	10.1
5190	Non HT-40, 6 to 54 Mbps	6	61.1	74	12.9
5230	Non HT-40, 6 to 54 Mbps	6	61.5	74	12.5
5240	Non HT-20, 6 to 54 Mbps	6	63.0	74	11.0



B.1.P.1 Radiated Transmitter Spurs, 5180 MHz, 6 to 54 Mbps, (1-18GHz)

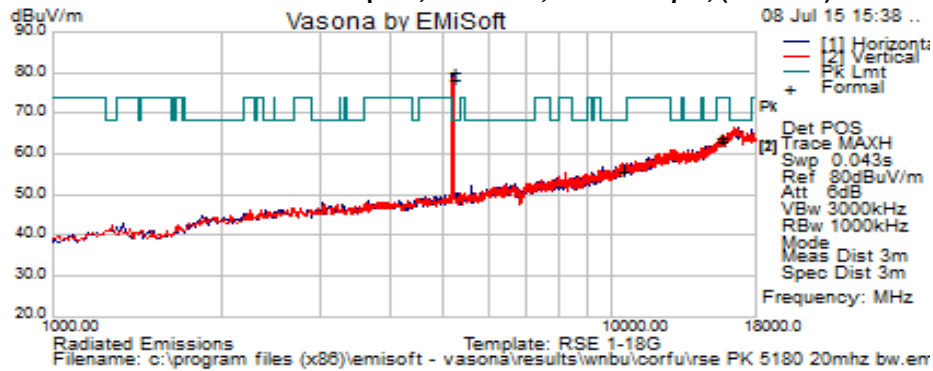

Frequency MHz	Raw dBuV	Cable Loss	AF dB	Level dBuV/m	Measurement Type	P ol	Hgt cm	Azt Deg	Limit dBuV/m	Margin dB	Pass /Fail
5185.438	73.68	9.4	-2.92	80.16	Peak.	H	145	168	--	--	--
5185.438	72.21	9.4	-2.92	78.69	Peak.	V	176	98	--	--	--
10359.055	38.38	13.54	3.77	55.69	Peak.	H	145	168	68.2	-12.51	Pass
10359.996	38.34	13.54	3.78	55.66	Peak.	V	176	98	68.2	-12.54	Pass
15537.445	41.4	17.22	4.49	63.11	Peak.	H	145	168	74	-10.89	Pass
15538.617	42.23	17.21	4.49	63.94	Peak.	V	176	98	74	-10.06	Pass

B.1.P.2 Radiated Transmitter Spurs, 5190 MHz, HT/VHT40, M0 to M23, M0.0 to M9.4, Peak (1-18GHz)

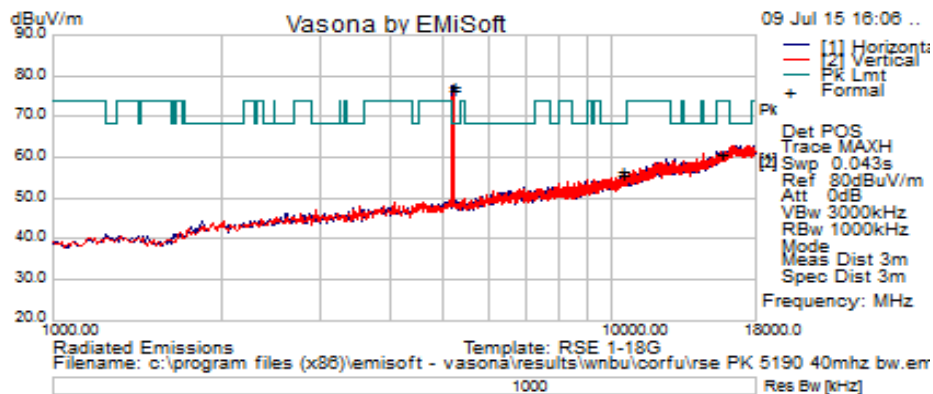

Frequency MHz	Raw dBuV	Cable Loss	AF dB	Level dBuV/m	Measurement Type	P ol	Hgt cm	Azt Deg	Limit dBuV/m	Margin dB	Pass /Fail
5185.433	71	9.4	-2.9	77.45	Peak.	H	111	185	--	--	--
5187.868	70.1	9.4	-2.9	76.6	Peak.	V	106	45	--	--	--
10382.166	38.5	13.54	3.83	55.87	Peak.	H	111	185	68.2	-12.33	Pass
10382.816	39.6	13.54	3.83	56.97	Peak.	V	106	45	68.2	-11.23	Pass
15569.308	39.27	17.17	4.36	60.8	Peak.	H	111	185	74	-13.2	Pass
15568.424	39.5	17.17	4.37	61.04	Peak.	V	106	45	74	-12.96	Pass



B.1.P.5 Radiated Transmitter Spurs, 5240 MHz, 6 to 54 Mbps , Peak (1-18GHz)

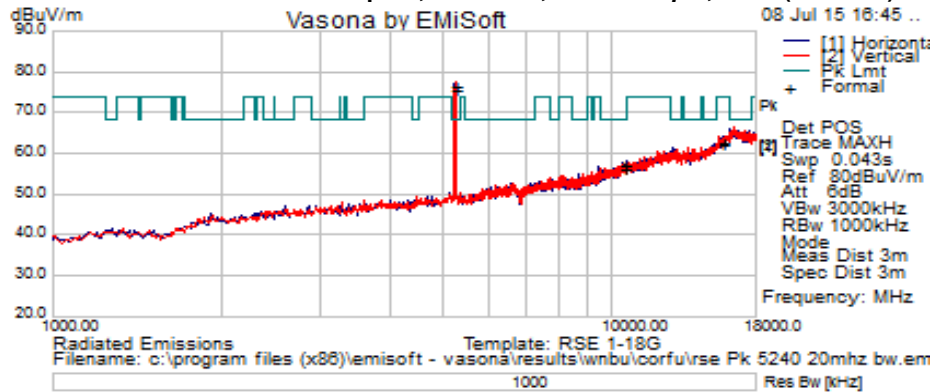

Frequency MHz	Raw dBuV	Cable Loss	AF dB	Level dBuV/m	Measurement Type	P ol	Hgt cm	Azt Deg	Limit dBuV/m	Margin dB	Pass /Fail
5242.905	69.14	9.48	-2.77	75.85	Peak.	H	123	157	--	--	--
5246.27	69.97	9.48	-2.77	76.68	Peak.	V	188	68	--	--	--
10478.992	39.27	13.63	4.35	57.25	Peak.	H	124	157	68.2	-10.95	Pass
10480.3	38.56	13.63	4.34	56.53	Peak.	V	188	68	68.2	-11.67	Pass
15718.208	40.6	17.31	4.53	62.44	Peak.	H	124	157	74	-11.56	Pass
15719.792	41.1	17.32	4.54	62.96	Peak.	V	188	68	74	-11.04	Pass

B.1.P.6 Radiated Transmitter Spurs, 5230 MHz, HT/VHT40, M0 to M23, M0.0 to M9.4, Peak (1-18GHz)

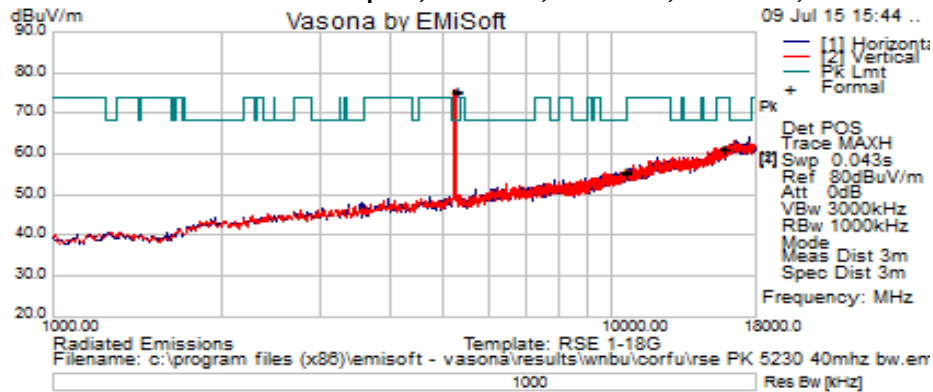

Frequency MHz	Raw dBuV	Cable Loss	AF dB	Level dBuV/m	Measurement Type	P ol	Hgt cm	Azt Deg	Limit dBuV/m	Margin dB	Pass /Fail
5228.125	69.1	9.45	-2.75	75.8	Peak.	H	100	196	--	--	--
5243.438	68.39	9.48	-2.77	75.1	Peak.	V	101	360	--	--	--
10461.254	37.9	13.6	4.3	55.9	Peak.	H	101	360	68.2	-12.3	Pass
10462.129	37.2	13.6	4.3	55.2	Peak.	V	101	360	68.2	-13	Pass
15689.691	39.6	17.3	4.3	61.2	Peak.	H	101	360	74	-12.8	Pass
15690.933	39.9	17.3	4.3	61.5	Peak.	V	101	360	74	-12.5	Pass

B.1.P.7 Radiated Transmitter Spurs, All rate, All modes, Peak (18-26.5GHz) Horizontal & Vertical

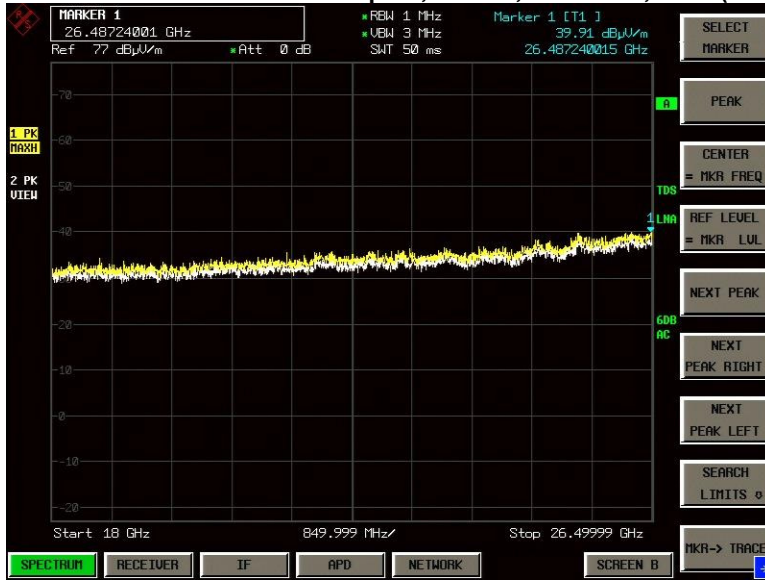

B.1.P.8 Radiated Transmitter Spurs, All rate, All modes, Peak (26.5-40GHz) Horizontal & Vertical



B.2 Radiated Emissions 30MHz to 1GHz

FCC 15.209 / 15.205 / 15.407 Radiated emissions which fall in the restricted bands, as defined in Section 15.205(a), must also comply with the radiated emission limits specified in Section 15.209(a) (see Section 15.205(c)).

Ref. ANSI C63.10: 2013 section 6.5

Using Vasona, configure the spectrum analyzer as shown below (be sure to enter all losses between the transmitter output and the spectrum analyzer). Place the radio in continuous transmit mode.

Span:	30MHz – 1GHz
Reference Level:	80 dBuV
Attenuation:	10 dB
Sweep Time:	Coupled
Resolution Bandwidth:	100kHz
Video Bandwidth:	300kHz
Detector:	Peak for Pre-scan, Quasi-Peak

Compliance shall be determined using CISPR quasi-peak detection; however, peak detection is permitted as an alternative to quasi-peak detection.

Terminate the access Point RF ports with 50 ohm loads.

Maximize Turntable (find worst case table angle), Maximize Antenna (find worst case height)

This report represents the worst case data for all supported operating modes and antennas.

System Number	Description	Samples	System under test	Support equipment
1	EUT	S01	<input checked="" type="checkbox"/>	<input type="checkbox"/>
	Support	S02	<input type="checkbox"/>	<input checked="" type="checkbox"/>

Tested By : Jose Aguirre	Date of testing: 07-Jul-15 - 08-Aug-15
Test Result : PASS	

See Appendix C for list of test equipment

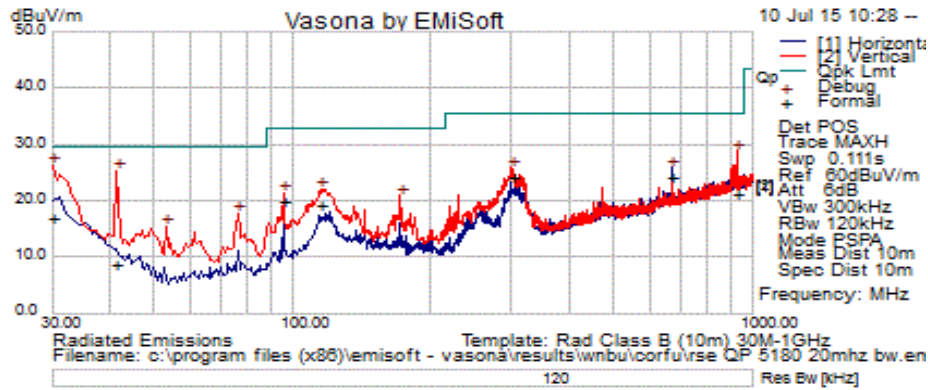

Frequency MHz	Raw dBuV	Cable Loss	AF dB	Level dBuV/m	Measurement Type	Po l	Hgt cm	Azt Deg	Limit dBuV/m	Margin dB	Pass /Fail
924.752	23.1	3.4	-5.3	21.2	Quasi Max	V	284	21	35.5	-14.4	Pass
30.001	23.4	0.6	-6.9	17.1	Quasi Max	V	203	21	29.5	-12.4	Pass
41.371	23.4	0.8	-15.4	8.8	Quasi Max	V	146	132	29.5	-20.7	Pass
115.497	32	1.3	-14.2	19.2	Quasi Max	V	126	169	33	-13.8	Pass
300.022	35.8	2.1	-13.7	24.1	Quasi Max	V	109	172	35.5	-11.4	Pass
670.009	30.1	2.8	-8.6	24.3	Quasi Max	H	391	225	35.5	-11.2	Pass
95.374	37.6	1.1	-18.8	20	Quasi Max	V	162	324	33	-13	Pass

B.3 AC Conducted Emissions

FCC 15.207 Except when the requirements applicable to a given device state otherwise, for any radio apparatus equipped to operate from the public utility AC power supply, either directly or indirectly (such as with a battery charger), the radio frequency voltage of emissions conducted back onto the AC power lines in the frequency range of 0.15 MHz to 30 MHz shall not exceed the limits shown in the table in these sections. The more stringent limit applies at the frequency range boundaries.

Measurement Procedure

Accordance with ANSI C63.10:2013 section 6.2

Using Vasona, configure the spectrum analyzer as shown below (be sure to enter all losses between the transmitter output and the spectrum analyzer). Place the radio in continuous transmit mode.

Span:	150 KHz – 30 MHz
Attenuation:	10 dB
Sweep Time:	Coupled
Resolution Bandwidth:	9 KHz
Video Bandwidth:	30 KHz
Detector:	Quasi-Peak / Average

System Number	Description	Samples	System under test	Support equipment
1	EUT	S01	<input checked="" type="checkbox"/>	<input type="checkbox"/>
	Support	S02	<input type="checkbox"/>	<input checked="" type="checkbox"/>

Tested By : Jose Aguirre	Date of testing: 07-Jul-15 - 08-Aug-15
Test Result : PASS	

See Appendix C for list of test equipment



Graphical Test Results

Note that the data displayed on the plots detailed in this appendix were measured using a 'Peak Detector'. Please refer to the results table for the detectors used during formal measurements

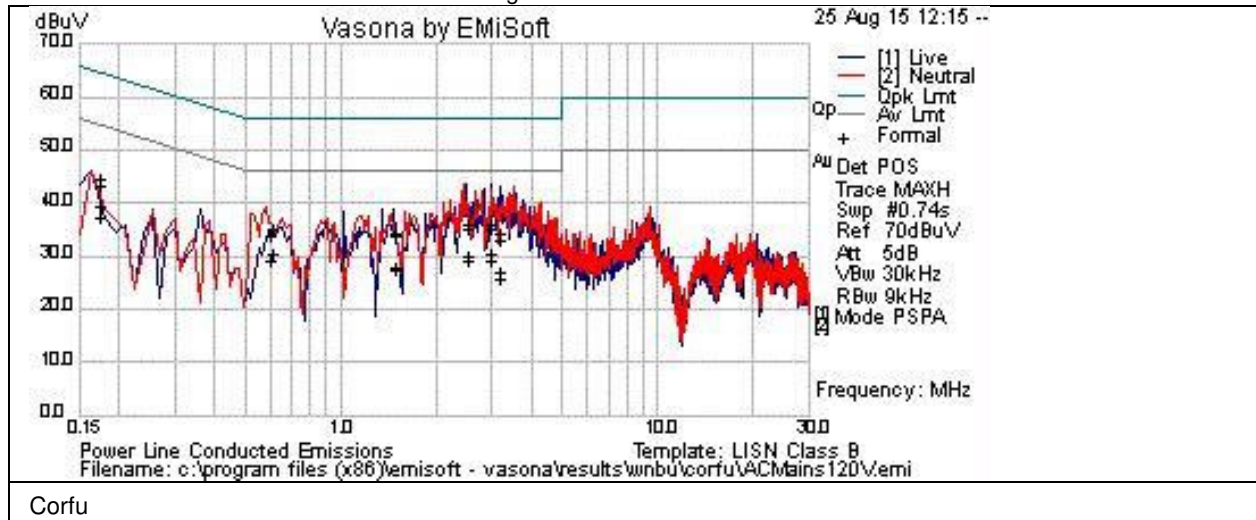

Test Results Table

Frequency MHz	Raw dBuV	Cable Loss	Factors dB	Level dBuV	Measurement Type	Line	Limit dBuV	Margin dB	Pass /Fail	Comments
0.606	15	20	0	35	Qp	L	56	-21	Pass	
2.508	16.2	20	0	36.2	Qp	L	56	-19.8	Pass	
2.986	16.2	20	0.1	36.2	Qp	L	56	-19.8	Pass	
0.173	23.6	20.9	0	44.6	Qp	L	64.8	-20.2	Pass	
1.478	14.5	20	0	34.5	Qp	L	56	-21.5	Pass	
3.18	14.3	20	0	34.3	Qp	L	56	-21.7	Pass	
2.986	15	20	0.1	35	Qp	N	56	-21	Pass	
2.508	15.1	20	0	35.1	Qp	N	56	-20.9	Pass	
3.18	12.8	20	0	32.8	Qp	N	56	-23.2	Pass	
0.604	13.7	20	0	33.8	Qp	N	56	-22.2	Pass	
0.173	22.4	20.9	0	43.4	Qp	N	64.8	-21.4	Pass	
1.478	13.9	20	0	33.9	Qp	N	56	-22.1	Pass	
0.606	10.4	20	0	30.4	Av	L	46	-15.6	Pass	
2.508	10.1	20	0	30.1	Av	L	46	-15.9	Pass	
2.986	10.6	20	0.1	30.7	Av	L	46	-15.3	Pass	
0.173	18.5	20.9	0	39.5	Av	L	54.8	-15.3	Pass	
1.478	7.9	20	0	27.9	Av	L	46	-18.1	Pass	
3.18	7	20	0	27.1	Av	L	46	-18.9	Pass	
2.986	9.3	20	0.1	29.3	Av	N	46	-16.7	Pass	
2.508	9.3	20	0	29.3	Av	N	46	-16.7	Pass	
3.18	5.6	20	0	25.7	Av	N	46	-20.3	Pass	
0.604	9	20	0	29.1	Av	N	46	-16.9	Pass	
0.173	16.5	20.9	0	37.5	Av	N	54.8	-17.4	Pass	
1.478	7.4	20	0	27.4	Av	N	46	-18.6	Pass	

Photographs of setup



Title: AIR-CAP1532I-B-K9 Conducted Test Setup

This is a dual band 2.4GHz / 5GHz device. All ports in this test set up photo are connected as all testing is automated. Section 2.6 of this test report given an overview of the different Tx antenna combinations used by this device.

AIR-CAP1532I-B-K9 AC Mains Conducted Emissions setup

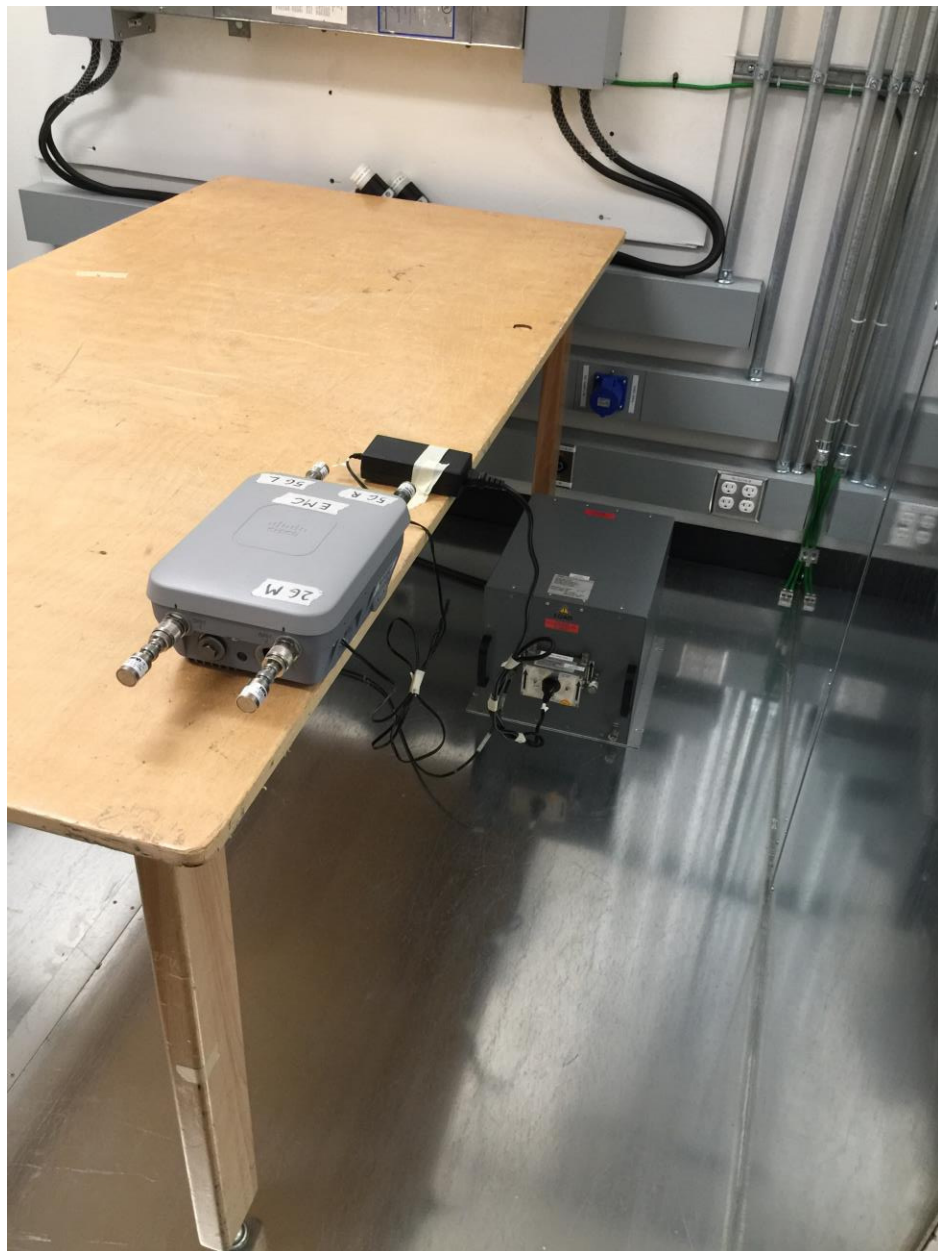

AIR-CAP1532I-B-K9 Radiated Emissions setup 30MHz – 1GHz

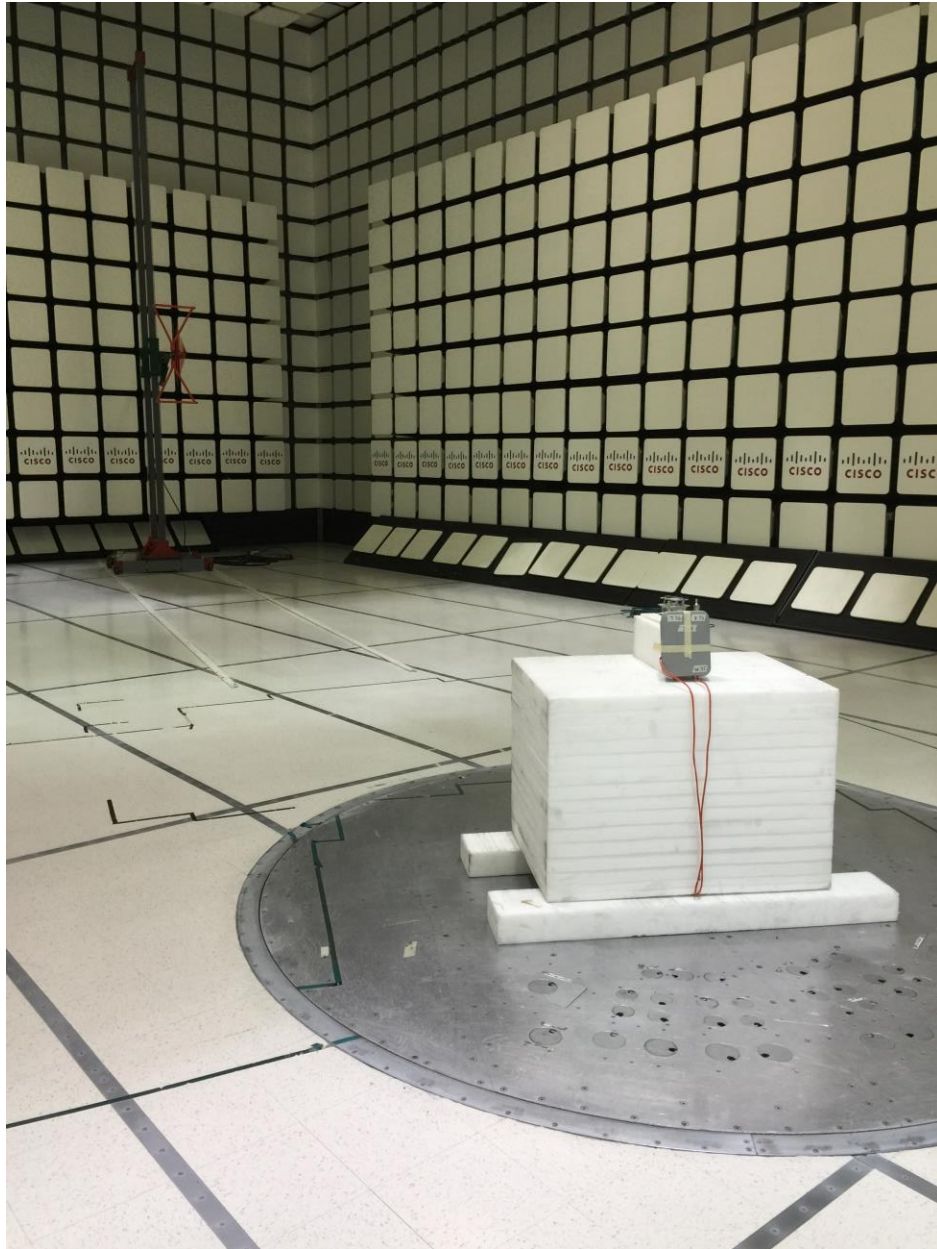

AIR-CAP1532I-B-K9 Radiated Emissions setup above 1GHz

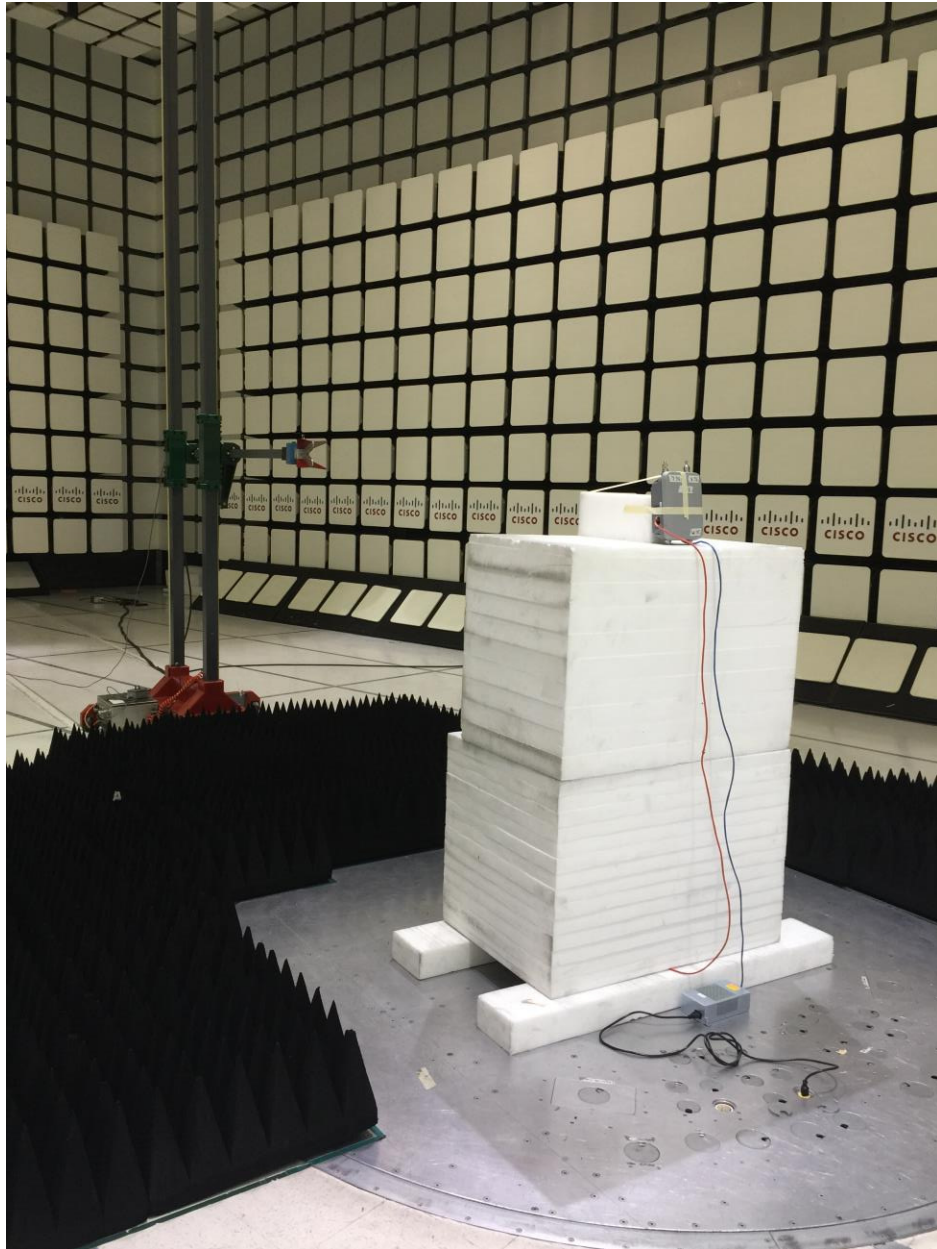

Appendix C: List of Test Equipment Used to perform the test

Equip#	Manufacturer/ Model	Description	Last Cal	Next Due	Test Item
Test Equipment used for Radiated Emissions					
CIS008447	Cisco / NSA 10m Chamber	NSA 10m Chamber	14-Oct-14	14-Oct-15	B.2
CIS030652	Sunol Sciences / JB1	Combination Antenna, 30MHz-2GHz	5-Nov-14	5-Nov-15	B.2
CIS033988	Agilent /E4446A	PSA Spectrum Analyzer	9-Dec-14	9-Dec-15	B.1
CIS044940	ROHDE & SCHWARZ / ESU40	EMI RECEIVER, 40GHZ	27-May-15	27-May-16	B.1
CIS041929	Newport /iBTHP-5-DB9	5 inch Temp/RH/Press Sensor w/20ft cable	20-Dec-14	20-Dec-15	B.1, B.2
CIS024998	MICRO-COAX / UFB197C-1-0240-504504	Coaxial RF Cable, 26.5 GHz	11-Mar-15	11-Mar-16	B.1, B.2
CIS035284	ETS Lindgren / 3117	Double Ridged Horn Antenna	16-Sep-14	16-Sep-15	B.1
CIS049516	Keysight / N9030A	PXA Spectrum Analyzer	12-Nov-14	12-Nov-15	B.1, B.2
CIS043124	Cisco /Above 1GHz Site Cal	Above 1GHz Cspr Site Verification	15-Jan-15	15-Jan-16	B.1
CIS008166	HP / 8491B Opt 010	10dB Attenuator	2-Feb-15	2-Feb-16	B.1
CIS020975	Micro-Coax / UFB311A-0-1344-520520	RF Coaxial Cable, to 18GHz, 134.4 in	18-Feb-15	18-Feb-16	B.1, B.2
CIS030559	Micro-Coax / UFB311A-1-0950-504504	RF Coaxial Cable, to 18GHz, 95 in	20-Feb-15	20-Feb-16	B.1, B.2
CIS003003	HP / 83731B	Synthesized Signal Generator	13-Mar-15	13-Mar-16	B.1
CIS005691	Miteq / NSP1800-25-S1	Broadband Preamplifier (1-18GHz)	25-Jun-15	25-Jun-16	B.1
CIS041979	Cisco / 1840	18-40GHz EMI Test Head/Verification Fixture	13-Jul-15	13-Jul-16	B.1
CIS047410	Agilent / N9038A	EMI Receiver	17-Feb-15	17-Feb-16	B.1, B.2
CIS051642	Huber+Suhner / Sucoflex 106PA	RF N Type Cable 8.5m	10-Feb-15	10-Feb-16	B.1, B.2
Test Equipment used for AC Mains Conducted Emissions					
CIS008192	Fischer Custom Communications FCC-450B-2.4-N	Instrumentation Limiter	28-JUL-15	28-JUL-16	B.3
CIS008197	TTE /H613-150K-50-21378	Hi Pass Filter - 150KHz cutoff	16-APR-15	16-APR-16	B.3
CIS008471	Bird / 5-T-MB	50 Ohm, 5W Terminator, Type BNC	18-SEP-14	18-SEP-15	B.3
CIS019337	Fischer Custom Communications FCC-LISN-50/250-50-2-01	LISN	08-SEP-14	08-SEP-15	B.3
CIS019136	Fischer Custom Communications FCC-801-M3-32A	Power Line Coupling/Decoupling Network	12-NOV-14	12-NOV-15	B.3
CIS023874	Fischer Custom Communications FCC-LISN-PA-NEMA-5-15	Power Adaptor, Polarized 120VAC	08-SEP-14	08-SEP-15	B.3
CIS035235	Lufkin / HY1035CME	5 Meter Tape Measure	Cal Not Required	N/A	B.3
CIS036031	York / CNE V	Comparison Noise Emitter	Cal Not Required	N/A	B.3
CIS039110	Coleman /RG-223	25 ft BNC cable	24-NOV-14	24-NOV-15	B.3
CIS045050	ROHDE & SCHWARZ/ ESCI	EMI Test Receiver	31-Oct-2014	31 Oct 2015	B.3
RF Conducted at output antenna port					
CIS050721	N9030A/ Keysight	PXA Signal Analyzer	13-Apr-16	13-Apr-16	A1 thru A4
CIS054609	ZFSC-2-10G /Mini-Circuits	Splitter	01-June-15	01-June-16	A1 thru A4

CIS054608	D3C2060 / Ditom	Splitter	01-June-15	01-June-16	A1 thru A4
CIS054607	PS4-09-452/4S/ Pulsar	Splitter	01-June-15	01-June-16	A1 thru A4
CIS054606	BRC50705-02/ Micro-Tronics	Notch Filter	01-June-15	01-June-16	A1 thru A4
CIS054605	BRC50703-02 / Micro-Tronics	Notch Filter	01-June-15	01-June-16	A1 thru A4
CIS054604	BRC50704-02/ Micro-Tronics	Notch Filter	01-June-15	01-June-16	A1 thru A4
CIS054603	BRM50702-02/ Micro-Tronics	Notch Filter	01-June-15	01-June-16	A1 thru A4
CIS054637	BWS30-W2/ Aeroflex	SMA 30dB Attenuator	02-June-15	02-June-16	A1 thru A4
CIS054636	BWS20-W2/ Aeroflex	20dB SMA Attenuator	02-June-15	02-June-16	A1 thru A4
CIS054625	RA08-S1S1-24/Megaphase	SMA cable 24"	02-June-15	02-June-16	A1 thru A4
CIS054624	RA08-S1S1-18/Megaphase	SMA cable 18"	02-June-15	02-June-16	A1 thru A4
CIS054623	RA08-S1S1-18/Megaphase	SMA cable 18"	02-June-15	02-June-16	A1 thru A4
CIS054622	RA08-S1S1-18/Megaphase	SMA cable 18"	02-June-15	02-June-16	A1 thru A4
CIS054621	RA08-S1S1-18/Megaphase	SMA cable 18"	02-June-15	02-June-16	A1 thru A4

Appendix E: Abbreviation Key and Definitions

The following table defines abbreviations used within this test report.

Abbreviation	Description	Abbreviation	Description
EMC	Electro Magnetic Compatibility	°F	Degrees Fahrenheit
EMI	Electro Magnetic Interference	°C	Degrees Celsius
EUT	Equipment Under Test	Temp	Temperature
ITE	Information Technology Equipment	S/N	Serial Number
TAP	Test Assessment Schedule	Qty	Quantity
ESD	Electro Static Discharge	emf	Electromotive force
EFT	Electric Fast Transient	RMS	Root mean square
EDCS	Engineering Document Control System	Qp	Quasi Peak
Config	Configuration	Av	Average
CIS#	Cisco Number (unique identification number for Cisco test equipment)	Pk	Peak
Cal	Calibration	kHz	Kilohertz (1×10^3)
EN	European Norm	MHz	MegaHertz (1×10^6)
IEC	International Electro technical Commission	GHz	Gigahertz (1×10^9)
CISPR	International Special Committee on Radio Interference	H	Horizontal
CDN	Coupling/Decoupling Network	V	Vertical
LISN	Line Impedance Stabilization Network	dB	decibel
PE	Protective Earth	V	Volt
GND	Ground	kV	Kilovolt (1×10^3)
L1	Line 1	μ V	Microvolt (1×10^{-6})
L2	Line2	A	Amp
L3	Line 3	μ A	Micro Amp (1×10^{-6})
DC	Direct Current	mS	Milli Second (1×10^{-3})
RAW	Uncorrected measurement value, as indicated by the measuring device	μ S	Micro Second (1×10^{-6})
RF	Radio Frequency	μ S	Micro Second (1×10^{-6})
SLCE	Signal Line Conducted Emissions	m	Meter
Meas dist	Measurement distance	Spec dist	Specification distance
N/A or NA	Not Applicable	SL	Signal Line (or Telecom Line)
P	Power Line	L	Live Line
N	Neutral Line	R	Return
S	Supply	AC	Alternating Current

End