



Dynamic Frequency Selection (DFS) Test Report

AIR-CAP1532I-A-K9

Cisco Aironet 802.11n Dual Band Mesh Access Point

FCC ID: LDK102090P

IC: 2461B-102090P

Also covers:

AIR-CAP1532I-T-K9, AIR-CAP1532I -Z-K9

5250-5350, 5470-5725 MHz

Against the following Specifications:

CFR47 Part 15.407

RSS210

LP0002

Cisco Systems

170 West Tasman Drive

San Jose, CA 95134

Test Engineer: *Bud Chiller*

Date: *9-16-2013*



This test report has been electronically authorized and archived using the CISCO Engineering Document Control system.

1.0	UNII DEVICE DESCRIPTION	2
2.0	DFS DETECTION THRESHOLDS	3
3.0	RADAR TEST WAVEFORMS	4
4.0	RADAR WAVEFORM CALIBRATION	7
5.0	TEST PROCEDURE/RESULTS	10
	<i>UNII DETECTION BANDWIDTH RESULTS, 20MHZ SIGNAL BANDWIDTH</i>	<i>14</i>
	<i>INITIAL CHANNEL AVAILABILITY CHECK TIME.....</i>	<i>26</i>
	<i>RADAR BURST AT THE BEGINNING OF THE CHANNEL AVAILABILITY CHECK TIME.....</i>	<i>27</i>
	<i>RADAR BURST AT THE END OF THE CHANNEL AVAILABILITY CHECK TIME.....</i>	<i>28</i>
	<i>CHANNEL MOVE TIME, CHANNEL CLOSING TRANSMISSION TIME FOR USA BIN 1</i>	<i>30</i>
	<i>30 MINUTE NON-OCCUPANCY PERIOD (USING TYPE 1 RADAR)</i>	<i>33</i>
	<i>USA BIN 1 RADAR STATISTICAL PERFORMANCE.....</i>	<i>35</i>
	<i>USA BIN 2 RADAR STATISTICAL PERFORMANCE.....</i>	<i>36</i>
	<i>USA BIN 3 RADAR STATISTICAL PERFORMANCE.....</i>	<i>37</i>
	<i>USA BIN 4 RADAR STATISTICAL PERFORMANCE.....</i>	<i>38</i>



Dynamic Frequency Selection (DFS) Test Results

15.407: U-NII devices operating in the 5.25-5.35 GHz band and the 5.47-5.725 GHz band shall employ a TPC mechanism. The U-NII device is required to have the capability to operate at least 6 dB below the mean EIRP value of 30 dBm. A TPC mechanism is not required for systems with an e.i.r.p. of less than 500 mW.

U-NII devices operating in the 5.25-5.35 GHz and 5.47-5.725 GHz bands shall employ a DFS radar detection mechanism to detect the presence of radar systems and to avoid co-channel operation with radar systems.

1.0 UNII Device Description

1. The AIR-CAP1532I Series Cisco Aironet 802.11n Access Point operates in the following bands:
 - a. 5250-5350 MHz
 - b. 5470-5725 MHz (excluding 5600-5650 MHz)
 - c. 5725-5850 MHz
2. The maximum EIRP of the 5GHz equipment is 32 dBm, and the minimum possible EIRP is 11 dBm.

Below are the available 50 ohm antenna assemblies and their corresponding gains. 0dBi gain was used to set the -63 dBm threshold level (-64dBm +1 dB) during calibration of the test setup.

Frequency	Part Number	Antenna Type	Antenna Gain (dBi)
2.4/5GHz	Internal	Dual band omnidirectional	3/5

3. System testing was performed with the designated MPEG test file that streams full motion video at 30 frames per second from the Master to the Client IP based system.
4. The Master requires 106.5 seconds to complete its power-on cycle.
5. Information regarding the parameters of the detected Radar Waveforms is not available to the end user.
6. For the 5250-5350 MHz and 5470-5725 MHz bands, the Master device provides, on aggregate, uniform loading of the spectrum across all devices by selecting an operating channel among the available channels using a random algorithm.

2.0 DFS Detection Thresholds

1. Interference Threshold values, Master or Client incorporating In-Service Monitoring

Maximum Transmit Power	Value (see note)
≥ 200 milliwatt	-64 dBm
< 200 milliwatt	-62 dBm
Note 1: This is the level at the input of the receiver assuming a 0 dBi receive antenna Note 2: Throughout these test procedures an additional 1 dB has been added to the amplitude of the test transmission waveforms to account for variations in measurement equipment. This will ensure that the test signal is at or above the detection threshold level to trigger a DFS response.	

2. DFS Response requirement values

Parameter	Value
<i>Non-occupancy period</i>	Minimum 30 minutes
<i>Channel Availability Check Time</i>	60 seconds
<i>Channel Move Time</i>	10 seconds See Note 1.
<i>Channel Closing Transmission Time</i>	200 milliseconds + an aggregate of 60 milliseconds over remaining 10 second period. See Notes 1 and 2.
<i>U-NII Detection Bandwidth</i>	Minimum 80% of the 99% power bandwidth See Note 3.
Note 1: The instant that the <i>Channel Move Time</i> and the <i>Channel Closing Transmission Time</i> begins is as follows: <ul style="list-style-type: none"> • For the Short pulse radar Test Signals this instant is the end of the <i>Burst</i>. • For the Frequency Hopping radar Test Signal, this instant is the end of the last radar <i>Burst</i> generated. • For the Long Pulse radar Test Signal this instant is the end of the 12 second period defining the radar transmission. Note 2: The <i>Channel Closing Transmission Time</i> is comprised of 200 milliseconds starting at the beginning of the <i>Channel Move Time</i> plus any additional intermittent control signals required to facilitate <i>Channel</i> changes (an aggregate of 60 milliseconds) during the remainder of the 10 second period. The aggregate duration of control signals will not count quiet periods in between transmissions. Note 3: During the <i>U-NII Detection Bandwidth</i> detection test, radar type 1 is used and for each frequency step the minimum percentage of detection is 90%. Measurements are performed with no data traffic.	

3.0 Radar Test Waveforms

This section provides the parameters for required test waveforms, minimum percentage of successful detections, and the minimum number of trials that must be used for determining DFS conformance. Step intervals of 0.1 microsecond for Pulse Width, 1 microsecond for PRI, 1 MHz for chirp width and 1 for the number of pulses will be utilized for the random determination of specific test waveforms.

1. Short Pulse Radar Test Waveforms

Radar Type	Pulse Width (μsec)	PRI (μsec)	Number of Pulses	Minimum Percentage of Successful Detection	Minimum Trials
1	1	1428	18	60%	30
2	1-5	150-230	23-29	60%	30
3	6-10	200-500	16-18	60%	30
4	11-20	200-500	12-16	60%	30
Aggregate (Radar Types 1-4)				80%	120

A minimum of 30 unique waveforms are required for each of the short pulse radar types 2 through 4. For short pulse radar type 1, the same waveform is used a minimum of 30 times. If more than 30 waveforms are used for short pulse radar types 2 through 4, then each additional waveform must also be unique and not repeated from the previous waveforms. The aggregate is the average of the percentage of successful detections of short pulse radar types 1-4.

2. Long Pulse Radar Test Waveform

Radar Type	Pulse Width (μsec)	Chirp Width (MHz)	PRI (μsec)	Number of Pulses per Burst	Number of Bursts	Minimum Percentage of Successful Detection	Minimum Trials
5	50-100	5-20	1000-2000	1-3	8-20	80%	30

The parameters for this waveform are randomly chosen. Thirty unique waveforms are required for the Long Pulse radar test signal. If more than 30 waveforms are used for the Long Pulse radar test signal, then each additional waveform must also be unique and not repeated from the previous waveforms.

Each waveform is defined as follows:

- 1) The transmission period for the Long Pulse Radar test signal is 12 seconds.
- 2) There are a total of 8 to 20 Bursts in the 12 second period, with the number of Bursts being randomly chosen. This number is Burst_Count.
- 3) Each Burst consists of 1 to 3 pulses, with the number of pulses being randomly chosen. Each Burst within the 12 second sequence may have a different number of pulses.
- 4) The pulse width is between 50 and 100 microseconds, with the pulse width being randomly chosen. Each pulse within a Burst will have the same pulse width. Pulses in different Bursts may have different pulse widths.

- 5) Each pulse has a linear FM chirp between 5 and 20 MHz, with the chirp width being randomly chosen. Each pulse within a Burst will have the same chirp width. Pulses in different Bursts may have different chirp widths. The chirp is centered on the pulse. For example, with a radar frequency of 5300 MHz and a 20 MHz chirped signal, the chirp starts at 5290 MHz and ends at 5310 MHz.
- 6) If more than one pulse is present in a Burst, the time between the pulses will be between 1000 and 2000 microseconds, with the time being randomly chosen. If three pulses are present in a Burst, the time between the first and second pulses is chosen independently of the time between the second and third pulses.
- 7) The 12 second transmission period is divided into even intervals. The number of intervals is equal to Burst_Count. Each interval is of length $(12,000,000 / \text{Burst_Count})$ microseconds. Each interval contains one Burst. The start time for the Burst, relative to the beginning of the interval, is between 1 and $[(12,000,000 / \text{Burst_Count}) - (\text{Total Burst Length}) + (\text{One Random PRI Interval})]$ microseconds, with the start time being randomly chosen. The step interval for the start time is 1 microsecond. The start time for each Burst is chosen independently.

A representative example of a Long Pulse radar test waveform:

- 1) The total test signal length is 12 seconds.
- 2) 8 Bursts are randomly generated for the Burst_Count.
- 3) Burst 1 has 2 randomly generated pulses.
- 4) The pulse width (for both pulses) is randomly selected to be 75 microseconds.
- 5) The PRI is randomly selected to be at 1213 microseconds.
- 6) Bursts 2 through 8 are generated using steps 3 – 5.
- 7) Each Burst is contained in even intervals of 1,500,000 microseconds. The starting location for Pulse 1, Burst 1 is randomly generated (1 to 1,500,000 minus the total Burst 1 length + 1 random PRI interval) at the 325,001 microsecond step. Bursts 2 through 8 randomly fall in successive 1,500,000 microsecond intervals (i.e. Burst 2 falls in the 1,500,001 – 3,000,000 microsecond range).

Graphical Representation of a Long Pulse radar Test Waveform

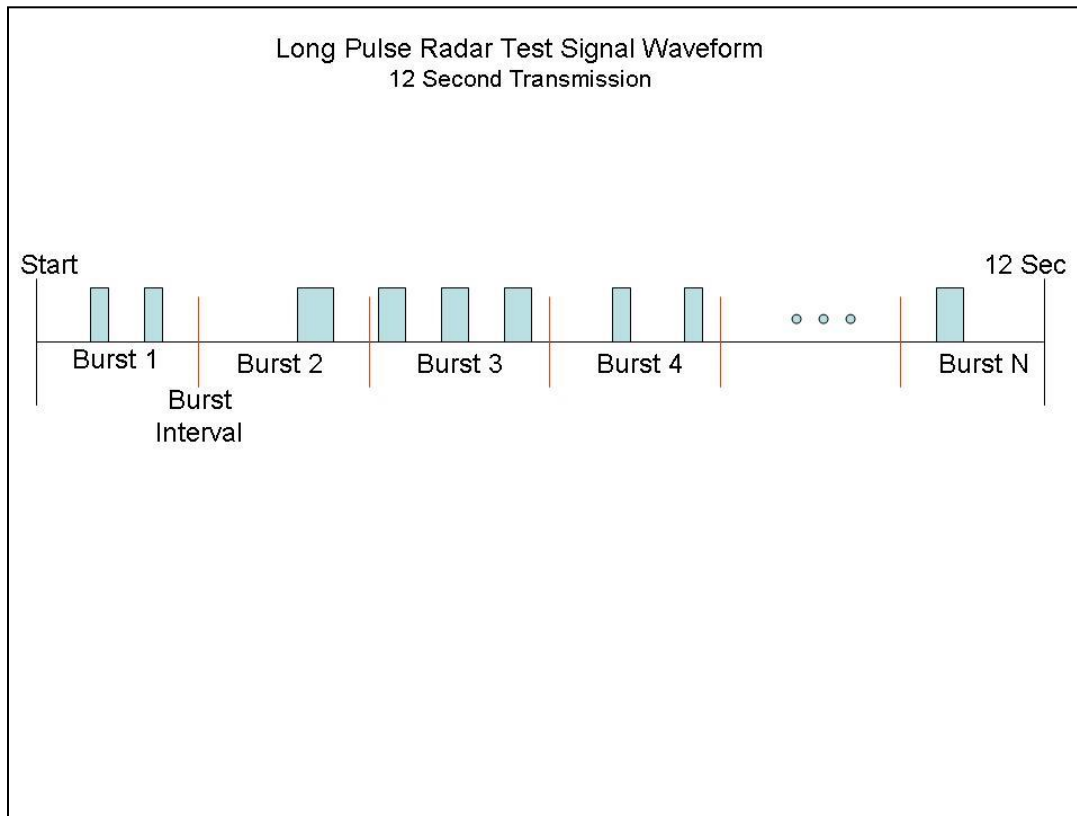

3.

Frequency Hopping Radar Test Waveform

Radars Type	Pulse Width (µsec)	PRI (µsec)	Pulses per Hop	Hopping Rate (kHz)	Hopping Sequence Length (msec)	Minimum Percentage of Successful Detection	Minimum Trials
6	1	333	9	.333	300	70%	30

For the Frequency Hopping Radar Type, the same *Burst* parameters are used for each waveform. The hopping sequence is different for each waveform and a 100-length segment is selected¹ from the hopping sequence defined by the following algorithm:

The first frequency in a hopping sequence is selected randomly from the group of 475 integer frequencies from 5250 – 5724 MHz. Next, the frequency that was just chosen is removed from the group and a frequency is randomly selected from the remaining 474 frequencies in the group. This process continues until all 475 frequencies are chosen for the set. For selection of a random frequency, the frequencies remaining within the group are always treated as equally likely.

4.0 Radar Waveform Calibration

1. The following equipment setup was used to calibrate the conducted Radar Waveform. A spectrum analyzer was used to establish the test signal level for each radar type. During this process there were no transmissions by either the Master or Client Device. The spectrum analyzer was switched to the zero span (Time Domain) mode at the frequency of the Radar Waveform generator. Peak detection was utilized. The spectrum analyzer resolution bandwidth (RBW) and video bandwidth (VBW) were set to 3 MHz.

The signal generator amplitude was set so that the power level measured at the spectrum analyzer was -63dBm.

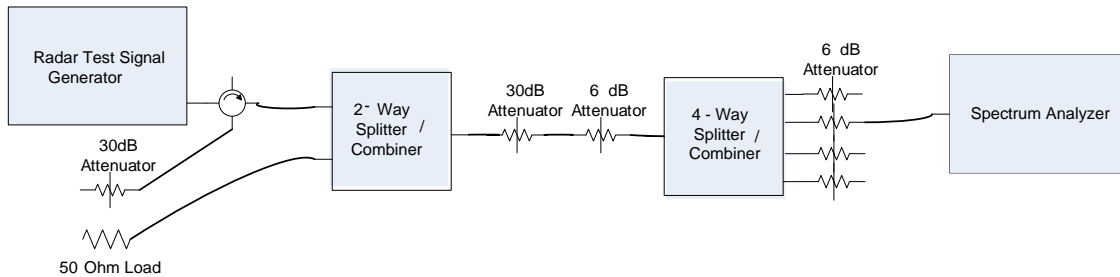

Conducted Calibration Setup



2. Following are the calibration plots for each of the required radar waveforms.

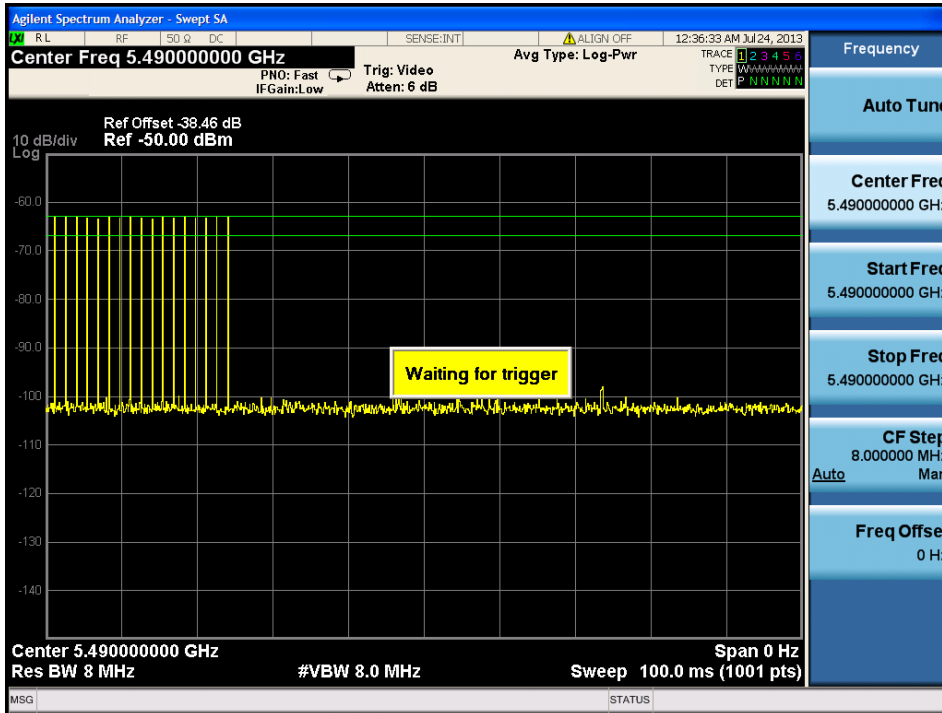

USA Bin 1 Radar Calibration

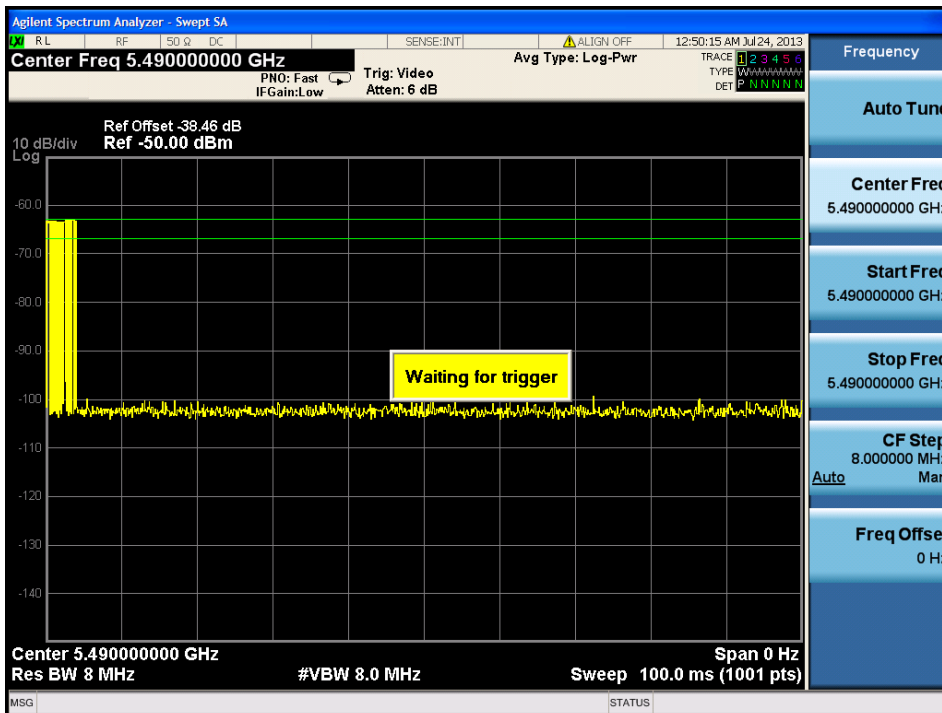

USA Bin 2 Radar Calibration

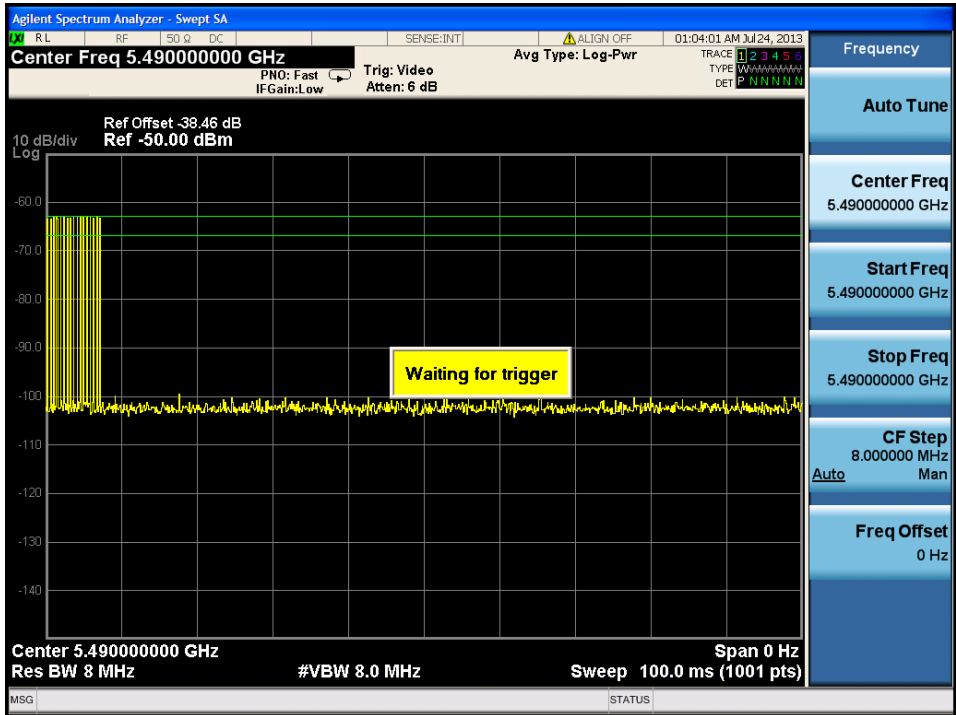

USA Bin 3 Radar Calibration

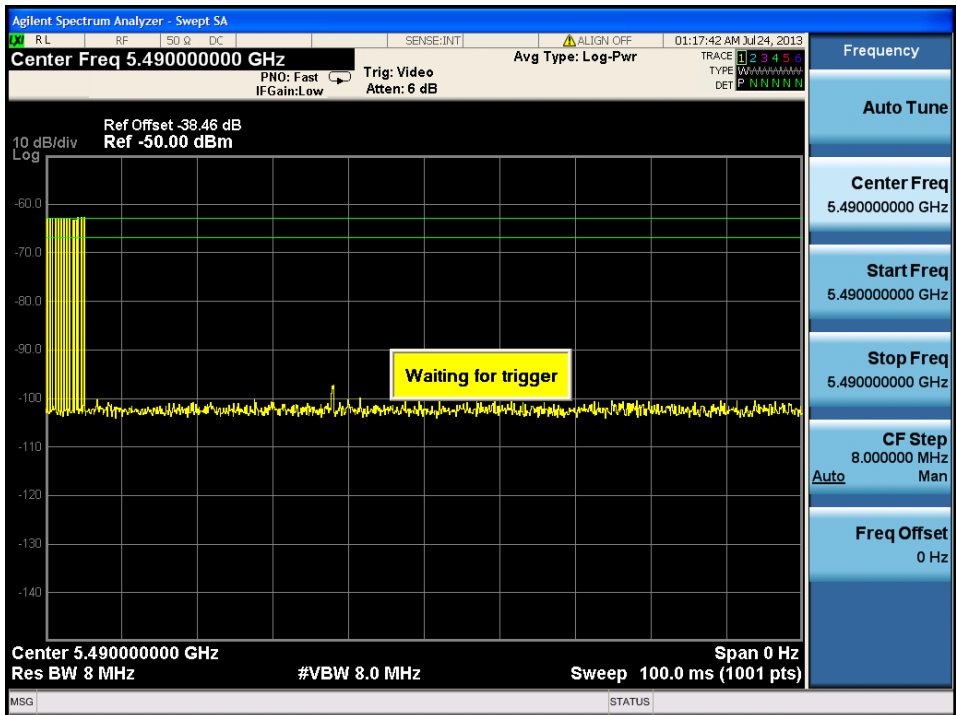

USA Bin 4 Radar Calibration

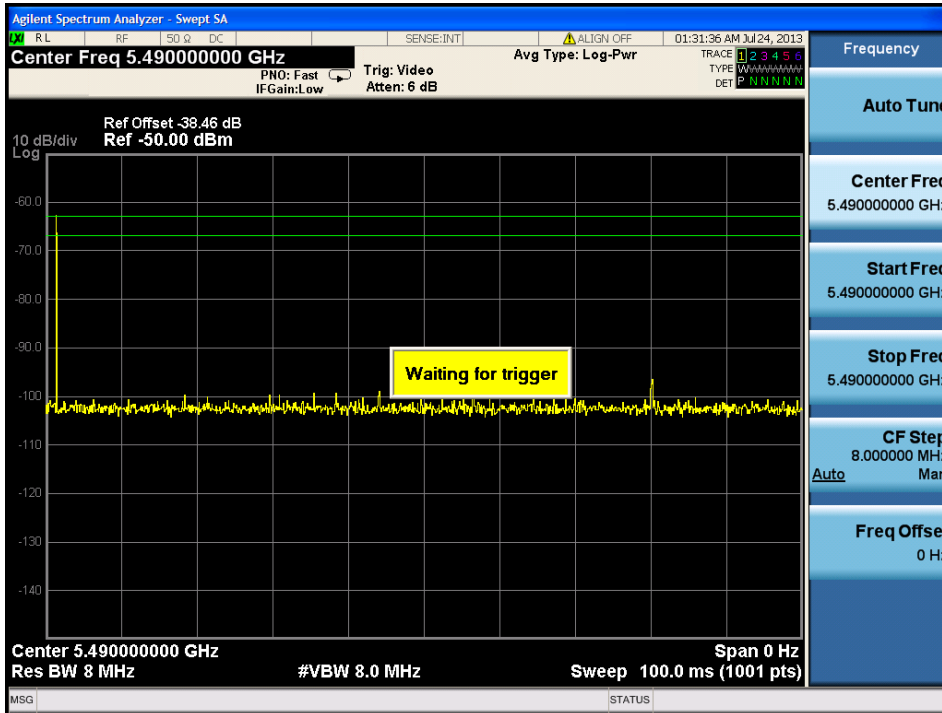

USA Bin 5 Radar Calibration

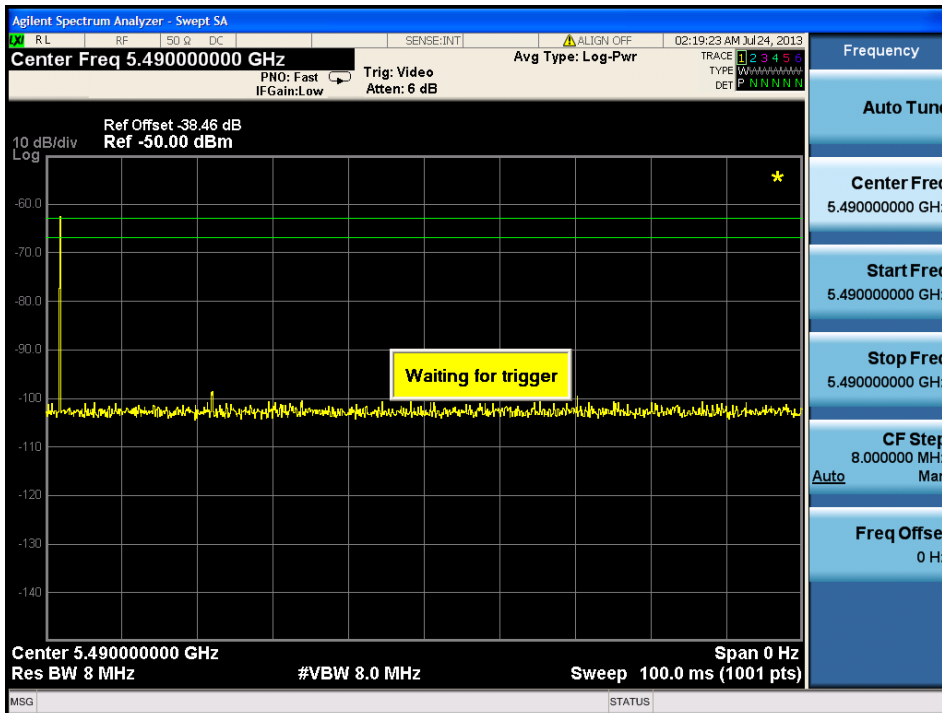

USA Frequency Hopping Radar Calibration

5.0 Test Procedure/Results

1. A spectrum analyzer is used as a monitor to verify that the UUT has vacated the Channel within the (Channel Closing Transmission Time and Channel Move Time, and does not transmit on a Channel

during the Non-Occupancy Period after the detection and Channel move. It is also used to monitor UUT transmissions during the Channel Availability Check Time.

- Following is the test setup used to generate the Radar Waveforms, and for all DFS tests described herein.

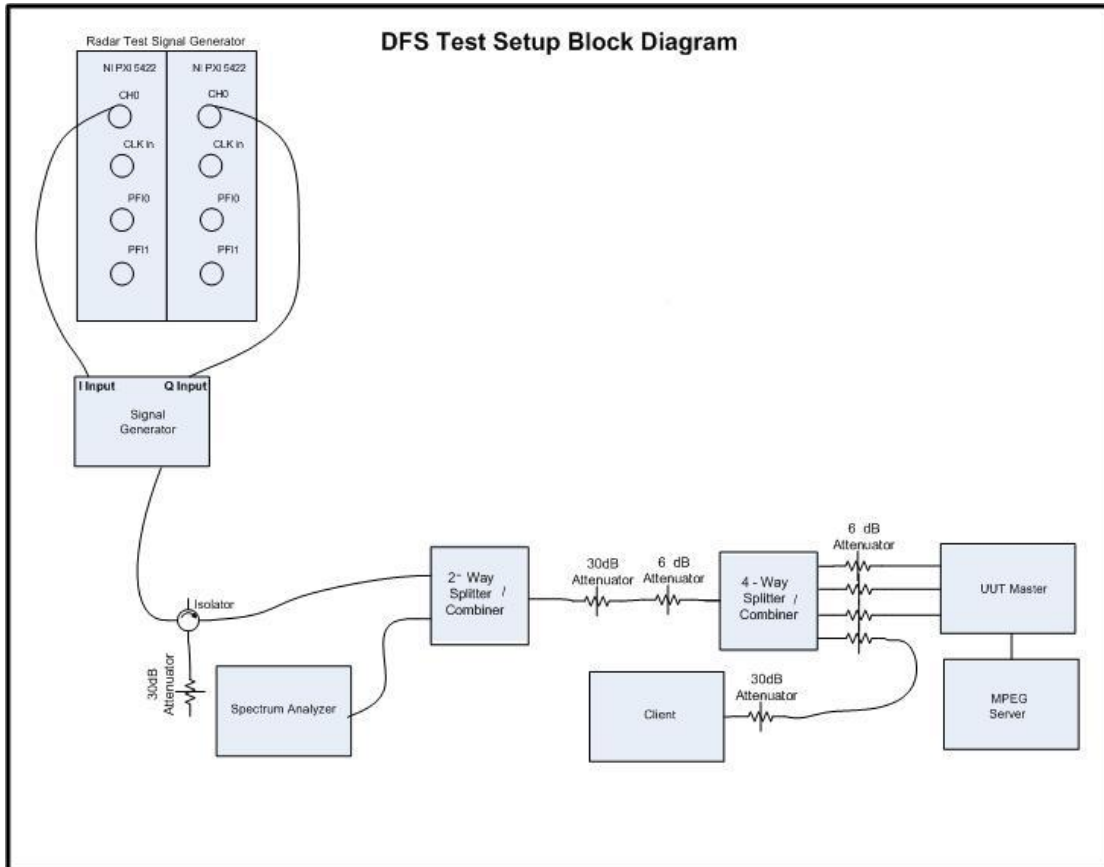

Conducted Setup: Radar Test Waveforms are injected into the Master



DFS Setup

The test setup is constructed of the following equipment:

Radar Test Signal Generator

National Instruments NI PXI-1042 8-Slot 3U Chassis

National Instruments NI PXI-5422 16-Bit 200MS/s Arbitrary Waveform Generator (Qty. 2)

Agilent N5182A MXG Signal Generator

Agilent E4448A Spectrum Analyzer

Mini-Circuits ZFSC-2-9G Splitter/Combiner (Qty. 1)

Weinschel 1594 4 to 1 power Splitter/Combiner (Qty. 1)

Ditom Microwave D3C-4080-11 Circulator/Isolator (Qty. 1)

Mini-Circuits BW-S30W2 30dB Attenuator (Qty. 4)

Mini-Circuits BW-S6W2 30dB Attenuator (Qty. 5)

Megaphase SF26 S1S1 36" Coaxial Cable (Qty. 2)

MicroCoax 18" Coaxial Cable (Qty. 3)

Dell 600M Laptop (Qty. 2: 1 for wireless client, 1 for MPEG server)

Cisco-Linksys WPC600N 802.11n NIC card (wireless client)

The waveform parameters from within the bounds of the signal type are selected randomly using uniform distribution.

3. **UNII Detection Bandwidth**

All UNII 20 MHz channels for this device have identical Channel bandwidths, all 40 MHz channels have identical Channel bandwidths, and all 80 MHz channels have identical Channel bandwidths. Therefore, all DFS testing was done at 5500 MHz. The 99% channel bandwidth for 20MHz signals is 18 MHz, the the 99% channel bandwidth for 40MHz signals is 36 MHz, and the 99% channel bandwidth for 80MHz signals is 72. (See the 26dB BW section of the RF report for further measurement details).

The generating equipment is configured as shown in the Conducted Test Setup above. A single *Burst* of the desired radar profile is produced at 5500MHz at a -63dBm level. The UUT is set up as a standalone device (no associated Client and no traffic).

A single radar Burst is generated for a minimum of 10 trials, and the response of the UUT is noted. The UUT must detect the Radar Waveform 90% or more of the time.

The radar frequency is increased in 1 MHz steps, repeating the above test sequence, until the detection rate falls below 90%. The highest frequency at which detection is greater than or equal to 90% is denoted as F_H .

The radar frequency is decreased in 1 MHz steps, repeating the above test sequence, until the detection rate falls below 90%. The lowest frequency at which detection is greater than or equal to 90% is denoted as F_L .

The U-NII Detection Bandwidth is calculated as follows:

$$\text{U-NII Detection Bandwidth} = F_H - F_L$$

The U-NII Detection Bandwidth must be at least 80% of the UUT transmitter 99% power bandwidth (14.4 MHz for 20MHz signals, 28.8 MHz for 40 MHz signals, and 57.6 MHz for 80 MHz signals), otherwise, the UUT does not comply with DFS requirements.



UNII Detection Bandwidth Results, 20MHz Signal Bandwidth

Radar Frequency	DFS Detection Trials (1=Detection, Blank= No Detection)										Detection Rate (%)	Detection Bandwidth (MHz)
	1	2	3	4	5	6	7	8	9	10		
5490	1	1	1	1	1	1	1	1	1	1	100	20
5491	1	1	1	1	1	1	1	1	1	1	100	
5492	1	1	1	1	1	1	1	1	1	1	100	
5493	1	1	1	1	1	1	1	1	1	1	100	
5494	1	1	1	1	1	1	1	1	1	1	100	
5495	1	1	1	1	1	1	1	1	1	1	100	
5496	1	1	1	1	1	1	1	1	1	1	100	
5497	1	1	1	1	1	1	1	1	1	1	100	
5498	1	1	1	1	1	1	1	1	1	1	100	
5499	1	1	1	1	1	1	1	1	1	1	100	
5500	1	1	1	1	1	1	1	1	1	1	100	
5501	1	1	1	1	1	1	1	1	1	1	100	
5502	1	1	1	1	1	1	1	1	1	1	100	
5503	1	1	1	1	1	1	1	1	1	1	100	
5504	1	1	1	1	1	1	1	1	1	1	100	
5505	1	1	1	1	1	1	1	1	1	1	100	
5506	1	1	1	1	1	1	1	1	1	1	100	
5507	1	1	1	1	1	1	1	1	1	1	100	
5508	1	1	1	1	1	1	1	1	1	1	100	
5509	1	1	1	1	1	1	1	1	1	1	100	
5510	1	1	1	1	1	1	1	1	1	1	100	

USA Bin 1 Radar



Radar Frequency	DFS Detection Trials (1=Detection, Blank= No Detection)										Detection Rate (%)	Detection Bandwidth (MHz)
	1	2	3	4	5	6	7	8	9	10		
5490	1	1	1	1	1	1	1	1	1	1	100	20
5491	1	1	1	1	1	1	1	1	1	1	100	
5492	1	1	1	1	1	1	1	1	1	1	100	
5493	1	1	1	1	1	1	1	1	1	1	100	
5494	1	1	1	1	1	1	1	1	1	1	100	
5495	1	1	1	1	1	1	1	1	1	1	100	
5496	1	1	1	1	1	1	1	1	1	1	100	
5497	1	1	1	1	1	1	1	1	1	1	100	
5498	1	1	1	1	1	1	1	1	1	1	100	
5499	1	1	1	1	1	1	1	1	1	1	100	
5500	1	1	1	1	1	1	1	1	1	1	100	
5501	1	1	1	1	1	1	1	1	1	1	100	
5502	1	1	1	1	1	1	1	1	1	1	100	
5503	1	1	1	1	1	1	1	1	1	1	100	
5504	1	1	1	1	1	1	1	1	1	1	100	
5505	1	1	1	1	1	1	1	1	1	1	100	
5506	1	1	1	1	1	1	1	1	1	1	100	
5507	1	1	1	1	1	1	1	1	1	1	100	
5508	1	1	1	1	1	1	1	1	1	1	100	
5509	1	1	1	1	1	1	1	1	1	1	100	
5510	1	1	1	1	1	1	1	1	1	1	100	

USA Bin 2 Radar



Radar Frequency	DFS Detection Trials (1=Detection, Blank= No Detection)										Detection Rate (%)	Detection Bandwidth (MHz)
	1	2	3	4	5	6	7	8	9	10		
5490	1	1	1	1	1	1	1	1	1	1	100	20
5491	1	1	1	1	1	1	1	1	1	1	100	
5492	1	1	1	1	1	1	1	1	1	1	100	
5493	1	1	1	1	1	1	1	1	1	1	100	
5494	1	1	1	1	1	1	1	1	1	1	100	
5495	1	1	1	1	1	1	1	1	1	1	100	
5496	1	1	1	1	1	1	1	1	1	1	100	
5497	1	1	1	1	1	1	1	1	1	1	100	
5498	1	1	1	1	1	1	1	1	1	1	100	
5499	1	1	1	1	1	1	1	1	1	1	100	
5500	1	1	1	1	1	1	1	1	1	1	100	
5501	1	1	1	1	1	1	1	1	1	1	100	
5502	1	1	1	1	1	1	1	1	1	1	100	
5503	1	1	1	1	1	1	1	1	1	1	100	
5504	1	1	1	1	1	1	1	1	1	1	100	
5505	1	1	1	1	1	1	1	1	1	1	100	
5506	1	1	1	1	1	1	1	1	1	1	100	
5507	1	1	1	1	1	1	1	1	1	1	100	
5508	1	1	1	1	1	1	1	1	1	1	100	
5509	1	1	1	1	1	1	1	1	1	1	100	
5510	1	1	1	1	1	1	1	1	1	1	100	

USA Bin 3 Radar



Radar Frequency	DFS Detection Trials (1=Detection, Blank= No Detection)										Detection Rate (%)	Detection Bandwidth (MHz)
	1	2	3	4	5	6	7	8	9	10		
5490	1	1	1	1	1	1	0	1	1	1	90	20
5491	1	1	1	1	1	1	1	1	1	1	100	
5492	1	1	1	1	1	1	1	1	1	1	100	
5493	1	1	1	1	1	1	1	1	1	1	100	
5494	1	1	1	1	1	1	1	1	1	1	100	
5495	1	1	1	1	1	1	1	1	1	1	100	
5496	1	1	1	1	1	1	1	1	1	1	100	
5497	1	1	1	1	1	1	1	1	1	1	100	
5498	1	1	1	1	1	1	1	1	1	1	100	
5499	1	1	1	1	1	1	1	1	1	1	100	
5500	1	1	1	1	1	1	1	1	1	1	100	
5501	1	1	1	1	1	1	1	1	1	1	100	
5502	1	1	1	1	1	1	1	1	1	1	100	
5503	1	1	1	1	1	1	1	1	1	1	100	
5504	1	1	1	1	1	1	1	1	1	1	100	
5505	1	1	1	1	1	1	1	1	1	1	100	
5506	1	1	1	1	1	1	1	1	1	1	100	
5507	1	1	1	1	1	1	1	1	1	1	100	
5508	1	1	1	1	1	1	1	1	1	1	100	
5509	1	1	1	1	1	1	1	1	1	1	100	
5510	1	1	1	1	1	1	1	1	1	1	100	

USA Bin 4 Radar



Radar Frequency	DFS Detection Trials (1=Detection, Blank= No Detection)										Detection Rate (%)	Detection Bandwidth (MHz)
	1	2	3	4	5	6	7	8	9	10		
5490	0	0	1	1	1	1	1	1	1	0	70	18
5491	1	1	1	1	1	1	1	1	1	1	100	
5492	1	1	1	1	1	1	1	1	1	1	100	
5493	1	1	1	1	1	1	1	1	1	1	100	
5494	1	1	1	1	1	1	1	1	1	1	100	
5495	1	1	1	1	1	1	1	1	1	1	100	
5496	1	1	1	1	1	1	1	1	1	1	100	
5497	1	1	1	1	1	1	1	1	1	1	100	
5498	1	1	1	1	1	1	1	1	1	1	100	
5499	1	1	1	1	1	1	1	1	1	1	100	
5500	1	1	1	1	1	1	1	1	1	1	100	
5501	1	1	1	1	1	1	1	1	1	1	100	
5502	1	1	1	1	1	1	1	1	1	1	100	
5503	1	1	1	1	1	1	1	1	1	1	100	
5504	1	1	1	1	1	1	1	1	1	1	100	
5505	1	1	1	1	1	1	1	1	1	1	100	
5506	1	1	1	1	1	1	1	1	1	1	100	
5507	1	1	1	1	1	1	1	1	1	1	100	
5508	1	1	1	1	1	1	1	1	1	1	100	
5509	1	1	1	1	1	1	1	1	1	1	100	
5510	1	1	1	1	1	1	1	1	1	1	100	

USA Bin 5 Radar



Radar Frequency	DFS Detection Trials (1=Detection, Blank= No Detection)										Detection Rate (%)	Detection Bandwidth (MHz)
	1	2	3	4	5	6	7	8	9	10		
5490	1	1	1	1	1	0	0	1	0	1	70	18
5491	1	1	1	1	1	1	1	1	1	1	100	
5492	1	1	1	1	1	1	1	0	1	1	90	
5493	1	1	1	1	1	1	1	1	1	1	100	
5494	1	1	1	1	1	1	1	1	1	1	100	
5495	0	1	1	1	1	1	1	1	1	1	90	
5496	1	1	1	0	1	1	1	1	1	1	90	
5497	1	1	1	1	1	1	1	1	1	1	100	
5498	1	1	1	1	1	1	1	1	1	1	100	
5499	1	1	1	1	1	1	1	1	1	1	100	
5500	1	1	1	1	1	1	1	1	1	1	100	
5501	1	1	1	1	1	1	1	1	1	1	100	
5502	1	1	1	1	1	1	1	1	1	1	100	
5503	1	1	1	1	1	1	1	1	1	1	100	
5504	1	1	1	1	1	1	0	1	1	1	90	
5505	1	1	1	1	1	1	1	1	1	1	100	
5506	1	1	1	1	1	1	1	1	1	1	100	
5507	1	1	0	1	1	1	1	1	1	1	90	
5508	1	1	1	1	1	1	1	1	1	1	100	
5509	1	1	1	0	1	1	1	1	1	1	90	
5510	1	1	1	1	1	1	1	1	1	1	100	

USA Frequency Hopping Radar



Radar Frequency	DFS Detection Trials (1=Detection, Blank= No Detection)										Detection Rate (%)	Detection Bandwidth (MHz)
	1	2	3	4	5	6	7	8	9	10		
5490	1	1	1	1	1	1	1	1	1	1	100	40
5491	1	1	1	1	1	1	1	1	1	1	100	
5492	1	1	1	1	1	1	1	1	1	1	100	
5493	1	1	1	1	1	1	1	1	1	1	100	
5494	1	1	1	1	1	1	1	1	1	1	100	
5495	1	1	1	1	1	1	1	1	1	1	100	
5496	1	1	1	1	1	1	1	1	1	1	100	
5497	1	1	1	1	1	1	1	1	1	1	100	
5498	1	1	1	1	1	1	1	1	1	1	100	
5499	1	1	1	1	1	1	1	1	1	1	100	
5500	1	1	1	1	1	1	1	1	1	1	100	
5501	1	1	1	1	1	1	1	1	1	1	100	
5502	1	1	1	1	1	1	1	1	1	1	100	
5503	1	1	1	1	1	1	1	1	1	1	100	
5504	1	1	1	1	1	1	1	1	1	1	100	
5505	1	1	1	1	1	1	1	1	1	1	100	
5506	1	1	1	1	1	1	1	1	1	1	100	
5507	1	1	1	1	1	1	1	1	1	1	100	
5508	1	1	1	1	1	1	1	1	1	1	100	
5509	1	1	1	1	1	1	1	1	1	1	100	
5510	1	1	1	1	1	1	1	1	1	1	100	
5511	1	1	1	1	1	1	1	1	1	1	100	
5512	1	1	1	1	1	1	1	1	1	1	100	
5513	1	1	1	1	1	1	1	1	1	1	100	
5514	1	1	1	1	1	1	1	1	1	1	100	
5515	1	1	1	1	1	1	1	1	1	1	100	
5516	1	1	1	1	1	1	1	1	1	1	100	
5517	1	1	1	1	1	1	1	1	1	1	100	
5518	1	1	1	1	1	1	1	1	1	1	100	
5519	1	1	1	1	1	1	1	1	1	1	100	
5520	1	1	1	1	1	1	1	1	1	1	100	
5521	1	1	1	1	1	1	1	1	1	1	100	
5522	1	1	1	1	1	1	1	1	1	1	100	
5523	1	1	1	1	1	1	1	1	1	1	100	
5524	1	1	1	1	1	1	1	1	1	1	100	
5525	1	1	1	1	1	1	1	1	1	1	100	
5526	1	1	1	1	1	1	1	1	1	1	100	
5527	1	1	1	1	1	1	1	1	1	1	100	
5528	1	1	1	1	1	1	1	1	1	1	100	
5529	1	1	1	1	1	1	1	1	1	1	100	
5530	1	1	1	1	1	1	1	1	1	1	100	

USA Bin 1 Radar



Radar Frequency	DFS Detection Trials (1=Detection, Blank= No Detection)										Detection Rate (%)	Detection Bandwidth (MHz)
	1	2	3	4	5	6	7	8	9	10		
5490	1	1	1	0	1	0	1	0	1	1	70	38
5491	1	1	1	1	1	1	1	1	1	1	100	
5492	1	1	1	1	1	1	1	1	1	1	100	
5493	1	1	1	1	1	1	1	1	1	1	100	
5494	1	1	1	1	1	1	1	1	1	1	100	
5495	1	1	1	1	1	1	1	1	1	1	100	
5496	1	1	1	1	1	1	1	1	1	1	100	
5497	1	1	1	1	1	1	1	1	1	1	100	
5498	1	1	1	1	1	1	1	1	1	1	100	
5499	0	1	1	1	1	1	1	1	1	1	90	
5500	1	1	1	1	1	1	1	1	1	1	100	
5501	1	1	1	1	1	1	1	1	1	1	100	
5502	1	1	1	1	1	1	1	1	1	1	100	
5503	1	1	1	1	1	1	1	1	1	1	100	
5504	1	1	1	1	1	1	1	1	1	1	100	
5505	1	1	1	1	1	1	1	1	1	1	100	
5506	1	1	1	1	1	1	1	1	1	1	100	
5507	1	1	1	1	1	1	1	1	0	1	90	
5508	1	1	1	1	1	1	1	1	1	1	100	
5509	1	1	1	1	1	1	1	1	1	1	100	
5510	1	1	1	1	1	1	1	1	1	1	100	
5511	1	1	1	1	1	1	1	1	1	1	100	
5512	1	1	1	1	1	1	1	1	1	1	100	
5513	1	1	1	1	1	1	1	1	1	1	100	
5514	1	1	1	1	1	1	1	1	1	1	100	
5515	1	1	1	1	1	1	1	1	1	1	100	
5516	1	1	1	1	1	1	1	1	1	1	100	
5517	1	1	1	1	1	1	1	1	1	1	100	
5518	1	1	1	1	1	1	1	1	1	1	100	
5519	1	1	1	1	1	1	1	1	1	1	100	
5520	1	1	1	1	1	1	1	1	1	1	100	
5521	1	1	1	1	1	1	1	1	1	1	100	
5522	1	1	1	1	1	1	1	1	1	1	100	
5523	1	1	1	1	1	1	1	1	1	1	100	
5524	1	1	1	1	1	1	1	1	1	1	100	
5525	1	1	1	1	1	1	1	1	1	1	100	
5526	1	1	1	1	1	1	1	1	1	1	100	
5527	1	1	1	1	1	1	1	1	1	1	100	
5528	1	1	1	1	1	1	1	1	1	1	100	
5529	1	1	1	1	1	1	1	1	1	1	100	
5530	1	0	0	1	1	0	0	0	1	0	40	

USA Bin 2 Radar



Radar Frequency	DFS Detection Trials (1=Detection, Blank= No Detection)										Detection Rate (%)	Detection Bandwidth (MHz)
	1	2	3	4	5	6	7	8	9	10		
5490	0	1	1	1	1	1	1	1	1	1	90	38
5491	1	1	1	1	1	1	1	1	1	1	100	
5492	1	1	1	1	1	1	1	1	1	1	100	
5493	1	1	1	1	1	1	1	1	1	1	100	
5494	1	1	1	1	1	1	1	1	1	1	100	
5495	1	1	1	1	1	1	1	1	1	1	100	
5496	1	1	1	1	1	1	1	1	1	1	100	
5497	1	1	1	1	1	1	1	1	1	1	100	
5498	1	1	1	1	1	1	1	1	1	1	100	
5499	1	1	1	1	1	1	1	1	1	1	100	
5500	1	1	1	1	1	1	1	1	1	1	100	
5501	1	1	1	1	1	1	1	1	1	1	100	
5502	1	1	1	1	1	1	1	1	1	1	100	
5503	1	1	1	1	1	1	1	1	1	1	100	
5504	1	1	1	1	1	1	1	1	1	1	100	
5505	1	1	1	1	1	1	1	1	1	1	100	
5506	1	1	1	1	1	1	1	1	1	1	100	
5507	1	1	1	1	1	1	1	1	1	1	100	
5508	1	1	1	1	1	1	1	1	1	1	100	
5509	1	1	1	1	1	1	1	1	1	1	100	
5510	1	1	1	1	1	1	1	1	1	1	100	
5511	1	1	1	1	1	1	1	1	1	1	100	
5512	1	1	1	1	1	1	1	1	1	1	100	
5513	1	1	1	1	1	1	1	1	1	1	100	
5514	1	1	1	1	1	1	1	1	1	1	100	
5515	1	1	1	1	1	1	1	1	1	1	100	
5516	1	1	1	1	1	1	1	1	1	1	100	
5517	1	1	1	1	1	1	1	1	1	1	100	
5518	1	1	1	1	1	1	1	1	1	1	100	
5519	1	1	1	1	1	1	1	1	1	1	100	
5520	1	1	1	1	1	1	1	1	1	1	100	
5521	1	1	1	1	1	1	1	1	1	1	100	
5522	1	1	1	1	1	1	1	1	1	1	100	
5523	1	1	1	1	1	1	1	1	1	1	100	
5524	1	1	1	1	1	1	1	1	1	1	100	
5525	1	1	1	1	1	1	1	1	1	1	100	
5526	1	1	1	1	1	1	1	1	1	1	100	
5527	1	1	1	1	1	1	1	1	1	1	100	
5528	1	1	1	1	1	1	1	1	1	1	100	
5529	1	1	1	1	1	1	1	1	1	1	100	
5530	0	0	0	0	0	0	0	0	0	0	0	

USA Bin 3 Radar



Radar Frequency	DFS Detection Trials (1=Detection, Blank= No Detection)										Detection Rate (%)	Detection Bandwidth (MHz)
	1	2	3	4	5	6	7	8	9	10		
5490	0	1	1	1	1	1	1	1	1	1	90	38
5491	1	1	1	1	1	1	1	1	1	1	100	
5492	1	1	1	1	1	1	1	1	1	1	100	
5493	1	1	1	1	1	1	1	1	1	1	100	
5494	1	1	1	1	1	1	1	1	1	1	100	
5495	1	1	1	1	1	1	1	1	1	1	100	
5496	1	1	1	1	1	1	1	1	1	1	100	
5497	1	1	1	1	1	1	1	1	1	1	100	
5498	1	1	1	1	1	1	1	1	1	1	100	
5499	1	1	1	1	1	1	1	1	1	1	100	
5500	1	1	1	1	1	1	1	1	1	1	100	
5501	1	1	1	1	1	1	1	1	1	1	100	
5502	1	1	1	1	1	1	1	1	1	1	100	
5503	1	1	1	1	1	1	1	1	1	1	100	
5504	1	1	1	1	1	1	1	1	1	1	100	
5505	1	1	1	1	1	1	1	1	1	1	100	
5506	1	1	1	1	1	1	1	1	1	1	100	
5507	1	1	1	1	1	1	1	1	1	1	100	
5508	1	1	1	1	1	1	1	1	1	1	100	
5509	1	1	1	1	1	1	1	1	1	1	100	
5510	1	1	1	1	1	1	1	1	1	1	100	
5511	1	1	1	1	1	1	1	1	1	1	100	
5512	1	1	1	1	1	1	1	1	1	1	100	
5513	1	1	1	1	1	1	1	1	1	1	100	
5514	1	1	1	1	1	1	1	1	1	1	100	
5515	1	1	1	1	1	1	1	1	1	1	100	
5516	1	1	1	1	1	1	1	1	1	1	100	
5517	1	1	1	1	1	1	1	1	1	1	100	
5518	1	1	1	1	1	1	1	1	1	1	100	
5519	1	1	1	1	1	1	1	1	1	1	100	
5520	1	1	1	1	1	1	1	1	1	1	100	
5521	1	1	1	1	1	1	1	1	1	1	100	
5522	1	1	1	1	1	1	1	1	1	1	100	
5523	1	1	1	1	1	1	0	1	1	1	90	
5524	1	1	1	1	1	1	1	1	1	1	100	
5525	1	1	1	1	1	1	1	1	1	1	100	
5526	1	1	1	1	1	1	1	1	1	1	100	
5527	1	1	1	1	1	1	1	1	1	1	100	
5528	1	1	1	1	1	1	1	1	1	1	100	
5529	1	1	1	1	1	1	1	1	1	1	100	
5530	0	0	0	0	0	0	0	0	0	0	0	

USA Bin 4 Radar



Radar Frequency	DFS Detection Trials (1=Detection, Blank= No Detection)										Detection Rate (%)	Detection Bandwidth (MHz)
	1	2	3	4	5	6	7	8	9	10		
5490	0	1	1	1	1	1	0	0	0	0	50	36
5491	0	0	0	1	1	1	1	1	1	1	70	
5492	1	1	1	1	1	1	1	1	1	1	100	
5493	1	1	1	1	1	1	1	1	1	1	100	
5494	1	1	1	1	1	1	1	1	1	1	100	
5495	1	1	1	1	1	1	1	1	1	1	100	
5496	1	1	1	1	1	1	1	1	1	1	100	
5497	1	1	1	1	1	1	1	1	1	1	100	
5498	1	1	1	1	1	1	1	1	1	1	100	
5499	1	1	1	1	1	1	1	1	1	1	100	
5500	1	1	1	1	1	1	1	1	1	1	100	
5501	1	1	1	1	1	1	1	1	1	1	100	
5502	1	1	1	1	1	1	1	1	1	1	100	
5503	1	1	1	1	1	1	1	1	1	1	100	
5504	1	1	1	1	1	1	1	1	1	1	100	
5505	1	1	1	1	1	1	1	1	1	1	100	
5506	1	1	1	1	1	1	1	1	1	1	100	
5507	1	1	1	1	1	1	1	1	1	1	100	
5508	1	1	1	1	1	1	1	1	1	1	100	
5509	1	1	1	1	1	1	1	1	1	1	100	
5510	1	1	1	1	1	1	1	1	1	1	100	
5511	1	1	1	1	1	1	1	1	1	1	100	
5512	1	1	1	1	1	1	1	1	1	1	100	
5513	1	1	1	1	1	1	1	1	1	1	100	
5514	1	1	1	1	1	1	1	1	1	1	100	
5515	1	1	1	1	1	1	1	1	1	1	100	
5516	1	1	1	1	1	1	1	1	1	1	100	
5517	1	1	1	1	1	1	1	1	1	1	100	
5518	1	1	1	1	1	1	1	1	1	1	100	
5519	1	1	1	1	1	1	1	1	1	1	100	
5520	1	1	1	1	1	1	1	1	1	1	100	
5521	1	1	1	1	1	1	1	1	1	1	100	
5522	1	1	1	1	1	1	1	1	1	1	100	
5523	1	1	1	1	1	1	1	1	1	1	100	
5524	1	1	1	1	1	1	1	1	1	1	100	
5525	1	1	1	1	1	1	1	1	1	1	100	
5526	1	1	1	1	1	1	1	1	1	1	100	
5527	1	1	1	1	1	1	1	1	1	1	100	
5528	1	1	1	1	1	1	1	1	1	1	100	
5529	1	1	1	1	1	1	1	1	1	1	100	
5530	1	1	1	1	1	1	1	1	1	1	100	

USA Bin 5 Radar



Radar Frequency	DFS Detection Trials (1=Detection, Blank= No Detection)										Detection Rate (%)	Detection Bandwidth (MHz)
	1	2	3	4	5	6	7	8	9	10		
5490	1	1	1	0	1	1	1	1	1	1	90	40
5491	1	1	1	1	1	0	1	1	1	1	90	
5492	1	1	1	1	1	1	1	1	1	1	100	
5493	1	1	1	1	1	1	1	1	1	1	100	
5494	1	1	1	1	1	1	1	1	1	1	100	
5495	1	1	0	1	1	1	1	1	1	1	90	
5496	1	1	1	1	1	1	1	1	1	1	100	
5497	1	1	1	1	1	1	1	1	1	1	100	
5498	1	1	1	1	1	1	1	1	1	1	100	
5499	1	1	1	1	1	1	1	1	1	1	100	
5500	1	1	1	1	1	1	1	0	1	1	90	
5501	1	1	1	1	1	1	1	1	1	1	100	
5502	1	1	1	1	1	1	1	1	1	1	100	
5503	1	1	1	1	1	1	1	1	1	1	100	
5504	1	1	1	1	1	1	1	1	1	1	100	
5505	1	1	1	1	1	1	1	1	1	1	100	
5506	1	1	1	1	1	1	1	1	1	1	100	
5507	1	1	1	1	1	1	1	1	1	1	100	
5508	1	1	1	1	1	1	1	1	1	1	100	
5509	1	1	1	1	1	1	1	1	1	1	100	
5510	1	1	1	1	1	1	1	1	1	1	100	
5511	1	1	1	1	1	1	1	1	1	1	100	
5512	1	1	0	1	1	1	1	1	1	1	90	
5513	1	1	1	1	1	1	1	1	1	1	100	
5514	1	1	1	1	1	1	1	1	1	1	100	
5515	1	1	1	1	1	1	1	1	1	1	100	
5516	1	1	1	1	1	1	1	1	1	1	100	
5517	1	1	1	1	1	1	1	1	1	1	100	
5518	1	1	1	1	1	1	1	1	1	1	100	
5519	1	1	1	1	1	1	1	1	1	1	100	
5520	1	1	1	1	1	1	1	1	1	1	100	
5521	1	1	1	1	1	1	1	1	1	1	100	
5522	1	1	1	1	1	1	1	0	1	1	90	
5523	1	1	1	1	1	1	1	1	1	1	100	
5524	1	1	1	1	1	1	1	1	1	1	100	
5525	1	1	1	1	1	1	1	1	1	1	100	
5526	1	1	1	1	1	1	1	1	1	1	100	
5527	1	1	1	1	1	1	1	1	1	1	100	
5528	1	1	1	1	0	1	1	1	1	1	90	
5529	1	1	1	1	1	1	1	1	1	1	100	
5530	1	1	1	1	1	1	1	1	1	1	100	

USA Frequency Hopping Radar



4. Initial Channel Availability Check Time

The tests that the UUT does not emit beacon, control, or data signals on the test Channel until the power-up sequence has been completed and the U-NII device checks for Radar Waveforms for one minute on the test Channel. This test does not use any Radar Waveforms.

The U-NII device is powered on and instructed to operate at 5500 MHz. At the same time the UUT is powered on, the spectrum analyzer is set to zero span mode with a 3 MHz resolution bandwidth at 5500MHz with a 2.5 minute sweep time. The analyzer's sweep will be started the same time power is applied to the U-NII device.

The UUT should not transmit any beacon or data transmissions until at least 1 minute after the completion of the power-on cycle.

The initial power up time of the UUT is indicated by marker 1 in the plot. Initial beacons/data transmissions are indicated by marker 1R.

Initial Channel Availability Check Time

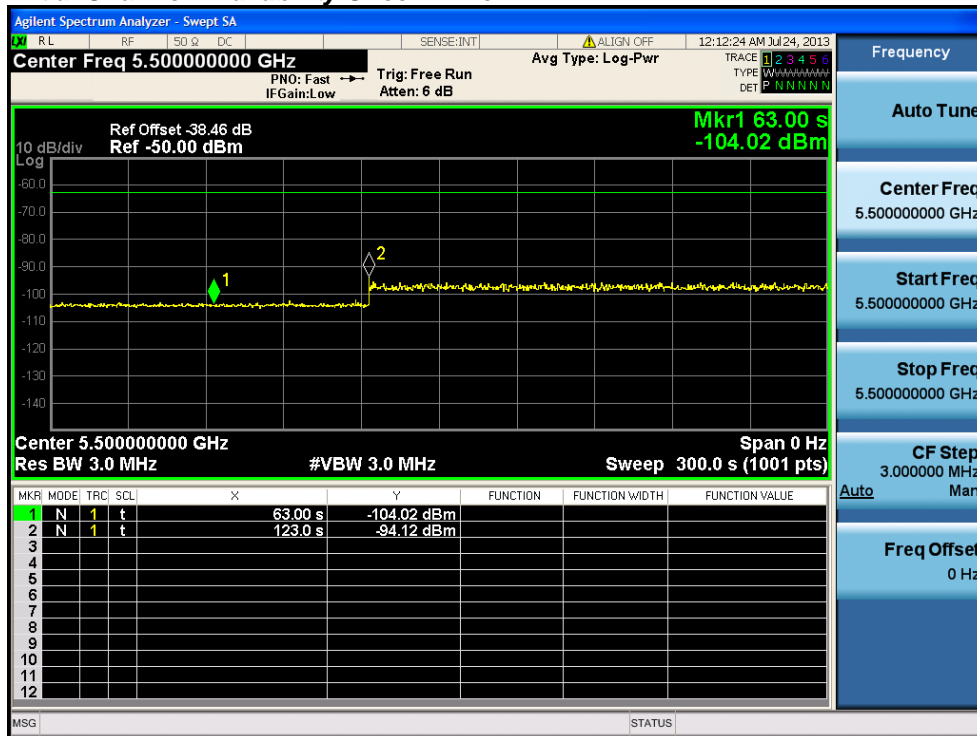



5. Radar Burst at the Beginning of the Channel Availability Check Time

The steps below define the procedure to verify successful radar detection on the selected Channel during a period equal to the Channel Availability Check Time and avoidance of operation on that Channel when a radar Burst with a level equal to the DFS Detection Threshold + 1 dB (-63dBm) occurs at the beginning of the Channel Availability Check Time.

The UUT is powered on at T_0 . T_1 denotes the instant when the UUT has completed its power-up sequence. The Channel Availability Check Time commences at instant T_1 and will end no sooner than $T_1 + 60$ seconds.

A single Burst of short pulse of radar type 1 at -63 dBm will commence within a 6 second window starting at T_1 .

Visual indication on the UUT of successful detection of the radar Burst will be recorded and reported. Observation of emissions at 5500MHz will continue for 2.5 minutes after the radar Burst has been generated.

Verify that during the 2.5 minute measurement window no UUT transmissions occurred at 5500MHz.

Radar Burst at the Beginning of the Channel Availability Check Time

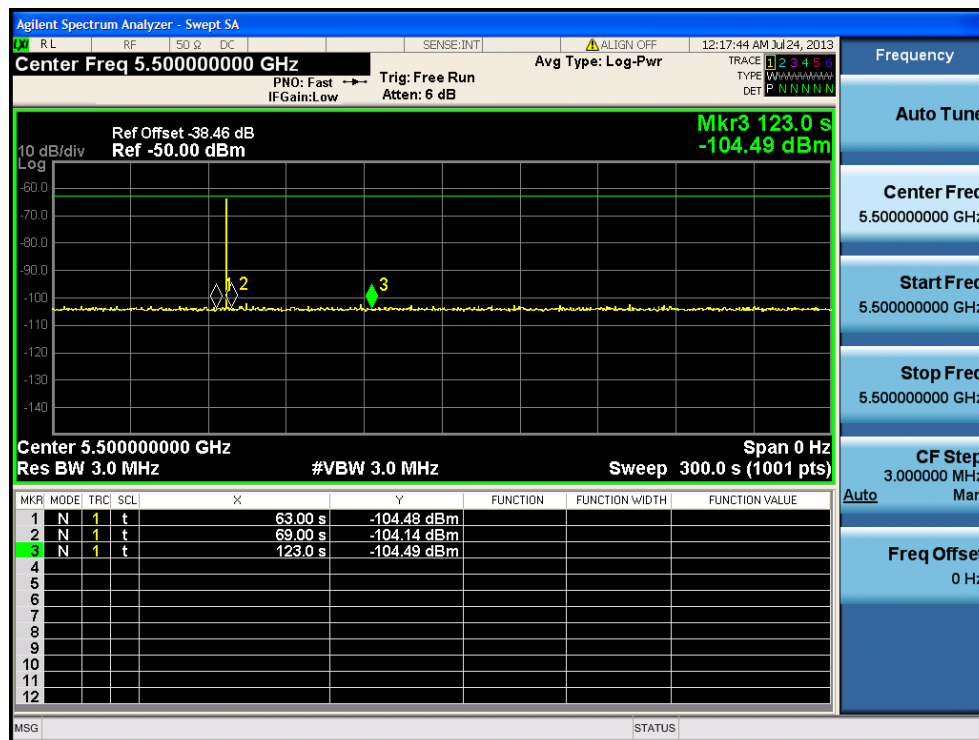



6. Radar Burst at the End of the Channel Availability Check Time

The steps below define the procedure to verify successful radar detection on the selected Channel during a period equal to the Channel Availability Check Time and avoidance of operation on that Channel when a radar Burst with a level equal to the DFS Detection Threshold + 1 dB (-63dBm) occurs at the end of the Channel Availability Check Time.

The UUT is powered on at T_0 . T_1 denotes the instant when the UUT has completed its power-up sequence. The Channel Availability Check Time commences at instant T_1 and will end no sooner than $T_1 + 60$ seconds.

A single Burst of short pulse of radar type 1 at -63 dBm will commence within a 6 second window starting at $T_1 + 54$ seconds.

Visual indication on the UUT of successful detection of the radar Burst will be recorded and reported. Observation of emissions at 5500MHz will continue for 2.5 minutes after the radar Burst has been generated.

Verify that during the 2.5 minute measurement window no UUT transmissions occurred at 5500MHz.

Radar Burst at the End of the Channel Availability Check Time

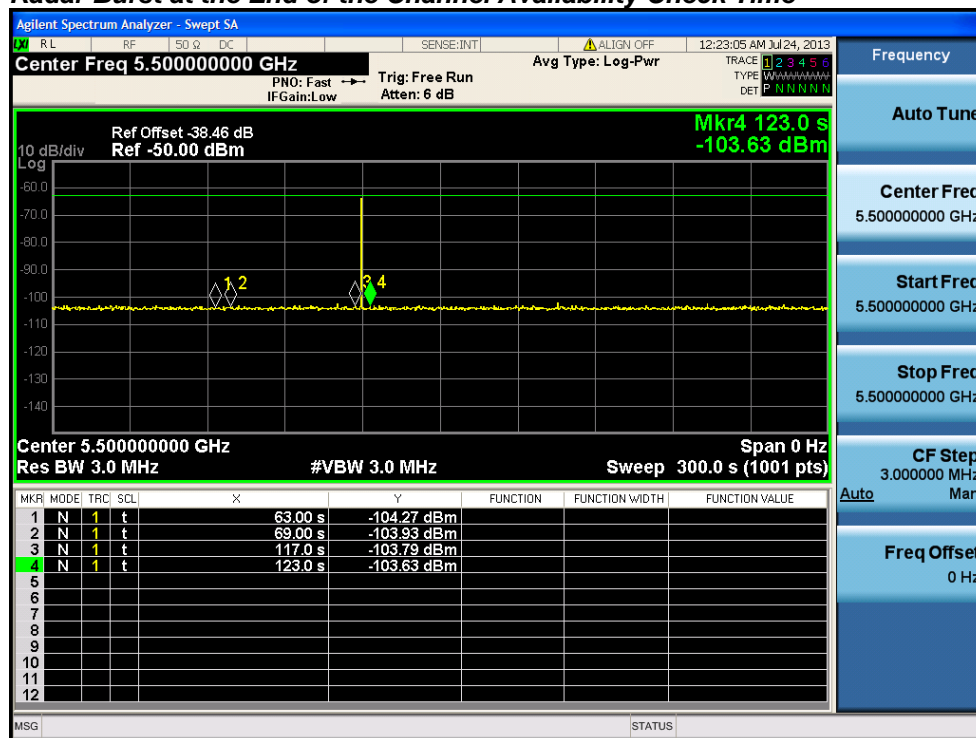



7. In-Service Monitoring for Channel Move Time, Channel Closing Transmission Time and Non-Occupancy Period

These tests define how the following DFS parameters are verified during In-Service Monitoring; Channel Closing Transmission Time, Channel Move Time, and Non-Occupancy Period.

The steps below define the procedure to determine the above mentioned parameters when a radar Burst with a level equal to the DFS Detection Threshold + 1dB (-63dBm) is generated on the Operating Channel of the U-NII device.

A U-NII device operating as a Client Device will associate with the UUT (Master) at 5500 MHz. Stream the MPEG test file from the Master Device to the Client Device on the selected Channel for the entire period of the test.

At time T_0 the Radar Waveform generator sends a Burst of pulses for each of the radar types at -63dBm.

Observe the transmissions of the UUT at the end of the radar Burst on the Operating Channel for duration greater than 10 seconds. Measure and record the transmissions from the UUT during the observation time (Channel Move Time). Compare the Channel Move Time and Channel Closing Transmission Time results to the limits defined in the *DFS Response requirement values table*.

The following plot demonstrates a channel close time of 50ms, with an aggregate of no more than 60 ms. Type 1 radar was used for this data.

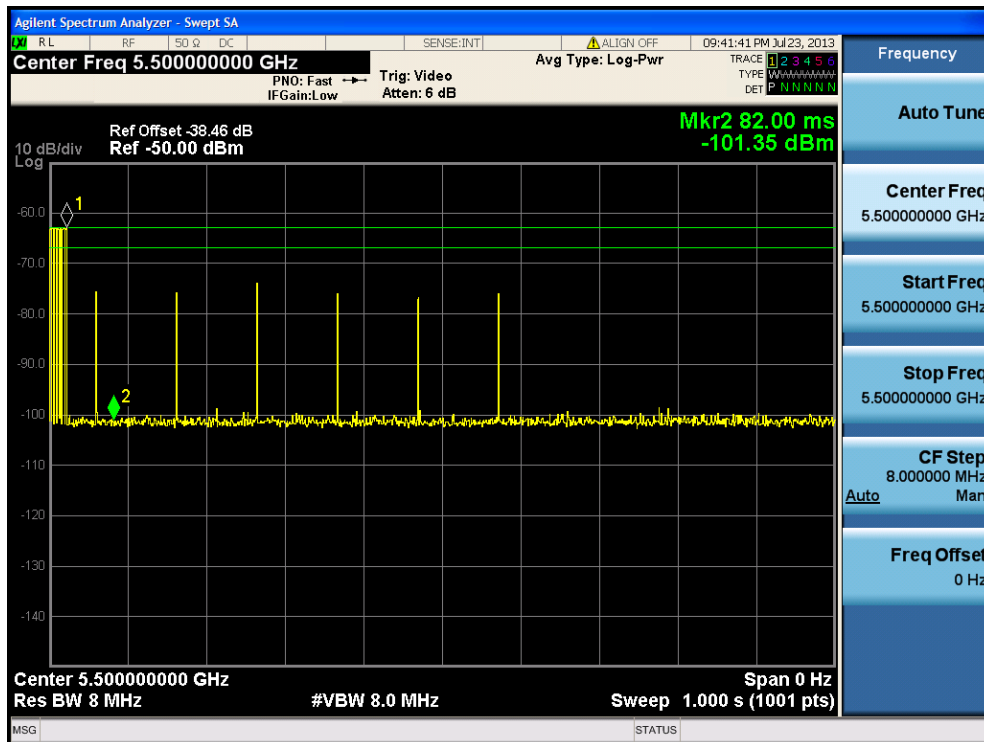



Channel Move Time, Channel Closing Transmission Time for USA Bin 1

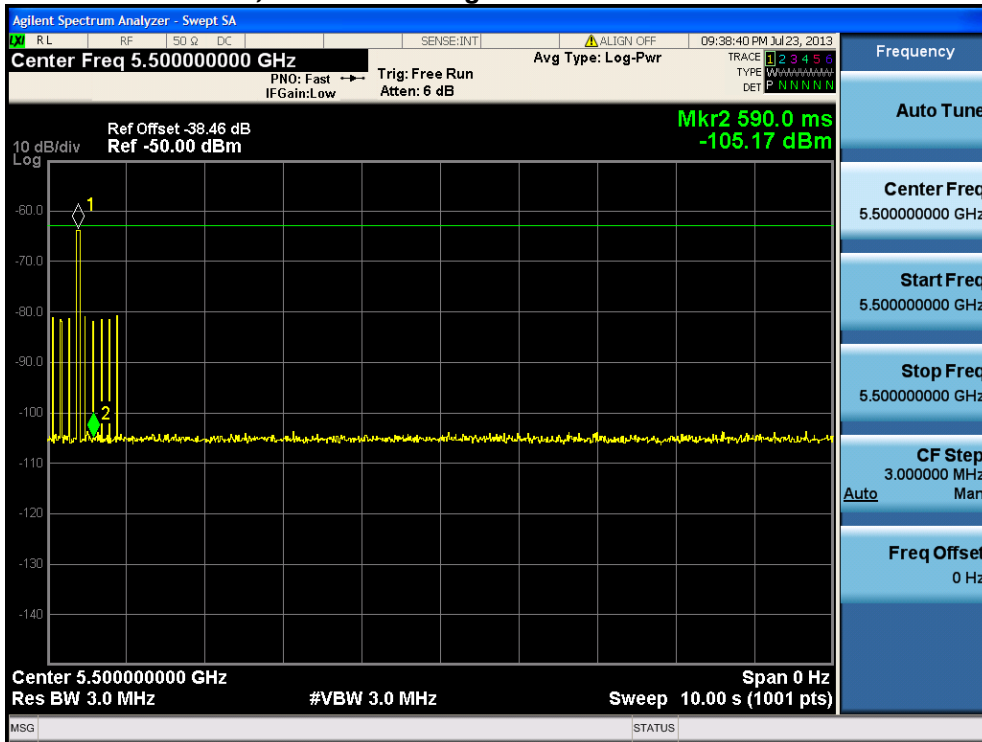

Channel Move Time, Channel Closing Transmission Time for USA Bin 2

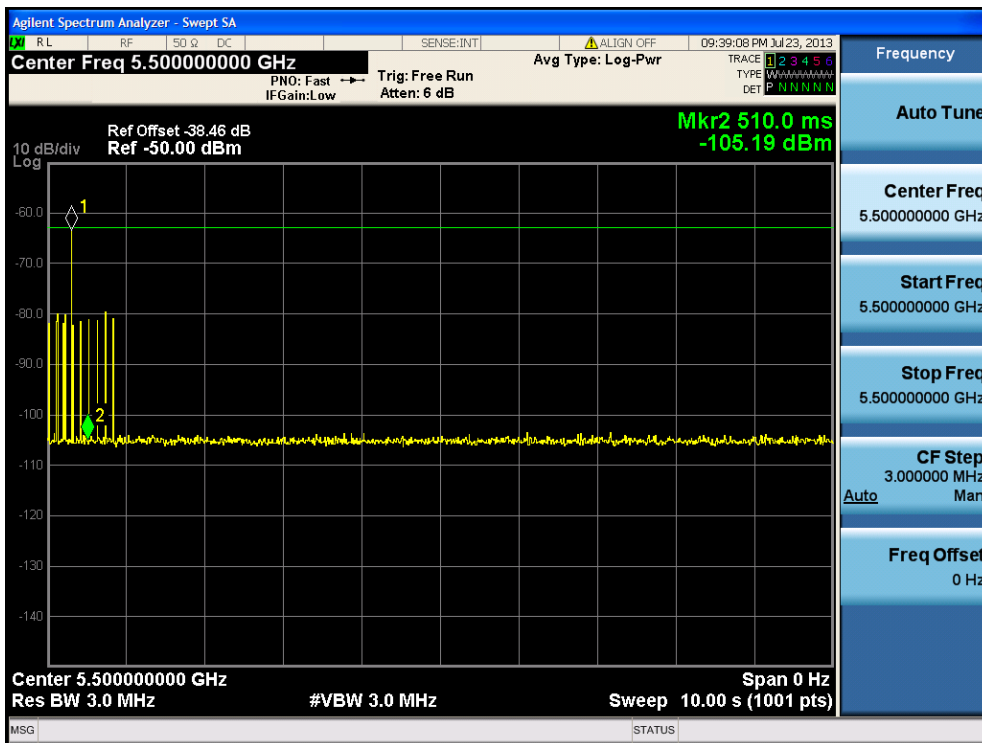



Channel Move Time, Channel Closing Transmission Time for USA Bin 3

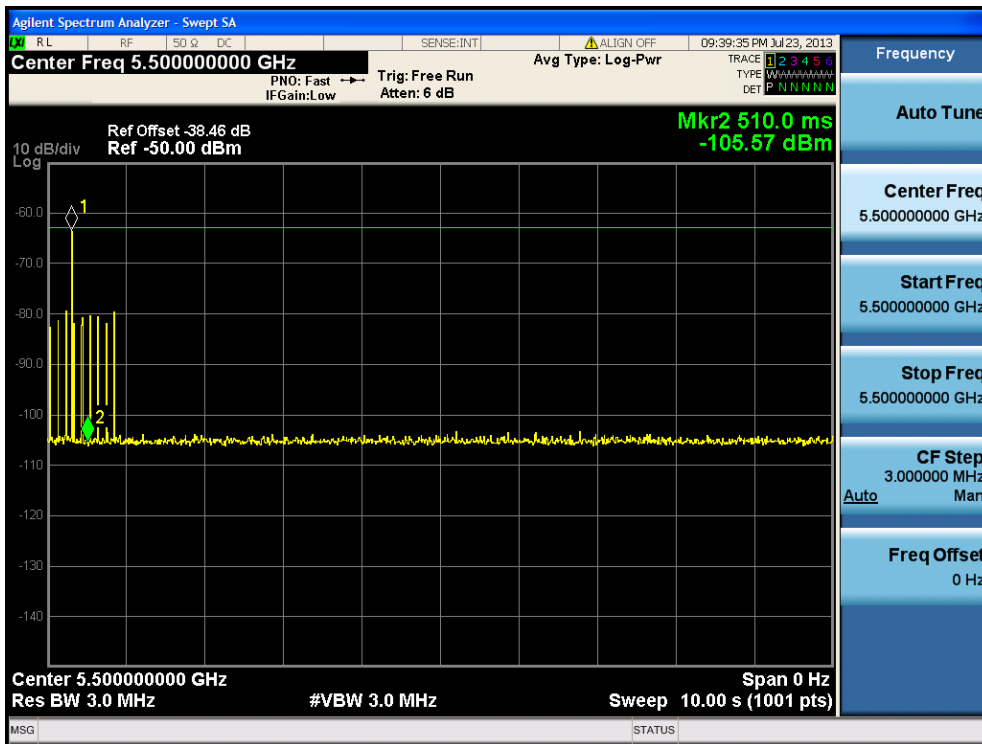

Channel Move Time, Channel Closing Transmission Time for USA Bin 4

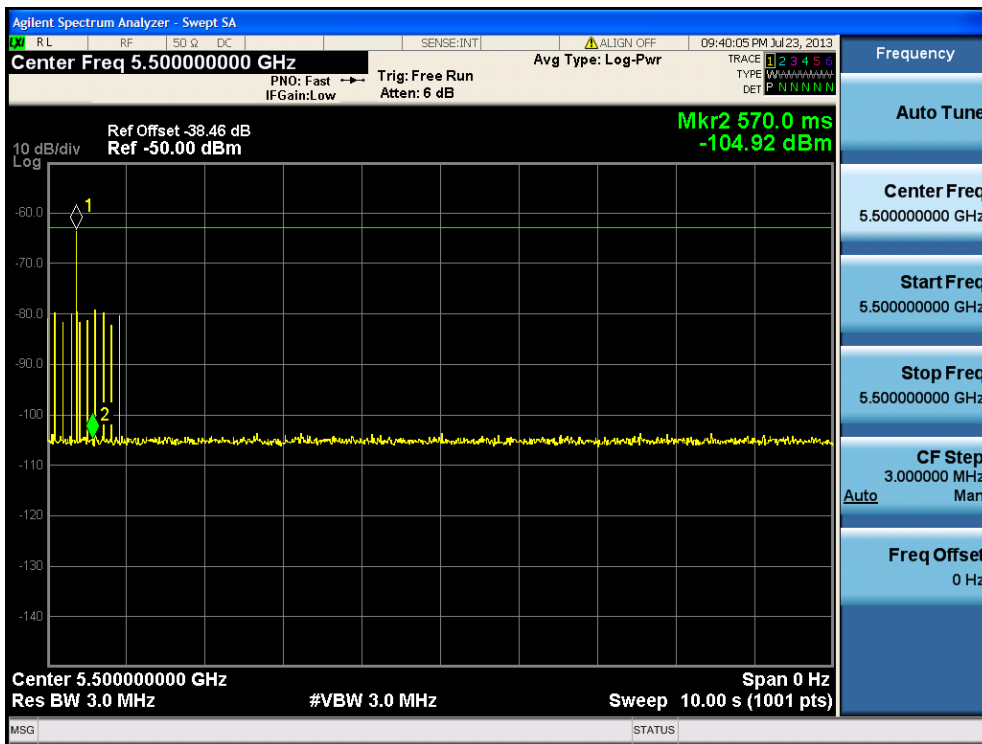



Channel Move Time, Channel Closing Transmission Time for USA Bin 5

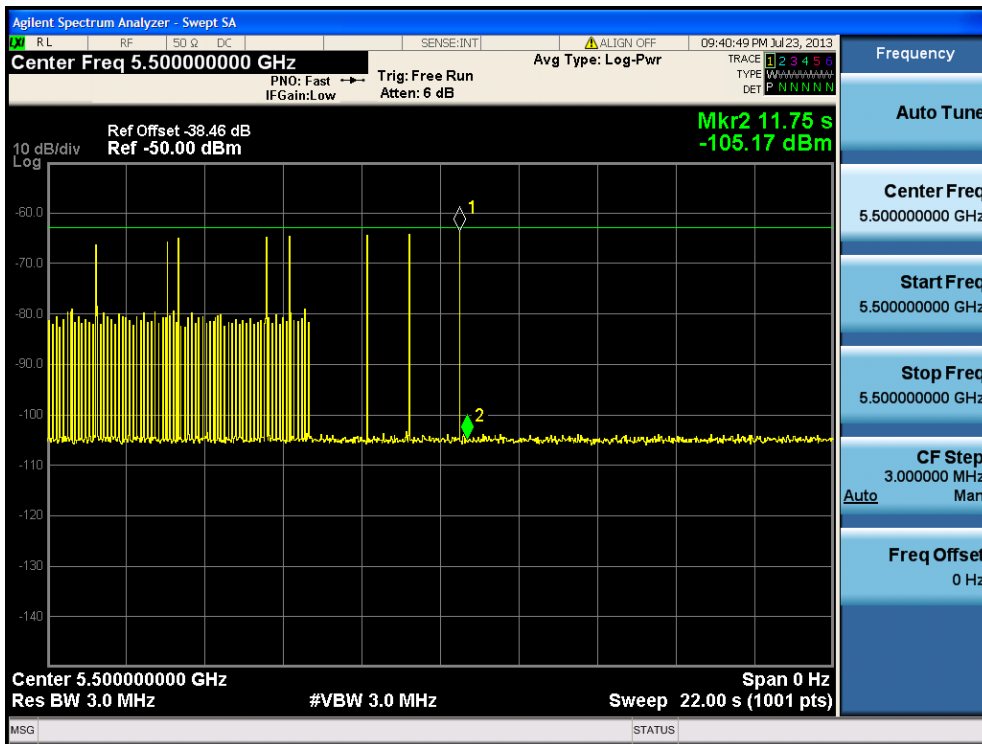

Channel Move Time, Channel Closing Transmission Time for USA Frequency Hopping

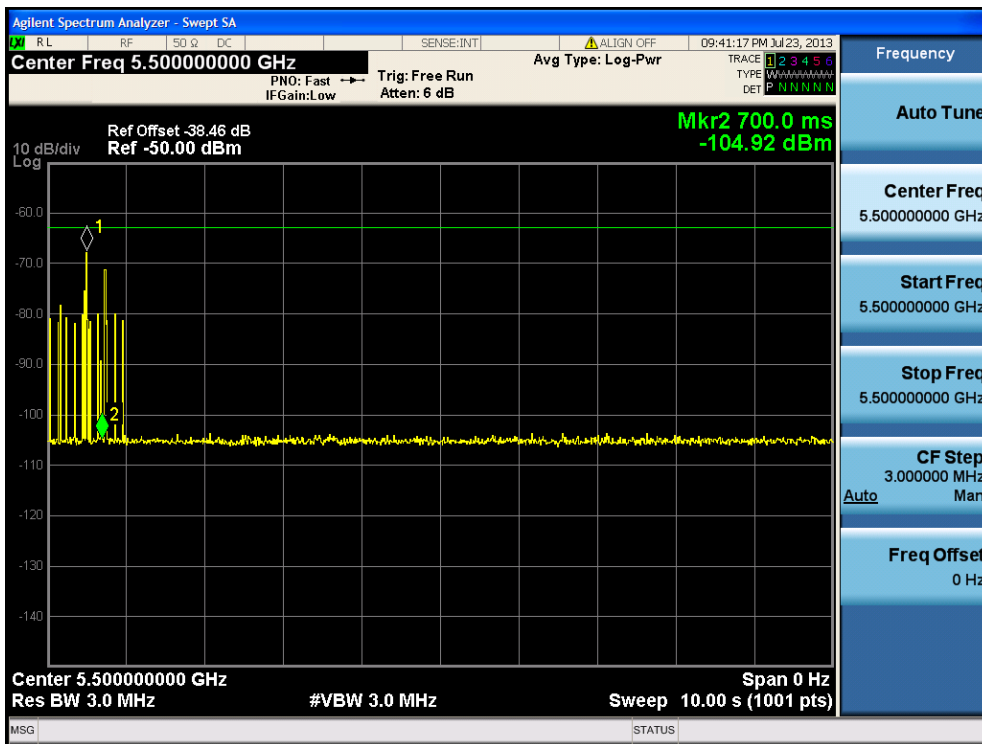



Measure the UUT for more than 30 minutes following the channel close/move time to verify that the UUT does not resume any transmissions on this Channel.

30 Minute Non-Occupancy Period (using Type 1 radar)

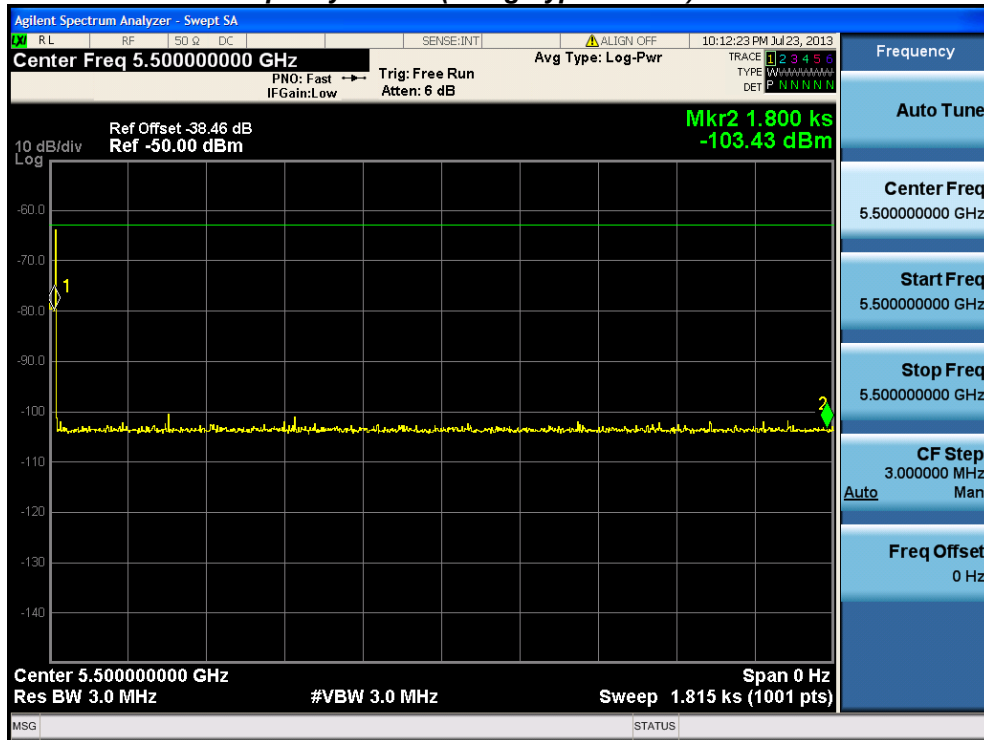

8. **Statistical Performance Check**

The steps below define the procedure to determine the minimum percentage of detection when a radar burst with a level equal to the DFS Detection Threshold + 1dB (-63dBm) is generated on the Operating Channel of the U-NII device.

A U-NII device operating as a Client Device will associate with the UUT (Master) at 5500 MHz. Stream the MPEG test file from the Master Device to the Client Device on the selected Channel for the entire period of the test.

The Radar Waveform generator sends the individual waveform for each of the radar types 1-6 at -63dbm. Statistical data will be gathered to determine the ability of the device to detect the radar test waveforms. The device can utilize a test mode to demonstrate when detection occurs to prevent the need to reset the device between trial runs. The percentage of successful detection is calculated by:

$$\frac{\textit{TotalWaveformDetections}}{\textit{TotalWaveformTrials}} \times 100 = \textit{Probability of Detection Radar Waveform}$$

The Minimum number of trails, minimum percentage of successful detection and the average minimum percentage of successful detection are found in the *Radar Test Waveforms* section. The data represents the worst case detection for 20 MHz and 40 MHz signal bandwidths.



USA Bin 1 Radar Statistical Performance

Trial #	PW	PRI	Pulses	1=Detection 0=No Detection	Detection Percentage	Limit
1	18	1	1428	0	86.7%	60.0%
2	18	1	1428	0		
3	18	1	1428	0		
4	18	1	1428	0		
5	18	1	1428	1		
6	18	1	1428	1		
7	18	1	1428	1		
8	18	1	1428	1		
9	18	1	1428	1		
10	18	1	1428	1		
11	18	1	1428	1		
12	18	1	1428	1		
13	18	1	1428	1		
14	18	1	1428	1		
15	18	1	1428	1		
16	18	1	1428	1		
17	18	1	1428	1		
18	18	1	1428	1		
19	18	1	1428	1		
20	18	1	1428	1		
21	18	1	1428	1		
22	18	1	1428	1		
23	18	1	1428	1		
24	18	1	1428	1		
25	18	1	1428	1		
26	18	1	1428	1		
27	18	1	1428	1		
28	18	1	1428	1		
29	18	1	1428	1		
30	18	1	1428	1		



USA Bin 2 Radar Statistical Performance

Trial #	PW	PRI	Pulses	1=Detection 0=No Detection	Detection Percentage	Limit
1	26	4.9	157	1	80.0%	60.0%
2	29	2.1	223	0		
3	25	4.5	211	1		
4	24	1	207	1		
5	25	4.9	167	0		
6	29	4.2	154	1		
7	26	3.8	226	1		
8	28	4.3	220	0		
9	26	4.7	192	1		
10	25	4.4	188	1		
11	23	1.7	201	1		
12	25	2.1	197	1		
13	28	2.3	224	0		
14	25	4.4	209	1		
15	24	1.5	160	1		
16	29	2.9	153	1		
17	29	3.8	202	0		
18	24	2.1	150	1		
19	26	4.7	197	1		
20	25	4.6	209	1		
21	29	3.1	226	1		
22	24	1.4	166	1		
23	26	1.8	155	1		
24	26	4.3	167	0		
25	25	3.4	166	1		
26	24	4.9	151	1		
27	26	3	185	1		
28	28	4.3	161	1		
29	27	2.1	177	1		
30	23	4.8	177	1		



USA Bin 3 Radar Statistical Performance

Trial #	PW	PRI	Pulses	1=Detection 0=No Detection	Detection Percentage	Limit
1	17	7.6	228	1	76.7%	60.0%
2	16	6.6	343	0		
3	16	8.1	395	1		
4	18	8.4	277	1		
5	17	7.7	409	0		
6	18	6.2	348	1		
7	16	7.1	363	0		
8	16	7.1	333	0		
9	18	7.2	280	1		
10	17	7.9	429	1		
11	18	10	301	0		
12	16	9.8	252	1		
13	16	6.4	381	0		
14	18	8.8	318	1		
15	17	9.2	441	1		
16	18	9.4	485	1		
17	17	6.5	203	1		
18	18	6.2	335	1		
19	18	7.9	422	0		
20	18	9.3	322	1		
21	18	9.5	337	1		
22	16	7.9	298	1		
23	18	6.6	319	1		
24	18	9	213	1		
25	16	7.8	446	1		
26	16	7	477	1		
27	16	6.7	375	1		
28	18	9	201	1		
29	16	8.4	439	1		
30	17	9.3	454	1		



USA Bin 4 Radar Statistical Performance

Trial #	PW	PRI	Pulses	1=Detection 0=No Detection	Detection Percentage	Limit
1	14	19.6	282	1	76.7%	60.0%
2	15	12.1	394	1		
3	13	16.8	466	1		
4	13	12.3	282	1		
5	16	12.2	266	0		
6	16	18.5	356	0		
7	12	12.6	281	1		
8	15	13.8	282	0		
9	15	11.3	284	1		
10	14	12.6	340	0		
11	13	14.5	412	1		
12	14	14.3	412	1		
13	13	16.1	221	1		
14	12	16.8	252	1		
15	12	19.5	352	1		
16	14	19.3	490	1		
17	14	17.6	327	1		
18	14	19.5	393	1		
19	13	18	329	1		
20	16	18.5	433	1		
21	14	16.7	488	1		
22	16	11.7	229	0		
23	12	12.4	237	1		
24	16	14.6	335	0		
25	13	13.8	340	1		
26	15	18.6	220	0		
27	15	13.9	500	1		
28	16	12.1	353	1		
29	14	12.6	283	1		
30	14	11.5	418	1		

In addition an average minimum percentage of successful detection across all four Short pulse radar test waveforms is required and is calculated as follows:

$$\frac{P_d 1 + P_d 2 + P_d 3 + P_d 4}{4} = (86.7\% + 80.0\% + 76.7\% + 76.7\%) / 4 = 80.0\% (>80\%)$$



*See the Bin5 Radar Characteristics at the end of this report.

USA Bin 5 Radar Statistical Performance

Trial #	Name	1=Detection 0=No Detection	Detection Percentage	Limit
1	USA Bin 5 Radar Test 1	1	100.0%	80.0%
2	USA Bin 5 Radar Test 2	1		
3	USA Bin 5 Radar Test 3	1		
4	USA Bin 5 Radar Test 4	1		
5	USA Bin 5 Radar Test 5	1		
6	USA Bin 5 Radar Test 6	1		
7	USA Bin 5 Radar Test 7	1		
8	USA Bin 5 Radar Test 8	1		
9	USA Bin 5 Radar Test 9	1		
10	USA Bin 5 Radar Test 10	1		
11	USA Bin 5 Radar Test 11	1		
12	USA Bin 5 Radar Test 12	1		
13	USA Bin 5 Radar Test 13	1		
14	USA Bin 5 Radar Test 14	1		
15	USA Bin 5 Radar Test 15	1		
16	USA Bin 5 Radar Test 16	1		
17	USA Bin 5 Radar Test 17	1		
18	USA Bin 5 Radar Test 18	1		
19	USA Bin 5 Radar Test 19	1		
20	USA Bin 5 Radar Test 20	1		
21	USA Bin 5 Radar Test 21	1		
22	USA Bin 5 Radar Test 22	1		
23	USA Bin 5 Radar Test 23	1		
24	USA Bin 5 Radar Test 24	1		
25	USA Bin 5 Radar Test 25	1		
26	USA Bin 5 Radar Test 26	1		
27	USA Bin 5 Radar Test 27	1		
28	USA Bin 5 Radar Test 28	1		
29	USA Bin 5 Radar Test 29	1		
30	USA Bin 5 Radar Test 30	1		



*See the Bin6 Radar Characteristics at the end of this report.

USA Frequency Hopping Radar Statistical Performance

Trial #	Name	1=Detection 0=No Detection	Detection Percentage	Limit
1	USA Bin 6 Radar Test 1	1	90.0%	70.0%
2	USA Bin 6 Radar Test 2	1		
3	USA Bin 6 Radar Test 3	1		
4	USA Bin 6 Radar Test 4	1		
5	USA Bin 6 Radar Test 5	1		
6	USA Bin 6 Radar Test 6	1		
7	USA Bin 6 Radar Test 7	0		
8	USA Bin 6 Radar Test 8	1		
9	USA Bin 6 Radar Test 9	1		
10	USA Bin 6 Radar Test 10	1		
11	USA Bin 6 Radar Test 11	1		
12	USA Bin 6 Radar Test 12	0		
13	USA Bin 6 Radar Test 13	1		
14	USA Bin 6 Radar Test 14	1		
15	USA Bin 6 Radar Test 15	1		
16	USA Bin 6 Radar Test 16	1		
17	USA Bin 6 Radar Test 17	1		
18	USA Bin 6 Radar Test 18	1		
19	USA Bin 6 Radar Test 19	1		
20	USA Bin 6 Radar Test 20	1		
21	USA Bin 6 Radar Test 21	1		
22	USA Bin 6 Radar Test 22	1		
23	USA Bin 6 Radar Test 23	1		
24	USA Bin 6 Radar Test 24	1		
25	USA Bin 6 Radar Test 25	1		
26	USA Bin 6 Radar Test 26	1		
27	USA Bin 6 Radar Test 27	1		
28	USA Bin 6 Radar Test 28	0		
29	USA Bin 6 Radar Test 29	1		
30	USA Bin 6 Radar Test 30	1		



USA Bin 5 Trial #1

Burst #	Pulses	Chirp (MHz)	PW (uS)	Inter-pulse spacing (uS)	Inter-pulse spacing (uS)	Pulse Start (S)
1	1	12	70			0.25003
2	2	9	55	1003		0.931395
3	2	8	65	1678		1.708799
4	3	12	65	1321	1426	1.81494
5	2	13	100	1047		2.84001
6	3	19	95	1074	1390	3.038786
7	2	8	70	1119		3.669631
8	3	6	75	1241	1809	4.47804
9	2	7	80	1884		5.228726
10	2	11	100	1163		5.50869
11	1	19	75			6.265008
12	3	8	80	1363	1330	7.17873
13	1	11	70			7.439209
14	3	11	50	1867	1916	7.809997
15	1	6	80			8.424865
16	1	16	85			9.152646
17	2	17	75	1125		9.902829
18	2	9	70	1561		10.633958
19	2	13	75	1362		10.882411
20	2	5	80	1769		11.855975

USA Bin 5 Trial #2

Burst #	Pulses	Chirp (MHz)	PW (uS)	Inter-pulse spacing (uS)	Inter-pulse spacing (uS)	Pulse Start (S)
1	1	11	50			0.51505
2	1	13	60			1.627897
3	2	6	55	1335		2.756355
4	3	17	70	1646	1191	3.614202
5	2	5	80	1052		3.69914
6	1	8	65			5.390732
7	3	9	55	1301	1585	5.721027
8	3	12	55	1134	1790	7.068069
9	3	16	70	1445	1224	7.633924
10	3	12	80	1503	1635	8.433046
11	3	15	75	1112	1107	10.018676
12	3	16	85	1303	1150	10.458392
13	1	14	85			11.414927

USA Bin 5 Trial #3

Burst #	Pulses	Chirp (MHz)	PW (uS)	Inter-pulse spacing (uS)	Inter-pulse spacing (uS)	Pulse Start (S)
1	3	15	100	1913	1475	0.030111
2	2	10	50	1452		0.772794
3	3	15	55	1479	1650	1.921941
4	2	9	100	1483		2.360825
5	1	17	70			3.14519
6	1	9	95			3.633473
7	2	11	95	1112		4.731789
8	3	16	100	1642	1632	5.336149
9	2	10	80	1928		6.249243
10	1	20	50			7.029919



11	3	10	50	1866	1823	7.701996
12	2	18	50	1810		8.286365
13	3	14	55	1166	1861	8.971057
14	1	6	70			9.743862
15	2	10	50	1805		10.157057
16	3	17	75	1189	1859	10.741942
17	3	6	100	1661	1279	11.665471

USA Bin 5 Trial #4

Burst #	Pulses	Chirp (MHz)	PW (uS)	Inter-pulse spacing (uS)	Inter-pulse spacing (uS)	Pulse Start (S)
1	3	17	70	1480	1111	0.001904
2	2	18	65	1433		1.649547
3	1	13	60			2.826281
4	2	5	50	1704		3.936381
5	3	6	100	1483	1475	5.757591
6	1	17	85			7.10847
7	3	9	100	1009	1918	8.208765
8	1	9	100			9.491756
9	3	20	90	1066	1705	10.794484
10	3	16	80	1279	1844	11.104091

USA Bin 5 Trial #5

Burst #	Pulses	Chirp (MHz)	PW (uS)	Inter-pulse spacing (uS)	Inter-pulse spacing (uS)	Pulse Start (S)
1	2	15	60	1276		0.559219
2	1	6	70			1.331878
3	1	11	65			2.634389
4	1	13	70			3.920378
5	1	14	80			4.7646
6	3	20	55	1863	1183	5.371253
7	1	19	50			6.51813
8	2	14	100	1052		7.92566
9	2	5	65	1828		8.720955
10	2	20	85	1882		9.421921
11	1	7	75			10.444647
12	1	17	60			11.111583

USA Bin 5 Trial #6

Burst #	Pulses	Chirp (MHz)	PW (uS)	Inter-pulse spacing (uS)	Inter-pulse spacing (uS)	Pulse Start (S)
1	2	9	85	1822		0.066747
2	2	11	85	1782		2.520163
3	3	20	70	1117	1142	3.098519
4	1	15	60			5.895743
5	2	10	60	1788		7.343853
6	2	13	95	1355		7.63739
7	1	12	55			9.752911
8	3	11	90	1672	1140	10.78217

USA Bin 5 Trial #7

Burst #	Pulses	Chirp (MHz)	PW (uS)	Inter-pulse spacing (uS)	Inter-pulse spacing (uS)	Pulse Start (S)
1	1	9	95			0.943359
2	1	14	60			1.520536
3	3	6	70	1681	1761	2.833177
4	1	20	95			3.070121



5	3	10	100	1661	1455	4.455718
6	1	7	50			5.850266
7	3	11	80	1241	1585	6.471391
8	3	9	85	1106	1611	7.191855
9	1	18	85			8.331194
10	3	10	70	1355	1262	9.068644
11	1	7	85			10.024786
12	2	14	50	1498		11.736409

USA Bin 5 Trial #8

Burst #	Pulses	Chirp (MHz)	PW (uS)	Inter-pulse spacing (uS)	Inter-pulse spacing (uS)	Pulse Start (S)
1	2	10	80	1065		0.097212
2	2	17	80	1848		0.825316
3	3	16	95	1886	1332	1.61534
4	1	6	95			3.098278
5	3	9	90	1442	1526	3.23031
6	2	13	90	1547		4.01214
7	3	9	80	1100	1540	5.588044
8	3	5	65	1123	1782	6.305624
9	1	20	95			6.496673
10	2	16	75	1060		7.444697
11	1	6	100			8.292188
12	3	9	90	1689	1616	8.98863
13	1	18	60			9.742124
14	1	18	70			11.049716
15	2	10	60	1387		11.274503

USA Bin 5 Trial #9

Burst #	Pulses	Chirp (MHz)	PW (uS)	Inter-pulse spacing (uS)	Inter-pulse spacing (uS)	Pulse Start (S)
1	3	11	55	1778	1248	0.007708
2	1	9	90			1.225617
3	3	15	85	1572	1587	1.972732
4	1	11	75			2.568779
5	1	11	75			3.47165
6	3	17	50	1825	1991	4.575373
7	3	14	80	1572	1284	4.939116
8	1	11	90			5.693978
9	1	15	80			6.577405
10	2	8	65	1641		7.721383
11	1	9	100			8.48797
12	3	7	90	1383	1983	8.85103
13	1	10	95			10.387618
14	3	6	70	1645	1863	10.815994
15	2	10	75	1696		11.824182

USA Bin 5 Trial #10

Burst #	Pulses	Chirp (MHz)	PW (uS)	Inter-pulse spacing (uS)	Inter-pulse spacing (uS)	Pulse Start (S)
1	1	6	65			0.339262
2	3	18	55	1481	1173	2.265865
3	2	6	55	1131		3.064165
4	3	12	95	1271	1514	4.807009
5	2	7	100	1573		6.092343



6	1	20	95			7.804485
7	2	6	90	1766		8.885187
8	3	7	80	1527	1556	9.557984
9	1	14	70			11.159304

USA Bin 5 Trial #11

Burst #	Pulses	Chirp (MHz)	PW (uS)	Inter-pulse spacing (uS)	Inter-pulse spacing (uS)	Pulse Start (S)
1	3	8	85	1271	1166	0.494035
2	3	18	100	1544	1317	1.927138
3	1	6	85			2.326517
4	1	15	85			4.07852
5	2	20	75	1075		5.020131
6	3	8	95	1046	1494	6.263834
7	3	5	90	1606	1139	7.312726
8	2	16	90	1620		8.240907
9	1	20	50			8.969632
10	2	10	90	1461		10.721057
11	2	8	50	1933		11.599397

USA Bin 5 Trial #12

Burst #	Pulses	Chirp (MHz)	PW (uS)	Inter-pulse spacing (uS)	Inter-pulse spacing (uS)	Pulse Start (S)
1	3	19	65	1620	1124	0.310514
2	2	16	90	1444		1.147327
3	2	16	85	1747		1.711001
4	1	17	60			2.276942
5	2	12	95	1684		3.285881
6	3	8	95	1213	1545	4.07257
7	1	16	75			4.998568
8	1	12	60			5.680743
9	3	7	75	1341	1536	6.516744
10	3	14	95	1211	1461	6.794332
11	1	14	70			7.894546
12	1	5	85			8.786564
13	2	20	75	1745		9.566855
14	3	8	55	1532	1039	9.921289
15	1	17	55			10.578645
16	3	19	65	1063	1817	11.43604

USA Bin 5 Trial #13

Burst #	Pulses	Chirp (MHz)	PW (uS)	Inter-pulse spacing (uS)	Inter-pulse spacing (uS)	Pulse Start (S)
1	1	6	70			1.406661
2	2	16	65	1460		1.626807
3	2	5	85	1670		4.42959
4	2	12	70	1286		5.175155
5	1	10	55			7.375064
6	2	14	75	1321		8.318004
7	3	17	65	1353	1650	10.225006
8	1	10	75			11.597586

USA Bin 5 Trial #14

Burst #	Pulses	Chirp (MHz)	PW (uS)	Inter-pulse spacing (uS)	Inter-pulse spacing (uS)	Pulse Start (S)
1	3	7	80	1633	1853	0.44338
2	3	14	80	1813	1799	1.425628



3	2	14	55	1517		1.942484
4	3	6	100	1514	1829	2.734929
5	1	20	100			3.285296
6	1	20	70			4.37392
7	3	18	85	1881	1096	4.964142
8	1	14	90			5.83664
9	2	14	75	1282		7.00251
10	2	16	70	1771		7.424662
11	2	18	60	1532		8.645794
12	2	19	65	1638		8.858874
13	3	8	95	1414	1071	9.822178
14	1	6	55			11.094684
15	2	17	60	1653		11.822525

USA Bin 5 Trial #15

Burst #	Pulses	Chirp (MHz)	PW (uS)	Inter-pulse spacing (uS)	Inter-pulse spacing (uS)	Pulse Start (S)
1	3	6	55	1029	1744	0.897884
2	3	6	60	1855	1273	1.5751
3	1	20	95			2.580468
4	1	6	55			3.393436
5	3	10	75	1198	1488	4.592312
6	2	16	60	1339		5.282757
7	3	14	75	1430	1779	5.816109
8	3	14	50	1537	1368	7.082261
9	1	9	55			8.259734
10	3	10	65	1143	1417	8.527199
11	2	10	85	1889		9.28534
12	1	13	75			10.766199
13	2	19	65	1541		11.571047

USA Bin 5 Trial #16

Burst #	Pulses	Chirp (MHz)	PW (uS)	Inter-pulse spacing (uS)	Inter-pulse spacing (uS)	Pulse Start (S)
1	3	12	80	1979	1726	0.357774
2	3	5	75	1044	1731	1.921415
3	3	11	50	1146	1128	2.523742
4	3	5	70	1188	1962	3.520944
5	1	14	95			4.580853
6	2	7	75	1290		5.524383
7	3	12	55	1818	1267	7.461309
8	2	15	80	1589		8.085314
9	2	13	90	1599		9.161862
10	1	14	65			10.320687
11	3	18	60	1035	1880	11.718286

USA Bin 5 Trial #17

Burst #	Pulses	Chirp (MHz)	PW (uS)	Inter-pulse spacing (uS)	Inter-pulse spacing (uS)	Pulse Start (S)
1	3	14	85	1996	1500	0.718169
2	3	7	65	1420	1648	1.33815
3	2	17	50	1124		2.012873
4	3	14	100	1754	1592	2.711914
5	1	13	75			3.38123
6	2	17	75	1318		4.217777



7	2	18	100	1622		5.042937
8	2	20	85	1208		5.933214
9	1	15	60			6.156459
10	1	13	75			6.978868
11	3	13	70	1046	1256	7.901495
12	2	7	90	1672		8.750615
13	2	5	80	1605		9.639956
14	1	11	50			10.168865
15	3	7	55	1297	1117	10.700734
16	2	20	90	1837		11.359058

USA Bin 5 Trial #18

Burst #	Pulses	Chirp (MHz)	PW (uS)	Inter-pulse spacing (uS)	Inter-pulse spacing (uS)	Pulse Start (S)
1	1	16	65			1.167177
2	1	12	55			2.384768
3	2	6	100	1156		3.580275
4	2	18	90	1426		4.738516
5	2	11	80	1101		6.310383
6	2	10	90	1485		6.850395
7	3	11	90	1396	1786	8.048352
8	1	20	80			10.341463
9	3	8	90	1824	1079	11.049391

USA Bin 5 Trial #19

Burst #	Pulses	Chirp (MHz)	PW (uS)	Inter-pulse spacing (uS)	Inter-pulse spacing (uS)	Pulse Start (S)
1	1	5	60			0.199845
2	2	7	50	1768		1.495027
3	2	13	95	1847		1.932133
4	3	13	50	1532	1817	3.06524
5	1	12	65			4.399304
6	2	7	100	1676		5.373186
7	3	5	75	1967	1605	5.569
8	1	6	85			6.89847
9	1	8	70			7.486679
10	1	15	50			8.365622
11	3	16	75	1031	1647	9.30152
12	2	12	60	1966		10.34328
13	2	13	85	1685		11.476492

USA Bin 5 Trial #20

Burst #	Pulses	Chirp (MHz)	PW (uS)	Inter-pulse spacing (uS)	Inter-pulse spacing (uS)	Pulse Start (S)
1	3	14	70	1557	1783	0.114263
2	1	8	65			0.958212
3	3	11	55	1851	1904	1.723194
4	2	10	85	1322		3.069372
5	3	10	75	1281	1014	3.251162
6	1	16	95			4.723026
7	2	8	70	1816		5.44413
8	1	17	70			6.167074
9	3	16	60	1406	1717	6.429455
10	1	17	85			7.961008
11	3	14	60	1691	1375	8.728798



12	3	13	90	1600	1221	9.144827
13	1	14	80			9.802499
14	1	7	85			11.043984
15	1	10	85			11.506165

USA Bin 5 Trial #21

Burst #	Pulses	Chirp (MHz)	PW (uS)	Inter-pulse spacing (uS)	Inter-pulse spacing (uS)	Pulse Start (S)
1	1	9	95			0.652976
2	1	11	100			1.013389
3	2	12	55	1452		2.069996
4	1	16	50			2.874687
5	3	11	70	1059	1791	3.132944
6	2	19	90	1134		3.997301
7	2	19	100	1276		5.023608
8	1	5	85			5.590899
9	2	5	55	1200		6.209022
10	3	14	60	1865	1678	7.133781
11	3	7	60	1001	1295	8.083897
12	1	20	90			8.549567
13	3	13	95	1630	1893	9.01068
14	1	9	75			9.794235
15	1	16	55			10.955301
16	1	14	70			11.476821

USA Bin 5 Trial #22

Burst #	Pulses	Chirp (MHz)	PW (uS)	Inter-pulse spacing (uS)	Inter-pulse spacing (uS)	Pulse Start (S)
1	2	5	80	1426		0.528512
2	3	13	55	1913	1807	1.445455
3	1	18	90			2.02043
4	3	8	95	1250	1518	2.936975
5	1	13	65			3.106487
6	2	13	100	1260		3.988302
7	1	12	65			4.897655
8	2	5	50	1738		5.35885
9	2	18	75	1604		6.160886
10	1	5	85			7.303469
11	1	17	95			7.763562
12	2	8	90	1228		8.742983
13	1	6	70			9.048697
14	3	10	70	1578	1342	10.015276
15	1	16	90			10.596409
16	3	5	95	1488	1172	11.454006

USA Bin 5 Trial #23

Burst #	Pulses	Chirp (MHz)	PW (uS)	Inter-pulse spacing (uS)	Inter-pulse spacing (uS)	Pulse Start (S)
1	1	13	60			1.121914
2	1	8	90			2.081351
3	3	16	65	1554	1749	3.490339
4	3	15	75	1092	1704	3.729691
5	2	6	95	1603		5.194838
6	1	16	95			6.494438
7	2	5	70	1769		8.337276

8	3	17	75	1179	1793	8.987604
9	2	16	55	1742		9.801075
10	3	13	50	1966	1418	11.316449

USA Bin 5 Trial #24

Burst #	Pulses	Chirp (MHz)	PW (uS)	Inter-pulse spacing (uS)	Inter-pulse spacing (uS)	Pulse Start (S)
1	3	7	80	1735	1313	0.374613
2	3	6	80	1644	1500	1.189599
3	3	11	100	1438	1661	2.441129
4	1	12	80			3.030765
5	1	12	70			3.934359
6	3	14	80	1971	1067	4.956148
7	1	7	95			6.090819
8	1	16	70			7.233177
9	3	5	85	1804	1105	7.511492
10	3	18	60	1220	1627	8.756059
11	3	18	100	1757	1954	9.484664
12	3	5	55	1163	1332	10.711156
13	2	6	50	1734		11.836501

USA Bin 5 Trial #25

Burst #	Pulses	Chirp (MHz)	PW (uS)	Inter-pulse spacing (uS)	Inter-pulse spacing (uS)	Pulse Start (S)
1	3	5	95	1932	1721	0.448776
2	3	9	70	1549	1932	1.191995
3	2	5	70	1299		1.665939
4	3	5	95	1805	1502	2.066912
5	3	12	95	1574	1796	2.775741
6	3	10	70	1991	1131	3.070484
7	3	13	75	1115	1216	4.105207
8	1	17	75			4.728602
9	2	19	80	1825		5.344698
10	3	20	100	1960	1505	5.722855
11	2	20	75	1976		6.552607
12	1	20	50			7.021802
13	3	15	65	1760	1004	7.498997
14	3	12	85	1742	1304	7.913285
15	2	6	85	1523		8.755669
16	2	17	75	1301		9.349497
17	1	16	90			10.067801
18	2	20	60	1912		10.650563
19	1	14	55			10.948397
20	1	6	65			11.633053

USA Bin 5 Trial #26

Burst #	Pulses	Chirp (MHz)	PW (uS)	Inter-pulse spacing (uS)	Inter-pulse spacing (uS)	Pulse Start (S)
1	3	20	55	1735	1750	0.080102
2	3	18	60	1994	1119	1.170809
3	3	17	50	1061	1379	1.617854
4	1	8	60			2.525666
5	2	10	75	1452		3.353114
6	2	10	95	1443		3.539398
7	3	7	90	1114	1327	4.292078



8	1	12	60			5.502486
9	2	8	75	1419		6.028365
10	2	8	95	1522		6.490248
11	2	7	95	1818		7.160389
12	1	14	75			8.126887
13	1	11	60			8.927707
14	2	13	50	1010		9.442244
15	3	11	55	1824	1950	10.416317
16	2	14	60	1522		10.603765
17	3	18	80	1339	1492	11.697488

USA Bin 5 Trial #27

Burst #	Pulses	Chirp (MHz)	PW (uS)	Inter-pulse spacing (uS)	Inter-pulse spacing (uS)	Pulse Start (S)
1	1	19	70			0.510257
2	1	12	90			1.361875
3	1	20	55			2.172247
4	1	18	80			3.480556
5	1	17	75			4.461083
6	1	14	50			4.781769
7	1	10	80			6.059188
8	3	12	70	1942	1844	6.806078
9	3	5	95	1510	1041	7.754936
10	1	5	80			8.393541
11	1	18	100			9.714444
12	2	11	55	1843		10.999557
13	2	20	50	1836		11.921224

USA Bin 5 Trial #28

Burst #	Pulses	Chirp (MHz)	PW (uS)	Inter-pulse spacing (uS)	Inter-pulse spacing (uS)	Pulse Start (S)
1	3	20	60	1201	1883	0.055738
2	3	13	100	1170	1597	2.525424
3	3	5	55	1514	1532	3.486411
4	3	7	65	1139	1976	4.429224
5	2	6	95	1313		5.999914
6	2	19	80	1144		7.020764
7	2	17	65	1992		8.687301
8	3	10	65	1950	1074	9.871643
9	2	8	75	1015		11.335441

USA Bin 5 Trial #29

Burst #	Pulses	Chirp (MHz)	PW (uS)	Inter-pulse spacing (uS)	Inter-pulse spacing (uS)	Pulse Start (S)
1	2	13	65	1789		0.963333
2	3	17	50	1602	1898	1.168073
3	3	5	80	1103	1015	2.413687
4	1	7	50			4.301762
5	1	17	60			4.372635
6	2	5	65	1253		6.127852
7	2	19	80	1530		7.451835
8	1	18	100			7.704129
9	3	9	70	1366	1251	8.823576
10	1	12	100			10.167282
11	3	18	50	1863	1292	11.396365



USA Bin 5 Trial #30

Burst #	Pulses	Chirp (MHz)	PW (uS)	Inter-pulse spacing (uS)	Inter-pulse spacing (uS)	Pulse Start (S)
1	3	17	80	1529	1579	0.215603
2	3	11	55	1481	1842	0.670385
3	3	15	70	1434	1154	1.536013
4	3	12	90	1060	1212	2.388397
5	1	18	65			2.47049
6	2	16	65	1660		3.390101
7	1	18	55			3.65636
8	2	20	50	1198		4.236706
9	3	6	55	1112	1462	4.861752
10	1	6	100			5.447507
11	2	17	50	1632		6.155637
12	3	15	70	1643	1302	6.885607
13	2	8	65	1615		7.689658
14	3	15	95	1443	1270	7.964316
15	3	7	50	1342	1495	8.801944
16	1	16	90			9.512596
17	1	20	80			10.196092
18	3	16	85	1028	1393	10.427242
19	3	7	75	1974	1191	11.337141
20	3	12	55	1190	1702	11.754292

USA Frequency Hopping Trial #1

Hop #	Freq (GHz)	Pulse Start (mS)
3	5505	9
11	5514	33
18	5460	54
28	5529	84
31	5478	93
35	5493	105
38	5532	114
41	5495	123
44	5467	132
49	5501	147
54	5524	162
55	5533	165
56	5487	168
58	5480	174
59	5527	177
63	5538	189
64	5516	192
66	5513	198
69	5494	207
73	5492	219
79	5539	237
85	5512	255
87	5530	261
92	5465	276
94	5475	282

USA Frequency Hopping Trial #2

Hop #	Freq (GHz)	Pulse Start (mS)
0	5537	0
1	5507	3
4	5500	12
24	5475	72
25	5495	75
28	5509	84
33	5477	99
40	5486	120
42	5501	126
58	5460	174
66	5526	198
67	5499	201
70	5529	210
73	5517	219
74	5527	222
82	5465	246
85	5478	255
89	5520	267
90	5533	270
93	5469	279

96	5494	288
99	5531	297

USA Frequency Hopping Trial #3

Hop #	Freq (GHz)	Pulse Start (mS)
3	5468	9
4	5521	12
9	5514	27
25	5507	75
33	5516	99
36	5501	108
37	5500	111
41	5497	123
42	5491	126
50	5474	150
54	5506	162
57	5519	171
62	5465	186
74	5504	222
79	5524	237
81	5480	243
83	5503	249
86	5473	258

USA Frequency Hopping Trial #4

Hop #	Freq (GHz)	Pulse Start (mS)
4	5498	12
6	5507	18
15	5463	45
22	5528	66
31	5499	93
32	5476	96
38	5474	114
47	5461	141
53	5469	159
58	5477	174
63	5533	189
67	5506	201
88	5465	264
89	5509	267
93	5471	279
96	5516	288
99	5539	297

USA Frequency Hopping Trial #5

Hop #	Freq (GHz)	Pulse Start (mS)
1	5466	3
2	5527	6
3	5510	9
11	5539	33
13	5529	39
28	5526	84

29	5532	87
35	5500	105
45	5479	135
57	5534	171
58	5473	174
60	5525	180
61	5502	183
65	5509	195
69	5494	207
70	5538	210
72	5519	216
74	5471	222
77	5501	231
83	5513	249
86	5484	258
88	5504	264
93	5505	279
96	5514	288

USA Frequency Hopping Trial #6

Hop #	Freq (GHz)	Pulse Start (mS)
9	5473	27
12	5504	36
20	5512	60
23	5501	69
29	5523	87
32	5472	96
33	5535	99
59	5514	177
84	5467	252
89	5516	267
92	5483	276
96	5528	288

USA Frequency Hopping Trial #7

Hop #	Freq (GHz)	Pulse Start (mS)
7	5503	21
13	5490	39
14	5502	42
16	5480	48
21	5466	63
23	5464	69
33	5521	99
36	5479	108
37	5518	111
41	5540	123
42	5478	126
54	5487	162
55	5532	165
56	5511	168
88	5489	264



95	5529	285
98	5533	294
99	5519	297

USA Frequency Hopping Trial #8

Hop #	Freq (GHz)	Pulse Start (mS)
0	5489	0
10	5476	30
11	5460	33
13	5484	39
15	5539	45
21	5463	63
31	5500	93
34	5490	102
38	5477	114
50	5469	150
58	5520	174
59	5504	177
65	5509	195
70	5511	210
77	5475	231
79	5506	237
83	5473	249
84	5472	252
85	5518	255
91	5528	273

USA Frequency Hopping Trial #9

Hop #	Freq (GHz)	Pulse Start (mS)
21	5463	63
22	5482	66
25	5475	75
26	5489	78
28	5498	84
32	5523	96
34	5535	102
36	5485	108
37	5465	111
45	5525	135
56	5540	168
59	5495	177
64	5500	192
79	5496	237
80	5517	240
87	5479	261
93	5537	279
94	5507	282
97	5484	291

USA Frequency Hopping Trial #10

Hop #	Freq (GHz)	Pulse Start (mS)
2	5523	6

7	5494	21
9	5473	27
11	5470	33
19	5511	57
20	5471	60
22	5497	66
23	5496	69
27	5477	81
35	5538	105
36	5526	108
45	5483	135
51	5474	153
68	5516	204
72	5514	216
80	5487	240
90	5463	270
95	5486	285

USA Frequency Hopping Trial #11

Hop #	Freq (GHz)	Pulse Start (mS)
0	5487	0
4	5484	12
17	5502	51
19	5516	57
20	5536	60
33	5500	99
42	5492	126
48	5511	144
50	5481	150
55	5478	165
58	5498	174
63	5461	189
88	5472	264
94	5535	282
97	5483	291

USA Frequency Hopping Trial #12

Hop #	Freq (GHz)	Pulse Start (mS)
1	5481	3
4	5473	12
11	5469	33
19	5483	57
21	5487	63
30	5524	90
33	5484	99
46	5531	138
49	5513	147
55	5460	165
64	5476	192
80	5490	240
85	5517	255



90	5474	270
92	5491	276
94	5511	282
98	5520	294

USA Frequency Hopping Trial #13

Hop #	Freq (GHz)	Pulse Start (mS)
5	5538	15
14	5469	42
19	5512	57
25	5475	75
37	5533	111
40	5468	120
42	5484	126
44	5515	132
58	5503	174
65	5465	195
67	5467	201
71	5476	213
75	5479	225
79	5526	237
80	5510	240
92	5522	276
94	5513	282
97	5478	291

USA Frequency Hopping Trial #14

Hop #	Freq (GHz)	Pulse Start (mS)
3	5499	9
9	5461	27
13	5518	39
17	5531	51
23	5503	69
41	5465	123
42	5494	126
48	5508	144
55	5528	165
58	5482	174
61	5493	183
66	5535	198
73	5483	219
78	5475	234
79	5472	237
90	5537	270
93	5464	279

USA Frequency Hopping Trial #15

Hop #	Freq (GHz)	Pulse Start (mS)
2	5510	6
3	5512	9
5	5504	15
11	5500	33



40	5527	120
49	5525	147
50	5474	150
55	5514	165
59	5505	177
65	5467	195
67	5501	201
76	5462	228
79	5484	237
97	5540	291

USA Frequency Hopping Trial #16

Hop #	Freq (GHz)	Pulse Start (mS)
1	5496	3
3	5509	9
6	5508	18
15	5461	45
16	5504	48
20	5470	60
23	5462	69
30	5535	90
39	5465	117
49	5483	147
51	5474	153
54	5481	162
58	5484	174
61	5486	183
75	5501	225
78	5534	234
84	5500	252
88	5493	264
89	5491	267
92	5482	276
94	5515	282

USA Frequency Hopping Trial #17

Hop #	Freq (GHz)	Pulse Start (mS)
3	5482	9
4	5538	12
6	5522	18
7	5518	21
21	5534	63
24	5477	72
28	5505	84
33	5510	99
40	5483	120
47	5537	141
54	5463	162
60	5486	180
61	5521	183
66	5520	198



68	5515	204
72	5494	216
75	5526	225
77	5474	231
78	5529	234
79	5524	237
97	5495	291

USA Frequency Hopping Trial #18

Hop #	Freq (GHz)	Pulse Start (mS)
0	5508	0
2	5523	6
3	5463	9
6	5538	18
11	5509	33
17	5471	51
19	5460	57
20	5473	60
21	5495	63
22	5502	66
34	5464	102
43	5515	129
53	5535	159
54	5488	162
63	5461	189
64	5504	192
78	5512	234
91	5536	273

USA Frequency Hopping Trial #19

Hop #	Freq (GHz)	Pulse Start (mS)
2	5538	6
7	5528	21
10	5524	30
13	5533	39
14	5461	42
17	5525	51
18	5487	54
20	5473	60
21	5495	63
24	5507	72
34	5529	102
47	5465	141
50	5464	150
54	5488	162
57	5472	171
59	5468	177
65	5512	195
73	5484	219
86	5477	258

USA Frequency Hopping Trial #20

Hop #	Freq (GHz)	Pulse Start (mS)
14	5482	42
19	5526	57
21	5513	63
27	5475	81
33	5488	99
37	5516	111
54	5515	162
61	5540	183
66	5489	198
78	5530	234
81	5509	243
98	5460	294

USA Frequency Hopping Trial #21

Hop #	Freq (GHz)	Pulse Start (mS)
2	5502	6
3	5514	9
12	5523	36
21	5462	63
30	5500	90
54	5535	162
55	5479	165
60	5510	180
64	5474	192
71	5498	213
72	5507	216
92	5464	276
93	5481	279

USA Frequency Hopping Trial #22

Hop #	Freq (GHz)	Pulse Start (mS)
1	5479	3
6	5499	18
18	5517	54
34	5471	102
35	5512	105
43	5481	129
46	5493	138
52	5506	156
63	5462	189
64	5502	192
69	5485	207
74	5473	222
77	5526	231
81	5466	243
90	5522	270
91	5540	273
97	5492	291

USA Frequency Hopping Trial #23

Hop #	Freq (GHz)	Pulse Start (mS)
-------	------------	------------------

7	5507	21
17	5491	51
22	5496	66
32	5530	96
33	5527	99
58	5489	174
59	5500	177
62	5540	186
63	5509	189
66	5536	198
70	5525	210
72	5539	216
73	5486	219
80	5476	240
81	5463	243
89	5471	267
92	5532	276
93	5485	279
98	5522	294

USA Frequency Hopping Trial #24

Hop #	Freq (GHz)	Pulse Start (mS)
1	5476	3
11	5478	33
12	5533	36
14	5467	42
18	5505	54
27	5527	81
35	5475	105
38	5516	114
44	5534	132
49	5466	147
50	5512	150
52	5464	156
61	5531	183
63	5479	189
70	5471	210
72	5535	216
80	5462	240
82	5514	246
87	5532	261
90	5540	270
91	5490	273
93	5517	279
97	5518	291

USA Frequency Hopping Trial #25

Hop #	Freq (GHz)	Pulse Start (mS)
4	5483	12
8	5535	24
17	5527	51



20	5496	60
23	5517	69
24	5513	72
33	5501	99
35	5488	105
36	5529	108
39	5490	117
44	5525	132
48	5514	144
53	5537	159
72	5466	216
86	5502	258

USA Frequency Hopping Trial #26

Hop #	Freq (GHz)	Pulse Start (mS)
3	5518	9
4	5469	12
6	5506	18
14	5481	42
24	5511	72
33	5461	99
36	5490	108
49	5478	147
60	5482	180
62	5484	186
78	5465	234
79	5468	237
82	5527	246
90	5502	270
92	5488	276
95	5507	285

USA Frequency Hopping Trial #27

Hop #	Freq (GHz)	Pulse Start (mS)
0	5506	0
6	5481	18
17	5466	51
21	5508	63
22	5495	66
29	5476	87
31	5524	93
49	5475	147
51	5490	153
52	5512	156
55	5461	165
59	5494	177
62	5491	186
74	5489	222
75	5501	225
77	5503	231
90	5499	270



98	5525	294
USA Frequency Hopping Trial #28		
Hop #	Freq (GHz)	Pulse Start (mS)
2	5515	6
3	5490	9
4	5462	12
10	5506	30
12	5501	36
21	5480	63
32	5487	96
37	5463	111
39	5470	117
53	5528	159
60	5467	180
71	5537	213
88	5484	264
96	5492	288
98	5524	294

USA Frequency Hopping Trial #29		
Hop #	Freq (GHz)	Pulse Start (mS)
1	5476	3
3	5508	9
4	5537	12
11	5529	33
25	5486	75
34	5460	102
40	5502	120
46	5491	138
53	5490	159
54	5533	162
60	5504	180
70	5498	210
72	5509	216
81	5506	243

USA Frequency Hopping Trial #30		
Hop #	Freq (GHz)	Pulse Start (mS)
11	5472	33
16	5517	48
26	5485	78
29	5493	87
30	5534	90
32	5468	96
36	5484	108
38	5469	114
50	5460	150
63	5463	189
70	5521	210
71	5492	213
79	5489	237



85	5497	255
87	5533	261
90	5519	270
94	5476	282