



Dynamic Frequency Selection (DFS) Test Report

AIR-CAP3602y-A-K9

Cisco Aironet 802.11n Dual Band Access Points

FCC ID: LDK102075

IC: 2461B-102075

y = E (External Antenna) or I (Internal Antenna)

5250-5350, 5470-5725 MHz

Against the following Specifications:

CFR47 Part 15.407

RSS210

Cisco Systems

170 West Tasman Drive

San Jose, CA 95134



This test report has been electronically authorized and archived using the CISCO Engineering Document Control system.

DFS DETECTION THRESHOLDS	4
RADAR WAVEFORM CALIBRATION.....	8
TEST PROCEDURE/RESULTS.....	12
<i>UNII DETECTION BANDWIDTH RESULTS, 20MHZ SIGNAL BANDWIDTH.....</i>	<i>15</i>
<i>UNII DETECTION BANDWIDTH RESULTS, 40 MHZ SIGNAL BANDWIDTH.....</i>	<i>21</i>
<i>INITIAL CHANNEL AVAILABILITY CHECK TIME.....</i>	<i>27</i>
<i>CHANNEL CLOSE TIME</i>	<i>30</i>
<i>CHANNEL MOVE TIME, CHANNEL CLOSING TRANSMISSION TIME FOR TYPE 1 RADAR.</i>	<i>31</i>
<i>CHANNEL MOVE TIME, CHANNEL CLOSING TRANSMISSION TIME FOR TYPE 2 RADAR.....</i>	<i>31</i>
<i>CHANNEL MOVE TIME, CHANNEL CLOSING TRANSMISSION TIME FOR TYPE 3 RADAR.</i>	<i>32</i>
<i>CHANNEL MOVE TIME, CHANNEL CLOSING TRANSMISSION TIME FOR TYPE 4 RADAR.</i>	<i>32</i>
<i>CHANNEL MOVE TIME, CHANNEL CLOSING TRANSMISSION TIME FOR TYPE 5 RADAR.</i>	<i>33</i>
<i>CHANNEL MOVE TIME, CHANNEL CLOSING TRANSMISSION TIME FOR TYPE 6 RADAR.....</i>	<i>33</i>
<i>30 MINUTE NON-OCCUPANCY PERIOD (USING TYPE 1 RADAR)</i>	<i>34</i>
STATISTICAL PERFORMANCE CHECK.....	35



Dynamic Frequency Selection (DFS) Test Results

15.407: U-NII devices operating in the 5.25-5.35 GHz band and the 5.47-5.725 GHz band shall employ a TPC mechanism. The U-NII device is required to have the capability to operate at least 6 dB below the mean EIRP value of 30 dBm. A TPC mechanism is not required for systems with an e.i.r.p. of less than 500 mW.

U-NII devices operating in the 5.25-5.35 GHz and 5.47-5.725 GHz bands shall employ a DFS radar detection mechanism to detect the presence of radar systems and to avoid co-channel operation with radar systems.

1.0 UNII Device Description

1. The 3600 Series Cisco Aironet 802.11n Dual Band Access Points operate in the following bands:
 - a. 5150-5250 MHz
 - b. 5250-5350 MHz
 - c. 5470-5725 MHz (excluding 5600-5650 MHz)
 - d. 5725-5850 MHz
2. The maximum EIRP of the 5GHz equipment is 29 dBm, and the minimum possible EIRP is -1 dBm.

Below are the available 50 ohm antenna assemblies and their corresponding gains. 0dBi gain was used to set the -63 dBm threshold level (-64dBm +1 dB) during calibration of the test setup.

Frequency	Part Number	Antenna Type	Antenna Gain (dBi)
2.4/5 GHz	AIR-ANT2524DB-R	Dual-resonant black dipole	2 / 4
	AIR-ANT2524DW-R	Dual-resonant white dipole	2 / 4
	AIR-ANT2524DG-R	Dual-resonant gray dipole	2 / 4
	AIR-ANT2534V4C-R	Dual-resonant ceiling mount omni (4-pack)	3 / 4
	AIR-ANT2546V4M-R	Dual-resonant omni (4-pack)	4 / 6
	AIR-ANT2566P4W-R	Dual-resonant "directional" antenna (4-pack)	6 / 6
	Internal	Dual-resonant omnidirectional	3 / 5

3. System testing was performed with the designated MPEG test file that streams full motion video at 30 frames per second from the Master to the Client IP based system.
4. The Master requires 106.5 seconds to complete its power-on cycle.
5. Information regarding the parameters of the detected Radar Waveforms is not available to the end user.
6. For the 5250-5350 MHz and 5470-5725 MHz bands, the Master device provides, on aggregate, uniform loading of the spectrum across all devices by selecting an operating channel among the available channels using a random algorithm.

2.0 DFS Detection Thresholds

1. Interference Threshold values, Master or Client incorporating In-Service Monitoring

Maximum Transmit Power	Value (see note)
≥ 200 milliwatt	-64 dBm
< 200 milliwatt	-62 dBm
Note 1: This is the level at the input of the receiver assuming a 0 dBi receive antenna Note 2: Throughout these test procedures an additional 1 dB has been added to the amplitude of the test transmission waveforms to account for variations in measurement equipment. This will ensure that the test signal is at or above the detection threshold level to trigger a DFS response.	

2. DFS Response requirement values

Parameter	Value
<i>Non-occupancy period</i>	Minimum 30 minutes
<i>Channel Availability Check Time</i>	60 seconds
<i>Channel Move Time</i>	10 seconds See Note 1.
<i>Channel Closing Transmission Time</i>	200 milliseconds + an aggregate of 60 milliseconds over remaining 10 second period. See Notes 1 and 2.
<i>U-NII Detection Bandwidth</i>	Minimum 80% of the 99% power bandwidth See Note 3.
Note 1: The instant that the <i>Channel Move Time</i> and the <i>Channel Closing Transmission Time</i> begins is as follows: <ul style="list-style-type: none"> • For the Short pulse radar Test Signals this instant is the end of the <i>Burst</i>. • For the Frequency Hopping radar Test Signal, this instant is the end of the last radar <i>Burst</i> generated. • For the Long Pulse radar Test Signal this instant is the end of the 12 second period defining the radar transmission. Note 2: The <i>Channel Closing Transmission Time</i> is comprised of 200 milliseconds starting at the beginning of the <i>Channel Move Time</i> plus any additional intermittent control signals required to facilitate <i>Channel</i> changes (an aggregate of 60 milliseconds) during the remainder of the 10 second period. The aggregate duration of control signals will not count quiet periods in between transmissions. Note 3: During the <i>U-NII Detection Bandwidth</i> detection test, radar type 1 is used and for each frequency step the minimum percentage of detection is 90%. Measurements are performed with no data traffic.	

3.0 Radar Test Waveforms

This section provides the parameters for required test waveforms, minimum percentage of successful detections, and the minimum number of trials that must be used for determining DFS conformance. Step intervals of 0.1 microsecond for Pulse Width, 1 microsecond for PRI, 1 MHz for chirp width and 1 for the number of pulses will be utilized for the random determination of specific test waveforms.

1. Short Pulse Radar Test Waveforms

Radar Type	Pulse Width (μsec)	PRI (μsec)	Number of Pulses	Minimum Percentage of Successful Detection	Minimum Trials
1	1	1428	18	60%	30
2	1-5	150-230	23-29	60%	30
3	6-10	200-500	16-18	60%	30
4	11-20	200-500	12-16	60%	30
Aggregate (Radar Types 1-4)				80%	120

A minimum of 30 unique waveforms are required for each of the short pulse radar types 2 through 4. For short pulse radar type 1, the same waveform is used a minimum of 30 times. If more than 30 waveforms are used for short pulse radar types 2 through 4, then each additional waveform must also be unique and not repeated from the previous waveforms. The aggregate is the average of the percentage of successful detections of short pulse radar types 1-4.

2. Long Pulse Radar Test Waveform

Radar Type	Pulse Width (μsec)	Chirp Width (MHz)	PRI (μsec)	Number of Pulses per Burst	Number of Bursts	Minimum Percentage of Successful Detection	Minimum Trials
5	50-100	5-20	1000-2000	1-3	8-20	80%	30

The parameters for this waveform are randomly chosen. Thirty unique waveforms are required for the Long Pulse radar test signal. If more than 30 waveforms are used for the Long Pulse radar test signal, then each additional waveform must also be unique and not repeated from the previous waveforms.

Each waveform is defined as follows:

- 1) The transmission period for the Long Pulse Radar test signal is 12 seconds.
- 2) There are a total of 8 to 20 Bursts in the 12 second period, with the number of Bursts being randomly chosen. This number is Burst_Count.
- 3) Each Burst consists of 1 to 3 pulses, with the number of pulses being randomly chosen. Each Burst within the 12 second sequence may have a different number of pulses.



- 4) The pulse width is between 50 and 100 microseconds, with the pulse width being randomly chosen. Each pulse within a Burst will have the same pulse width. Pulses in different Bursts may have different pulse widths.
- 5) Each pulse has a linear FM chirp between 5 and 20 MHz, with the chirp width being randomly chosen. Each pulse within a Burst will have the same chirp width. Pulses in different Bursts may have different chirp widths. The chirp is centered on the pulse. For example, with a radar frequency of 5300 MHz and a 20 MHz chirped signal, the chirp starts at 5290 MHz and ends at 5310 MHz.
- 6) If more than one pulse is present in a Burst, the time between the pulses will be between 1000 and 2000 microseconds, with the time being randomly chosen. If three pulses are present in a Burst, the time between the first and second pulses is chosen independently of the time between the second and third pulses.
- 7) The 12 second transmission period is divided into even intervals. The number of intervals is equal to Burst_Count. Each interval is of length $(12,000,000 / \text{Burst_Count})$ microseconds. Each interval contains one Burst. The start time for the Burst, relative to the beginning of the interval, is between 1 and $[(12,000,000 / \text{Burst_Count}) - (\text{Total Burst Length}) + (\text{One Random PRI Interval})]$ microseconds, with the start time being randomly chosen. The step interval for the start time is 1 microsecond. The start time for each Burst is chosen independently.

A representative example of a Long Pulse radar test waveform:

- 1) The total test signal length is 12 seconds.
- 2) 8 Bursts are randomly generated for the Burst_Count.
- 3) Burst 1 has 2 randomly generated pulses.
- 4) The pulse width (for both pulses) is randomly selected to be 75 microseconds.
- 5) The PRI is randomly selected to be at 1213 microseconds.
- 6) Bursts 2 through 8 are generated using steps 3 – 5.
- 7) Each Burst is contained in even intervals of 1,500,000 microseconds. The starting location for Pulse 1, Burst 1 is randomly generated (1 to 1,500,000 minus the total Burst 1 length + 1 random PRI interval) at the 325,001 microsecond step. Bursts 2 through 8 randomly fall in successive 1,500,000 microsecond intervals (i.e. Burst 2 falls in the 1,500,001 – 3,000,000 microsecond range).

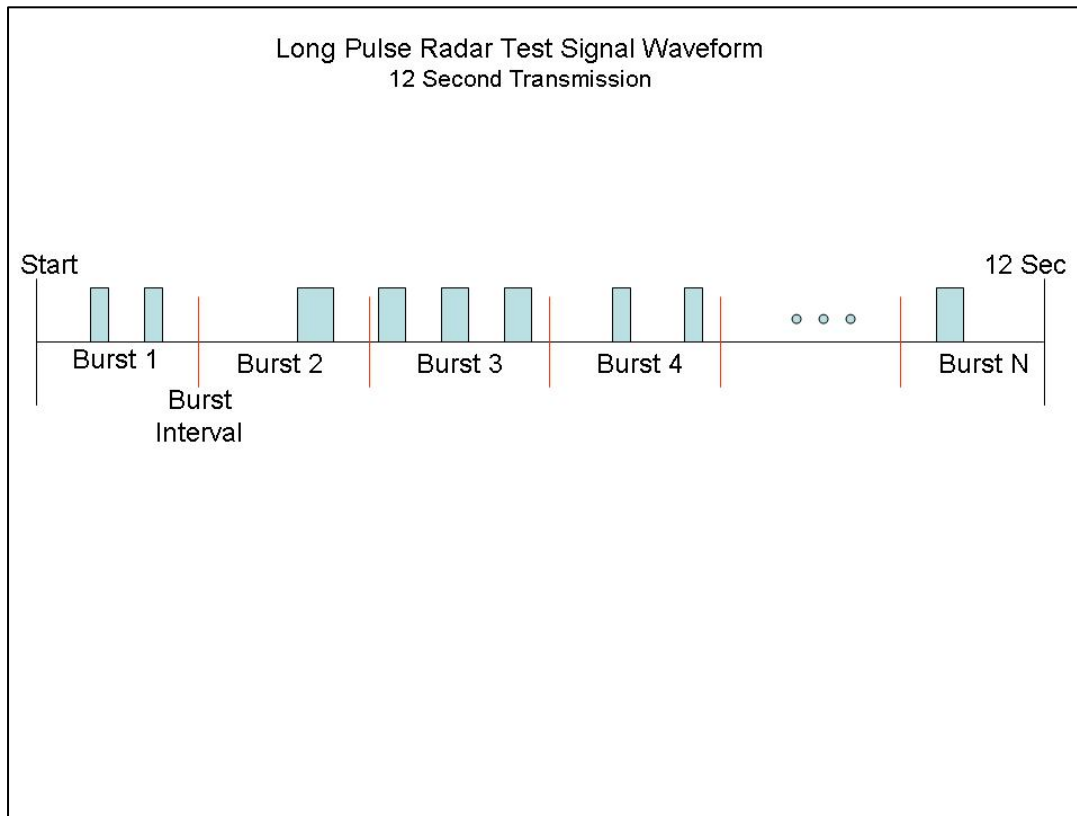

Graphical Representation of a Long Pulse radar Test Waveform

3. Frequency Hopping Radar Test Waveform

Radar Type	Pulse Width (µsec)	PRI (µsec)	Pulses per Hop	Hopping Rate (kHz)	Hopping Sequence Length (msec)	Minimum Percentage of Successful Detection	Minimum Trials
6	1	333	9	.333	300	70%	30

For the Frequency Hopping Radar Type, the same *Burst* parameters are used for each waveform. The hopping sequence is different for each waveform and a 100-length segment is selected¹ from the hopping sequence defined by the following algorithm:

The first frequency in a hopping sequence is selected randomly from the group of 475 integer frequencies from 5250 – 5724 MHz. Next, the frequency that was just chosen is removed from the group and a frequency is randomly selected from the remaining 474 frequencies in the group. This

process continues until all 475 frequencies are chosen for the set. For selection of a random frequency, the frequencies remaining within the group are always treated as equally likely.

4.0 Radar Waveform Calibration

1. The following equipment setup was used to calibrate the conducted Radar Waveform. A spectrum analyzer was used to establish the test signal level for each radar type. During this process there were no transmissions by either the Master or Client Device. The spectrum analyzer was switched to the zero span (Time Domain) mode at the frequency of the Radar Waveform generator. Peak detection was utilized. The spectrum analyzer resolution bandwidth (RBW) and video bandwidth (VBW) were set to 3 MHz.

The signal generator amplitude was set so that the power level measured at the spectrum analyzer was -63dBm.

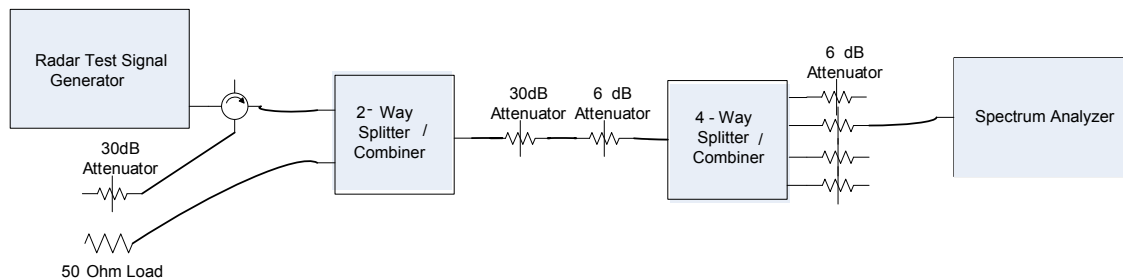

Conducted Calibration Setup



2. Following are the calibration plots for each of the required radar waveforms.

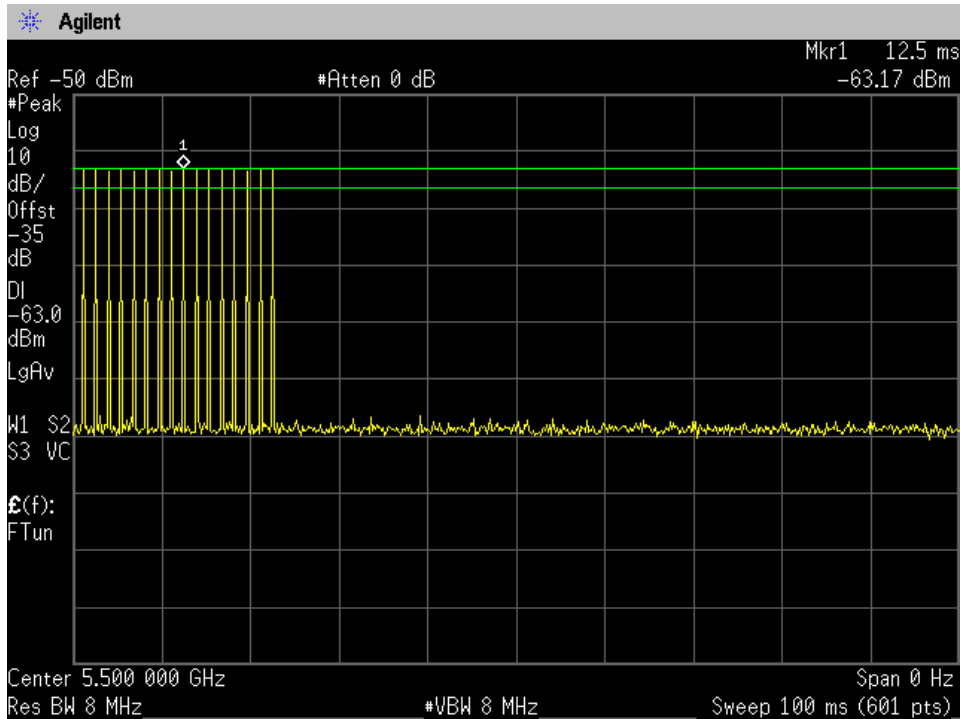

Bin 1 Radar Calibration

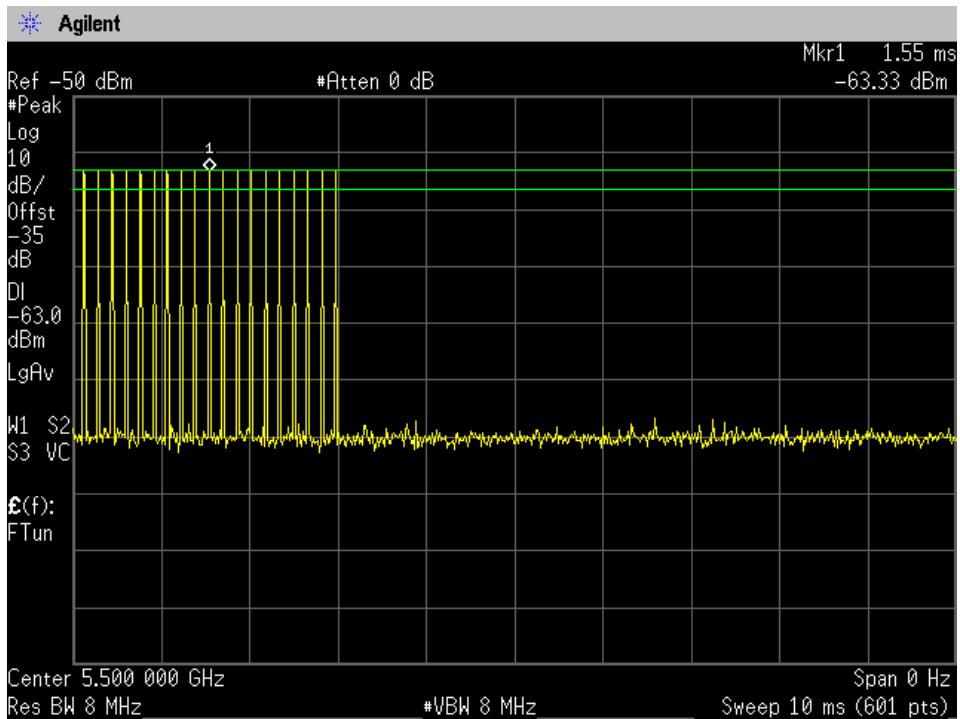

Bin 2 Radar Calibration

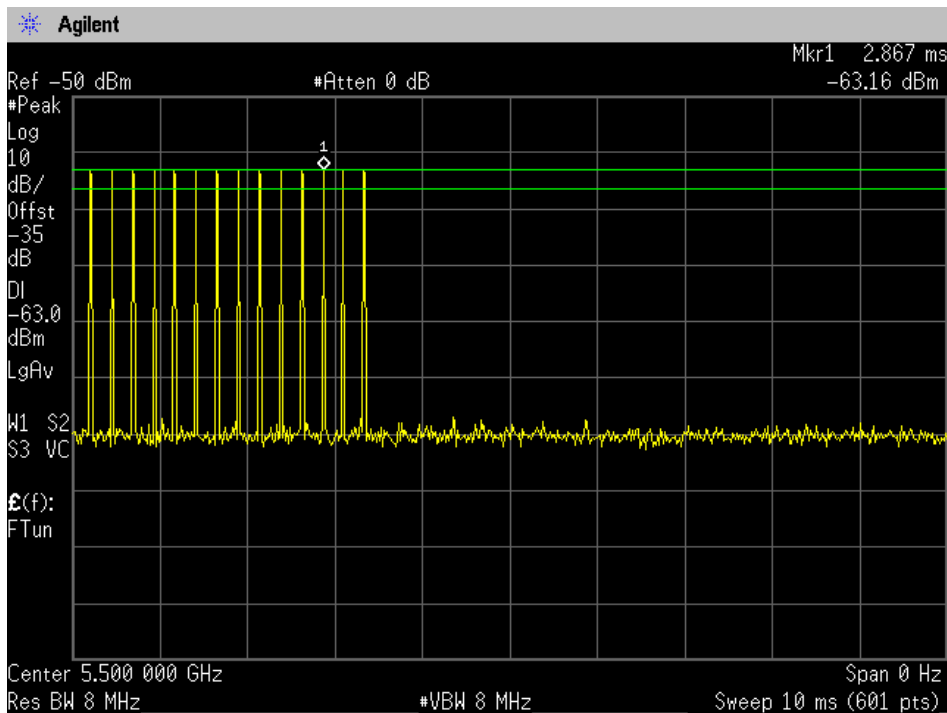

Bin 3 Radar Calibration

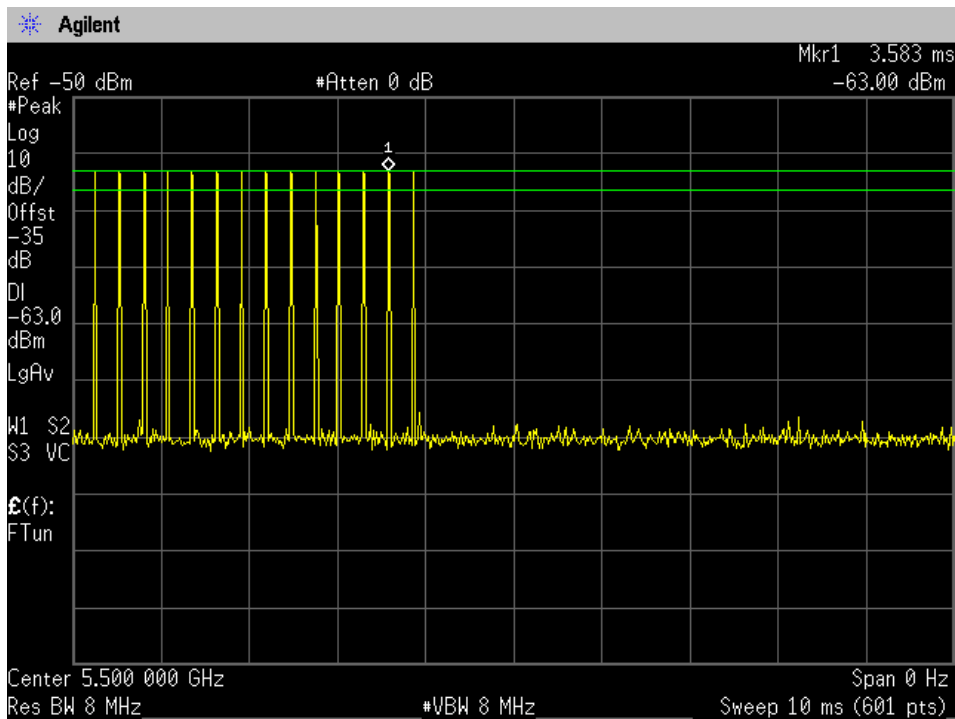

Bin 4 Radar Calibration

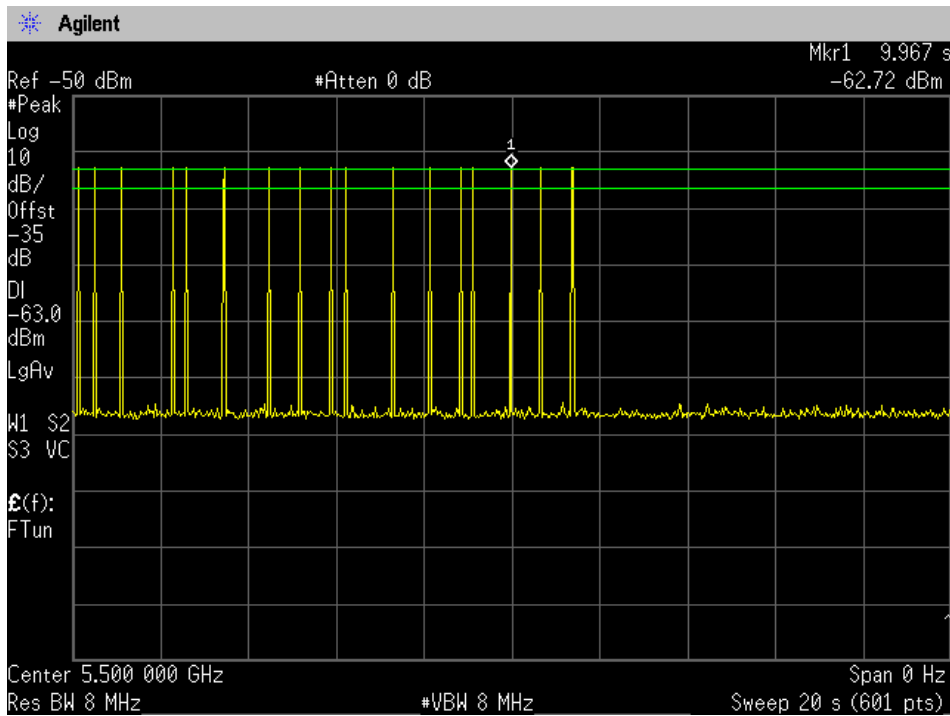

Bin 5 Radar Calibration

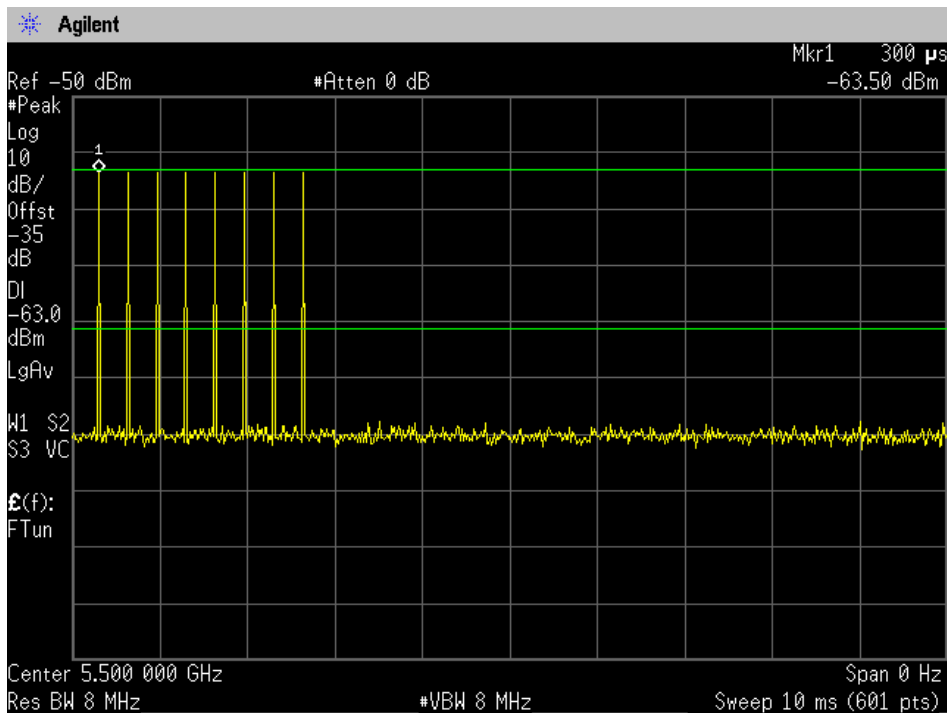

Bin 6 Radar Calibration

5.0 Test Procedure/Results

1. A spectrum analyzer is used as a monitor to verify that the UUT has vacated the Channel within the (Channel Closing Transmission Time and Channel Move Time, and does not transmit on a Channel during the Non-Occupancy Period after the detection and Channel move. It is also used to monitor UUT transmissions during the Channel Availability Check Time.
2. Following is the test setup used to generate the Radar Waveforms, and for all DFS tests described herein.

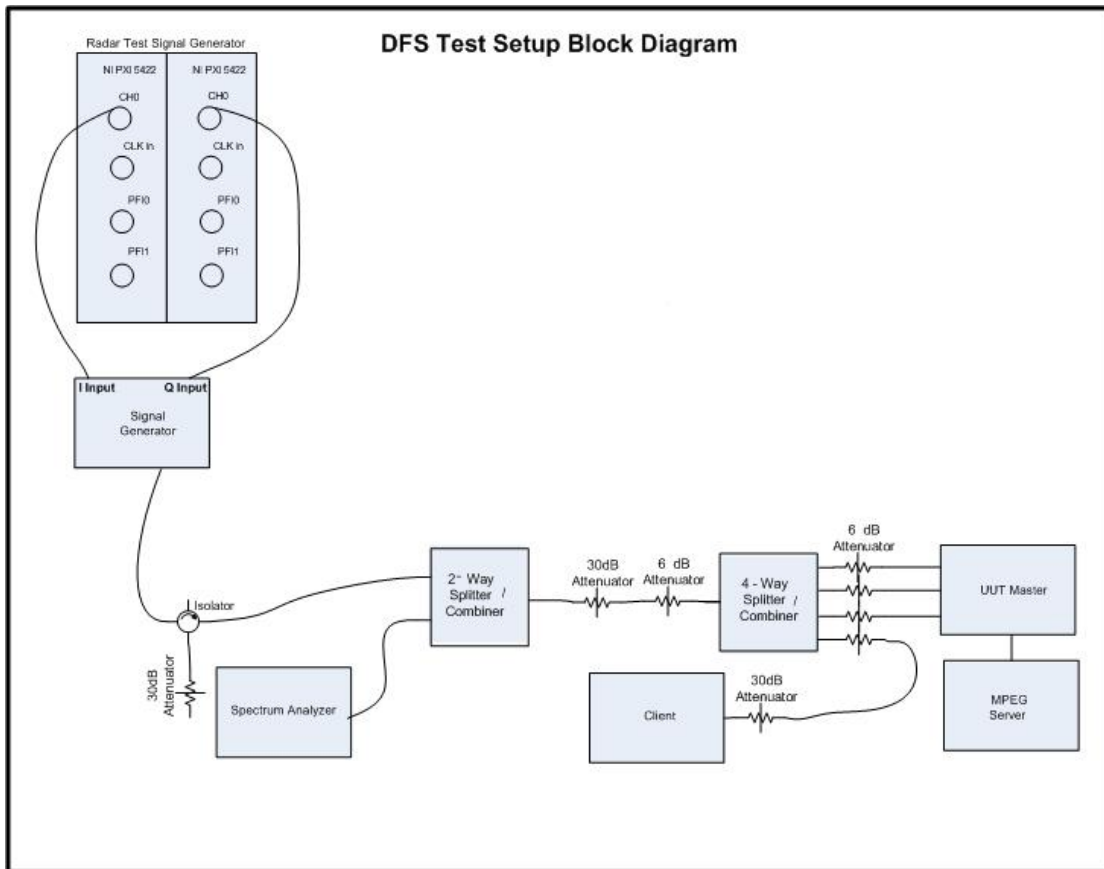

Conducted Setup: Radar Test Waveforms are injected into the Master

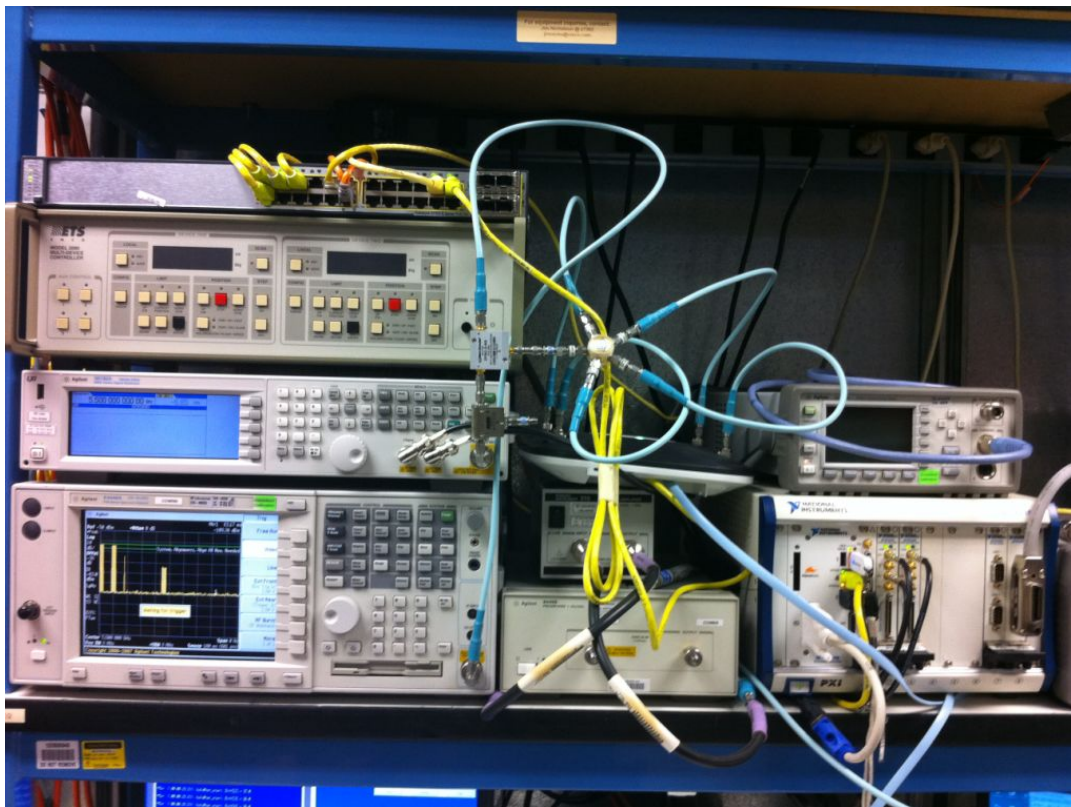

DFS Setup

The test setup is constructed of the following equipment:

Radar Test Signal Generator

National Instruments NI PXI-1042 8-Slot 3U Chassis

National Instruments NI PXI-5422 16-Bit 200MS/s Arbitrary Waveform Generator (Qty. 2)

Agilent N5182A MXG Signal Generator

Agilent E4448A Spectrum Analyzer

Mini-Circuits ZFSC-2-9G Splitter/Combiner (Qty. 1)

Weinschel 1594 4 to 1 power Splitter/Combiner (Qty. 1)

Ditom Microwave D3C-4080-11 Circulator/Isolator (Qty. 1)

Mini-Circuits BW-S30W2 30dB Attenuator (Qty. 4)

Mini-Circuits BW-S6W2 30dB Attenuator (Qty. 5)

Megaphase SF26 S1S1 36" Coaxial Cable (Qty. 2)

MicroCoax 18" Coaxial Cable (Qty. 3)

Dell 600M Laptop (Qty. 2: 1 for wireless client, 1 for MPEG server)

Cisco-Linksys WPC600N 802.11n NIC card (wireless client)

The waveform parameters from within the bounds of the signal type are selected randomly using uniform distribution.



3. **UNII Detection Bandwidth:** All UNII 20 MHz channels for this device have identical Channel bandwidths. All UNII 40 MHz channels for this device also have identical Channel bandwidths. Therefore, all DFS testing was done at 5500 MHz. The 99% channel bandwidth for 20MHz signals is 18 MHz, and the 99% channel bandwidth for 40MHz signals is 36 MHz. (See the 26dB BW section of the RF report for further measurement details).

The generating equipment is configured as shown in the Conducted Test Setup above. A single *Burst* of the desired radar profile is produced at 5500MHz at a -63dBm level. The UUT is set up as a standalone device (no associated Client and no traffic).

A single radar Burst is generated for a minimum of 10 trials, and the response of the UUT is noted. The UUT must detect the Radar Waveform 90% or more of the time.

The radar frequency is increased in 1 MHz steps, repeating the above test sequence, until the detection rate falls below 90%. The highest frequency at which detection is greater than or equal to 90% is denoted as F_H .

The radar frequency is decreased in 1 MHz steps, repeating the above test sequence, until the detection rate falls below 90%. The lowest frequency at which detection is greater than or equal to 90% is denoted as F_L .

The U-NII Detection Bandwidth is calculated as follows:

$$\text{U-NII Detection Bandwidth} = F_H - F_L$$

The U-NII Detection Bandwidth must be at least 80% of the UUT transmitter 99% power bandwidth (14.4 MHz for 20MHz signals, 28.8 MHz for 40 MHz signals), otherwise, the UUT does not comply with DFS requirements.



UNII Detection Bandwidth Results, 20MHz Signal Bandwidth

Radar Frequency	DFS Detection Trials (1=Detection, Blank= No Detection)										Detection Rate (%)	Detection Bandwidth (MHz)
	1	2	3	4	5	6	7	8	9	10		
5490	1	1	1	1	1	1	1	1	1	1	100	20
5491	1	1	1	1	1	1	1	1	1	1	100	
5492	1	1	1	1	1	1	1	1	1	1	100	
5493	1	1	1	1	1	1	1	1	1	1	100	
5494	1	1	1	1	1	1	1	1	1	1	100	
5495	1	1	1	1	1	1	1	1	1	1	100	
5496	1	1	1	1	1	1	1	1	1	1	100	
5497	1	1	1	1	1	1	1	1	1	1	100	
5498	1	1	1	1	1	1	1	1	1	1	100	
5499	1	1	1	1	1	1	1	1	1	1	100	
5500	1	1	1	1	1	1	1	1	1	1	100	
5501	1	1	1	1	1	1	1	1	1	1	100	
5502	1	1	1	1	1	1	1	1	1	1	100	
5503	1	1	1	1	1	1	1	1	1	1	100	
5504	1	1	1	1	1	1	1	1	1	1	100	
5505	1	1	1	1	1	1	1	1	1	1	100	
5506	1	1	1	1	1	1	1	1	1	1	100	
5507	1	1	1	1	1	1	1	1	1	1	100	
5508	1	1	1	1	1	1	1	1	1	1	100	
5509	1	1	1	1	1	1	1	1	1	1	100	
5510	1	1	1	1	1	1	1	1	1	1	100	

Type 1 Radar



Radar Frequency	DFS Detection Trials (1=Detection, Blank= No Detection)										Detection Rate (%)	Detection Bandwidth (MHz)
	1	2	3	4	5	6	7	8	9	10		
5490	1	1	1	1	1	1	1	1	1	1	100	20
5491	1	1	1	1	1	1	1	1	1	1	100	
5492	1	1	1	1	1	1	1	1	1	1	100	
5493	1	1	1	1	1	1	1	1	1	1	100	
5494	1	1	1	1	1	1	1	1	1	1	100	
5495	1	1	1	1	1	1	1	1	1	1	100	
5496	1	1	1	1	1	1	1	1	1	1	100	
5497	1	1	1	1	1	1	1	1	1	1	100	
5498	1	1	1	1	1	1	1	1	1	1	100	
5499	1	1	1	1	1	1	1	1	1	1	100	
5500	1	1	1	1	1	1	1	1	1	1	100	
5501	1	1	1	1	1	1	1	1	1	1	100	
5502	1	1	1	1	1	1	1	1	1	1	100	
5503	1	1	1	1	1	1	1	1	1	1	100	
5504	1	1	1	1	1	1	1	1	1	1	100	
5505	1	1	1	1	1	1	1	1	1	1	100	
5506	1	1	1	1	1	1	1	1	1	1	100	
5507	1	1	1	1	1	1	1	1	1	1	100	
5508	1	1	1	1	1	1	1	1	1	1	100	
5509	1	1	1	1	1	1	1	1	1	1	100	
5510	1	1	1	1	1	1	1	1	1	1	100	

Type 2 Radar



Radar Frequency	DFS Detection Trials (1=Detection, Blank= No Detection)										Detection Rate (%)	Detection Bandwidth (MHz)
	1	2	3	4	5	6	7	8	9	10		
5490	1	1	1	1	1	1	1	1	1	1	100	20
5491	1	1	1	1	1	1	1	1	1	1	100	
5492	1	1	1	1	1	1	1	1	1	1	100	
5493	1	1	1	1	1	1	1	1	1	1	100	
5494	1	1	1	1	1	1	1	1	1	1	100	
5495	1	1	1	1	1	1	1	1	1	1	100	
5496	1	1	1	1	1	1	1	1	1	1	100	
5497	1	1	1	1	1	1	1	1	1	1	100	
5498	1	1	1	1	1	1	1	1	1	1	100	
5499	1	1	1	1	1	1	1	1	1	1	100	
5500	1	1	1	1	1	1	1	1	1	1	100	
5501	1	1	1	1	1	1	1	1	1	1	100	
5502	1	1	1	1	1	1	1	1	1	1	100	
5503	1	1	1	1	1	1	1	1	1	1	100	
5504	1	1	1	1	1	1	1	1	1	1	100	
5505	1	1	1	1	1	1	1	1	1	1	100	
5506	1	1	1	1	1	1	1	1	1	1	100	
5507	1	1	1	1	1	1	1	1	1	1	100	
5508	1	1	1	1	1	1	1	1	1	1	100	
5509	1	1	1	1	1	1	1	1	1	1	100	
5510	1	1	1	1	1	1	1	1	1	1	100	

Type 3 Radar



Radar Frequency	DFS Detection Trials (1=Detection, Blank= No Detection)										Detection Rate (%)	Detection Bandwidth (MHz)
	1	2	3	4	5	6	7	8	9	10		
5490	1	0	0	0	0	0	0	0	0	0	10	18
5491	1	1	1	1	1	1	1	1	1	1	100	
5492	1	1	1	1	1	1	1	1	1	1	100	
5493	1	1	1	1	1	1	1	1	1	1	100	
5494	1	1	1	1	1	1	1	1	1	1	100	
5495	1	1	1	1	1	1	1	1	1	1	100	
5496	1	1	1	1	1	1	1	1	1	1	100	
5497	1	1	1	1	1	1	1	1	1	1	100	
5498	1	1	1	1	1	1	1	1	1	1	100	
5499	1	1	1	1	1	1	1	1	1	1	100	
5500	1	1	1	1	1	1	1	1	1	1	100	
5501	1	1	1	1	1	1	1	1	1	1	100	
5502	1	1	1	1	1	1	1	1	1	1	100	
5503	1	1	1	1	1	1	1	1	1	1	100	
5504	1	1	1	1	1	1	1	1	1	1	100	
5505	1	1	1	1	1	1	1	1	1	1	100	
5506	1	1	1	1	1	1	1	1	1	1	100	
5507	1	1	1	1	1	1	1	1	1	1	100	
5508	1	1	1	1	1	1	1	1	1	1	100	
5509	1	1	1	1	1	1	1	1	1	1	100	
5510	1	0	0	0	1	1	0	0	1	0	40	

Type 4 Radar



Radar Frequency	DFS Detection Trials (1=Detection, Blank= No Detection)										Detection Rate (%)	Detection Bandwidth (MHz)
	1	2	3	4	5	6	7	8	9	10		
5490	1	1	1	1	1	1	1	1	1	1	100	20
5491	1	1	1	1	1	1	1	1	1	1	100	
5492	1	1	1	1	1	1	1	1	1	1	100	
5493	1	1	1	1	1	1	1	1	1	1	100	
5494	1	1	1	1	1	1	1	1	1	1	100	
5495	1	1	1	1	1	1	1	1	1	1	100	
5496	1	1	1	1	1	1	1	1	1	1	100	
5497	1	1	1	1	1	1	1	1	1	1	100	
5498	1	1	1	1	1	1	1	1	1	1	100	
5499	1	1	1	1	1	1	1	1	1	1	100	
5500	1	1	1	1	1	1	1	1	1	1	100	
5501	1	1	1	1	1	1	1	1	1	1	100	
5502	1	1	1	1	1	1	1	1	1	1	100	
5503	1	1	1	1	1	1	1	1	1	1	100	
5504	1	1	1	1	1	1	1	1	1	1	100	
5505	1	1	1	1	1	1	1	1	1	1	100	
5506	1	1	1	1	1	1	1	1	1	1	100	
5507	1	1	1	1	1	1	1	1	1	1	100	
5508	1	1	1	1	1	1	1	1	1	1	100	
5509	1	1	1	1	1	1	1	1	1	1	100	
5510	1	1	1	1	1	1	1	1	1	1	100	

Type 5 Radar



Radar Frequency	DFS Detection Trials (1=Detection, Blank= No Detection)										Detection Rate (%)	Detection Bandwidth (MHz)
	1	2	3	4	5	6	7	8	9	10		
5490	1	0	0	0	0	0	0	0	0	0	10	19
5491	1	1	1	1	1	1	1	1	1	1	100	
5492	1	1	1	1	1	1	1	1	1	1	100	
5493	1	1	1	1	1	1	1	1	1	1	100	
5494	1	1	1	1	1	1	1	1	1	1	100	
5495	1	1	1	1	1	1	1	1	1	1	100	
5496	1	1	1	1	1	1	1	1	1	1	100	
5497	1	1	1	1	1	1	1	1	1	1	100	
5498	1	1	1	1	1	1	1	1	1	1	100	
5499	1	1	1	1	1	1	1	1	1	1	100	
5500	1	1	1	1	1	1	1	1	1	1	100	
5501	1	1	1	1	1	1	1	1	1	1	100	
5502	1	1	1	1	1	1	1	1	1	1	100	
5503	1	1	1	1	1	1	1	1	1	1	100	
5504	1	1	1	1	1	1	1	1	1	1	100	
5505	1	1	1	0	1	1	1	1	1	1	90	
5506	1	1	1	1	1	0	1	1	1	1	90	
5507	1	1	1	1	1	1	1	1	1	1	100	
5508	1	1	1	1	1	1	1	1	1	1	100	
5509	1	1	1	1	1	1	1	1	1	1	100	
5510	1	1	1	1	1	1	1	1	1	1	100	

Type 6 Radar



UNII Detection Bandwidth Results, 40 MHz Signal Bandwidth

Radar Frequency (MHz)	DFS Detection Trials (1=Detection, Blank= No Detection)										Detection Rate (%)	Detection Bandwidth (MHz)
	1	2	3	4	5	6	7	8	9	10		
5492	1	0	0	0	0	0	0	0	0	0	10	
5493	1	0	0	0	0	0	0	0	0	0	10	
5494	1	1	1	1	1	1	1	1	1	1	100	
5495	1	1	1	1	1	1	1	1	1	1	100	
5496	1	1	1	1	1	1	1	1	1	1	100	
5497	1	1	1	1	1	1	1	1	1	1	100	
5498	1	1	1	1	1	1	1	1	1	1	100	
5499	1	1	1	1	1	1	1	1	1	1	100	
5500	1	1	1	1	1	1	1	1	1	1	100	
5501	1	1	1	1	1	1	1	1	1	1	100	
5502	1	1	1	1	1	1	1	1	1	1	100	
5503	1	1	1	1	1	1	1	1	1	1	100	
5504	1	1	1	1	1	1	1	1	1	1	100	
5505	1	1	1	1	1	1	1	1	1	1	100	
5506	1	1	1	1	1	1	1	1	1	1	100	
5507	1	1	1	1	1	1	1	1	1	1	100	
5508	1	1	1	1	1	1	1	1	1	1	100	
5509	1	1	1	1	1	1	1	1	1	1	100	
5510	1	1	1	1	1	1	1	1	1	1	100	
5511	1	1	1	1	1	1	1	1	1	1	100	
5512	1	1	1	1	1	1	1	1	1	1	100	
5513	1	1	1	1	1	1	1	1	1	1	100	
5514	1	1	1	1	1	1	1	1	1	1	100	
5515	1	1	1	1	1	1	1	1	1	1	100	
5516	1	1	1	1	1	1	1	1	1	1	100	
5517	1	1	1	1	1	1	1	1	1	1	100	
5518	1	1	1	1	1	1	1	1	1	1	100	
5519	1	1	1	1	1	1	1	1	1	1	100	
5520	1	1	1	1	1	1	1	1	1	1	100	
5521	1	1	1	1	1	1	1	1	1	1	100	
5522	1	1	1	1	1	1	1	1	1	1	100	
5523	1	1	1	1	1	1	1	1	1	1	100	
5524	1	1	1	1	1	1	1	1	1	1	100	
5525	1	1	1	1	1	1	1	1	1	1	100	
5526	1	1	1	1	1	1	1	1	1	1	100	
5527	1	0	0	0	0	0	0	0	0	0	10	
5528	1	0	0	0	0	0	0	0	0	0	10	

32

Type 1 Radar



Radar Frequency (MHz)	DFS Detection Trials (1=Detection, Blank= No Detection)										Detection Rate (%)	Detection Bandwidth (MHz)
	1	2	3	4	5	6	7	8	9	10		
5492	1	0	0	0	0	0	0	0	0	0	10	
5493	1	0	0	0	0	0	0	0	0	0	10	
5494	1	1	1	1	1	1	1	1	1	1	100	32
5495	1	1	1	1	1	1	1	1	1	1	100	
5496	1	1	1	1	1	1	1	1	1	1	100	
5497	1	1	1	1	1	1	1	1	1	1	100	
5498	1	1	1	1	1	1	1	1	1	1	100	
5499	1	1	1	1	1	1	1	1	1	1	100	
5500	1	1	1	1	1	1	1	1	1	1	100	
5501	1	1	1	1	1	1	1	1	1	1	100	
5502	1	1	1	1	1	1	1	1	1	1	100	
5503	1	1	1	1	1	1	1	1	1	1	100	
5504	1	1	1	1	1	1	1	1	1	1	100	
5505	1	1	1	1	1	1	1	1	1	1	100	
5506	1	1	1	1	1	1	1	1	1	1	100	
5507	1	1	1	1	1	1	1	1	1	1	100	
5508	1	1	1	1	1	1	1	1	1	1	100	
5509	1	1	1	1	1	1	1	1	1	1	100	
5510	1	1	1	1	1	1	1	1	1	1	100	
5511	1	1	1	1	1	1	1	1	1	1	100	
5512	1	1	1	1	1	1	1	1	1	1	100	
5513	1	1	1	1	1	1	1	1	1	1	100	
5514	1	1	1	1	1	1	1	1	1	1	100	
5515	1	1	1	1	1	1	1	1	1	1	100	
5516	1	1	1	1	1	1	1	1	1	1	100	
5517	1	1	1	1	1	1	1	1	1	1	100	
5518	1	1	1	1	1	1	1	1	1	1	100	
5519	1	1	1	1	1	1	1	1	1	1	100	
5520	1	1	1	1	1	1	1	1	1	1	100	
5521	1	1	1	1	1	1	1	1	1	1	100	
5522	1	1	1	1	1	1	1	1	1	1	100	
5523	1	1	1	1	1	1	1	1	1	1	100	
5524	1	1	1	1	1	1	1	1	1	1	100	
5525	1	1	1	1	1	1	1	1	1	1	100	
5526	1	1	1	1	1	1	1	1	1	1	100	
5527	1	0	0	0	0	0	0	0	0	0	10	
5528	1	0	0	0	0	0	0	0	0	0	10	

Type 2 Radar



Radars Frequency (MHz)	1	2	3	4	5	6	7	8	9	10	Detection Rate (%)	Detection Bandwidth (MHz)
5492	1	0	0	0	0	0	0	0	0	0	10	
5493	1	0	0	0	0	0	0	0	0	0	10	
5494	1	1	1	1	1	1	1	1	1	1	100	32
5495	1	1	1	1	1	1	1	1	1	1	100	
5496	1	1	1	1	1	1	1	1	1	1	100	
5497	1	1	1	1	1	1	1	1	1	1	100	
5498	1	1	1	1	1	1	1	1	1	1	100	
5499	1	1	1	1	1	1	1	1	1	1	100	
5500	1	1	1	1	1	1	1	1	1	1	100	
5501	1	1	1	1	1	1	1	1	1	1	100	
5502	1	1	1	1	1	1	1	1	1	1	100	
5503	1	1	1	1	1	1	1	1	1	1	100	
5504	1	1	1	1	1	1	1	1	1	1	100	
5505	1	1	1	1	1	1	1	1	1	1	100	
5506	1	1	1	1	1	1	1	1	1	1	100	
5507	1	1	1	1	1	1	1	1	1	1	100	
5508	1	1	1	1	1	1	1	1	1	1	100	
5509	1	1	1	1	1	1	1	1	1	1	100	
5510	1	1	1	1	1	1	1	1	1	1	100	
5511	1	1	1	1	1	1	1	1	1	1	100	
5512	1	1	1	1	1	1	1	1	1	1	100	
5513	1	1	1	1	1	1	1	1	1	1	100	
5514	1	1	1	1	1	1	1	1	1	1	100	
5515	1	1	1	1	1	1	1	1	1	1	100	
5516	1	1	1	1	1	1	1	1	1	1	100	
5517	1	1	1	1	1	1	1	1	1	1	100	
5518	1	1	1	1	1	1	1	1	1	1	100	
5519	1	1	1	1	1	1	1	1	1	1	100	
5520	1	1	1	1	1	1	1	1	1	1	100	
5521	1	1	1	1	1	1	1	1	1	1	100	
5522	1	1	1	1	1	1	1	1	1	1	100	
5523	1	1	1	1	1	1	1	1	1	1	100	
5524	1	1	1	1	1	1	1	1	1	1	100	
5525	1	1	1	1	1	1	1	1	1	1	100	
5526	1	1	1	1	1	1	1	1	1	1	100	
5527	1	0	0	0	0	0	0	0	0	0	10	
5528	1	0	0	0	0	0	0	0	0	0	10	

Type 3 Radar



Radar Frequency (MHz)	DFS Detection Trials (1=Detection, Blank= No Detection)										Detection Rate (%)	Detection Bandwidth (MHz)
	1	2	3	4	5	6	7	8	9	10		
5490	1	0	0	0	0	0	0	0	0	0	10	
5491	1	0	0	0	0	0	0	0	0	0	10	
5492	1	0	0	0	0	0	0	0	0	0	10	
5493	1	0	0	0	0	0	0	0	0	0	10	
5494	1	1	1	1	1	1	1	1	1	1	100	32
5495	1	1	1	1	1	1	1	1	1	1	100	
5496	1	1	1	1	1	1	1	1	1	1	100	
5497	1	1	1	1	1	1	1	1	1	1	100	
5498	1	1	1	1	1	1	1	1	1	1	100	
5499	1	1	1	1	1	1	1	1	1	1	100	
5500	1	1	1	1	1	1	1	1	1	1	100	
5501	1	1	1	1	1	1	1	1	1	1	100	
5502	1	1	1	1	1	1	1	1	1	1	100	
5503	1	1	1	1	1	1	1	1	1	1	100	
5504	1	1	1	1	1	1	1	1	1	1	100	
5505	1	1	1	1	1	1	1	1	1	1	100	
5506	1	1	1	1	1	1	1	1	1	1	100	
5507	1	1	1	1	1	1	1	1	1	1	100	
5508	1	1	1	1	1	1	1	1	1	1	100	
5509	1	1	1	1	1	1	1	1	1	1	100	
5510	1	1	1	1	1	1	1	1	1	1	100	
5511	1	1	1	1	1	1	1	1	1	1	100	
5512	1	1	1	1	1	1	1	1	1	1	100	
5513	1	1	1	1	1	1	1	1	1	1	100	
5514	1	1	1	1	1	1	1	1	1	1	100	
5515	1	1	1	1	1	1	1	1	1	1	100	
5516	1	1	1	1	1	1	1	1	1	1	100	
5517	1	1	1	1	1	1	1	1	1	1	100	
5518	1	1	1	1	1	1	1	1	1	1	100	
5519	1	1	1	1	1	1	1	1	1	1	100	
5520	1	1	1	1	1	1	1	1	1	1	100	
5521	1	1	1	1	1	1	1	1	1	1	100	
5522	1	1	1	1	1	1	1	1	1	1	100	
5523	1	1	1	1	1	1	1	1	1	1	100	
5524	1	1	1	1	1	1	1	1	1	1	100	
5525	1	1	1	1	1	1	1	1	1	1	100	
5526	1	1	1	1	1	1	1	1	1	1	100	
5527	1	1	0	0	1	0	1	0	0	0	40	
5528	1	0	1	1	1	0	0	1	1	0	60	

Type 4 Radar



Radar Frequency (MHz)	DFS Detection Trials (1=Detection, Blank= No Detection)										Detection Rate (%)	Detection Bandwidth (MHz)
	1	2	3	4	5	6	7	8	9	10		
5492	1	0	0	0	0	0	0	0	0	0	10	
5493	1	0	0	0	0	0	0	0	0	0	10	
5494	1	1	1	1	1	1	1	1	1	1	100	36
5495	1	1	1	1	1	1	1	1	1	1	100	
5496	1	1	1	1	1	1	1	1	1	1	100	
5497	1	1	1	1	1	1	1	1	1	1	100	
5498	1	1	1	1	1	1	1	1	1	1	100	
5499	1	1	1	1	1	1	1	1	1	1	100	
5500	1	1	1	1	1	1	1	1	1	1	100	
5501	1	1	1	1	1	1	1	1	1	1	100	
5502	1	1	1	1	1	1	1	1	1	1	100	
5503	1	1	1	1	1	1	1	1	1	1	100	
5504	1	1	1	1	1	1	1	1	1	1	100	
5505	1	1	1	1	1	1	1	1	1	1	100	
5506	1	1	1	1	1	1	1	1	1	1	100	
5507	1	1	1	1	1	1	1	1	1	1	100	
5508	1	1	1	1	1	1	1	1	1	1	100	
5509	1	1	1	1	1	1	1	1	1	1	100	
5510	1	1	1	1	1	1	1	1	1	1	100	
5511	1	1	1	1	1	1	1	1	1	1	100	
5512	1	1	1	1	1	1	1	1	1	1	100	
5513	1	1	1	1	1	1	1	1	1	1	100	
5514	1	1	1	1	1	1	1	1	1	1	100	
5515	1	1	1	1	1	1	1	1	1	1	100	
5516	1	1	1	1	1	1	1	1	1	1	100	
5517	1	1	1	1	1	1	1	1	1	1	100	
5518	1	1	1	1	1	1	1	1	1	1	100	
5519	1	1	1	1	1	1	1	1	1	1	100	
5520	1	1	1	1	1	1	1	1	1	1	100	
5521	1	1	1	1	1	1	1	1	1	1	100	
5522	1	1	1	1	1	1	1	1	1	1	100	
5523	1	1	1	1	1	1	1	1	1	1	100	
5524	1	1	1	1	1	1	1	1	1	1	100	
5525	1	1	1	1	1	1	1	1	1	1	100	
5526	1	1	1	1	1	1	1	1	1	1	100	
5527	1	1	1	1	1	1	1	1	1	1	100	
5528	1	1	1	1	1	1	1	1	1	1	100	
5529	1	1	1	1	1	1	1	1	1	1	100	
5530	1	0	1	1	1	1	1	1	1	1	90	

Type 5 Radar



Radars Frequency (MHz)	1	2	3	4	5	6	7	8	9	10	Detection Rate (%)	Detection Bandwidth (MHz)
5492	1	0	0	0	0	0	0	0	0	0	10	
5493	1	0	0	0	0	0	0	0	0	0	10	
5494	1	1	1	1	1	1	1	1	1	1	100	36
5495	1	1	1	1	1	1	1	1	1	1	100	
5496	1	1	1	1	1	1	1	1	1	1	100	
5497	1	1	1	1	1	1	1	1	1	1	100	
5498	1	1	1	1	1	1	1	1	1	1	100	
5499	1	1	1	1	1	1	1	1	1	1	100	
5500	1	1	1	1	1	1	1	1	1	1	100	
5501	1	1	1	1	1	1	1	1	1	1	100	
5502	1	1	1	1	1	1	1	1	1	1	100	
5503	1	1	1	1	1	1	1	1	1	1	100	
5504	1	1	1	1	1	1	1	1	1	1	100	
5505	1	1	1	1	1	1	1	1	1	1	100	
5506	1	1	1	1	1	1	1	1	1	1	100	
5507	1	1	1	1	1	1	1	1	1	1	100	
5508	1	1	1	1	1	1	1	1	1	1	100	
5509	1	1	1	1	1	1	1	1	1	1	100	
5510	1	1	1	1	1	1	1	1	1	1	100	
5511	1	1	1	1	1	1	1	1	1	1	100	
5512	1	1	1	1	1	1	1	1	1	1	100	
5513	1	1	1	1	1	1	1	1	1	1	100	
5514	1	1	1	1	1	1	1	1	1	1	100	
5515	1	1	1	1	1	1	1	1	1	1	100	
5516	1	1	1	1	1	1	1	1	1	1	100	
5517	1	1	1	1	1	1	1	1	1	1	100	
5518	1	1	1	1	1	1	1	1	1	1	100	
5519	1	1	1	1	1	1	1	1	1	1	100	
5520	1	1	1	1	1	1	1	1	1	1	100	
5521	1	1	1	1	1	1	1	1	1	1	100	
5522	1	1	1	1	1	1	1	1	1	1	100	
5523	1	1	1	1	1	1	1	1	1	1	100	
5524	1	1	1	1	1	1	1	1	1	1	100	
5525	1	1	1	0	1	1	1	1	1	1	90	
5526	1	1	1	1	1	1	1	1	1	1	100	
5527	1	1	1	1	1	1	1	1	0	1	90	
5528	1	1	1	1	1	1	1	1	1	1	100	
5529	1	1	1	1	1	1	1	1	1	1	100	
5530	1	1	1	1	1	1	1	1	1	1	100	

Type 6 Radar



- The **Initial Channel Availability Check Time** tests that the UUT does not emit beacon, control, or data signals on the test Channel until the power-up sequence has been completed and the U-NII device checks for Radar Waveforms for one minute on the test Channel. This test does not use any Radar Waveforms.

The U-NII device is powered on and instructed to operate at 5500 MHz. At the same time the UUT is powered on, the spectrum analyzer is set to zero span mode with a 3 MHz resolution bandwidth at 5500MHz with a 2.5 minute sweep time. The analyzer's sweep will be started the same time power is applied to the U-NII device.

The UUT should not transmit any beacon or data transmissions until at least 1 minute after the completion of the power-on cycle.

The initial power up time of the UUT is indicated by marker 1 in the plot. Initial beacons/data transmissions are indicated by marker 1R.

Initial Channel Availability Check Time

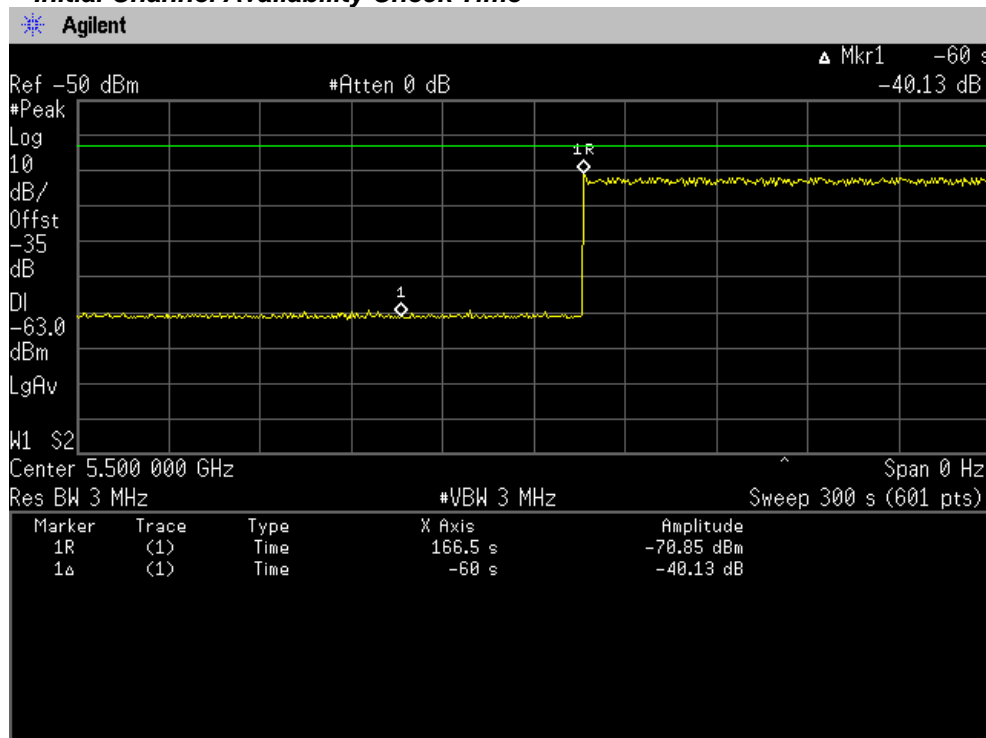



- Radar Burst at the Beginning of the Channel Availability Check Time:** The steps below define the procedure to verify successful radar detection on the selected Channel during a period equal to the Channel Availability Check Time and avoidance of operation on that Channel when a radar Burst with a level equal to the DFS Detection Threshold + 1 dB (-63dBm) occurs at the beginning of the Channel Availability Check Time.

The UUT is powered on at T_0 . T_1 denotes the instant when the UUT has completed its power-up sequence. The Channel Availability Check Time commences at instant T_1 and will end no sooner than $T_1 + 60$ seconds.

A single Burst of short pulse of radar type 1 at -63 dBm will commence within a 6 second window starting at T_1 .

Visual indication on the UUT of successful detection of the radar Burst will be recorded and reported. Observation of emissions at 5500MHz will continue for 2.5 minutes after the radar Burst has been generated.

Verify that during the 2.5 minute measurement window no UUT transmissions occurred at 5500MHz.

Radar Burst at the Beginning of the Channel Availability Check Time

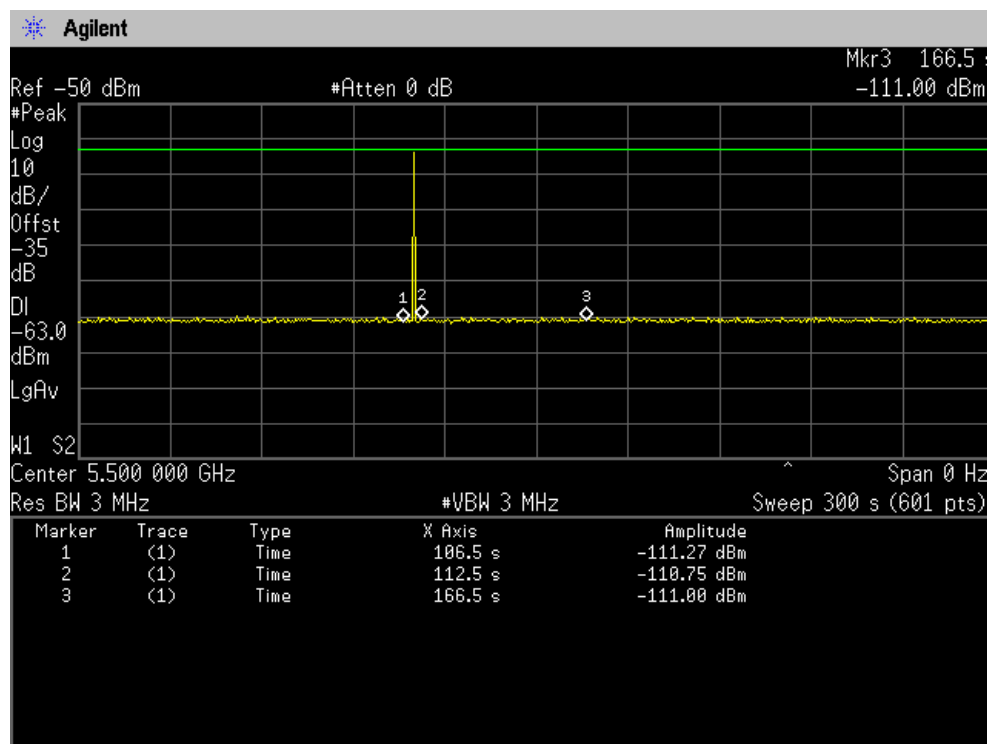



6. **Radar Burst at the End of the Channel Availability Check Time:** The steps below define the procedure to verify successful radar detection on the selected Channel during a period equal to the Channel Availability Check Time and avoidance of operation on that Channel when a radar Burst with a level equal to the DFS Detection Threshold + 1 dB (-63dBm) occurs at the end of the Channel Availability Check Time.

The UUT is powered on at T_0 . T_1 denotes the instant when the UUT has completed its power-up sequence. The Channel Availability Check Time commences at instant T_1 and will end no sooner than $T_1 + 60$ seconds.

A single Burst of short pulse of radar type 1 at -63 dBm will commence within a 6 second window starting at $T_1 + 54$ seconds.

Visual indication on the UUT of successful detection of the radar Burst will be recorded and reported. Observation of emissions at 5500MHz will continue for 2.5 minutes after the radar Burst has been generated.

Verify that during the 2.5 minute measurement window no UUT transmissions occurred at 5500MHz.

Radar Burst at the End of the Channel Availability Check Time

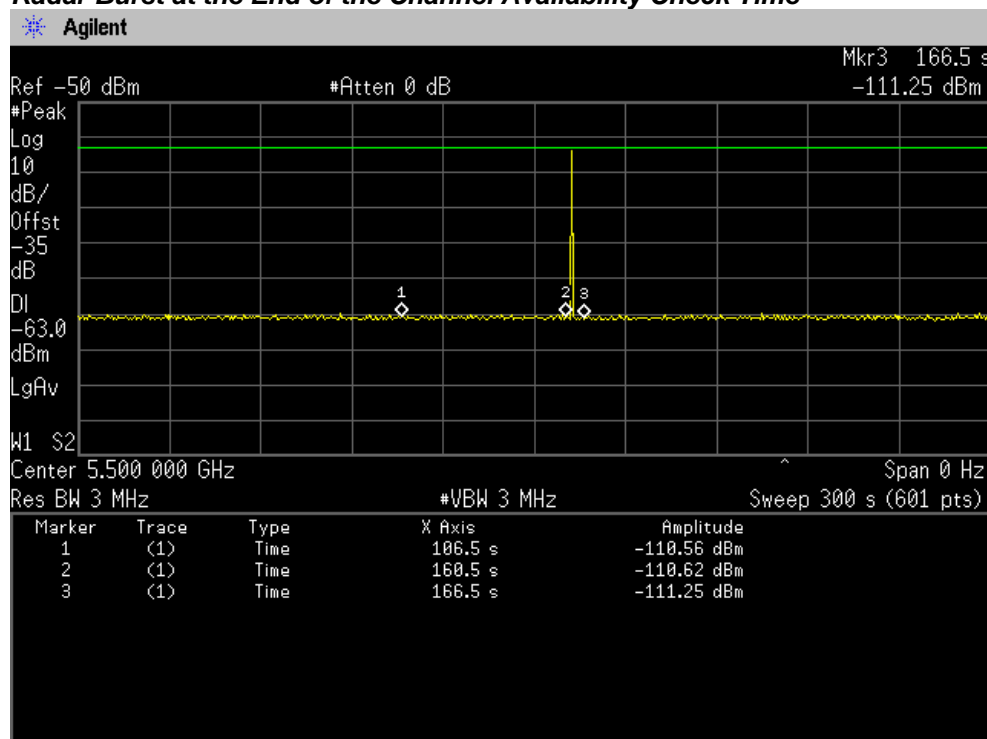



6. In-Service Monitoring for Channel Move Time, Channel Closing Transmission Time and Non-Occupancy Period

These tests define how the following DFS parameters are verified during In-Service Monitoring; Channel Closing Transmission Time, Channel Move Time, and Non-Occupancy Period.

The steps below define the procedure to determine the above mentioned parameters when a radar Burst with a level equal to the DFS Detection Threshold + 1dB (-63dBm) is generated on the Operating Channel of the U-NII device.

A U-NII device operating as a Client Device will associate with the UUT (Master) at 5500 MHz. Stream the MPEG test file from the Master Device to the Client Device on the selected Channel for the entire period of the test.

At time T_0 the Radar Waveform generator sends a Burst of pulses for each of the radar types at -63dBm.

Observe the transmissions of the UUT at the end of the radar Burst on the Operating Channel for duration greater than 10 seconds. Measure and record the transmissions from the UUT during the observation time (Channel Move Time). Compare the Channel Move Time and Channel Closing Transmission Time results to the limits defined in the *DFS Response requirement values table*.

The following plot demonstrates a channel close time of 50ms, with an aggregate of no more than 60 ms. Type 1 radar was used for this data.

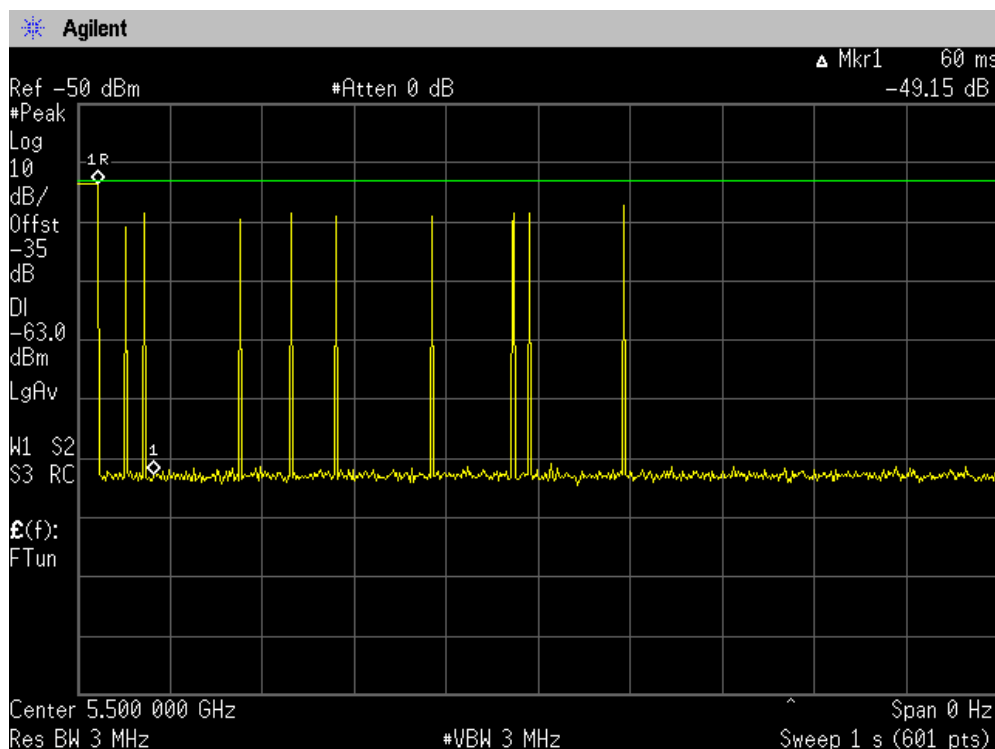



Channel Move Time, Channel Closing Transmission Time for Type 1 radar.

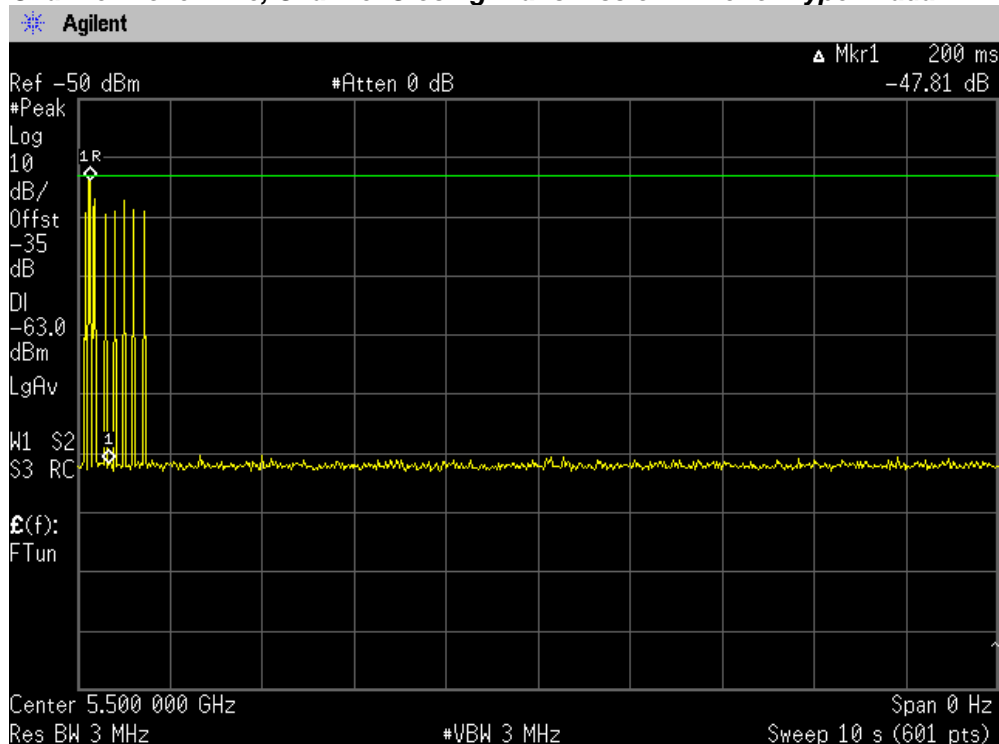

Channel Move Time, Channel Closing Transmission Time for Type 2 radar

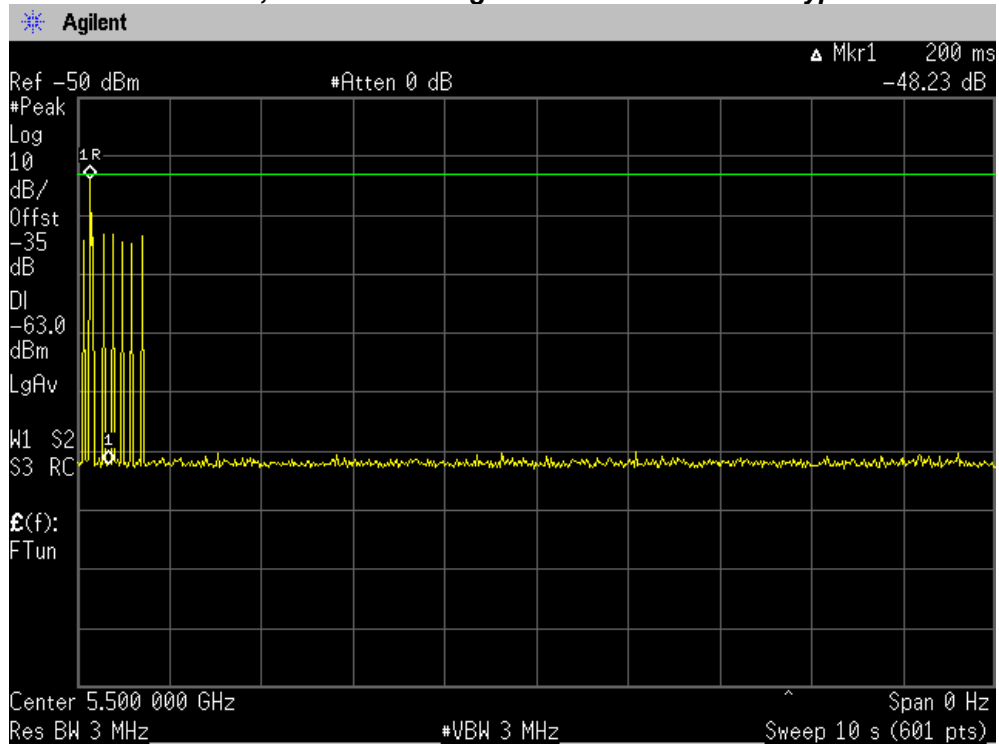



Channel Move Time, Channel Closing Transmission Time for Type 3 radar.

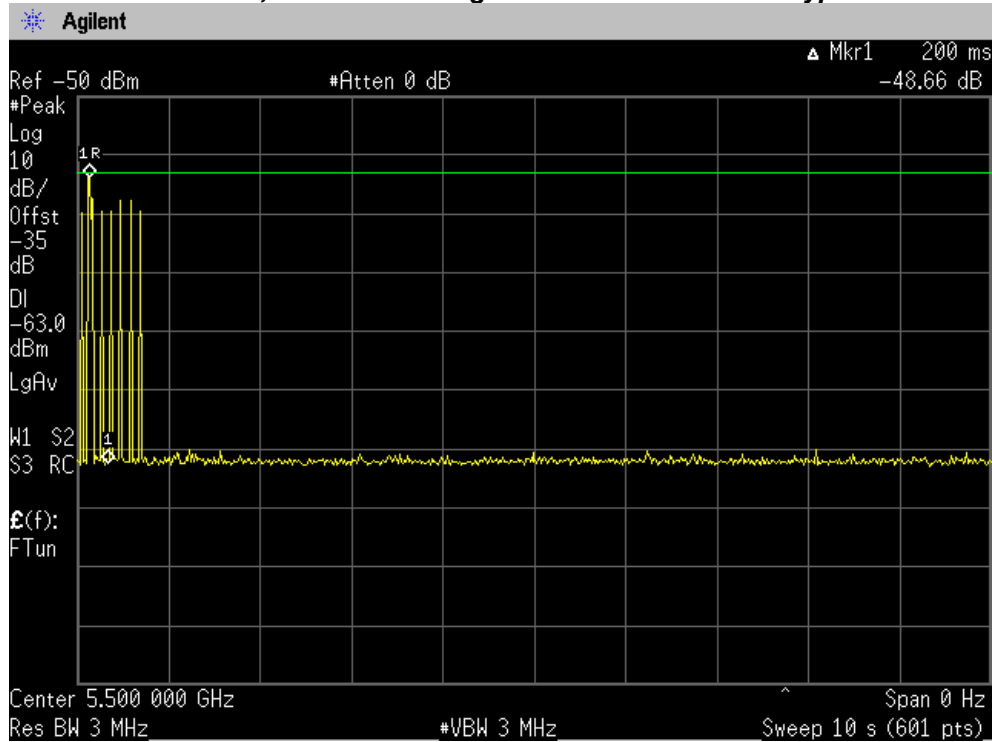

Channel Move Time, Channel Closing Transmission Time for Type 4 radar.

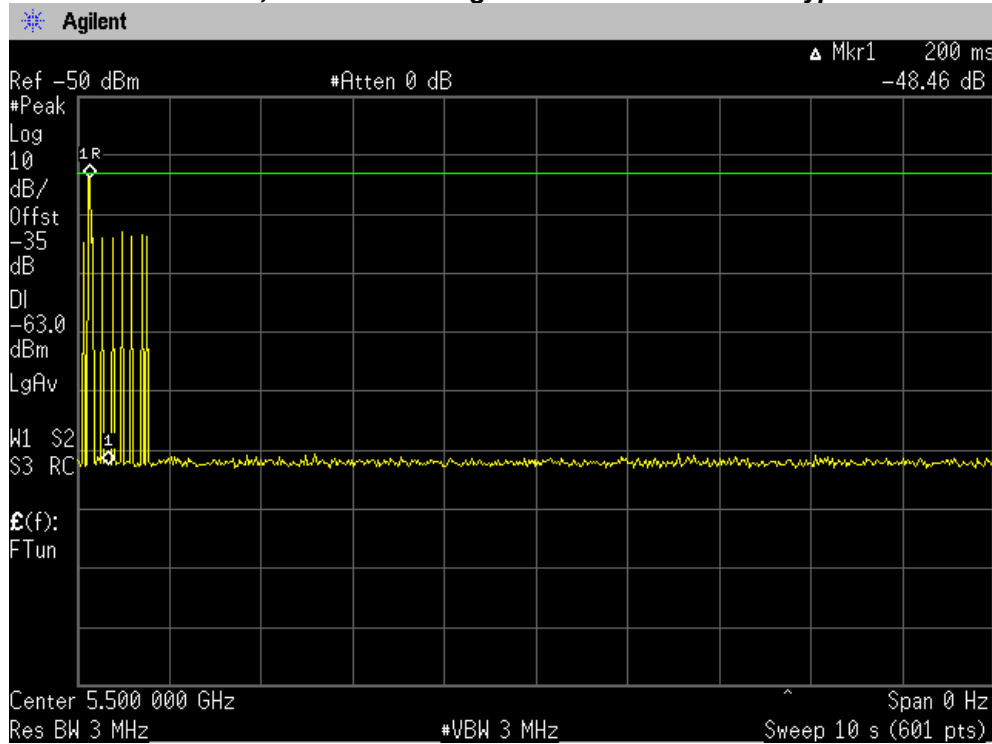



Channel Move Time, Channel Closing Transmission Time for Type 5 radar.

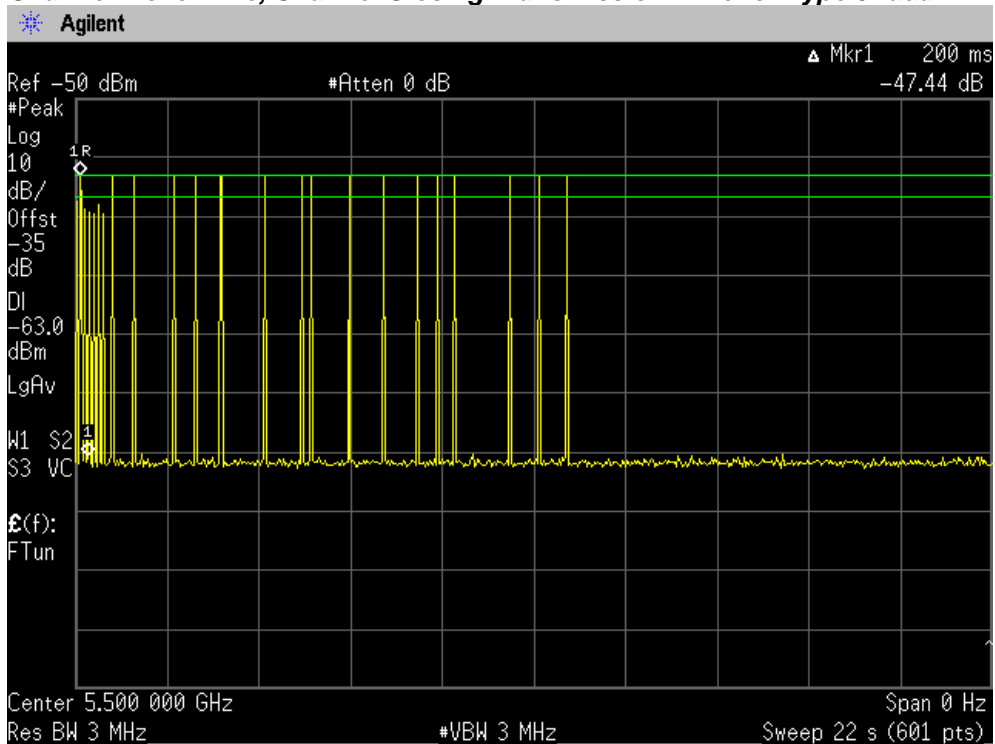

Channel Move Time, Channel Closing Transmission Time for Type 6 radar

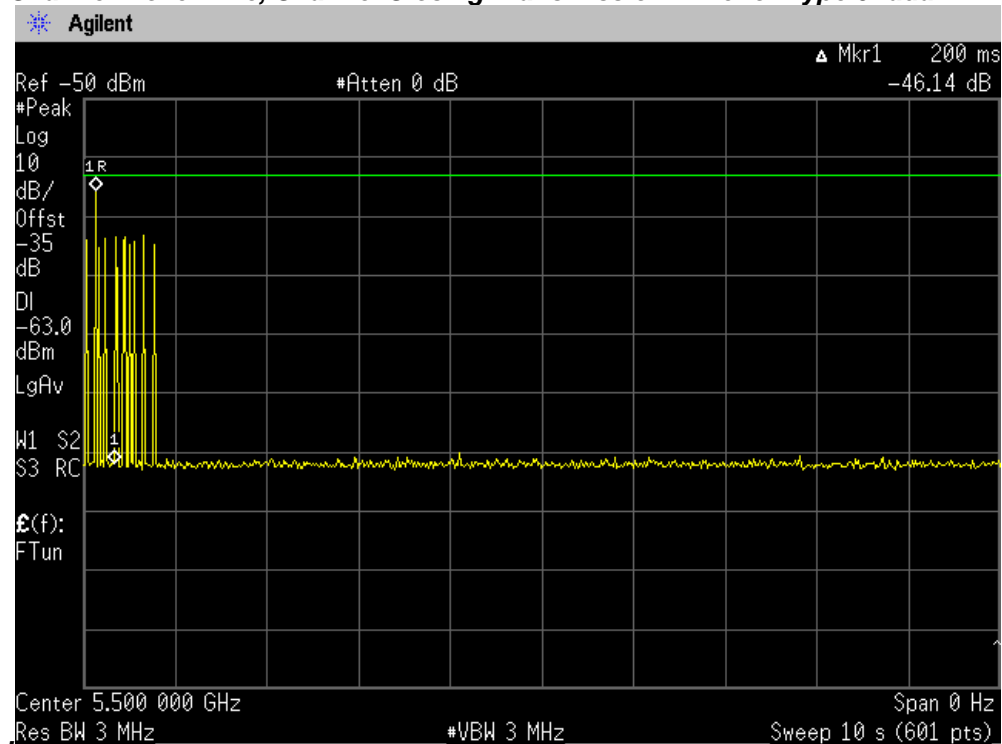



Measure the UUT for more than 30 minutes following the channel close/move time to verify that the UUT does not resume any transmissions on this Channel.

30 Minute Non-Occupancy Period (using Type 1 radar)

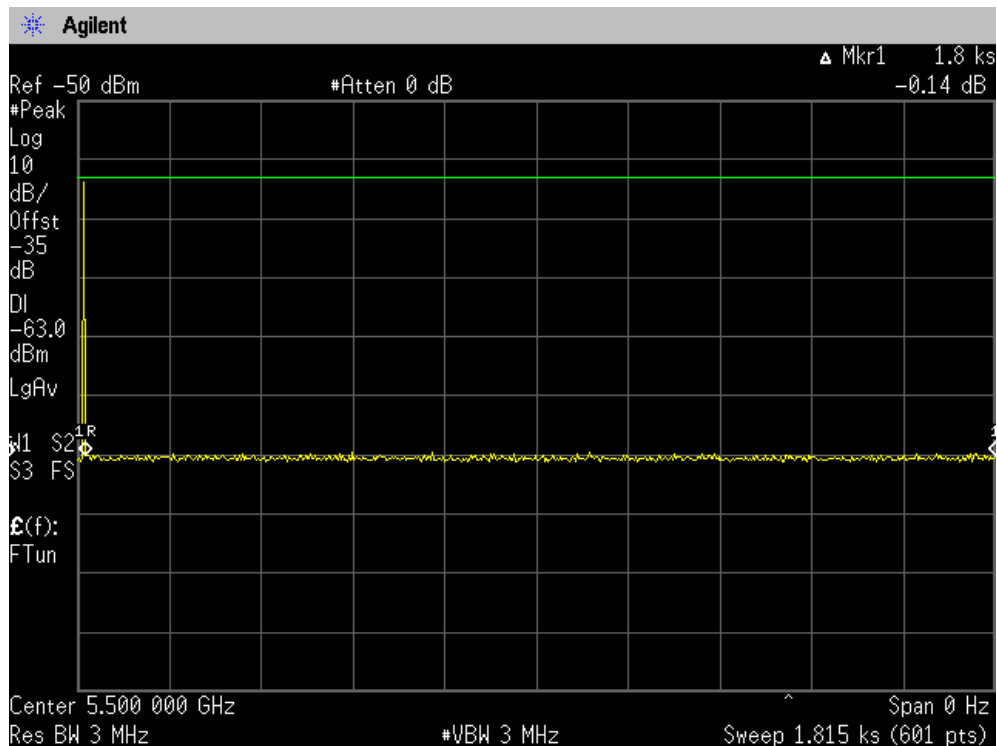



7. Statistical Performance Check

The steps below define the procedure to determine the minimum percentage of detection when a radar burst with a level equal to the DFS Detection Threshold + 1dB (-63dBm) is generated on the Operating Channel of the U-NII device.

A U-NII device operating as a Client Device will associate with the UUT (Master) at 5500 MHz. Stream the MPEG test file from the Master Device to the Client Device on the selected Channel for the entire period of the test.

The Radar Waveform generator sends the individual waveform for each of the radar types 1-6 at -63dbm. Statistical data will be gathered to determine the ability of the device to detect the radar test waveforms. The device can utilize a test mode to demonstrate when detection occurs to prevent the need to reset the device between trial runs. The percentage of successful detection is calculated by:

$$\frac{\text{TotalWaveformDetections}}{\text{TotalWaveformTrials}} \times 100 = \text{Probability of Detection Radar Waveform}$$

The Minimum number of trails, minimum percentage of successful detection and the average minimum percentage of successful detection are found in the *Radar Test Waveforms* section. The data represents the worst case detection for 20 MHz and 40 MHz signal bandwidths.



Type 1 Radar Statistical Performance

Trial	PW	PRI	Pulses	1=Detection Blank=No Detection	Detection Percentage
1	1	1428	18	0	
2	1	1428	18	1	
3	1	1428	18	1	
4	1	1428	18	1	
5	1	1428	18	1	
6	1	1428	18	1	
7	1	1428	18	0	
8	1	1428	18	1	
9	1	1428	18	1	
10	1	1428	18	1	
11	1	1428	18	1	
12	1	1428	18	1	
13	1	1428	18	1	
14	1	1428	18	1	
15	1	1428	18	1	
16	1	1428	18	1	
17	1	1428	18	1	
18	1	1428	18	1	
19	1	1428	18	1	
20	1	1428	18	1	
21	1	1428	18	1	
22	1	1428	18	1	
23	1	1428	18	1	
24	1	1428	18	1	
25	1	1428	18	1	
26	1	1428	18	1	
27	1	1428	18	1	
28	1	1428	18	0	
29	1	1428	18	1	
30	1	1428	18	0	



Type 2 Radar Statistical Performance

Trial	PW	PRI	Pulses	1=Detection Blank=No Detection	Detection Percentage
1	1.2	226	29	1	86.7%
2	3.6	168	27	1	
3	3.5	190	26	1	
4	4.2	186	26	1	
5	4.6	177	23	1	
6	4.8	210	23	1	
7	1.3	195	25	1	
8	4.3	192	27	1	
9	1.3	177	23	1	
10	1.5	182	23	1	
11	2.6	212	27	1	
12	3	177	26	1	
13	3.6	154	24	1	
14	2.6	154	24	1	
15	4.1	202	27	1	
16	5	187	25	1	
17	4.9	177	29	0	
18	3.2	226	29	1	
19	4	199	23	1	
20	2.3	176	24	1	
21	2.9	224	23	1	
22	4.9	194	29	0	
23	1.6	222	28	1	
24	3.1	181	28	1	
25	3.6	196	28	1	
26	2.4	178	25	1	
27	1.9	184	29	0	
28	3.9	216	26	1	
29	3.1	157	23	1	
30	1.7	155	28	0	



Type 3 Radar Statistical Performance

Trial	PW	PRI	Pulses	1=Detection Blank=No Detection	Detection Percentage
1	7.9	404	18	1	73.3%
2	9	339	18	0	
3	7.7	287	17	1	
4	7.5	212	17	1	
5	9.4	361	16	1	
6	8.6	307	17	1	
7	9.8	426	18	1	
8	9.3	300	16	1	
9	7.1	471	16	0	
10	9	343	18	0	
11	8.5	353	17	0	
12	8.1	470	18	1	
13	6	491	17	1	
14	7.8	220	18	1	
15	7.8	476	18	1	
16	6.6	249	17	0	
17	9.3	296	17	1	
18	6.5	209	17	1	
19	9.4	299	18	0	
20	6.8	284	16	1	
21	6.5	277	18	0	
22	8.7	346	18	1	
23	9.9	264	17	1	
24	7.7	330	17	1	
25	7.6	315	16	1	
26	6.8	499	18	1	
27	6.6	220	16	1	
28	9.9	369	18	0	
29	7.9	475	17	1	
30	8.4	244	17	1	

Type 4 Radar Statistical Performance

Trial	PW	PRI	Pulses	1=Detection Blank=No Detection	Detection Percentage
1	16	287	16	1	
2	12.6	456	16	1	
3	18.3	289	12	0	
4	11.5	279	12	1	
5	15.4	347	12	1	
6	19.7	335	16	1	
7	14.2	318	16	1	
8	16.8	466	13	1	
9	16	420	16	1	
10	15.7	419	15	1	
11	15.9	346	16	1	
12	16.7	439	15	1	
13	19.5	310	13	1	
14	19.9	441	12	1	
15	19.9	424	15	0	
16	18.4	427	15	0	
17	16.7	443	15	1	
18	12.6	427	13	0	
19	19.3	405	12	1	
20	12.2	490	14	1	
21	17.6	375	13	1	
22	17.5	230	12	1	
23	16.9	307	15	1	
24	16.9	223	16	1	
25	14.4	398	12	0	
26	14.1	235	14	1	
27	14.4	243	15	0	
28	12.7	424	14	1	
29	15.5	272	15	1	
30	14.2	214	13	1	80

In addition an average minimum percentage of successful detection across all four Short pulse radar test waveforms is required and is calculated as follows:

$$\frac{P_d 1 + P_d 2 + P_d 3 + P_d 4}{4} = (86.7\% + 86.7\% + 73.3\% + 80\%) / 4 = 81.7\% (>80\%)$$

**Type 5 Radar Statistical Performance**

*See the Bin5 Radar Characteristics at the end of this report.

Trial #	Filename	1=Detection Blank=No Detection
1	USA Bin 5 Radar Test 1	1
2	USA Bin 5 Radar Test 2	1
3	USA Bin 5 Radar Test 3	1
4	USA Bin 5 Radar Test 4	1
5	USA Bin 5 Radar Test 5	1
6	USA Bin 5 Radar Test 6	1
7	USA Bin 5 Radar Test 7	1
8	USA Bin 5 Radar Test 8	1
9	USA Bin 5 Radar Test 9	1
10	USA Bin 5 Radar Test 10	1
11	USA Bin 5 Radar Test 11	1
12	USA Bin 5 Radar Test 12	1
13	USA Bin 5 Radar Test 13	1
14	USA Bin 5 Radar Test 14	1
15	USA Bin 5 Radar Test 15	1
16	USA Bin 5 Radar Test 16	1
17	USA Bin 5 Radar Test 17	1
18	USA Bin 5 Radar Test 18	1
19	USA Bin 5 Radar Test 19	1
20	USA Bin 5 Radar Test 20	1
21	USA Bin 5 Radar Test 21	1
22	USA Bin 5 Radar Test 22	1
23	USA Bin 5 Radar Test 23	1
24	USA Bin 5 Radar Test 24	1
25	USA Bin 5 Radar Test 25	1
26	USA Bin 5 Radar Test 26	1
27	USA Bin 5 Radar Test 27	1
28	USA Bin 5 Radar Test 28	1
29	USA Bin 5 Radar Test 29	1
30	USA Bin 5 Radar Test 30	1
Detection Percentage		100% (>80%)

**Type 6 Radar Statistical Performance**

*See the Bin6 Radar Characteristics at the end of this report.

Trial #	Filename	1=Detection Blank=No Detection
1	USA Bin 6 Radar Test 1	1
2	USA Bin 6 Radar Test 2	1
3	USA Bin 6 Radar Test 3	1
4	USA Bin 6 Radar Test 4	1
5	USA Bin 6 Radar Test 5	1
6	USA Bin 6 Radar Test 6	1
7	USA Bin 6 Radar Test 7	1
8	USA Bin 6 Radar Test 8	1
9	USA Bin 6 Radar Test 9	1
10	USA Bin 6 Radar Test 10	1
11	USA Bin 6 Radar Test 11	1
12	USA Bin 6 Radar Test 12	1
13	USA Bin 6 Radar Test 13	1
14	USA Bin 6 Radar Test 14	1
15	USA Bin 6 Radar Test 15	1
16	USA Bin 6 Radar Test 16	1
17	USA Bin 6 Radar Test 17	1
18	USA Bin 6 Radar Test 18	1
19	USA Bin 6 Radar Test 19	1
20	USA Bin 6 Radar Test 20	1
21	USA Bin 6 Radar Test 21	1
22	USA Bin 6 Radar Test 22	1
23	USA Bin 6 Radar Test 23	1
24	USA Bin 6 Radar Test 24	1
25	USA Bin 6 Radar Test 25	1
26	USA Bin 6 Radar Test 26	1
27	USA Bin 6 Radar Test 27	1
28	USA Bin 6 Radar Test 28	1
29	USA Bin 6 Radar Test 29	1
30	USA Bin 6 Radar Test 30	1
Detection Percentage		100%



USA Bin 5 Radar Test 1

Burst#	Pulses	Chirp(MHz)	PW(uS)	Inter-pulse spacing/s(uS)	Pulse Start(S)
1	2	8	70	1486	0.265334
2	3	14	95	1653,1619	1.195186
3	1	15	65	NA	1.574911
4	3	9	65	1208,1017	2.324644
5	1	18	60	NA	2.612440
6	3	14	85	1788,1931	3.151526
7	1	11	95	NA	3.963458
8	2	10	95	1597	4.202753
9	2	11	70	1308	5.157464
10	1	10	85	NA	5.923865
11	3	14	70	1489,1138	6.320280
12	3	15	100	1814,1914	6.631021
13	1	12	70	NA	7.613991
14	1	12	50	NA	7.984286
15	1	17	100	NA	8.568799
16	2	11	85	1863	9.375974
17	3	15	95	1137,1886	10.123996
18	2	6	85	1783	10.582152
19	1	20	95	NA	11.235204
20	2	8	80	1792	11.782910

USA Bin 5 Radar Test 2

Burst#	Pulses	Chirp(MHz)	PW(uS)	Inter-pulse spacing/s(uS)	Pulse Start(S)
1	3	5	50	1215,1099	0.520496
2	3	14	75	1644,1646	1.267770
3	1	15	65	NA	1.723383
4	2	10	60	1403	3.149864
5	1	6	75	NA	3.602321
6	2	9	50	1410	4.457648
7	2	9	50	1951	5.590197
8	2	18	85	1671	6.640204
9	3	8	100	1696,1985	6.989766
10	2	8	55	1535	7.828982
11	2	15	85	1291	8.660815
12	3	20	95	1736,1712	9.828321
13	1	8	85	NA	10.944422
14	1	13	55	NA	11.564845

USA Bin 5 Radar Test 3

Burst#	Pulses	Chirp(MHz)	PW(uS)	Inter-pulse spacing/s(uS)	Pulse Start(S)
1	1	11	75	NA	0.127943
2	2	18	95	1696	0.814929
3	1	15	80	NA	2.002347
4	2	7	65	1235	2.174262
5	1	8	90	NA	3.341870
6	3	8	80	1641,1197	4.213937
7	2	5	55	1039	4.773798
8	3	17	55	1035,1293	4.969466
9	1	11	60	NA	6.258380
10	3	9	90	1215,1532	6.417831
11	1	9	80	NA	7.200270
12	3	7	55	1802,1512	7.980620
13	1	10	85	NA	8.650761
14	1	19	55	NA	9.811377
15	1	18	50	NA	9.991517
16	1	13	55	NA	10.885361



17	3	19	100	1073,1578	11.900978	
USA Bin 5 Radar Test 4						
Burst#	Pulses	Chirp(MHz)	PW(uS)	Inter-pulse spacing/s(uS)	Pulse Start(S)	
1	1	10	75	NA	0.851765	
2	2	16	50	1734	1.523464	
3	1	14	90	NA	3.409426	
4	3	5	55	1748,1196	4.867602	
5	1	19	50	NA	6.467982	
6	3	13	95	1912,1579	7.279553	
7	3	11	80	1764,1358	8.275933	
8	3	7	95	1290,1579	10.534757	
9	1	17	95	NA	11.055090	
USA Bin 5 Radar Test 5						
Burst#	Pulses	Chirp(MHz)	PW(uS)	Inter-pulse spacing/s(uS)	Pulse Start(S)	
1	2	17	60	1376	0.378704	
2	1	17	50	NA	1.033985	
3	1	12	95	NA	1.898978	
4	2	9	90	1134	2.590892	
5	2	14	55	1536	3.903324	
6	1	8	55	NA	4.207086	
7	2	18	95	1127	5.181973	
8	2	14	70	1499	6.330651	
9	2	16	65	1348	6.703345	
10	3	14	55	1380,1867	7.799516	
11	2	12	75	1664	8.527028	
12	1	15	65	NA	9.560012	
13	3	7	90	1430,1817	10.106775	
14	3	20	100	1245,1388	10.892519	
15	2	16	55	1399	11.882159	
USA Bin 5 Radar Test 6						
Burst#	Pulses	Chirp(MHz)	PW(uS)	Inter-pulse spacing/s(uS)	Pulse Start(S)	
1	3	15	70	1224,1557	0.615337	
2	1	12	100	NA	1.222028	
3	1	7	80	NA	1.448944	
4	3	6	50	1387,1127	2.494806	
5	2	13	65	1047	3.312107	
6	3	17	85	1004,1348	3.541892	
7	1	5	90	NA	4.544656	
8	3	10	85	1821,1540	4.903709	
9	2	8	70	1889	5.873673	
10	2	5	60	1318	6.211249	
11	1	20	80	NA	7.120180	
12	3	8	60	1600,1508	7.673545	
13	2	5	85	1994	8.182390	
14	1	11	95	NA	9.046155	
15	2	6	60	1557	9.957648	
16	1	14	50	NA	10.013632	
17	3	17	60	1879,1537	10.863400	
18	1	15	85	NA	11.846228	
USA Bin 5 Radar Test 7						
Burst#	Pulses	Chirp(MHz)	PW(uS)	Inter-pulse spacing/s(uS)	Pulse Start(S)	
1	2	5	70	1028	0.519628	
2	2	12	55	1510	1.305640	
3	3	8	100	1638,1837	1.687766	
4	3	8	65	1267,1809	2.210869	
5	3	18	60	1386,1010	3.317992	



6	1	16	95	NA	3.715596
7	3	11	75	1661,1317	4.423562
8	3	20	50	1821,1845	5.182690
9	1	13	60	NA	5.877019
10	3	7	85	1223,1138	6.309000
11	1	15	60	NA	7.222898
12	3	20	95	1712,1635	7.722671
13	1	18	95	NA	8.608274
14	1	12	95	NA	8.880852
15	3	17	60	1976,1216	9.925657
16	1	11	80	NA	10.123538
17	2	16	55	1660	10.857579
18	3	16	60	1552,1936	11.537813
USA Bin 5 Radar Test 8					
Burst#	Pulses	Chirp(MHz)	PW(uS)	Inter-pulse spacing/s(uS)	Pulse Start(S)
1	2	10	60	1141	0.041697
2	1	6	75	NA	1.258814
3	1	12	100	NA	2.565702
4	3	20	65	1197,1015	2.847122
5	2	11	60	1543	4.079128
6	1	18	75	NA	5.184988
7	1	11	75	NA	6.169029
8	3	13	70	1208,1732	6.524777
9	2	9	100	1482	7.612735
10	1	10	50	NA	8.842803
11	1	12	95	NA	9.694498
12	1	6	55	NA	10.970311
13	2	8	85	1378	11.654229
USA Bin 5 Radar Test 9					
Burst#	Pulses	Chirp(MHz)	PW(uS)	Inter-pulse spacing/s(uS)	Pulse Start(S)
1	2	18	90	1636	0.119652
2	1	18	95	NA	2.171864
3	1	18	75	NA	2.723093
4	2	18	100	1290	4.512865
5	3	5	65	1386,1162	4.968297
6	2	9	55	1945	6.855340
7	2	14	50	1091	7.628724
8	2	10	50	1289	8.946233
9	2	20	90	1597	10.341220
10	1	9	70	NA	11.297470
USA Bin 5 Radar Test 10					
Burst#	Pulses	Chirp(MHz)	PW(uS)	Inter-pulse spacing/s(uS)	Pulse Start(S)
1	1	17	90	NA	0.357269
2	2	16	70	1865	0.980346
3	3	14	70	1454,1855	1.561334
4	3	9	70	1748,1310	2.008141
5	3	19	80	1361,1230	2.784238
6	2	16	55	1427	3.266806
7	1	12	70	NA	3.853802
8	3	16	60	1273,1727	4.294271
9	3	20	95	1106,1739	4.952857
10	3	17	65	1320,1510	5.768022
11	1	8	60	NA	6.210793
12	1	10	90	NA	6.888428
13	3	19	50	1813,1445	7.528204
14	3	20	50	1308,1277	8.122012
15	3	15	55	1973,1190	8.953106



16	2	11	70	1626	9.428198
17	3	15	70	1154,1395	9.898070
18	2	15	55	1751	10.531236
19	2	5	95	1820	11.175066
20	1	9	90	NA	11.682351
USA Bin 5 Radar Test 11					
Burst#	Pulses	Chirp(MHz)	PW(uS)	Inter-pulse spacing/s(uS)	Pulse Start(S)
1	1	9	75	NA	0.292410
2	2	15	90	1969	1.050276
3	3	13	55	1983,1006	1.512928
4	2	9	95	1319	2.195562
5	1	13	70	NA	2.618727
6	1	15	95	NA	3.495425
7	2	7	100	1632	3.874947
8	3	8	65	1488,1829	4.778645
9	1	17	50	NA	5.266341
10	2	17	65	1647	5.864888
11	1	10	50	NA	6.515013
12	3	20	55	1819,1410	7.050598
13	3	18	70	1335,1477	7.318957
14	1	20	90	NA	8.393739
15	1	6	65	NA	8.647178
16	3	12	75	1575,1309	9.546410
17	2	9	50	1458	10.070466
18	2	6	90	1096	10.757288
19	3	5	50	1895,1128	11.330961
20	2	14	100	1856	11.744340
USA Bin 5 Radar Test 12					
Burst#	Pulses	Chirp(MHz)	PW(uS)	Inter-pulse spacing/s(uS)	Pulse Start(S)
1	3	13	80	1698,1598	0.648291
2	1	16	80	NA	1.055330
3	3	19	95	1113,1923	1.873242
4	3	13	75	1595,1033	2.617960
5	2	19	90	1308	3.273637
6	1	8	85	NA	3.727649
7	1	17	70	NA	4.521353
8	1	11	50	NA	4.770660
9	1	18	95	NA	5.608873
10	2	17	100	1849	6.001675
11	1	9	80	NA	7.015589
12	1	13	70	NA	7.736635
13	1	7	100	NA	8.598057
14	3	19	70	1501,1696	9.080572
15	3	18	60	1800,1995	9.488659
16	3	9	95	1806,1252	10.386306
17	3	9	75	1811,1593	11.100703
18	1	5	50	NA	11.741126
USA Bin 5 Radar Test 13					
Burst#	Pulses	Chirp(MHz)	PW(uS)	Inter-pulse spacing/s(uS)	Pulse Start(S)
1	1	16	60	NA	0.949186
2	3	12	55	1835,1655	1.328883
3	3	14	65	1083,1523	3.177073
4	2	17	70	1768	4.164986
5	2	5	95	1634	4.775392
6	1	13	70	NA	6.015700
7	1	11	50	NA	7.479978
8	3	7	60	1348,1991	8.696874



9	3	7	95	1172,1473	9.515080
10	3	7	90	1122,1173	10.595005
11	1	20	55	NA	10.991176
USA Bin 5 Radar Test 14					
Burst#	Pulses	Chirp(MHz)	PW(uS)	Inter-pulse spacing/s(uS)	Pulse Start(S)
1	1	12	90	NA	0.073808
2	1	14	90	NA	0.745085
3	2	11	70	1504	1.539852
4	1	8	60	NA	2.240365
5	2	16	95	1269	2.901959
6	3	10	60	1235,1409	3.181174
7	2	11	70	1396	4.147888
8	1	13	65	NA	4.228573
9	2	19	55	1169	5.181808
10	1	9	70	NA	5.414666
11	2	20	85	1679	6.087645
12	2	7	50	1028	6.776720
13	2	6	85	1865	7.473392
14	2	5	80	1180	8.276813
15	1	13	95	NA	8.408825
16	3	6	95	1227,1091	9.291278
17	3	11	70	1282,1452	10.015720
18	1	7	50	NA	10.458138
19	2	15	50	2000	11.332965
20	3	5	80	1448,1012	11.608048
USA Bin 5 Radar Test 15					
Burst#	Pulses	Chirp(MHz)	PW(uS)	Inter-pulse spacing/s(uS)	Pulse Start(S)
1	1	8	90	NA	0.077766
2	3	19	75	1819,1342	1.017422
3	2	10	60	1612	1.362853
4	1	17	85	NA	2.176247
5	2	17	100	1382	3.001128
6	2	20	100	1855	3.629951
7	1	11	100	NA	4.343951
8	2	5	70	1326	4.496126
9	2	10	100	1035	5.404115
10	3	12	60	1054,1454	5.975737
11	2	8	50	1779	6.845130
12	2	18	50	1700	7.533995
13	3	14	70	1007,1511	8.108018
14	3	20	90	1651,1887	8.720598
15	1	14	70	NA	9.025767
16	3	8	55	1017,1450	9.819592
17	2	14	95	1536	10.709691
18	2	14	50	1714	10.745919
19	2	17	80	1500	11.798604
USA Bin 5 Radar Test 19					
Burst#	Pulses	Chirp(MHz)	PW(uS)	Inter-pulse spacing/s(uS)	Pulse Start(S)
1	1	17	50	NA	0.528729
2	2	13	55	1119	0.939251
3	3	7	95	1863,1925	1.890174
4	1	17	75	NA	3.573350
5	3	14	95	1222,1484	4.378918
6	3	11	80	1939,1185	4.973955
7	2	16	70	1866	5.838912
8	2	12	60	1505	6.607550
9	3	7	50	1644,1668	7.615131



10	3	20	100	1766,1664	8.342978
11	2	20	100	1191	9.947313
12	1	5	70	NA	10.685263
13	1	15	100	NA	11.818584

USA Bin 5 Radar Test 20

Burst#	Pulses	Chirp(MHz)	PW(uS)	Inter-pulse spacing/s(uS)	Pulse Start(S)
1	1	20	50	NA	0.606118
2	1	5	55	NA	0.639488
3	2	5	70	1079	1.882586
4	3	11	85	1131,1427	2.162516
5	1	14	65	NA	3.085596
6	1	9	80	NA	3.216793
7	1	20	65	NA	3.850859
8	3	5	60	1178,1572	4.671587
9	3	5	100	1407,1805	5.584487
10	3	5	75	1421,1897	6.046344
11	2	12	70	1604	6.442920
12	2	11	65	1882	7.445739
13	3	17	50	1882,1022	8.019793
14	3	16	50	1685,1914	8.692311
15	2	14	65	1668	9.469231
16	3	13	90	1823,1388	10.080105
17	2	12	65	1735	10.158705
18	2	17	75	1676	10.892375
19	1	5	50	NA	11.757968

USA Bin 5 Radar Test 21

Burst#	Pulses	Chirp(MHz)	PW(uS)	Inter-pulse spacing/s(uS)	Pulse Start(S)
1	2	20	80	1408	0.357130
2	2	6	75	1310	1.059486
3	2	10	80	2000	1.269920
4	1	17	70	NA	2.040277
5	3	14	95	1860,1426	2.953910
6	1	7	50	NA	3.460244
7	3	5	65	1123,1563	3.823863
8	1	8	90	NA	4.962983
9	3	7	70	1445,1803	5.222607
10	1	13	70	NA	5.714969
11	2	7	60	1139	6.923050
12	3	14	90	1760,1366	6.954939
13	1	9	55	NA	7.997090
14	1	7	85	NA	8.763733
15	1	12	75	NA	8.930217
16	3	9	80	1944,1875	10.043983
17	2	12	100	1447	10.361280
18	1	20	75	NA	10.839777
19	1	19	80	NA	11.695909

USA Bin 5 Radar Test 22

Burst#	Pulses	Chirp(MHz)	PW(uS)	Inter-pulse spacing/s(uS)	Pulse Start(S)
1	1	18	75	NA	0.892051
2	3	19	80	1554,1465	1.312659
3	3	19	85	1123,1711	2.218820
4	3	20	75	1788,1711	3.264874
5	2	18	85	1675	4.966352
6	2	12	75	1233	5.740953
7	2	7	80	1071	6.636147
8	1	8	60	NA	7.150020



9	1	5	85	NA	8.938973
10	1	19	90	NA	9.079892
11	2	17	70	1143	10.306403
12	2	6	75	1184	11.998230

USA Bin 5 Radar Test 23

Burst#	Pulses	Chirp(MHz)	PW(uS)	Inter-pulse spacing/s(uS)	Pulse Start(S)
1	1	10	60	NA	0.587757
2	2	12	80	1268	0.981467
3	2	7	50	1115	1.610205
4	3	16	65	1346,1048	2.428346
5	3	10	95	1217,1764	2.881662
6	1	16	80	NA	3.209584
7	3	6	55	1021,1530	4.137370
8	2	8	55	1705	4.662134
9	1	18	55	NA	5.532934
10	2	15	90	1029	6.220981
11	2	18	80	1359	6.622987
12	1	18	75	NA	7.058291
13	1	9	55	NA	8.144720
14	2	5	100	1490	8.781202
15	1	9	95	NA	9.283502
16	1	10	90	NA	9.661487
17	2	15	90	1205	10.489821
18	2	9	85	1802	10.799562
19	1	13	70	NA	11.496314

USA Bin 5 Radar Test 24

Burst#	Pulses	Chirp(MHz)	PW(uS)	Inter-pulse spacing/s(uS)	Pulse Start(S)
1	1	12	90	NA	0.054663
2	3	19	65	1357,1771	1.219044
3	3	16	60	1653,1335	1.922585
4	3	11	90	1170,1039	2.606924
5	2	20	80	1958	3.609482
6	3	18	100	1500,1236	4.072770
7	2	12	55	1895	5.114915
8	3	18	75	1564,1573	6.085995
9	1	10	50	NA	6.953837
10	3	11	65	1741,1162	7.721074
11	3	16	80	1623,1739	8.138690
12	2	9	75	1388	9.226998
13	3	16	90	1883,1762	10.364177
14	2	20	50	1567	10.536482
15	3	20	70	1855,1587	11.990974

USA Bin 5 Radar Test 25

Burst#	Pulses	Chirp(MHz)	PW(uS)	Inter-pulse spacing/s(uS)	Pulse Start(S)
1	3	9	50	1514,1790	0.128935
2	3	7	95	1709,1494	1.044650
3	3	12	95	1669,1199	1.710309
4	2	12	85	1033	2.496817
5	2	11	95	1079	3.963800
6	2	10	50	1961	4.095773
7	3	9	65	1417,1246	4.912255
8	2	8	70	1257	6.371336
9	2	13	95	1535	6.770986
10	1	11	50	NA	7.450416
11	1	10	65	NA	8.536185
12	2	16	50	1400	9.578508
13	3	7	60	1636,1653	9.996259



14	1	6	85		NA	10.548162
15	3	14	95	1533,1862		11.754037
USA Bin 5 Radar Test 26						
Burst#	Pulses	Chirp(MHz)	PW(uS)	Inter-pulse spacing/s(uS)	Pulse	Start(S)
1	1	15	100		NA	0.232665
2	1	7	100		NA	0.978346
3	3	15	50	1227,1578		2.028674
4	3	5	60	1692,1947		2.661997
5	2	15	80	1276		3.110519
6	1	9	55		NA	4.342974
7	1	20	70		NA	4.800884
8	3	18	95	1948,1078		5.643197
9	2	9	75	1683		6.191529
10	3	15	50	1135,1387		6.852566
11	2	10	85	1677		8.114811
12	1	8	60		NA	8.949463
13	2	6	50	1593		9.623826
14	1	13	65		NA	10.135349
15	3	9	60	1560,1663		10.956630
16	2	16	80	1643		11.477109
USA Bin 5 Radar Test 27						
Burst#	Pulses	Chirp(MHz)	PW(uS)	Inter-pulse spacing/s(uS)	Pulse	Start(S)
1	2	14	65	1506		0.027801
2	3	12	50	1404,1752		1.242653
3	2	12	85	1824		1.764332
4	2	13	80	1284		2.581830
5	2	7	80	1965		2.734184
6	1	16	70		NA	3.342816
7	3	15	50	1415,1285		4.313548
8	2	19	55	1237		4.868162
9	2	19	80	1701		5.373955
10	2	16	55	1265		6.369277
11	1	15	65		NA	7.057002
12	3	6	100	1982,1789		7.988731
13	3	7	85	1834,1836		8.169291
14	3	12	50	1266,1992		8.676270
15	1	5	75		NA	9.975291
16	2	5	90	1152		10.212293
17	3	19	95	1025,1400		11.315712
18	1	17	95		NA	11.962799
USA Bin 5 Radar Test 28						
Burst#	Pulses	Chirp(MHz)	PW(uS)	Inter-pulse spacing/s(uS)	Pulse	Start(S)
1	1	14	70		NA	1.157479
2	3	12	85	1869,1957		1.306707
3	1	13	100		NA	2.552169
4	1	10	50		NA	4.551944
5	1	9	60		NA	5.935229
6	3	17	95	1901,1323		6.021266
7	1	13	60		NA	7.737172
8	3	14	75	1806,1661		9.289671
9	2	12	95	1163		10.212325
10	1	16	95		NA	11.508843
USA Bin 5 Radar Test 29						
Burst#	Pulses	Chirp(MHz)	PW(uS)	Inter-pulse spacing/s(uS)	Pulse	Start(S)
1	1	11	100		NA	0.458403
2	3	13	75	1193,1195		0.914158
3	2	12	85	1450		1.514820



4	2	9	65	1589	2.984716
5	3	6	50	1387,1570	3.309426
6	2	6	85	1853	4.213796
7	2	11	70	1356	5.135279
8	3	11	80	1572,1936	5.869565
9	2	10	90	1399	6.178486
10	1	7	90	NA	7.007385
11	1	14	65	NA	8.000297
12	2	14	65	1969	8.770694
13	1	9	50	NA	9.717765
14	3	17	100	1319,1463	10.267072
15	2	6	75	1412	11.021228
16	2	10	55	1308	11.301067

USA Bin 5 Radar Test 30

Burst#	Pulses	Chirp(MHz)	PW(uS)	Inter-pulse spacing/s(uS)	Pulse Start(S)
1	2	16	80	1537	0.323388
2	3	6	75	1837,1942	0.687146
3	3	7	65	1626,1838	1.508614
4	2	14	50	1186	2.284999
5	2	10	75	1362	2.629925
6	3	9	55	1266,1691	3.251345
7	2	6	80	1276	4.415377
8	1	18	100	NA	4.464031
9	2	11	80	1206	5.451080
10	2	5	80	1251	5.919893
11	3	17	85	1635,1875	6.879626
12	2	20	95	1937	7.483475
13	3	15	60	1642,1942	7.749995
14	3	20	90	2000,1002	8.415052
15	1	20	55	NA	9.280364
16	1	10	80	NA	9.844572
17	1	8	80	NA	10.707841
18	2	12	55	1856	10.903524
19	1	9	100	NA	11.561047

USA Bin 6 Radar Test 1

Hop#	Frequency(GHz)	Pulse Start (mS)
2	5.494000	6
17	5.491000	51
19	5.499000	57
69	5.507000	207
94	5.508000	282
99	5.509000	297

USA Bin 6 Radar Test 2

Hop#	Frequency(GHz)	Pulse Start (mS)
8	5.495000	24
38	5.497000	114
63	5.492000	189

USA Bin 6 Radar Test 3

Hop#	Frequency(GHz)	Pulse Start (mS)
67	5.505000	201
90	5.499000	270



USA Bin 6 Radar Test 4

Hop#	Frequency(GHz)	Pulse Start (mS)
27	5.500000	81
95	5.502000	285

USA Bin 6 Radar Test 5

Hop#	Frequency(GHz)	Pulse Start (mS)
16	5.503000	48
46	5.509000	138
62	5.500000	186
71	5.493000	213

USA Bin 6 Radar Test 6

Hop#	Frequency(GHz)	Pulse Start (mS)
18	5.501000	54
40	5.508000	120
92	5.503000	276
93	5.500000	279

USA Bin 6 Radar Test 7

Hop#	Frequency(GHz)	Pulse Start (mS)
21	5.491000	63
31	5.506000	93
51	5.503000	153
81	5.494000	243

USA Bin 6 Radar Test 8

Hop#	Frequency(GHz)	Pulse Start (mS)
37	5.500000	111
42	5.499000	126
43	5.508000	129
54	5.495000	162
79	5.505000	237
91	5.501000	273

USA Bin 5 Radar Test 9

Hop#	Frequency(GHz)	Pulse Start (mS)
0	5.493000	0
58	5.491000	174
97	5.500000	291

USA Bin 6 Radar Test 10

Hop#	Frequency(GHz)	Pulse Start (mS)
13	5.498000	39
54	5.504000	162
84	5.508000	252
93	5.505000	279

USA Bin 6 Radar Test 11

Hop#	Frequency(GHz)	Pulse Start (mS)
25	5.495000	75
63	5.508000	189
68	5.502000	204
84	5.501000	252



USA Bin 6 Radar Test 12

Hop#	Frequency(GHz)	Pulse Start (mS)
10	5.499000	30
61	5.507000	183
66	5.493000	198
96	5.501000	288

USA Bin 6 Radar Test 13

Hop#	Frequency(GHz)	Pulse Start (mS)
3	5.505000	9
43	5.502000	129
61	5.494000	183
69	5.503000	207
86	5.507000	258

USA Bin 6 Radar Test 14

Hop#	Frequency(GHz)	Pulse Start (mS)
9	5.494000	27
10	5.500000	30

USA Bin 6 Radar Test 15

Hop#	Frequency(GHz)	Pulse Start (mS)
1	5.498000	3
15	5.509000	45
85	5.499000	255

USA Bin 6 Radar Test 16

Hop#	Frequency(GHz)	Pulse Start (mS)
0	5.494000	0
22	5.507000	66
26	5.503000	78
46	5.491000	138
63	5.499000	189
65	5.496000	195

USA Bin 6 Radar Test 17

Hop#	Frequency(GHz)	Pulse Start (mS)
32	5.491000	96
35	5.500000	105
85	5.505000	255

USA Bin 6 Radar Test 18

Hop#	Frequency(GHz)	Pulse Start (mS)
32	5.492000	96
70	5.502000	210
89	5.508000	267

USA Bin 6 Radar Test 19

Hop#	Frequency(GHz)	Pulse Start (mS)
40	5.503000	120
45	5.493000	135
64	5.492000	192
66	5.498000	198
71	5.494000	213
99	5.505000	297

USA Bin 6 Radar Test 20



Hop#	Frequency(GHz)	Pulse Start (mS)
4	5.509000	12
9	5.506000	27
35	5.496000	105
53	5.505000	159

USA Bin 6 Radar Test 21

Hop#	Frequency(GHz)	Pulse Start (mS)
1	5.499000	3
53	5.493000	159
59	5.498000	177

USA Bin 6 Radar Test 22

Hop#	Frequency(GHz)	Pulse Start (mS)
18	5.507000	54
27	5.501000	81
40	5.494000	120
61	5.492000	183
68	5.509000	204
74	5.500000	222
99	5.505000	297

USA Bin 6 Radar Test 23

Hop#	Frequency(GHz)	Pulse Start (mS)
40	5.498000	120
49	5.495000	147
51	5.502000	153

USA Bin 6 Radar Test 24

Hop#	Frequency(GHz)	Pulse Start (mS)
46	5.508000	138
62	5.504000	186
75	5.496000	225

USA Bin 6 Radar Test 25

Hop#	Frequency(GHz)	Pulse Start (mS)
17	5.505000	51
49	5.508000	147
50	5.497000	150
52	5.495000	156
62	5.501000	186
91	5.506000	273

USA Bin 6 Radar Test 26

Hop#	Frequency(GHz)	Pulse Start (mS)
16	5.507000	48
32	5.498000	96
70	5.494000	210

USA Bin 6 Radar Test 27

Hop#	Frequency(GHz)	Pulse Start (mS)
6	5.491000	18

USA Bin 6 Radar Test 28

Hop#	Frequency(GHz)	Pulse Start (mS)
12	5.507000	36
21	5.492000	63



27	5.509000	81
35	5.498000	105
63	5.495000	189
76	5.502000	228
93	5.508000	279

USA Bin 6 Radar Test 29

Hop#	Frequency(GHz)	Pulse Start (mS)
6	5.496000	18
12	5.502000	36
14	5.498000	42
18	5.508000	54

USA Bin 6 Radar Test 30

Hop#	Frequency(GHz)	Pulse Start (mS)
37	5.492000	111
77	5.507000	231
96	5.509000	288