

TEST REPORT FOR CERTIFICATION OF A U-NII TRANSCEIVER

Applicant: Cisco Systems, Inc.
170 West Tasman Drive
San Jose, CA 95134-1706

FCC ID: LDK102047P
Model name: Pegasus

Product Description

Pegasus is a wireless bridge designed for building to building wireless connectivity. Operating in the 5.8 GHz UNII 3 band, derived from the 802.11a standard, Pegasus delivers up to 54Mbps data rate without special licensing. Pegasus is a self contained unit designed for outdoor installations, providing differing antenna gains as well as coverage patterns and supports both point to point and point to multipoint configurations.

Product Block Diagram

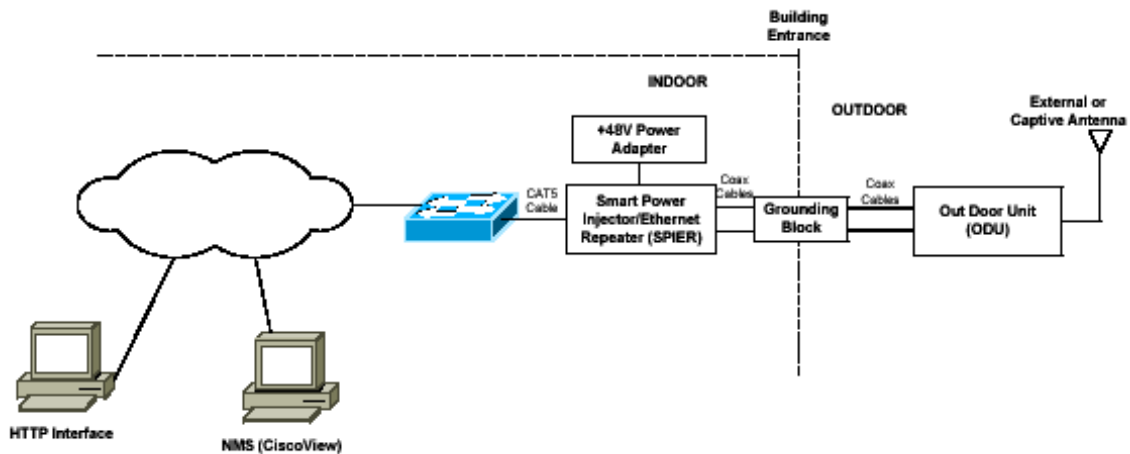

Product Specifications

Transmitter Power:	24 dBm, adjustable in 1 dBm steps
Operating Frequency Range:	5745 MHz (Channel 1) 5765 MHz (Channel 2) 5785 MHz (Channel 3) 5805 MHz (Channel 4)
Antennas	9.5 dBi omni 10 dBi sector 23 dBi max integral antenna (22.5 dBi typical)* 29.5 dBi max dish (28 dBi typical)
Power	-48 VDC over Ethernet from power inserter (DC voltage derived from AC adapter)

* sold under separate FCC ID: LDK102047. All electronics identical.

Test Procedures and Guidelines

1) ANSI C63.4

15.207, 15.407(b)5, AC line conducted emissions:	0.150 – 30 MHz
15.109, 15.407(b)5, Radiated emissions, below 1 GHz:	30 – 1000 MHz
15.205 TX Radiated emissions, restricted bands:	1 – 40 GHz

2) FCC Public Notice DA 02-2138 dated 30 August 2002

15.407(a)3 Peak power measurement:	Method 1
15.407(a)5 Peak power spectral density measurement:	Method 2
15.407(b)3,4 Unwanted emissions (band edge psd)	Method 2
15.401(c) Emission bandwidth	
15.407(a)6 Peak excursion	

3) 2002 TCB Instructions: GUIDANCE FOR REVIEWING OF COMPLIANCE SUBMISSIONS FOR UNII DEVICES

All testing was performed by me or by qualified EMC test engineers acting under my supervision. Antenna output conducted tests were tested on 25 March 2003 in the RF laboratory at Cisco Building 14 in San Jose, CA.

Radiated emissions 1-40GHz were tested on 11 April 2003 at Cisco Building 6 in San Jose, CA.

Radiated emissions 30-1000 MHz and AC line conducted emissions were performed 22 October 2002 in Cisco Building P.

Testing in Building 14 was performed on 25 March 2003. Testing in Building 6 was performed on 11 April 2003.

T.N. Cokenias
EMC Consultant and Agent for Cisco Systems

TEST RESULTS

15.401(c) Emission bandwidth

Test equipment

Agilent 4440A spectrum analyzer
6 dB attenuator
coaxial cable (1.3 dB loss at 5.8 GHz)

Test Set-up

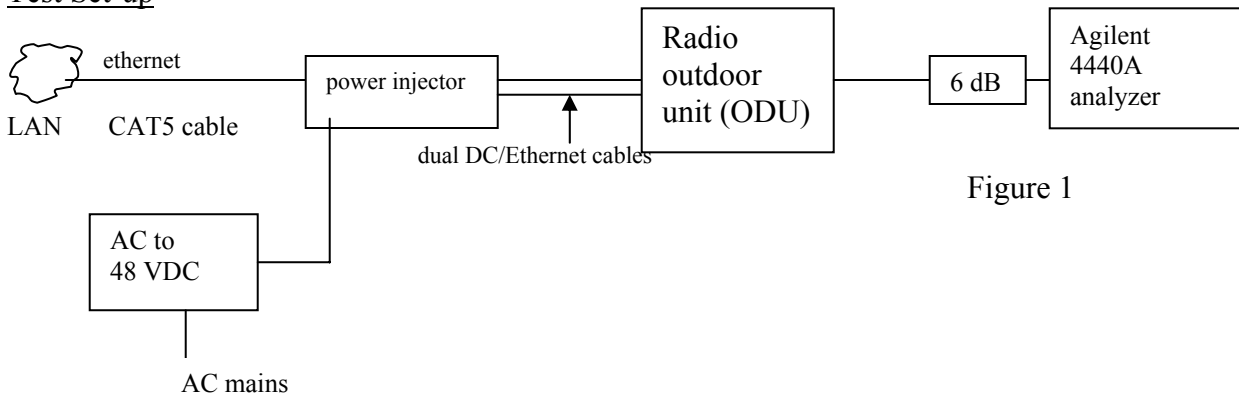

Figure 1

Test Procedure

From Public Notice DA-02 –2138:

- Use a RBW = approximately 1% of the emission bandwidth.
- Set the VBW > RBW. Use a peak detector.
- Do not use the Max Hold function. Rather, use the view button to capture the emission.
- Measure the maximum width of the emission that is 26 dB down from the peak of the emission.
- Compare this with the RBW setting of the analyzer.
- Readjust RBW and repeat measurement as needed until the RBW/EBW ratio is approximately 1%.

Test Results

Refer to spectrum analyzer plots below. On the LOW channel, occupied bandwidth measurements were made for three data rates:

6 Mbps
24 Mbps
54 Mbps

Measurement results (and theory) indicate occupied bandwidth is independent of data rate for this type of OFDM modulation. Occupied bandwidth for MID and HIGH channel were performed at 24 Mbps only.

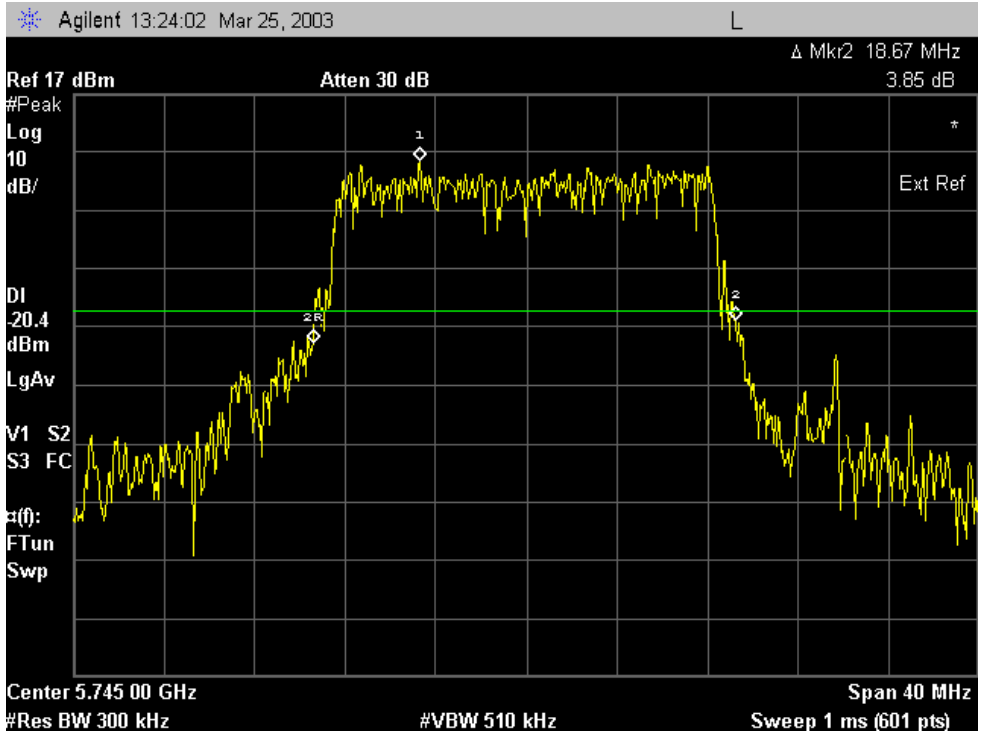

Occupied Bandwidth, 5745 MHz: LOW channel modulation Rate 6 Mbps



Occupied Bandwidth, 5745 MHz: LOW channel
modulation rate 24 Mbps

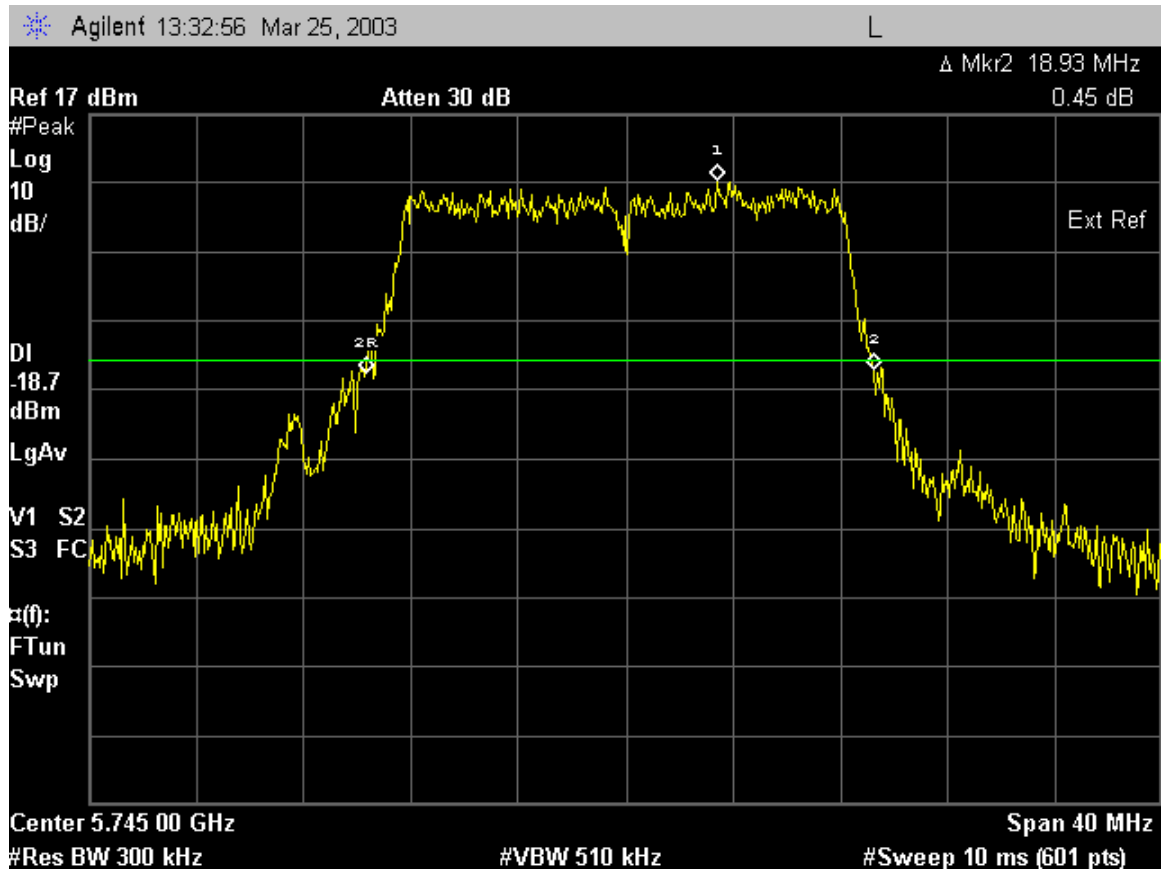

Occupied Bandwidth, 5745 MHz: LOW channel
modulation rate 54 Mbps

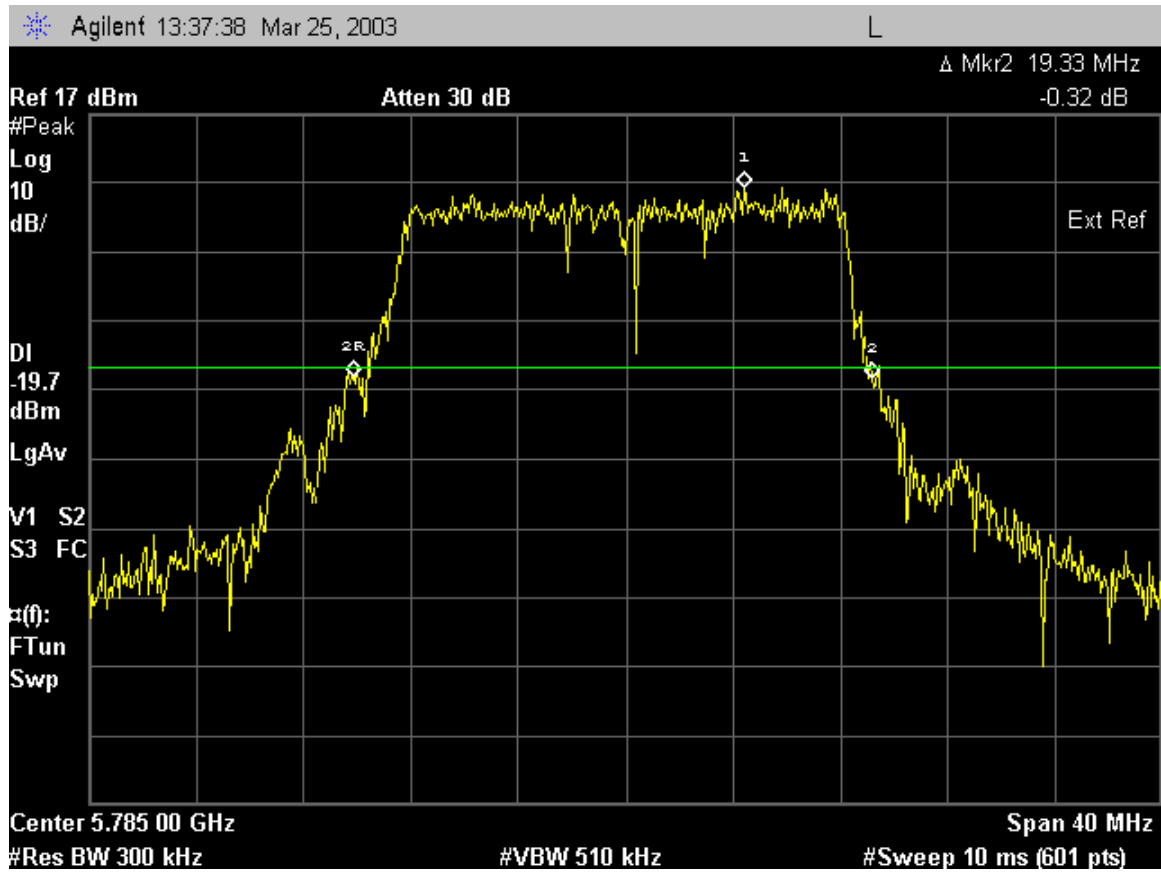

Occupied Bandwidth, 5785 MHz: MID channel
modulation rate 24 Mbps

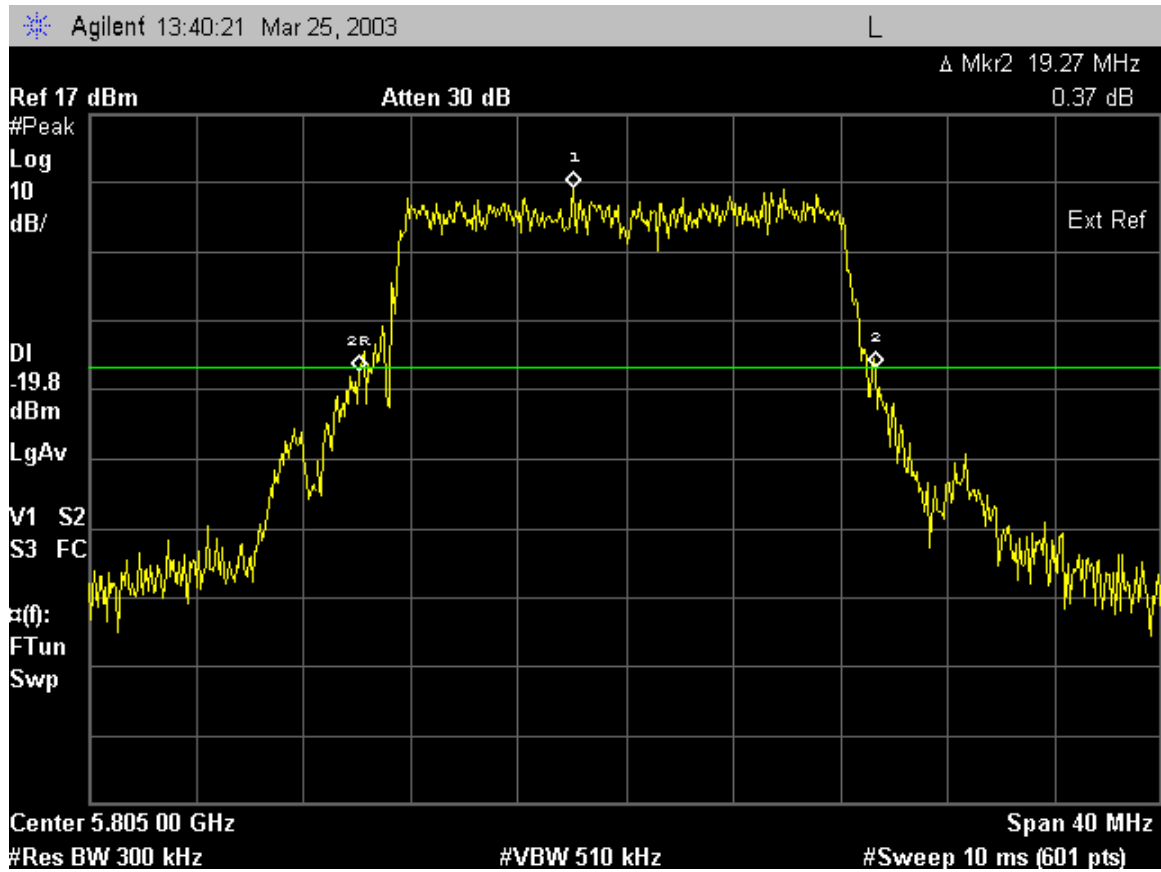

Occupied Bandwidth, 5805 MHz: HIGH channel
modulation rate 24 Mbps

15.407(a) Peak power measurement

Test equipment

Agilent 4440A spectrum analyzer
6 dB attenuator
coaxial cable (1.3 dB loss at 5.8 GHz)

Test Set-up

Refer to Figure 1.

Test limits

15.407(a) (3) For the band 5.725-5.825 GHz, the peak transmit power over the frequency band operation shall not exceed the lesser of 1 W or $17 \text{ dBm} + 10 \log B$, where B is the 26-dB emission bandwidth in MHz. In addition, the peak power spectral density shall not exceed 17 dBm in any 1-MHz band.

The EUT has a 26 dB BW of 19 MHz.
 $P_{\text{max}} = 17 + 10 \log(19) = 29.8 \text{ dBm}$

Test Procedure

Transmitter was placed in continuous transmit test mode. Transmitter is ON for 180 usec with a 3 usec reset OFF time. Duty cycle correction is $20 \log(180/183) = -.14 \text{ dB}$. For reporting purposes, duty cycle correction is considered zero.

Sweep time < T (transmit time) because transmitter is transmitting in continuous mode:

Method 1 from Public Notice DA-02 –2138:

- Set span to encompass the entire emission bandwidth (EBW) of the signal.
- Set RBW = 1 MHz.
- Set VBW \geq 3 MHz.
- Use sample detector mode if bin width (i.e., span/number of points in spectrum display) < 0.5 RBW. Otherwise use peak detector mode
- Use a video trigger with the trigger level set to enable triggering only on full power pulses. Transmitter must operate at full control power for entire sweep of every sweep. If the device transmits continuously, with no off intervals or reduced power intervals, the trigger may be set to “free run”.
- Trace average 100 traces in power averaging mode.
- Compute power by integrating the spectrum across the 26 dB EBW of the signal. The integration can be performed using the spectrum analyzer’s band power measurement function with band limits set equal to the EBW band edges or by summing power levels in each 1 MHz band in linear power terms. The 1 MHz band power levels to be summed can be obtained by averaging, in linear power terms, power levels in each frequency bin across the 1 MHz.

Test Results

Refer to attached spectrum analyzer plots. Power output was independent of data rate.
For transmit antenna gain of 23 dBi or less:

5745 MHz	Low channel:	24.39 dBm	at 54 Mbps
5785 MHz	Mid channel:	23.73 dBm	at 54 Mbps
5805 MHz	High channel:	23.76 dBm	at 54 Mbps

For the dish antenna (gain = 28 dBi) the output power at the LOW and HIGH is lowered so that band edge power spectral density (psd) emissions are compliant:

5745 MHz	Low channel:	21.72 dBm	at 54 Mbps
5805 MHz	High channel:	21.99 dBm	at 54 Mbps

Peak Power LOW channel (for antenna gain 23 dBi or less)

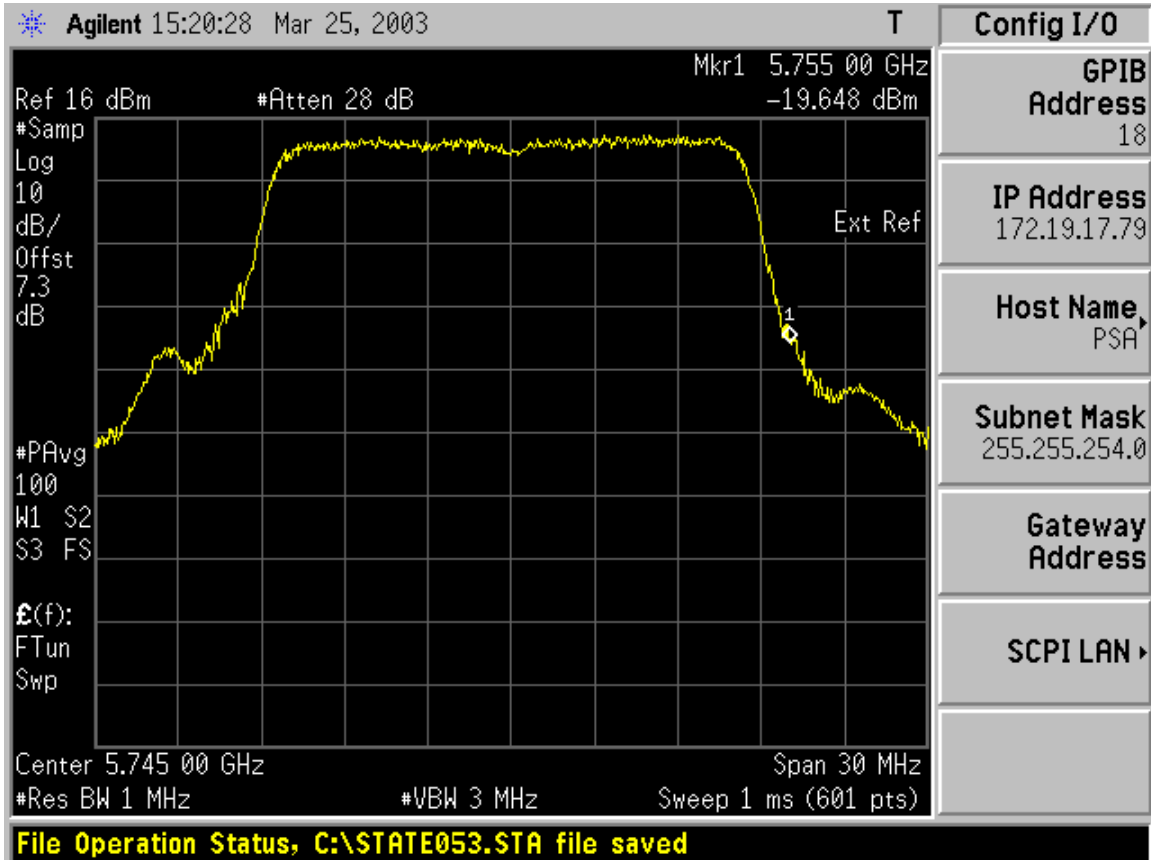

5745 +24 dBm setting 54 Mb/S For Antenna gain 23 dBi or less

Freq = 5735.0 MHz, Ampl = -14.29 dBm, 0.037 mW
Freq = 5736.0 MHz, Ampl = 1.11 dBm, 1.292 mW
Freq = 5737.0 MHz, Ampl = 10.55 dBm, 11.350 mW
Freq = 5738.0 MHz, Ampl = 12.11 dBm, 16.237 mW
Freq = 5739.0 MHz, Ampl = 12.05 dBm, 16.040 mW
Freq = 5740.0 MHz, Ampl = 12.75 dBm, 18.823 mW
Freq = 5741.0 MHz, Ampl = 12.21 dBm, 16.646 mW
Freq = 5742.0 MHz, Ampl = 11.30 dBm, 13.499 mW
Freq = 5743.0 MHz, Ampl = 11.65 dBm, 14.635 mW
Freq = 5744.0 MHz, Ampl = 11.42 dBm, 13.874 mW
Freq = 5745.0 MHz, Ampl = 10.67 dBm, 11.668 mW
Freq = 5746.0 MHz, Ampl = 11.99 dBm, 15.820 mW
Freq = 5747.0 MHz, Ampl = 11.90 dBm, 15.502 mW
Freq = 5748.0 MHz, Ampl = 12.78 dBm, 18.980 mW
Freq = 5749.0 MHz, Ampl = 12.75 dBm, 18.854 mW
Freq = 5750.0 MHz, Ampl = 12.72 dBm, 18.724 mW
Freq = 5751.0 MHz, Ampl = 12.80 dBm, 19.046 mW
Freq = 5752.0 MHz, Ampl = 12.51 dBm, 17.828 mW
Freq = 5753.0 MHz, Ampl = 11.88 dBm, 15.406 mW
Freq = 5754.0 MHz, Ampl = -1.09 dBm, 0.777 mW
Freq = 5755.0 MHz, Ampl = -18.98 dBm, 0.013 mW

Total In Band Power = 24.39 dBm, 275.052 mW

5745 +22 dBm (for ant gain = 29.5 dBi)

Freq = 5735.0 MHz, Ampl	= -17.78 dBm,	0.017 mW
Freq = 5736.0 MHz, Ampl	= -1.88 dBm,	0.649 mW
Freq = 5737.0 MHz, Ampl	= 8.43 dBm,	6.963 mW
Freq = 5738.0 MHz, Ampl	= 9.35 dBm,	8.612 mW
Freq = 5739.0 MHz, Ampl	= 9.91 dBm,	9.799 mW
Freq = 5740.0 MHz, Ampl	= 9.67 dBm,	9.268 mW
Freq = 5741.0 MHz, Ampl	= 9.28 dBm,	8.474 mW
Freq = 5742.0 MHz, Ampl	= 9.44 dBm,	8.780 mW
Freq = 5743.0 MHz, Ampl	= 9.74 dBm,	9.423 mW
Freq = 5744.0 MHz, Ampl	= 8.55 dBm,	7.158 mW
Freq = 5745.0 MHz, Ampl	= 7.76 dBm,	5.965 mW
Freq = 5746.0 MHz, Ampl	= 9.50 dBm,	8.915 mW
Freq = 5747.0 MHz, Ampl	= 8.88 dBm,	7.718 mW
Freq = 5748.0 MHz, Ampl	= 9.51 dBm,	8.941 mW
Freq = 5749.0 MHz, Ampl	= 10.73 dBm,	11.820 mW
Freq = 5750.0 MHz, Ampl	= 9.61 dBm,	9.141 mW
Freq = 5751.0 MHz, Ampl	= 10.05 dBm,	10.109 mW
Freq = 5752.0 MHz, Ampl	= 9.71 dBm,	9.358 mW
Freq = 5753.0 MHz, Ampl	= 8.58 dBm,	7.204 mW
Freq = 5754.0 MHz, Ampl	= -5.23 dBm,	0.300 mW
Freq = 5755.0 MHz, Ampl	= -20.92 dBm,	0.008 mW

Total In Band Power = 21.72 dBm, 148.623 mW

Peak Power MID channel (for antenna gain 23 dBi or less)

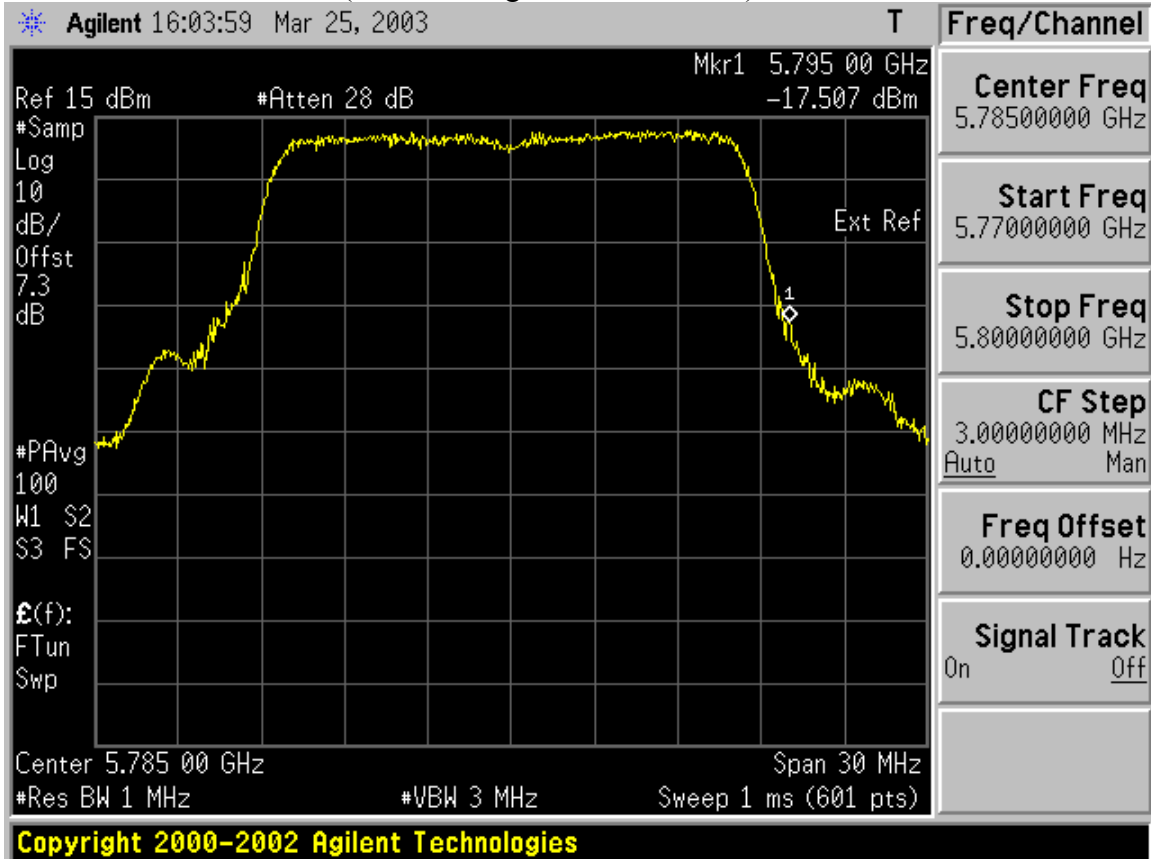

5785 +24 setting 54 Mb/S

For Antenna gain 23 dBi or less

In Band Power

Freq = 5775.0 MHz, Ampl = -14.92 dBm, 0.032 mW
Freq = 5776.0 MHz, Ampl = -0.34 dBm, 0.924 mW
Freq = 5777.0 MHz, Ampl = 10.56 dBm, 11.379 mW
Freq = 5778.0 MHz, Ampl = 9.59 dBm, 9.095 mW
Freq = 5779.0 MHz, Ampl = 11.17 dBm, 13.083 mW
Freq = 5780.0 MHz, Ampl = 11.38 dBm, 13.740 mW
Freq = 5781.0 MHz, Ampl = 11.75 dBm, 14.976 mW
Freq = 5782.0 MHz, Ampl = 10.76 dBm, 11.923 mW
Freq = 5783.0 MHz, Ampl = 11.28 dBm, 13.431 mW
Freq = 5784.0 MHz, Ampl = 11.45 dBm, 13.973 mW
Freq = 5785.0 MHz, Ampl = 9.98 dBm, 9.945 mW
Freq = 5786.0 MHz, Ampl = 12.48 dBm, 17.709 mW
Freq = 5787.0 MHz, Ampl = 11.64 dBm, 14.581 mW
Freq = 5788.0 MHz, Ampl = 11.62 dBm, 14.518 mW
Freq = 5789.0 MHz, Ampl = 12.35 dBm, 17.183 mW
Freq = 5790.0 MHz, Ampl = 12.45 dBm, 17.575 mW
Freq = 5791.0 MHz, Ampl = 12.00 dBm, 15.860 mW
Freq = 5792.0 MHz, Ampl = 11.38 dBm, 13.725 mW
Freq = 5793.0 MHz, Ampl = 10.75 dBm, 11.882 mW
Freq = 5794.0 MHz, Ampl = -2.21 dBm, 0.601 mW
Freq = 5795.0 MHz, Ampl = -17.51 dBm, 0.018 mW

Total In Band Power = 23.73 dBm, 236.154 mW

Peak Power HIGH channel(for antenna gain 23 dBi or less)

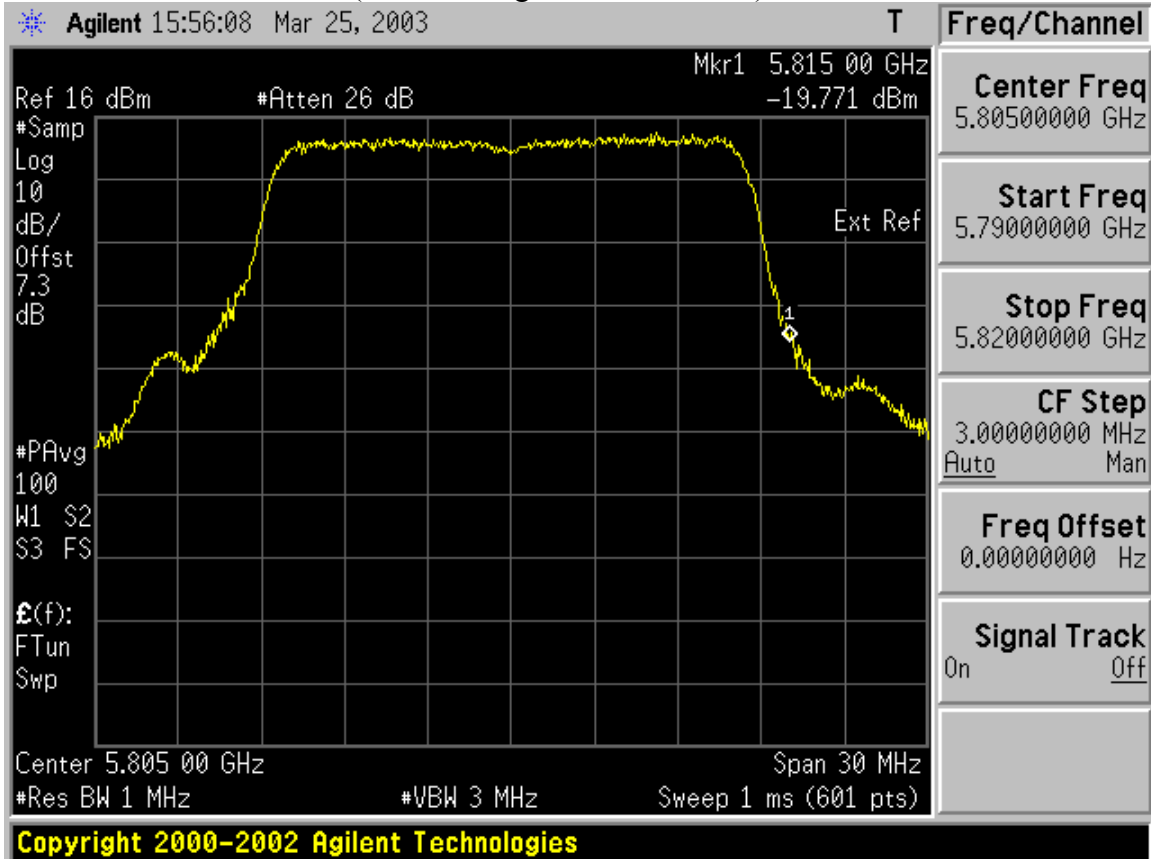

5805 +24 dBm setting 54 Mb/S For Antenna gain 23 dBi or less

In Band Power:

Freq = 5795.0 MHz, Ampl = -16.14 dBm, 0.024 mW
Freq = 5796.0 MHz, Ampl = -0.01 dBm, 0.997 mW
Freq = 5797.0 MHz, Ampl = 10.58 dBm, 11.421 mW
Freq = 5798.0 MHz, Ampl = 11.20 dBm, 13.176 mW
Freq = 5799.0 MHz, Ampl = 10.87 dBm, 12.229 mW
Freq = 5800.0 MHz, Ampl = 11.79 dBm, 15.097 mW
Freq = 5801.0 MHz, Ampl = 11.89 dBm, 15.460 mW
Freq = 5802.0 MHz, Ampl = 11.30 dBm, 13.487 mW
Freq = 5803.0 MHz, Ampl = 11.12 dBm, 12.942 mW
Freq = 5804.0 MHz, Ampl = 11.46 dBm, 13.980 mW
Freq = 5805.0 MHz, Ampl = 9.87 dBm, 9.701 mW
Freq = 5806.0 MHz, Ampl = 11.69 dBm, 14.767 mW
Freq = 5807.0 MHz, Ampl = 11.18 dBm, 13.125 mW
Freq = 5808.0 MHz, Ampl = 11.99 dBm, 15.802 mW
Freq = 5809.0 MHz, Ampl = 11.98 dBm, 15.765 mW
Freq = 5810.0 MHz, Ampl = 12.57 dBm, 18.072 mW
Freq = 5811.0 MHz, Ampl = 12.01 dBm, 15.900 mW
Freq = 5812.0 MHz, Ampl = 11.59 dBm, 14.418 mW
Freq = 5813.0 MHz, Ampl = 10.22 dBm, 10.520 mW
Freq = 5814.0 MHz, Ampl = -2.10 dBm, 0.617 mW
Freq = 5815.0 MHz, Ampl = -19.77 dBm, 0.011 mW

Total In Band Power = 23.76 dBm, 237.510 mW

5805 MHz, +22 dBm (for ant gain = 29.5 dBi) 54 Mb/S

Freq = 5795.0 MHz, Ampl	= -14.92 dBm,	0.032 mW
Freq = 5796.0 MHz, Ampl	= -2.25 dBm,	0.595 mW
Freq = 5797.0 MHz, Ampl	= 8.79 dBm,	7.575 mW
Freq = 5798.0 MHz, Ampl	= 8.99 dBm,	7.923 mW
Freq = 5799.0 MHz, Ampl	= 9.39 dBm,	8.680 mW
Freq = 5800.0 MHz, Ampl	= 9.78 dBm,	9.510 mW
Freq = 5801.0 MHz, Ampl	= 10.36 dBm,	10.867 mW
Freq = 5802.0 MHz, Ampl	= 9.76 dBm,	9.460 mW
Freq = 5803.0 MHz, Ampl	= 9.86 dBm,	9.681 mW
Freq = 5804.0 MHz, Ampl	= 9.56 dBm,	9.032 mW
Freq = 5805.0 MHz, Ampl	= 7.39 dBm,	5.478 mW
Freq = 5806.0 MHz, Ampl	= 10.27 dBm,	10.634 mW
Freq = 5807.0 MHz, Ampl	= 9.79 dBm,	9.519 mW
Freq = 5808.0 MHz, Ampl	= 9.76 dBm,	9.456 mW
Freq = 5809.0 MHz, Ampl	= 10.30 dBm,	10.708 mW
Freq = 5810.0 MHz, Ampl	= 10.78 dBm,	11.962 mW
Freq = 5811.0 MHz, Ampl	= 9.56 dBm,	9.030 mW
Freq = 5812.0 MHz, Ampl	= 9.62 dBm,	9.164 mW
Freq = 5813.0 MHz, Ampl	= 9.33 dBm,	8.568 mW
Freq = 5814.0 MHz, Ampl	= -4.17 dBm,	0.383 mW
Freq = 5815.0 MHz, Ampl	= -21.60 dBm,	0.007 mW

Total In Band Power = 21.99 dBm, 158.265 mW

15.407(a)5 Peak power spectral density measurement

Test equipment

Agilent 4440A spectrum analyzer
6 dB attenuator
coaxial cable (1.3 dB loss at 5.8 GHz)

Test Set-up

Refer to Figure 1.

Test limits

17 dBm/MHz

Test Procedures

From Public Notice DA-02 –2138:

Method 2:

Use sample detector and power averaging (not video averaging) mode.
Set RBW= 1 MHz*, VBW > 1 MHz. The PPSD is the highest level found across the emission in any 1-MHz band after 100 sweeps of averaging. This method is permitted only if the transmission pulse or sequence of pulses remains at maximum transmit power throughout each of the 100 sweeps of averaging and that the interval between pulses is not included in any of the sweeps (e.g., 100 sweeps should occur during one transmission, or each sweep gated to occur during a transmission).

* It is permissible to use a resolution bandwidth less than the measurement bandwidth provided the measured power is integrated to show total power over the measurement bandwidth. The integration can be performed using the spectrum analyzer's band power measurement function with band limits set equal to the measurement band edges or by summing power levels in each band in linear power terms.

Transmitter was placed in continuous transmit test mode. Transmitter is ON for 180 usec with a 3 usec reset OFF time. Duty cycle correction is $20 \log(180/183) = -.14$ dB, For reporting purposes, duty cycle correction is considered zero.

Test Results

Refer to spectrum analyzer plots below.

Highest measured PSD : 13.83 dBm

PSD was essentially independent of data rate.

PSD, LOW channel, 6 Mbps

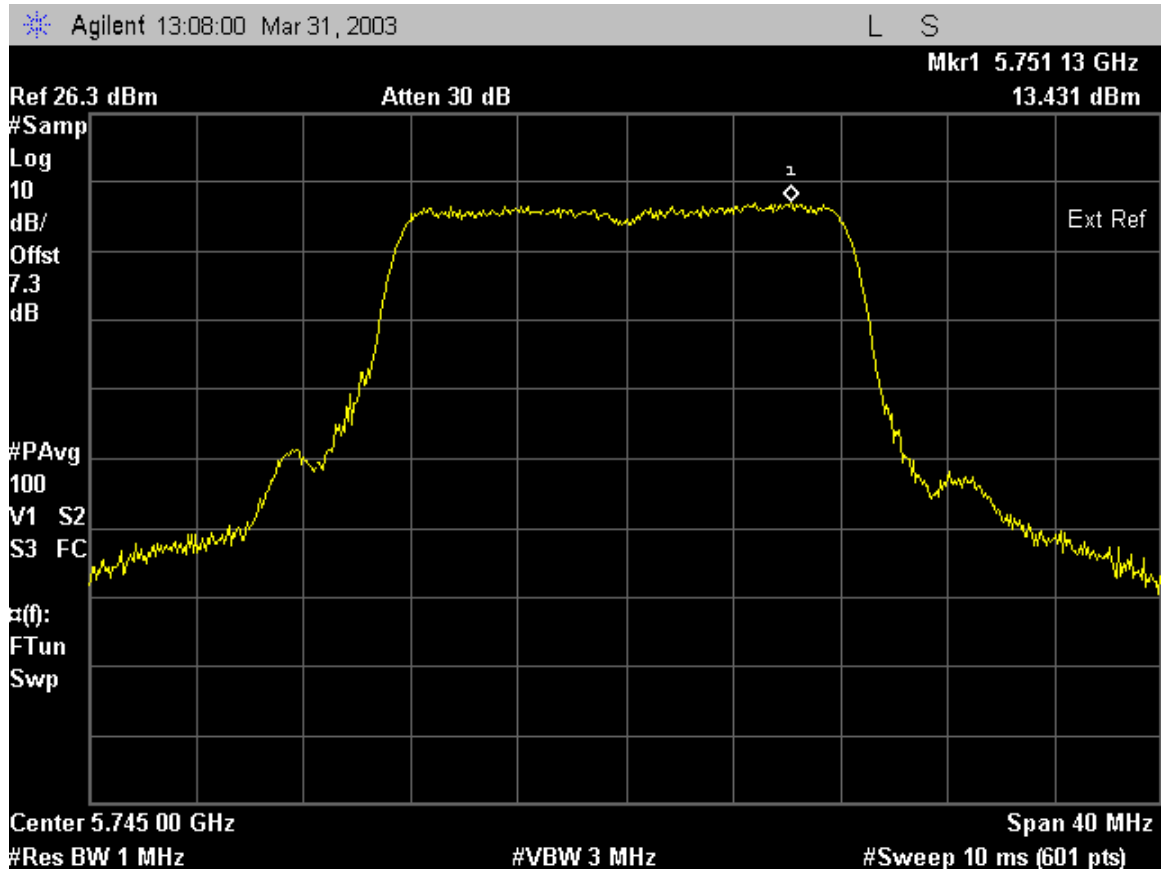

PSD, LOW channel, 24 Mbps

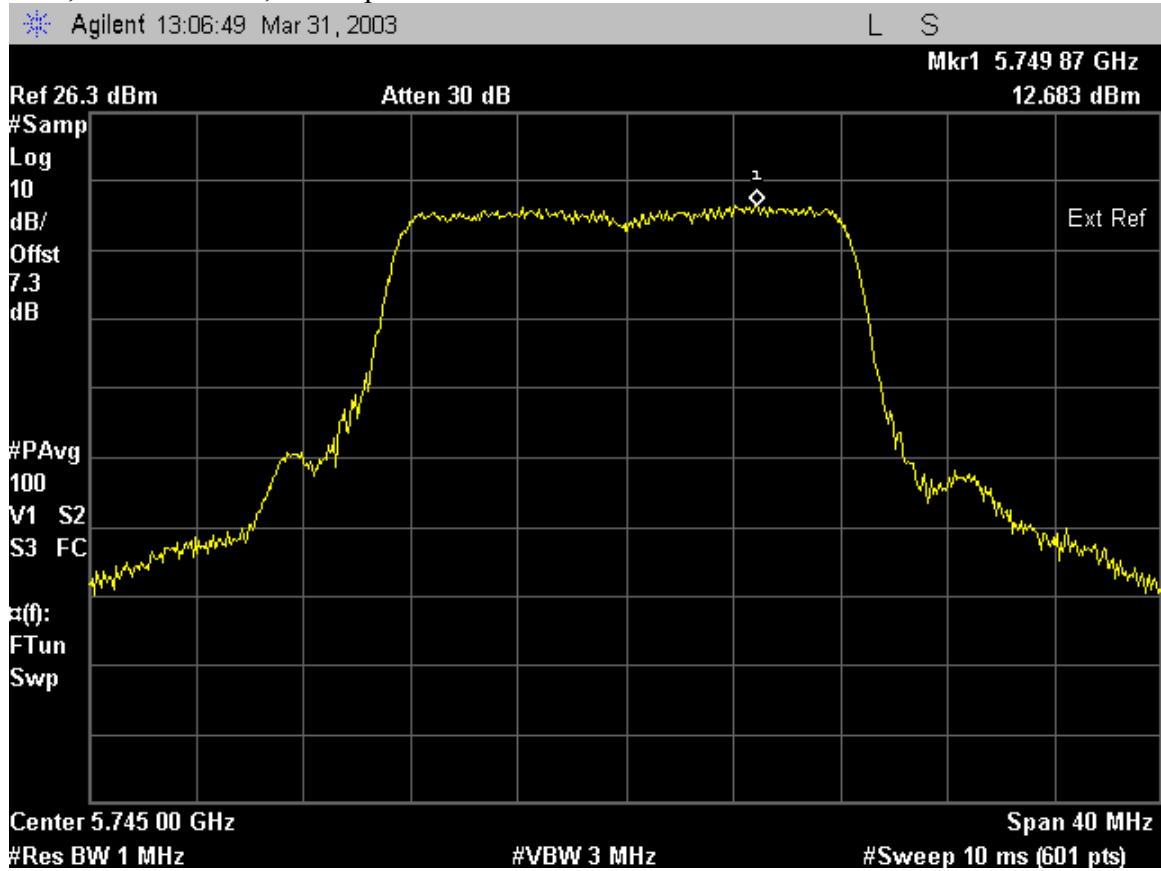

PSD, LOW channel, 54 Mbps

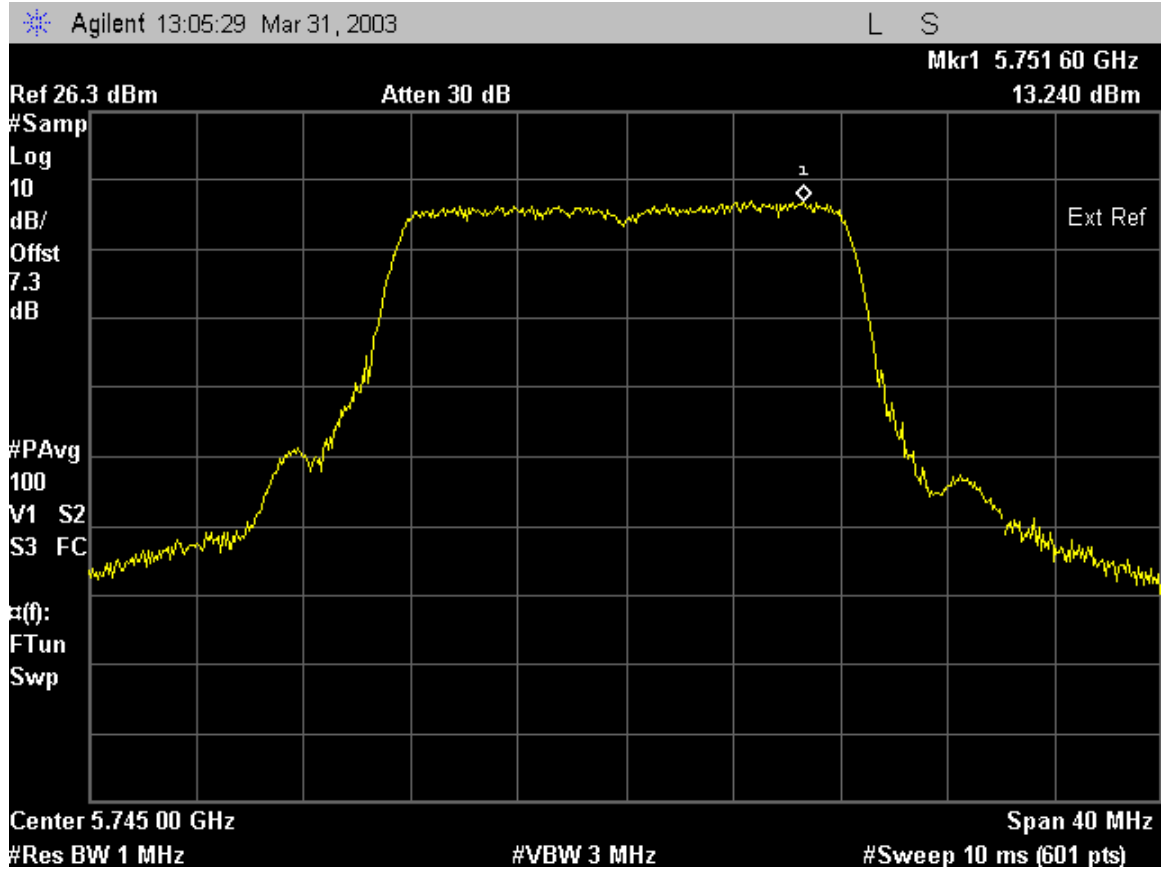

PSD, MID channel, 6 Mbps

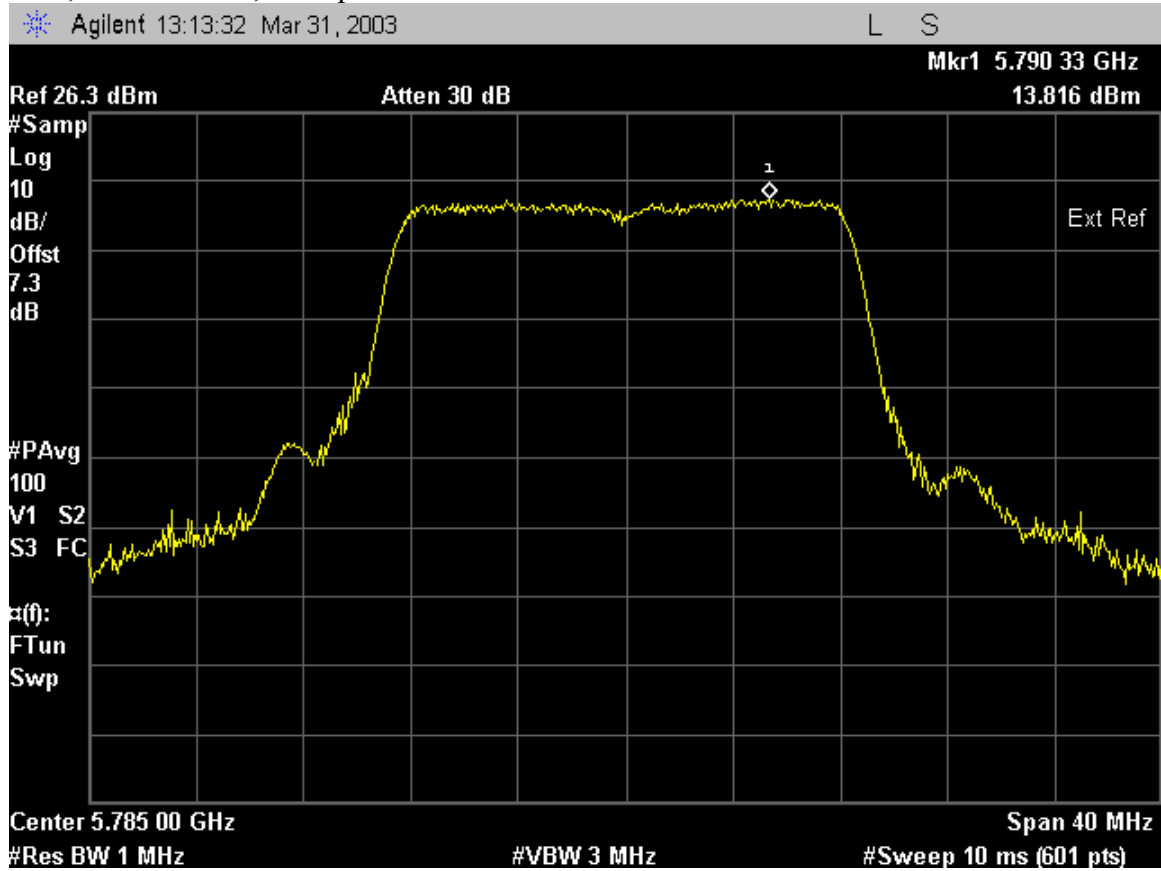

PSD, MID channel, 54 Mbps

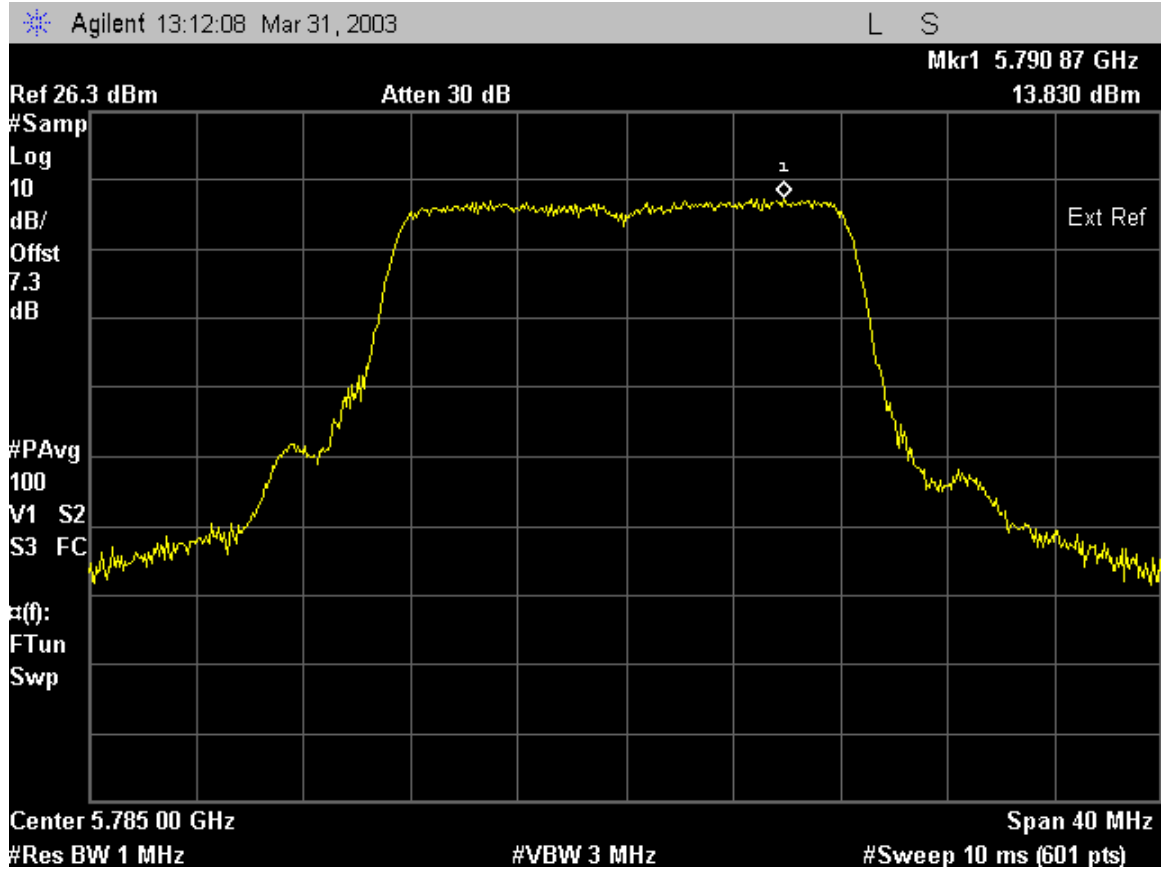

PSD, HIGH channel, 6 Mbps

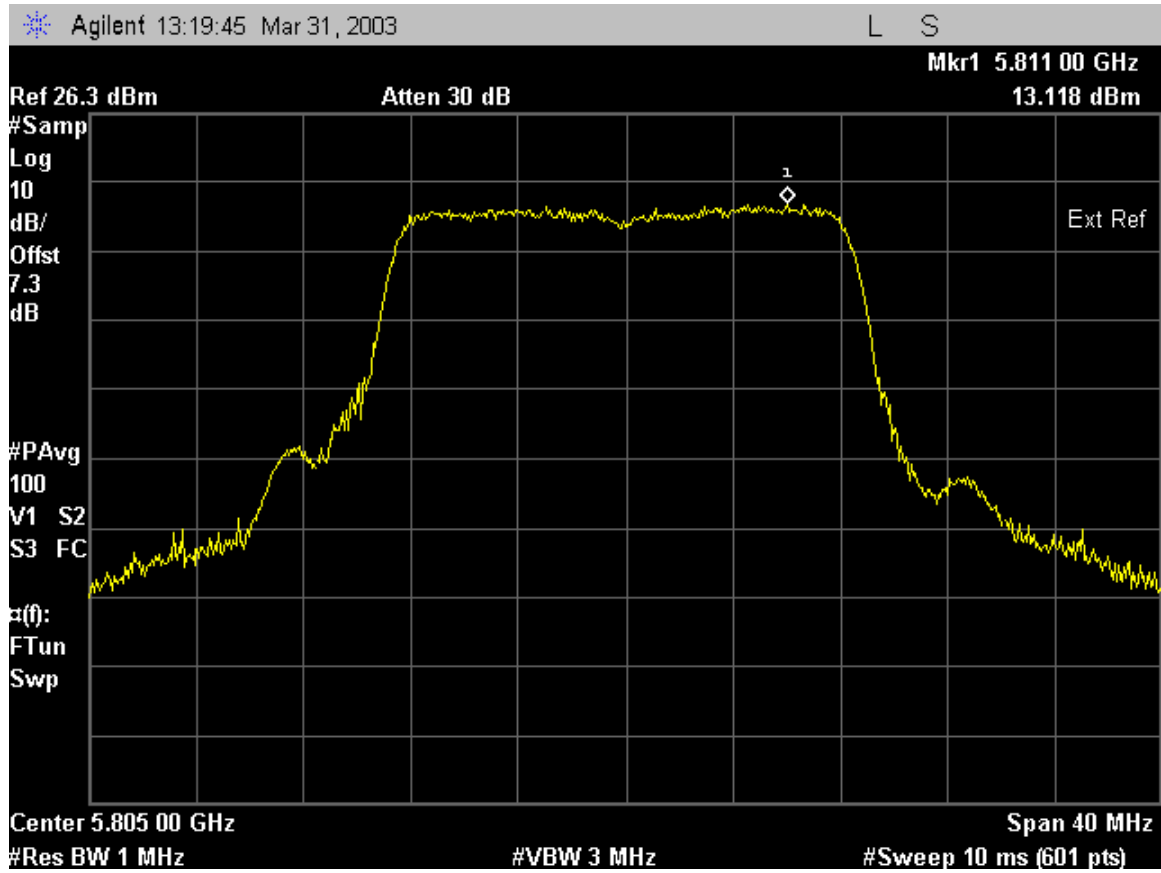

PSD, HIGH channel, 54 Mbps

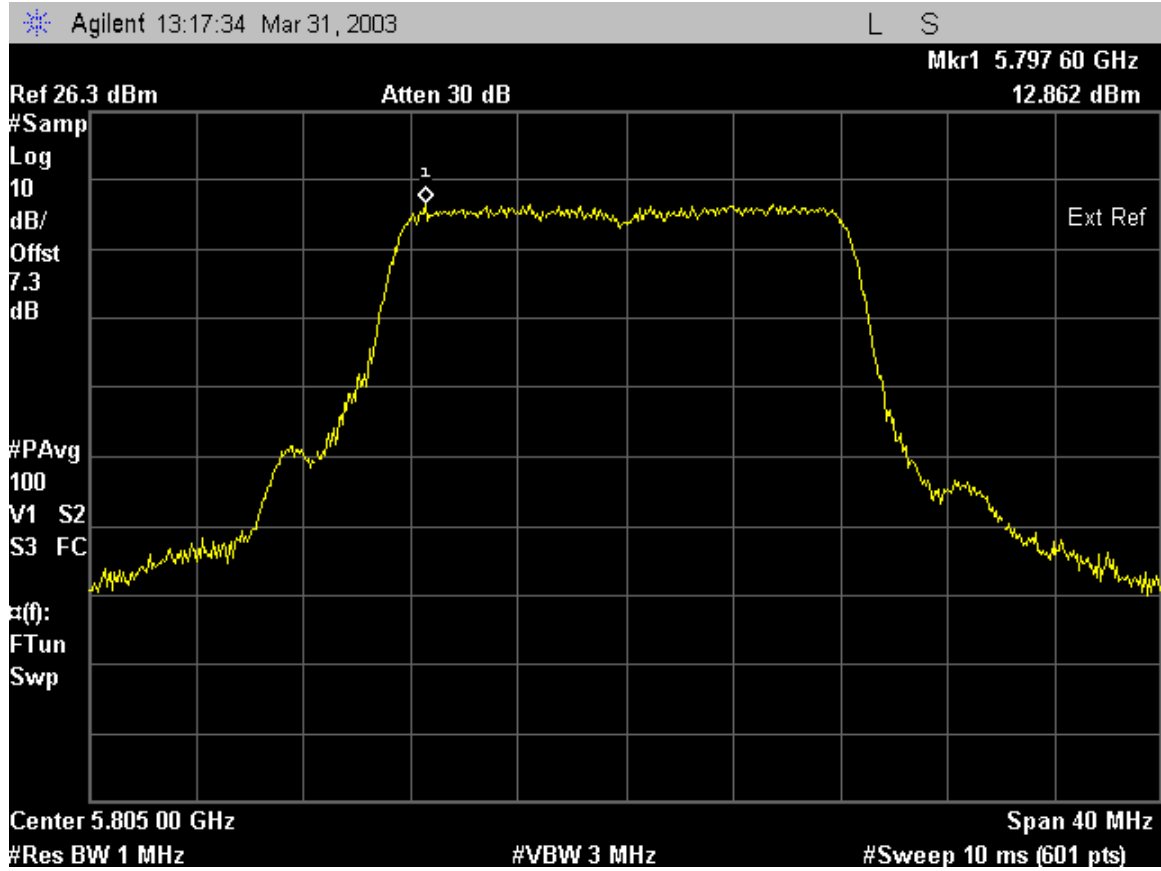

15.407(b)3 Unwanted emissions, psd at band edge

Test equipment

Agilent 4440A spectrum analyzer
6 dB attenuator
coaxial cable (1.3 dB loss at 5.8 GHz)

Test Set-up

Refer to Figure 1.

Test limits

5715-5725 MHz:	-17 dBm/MHz EIRP	-40 dBm into 23 dBi antenna -45 dBm into 29.5 dBi antenna
below 5715 MHz:	-27 dBm/MHz EIRP	-50 dBm into 23 dBi antenna -55 dBm into 29.5 dBi antenna
5825-5835 MHz:	-17 dBm/MHz EIRP	-40 dBm into 23 dBi antenna -45 dBm into 29.5 dBi antenna
Above 5835 MHz:	-27 dBm/MHz EIRP	-50 dBm into 23 dBi antenna -55 dBm into 29.5 dBi antenna

Test Procedures

The TCB Guidance document allows the same instrument setting to be used for unwanted emissions psd as are called out for in band psd measurements.

From Public Notice DA-02 –2138:

Method 2:

Use sample detector and power averaging (not video averaging) mode.

* It is permissible to use a resolution bandwidth less than the measurement bandwidth provided the measured power is integrated to show total power over the measurement bandwidth. The integration can be performed using the spectrum analyzer's band power measurement function with band limits set equal to the measurement band edges or by summing power levels in each band in linear power terms.

Transmitter was placed in continuous transmit test mode. Transmitter is ON for 180 usec with a 3 usec reset OFF time. Duty cycle correction is $20 \log(180/183) = -.14$ dB, For reporting purposes, duty cycle correction is considered zero.

Resolution bandwidth was set to 100 kHz. Ten separate measurements were taken and the individual powers were summed to determine the power in 1 MHz bandwidth at the following frequencies:

5715 MHz and 5725 MHz for operation at 5745 MHz (LOW channel)
5825 MHz and 5835 MHz for operation at 5805 MHz (HIGH channel)

Test Results

Refer to attached spectrum analyzer plots and tabular data. Two sets of data are presented, the first for antennas with gains of 23 dBi or less, the second for the 29.5 dBi dish antenna with the transmitter operating at reduced power (22 dBm).

Band edge Emissions for LOW channel (5745 MHz) (for antenna gain 23 dBi or less)

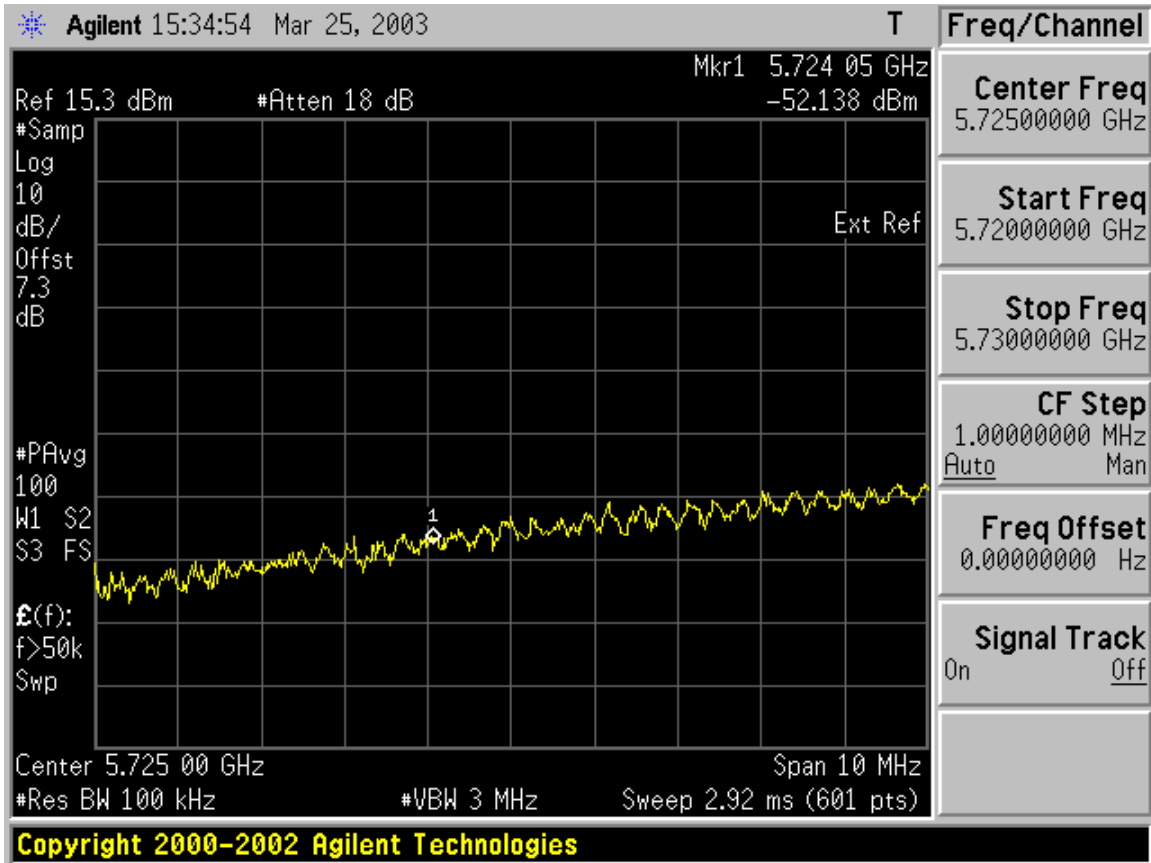

Freq = 5724.95 MHz,	Ampl = -48.81 dBm,	0.000013161 mW
Freq = 5724.85 MHz,	Ampl = -50.64 dBm,	0.000008624 mW
Freq = 5724.75 MHz,	Ampl = -50.67 dBm,	0.000008568 mW
Freq = 5724.65 MHz,	Ampl = -50.13 dBm,	0.000009714 mW
Freq = 5724.55 MHz,	Ampl = -51.84 dBm,	0.000006540 mW
Freq = 5724.45 MHz,	Ampl = -51.63 dBm,	0.000006875 mW
Freq = 5724.35 MHz,	Ampl = -51.62 dBm,	0.000006893 mW
Freq = 5724.25 MHz,	Ampl = -51.33 dBm,	0.000007360 mW
Freq = 5724.15 MHz,	Ampl = -52.87 dBm,	0.000005170 mW
Freq = 5724.05 MHz,	Ampl = -52.14 dBm,	0.000006112 mW

Power at 5725 MHz in 1 MHz bandwidth (sum of readings above)

Freq = 5725.0 MHz, Ampl = -41.02 dBm
 Limit = -40.00 dBm for 23 dBi antenna (-40 + 23 = -17 dBm EIRP)

P out = 22 dBm

Freq = 5724.95 MHz, Ampl	= -54.46 dBm,	0.000003583 mW
Freq = 5724.85 MHz, Ampl	= -57.50 dBm,	0.000001780 mW
Freq = 5724.75 MHz, Ampl	= -57.00 dBm,	0.000001997 mW
Freq = 5724.65 MHz, Ampl	= -56.09 dBm,	0.000002460 mW
Freq = 5724.55 MHz, Ampl	= -58.54 dBm,	0.000001400 mW
Freq = 5724.45 MHz, Ampl	= -58.04 dBm,	0.000001570 mW
Freq = 5724.35 MHz, Ampl	= -57.73 dBm,	0.000001686 mW
Freq = 5724.25 MHz, Ampl	= -58.72 dBm,	0.000001342 mW
Freq = 5724.15 MHz, Ampl	= -59.64 dBm,	0.000001087 mW
Freq = 5724.05 MHz, Ampl	= -57.32 dBm,	0.000001853 mW

Power at 5725 MHz in 1 MHz bandwidth (sum of readings above)

Freq = 5725.0 MHz, Ampl = -47.27 dBm
Limit = -46.5dBm for 29.5 dBi antenna(-46.5+29.5 = -17 dBm EIRP)

Band edge Emissions for LOW channel (5745 MHz) (for antenna gain 23 dBi or less)

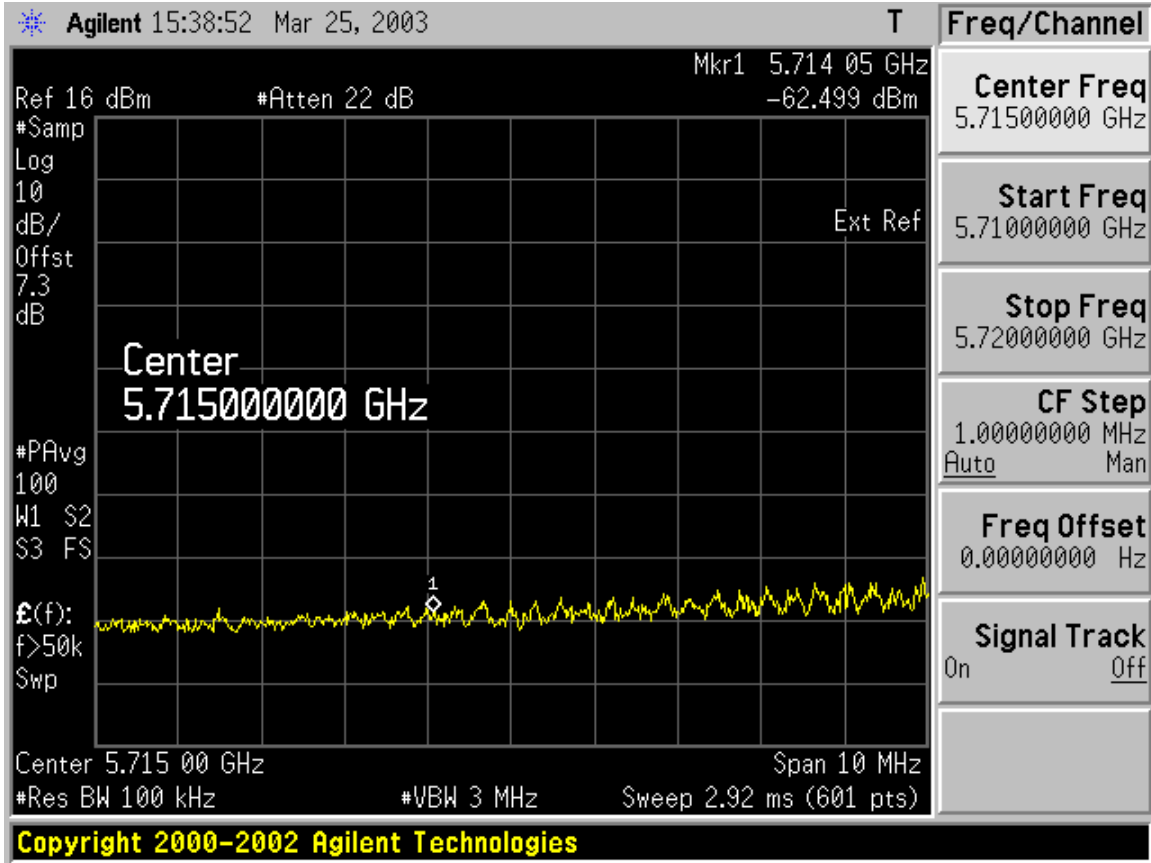

Freq	Ampl	Power
5714.95 MHz	-61.34 dBm	0.000000735 mW
5714.85 MHz	-63.83 dBm	0.000000414 mW
5714.75 MHz	-62.53 dBm	0.000000558 mW
5714.65 MHz	-61.16 dBm	0.000000765 mW
5714.55 MHz	-62.29 dBm	0.000000590 mW
5714.45 MHz	-63.32 dBm	0.000000466 mW
5714.35 MHz	-61.91 dBm	0.000000644 mW
5714.25 MHz	-62.62 dBm	0.000000547 mW
5714.15 MHz	-63.57 dBm	0.000000440 mW
5714.05 MHz	-61.79 dBm	0.000000662 mW

Power at 5715 MHz in 1 MHz bandwidth (sum of readings above)

Freq = 5715.0 MHz, Ampl = -52.35 dBm
 Limit = -50.00 dBm for 23 dBi antenna (-50 + 23 = -27 dBm EIRP)

P out = 22 dBm

Freq = 5714.95 MHz, Ampl	= -68.72 dBm,	0.000000134 mW
Freq = 5714.85 MHz, Ampl	= -68.94 dBm,	0.000000128 mW
Freq = 5714.75 MHz, Ampl	= -68.36 dBm,	0.000000146 mW
Freq = 5714.65 MHz, Ampl	= -68.95 dBm,	0.000000127 mW
Freq = 5714.55 MHz, Ampl	= -68.80 dBm,	0.000000132 mW
Freq = 5714.45 MHz, Ampl	= -68.80 dBm,	0.000000132 mW
Freq = 5714.35 MHz, Ampl	= -68.88 dBm,	0.000000129 mW
Freq = 5714.25 MHz, Ampl	= -68.75 dBm,	0.000000133 mW
Freq = 5714.15 MHz, Ampl	= -68.03 dBm,	0.000000157 mW
Freq = 5714.05 MHz, Ampl	= -68.87 dBm,	0.000000130 mW

Power at 5715 MHz in 1 MHz bandwidth (sum of readings above)

Freq = 5715.0 MHz, Ampl = -58.70 dBm
(Limit = -57.5 dBm for 29.5 dBi antenna (-56.5 + 29.5 = -27 dBm EIRP))

Band edge Emissions for HIGH channel (5805 MHz) (for antenna gain 23 dBi or less)

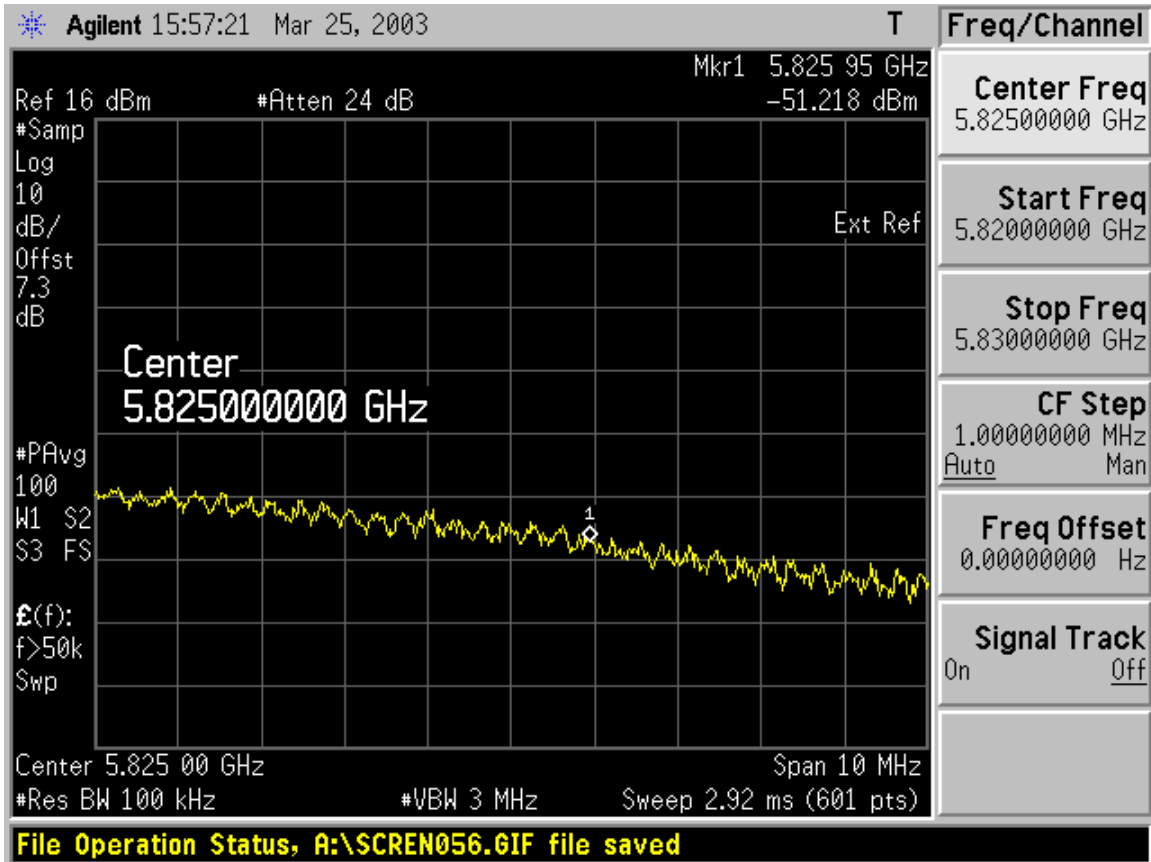

Freq = 5825.05 MHz,	Ampl = -49.50 dBm,	0.000011220 mW
Freq = 5825.15 MHz,	Ampl = -50.79 dBm,	0.000008339 mW
Freq = 5825.25 MHz,	Ampl = -49.10 dBm,	0.000012291 mW
Freq = 5825.35 MHz,	Ampl = -51.70 dBm,	0.000006767 mW
Freq = 5825.45 MHz,	Ampl = -51.67 dBm,	0.000006814 mW
Freq = 5825.55 MHz,	Ampl = -49.85 dBm,	0.000010351 mW
Freq = 5825.65 MHz,	Ampl = -49.58 dBm,	0.000011013 mW
Freq = 5825.75 MHz,	Ampl = -52.33 dBm,	0.000005845 mW
Freq = 5825.85 MHz,	Ampl = -52.21 dBm,	0.000006013 mW
Freq = 5825.95 MHz,	Ampl = -51.22 dBm,	0.000007554 mW

Power at 5825 MHz in 1 MHz bandwidth (sum of readings above)

Freq = 5825.0 MHz, Ampl = -40.64 dBm
 Limit = -40.00 dBm for 23 dBi antenna (-40 + 23 = -17 dBm EIRP)

Pout = 22 dBm

Freq = 5825.05 MHz,	Ampl = -56.00 dBm,	0.000002511 mW
Freq = 5825.15 MHz,	Ampl = -56.25 dBm,	0.000002374 mW
Freq = 5825.25 MHz,	Ampl = -54.87 dBm,	0.000003256 mW
Freq = 5825.35 MHz,	Ampl = -56.83 dBm,	0.000002076 mW
Freq = 5825.45 MHz,	Ampl = -57.98 dBm,	0.000001593 mW
Freq = 5825.55 MHz,	Ampl = -55.33 dBm,	0.000002934 mW
Freq = 5825.65 MHz,	Ampl = -57.12 dBm,	0.000001940 mW
Freq = 5825.75 MHz,	Ampl = -58.21 dBm,	0.000001511 mW
Freq = 5825.85 MHz,	Ampl = -57.41 dBm,	0.000001817 mW
Freq = 5825.95 MHz,	Ampl = -57.28 dBm,	0.000001873 mW

Freq = 5825.0 MHz, Ampl = -46.60 dBm

Limit = -46.5 dBm (46.5 dbm + 29.5 = -17 dBm EIRP)

Band edge Emissions for HIGH channel (5805MHz) (for antenna gain 23 dBi or less)

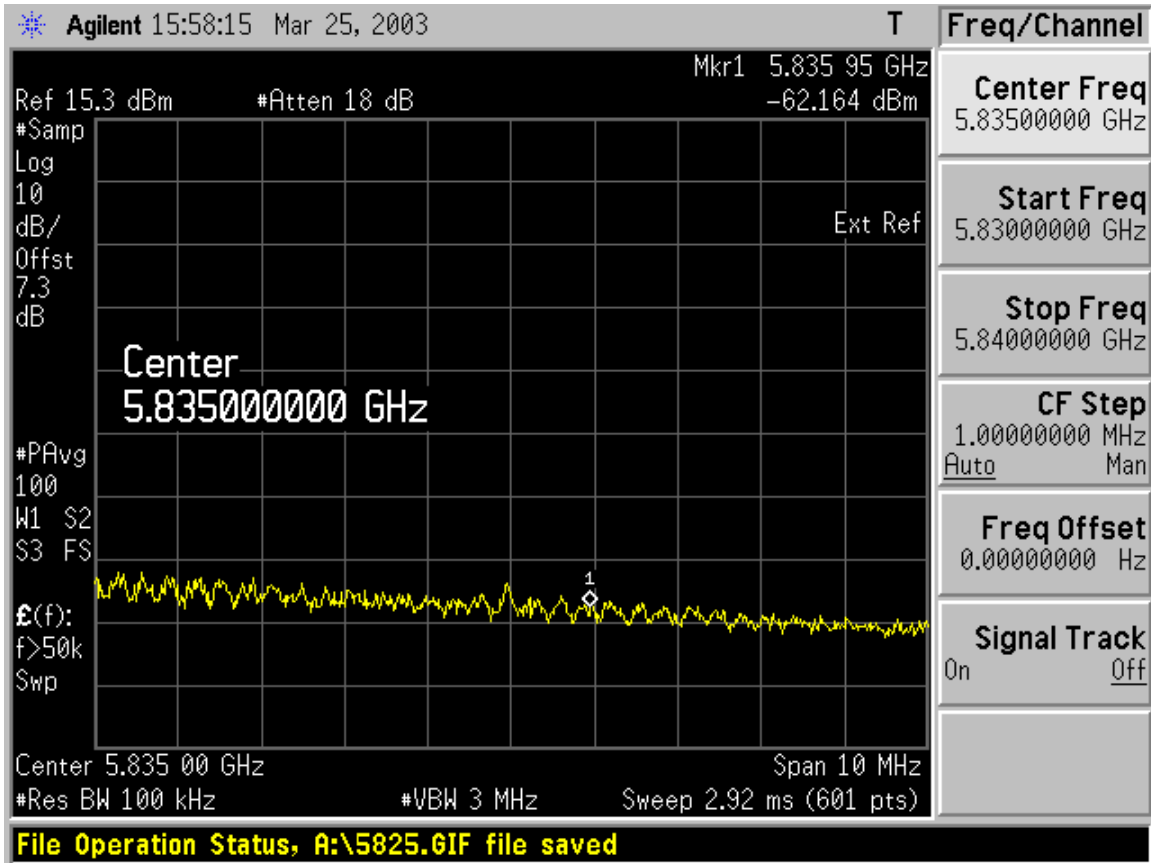

Freq	Ampl	Power
5835.05 MHz	-62.46 dBm	0.000000567 mW
5835.15 MHz	-62.00 dBm	0.000000631 mW
5835.25 MHz	-62.91 dBm	0.000000511 mW
5835.35 MHz	-63.06 dBm	0.000000494 mW
5835.45 MHz	-64.44 dBm	0.000000360 mW
5835.55 MHz	-61.71 dBm	0.000000675 mW
5835.65 MHz	-61.56 dBm	0.000000698 mW
5835.75 MHz	-64.69 dBm	0.000000339 mW
5835.85 MHz	-62.34 dBm	0.000000584 mW
5835.95 MHz	-62.16 dBm	0.000000608 mW

Power at 5835 MHz in 1 MHz bandwidth (sum of readings above)

Freq = 5835.0 MHz, Ampl = -52.62 dBm
 Limit = -50.00 dBm for 23 dBi antenna (-50 + 23 = -27 dBm EIRP)

Pout =22 dBm

Freq = 5835.05 MHz, Ampl	= -68.78 dBm,	0.000000133 mW
Freq = 5835.15 MHz, Ampl	= -70.89 dBm,	0.000000081 mW
Freq = 5835.25 MHz, Ampl	= -70.22 dBm,	0.000000095 mW
Freq = 5835.35 MHz, Ampl	= -70.02 dBm,	0.000000099 mW
Freq = 5835.45 MHz, Ampl	= -70.23 dBm,	0.000000095 mW
Freq = 5835.55 MHz, Ampl	= -70.83 dBm,	0.000000083 mW
Freq = 5835.65 MHz, Ampl	= -70.02 dBm,	0.000000100 mW
Freq = 5835.75 MHz, Ampl	= -69.48 dBm,	0.000000113 mW
Freq = 5835.85 MHz, Ampl	= -70.35 dBm,	0.000000092 mW
Freq = 5835.95 MHz, Ampl	= -69.66 dBm,	0.000000108 mW

Freq = 5835.0 MHz, Ampl = -60.01 dBm

Limit = -56.5 dBm for 29.5 dBi antenna (-56.5 + 29.5 = -27 dBm EIRP)

15.407(a)6 Peak excursion

Test equipment

Agilent 4440A spectrum analyzer
6 dB attenuator
coaxial cable (1.3 dB loss at 5.8 GHz)

Test Set-up

Refer to Figure 1.

Test limits

13 dB maximum

Test Procedures

From Public Notice DA-02 –2138

Set the spectrum analyzer span to view the entire emission bandwidth. The largest difference between the following two traces must be ≤ 13 dB for all frequencies across the emission bandwidth. Submit a plot.

1st Trace:

- Set RBW = 1 MHz, VBW ≥ 3 MHz with peak detector and maxhold settings.

2nd Trace:

- If Method #1 was used for the peak conducted transmit output power test, then create the 2nd trace using the settings described in Method #1.

Test Results

Refer to attached spectrum analyzer plots.

Worst case peak excursion: 12.6 dB

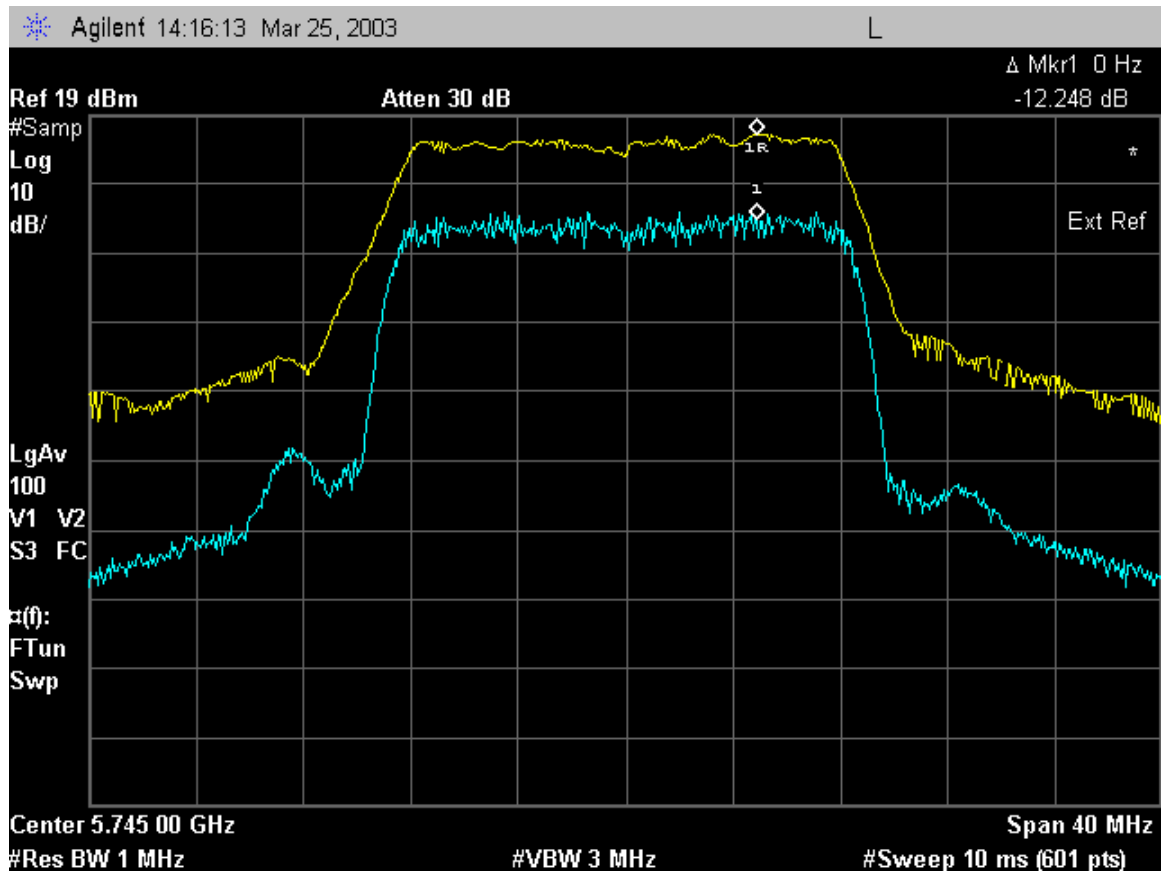

Peak Excursion 5745 MHz LOW channel
modulation rate 54 Mbps

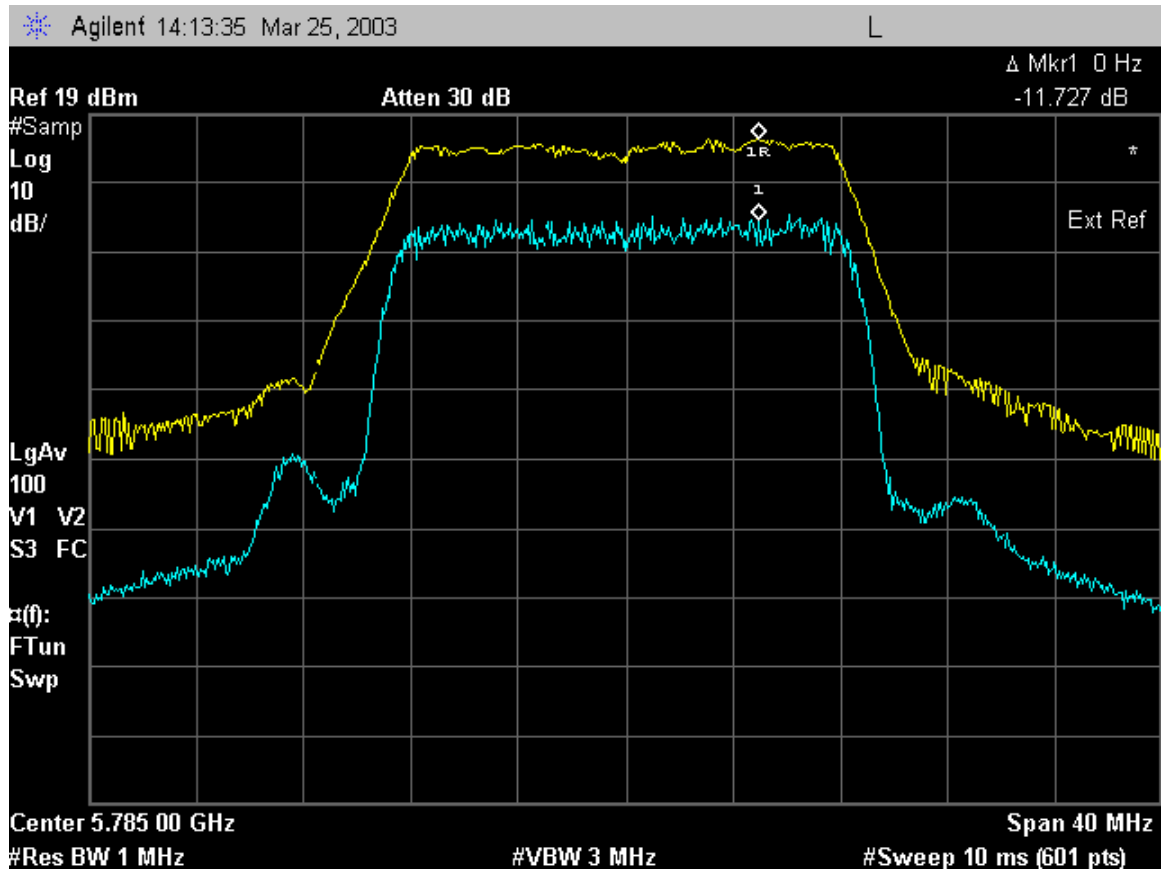

Peak Excursion 5785 MHz MID channel
modulation rate 54 Mbps

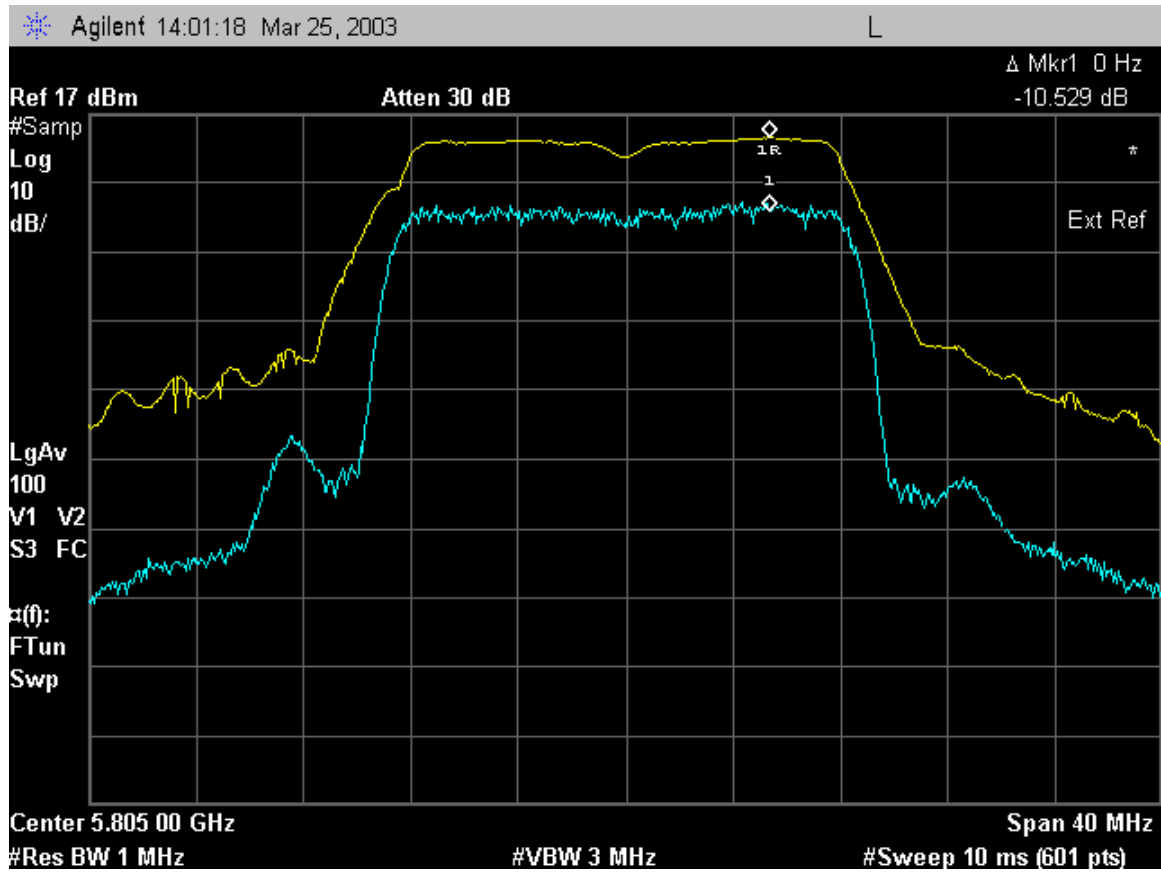

Peak Excursion 5805 MHz HIGH channel
modulation rate 6 Mbps

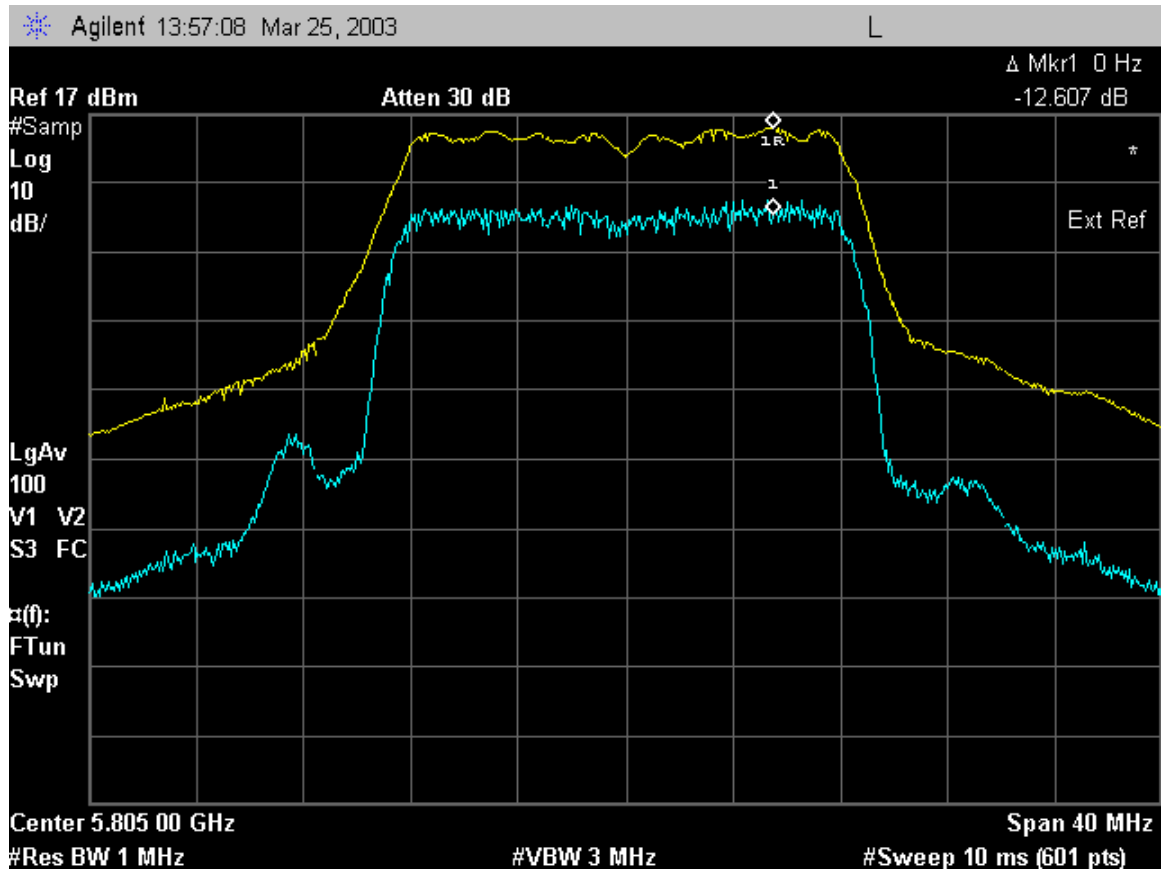

Peak Excursion 5805 MHz HIGH channel
modulation rate 24 Mbps

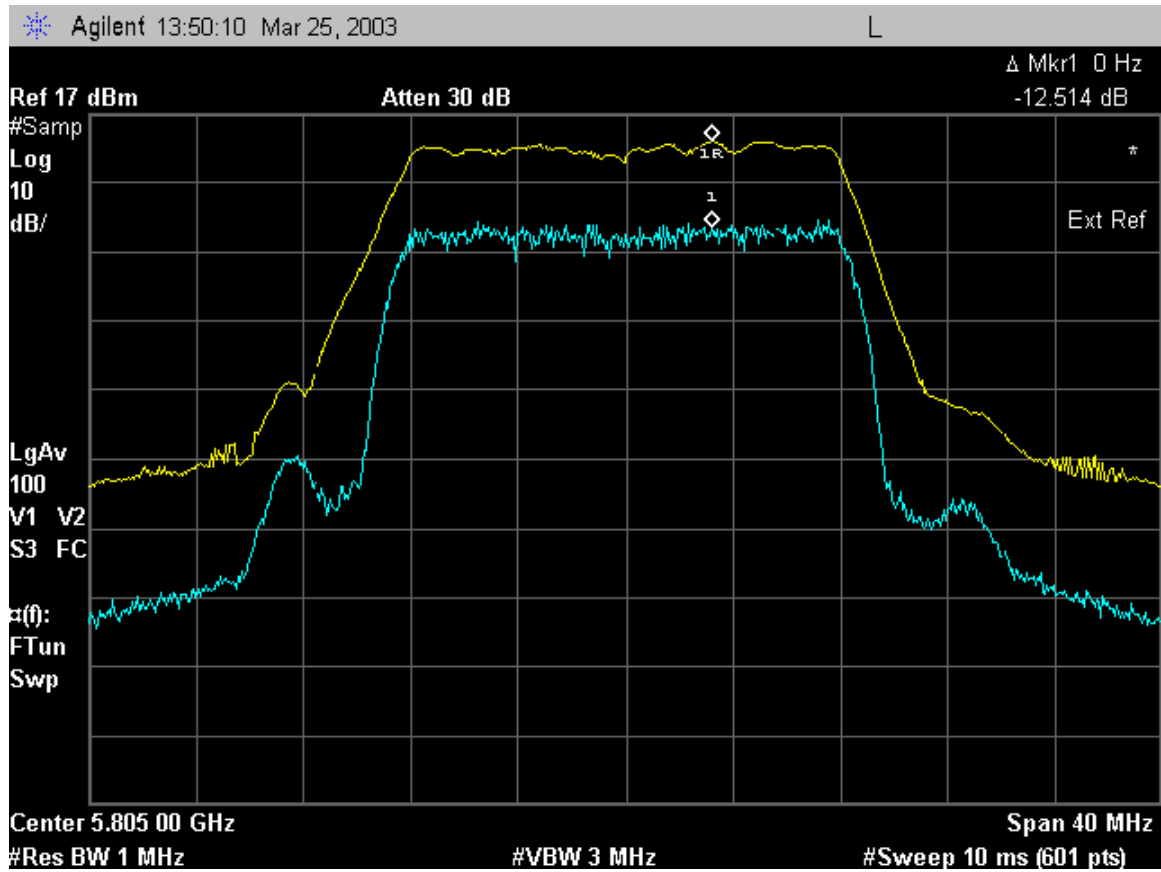

Peak Excursion 5805 MHz HiGH channel
modulation rate 54 Mbps

15.407(b)3,4 Unwanted emissions (radiated emissions) 1-40 GHz

Test equipment

HP 841256 Microwave EMC test system:

- EMCO 3115 horn antenna, 1 - 18 GHz
- HP horn antenna, 18 - 26.5 GHz
- HP horn antenna, 26.5 - 40 GHz
- High pass filter, 8.5 GHz
- HP 8561E Spectrum analyzer, 9 kHz - 50 GHz
- Cables, connectors, and adapters

Test Set-up

Figure 2

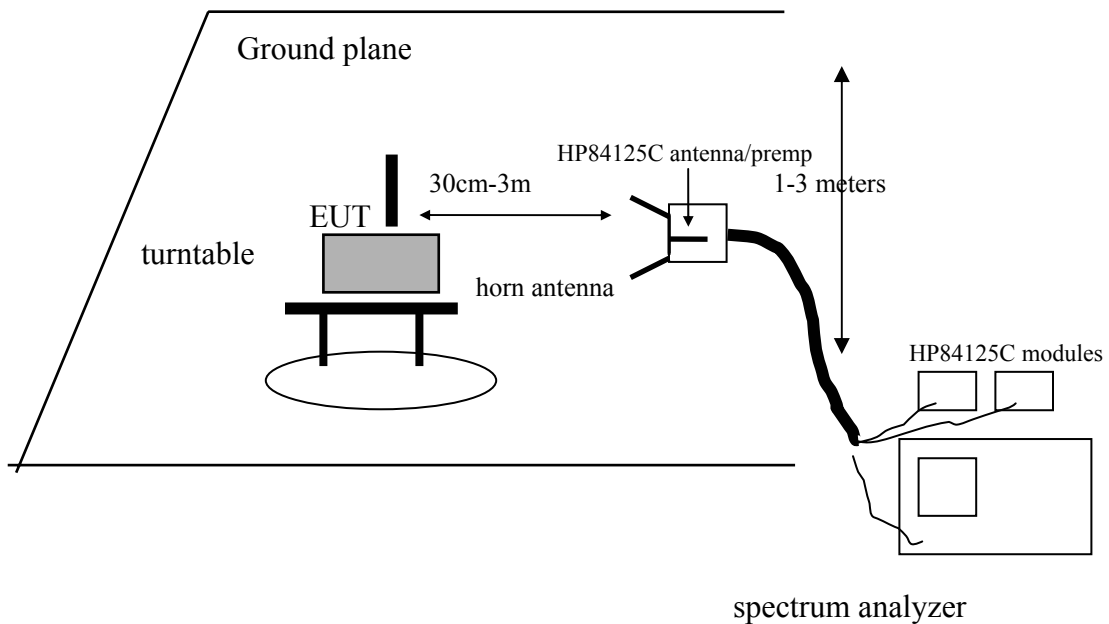

Test Procedures

Four different antennas are used with the transmitter:

omni	9 dBi
sector	10 dBi
integrated flat panel	23 dBi
dish antenna	29 dBi

For each transmit antenna, with the transmitter operating at full power, the EUT was rotated 360° and the search antenna was raised and lowered in both polarities, all in an attempt to maximize the levels of the received emission for each harmonic and spurious emission up to 10 fo.

Test Results

For all antennas tested, radiated emissions 1-40 GHz were at or below instrument noise floor, except for the fundamental frequency and second harmonic emission.

Fo	Harmonic	omni Pk/Av (dBuV/m)	dish Pk/Av (dBuV/m)	sector Pk/Av (dBuV/m)	integral Pk/Av (dBuV/m)	LIMITS Pk/Av (dBuV/m)	Meas.Dist
5745	2fo	54/44	54.8/40NF	54/43	54.5/43	74/54	3m
	3fo	NF 48/37	NF48.2/37	NF48/38	NF43.2/38	74/54	1m
	4fo-10fo	NF 39/28	NF 39/28	NF 39/28	NF 39/28	74/54	30 cm
5785	2fo	53/43	53/43.5	53/43.5	53/43.5	74/54	3m
	3fo	NF48/38	NF48/38	NF48/38	NF48/38	74/54	1m
	4fo-10fo	NF 39/28	NF 39/28	NF 39/28	NF 39/28	74/54	30 cm
5805	2fo	53/43	53/43	53/43	53/43	74/54	3m
	3fo	NF48/38	NF48/38	NF48/38	NF48/38	74/54	1m
	4fo-10fo	NF 39/28	NF 39/28	NF 39/28	NF 39/28	74/54	30 cm

HP 841256 Microwave EMC test system stores antenna factors, cable loss, and HP filter insertion loss values and produces a display with corrected field strength readings at a 3m separation distance.

System calibration date: 12 Feb 2003.

Readings were extrapolated to the 3m specification distance by adding a correction factor of $20\log(d/3m)$.

Readings were essentially all at noise floor, including 2fo readings, which were less than 3 dB above system noise floor.

15.407(c) Automatic transmitter turn-of

Requirement

(c) The device shall automatically discontinue transmission in case of either absence of information to transmit or operational failure. These provisions are not intended to preclude the transmission of control or signaling information or the use of repetitive codes used by certain digital technologies to complete frame or burst intervals. Applicants shall include in their application for equipment authorization a description of how this requirement is met.

Implementation

The EUT is an Ethernet system, and as such if there is no data to be transmitted the TX enable is not activated. The indoor unit sends a tone to the ODU microprocessor to discover operational state, and a watchdog monitor keeps track of ODU and IDU DC voltages. In the event of malfunction or power faults, the watchdog monitor sends a signal to the ODU microprocessor to cease TX operation until the fault is cleared.

15.407(g) Frequency Stability

Requirement

(g) Manufacturers of U-NII devices are responsible for ensuring frequency stability such that an emission is maintained within the band of operation under all conditions of normal operation as specified in the users manual.

Test equipment

Agilent 4440A spectrum analyzer
6 dB attenuator
coaxial cable (1.3 dB loss at 5.8 GHz)
Envirotronics model SH27C Temperature Chamber

Test Set-up

Figure 1, with EUT placed inside temperature chamber

Test Procedure

Spectrum analyzer set up same as "Emissions Bandwidth" tests. Trace taken by capturing sweep with view button (per procedures).

Test Results

Refer to spectrum analyzer plots below. There was no detectable frequency drift in the emission mask. The EUT uses a oscillator with 20ppm frequency drift specifications, with a theoretical maximum drift of $5805 * .000020 = 116$ kHz. The EUT stays within band for conditions of normal operation as specified in the manual.

5745 MHz Blue = -30°C Yellow = 55°C

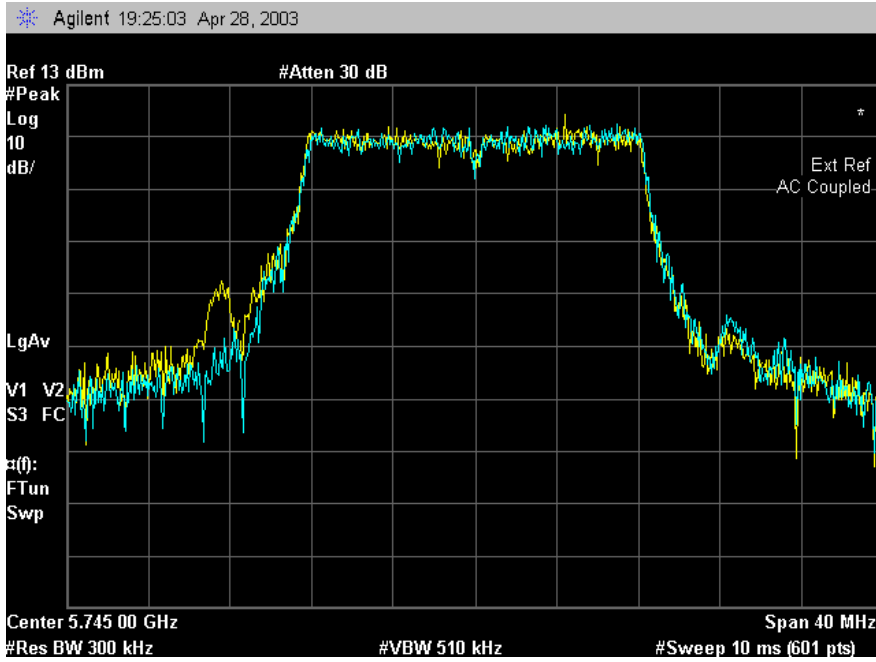

5805 MHz Blue = -30°C Yellow = 55°C

