



# Cisco Managed Services Residential Gateway User Guide



## Please Read

### Important

Please read this entire guide. If this guide provides installation or operation instructions, give particular attention to all safety statements included in this guide.

## Notices

### Trademark Acknowledgments

Cisco and the Cisco Logo are trademarks of Cisco Systems, Inc. and/or its affiliates in the U.S. and other countries. A listing of Cisco's trademarks can be found at [www.cisco.com/go/trademarks](http://www.cisco.com/go/trademarks).

Third party trademarks mentioned are the property of their respective owners.

The use of the word partner does not imply a partnership relationship between Cisco and any other company. (1005R)

The Wi-Fi Protected Setup mark is a mark of the Wi-Fi Alliance. Wi-Fi Protected Setup is a trademark of the Wi-Fi Alliance. <<**WRITERS: Use this statement if your product and document uses the WPS (Wi-Fi Protected Setup) logo. You MUST also include a wireless product disclaimer (Object 137283) in your doc.>>**

#### Disclaimer

The maximum performance for wireless is derived from IEEE Standard 802.11 specifications. Actual performance can vary, including lower wireless network capacity, data throughput rate, range and coverage. Performance depends on many factors, conditions and variables, including distance from the access point, volume of network traffic, building materials and construction, operating system used, mix of wireless products used, interference and other adverse conditions.

### Publication Disclaimer

Cisco Systems, Inc. assumes no responsibility for errors or omissions that may appear in this publication. We reserve the right to change this publication at any time without notice. This document is not to be construed as conferring by implication, estoppel, or otherwise any license or right under any copyright or patent, whether or not the use of any information in this document employs an invention claimed in any existing or later issued patent.



### Copyright

© 2010 Cisco Systems, Inc. All rights reserved. Printed in the United States of America.

Information in this publication is subject to change without notice. No part of this publication may be reproduced or transmitted in any form, by photocopy, microfilm, xerography, or any other means, or incorporated into any information retrieval system, electronic or mechanical, for any purpose, without the express permission of Cisco Systems, Inc.

## Notice to Installers

The servicing instructions in this notice are for use by qualified service personnel only. To reduce the risk of electric shock, do not perform any servicing other than that contained in the operating instructions, unless you are qualified to do so.

<p><b>Note to System Installer</b></p> <p>For this apparatus, the cable shield/screen shall be grounded as close as practical to the point of entry of the cable into the building. For products sold in the US and Canada, this reminder is provided to call the system installer's attention to Article 800-93 and Article 800-100 of the NEC (or Canadian Electrical Code Part 1), which provides guidelines for proper grounding of the cable shield.</p>	
	<p><b>CAUTION:</b> To reduce the risk of electric shock, do not remove cover (or back). No user-serviceable parts inside. Refer servicing to qualified service personnel.</p> <p><b>WARNING</b> TO PREVENT FIRE OR ELECTRIC SHOCK, DO NOT EXPOSE THIS UNIT TO RAIN OR MOISTURE.</p> 
<p>This symbol is intended to alert you that uninsulated voltage within this product may have sufficient magnitude to cause electric shock. Therefore, it is dangerous to make any kind of contact with any inside part of this product.</p>	<p>This symbol is intended to alert you of the presence of important operating and maintenance (servicing) instructions in the literature accompanying this product.</p>





## Notice à l'attention des installateurs de réseaux câblés

Les instructions relatives aux interventions d'entretien, fournies dans la présente notice, s'adressent exclusivement au personnel technique qualifié. Pour réduire les risques de chocs électriques, n'effectuer aucune intervention autre que celles décrites dans le mode d'emploi et les instructions relatives au fonctionnement, à moins que vous ne soyez qualifié pour ce faire.

<p><b>Remarque à l'attention de l'installateur du système</b></p> <p>Avec cet appareil, le blindage/écran du câble doit être mis à la terre aussi près que possible du point d'entrée du câble dans le bâtiment. En ce qui concerne les produits vendus aux États-Unis et au Canada, ce rappel est fourni pour attirer l'attention de l'installateur sur les articles 800-93 et 800-100 du Code national de l'électricité (ou Code de l'électricité canadien, Partie 1) qui fournissent des lignes directrices concernant la mise à la terre correcte du blindage (écran) du câble.</p>	
	<p><b>ATTENTION :</b> Pour réduire les risques de chocs électriques, ne pas enlever le couvercle (ou le panneau arrière). Ne contient aucune pièce réparable par l'utilisateur. Confier les interventions aux techniciens d'entretien qualifiés.</p> <p><b>AVERTISSEMENT</b> POUR ÉVITER LES INCENDIES OU LES CHOC ÉLECTRIQUES, NE PAS EXPOSER L'APPAREIL À LA PLUIE OU À L'HUMIDITÉ.</p> 
<p>Ce symbole a pour but de vous prévenir que des tensions électriques non isolées existent à l'intérieur de ce produit, pouvant être d'une intensité suffisante pour causer des chocs électriques. Il est donc dangereux d'établir un contact quelconque avec l'une des pièces comprises à l'intérieur de ce produit.</p>	<p>Ce symbole a pour but de vous prévenir de la présence d'instructions importantes relatives au fonctionnement ou à l'entretien (et aux réparations) dans la documentation accompagnant ce produit.</p>

## Mitteilung für CATV-Techniker

Die in dieser Mitteilung aufgeführten Wartungsanweisungen sind ausschließlich für qualifiziertes Fachpersonal bestimmt. Um die Gefahr eines elektrischen Schlags zu reduzieren, sollten Sie keine Wartungsarbeiten durchführen, die nicht ausdrücklich in der Bedienungsanleitung aufgeführt sind, außer Sie sind zur Durchführung solcher Arbeiten qualifiziert.

<p><b>Mitteilung an den Systemtechniker</b></p> <p>Für dieses Gerät muss der Kabelschutz/Schirm so nahe wie möglich am Eintrittspunkt des Kabels in das Gebäude geerdet werden. Dieser Erinnerungshinweis liegt den in den USA oder Kanada verkauften Produkten bei. Er soll den Systemtechniker auf Paragraph 800-93 und Paragraph 800-100 der US-Elektrovorschrift NEC (oder der kanadischen Elektrovorschrift Canadian Electrical Code Teil 1) aufmerksam machen, in denen die Richtlinien für die ordnungsgemäße Erdung des Kabelschirms festgehalten sind.</p>	<table border="1"> <tr> <td data-bbox="756 367 831 434"></td> <td data-bbox="836 338 1002 398"> <p><b>CAUTION</b> RISK OF ELECTRIC SHOCK DO NOT OPEN</p> </td> <td data-bbox="1007 367 1082 434"></td> </tr> <tr> <td></td> <td data-bbox="836 405 1002 465"> <p><b>ACHTUNG</b> STROMSCHLAGEFAHR, NICHT ÖFFNEN</p> </td> <td></td> </tr> </table> <p>ACHTUNG: Zur Vermeidung eines Stromschlags darf die Abdeckung (bzw. die Geräterückwand) nicht entfernt werden. Das Gerät enthält keine vom Benutzer wartbaren Teile. Wartungsarbeiten dürfen nur von qualifiziertem Fachpersonal durchgeführt werden.</p> <p><b>WARNUNG</b> DAS GERÄT NICHT REGEN ODER FEUCHTIGKEIT AUSSETZEN, UM STROMSCHLAG ODER DURCH EINEN KURZSCHLUSS VERURSACHTEN BRAND ZU VERMEIDEN.</p>		<p><b>CAUTION</b> RISK OF ELECTRIC SHOCK DO NOT OPEN</p>			<p><b>ACHTUNG</b> STROMSCHLAGEFAHR, NICHT ÖFFNEN</p>	
	<p><b>CAUTION</b> RISK OF ELECTRIC SHOCK DO NOT OPEN</p>						
	<p><b>ACHTUNG</b> STROMSCHLAGEFAHR, NICHT ÖFFNEN</p>						
<p></p> <p>Dieses Symbol weist den Benutzer auf das Vorhandensein von nicht isolierten gefährlichen Spannungen im Gerät hin, die Stromschläge verursachen können. Ein Kontakt mit den internen Teilen dieses Produktes ist mit Gefahren verbunden.</p>	<p></p> <p>Dieses Symbol weist den Benutzer darauf hin, dass die mit diesem Produkt gelieferte Dokumentation wichtige Betriebs- und Wartungsanweisungen für das Gerät enthält.</p>						

## Aviso a los instaladores de sistemas CATV

Las instrucciones de reparación contenidas en el presente aviso son para uso exclusivo por parte de personal de mantenimiento cualificado. Con el fin de reducir el riesgo de descarga eléctrica, no realice ninguna otra operación de reparación distinta a las contenidas en las instrucciones de funcionamiento, a menos que posea la cualificación necesaria para hacerlo.

<p><b>Nota para el instalador del sistema</b></p> <p>En lo que se refiere a este aparato, el blindaje del cable debe conectarse a tierra lo más cerca posible al punto por el cual el cable entra en el edificio. En el caso de los productos vendidos en los EE. UU. y Canadá, el presente aviso se suministra para llamar la atención del instalador del sistema sobre los Artículos 800-93 y 800-100 del NEC (o Código Eléctrico de Canadá, Parte 1), que proporcionan directrices para una correcta conexión a tierra del blindaje del cable.</p>	<table border="1"> <tr> <td data-bbox="756 1106 831 1173"></td> <td data-bbox="836 1077 1002 1137"> <p><b>CAUTION</b> RISK OF ELECTRIC SHOCK DO NOT OPEN</p> </td> <td data-bbox="1007 1106 1082 1173"></td> </tr> <tr> <td></td> <td data-bbox="836 1144 1002 1205"> <p><b>ATENCIÓN</b> RIESGO DE DESCARGA ELÉCTRICA NO ABRIR</p> </td> <td></td> </tr> </table> <p>ATENCIÓN: con el fin de reducir el riesgo de descarga eléctrica, no retire la tapa (ni la parte posterior). No existen en el interior componentes que puedan ser reparados por el usuario. Encargue su revisión a personal de mantenimiento cualificado.</p> <p><b>ADVERTENCIA</b> PARA EVITAR EL RIESGO DE INCENDIO O DESCARGA ELÉCTRICA, NO EXPONGA LA UNIDAD A LA LLUVIA O A LA HUMEDAD.</p>		<p><b>CAUTION</b> RISK OF ELECTRIC SHOCK DO NOT OPEN</p>			<p><b>ATENCIÓN</b> RIESGO DE DESCARGA ELÉCTRICA NO ABRIR</p>	
	<p><b>CAUTION</b> RISK OF ELECTRIC SHOCK DO NOT OPEN</p>						
	<p><b>ATENCIÓN</b> RIESGO DE DESCARGA ELÉCTRICA NO ABRIR</p>						
<p></p> <p>Este símbolo tiene como fin advertirle de que una tensión sin aislamiento en el interior de este producto podría ser de una magnitud suficiente como para provocar una descarga eléctrica. Por consiguiente, resulta peligroso realizar cualquier tipo de contacto con alguno de los componentes internos de este producto.</p>	<p></p> <p>Este símbolo tiene como fin alertarle de la presencia de importantes instrucciones de operación y mantenimiento (revisión) contenidas en la literatura que acompaña al producto.</p>						

# Contents

Notice à l'attention des installateurs de réseaux câblés .....	5
Mitteilung für CATV-Techniker .....	5
Aviso a los instaladores de sistemas CATV .....	6

## **IMPORTANT SAFETY INSTRUCTIONS** **vii**

Power Source Warning .....	vii
Ground the Product.....	vii
Protect the Product from Lightning .....	viii
Verify the Power Source from the On/Off Power Light.....	viii
Eliminate AC Mains Overloads .....	viii
Provide Ventilation and Select a Location .....	viii
Protect from Exposure to Moisture and Foreign Objects.....	viii
Service Warnings .....	ix
Check Product Safety .....	ix
Protect the Product When Moving It .....	ix
Telephone Equipment Notice .....	ix

## **United States FCC Compliance** **xii**

Declaration of Conformity.....	xii
Canada EMI Regulation.....	xii
RF Exposure Statements .....	xiii

## **CE Compliance** **xvi**

Declaration of Conformity with Regard to the EU Directive 1999/5/EC (R&TTE Directive) .....	xvi
National Restrictions .....	xvii
Antennas .....	xviii

## **About This Guide** **xix**

Introduction .....	xix
Audience .....	xix
Related Publications .....	xix
Document Version .....	xix

## **Chapter 1 Introducing the Managed Services Residential Gateway1**

Benefits and Features.....	2
Personal Content Sharing and Storage .....	2
Simplified Connected Home .....	2

## Contents

Phone Services.....	2
Wireless Services.....	3
Home Security, Monitoring and Automation.....	3
Web Browsing supported with Parental Controls & Firewall Monitoring.....	4
Home Energy Management .....	4
Simplified Support.....	4
What's on the Top Panel?.....	5
What's on the Back Panel? .....	7
What's on the Side Panel? .....	8
What's on the Bottom Panel .....	9
<b>Chapter 2 Installing the Residential Gateway</b>	<b>11</b>
Mounting the Residential Gateway.....	12
Mounting the Residential Gateway Horizontally .....	12
Mounting the Residential Gateway Vertically .....	12
Connecting the Residential Gateway .....	15
<b>Chapter 3 Configuration and Operation of the the Residential Gateway</b>	<b>19</b>
Logging into the Residential Gateway.....	20
Internet .....	21
VoIP Settings.....	25
SIP .....	25
Service.....	26
Voice .....	28
Advanced.....	29
Call Log .....	30
Wi-Fi .....	32
Home Address.....	34
Media Storage.....	35
<b>Chapter 4 Using the LCD</b>	<b>37</b>
Get Familiar with the LCD Screens and Menus .....	38
Internet .....	41
Phone .....	42
Wi-Fi .....	44
Turn Wi-Fi Off or On.....	44
Initiate Wi-Fi Protection Setup.....	45
Ports .....	48
Tools.....	49
Review Your Emergency 911 Address.....	49
Perform Factory Reset.....	51



## Contents

Select Language Settings.....	52
View Network Information.....	53
Use Network Tools .....	55
View Router Information.....	57
Select LCD Display Orientation.....	58
View System Event Log .....	59
Set Up Time of Day Parameters.....	60
<b>Chapter 5 Customer Information</b>	<b>63</b>
Customer Support.....	64
If You Have Questions .....	64
Additional Information.....	65
Return Products for Repair.....	66



## IMPORTANT SAFETY INSTRUCTIONS

- 1) Read these instructions.
- 2) Keep these instructions.
- 3) Heed all warnings.
- 4) Follow all instructions.
- 5) Do not use this apparatus near water.
- 6) Clean only with dry cloth.
- 7) Do not block any ventilation openings. Install in accordance with the manufacturer's instructions.
- 8) Do not install near any heat sources such as radiators, heat registers, stoves, or other apparatus (including amplifiers) that produce heat.
- 9) Do not defeat the safety purpose of the polarized or grounding-type plug. A polarized plug has two blades with one wider than the other. A grounding-type plug has two blades and a third grounding prong. The wide blade or the third prong are provided for your safety. If the provided plug does not fit into your outlet, consult an electrician for replacement of the obsolete outlet.
- 10) Protect the power cord from being walked on or pinched particularly at plugs, convenience receptacles, and the point where they exit from the apparatus.
- 11) Only use attachments/accessories specified by the manufacturer.
- 12)  Use only with the cart, stand, tripod, bracket, or table specified by the manufacturer, or sold with the apparatus. When a cart is used, use caution when moving the cart/apparatus combination to avoid injury from tip-over.
- 13) Unplug this apparatus during lightning storms or when unused for long periods of time.
- 14) Refer all servicing to qualified service personnel. Servicing is required when the apparatus has been damaged in any way, such as a power-supply cord or plug is damaged, liquid has been spilled or objects have fallen into the apparatus, the apparatus has been exposed to rain or moisture, does not operate normally, or has been dropped.

### Power Source Warning

A label on this product indicates the correct power source for this product. Operate this product only from an electrical outlet with the voltage and frequency indicated on the product label. If you are uncertain of the type of power supply to your home or business, consult your service provider or your local power company.

The AC inlet on the unit must remain accessible and operable at all times.

### Ground the Product



**WARNING: Avoid electric shock and fire hazard! If this product connects to coaxial cable wiring, be sure the cable system is grounded (earthed). Grounding provides some protection against voltage surges and built-up static charges.**

## IMPORTANT SAFETY INSTRUCTIONS

### Protect the Product from Lightning

In addition to disconnecting the AC power from the wall outlet, disconnect the signal inputs.

### Verify the Power Source from the On/Off Power Light

When the on/off power light is not illuminated, the apparatus may still be connected to the power source. The light may go out when the apparatus is turned off, regardless of whether it is still plugged into an AC power source.

### Eliminate AC Mains Overloads



**WARNING: Avoid electric shock and fire hazard! Do not overload AC mains, outlets, extension cords, or integral convenience receptacles. For products that require battery power or other power sources to operate them, refer to the operating instructions for those products.**

### Provide Ventilation and Select a Location

- Remove all packaging material before applying power to the product.
- Do not place this apparatus on a bed, sofa, rug, or similar surface.
- Do not place this apparatus on an unstable surface.
- Do not install this apparatus in an enclosure, such as a bookcase or rack, unless the installation provides proper ventilation.
- Do not place entertainment devices (such as VCRs or DVDs), lamps, books, vases with liquids, or other objects on top of this product.
- Do not block ventilation openings.

### Protect from Exposure to Moisture and Foreign Objects



**WARNING: Avoid electric shock and fire hazard! Do not expose this product to dripping or splashing liquids, rain, or moisture. Objects filled with liquids, such as vases, should not be placed on this apparatus.**



**WARNING: Avoid electric shock and fire hazard! Unplug this product before cleaning. Do not use a liquid cleaner or an aerosol cleaner. Do not use a magnetic/static cleaning device (dust remover) to clean this product.**



**WARNING: Avoid electric shock and fire hazard! Never push objects through the openings in this product. Foreign objects can cause electrical shorts that can result in electric shock or fire.**

## Service Warnings



**WARNING: Avoid electric shock! Do not open the cover of this product. Opening or removing the cover may expose you to dangerous voltages. If you open the cover, your warranty will be void. This product contains no user-serviceable parts.**

## Check Product Safety

Upon completion of any service or repairs to this product, the service technician must perform safety checks to determine that this product is in proper operating condition.

## Protect the Product When Moving It

Always disconnect the power source when moving the apparatus or connecting or disconnecting cables.

## Telephone Equipment Notice

When using your telephone equipment, basic safety precautions should always be followed to reduce the risk of fire, electric shock and injury to persons, including the following:

1. Do not use this product near water, for example, near a bath tub, wash bowl, kitchen sink or laundry tub, in a wet basement or near a swimming pool.
2. Avoid using a telephone (other than a cordless type) during an electrical storm. There may be a remote risk of electric shock from lightning.
3. Do not use the telephone to report a gas leak in the vicinity of the leak.



**CAUTION: To reduce the risk of fire, use only No. 26 AWG or larger telecommunication line cord.**

**SAVE THESE INSTRUCTIONS**

20090915\_Modem No Battery\_Safety



## IMPORTANT SAFETY INSTRUCTIONS

## United States FCC Compliance

This device has been tested and found to comply with the limits for a Class B digital device, pursuant to part 15 of the FCC Rules. These limits are designed to provide reasonable protection against such interference in a residential installation. This equipment generates, uses, and can radiate radio frequency energy. If not installed and used in accordance with the instructions, it may cause harmful interference to radio communications. However, there is no guarantee that interference will not occur in a particular installation. If this equipment does cause harmful interference to radio or television reception, which can be determined by turning the equipment OFF and ON, the user is encouraged to try to correct the interference by one or more of the following measures:

- Reorient or relocate the receiving antenna.
- Increase the separation between the equipment and receiver.
- Connect the equipment into an outlet on a circuit different from that to which the receiver is connected.
- Consult the service provider or an experienced radio/television technician for help.

Any changes or modifications not expressly approved by Cisco Systems, Inc., could void the user's authority to operate the equipment.

The information shown in the FCC Declaration of Conformity paragraph below is a requirement of the FCC and is intended to supply you with information regarding the FCC approval of this device. *The phone numbers listed are for FCC-related questions only and not intended for questions regarding the connection or operation for this device. Please contact your service provider for any questions you may have regarding the operation or installation of this device.*

## Declaration of Conformity

This device complies with Part 15 of FCC Rules. Operation is subject to the following two conditions: 1) the device may not cause harmful interference, and 2) the device must accept any interference received, including interference that may cause undesired operation.

## Canada EMI Regulation

This Class B digital apparatus complies with Canadian ICES-003.

Cet appareil numérique de la class B est conforme à la norme NMB-003 du Canada.



## RF Exposure Statements

**Note:** This transmitter must not be co-located or operated in conjunction with any other antenna or transmitter. This equipment should be installed and operated with a minimum distance of 7.9 inches (20 cm) between the radiator and your body.

### US

This system has been evaluated for RF exposure for humans in reference to ANSI C 95.1 (American National Standards Institute) limits. The evaluation was based in accordance with FCC OET Bulletin 65C rev 01.01 in compliance with Part 2.1091 and Part 15.27. The minimum separation distance from the antenna to general bystander is 7.9 inches (20 cm) to maintain compliance.

### Canada

This system has been evaluated for RF exposure for humans in reference to Canada Health Code 6 (2009) limits. The evaluation was based on evaluation per RSS-102 Rev 4. The minimum separation distance from the antenna to general bystander is 7.9 inches (20 cm) to maintain compliance.

### EU

This system has been evaluated for RF exposure for humans in reference to the ICNIRP (International Commission on Non-Ionizing Radiation Protection) limits. The evaluation was based on the EN 50385 Product Standard to Demonstrate Compliance of Radio Base Stations and Fixed Terminals for Wireless Telecommunications Systems with basic restrictions or reference levels related to Human Exposure to Radio Frequency Electromagnetic Fields from 300 MHz to 40 GHz. The minimum separation distance from the antenna to general bystander is 20 cm (7.9 inches).

### Australia

This system has been evaluated for RF exposure for humans as referenced in the Australian Radiation Protection standard and has been evaluated to the ICNIRP (International Commission on Non-Ionizing Radiation Protection) limits. The minimum separation distance from the antenna to general bystander is 20 cm (7.9 inches).

20100527 FCC DSL\_Dom and Intl

## Canada

This device complies with RSS-210 of the Industry Canada Rules. Operation is subject to the following two conditions: (1) This device may not cause harmful interference, and (2) this device must accept any interference received, including interference that may cause undesired operation.

Ce dispositif est conforme à la norme CNR-210 d'Industrie Canada applicable aux appareils radio exempts de licence. Son fonctionnement est sujet aux deux conditions suivantes: (1) le dispositif ne doit pas produire de brouillage préjudiciable, et (2) ce dispositif doit accepter tout brouillage reçu, y compris un brouillage susceptible de provoquer un fonctionnement indésirable.

**IMPORTANT NOTE:**

**Radiation Exposure Statement:**

**This equipment complies with IC radiation exposure limits set forth for an uncontrolled environment. This equipment should be installed and operated with minimum distance 20cm between the radiator & your body.**

**NOTE IMPORTANTE:**

**Déclaration d'exposition aux radiations:**

**Cet équipement est conforme aux limites d'exposition aux rayonnements IC établies pour un environnement non contrôlé. Cet équipement doit être installé et utilisé avec un minimum de 20 cm de distance entre la source de rayonnement et votre corps.**



## CE Compliance

### Declaration of Conformity with Regard to the EU Directive 1999/5/EC (R&TTE Directive)

This declaration is only valid for configurations (combinations of software, firmware and hardware) supported or provided by Cisco Systems for use within the EU. The use of software or firmware not supported or provided by Cisco Systems may result in the equipment no longer being compliant with the regulatory requirements.

Български [Bulgarian]:	Това оборудване отговаря на съществените изисквания и приложими клаузи на Директива 1999/5/EC.
Česky [Czech]:	Toto zařízení je v souladu se základními požadavky a ostatními odpovídajícími ustanoveními Směrnice 1999/5/EC.
Dansk [Danish]:	Dette udstyr er i overensstemmelse med de væsentlige krav og andre relevante bestemmelser i Direktiv 1999/5/EF.
Deutsch [German]:	Dieses Gerät entspricht den grundlegenden Anforderungen und den weiteren entsprechenden Vorgaben der Richtlinie 1999/5/EU.
Eesti [Estonian]:	See seade vastab direktiivi 1999/5/EU olulistele nõuetele ja teistele asjakohastele sätetele.
English:	This equipment is in compliance with the essential requirements and other relevant provisions of Directive 1999/5/EC.
Español [Spanish]:	Este equipo cumple con los requisitos esenciales así como con otras disposiciones de la Directiva 1999/5/CE.
Ελληνική [Greek]:	Αυτός ο εξοπλισμός είναι σε συμμόρφωση με τις ουσιαστικές απαιτήσεις και άλλες σχετικές διατάξεις της Οδηγίας 1999/5/EC.
Français [French]:	Cet appareil est conforme aux exigences essentielles et aux autres dispositions pertinentes de la Directive 1999/5/EC.
Íslenska [Icelandic]:	Þetta tæki er samkvæmt grunnkröfum og öðrum viðeigandi ákvæðum Tilskipunar 1999/5/EC.
Italiano [Italian]:	Questo apparato è conforme ai requisiti essenziali ed agli altri principi sanciti dalla Direttiva 1999/5/CE.
Latviski [Latvian]:	Šī iekārta atbilst Direktīvas 1999/5/EK būtiskajām prasībām un citiem ar to saistītajiem noteikumiem.
Lietuvių [Lithuanian]:	Šis įrenginys tenkina 1999/5/EB Direktyvos esminius reikalavimus ir kitas šios direktyvos nuostatas.
Nederlands [Dutch]:	Dit apparaat voldoet aan de essentiële eisen en andere van toepassing zijnde bepalingen van de Richtlijn 1999/5/EC.
Malti [Maltese]:	Dan l-apparat huwa konformi mal-ftigiet essenzjali u l-provedimenti l-oħra rilevanti tad-Direttiva 1999/5/EC.
Magyar [Hungarian]:	Ez a készülék teljesíti az alapvető követelményeket és más 1999/5/EK irányelvben meghatározott vonatkozó rendelkezéseket.
Norsk [Norwegian]:	Dette utstyret er i samsvar med de grunnleggende krav og andre relevante bestemmelser i EU-direktiv 1999/5/EF.
Polski [Polish]:	Urządzenie jest zgodne z ogólnymi wymaganiami oraz szczególnymi warunkami określonymi Dyrektywą UE: 1999/5/EC.
Português [Portuguese]:	Este equipamento está em conformidade com os requisitos essenciais e outras provisões relevantes da Directiva 1999/5/EC.
Română [Romanian]:	Acest echipament este în conformitate cu cerințele esențiale și cu alte prevederi relevante ale Directivei 1999/5/EC.
Slovensko [Slovenian]:	Ta naprava je skladna z bistvenimi zahtevami in ostalimi relevantnimi pogoji Direktive 1999/5/EC.
Slovensky [Slovak]:	Toto zariadenie je v zhode so základnými požiadavkami a inými príslušnými nariadeniami direktív: 1999/5/EC.
Suomi [Finnish]:	Tämä laite täyttää direktiivin 1999/5/EY olennaiset vaatimukset ja on siinä asetettujen muiden laitteita koskevien määräysten mukainen.
Svenska [Swedish]:	Denna utrustning är i överensstämmelse med de väsentliga kraven och andra relevanta bestämmelser i Direktiv 1999/5/EC.

**Note:** The full declaration of conformity for this product can be found in the Declarations of Conformity and Regulatory Information section of the appropriate product hardware installation guide, which is available on Cisco.com.

The following standards were applied during the assessment of the product against the requirements of the Directive 1999/5/EC:

- Radio: EN 300 328
- EMC: EN 301 489-1 and EN 301 489-17
- Safety: EN 60950 and EN 50385

The CE mark and class-2 identifier are affixed to the product and its packaging. This product conforms to the following European directives:



## National Restrictions

This product is for indoor use only.

### France

For 2.4 GHz, the output power is restricted to 10 mW EIRP when the product is used outdoors in the band 2454 - 2483,5 MHz. There are no restrictions when used in other parts of the 2,4 GHz band. Check <http://www.arcep.fr/> for more details.

Pour la bande 2,4 GHz, la puissance est limitée à 10 mW en p.i.r.e. pour les équipements utilisés en extérieur dans la bande 2454 - 2483,5 MHz. Il n'y a pas de restrictions pour des utilisations dans d'autres parties de la bande 2,4 GHz. Consultez <http://www.arcep.fr/> pour de plus amples détails.

### Italy

This product meets the National Radio Interface and the requirements specified in the National Frequency Allocation Table for Italy. Unless this wireless LAN product is operating within the boundaries of the owner's property, its use requires a "general authorization." Please check <http://www.comunicazioni.it/it/> for more details.

Questo prodotto è conforme alla specifiche di Interfaccia Radio Nazionali e rispetta il Piano Nazionale di ripartizione delle frequenze in Italia. Se non viene installato all'interno del proprio fondo, l'utilizzo di prodotti Wireless LAN richiede una "Autorizzazione Generale". Consultare <http://www.comunicazioni.it/it/> per maggiori dettagli.

### Latvia

The outdoor usage of the 2.4 GHz band requires an authorization from the Electronic Communications Office. Please check <http://www.esd.lv> for more details.

2,4 GHz frekvenču joslas izmantošanai ārpus telpām nepieciešama atļauja no Elektronisko sakaru direkcijas. Vairāk informācijas: <http://www.esd.lv>.

**Note:** The regulatory limits for maximum output power are specified in EIRP. The EIRP level of a device can be calculated by adding the gain of the antenna used (specified in dBi) to the output power available at the connector (specified in dBm).

**CE Compliance**

**Antennas**

Use only the antenna supplied with the product.

20090312 CE\_Gateway

# About This Guide

## Introduction

This guide supports the Cisco® Managed Services Residential Gateway. Refer to this guide for installing and configuring your residential gateway.

Models supported by this guide include:

- REN301 Managed Services Residential Gateway
- TES301 Managed Services Residential Gateway with SIP
- TEI301 Managed Services Residential Gateway with SIP/IMS
- REN301W Managed Services Residential Gateway with Z-Wave
- TES301W Managed Services Residential Gateway with Z-Wave with SIP
- TEI301W Managed Services Residential Gateway with Z-Wave with SIP/IMS
- REN301Z Managed Services Residential Gateway with ZigBee
- TES301Z Managed Services Residential Gateway with ZigBee with SIP
- TEI301Z Managed Services Residential Gateway with ZigBee with SIP/IMS

## Audience

This document is written for residential subscribers using a Managed Services Residential Gateway.

## Related Publications

Visit our website (<https://www.sciatl.com/subscriberextranet/techpubs>) to view additional publications about our products.

You need a user name and password to access this website. If you do not have a user name and password, go to <https://www.scientificatlanta.com/dsnexplorer/register.htm> to complete and submit a registration form.

**Note:** You may need to install a PDF reader, such as Adobe Acrobat Reader, on your system to view these publications.

## Document Version

This is the first formal release of this document.

## About This Guide



# 1

---

## Introducing the Managed Services Residential Gateway

### Introduction

The Cisco® Managed Services Residential Gateway is an advanced, high-performance home gateway that combines Ethernet, Voice over IP (VoIP), router and wireless access point technologies in a single device providing a cost-effective voice and networking solution for Connected Home and Managed Home experiences.

This chapter lists the benefits and features of the residential gateway. Illustrations and descriptions of the connection ports, power and reset buttons, touch-sensitive keys, and LED indicators are also provided.

### In This Chapter

■ Benefits and Features .....	2
■ What's on the Top Panel?.....	5
■ What's on the Back Panel? .....	7
■ What's on the Side Panel? .....	8
■ What's on the Bottom Panel .....	9

## Benefits and Features

### Personal Content Sharing and Storage

- Digital Living Network Alliance (DLNA) support provides a consolidated view of all content within the home network
- Content can be shared with any PC or device connected to the home network
- Pre-Installed SD card can support up to 32 GB capacity for local, intelligent caching of digital video, pictures, music and other files.
- Supports streaming content to media players and TVs
- Remote Access using Managed Service applications allows access to content from outside the home via a laptop or PDA
- Remote notifications for event triggering applications
- Optional IPsec for tunneling data to remote Storage servers
- Optional DTCP-IP security for copyright protected music and video files

### Simplified Connected Home

- Easy to use and follow color LCD combined with Embedded Network Management to simplify connections, configurations & settings of IP devices in the home
- Supports remote management, proactive monitoring and software updates
- Supports secure WAN tunnels for private/protected personal data flows
- Supports 10/100/1000 Ethernet WAN for deployment behind xDSL, fiber and cable modem
- Easy wireless setup with WPS Push Button

### Phone Services

- 2 ATA Ports with SIP Client support separate SIP phone numbers
- Home coverage supports SIP/IMS phones, Wi-Fi connection with Android

## Wireless Services

- Wi-Fi 802.11b/g/n 2.4 GHz (2x2) for basic home networking service
- Provides Unscheduled Automatic Power Save Delivery (UAPSD) Cell phone handoff (SIP) support
- Internal Antenna designs supports omni-directional techniques that provide excellent 3-D coverage, isolation & pattern diversity in all bands.

## Home Security, Monitoring and Automation

- Managed Services (OSGi/JVM, iControl, 4-Home, Open Peak, etc.)
- Remote home management from work or while traveling allows arming/disarming of home security system, lighting control, thermostat control, door lock control, and live video monitoring
- The REN301W, TEI301W, and TES301W models function as primary controller to include a Zwave node to the network by assigning its Home ID and Node ID and exclude other Zwave nodes as well. Characteristics for this low-power wireless technology used by home control, monitoring and security include:
  - RF Frequency band: Sub-GHz
  - Mesh Networking: Every node is a repeater and self healing
  - 32-bit unique identifier as Home ID to separate Z-wave networks
  - An 8-bit identifier called the Node ID is used to address individual nodes in the same network. One Z-wave network can have up to 232 nodes
- The REN301Z, TEI301Z, and TES301Z models support ZigBee, which is a technology for wireless sensors and control networks based on the IEEE 802.15.4 standard. ZigBee can be used for home automation/control and energy management, such as light switch, light dimmer, door lock, thermostat, and smart meter, etc. The characteristics of ZigBee are listed below:
  - RF frequency band: 2.4GHz
  - Data rates of 250kbps
  - Range: 50m typical (5-500m based on environment)
  - Multiple topologies: star, peer-to-peer, mesh
  - 64-bit IEEE address

## Web Browsing supported with Parental Controls & Firewall Monitoring

- NAPT, SPI firewall, WEP, WPA/2, MAC filtering, and VPN pass-through,
- IPv4 + IPv6, VLAN IEEE 802.1q and p
- Comprehensive protocol support including IGMP, DLNA, UPnP and OSGi/JVM friendly
- Remote Management via TR-069, TR-104 and embedded Network Management

## Home Energy Management

Home Area Network (HAN) and an energy management service which enables more optimal use of energy by consumers

## Simplified Support

- **Setup** – Embedded Network Management and Provisioning tool simplifies installation of the residential gateway.
- **Network Manager** – a PC based application that helps to self-manage the home network (repairs connections, secures, facilitates sharing)

## What's on the Top Panel?

The top panel of your residential gateway provides an LCD screen for easy setup and configuration. Use the touch-sensitive arrow keys to navigate through the menu options. Refer to *Configuration and Operation of the the Residential Gateway* (on page 19) for more information on this feature. The top panel also provides LED status icons that indicate the operational state of your gateway. Refer to the following diagram for a description of the top panel.



T14799

## Chapter 1 Introducing the Managed Services Residential Gateway

- 1 **Power** (Green/Red) – The Power LED lights up when the residential gateway is powered on. The LED becomes red during a malfunction.
- 2 **WPS Touch-Sensitive Key** (Amber) – Touch for 3 seconds to initiate pairing with Wi-Fi devices.
- 3 **LCD with Touch-Sensitive Keys** – LCD screen lights up by the wave of a hand to display menu options for common setup and configuration functions. The touch-sensitive keys, indicated by the up, down, left, and right arrows, help you navigate through the menus.
- 4 **Phone 1-2** (Blue) – The LED lights up blue when it is registered with SIP server. It flashes to indicate voice mail messages have been received.

## What's on the Back Panel?

The back panel of your residential gateway provides ports, power, and reset mechanisms. Refer to the following diagram for a description of the back panel.

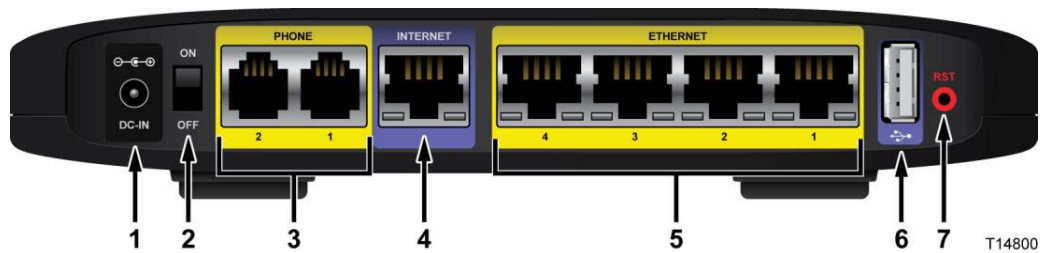

- 1 **Power** – The Power port is where you will connect the power adapter that is included in the box.
- 2 **Power Switch** – Use this switch to power on or off the device.
- 3 **Phone 1-2** – The Phone ports connect standard analog telephones to the device.
- 4 **Internet** – The Internet port connects to the Ethernet port on the DSL, fiber, or cable modem.
- 5 **Ethernet LAN 1-4** – These Ethernet ports (1, 2, 3, 4) connect device to wired computers and other Ethernet network devices.
- 6 **USB** – The USB port connects to a USB storage device, such as a USB hard drive or flash disk.
- 7 **Reset** – The Reset button restores the device to its original factory settings by pressing and holding down the Reset button for 5 seconds.

**Note:** The reset does not restore the voice settings to the factory defaults.

## What's on the Side Panel?

The side panel of your residential gateway provides an additional USB port. Refer to the following diagram for a description of the back panel.



**USB** – The USB port connects to a USB storage device, such as a USB hard drive or flash disk.



## What's on the Bottom Panel

The bottom panel of your residential gateway provides holes for mounting screws for wall mounting and protective feet for vertical or wall mounting surfaces. The factory label on the bottom panel provides serial number and MAC Address information.





# 2

---

## Installing the Residential Gateway

### Introduction

This chapter provides instructions for installing the residential gateway.

### In This Chapter

- Mounting the Residential Gateway..... 12
- Connecting the Residential Gateway..... 15

## Mounting the Residential Gateway

### Mounting the Residential Gateway Horizontally

The residential gateway has four rubber feet on its bottom panel. Place the residential gateway on a level surface near an electrical outlet.

### Mounting the Residential Gateway Vertically

The residential gateway has four wall-mount slots on its bottom panel. The distance between two adjacent slots is 4 inches (101.6 mm).

Two screws are needed to mount the residential gateway.

## Mounting the Residential Gateway

The following illustration shows the location and dimensions of the wall-mounting slots on the bottom of the residential gateway. Use the information on this page as a guide for mounting your residential gateway to the wall.

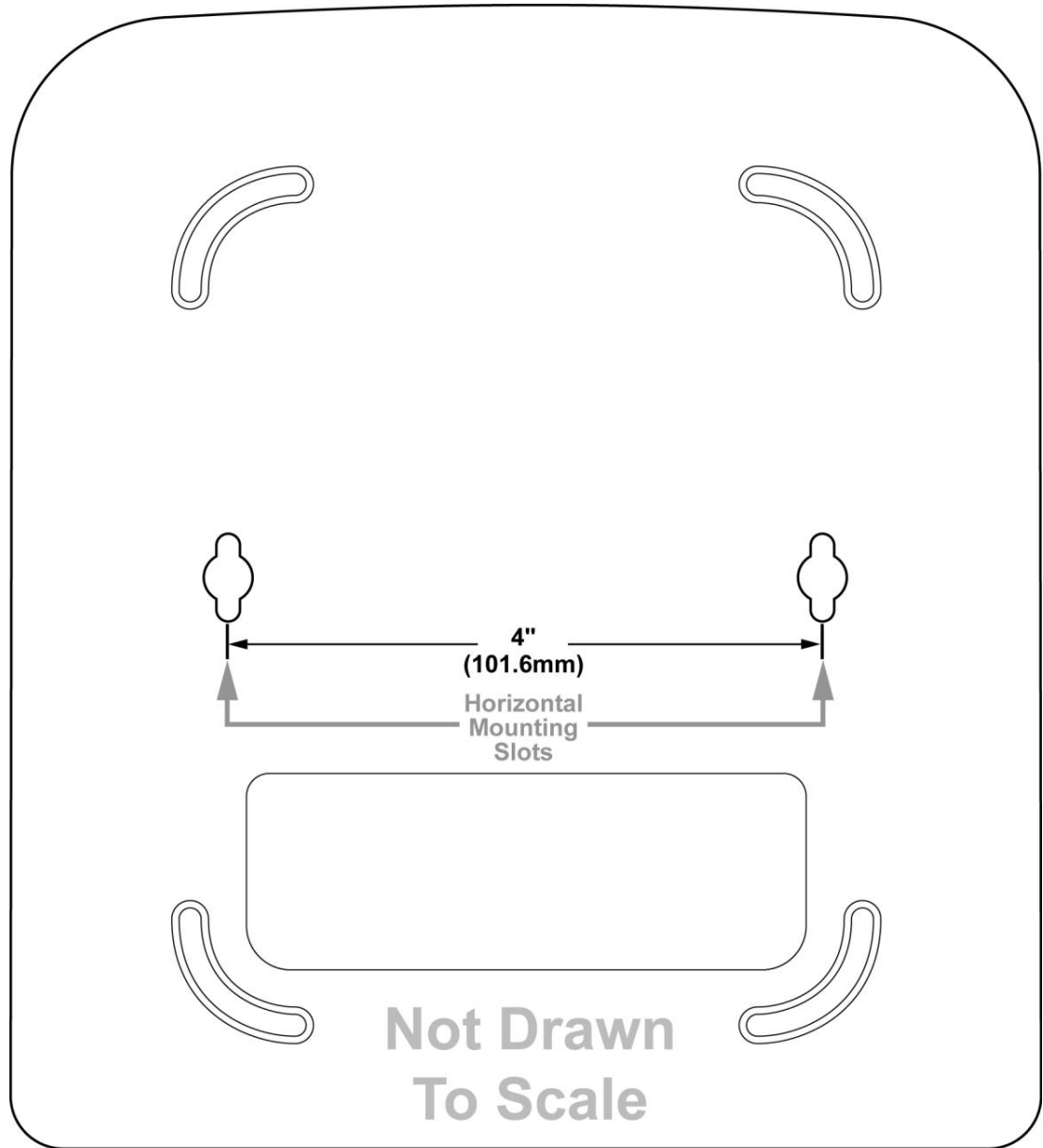

T14801

### Notes:

- Mounting hardware illustrations are not true to scale.
- Cisco is not responsible for damages incurred by insecure wall-mounting hardware.

## Chapter 2 Installing the Residential Gateway

Follow these instructions:

- 1 Determine where you want to mount the residential gateway. Make sure that the wall you use is smooth, flat, dry, and sturdy. Also make sure the location is within reach of an electrical outlet.
- 2 Drill two holes into the wall. Make sure the holes are 4 inches (101.6 mm) apart.
- 3 Insert a screw into each hole and leave 2 mm (0.8 inches) below the head exposed.
- 4 Maneuver the residential gateway so two of the wall-mount slots line up with the two screws.
- 5 Place the wall-mount slots over the screws and slide the residential gateway down until the screws fit snugly into the wall-mount slots.

## Connecting the Residential Gateway

Perform the following steps to connect the residential gateway.

- 1 Insert a standard RJ-45 Ethernet cable (included) into the Internet port and connect the other end to an xDSL, cable modem, or other Internet device.

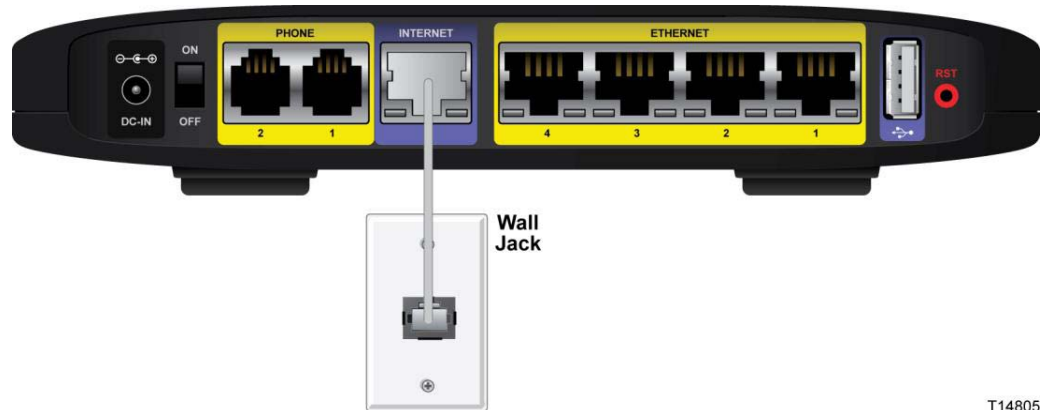

T14805

- 2 Insert a standard RJ-11 telephone cable into the PHONE 1 port and connect the other end to an analog touchtone telephone.

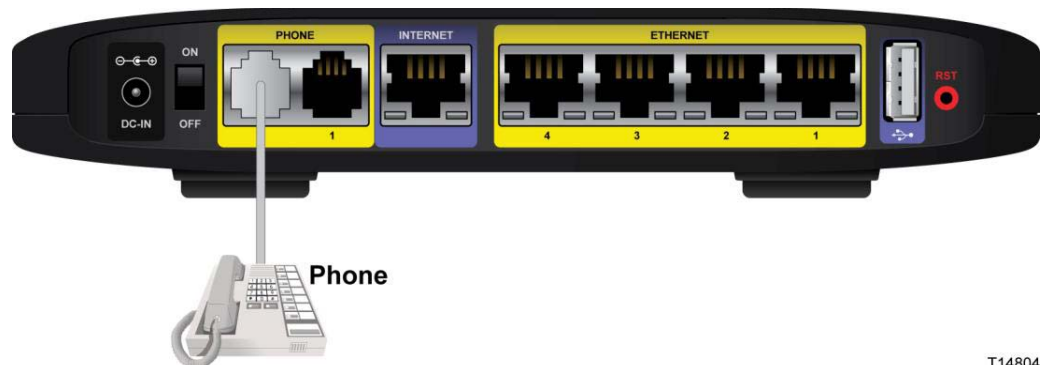

T14804

- 3 (Optional) You can connect the PHONE 2 port to a second analog telephone or a fax machine.

**Note:** To prevent an invalid connection to the circuit switched Telco network, do not connect an RJ-11 telephone cable from the PHONE 1 (or PHONE 2) port on the residential gateway to the wall jack.

## Chapter 2 Installing the Residential Gateway

- (Optional) Connect a PC or other Ethernet device to an ETHERNET port using a standard RJ-45 Ethernet cable.

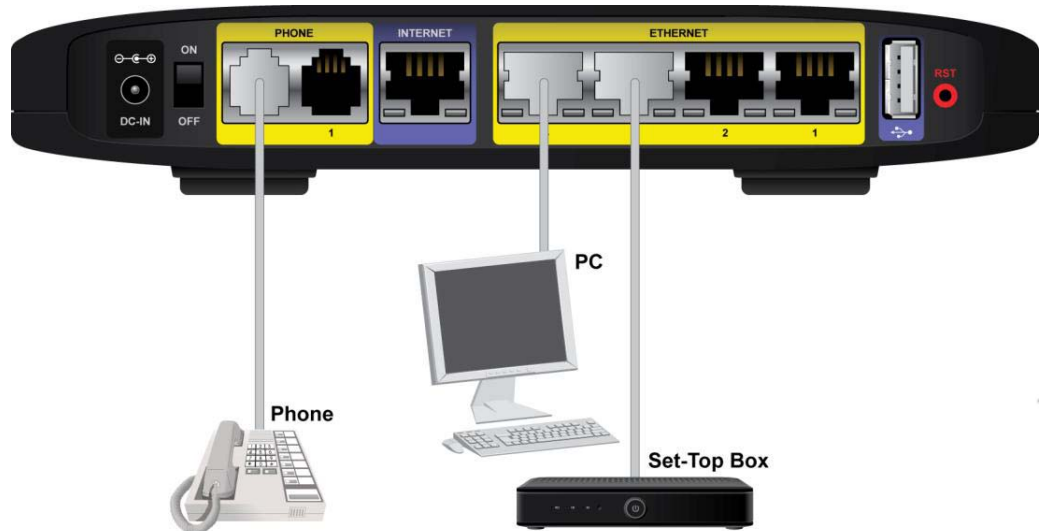

- Connect the included power adapter to the residential gateway power port, and then plug the power adapter into an electrical outlet. The power LED on the front panel will light up as soon as the device powers on.

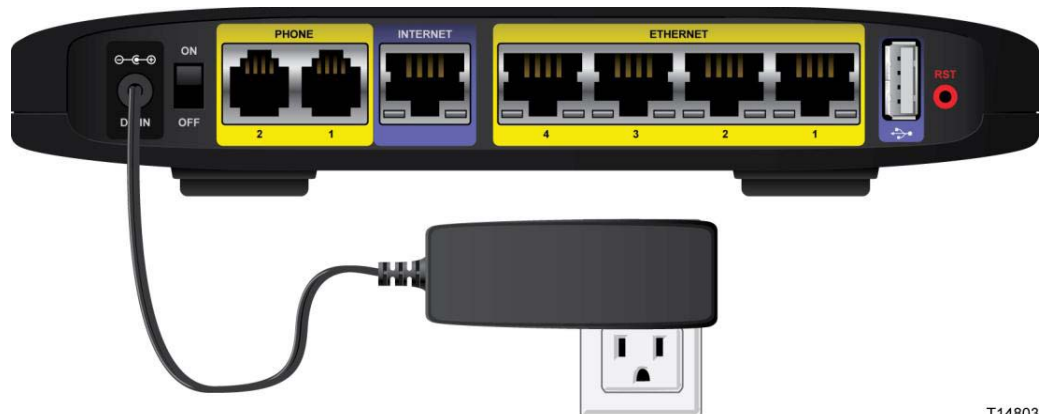

T14803

- Power on the residential gateway. The LCD will light up with a message that the device is booting up.



## Connecting the Residential Gateway

- 7 Follow the instructions in your owner's manual for your PC or laptop to activate the wireless connection.

**Note:** A wireless connection requires a wireless-enabled notebook or a computer with an 802.11b/g/n wireless network adapter installed.

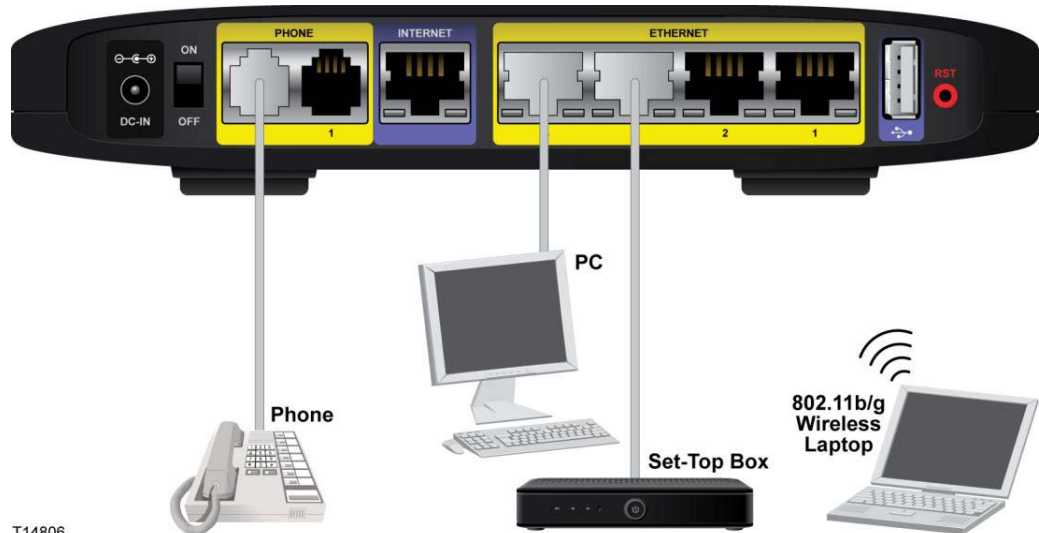

T14806

- 8 Continue with the *Configuration and Operation of the the Residential Gateway* (on page 19) chapter to configure your residential gateway.



# 3

---

## Configuration and Operation of the Residential Gateway

### Introduction

This chapter provides instructions to use the web-based utility to set up connections and configure the residential gateway features.

### In This Chapter

■ Logging into the Residential Gateway.....	20
■ Internet .....	21
■ VoIP Settings .....	25
■ Wi-Fi .....	32
■ Home Address .....	34
■ Media Storage.....	35

## Logging into the Residential Gateway

Complete the following steps to access the web-based utility.

**Note:** If the residential gateway was supplied by your service provider, then it may restrict access to the web-based utility. Contact your service provider for the login information.

- 1 Launch the web browser on your computer.
- 2 Type **192.168.29.1** in the URL Address field. This value is the residential gateway's default IP address.
- 3 Press **Enter**. A login screen appears.
- 4 Is this the first time you have opened the web-based utility?
  - If **yes**, type **admin** in the User name and Password fields.
  - If **no**, enter the user name and password you established previously.
- 5 Click **OK** to continue. The web-based utility opens.
- 6 To continue setup, go to the section applicable for your desired configuration:

## Internet

You will need to select a specific type of connection for your Internet connection. Your selection will determine which additional parameters will be required to complete your configuration.

Complete the following steps to set up your Internet connection.

- 1 From the residential gateway dashboard, click the **Change Connection Type** button located in the Internet cell.

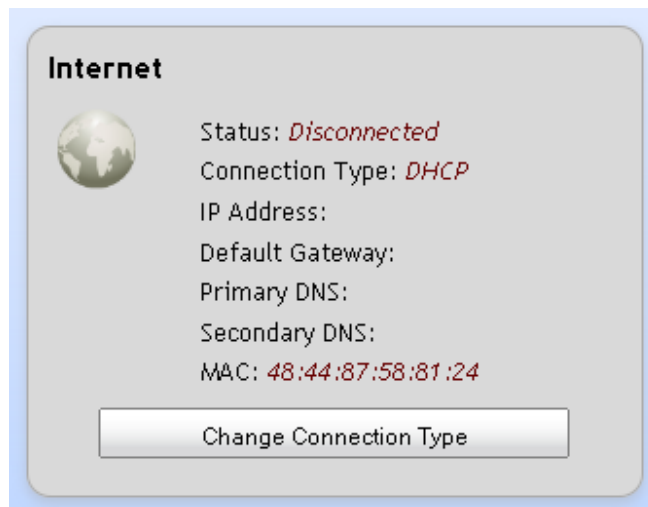

### Chapter 3 Configuration and Operation of the the Residential Gateway

- 2 Select an option from the **Connection Type** drop-down menu.

Internet Connection Type

Status: *Disconnected*

Connection Type:  (Default: DHCP)

Router Name\*:

Host Name\*:

Domain Name\*:

MTU\*:  (Default: Auto)

MTU Size:

\*Optional, but may be required by Internet Service Provider



- 3 Complete the fields for the connection type you selected as follows:

- For all connection types:
  - **Router Name** –
  - **Host Name** – Enter the Host Name of your internet server
  - **Domain Name** – Enter the Domain Name of your local network
  - **MTU** – Select Auto or Manual
  - **MTU Size** – Keep this value in the 1200 to 1500 range. The default MTU is configured automatically.
- For a Static connection:

**Note:** Your service provider may provide static Internet IP address, subnet mask, and default gateway values.

  - **Internet IP Address** – Enter the Gateway's IP address, as seen from the Internet.
  - **Subnet Mask** – Enter the Gateway's Subnet Mask, as seen from the Internet (including your service provider)
  - **Default Gateway** – Enter the IP address of the service provider's server
  - **DNS 1 through DNS 3** – Enter the DNS (Domain Name System) server IP address(es) provided by your service provider. At least one is required.
- For a PPPoE connection:

- **Username and Password** – Enter the Username and Password provided by your service provider.
  - **Connect on Demand** – You can configure the Router to cut the Internet connection after it has been inactive for a specified period of time (Max Idle Time). If your Internet connection has been terminated due to inactivity, Connect on Demand enables the Router to automatically re-establish your connection as soon as you attempt to access the Internet again
  - **Max Idle Time** – Enter the number of minutes you want to have elapsed before your Internet connection terminates. The default Max Idle Time is 5 minutes.
- For a PPTP connection:
    - **Internet IP Address** – Enter the Gateway's IP address, as seen from the Internet
    - **Subnet Mask** – Enter the Gateway's Subnet Mask, as seen from the Internet (including your service provider)
    - **Gateway** – Enter the IP address of the service provider's server
    - **Username and Password** – Enter the Username and Password provided by your service provider.
    - **Connect on Demand** – You can configure the Router to cut the Internet connection after it has been inactive for a specified period of time (Max Idle Time). If your Internet connection has been terminated due to inactivity, Connect on Demand enables the Router to automatically re-establish your connection as soon as you attempt to access the Internet again
    - **Max Idle Time** – Enter the number of minutes you want to have elapsed before your Internet connection terminates. The default Max Idle Time is 5 minutes.
  - For an L2TP connection:
    - **Username and Password** – Enter the Username and Password provided by your service provider.
    - **L2TP Server IP** – Enter the IP address of the L2TP server
    - **Connect on Demand** – You can configure the Router to cut the Internet connection after it has been inactive for a specified period of time (Max Idle Time). If your Internet connection has been terminated due to inactivity, Connect on Demand enables the Router to automatically re-establish your connection as soon as you attempt to access the Internet again
    - **Max Idle Time** – Enter the number of minutes you want to have elapsed before your Internet connection terminates. The default Max Idle Time is 5 minutes.

### Chapter 3 Configuration and Operation of the the Residential Gateway

- 4 Click **Save Changes** to save the information or **Cancel** to return to the dashboard.



## VoIP Settings

### SIP

Complete the following steps to configure the SIP parameters for your VoIP settings.

- 1 From the residential gateway dashboard, click the **Change Settings** button located in the VoIP Settings cell.

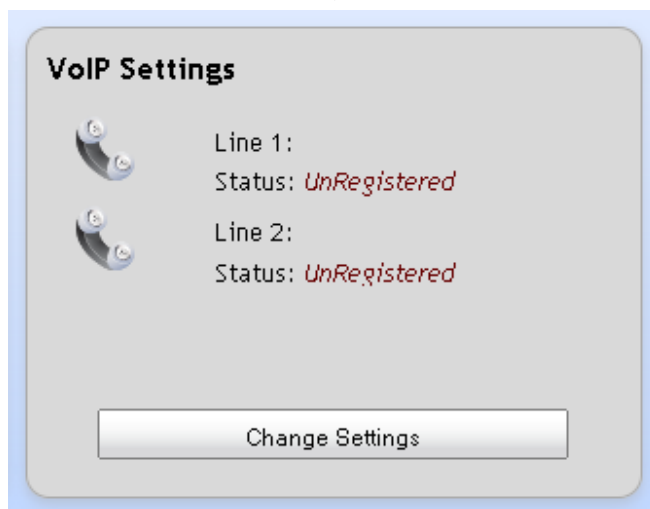

- 2 Complete the fields for the SIP tab.

The screenshot displays a web-based configuration interface for SIP settings. At the top, there are five tabs: 'SIP' (selected), 'Service', 'Voice', 'Advanced', and 'Call Log'. Below the tabs, the interface is divided into two sections for configuring subscriber information for two lines.

**Subscriber Information of Line 1**

Display Name:	<input type="text"/>
User Name:	<input type="text"/>
Auth. ID:	<input type="text"/>
Auth. Password:	<input type="text"/>

**Subscriber Information of Line 2**

Display Name:	<input type="text"/>
User Name:	<input type="text"/>
Auth. ID:	<input type="text"/>

At the bottom of the interface, there is a help icon (a question mark in a blue circle) on the left, and two buttons: 'Save Changes' and 'Cancel' on the right.

- 3 Click **Save Changes** to save the information or **Cancel** to return to the dashboard.

## Service

Complete the following steps to configure the Service parameters for your VoIP settings.

## VoIP Settings

- 1 From the residential gateway dashboard, click the **Change Settings** button located in the VoIP Settings cell.

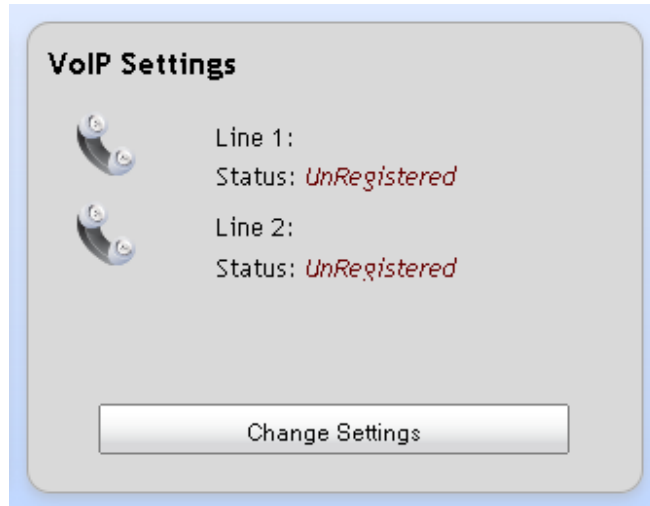

- 2 Complete the fields for the Service tab.

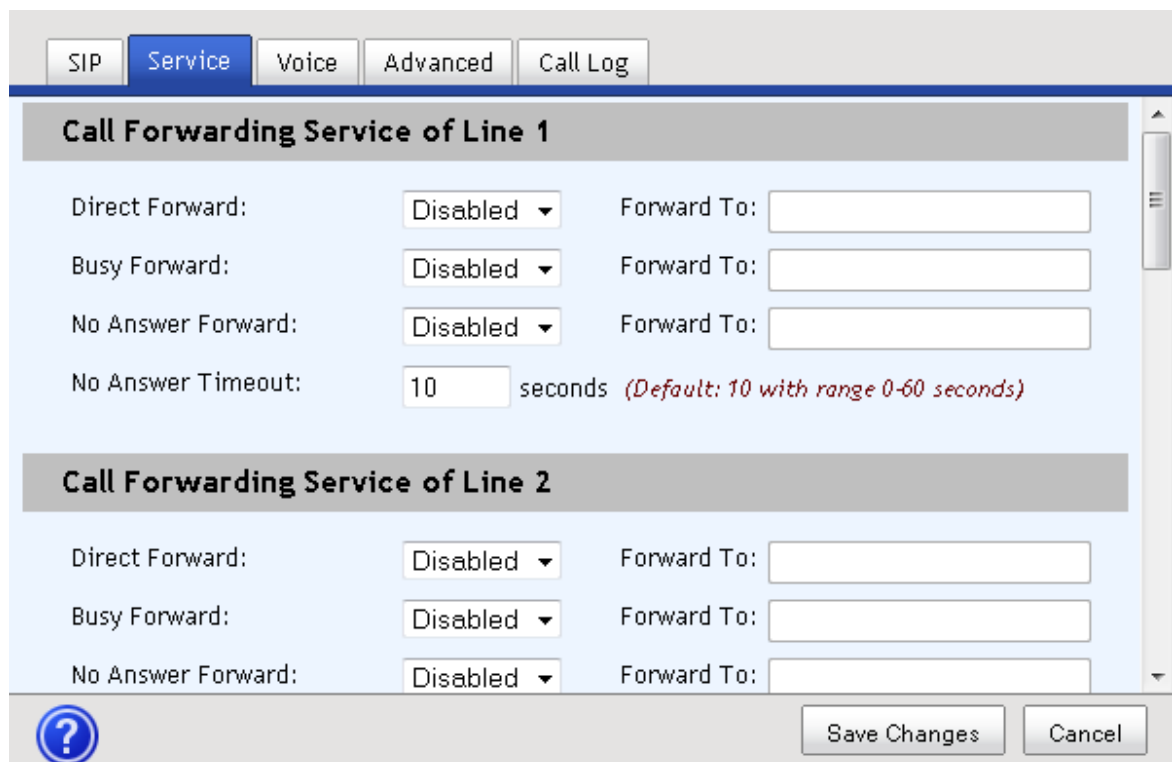
A screenshot of a web interface showing the "Service" tab configuration. At the top, there are tabs for "SIP", "Service", "Voice", "Advanced", and "Call Log", with "Service" selected. Below the tabs is a section titled "Call Forwarding Service of Line 1". This section contains four rows of settings: "Direct Forward:" with a "Disabled" dropdown and an empty "Forward To:" text box; "Busy Forward:" with a "Disabled" dropdown and an empty "Forward To:" text box; "No Answer Forward:" with a "Disabled" dropdown and an empty "Forward To:" text box; and "No Answer Timeout:" with a text box containing "10" and the label "seconds (Default: 10 with range 0-60 seconds)". Below this is a section titled "Call Forwarding Service of Line 2", which has the same layout as Line 1. At the bottom of the page, there is a blue question mark icon on the left and two buttons labeled "Save Changes" and "Cancel" on the right.

- 3 Click **Save Changes** to save the information or **Cancel** to return to the dashboard.

## Voice

Complete the following steps to configure the Voice parameters for your VoIP settings.

- 1 From the residential gateway dashboard, click the **Change Settings** button located in the VoIP Settings cell.

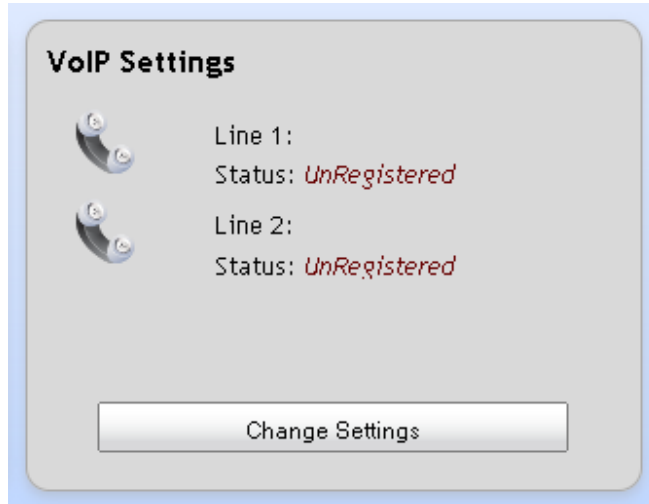

- 2 Complete the fields for the **Voice** tab.

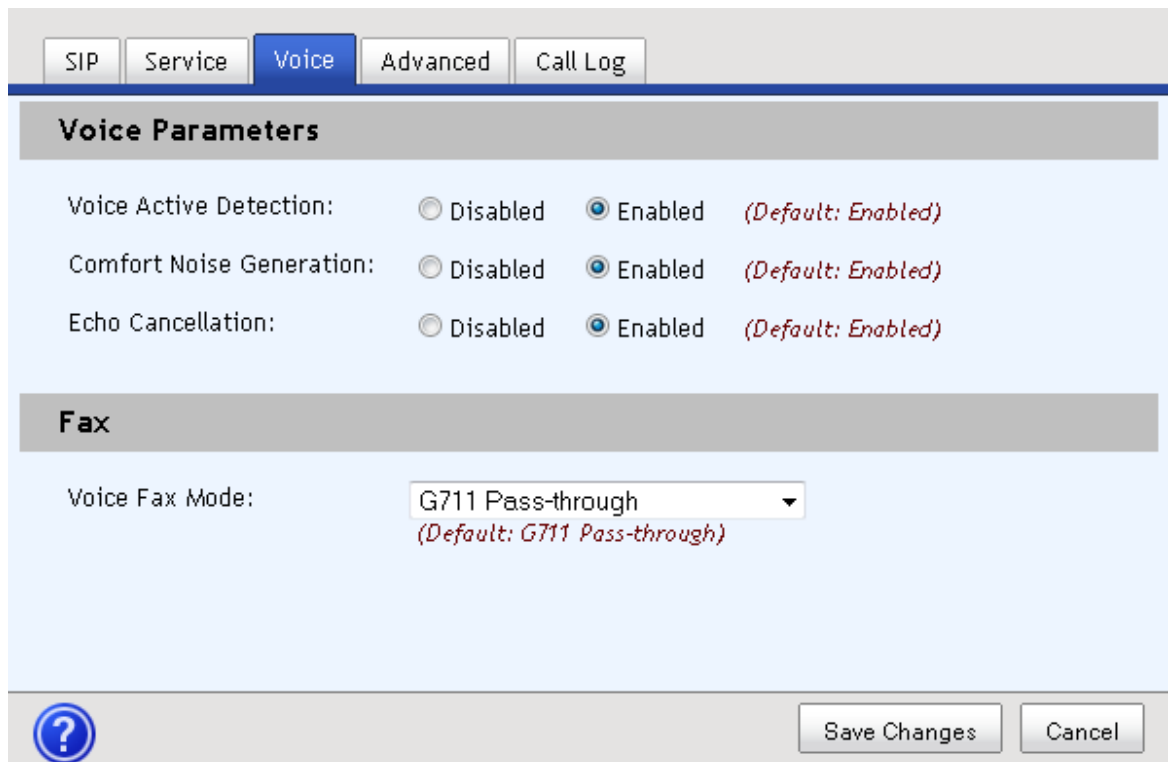

- 3 Click **Save Changes** to save the information or **Cancel** to return to the dashboard.

## Advanced

- 1 From the residential gateway dashboard, click the **Change Settings** button located in the VoIP Settings cell.

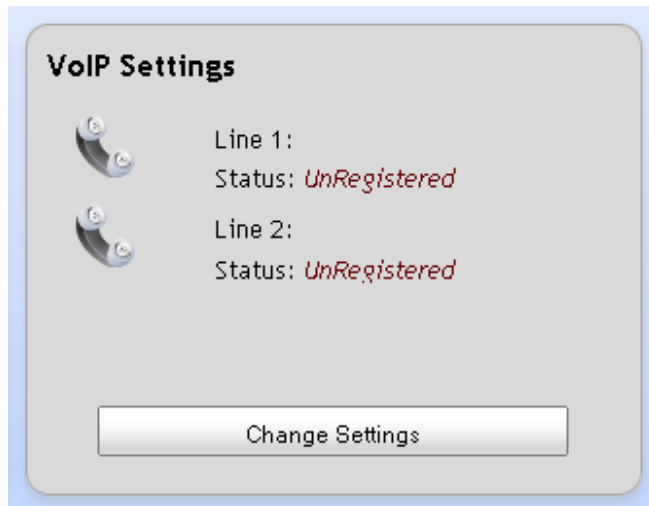

- 2 Complete the fields for the Advanced tab.

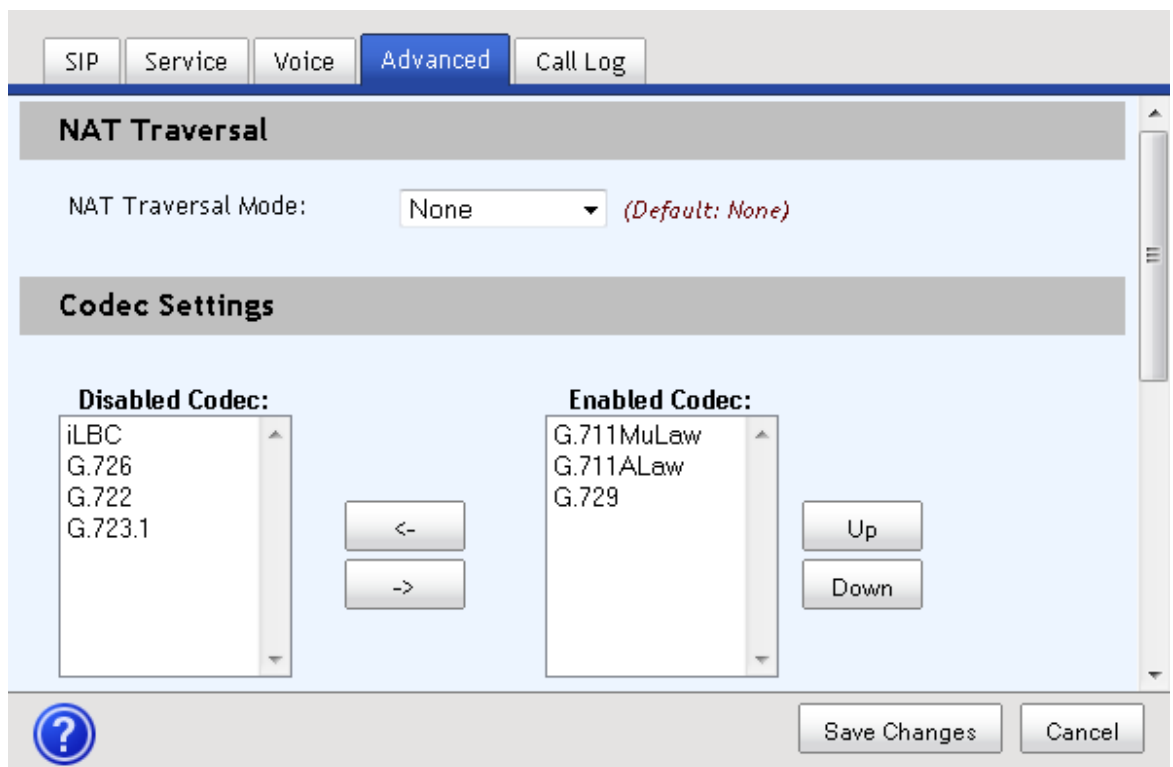

### Chapter 3 Configuration and Operation of the the Residential Gateway

- 3 Click **Save Changes** to save the information or **Cancel** to return to the dashboard.

## Call Log

Complete the following steps to review the Call Log for your VoIP usage.

- 1 From the residential gateway dashboard, click the **Change Settings** button located in the VoIP Settings cell.

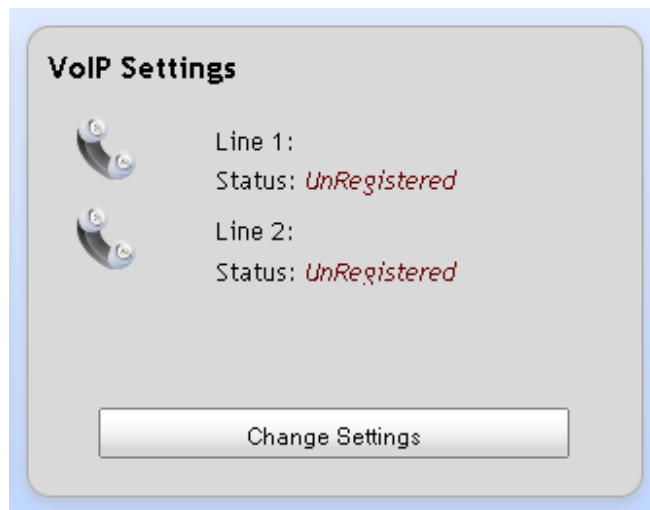

- 2 Click the **Call Log** tab to view the call history for each line.

Line No.	Type	Calling Name	Phone No.	Start Time	Duration
----------	------	--------------	-----------	------------	----------

- 3 Click **Delete** to clear items from the Call Log or **Cancel** to return to the dashboard.

## Wi-Fi

- 1 From the residential gateway dashboard, click the **Change Settings** button located in the Wi-Fi cell.



- 2 Select either the Access Point or Wi-Range Extension options.

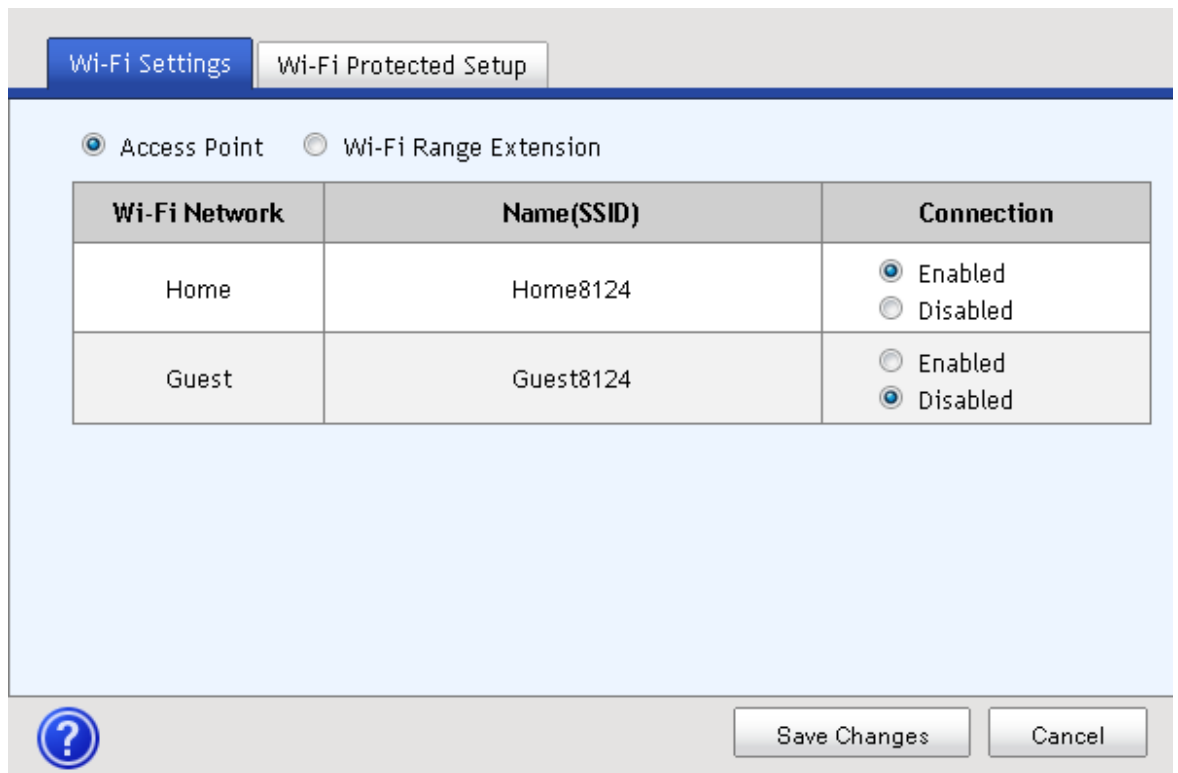

- 3 Complete the fields for the option you selected.
- 4 Click **Save Changes** to save the information or **Cancel** to return to the dashboard.



Wi-Fi

## Home Address

- 1 From the residential gateway dashboard, click the **Edit 911 Address** button located in the Home Address cell.

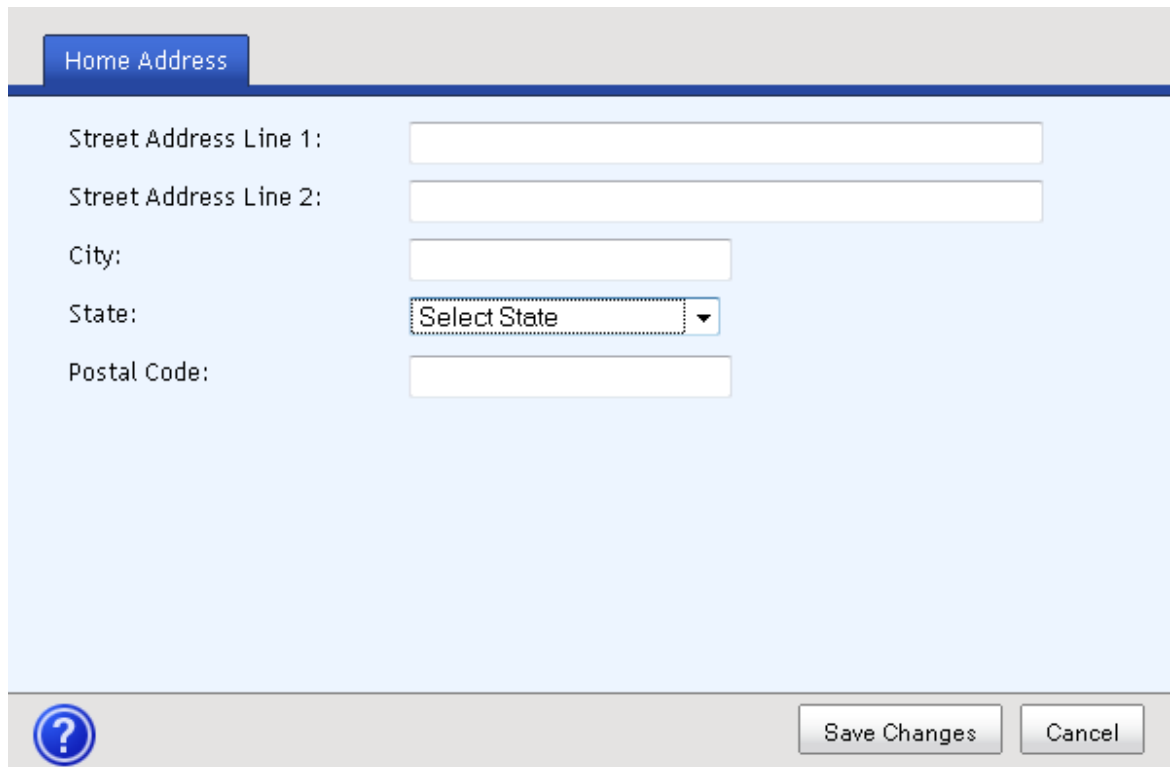

- 2 Complete the fields on the screen.

A screenshot of the "Home Address" configuration form. It features a tab labeled "Home Address" and five input fields: "Street Address Line 1:", "Street Address Line 2:", "City:", "State:" (with a dropdown menu showing "Select State"), and "Postal Code:". At the bottom, there is a help icon (a question mark in a circle) and two buttons: "Save Changes" and "Cancel".

- 3 Click **Save Changes** to save the information or **Cancel** to return to the dashboard.

## Media Storage

- 1 From the residential gateway dashboard, click the **Change Settings** button located in the Media Storage cell.

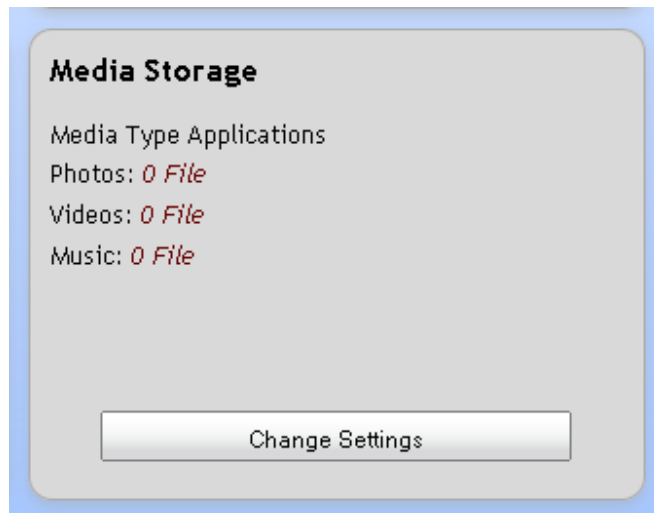

- 2 Complete the fields on the screen.

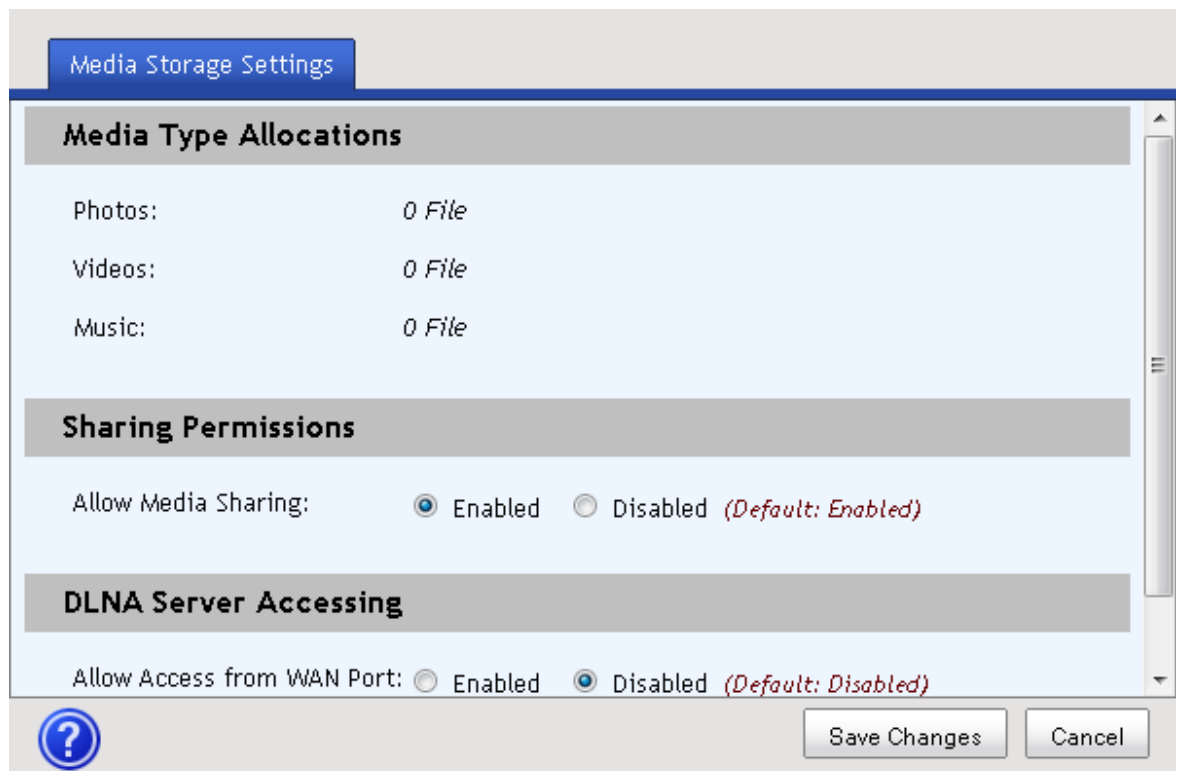

- 3 Click **Save Changes** to save the information or **Cancel** to return to the dashboard.



# 4

---

## Using the LCD

### Introduction

### In This Chapter

- Get Familiar with the LCD Screens and Menus ..... 38
- Internet ..... 41
- Phone ..... 42
- Wi-Fi ..... 44
- Ports ..... 48
- Tools..... 49

## Get Familiar with the LCD Screens and Menus

Follow the steps below to navigate to the Home Page and through the subject pages and menus available from the LCD screen.

- 1 Wave your hand over the LCD. The Home page and the touch-sensitive arrow keys appear. Notice that the House icon is highlighted when the Home page is displayed. As you page through the LCD screens, the device will highlight the icon applicable to the pages or menus you are using.



- 2 Tap the right arrow once and the Internet Status page appears.



- 3 Tap the right arrow again and the Phone Status page appears.



- 4 Tap the right arrow again and the Wi-F Network Status page appears.



Chapter 4 Using the LCD

- 5 Tap the right arrow again and the Ports Status page appears.



- 6 Tap the right arrow again and the Tools menu appears.





## Internet

Follow the steps below to navigate to the Internet Status page.

- 1 Wave your hand over the LCD.
- 2 Tap the right arrow repeatedly until the Internet icon is highlighted. The Internet Status page appears.



- 3 Tap the left arrow to exit this view.

## Phone

Follow the steps below to navigate to the Phone menus and options.

- 1 Wave your hand over the LCD.
- 2 Tap the right arrow repeatedly until the Phone icon is highlighted.



- 3 Tap the down arrow to display the Call Log menu options.



**Note:** The number of calls for each category is displayed in parentheses.

- 4 Tap the down or up arrow to scroll through the menu and highlight the category you want to view.

- 5 Tap the right arrow. The details for the first call in that category appears.



- 6 Tap the down and up arrows to page through the call details for each call in that category.
- 7 Tap the left arrow to exit this view.

## Wi-Fi

### Turn Wi-Fi Off or On

- 1 Wave your hand over the LCD.
- 2 Tap the right arrow repeatedly until the Wi-Fi icon is highlighted.



- 3 Tap the down or up arrow keys to highlight the account you wish to manage.



- 4 Tap the right arrow. Options for the selected account appear.

- 5 Tap the down or up arrow keys to select **Turn Wi-Fi Off/On**.



- 6 Tap the right arrow. A confirmation request appears.

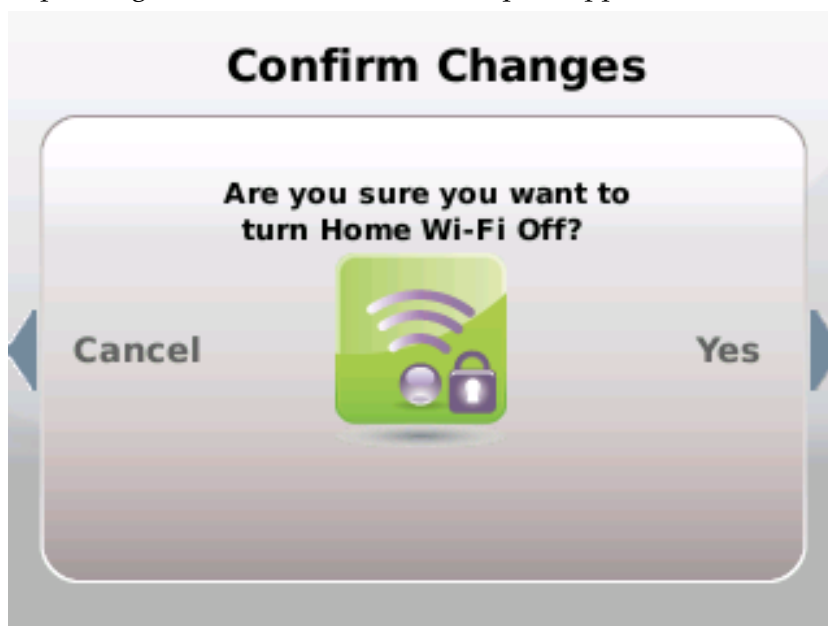

- 7 Tap the right arrow again to accept the change or tap the left arrow to cancel the request.
- 8 Tap the left arrow to exit the account details page.

## Initiate Wi-Fi Protection Setup

Complete the following steps to initiate Wi-Fi Protection Setup.

**Before you proceed:**

- At least one account must already be set up. Go to --- to setup account.
  - Wi-Fi must be turned on for the account you are managing. Go to *Turn Wi-Fi Off or On* (on page 44) if Wi-Fi is not already turned on.
- 1 Wave your hand over the LCD.
  - 2 Tap the right arrow repeatedly until the Wi-Fi icon is highlighted.



- 3 Tap the down or up arrow keys to highlight the account you wish to manage.



- 4 Tap the right arrow. Options for the selected account appear.
- 5 Tap the down or up arrow keys to select **Initiate Wi-Fi Protection Setup**.

- 6 Tap the right arrow. Follow the instructions that appear or tap the left arrow to cancel the request.

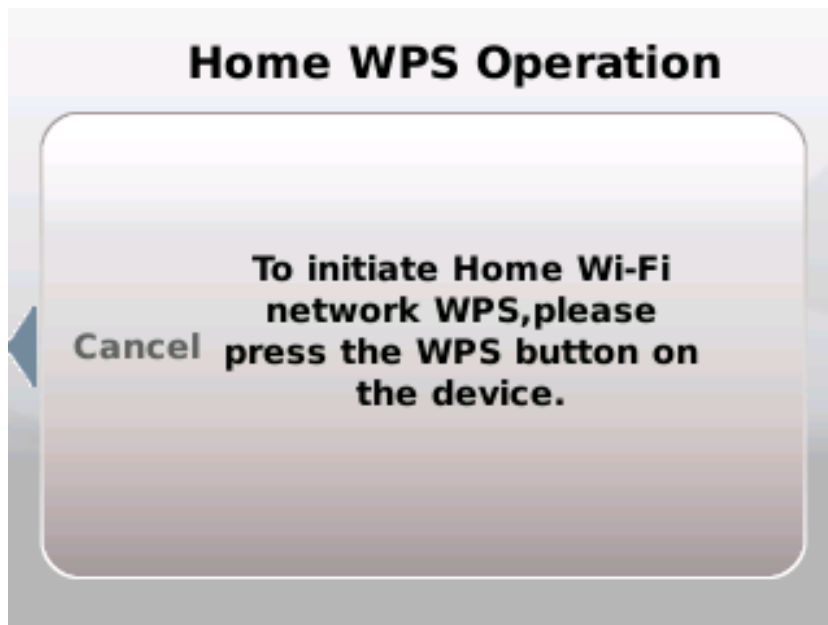

- 7 When initiation is complete, tap the left arrow to exit this view.

## Ports

Follow the steps below to navigate to the Port Status page.

- 1 Wave your hand over the LCD.
- 2 Tap the right arrow repeatedly until the Ports icon is highlighted. The Ports Status page appears.



- 3 Tap the left arrow to exit this view.



## Tools

Follow the steps below to navigate to the Tools menus and options.

- 1 Wave your hand over the LCD.
- 2 Tap the right arrow repeatedly until the Tools icon is highlighted.



- 3 Tap the down arrow to access the Advance Settings menu options.
- 4 Go to the section for the menu option you wish to use for instructions to use that option.

## Review Your Emergency 911 Address

Complete the following steps to review your Emergency 911 Address information.

- 1 Wave your hand over the LCD to activate the display.
- 2 Tap the right arrow repeatedly until the Tools icon is highlighted.

Chapter 4 Using the LCD

- 3 Tap the touch-sensitive down arrow to highlight **Emergency 911 Address**.



- 4 Tap the right arrow to view the current Emergency 911 Address information.



**Note:** Go the following sections in chapter 3 to make changes to this information:

- *Logging into the Residential Gateway* (on page 20)
  - *Home Address* (on page 34)
- 5 Tap the left arrow to exit this view.

## Perform Factory Reset

Complete the following steps to perform a Factory Reset.

- 1 Wave your hand over the LCD to activate the display.
- 2 Tap the right arrow repeatedly until the Tools icon is highlighted.
- 3 Tap the touch-sensitive down arrow to highlight **Factory Reset**.



- 4 Tap the right arrow. Instructions to perform a factory reset appear.

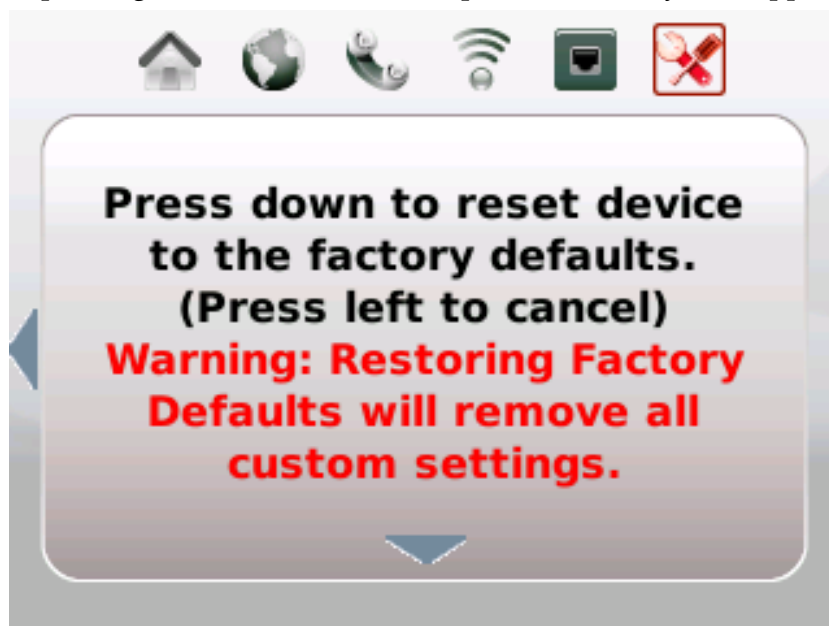

- 5 Follow the instructions that appear in the LCD screen or tap the left arrow to exit without making changes.

## Select Language Settings

Complete the following steps to select your preferred Language.

- 1 Wave your hand over the LCD to activate the display.
- 2 Tap the right arrow repeatedly until the Tools icon is highlighted.
- 3 Tap the touch-sensitive down arrow to highlight **Language**.



- 4 Tap the right arrow to view the current language setting.



- 5 Tap the up or down arrow keys to highlight the language you prefer to appear in the LCD screens and menus.
- 6 Tap the right arrow. A confirmation request appears.
- 7 Tap the right arrow again to accept the change or tap the left arrow to cancel the request.

## View Network Information

Complete the following steps to view your network information.

- 1 Wave your hand over the LCD to activate the display.
- 2 Tap the right arrow repeatedly until the Tools icon is highlighted.
- 3 Tap the touch-sensitive down arrow to highlight **Network Info**.



## Chapter 4 Using the LCD

- 4 Tap the right arrow. The Network Information menu appears.

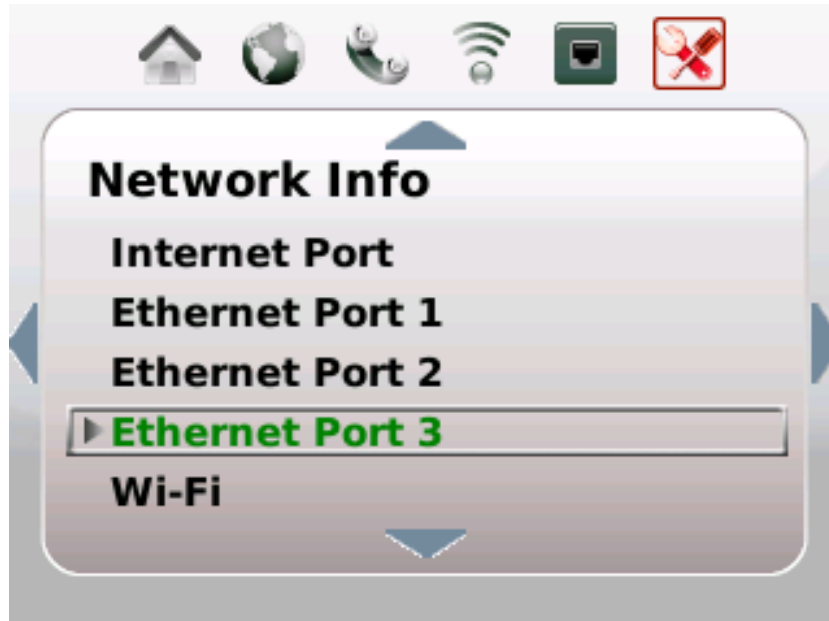

- 5 Tap the up or down arrow keys to highlight the menu option for the information you want to review.
- 6 Tap the right arrow. The Network Information page for that menu option appears.



**Note:** This information is managed by ---. Contact your service provider to request/Go to --- and follow the instructions to make changes to this information.

- 7 Tap the left arrow to exit this view.

## Use Network Tools

Complete the following steps to access and use the Network Tools options.

- 1 Wave your hand over the LCD to activate the display.
- 2 Tap the right arrow repeatedly until the Tools icon is highlighted.
- 3 Tap the touch-sensitive down arrow to highlight **Network Tools**.



- 4 Tap the right arrow to view the Network Tools menu options.



- 5 Tap the up or down arrow keys to highlight the option you want to use.

## Chapter 4 Using the LCD

- 6 Tap the right arrow. A request-in-process message appears followed by a results page.

### Ping in Process

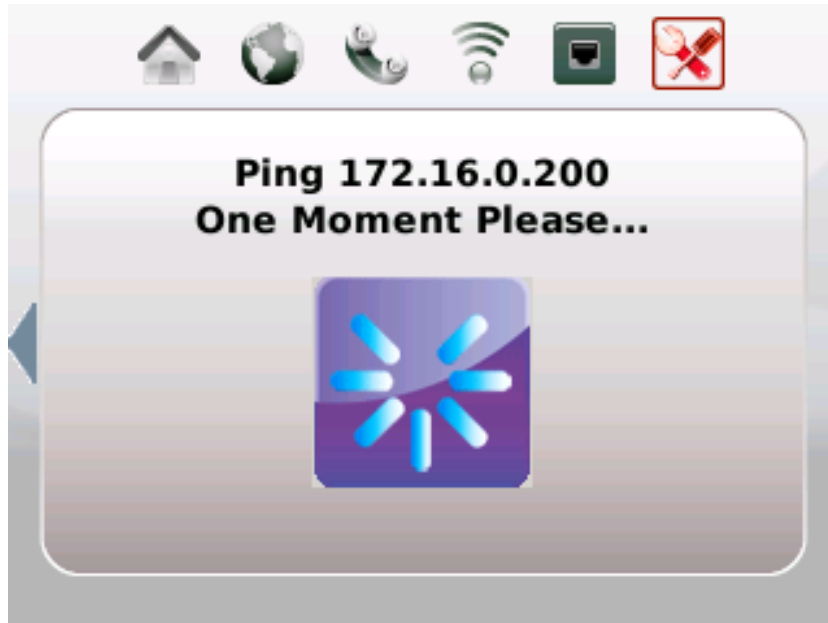

### Ping Results

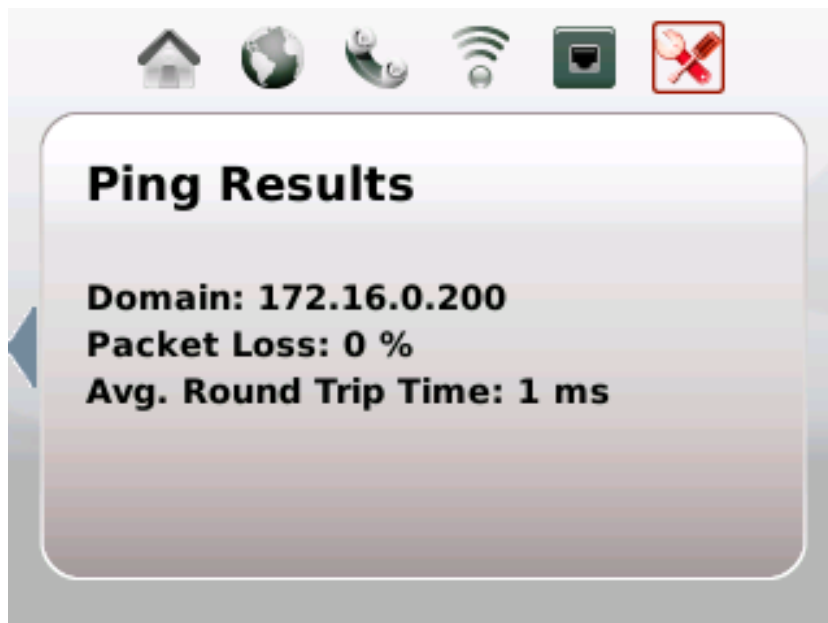

- 7 Tap the left arrow to exit this view.



## View Router Information

Complete the following steps to view your router information.

- 1 Wave your hand over the LCD to activate the display.
- 2 Tap the right arrow repeatedly until the Tools icon is highlighted.
- 3 Tap the touch-sensitive down arrow to highlight **Router Info**.



- 4
- 5 Tap the right arrow. The Router Information page appears.



## Chapter 4 Using the LCD

**Note:** This information is managed by ---. Contact your service provider to request/Go to --- and follow the instructions to make changes to this information.

- 6 Tap the left arrow to exit this view.

### Select LCD Display Orientation

Complete the following steps to select your preferred LCD display orientation.

- 1 Wave your hand over the LCD to activate the display.
- 2 Tap the right arrow repeatedly until the Tools icon is highlighted.
- 3 Tap the touch-sensitive down arrow to highlight **LCD Display Orientation**.



- 4 Tap the right arrow to change the current setting. A confirmation request appears.

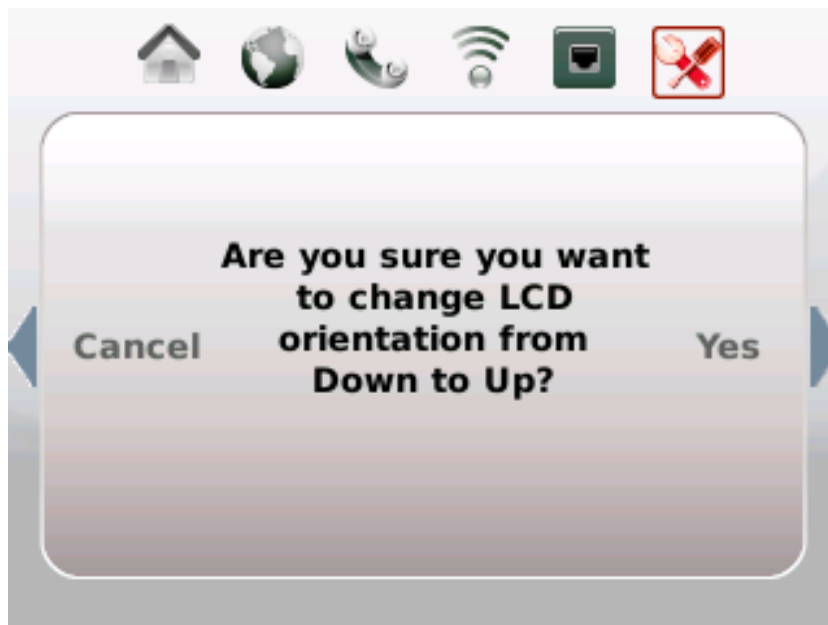

- 5 Tap the right arrow again to accept the change or tap the left arrow to cancel the request.

## View System Event Log

Complete the following steps to view the system event log.

- 1 Wave your hand over the LCD to activate the display.
- 2 Tap the right arrow repeatedly until the Tools icon is highlighted.
- 3 Tap the touch-sensitive down arrow to highlight **Sys Event Log**.



## Chapter 4 Using the LCD

- 4 Tap the right arrow. The System Event Log page appears.

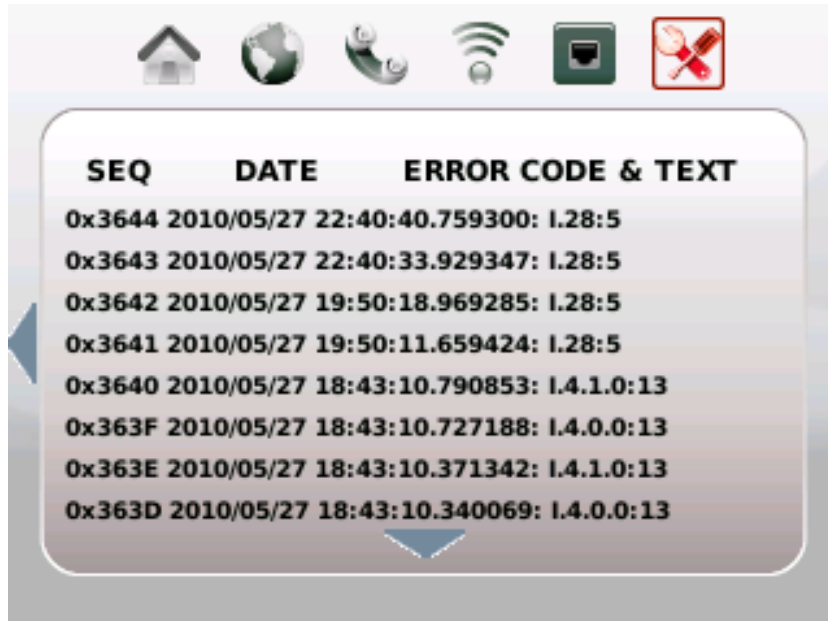

- 5 Tap the left arrow to exit this view.

## Set Up Time of Day Parameters

Complete the following steps to select your preferred Language.

- 1 Wave your hand over the LCD to activate the display.
- 2 Tap the right arrow repeatedly until the Tools icon is highlighted.
- 3 Tap the touch-sensitive down arrow to highlight **Time (Manual Configure)**.



- 4 Tap the right arrow to view the current time zone setting.

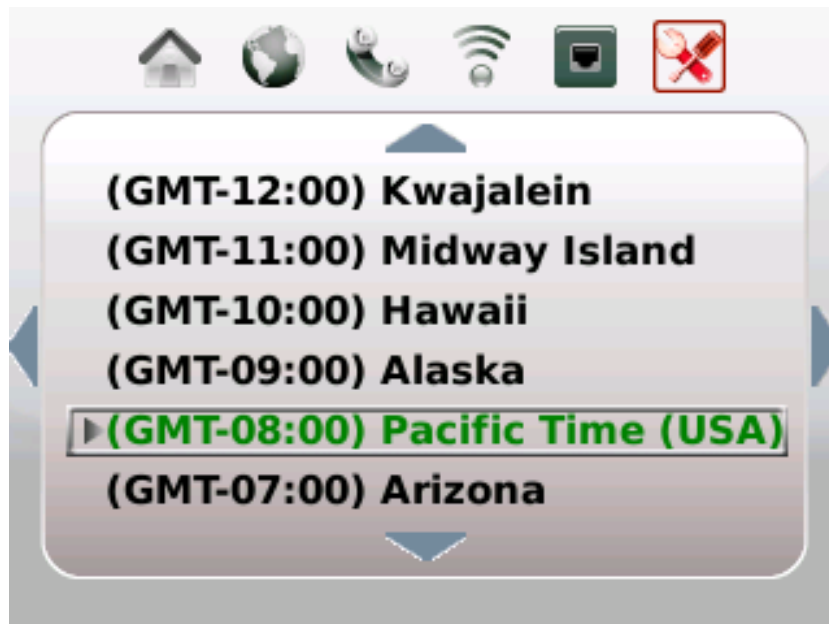

- 5 Tap the up or down arrow keys to highlight the time zone you prefer to use.
- 6 Tap the right arrow. A confirmation message appears.

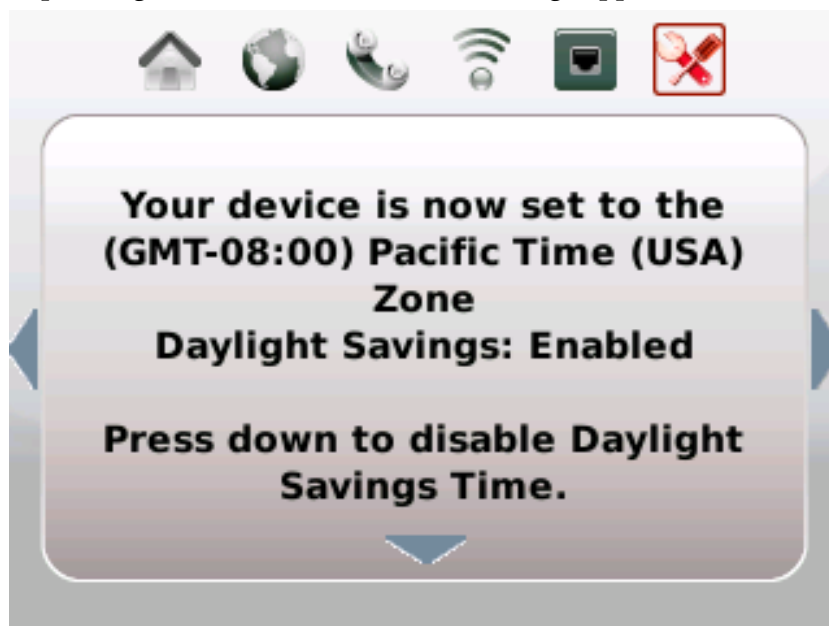

- 7 (Optional) Tap the down arrow to change the Daylight Savings setting.
- 8 Tap the left arrow to exit this view.



# 5

---

## Customer Information

### Introduction

This chapter provides contact information to obtain product support and return products for service.

### In This Chapter

- Customer Support ..... 64
- Return Products for Repair..... 66

## Customer Support

### If You Have Questions

If you have questions about this product, contact the representative who handles your account for information.

If you have technical questions, telephone your nearest technical support office at one of the following telephone numbers.

#### The Americas

---

United States	Cisco® Services Atlanta, Georgia	<b>Technical Support</b> <ul style="list-style-type: none"> <li>■ For <i>Digital Broadband Delivery System</i> products only, call:                             <ul style="list-style-type: none"> <li>– Toll-free: 1-866-787-3866</li> <li>– Local: 770-236-2200</li> <li>– Fax: 770-236-2488</li> </ul> </li> <li>■ For all products <i>other than</i> Digital Broadband Delivery System, call:                             <ul style="list-style-type: none"> <li>– Toll-free: 1-800-722-2009</li> <li>– Local: 678-277-1120</li> <li>– Fax: 770-236-2306</li> </ul> </li> </ul> <b>Customer Service</b> <ul style="list-style-type: none"> <li>■ Toll-free: 1-800-722-2009</li> <li>■ Local: 678-277-1120</li> <li>■ Fax: 770-236-5477</li> </ul>
---------------	-------------------------------------	-------------------------------------------------------------------------------------------------------------------------------------------------------------------------------------------------------------------------------------------------------------------------------------------------------------------------------------------------------------------------------------------------------------------------------------------------------------------------------------------------------------------------------------------------------------------------------------------------------------------------------------------------------------------------------------------------------------------------------------------------------

---

#### The United Kingdom and Europe

---

Europe	European Technical Assistance Center (EuTAC), Belgium	<b>Product Information</b> <ul style="list-style-type: none"> <li>■ Telephone: 32-56-445-444</li> </ul> <b>Technical Support</b> <ul style="list-style-type: none"> <li>■ Telephone: 32-56-445-197 or 32-56-445-155</li> <li>■ Fax: 32-56-445-061</li> </ul>
--------	-------------------------------------------------------	--------------------------------------------------------------------------------------------------------------------------------------------------------------------------------------------------------------------------------------------------------------

---

#### Asia-Pacific

---

China	Hong Kong	<b>Technical Support</b> <p>Telephone: 011-852-2588-4745</p> <p>Fax: 011-852-2588-3139</p>
-------	-----------	--------------------------------------------------------------------------------------------

---



---

**Australia**

Australia      Sydney

**Technical Support**

Telephone: 011-61-2-8446-5394

Fax: 011-61-2-8446-8015

---

**Japan**

Japan      Tokyo

**Technical Support**

Telephone: 011-81-3-5322-2067

Fax: 011-81-3-5322-1311

---

## Additional Information

Access your company's extranet site to view or order additional technical publications. For accessing instructions, contact the representative who handles your account. Check your extranet site often as the information is updated frequently.

## Return Products for Repair

You must obtain a return material authorization (RMA) number before you send products to us for repair or upgrade. To return a product for repair or upgrade, complete the following steps.

- 1 Obtain the following information about the product that you want to return for repair or upgrade:
  - The name and model number (if applicable) of the product and the quantity of returns
  - A reason for the return, such as upgrade or failure symptom
  - Your company name, contact, telephone number, email address, fax number, repair disposition authority, and any service contract details
  - A purchase order number

**Notes:**

- If you are unable to issue a purchase order at the time you request an RMA number, a proforma invoice will be sent to you at the completion of repair. This invoice lists all costs incurred.
- We must receive a purchase order within 15 days of receipt of proforma.

**Important:** In-warranty products can accrue costs through damage or misuse, or if no problem is found. Products incurring costs will not be returned to the customer without a valid purchase order.

- 2 Telephone or fax Factory Services at one of the following numbers to request an RMA number:
  - From North America, call:
    - Tel: 1-800-722-2009
    - Fax: 770-236-5477
  - From Europe, Middle East, or Africa, call:
    - Tel: 32-56-445-444
    - Fax: 32-56-445-051
  - From Latin America, call:
    - Tel: 1-770-236-5662
    - Fax: 1-770-236-5888
  - From Asia Pacific, call:
    - Tel: 852-2588-4746
    - Fax: 852-2588-3139

**Result:** The customer service representative will provide the RMA number and the shipping instructions to you.

**Note:** RMA numbers are only valid for 60 days. You must contact a customer service representative to revalidate your RMA numbers if the number is older than 60 days. After the RMA number is revalidated, you can return the product.

- 3 Pack the product in its original container and protective packing material.

**Important:**

- If the original container and packing material are no longer available, pack the product in a sturdy, corrugated box and cushion it with packing material that is appropriate for the method of shipping.
- You are responsible for delivering the returned goods to us safely and undamaged. Improperly packaged shipments, which may have caused additional damage, may be refused and returned to you at your expense.
- Do not return any power cords or accessories.

- 4 Write the following information on the outside of the container:

- Your name
- Your complete address
- Your Telephone number
- RMA number
- Problem description (for product failures)

**Important:** Absence of the RMA number may delay processing your product for repair. Include the RMA number in all correspondence.

- 5 Ship the product to the address you receive from the customer service representative.

**Important:** We do not accept freight collect. Be sure to prepay all shipments.



Cisco Systems, Inc.  
5030 Sugarloaf Parkway, Box 465447  
Lawrenceville, GA 30042

678.277.1000  
[www.cisco.com](http://www.cisco.com)

This document includes various trademarks of Cisco Systems, Inc. Please see the Notices section of this document for a list of the Cisco Systems, Inc. trademarks used in this document.

Product and service availability are subject to change without notice.

© 2010 Cisco Systems, Inc. All rights reserved.

DRAFT 2010 Printed in United States of America

Part Number 4038767 Rev A