

# Test Report

## C9124AXD-A/-B

Cisco Catalyst C9124AX Series 802.11ax Access Point  
2.4GHz Wi-Fi Radio

FCC ID: LDK-HTIAK2282  
IC: 2461N-HTIAK2282

**2400-2483.5 MHz**

Against the following Specifications:



CFR47 Part 15.247  
RSS-247  
RSS-Gen



Cisco Systems

170 West Tasman Drive

San Jose, CA 95134

	
<b>Author:</b> Johanna Knudsen <b>Tested By:</b> Julian Land, Said Abdelwafi	<b>Approved By:</b> Sam Kim <b>Title:</b> Manager, Radio Compliance <b>Revision:</b> 1

This report replaces any previously entered test report under EDCS – 21574927. This test report has been electronically authorized and archived using the CISCO Engineering Document Control system. Test Report Template EDCS# 11644121.

<b>SECTION 1: OVERVIEW .....</b>	<b>3</b>
<b>SECTION 2: ASSESSMENT INFORMATION .....</b>	<b>4</b>
2.1 GENERAL .....	4
2.2 DATE OF TESTING .....	6
2.3 REPORT ISSUE DATE .....	6
2.4 TESTING FACILITIES .....	6
2.5 EQUIPMENT ASSESSED (EUT) .....	6
2.6 EUT DESCRIPTION .....	7
<b>SECTION 3: RESULT SUMMARY .....</b>	<b>8</b>
3.1 RESULTS SUMMARY TABLE .....	8
<b>SECTION 4: SAMPLE DETAILS.....</b>	<b>11</b>
<b>APPENDIX A: EMISSION TEST RESULTS .....</b>	<b>12</b>
CONDUCTED TEST SETUP DIAGRAM.....	12
A.1 DUTY CYCLE .....	13
A.2 DTS BANDWIDTH (6dB BANDWIDTH).....	15
A.3 OCCUPIED BANDWIDTH .....	20
A.4 MAXIMUM CONDUCTED OUTPUT POWER .....	24
A.5 POWER SPECTRAL DENSITY .....	35
A.6 CONDUCTED SPURIOUS EMISSIONS.....	46
A.8 CONDUCTED BANDEDGE (RESTRICTED BAND) .....	68
A.9 CONDUCTED BANDEDGE (NON-RESTRICTED BAND) .....	83
<b>APPENDIX B: EMISSION TEST RESULTS .....</b>	<b>90</b>
RADIATED EMISSION SETUP DIAGRAM-BELOW 1G.....	90
B.1 RADIATED SPURIOUS EMISSIONS .....	91
B.2 RECEIVER SPURIOUS EMISSIONS .....	92
B.3 RADIATED EMISSIONS 30MHZ TO 1GHZ .....	93
B.4 AC CONDUCTED EMISSIONS .....	94
<b>APPENDIX C: LIST OF TEST EQUIPMENT USED TO PERFORM THE TEST.....</b>	<b>95</b>
<b>APPENDIX D: ABBREVIATION KEY AND DEFINITIONS .....</b>	<b>96</b>
<b>APPENDIX E: PHOTOGRAPHS OF TEST SETUPS .....</b>	<b>97</b>
<b>APPENDIX F: SOFTWARE USED TO PERFORM TESTING.....</b>	<b>97</b>
<b>APPENDIX G: TEST PROCEDURES .....</b>	<b>97</b>
<b>APPENDIX H: SCOPE OF ACCREDITATION (A2LA CERTIFICATE NUMBER 1178-01) .....</b>	<b>97</b>
<b>APPENDIX I: TEST ASSESSMENT PLAN .....</b>	<b>97</b>
<b>APPENDIX J: WORST CASE JUSTIFICATION .....</b>	<b>97</b>

## Section 1: Overview

The samples were assessed against the tests under the requirements of the following specifications:

Emission
CFR47 Part 15.247 RSS-247 Issue 2: Feb 2017 RSS-Gen Issue 5: Apr 2018

## Section 2: Assessment Information

### 2.1 General

This report contains an assessment of an apparatus against Electromagnetic Compatibility Standards based upon tests carried out on the samples submitted. The testing was performed by and for the use of Cisco systems Inc:

With regard to this assessment, the following points should be noted:

- a) The results contained in this report relate only to the items tested and were obtained in the period between the date of the initial assessment and the date of issue of the report. Manufactured products will not necessarily give identical results due to production and measurement tolerances.
- b) The apparatus was set up and exercised using the configuration and modes of operation defined in this report only.
- c) Where relevant, the apparatus was only assessed using the susceptibility criteria defined in this report and the Test Assessment Plan (TAP).
- d) All testing was performed under the following environmental conditions:  
Temperature            15°C to 35°C (54°F to 95°F)  
Atmospheric Pressure   860mbar to 1060mbar (25.4" to 31.3")  
Humidity                10% to 75\*%  
  
\*[Where applicable] For ESD testing the humidity limits used were 30% to 60% and for EFT/B tests the humidity limits used were 25% to 75%.
- e) All AC testing was performed at one or more of the following supply voltages:  
110V 60 Hz (+/-20%)

### Units of Measurement

The units of measurements defined in the appendices are reported in specific terms, which are test dependent.

Where radiated measurements are concerned these are defined at a particular distance. Basic voltage measurements are defined in units of [dBuV]

As an example, the basic calculation for all measurements is as follows:

$$\text{Emission level [dBuV]} = \text{Indicated voltage level [dBuV]} + \text{Cable Loss [dB]} + \text{Other correction factors [dB]}$$

The combinations of correction factors are dependent upon the exact test configurations [see test equipment lists for further details] and may include:-

Antenna Factors, Pre Amplifier Gain, LISN Loss, Pulse Limiter Loss and Filter Insertion Loss..

Note: to convert the results from dBuV/m to uV/m use the following formula:-

$$\text{Level in uV/m} = \text{Common Antilogarithm } [(X \text{ dBuV/m})/20] = Y \text{ uV/m}$$

## Measurement Uncertainty Values

voltage and power measurements	± 2 dB
conducted EIRP measurements	± 1.4 dB
radiated measurements	± 3.2 dB
frequency measurements	± 2.4 10 <sup>-7</sup>
temperature measurements	± 0.54°
humidity measurements	± 2.3%
DC and low frequency measurements	± 2.5%

Where relevant measurement uncertainty levels have been estimated for tests performed on the apparatus. This uncertainty represents an expanded uncertainty expressed at approximately the 95% confidence level using a coverage factor of k=2.

Radiated emissions (expanded uncertainty, confidence interval 95%)

30 MHz - 300 MHz	+/- 3.8 dB
300 MHz - 1000 MHz	+/- 4.3 dB
1 GHz - 10 GHz	+/- 4.0 dB
10 GHz - 18GHz	+/- 8.2 dB
18GHz - 26.5GHz	+/- 4.1 dB
26.5GHz - 40GHz	+/- 3.9 dB

Conducted emissions (expanded uncertainty, confidence interval 95%)

30 MHz – 40GHz	+/- 0.38 dB
----------------	-------------

A product is considered to comply with a requirement if the nominal measured value is below the limit line.  
The product is considered to not be in compliance in case the nominal measured value is above the limit line.

**This report must not be reproduced except in full, without written approval of Cisco Systems.**

## 2.2 Date of testing

02-MAR-2021 through 25-MAR-2021

## 2.3 Report Issue Date

06-APR-2021

Cisco uses an electronic system to issue, store and control the revision of test reports. This system is called the Engineering Document Control System (EDCS). The actual report issue date is embedded into the original file on EDCS. Any copies of this report, either electronic or paper, that are not on EDCS must be considered uncontrolled.

## 2.4 Testing facilities

This assessment was performed by:

### Testing Laboratory

Cisco Systems, Inc.  
125 West Tasman Drive (Building P)  
San Jose, CA 95134  
USA

### Headquarters

Cisco Systems, Inc.,  
170 West Tasman Drive  
San Jose, CA 95134,  
USA

### Registration Numbers for Industry Canada

Cisco System Site	Address	Site Identifier
Building P, 10m Chamber	125 West Tasman Dr San Jose, CA 95134	Company #: 2461N-2
Building P, 5m Chamber	125 West Tasman Dr San Jose, CA 95134	Company #: 2461N-1
Building 7, 5m Chamber	425 E. Tasman Drive San Jose, California 95134	Company #: 2461N-3

### Test Engineers

Said Abdelwafi, Julian Land

## 2.5 Equipment Assessed (EUT)

C9124AXI

## 2.6 EUT Description

The Cisco Catalyst 9124AX Series outdoor access points are next-generation Wi-Fi 6 access points encased in a rugged and robust design that service providers and enterprises can easily deploy.

The radio supports the following modes of operation. The modes are further defined in the radio Theory of Operation. The modes included in this report represent the worst-case data for all modes.

802.11b (1-11Mbps)  
802.11g (6-54Mbps)  
802.11n HT20 (MCS0 – MCS31)  
802.11ax HE20 (MCS0-MCS11, 4SS)

The following antennas are supported by this product series. Please note, the antenna information has been provided by the customer (the Cisco business unit). The data included in this report represent the worst-case data for all antennas.

### Ithaca (Internal Antenna) Model C9124AXD-x

Frequency	Antenna Name		Antenna Gain
2.4GHz & 5GHz (Wi-Fi)	Antenna 1	TX/RX: internal	9dBi@2.4GHz 9dBi@5GHz
2.4GHz & 5GHz (Wi-Fi)	Antenna 2	TX/RX: internal	9dBi@2.4GHz 9dBi@5GHz
2.4GHz & 5GHz (Wi-Fi)	Antenna 3	TX/RX: internal	9dBi@2.4GHz 9dBi@5GHz
2.4GHz & 5GHz (Wi-Fi)	Antenna 4	TX/RX: internal	9dBi@2.4GHz 9dBi@5GHz
BLE	Antenna T	TX/RX: internal	4dBi
2.4GHz & 5GHz (Aux)	Antenna A	TX/RX: internal	9dBi@2.4GHz 9dBi@5GHz
2.4GHz & 5GHz (Aux)	Antenna B	RX: internal	9dBi@2.4GHz 9dBi@5GHz

## **Section 3: Result Summary**

### **3.1 Results Summary Table**

#### **Conducted emissions**



Basic Standard	Technical Requirements / Details	Result
FCC 15.247 RSS-247	<p><b>6dB Bandwidth</b> Systems using digital modulation techniques may operate in the 2400-2483.5MHz band. The minimum 6dB bandwidth shall be at least 500 kHz</p>	Pass
FCC 15.247 RSS-247	<p><b>99% &amp; 26 dB Bandwidth:</b> The 99% occupied bandwidth is the frequency bandwidth such that, below its lower and above its upper frequency limits, the mean powers are each equal to 0.5% of the total mean power of the given emission. There is no limit for 99% OBW.</p> <p>The 26 dB emission is the width of the emission that is constrained by the frequencies associated with the two outermost amplitude points (upper and lower frequencies) that are attenuated by 26 dB relative to the maximum level measured in the fundamental emission.</p>	Pass
FCC 15.247 RSS-247	<p><b>Output Power:</b> <b>15.247</b> The maximum conducted output power of the intentional radiator for systems using digital modulation in the 2400-2483.5 MHz band shall not exceed 1 Watt (30dBm). If transmitting antennas of directional gain greater than 6 dBi are used, the maximum conducted output power shall be reduced by the amount in dB that the directional gain of the antenna exceeds 6 dBi.</p> <p><b>RSS-247</b> For DTSs employing digital modulation techniques operating in the band 2400-2483.5 MHz, the maximum peak conducted output power shall not exceed 1W. Except as provided in Section 5.4(e), the e.i.r.p. shall not exceed 4 W.</p>	Pass
FCC 15.247 RSS-247	<p><b>Power Spectral Density</b> For digitally modulated systems, the power spectral density conducted from the intentional radiator to the antenna shall not be greater than 8 dBm in any 3 kHz band during any time interval of continuous transmission.</p>	Pass
FCC 15.247 RSS-247	<p><b>Conducted Spurious Emissions / Band-Edge:</b> In any 100 kHz bandwidth outside the frequency band in which the spread spectrum or digitally modulated device is operating, the RF power that is produced shall be at least 20 dB below that in the 100 kHz bandwidth within the band that contains the highest level of the desired power, based on either an RF conducted or a radiated measurement, provided that the transmitter demonstrates compliance with the peak conducted power limits. If the transmitter complies with the conducted power limits based on the use of root-mean-square averaging over a time interval, as permitted under section 5.4(d), the attenuation required shall be 30 dB instead of 20 dB. Attenuation below the general field strength limits specified in RSS-Gen is not required.</p>	Pass
FCC 15.247 RSS-247 FCC 15.205 RSS-Gen	<p><b>Restricted band:</b> Unwanted emissions falling within the restricted bands, as defined in FCC 15.205 (a) and RSS-Gen 8.10 must also comply with the radiated emission limits specified in FCC 15.209 (a) and RSS-Gen 8.9</p>	Pass

**Radiated Emissions (General requirements)**

<b>Basic Standard</b>	<b>Technical Requirements / Details</b>	<b>Result</b>
FCC 15.209 RSS-Gen	<b>TX Spurious Emissions:</b> Except as provided elsewhere in this subpart, the emissions from an intentional radiator shall not exceed the field strength levels specified in the filed strength limits table in this section. Unwanted emissions falling within the restricted bands, as defined in FCC 15.205 (a) and RSS-Gen 8.10 must also comply with the radiated emission limits specified in FCC 15.209 (a) and RSS-Gen 8.9	Not covered by the scope of this test report
FCC 15.207 RSS-Gen	<b>AC conducted Emissions:</b> Except when the requirements applicable to a given device state otherwise, for any radio apparatus equipped to operate from the public utility AC power supply, either directly or indirectly (such as with a battery charger), the radio frequency voltage of emissions conducted back onto the AC power lines in the frequency range of 0.15 MHz to 30 MHz shall not exceed the limits shown in the table in these sections. The more stringent limit applies at the frequency range boundaries.	Not covered by the scope of this test report

#### Section 4: Sample Details

Note: Each sample was evaluated to ensure that its condition was suitable to be used as a test sample prior to the commencement of testing.

##### 4.1 Sample Details

Sample No.	Equipment Details	Manufacturer	Hardware Rev.	Serial Number
S01	C9124AXI-A (used in Rack 9)	Foxconn (for Cisco)	074-125082-01	FOC243919ZU

##### 4.2 System Details

System #	Description	Samples
1	EUT (used in Rack 9)	S01

##### 4.3 Mode of Operation Details

Mode#	Description	Comments
1	Continuous Transmit Testing using Rack 9	AP Running Image: 8.8.1.10 Cisco AP Software, (ap1g6a), [sjc-ads-9175:/nobackup/rahulsi6/ithaca/c175_throttle/router] Compiled Wed Feb 17 19:47:58 PST 2021

# Appendix A: Emission Test Results

## Conducted Test Setup Diagram

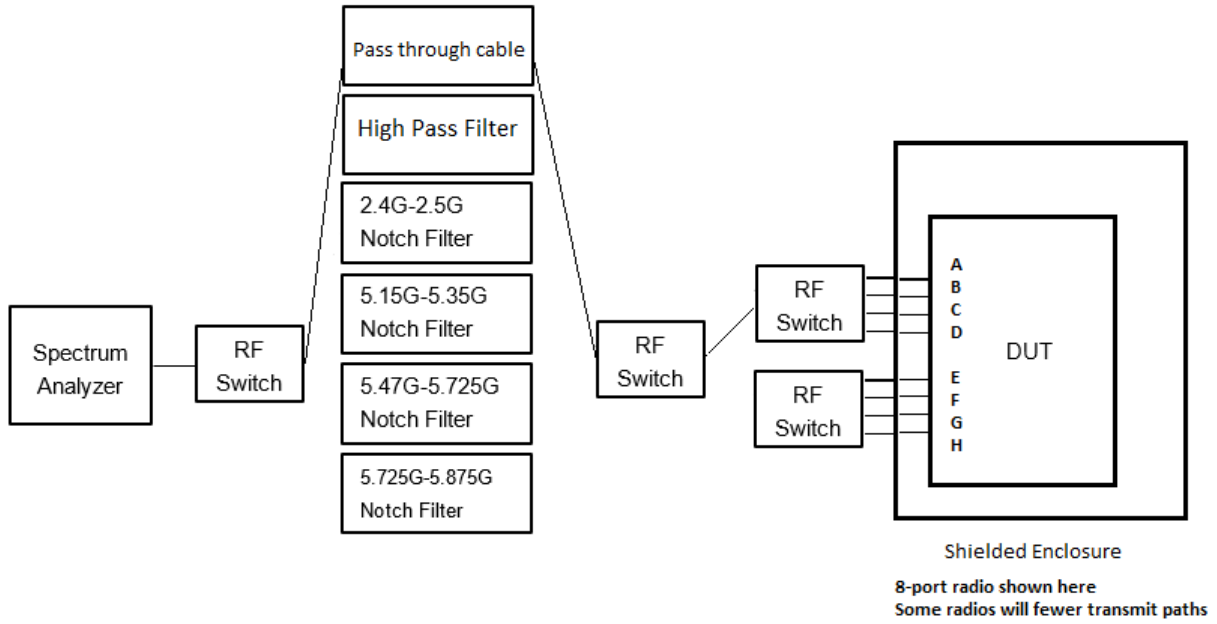

## A.1 Duty Cycle

### Duty Cycle Test Requirement

From KDB 558074, Section 6

#### 6.0 Duty cycle, transmission duration and maximum power control level

Preferably, all measurements of maximum conducted (average) output power will be performed with the EUT transmitting continuously (*i.e.*, with a duty cycle of greater than or equal to 98%). When continuous operation cannot be realized, then the use of sweep triggering/signal gating techniques can be utilized to ensure that measurements are made only during transmissions at the maximum power control level. ...

When continuous transmission cannot be achieved and sweep triggering/signal gating cannot be implemented, alternate procedures are provided that can be used to measure the average power; however, they will require an additional measurement of the transmitter duty cycle. Within this guidance document, the duty cycle refers to the fraction of time over which the transmitter is on and is transmitting at its maximum power control level. The duty cycle is considered to be constant if variations are less than  $\pm 2$  percent, otherwise the duty cycle is considered to be non-constant.

### Duty Cycle Test Method

From KDB 558074, Section 6:

The zero-span mode on a spectrum analyzer or EMI receiver if the response time and spacing between bins on the sweep are sufficient to permit accurate measurements of the on and off times of the transmitted signal. Set the center frequency of the instrument to the center frequency of the transmission. Set  $RBW \geq OBW$  if possible; otherwise, set RBW to the largest available value. Set  $VBW \geq RBW$ . Set detector = peak or average. The zero-span measurement method shall not be used unless both RBW and VBW are  $> 50/T$  and the number of sweep points across duration T exceeds 100. (For example, if VBW and/or RBW are limited to 3 MHz, then the zero-span method of measuring duty cycle shall not be used if  $T \leq 16.7$  microseconds.)

### Duty Cycle Test Information

<b>Tested By :</b> Said Abdelwafi, Julian Land	<b>Date of testing:</b> 02-MAR-2021 through 25-MAR-2021
<b>Test Result : PASS</b>	

### Test Equipment

See Appendix C for list of test equipment

## Duty Cycle Data Table

Duty Cycle table and screen captures are shown below for power/psd modes.

Frequency (MHz)	Mode	Data Rate (Mbps)	Duty Cycle Correction Factor (dB)
2412	CCK, 1 to 11 Mbps	11.0	1.40922
	Non HT20, 6 to 54 Mbps	6.0	0.3659
	HT/VHT20, M0 to M7	m0	0.19997
	HE20, M0 to M7	m0h1	0.26272
2437	CCK, 1 to 11 Mbps	11.0	1.40922
	Non HT20, 6 to 54 Mbps	6.0	0.3659
	HT/VHT20, M0 to M7	m0	0.19724
	HE20, M0 to M7	m0h1	0.26272
2462	CCK, 1 to 11 Mbps	11.0	1.40922
	Non HT20, 6 to 54 Mbps	6.0	0.3659
	HT/VHT20, M0 to M7	m0	0.19724
	HE20, M0 to M7	m0h1	0.26272

## Data Screenshots

2412 MHz: CCK, 1 to 11 Mbps

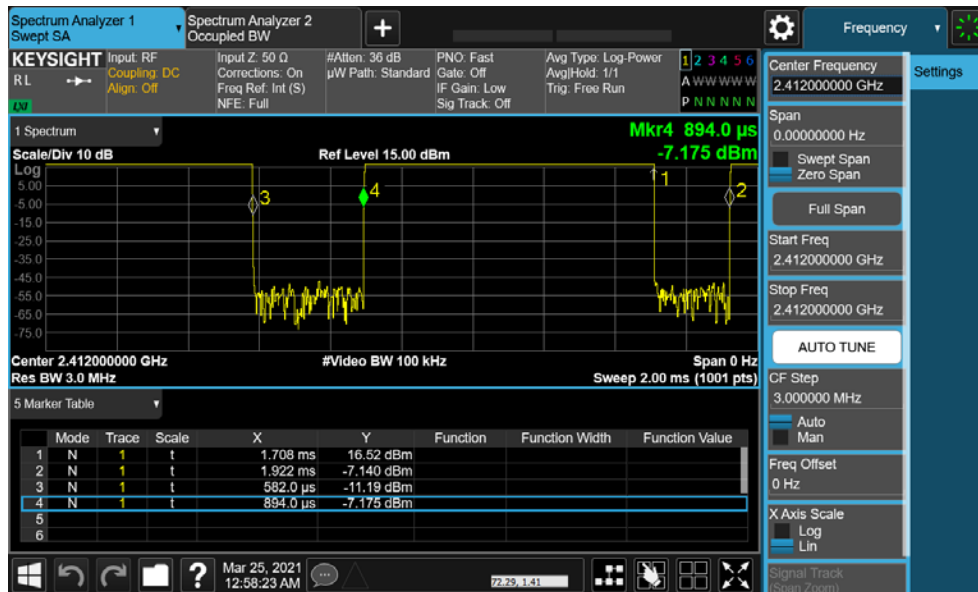

Antenna A

## A.2 DTS Bandwidth (6dB Bandwidth)

### DTS Bandwidth Test Requirement

For the FCC  
15.247 (2)

Systems using digital modulation techniques may operate in the 902–928 MHz, 2400–2483.5 MHz, and 5725–5850 MHz bands. The minimum 6 dB bandwidth shall be at least 500 kHz.

For Industry Canada:  
RSS-247 5.2 (a)

#### 5.2 Digital transmission systems

DTSs include systems that employ digital modulation techniques resulting in spectral characteristics similar to direct sequence systems. The following applies to the bands 902-928 MHz and 2400-2483.5 MHz:

a) The minimum 6 dB bandwidth shall be 500 kHz.

### DTS Bandwidth/ 6dB Bandwidth Test Procedure

Ref. KDB 558074 D01 DTS Meas Guidance v05r02, Section 8.2  
ANSI C63.10: 2013, Clause 11.8.2 Option 2

#### 6 BW

Test Procedure

1. Set the radio in the continuous transmitting mode.
2. Allow the trace to stabilize.
3. Setting the x-dB bandwidth mode to -6dB within the measurement set up function.
4. Select the automatic OBW measurement function of an instrument to perform bandwidth measurement.
5. Capture graphs and record pertinent measurement data.

Ref. KDB 558074 D01 DTS Meas Guidance v05r02, Section 8.2  
ANSI C63.10: 2013, Clause 11.8.2 Option 2

#### 6 BW

Test parameters

### 11.8 DTS bandwidth

One of the following procedures may be used to determine the modulated DTS bandwidth.

#### 11.8.1 Option 1

The steps for the first option are as follows:

- a) Set RBW = 100 kHz.
- b) Set the VBW  $\geq [3 \times \text{RBW}]$ .
- c) Detector = peak.
- d) Trace mode = max hold.
- e) Sweep = auto couple.
- f) Allow the trace to stabilize.
- g) Measure the maximum width of the emission that is constrained by the frequencies associated with the two outermost amplitude points (upper and lower frequencies) that are attenuated by 6 dB relative to the maximum level measured in the fundamental emission.

#### 11.8.2 Option 2

The automatic bandwidth measurement capability of an instrument may be employed using the  $X$  dB bandwidth mode with  $X$  set to 6 dB, if the functionality described in 11.8.1 (i.e., RBW = 100 kHz, VBW  $\geq 3 \times \text{RBW}$ , and peak detector with maximum hold) is implemented by the instrumentation function. When using this capability, care shall be taken so that the bandwidth measurement is not influenced by any intermediate power nulls in the fundamental emission that might be  $\geq 6$  dB.

<b>Tested By :</b> Said Abdelwafi, Julian Land	<b>Date of testing:</b> 02-MAR-2021 through 25-MAR-2021
<b>Test Result : PASS</b>	

### Test Equipment

See Appendix C for list of test equipment



## DTS BW Table

Frequency (MHz)	Mode	Data Rate (Mbps)	6dB BW (MHz)	Limit (kHz)	Margin (MHz)
2412	CCK, 1 to 11 Mbps	11.0	7.2	>500	6.7
	Non HT20, 6 to 54 Mbps	6.0	15.9	>500	15.4
	HT/VHT20, M0 to M7	m0	16.9	>500	16.4
	HE20, M0 to M9 1ss	m0h1	18.5	>500	18.0
2437	CCK, 1 to 11 Mbps	11.0	6.2	>500	5.7
	Non HT20, 6 to 54 Mbps	6.0	16.3	>500	15.8
	HT/VHT20, M0 to M7	m0	17.3	>500	16.8
	HE20, M0 to M9 1ss	m0h1	18.8	>500	18.3
2462	CCK, 1 to 11 Mbps	11.0	6.7	>500	6.2
	Non HT20, 6 to 54 Mbps	6.0	16.0	>500	15.5
	HT/VHT20 Beam Forming, M0 to M7	m0	17.1	>500	16.6
	HE20, M0 to M9 1ss	m0h1	18.6	>500	18.1

## Data Screenshots

2437 MHz: CCK, 1 to 11 Mbps

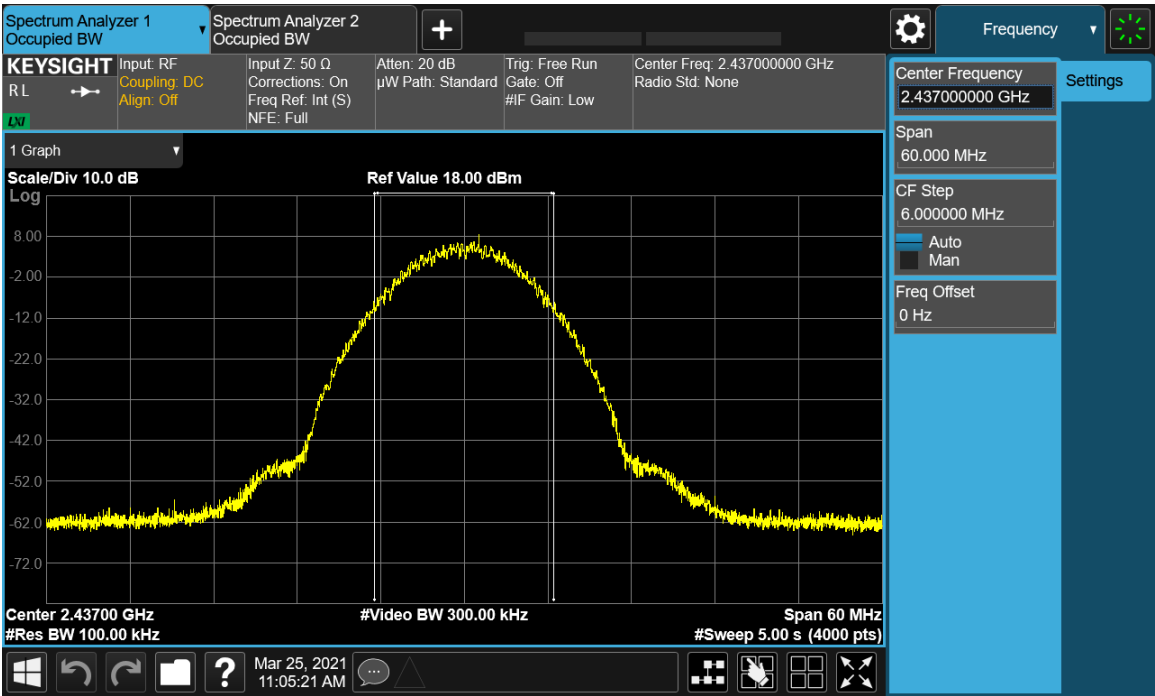

Antenna A

2462 MHz: CCK, 1 to 11 Mbps

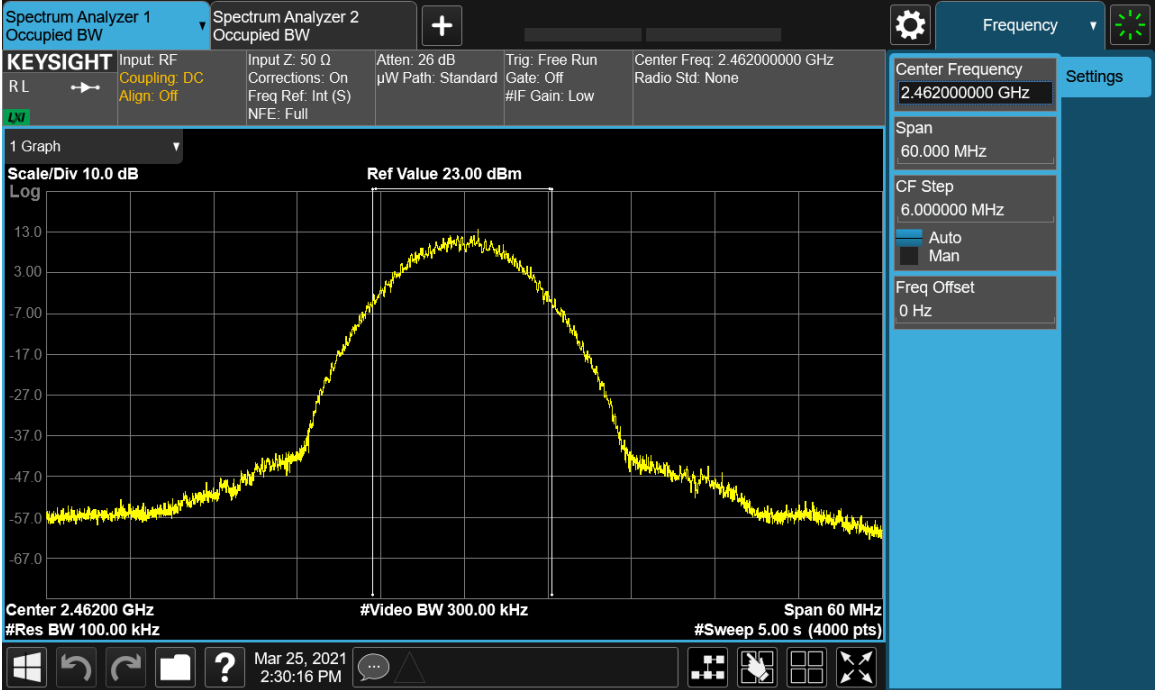

Antenna A

2412 MHz: CCK, 1 to 11 Mbps

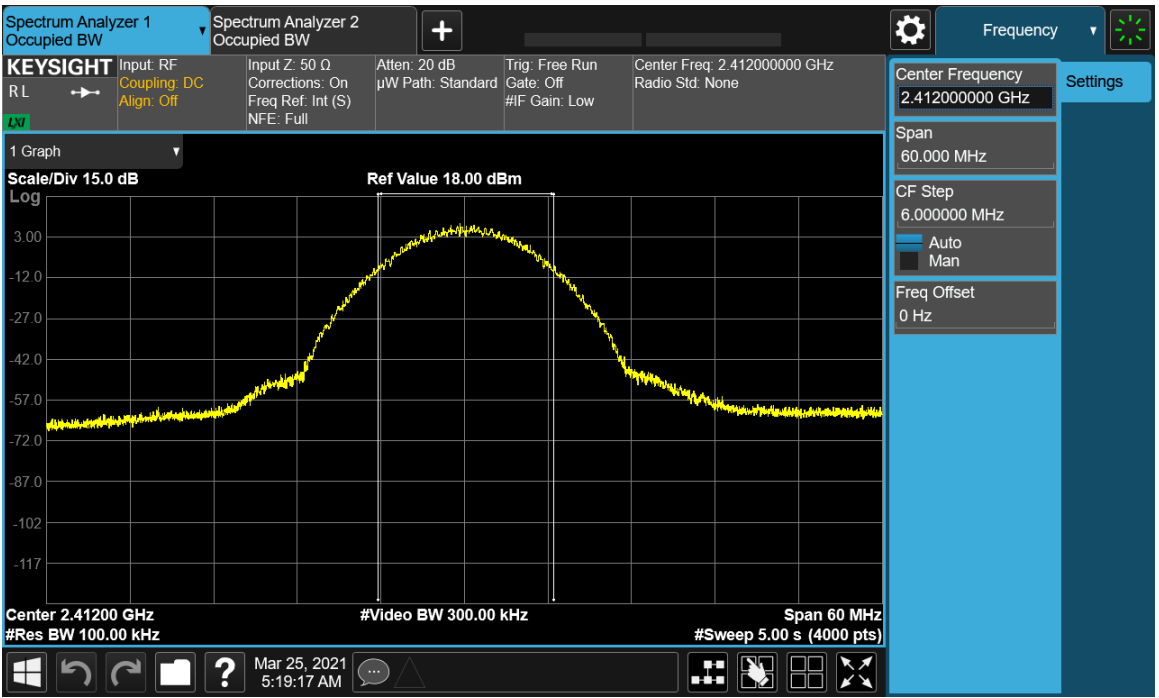

Antenna A

## A.3 Occupied Bandwidth

### Occupied Bandwidth Test Requirement

The 99% occupied bandwidth is the frequency bandwidth such that, below its lower and above its upper frequency limits, the mean powers are each equal to 0.5% of the total mean power of the given emission. There is no limit for 99% OBW.

The 26 dB emission is the width of the emission that is constrained by the frequencies associated with the two outermost amplitude points (upper and lower frequencies) that are attenuated by 26 dB relative to the maximum level measured in the fundamental emission.

### Occupied Bandwidth Test Method

#### Ref. ANSI C63.10: 2013

<b>Occupied Bandwidth</b> Test Procedure
<ol style="list-style-type: none"><li>1. Set the radio in the continuous transmitting mode.</li><li>2. Allow the trace to stabilize.</li><li>3. Setting the x-dB bandwidth mode to -26dB &amp; OBW to 99% within the measurement set up function.</li><li>4. Select the automatic OBW measurement function of an instrument to perform bandwidth measurement.</li><li>5. Capture graphs and record pertinent measurement data.</li></ol>

#### Ref. ANSI C63.10: 2013 section 6.9.3

<b>Occupied Bandwidth</b> Test parameters
<p><b>6.9.3 Occupied bandwidth—power bandwidth (99%) measurement procedure</b></p> <p>The occupied bandwidth is the frequency bandwidth such that, below its lower and above its upper frequency limits, the mean powers are each equal to 0.5% of the total mean power of the given emission. The following procedure shall be used for measuring 99% power bandwidth:</p> <ol style="list-style-type: none"><li>a) The instrument center frequency is set to the nominal EUT channel center frequency. The frequency span for the spectrum analyzer shall be between 1.5 times and 5.0 times the OBW.</li><li>b) The nominal IF filter bandwidth (3 dB RBW) shall be in the range of 1% to 5% of the OBW, and VBW shall be approximately three times the RBW, unless otherwise specified by the applicable requirement.</li><li>c) Set the reference level of the instrument as required, keeping the signal from exceeding the maximum input mixer level for linear operation. In general, the peak of the spectral envelope shall be more than <math>[10 \log (OBW/RBW)]</math> below the reference level. Specific guidance is given in 4.1.5.2.</li><li>d) Step a) through step c) might require iteration to adjust within the specified range.</li><li>e) Video averaging is not permitted. Where practical, a sample detection and single sweep mode shall be used. Otherwise, peak detection and max hold mode (until the trace stabilizes) shall be used.</li><li>f) Use the 99% power bandwidth function of the instrument (if available) and report the measured bandwidth.</li><li>g) If the instrument does not have a 99% power bandwidth function, then the trace data points are recovered and directly summed in linear power terms. The recovered amplitude data points, beginning at the lowest frequency, are placed in a running sum until 0.5% of the total is reached; that frequency is recorded as the lower frequency. The process is repeated until 99.5% of the total is reached; that frequency is recorded as the upper frequency. The 99% power bandwidth is the difference between these two frequencies.</li><li>h) The occupied bandwidth shall be reported by providing plot(s) of the measuring instrument display; the plot axes and the scale units per division shall be clearly labeled. Tabular data may be reported in addition to the plot(s).</li></ol>

<b>Tested By :</b> Said Abdelwafi, Julian Land	<b>Date of testing:</b> 02-MAR-2021 through 25-MAR-2021
<b>Test Result : PASS</b>	

### Test Equipment

See Appendix C for list of test equipment

### Occupied Bandwidth

Frequency (MHz)	Mode	Data Rate (Mbps)	26dB BW (MHz)	99% BW (MHz)
2412	CCK, 1 to 11 Mbps	11.0	16.6	12.605
	Non HT20 Beam Forming, 6 to 54 Mbps	6.0	18.9	16.311
	HT/VHT20, M0 to M7	m0	20.2	17.524
	HE20, M0 to M9 1ss	m0h1	20.9	18.881
2437	CCK, 1 to 11 Mbps	11.0	16.6	12.767
	Non HT20 Beam Forming, 6 to 54 Mbps	6.0	19.1	16.347
	HT/VHT20, M0 to M7	m0	20.3	17.561
	HE20 Beam Forming, M0 to M9 1ss	m0h1	21.0	18.91
2462	CCK, 1 to 11 Mbps	11.0	16.5	12.729
	Non HT20, 6 to 54 Mbps	6.0	18.9	16.338
	HT/VHT20 Beam Forming, M0 to M7	m0	20.3	17.534
	HE20 Beam Forming, M0 to M9 1ss	m0h1	20.8	18.895

# Data Screenshots

2412 MHz: CCK, 1 to 11 Mbps

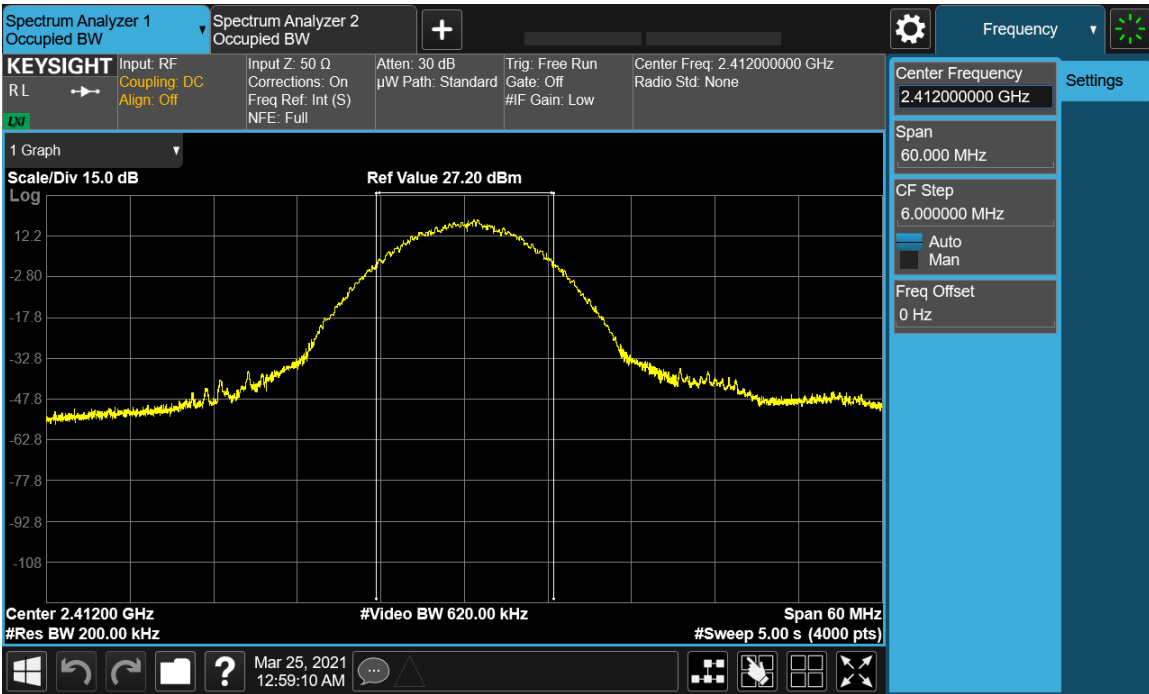

Antenna A

2462 MHz: CCK, 1 to 11 Mbps

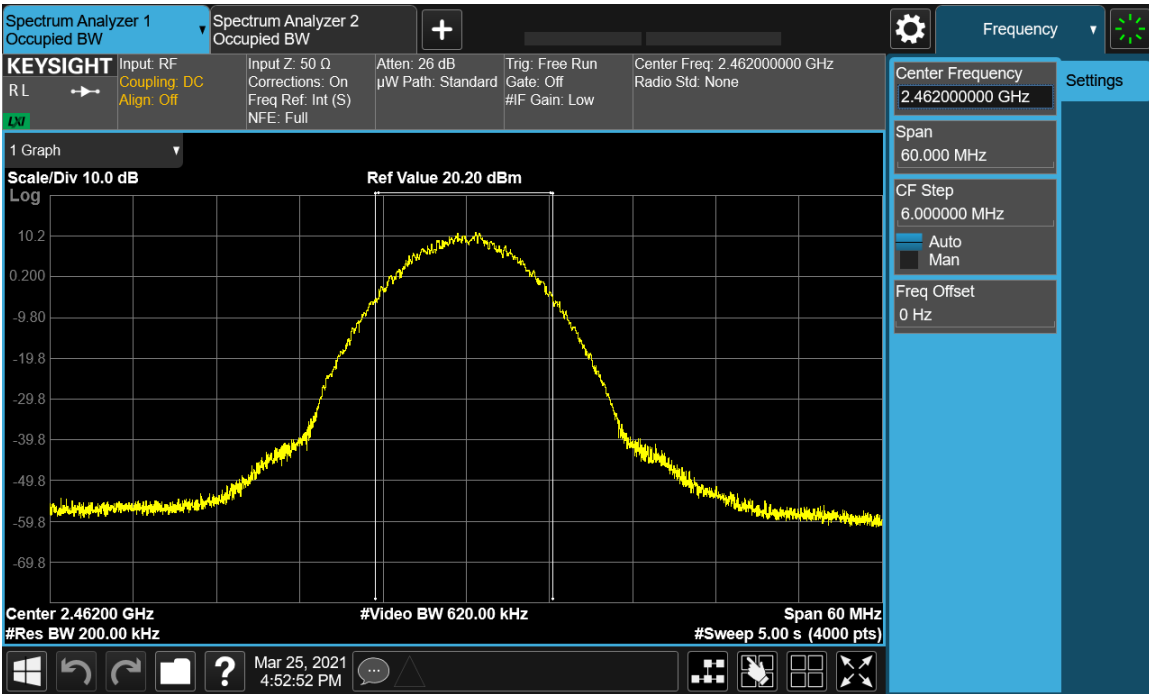

Antenna A

2437 MHz: CCK, 1 to 11 Mbps

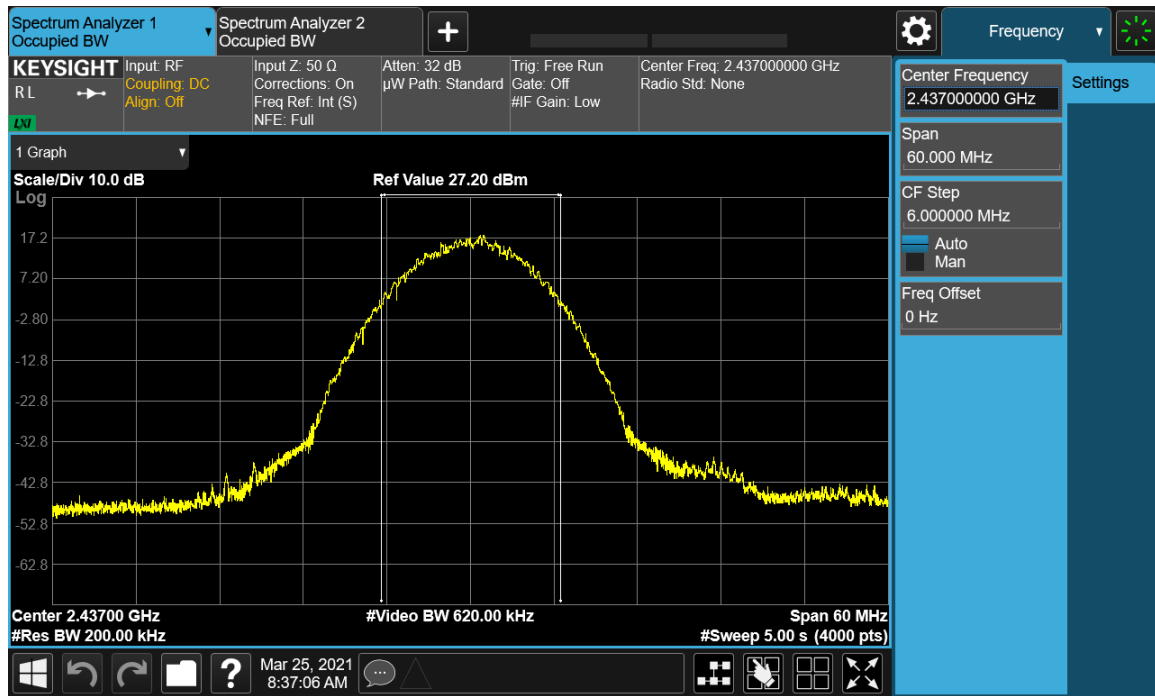

Antenna A

## A.4 Maximum Conducted Output Power

### Maximum Conducted Output Power Test Requirement

#### FCC, 15.247

(b) The maximum peak conducted output power of the intentional radiator shall not exceed the following: (3) For systems using digital modulation in the 902-928 MHz, **2400-2483.5 MHz**, and 5725-5850 MHz bands: **1 Watt**. As an alternative to a peak power measurement, compliance with the one Watt limit can be based on a measurement of the maximum conducted output power. Maximum Conducted Output Power is defined as the total transmit power delivered to all antennas and antenna elements averaged across all symbols in the signaling alphabet when the transmitter is operating at its maximum power control level. Power must be summed across all antennas and antenna elements. The average must not include any time intervals during which the transmitter is off or is transmitting at a reduced power level. If multiple modes of operation are possible (e.g., alternative modulation methods), the maximum conducted output power is the highest total transmit power occurring in any mode.

(4) The conducted output power limit specified in paragraph (b) of this section is based on the use of antennas with directional gains that do not exceed 6 dBi. Except as shown in paragraph (c) of this section, if transmitting antennas of directional gain greater than 6 dBi are used, the conducted output power from the intentional radiator shall be reduced below the stated values in paragraphs (b)(1), (b)(2), and (b)(3) of this section, as appropriate, by the amount in dB that the directional gain of the antenna exceeds 6 dBi.

#### Industry Canada, RSS-247:

##### 5.4 Transmitter output power and equivalent isotropically radiated power (e.i.r.p.) requirements

d) For DTSs employing digital modulation techniques operating in the bands 902-928 MHz and 2400-2483.5 MHz, the maximum peak conducted output power shall not exceed 1W. The e.i.r.p. shall not exceed 4 W, except as provided in section 5.4(e).

As an alternative to a peak power measurement, compliance can be based on a measurement of the maximum conducted output power. The maximum conducted output power is the total transmit power delivered to all antennas and antenna elements, averaged across all symbols in the signalling alphabet when the transmitter is operating at its maximum power control level. Power must be summed across all antennas and antenna elements. The average must not include any time intervals during which the transmitter is off or transmitting at a reduced power level. If multiple modes of operation are implemented, the maximum conducted output power is the highest total transmit power occurring in any mode.

The maximum supported antenna gain is 9dBi. The peak correlated gain for each mode is listed in the table below.

### Maximum Conducted Output Power Test Method

Ref. KDB 558074 D01 DTS Meas Guidance v05r02

ANSI C63.10: 2013

<b>Maximum Conducted Output power</b>
Test Procedure
1. Set the radio in the continuous transmitting mode at full power
2. Compute power by integrating the spectrum across the EBW (or alternatively entire 99% OBW) of the signal using the instrument's band power measurement function. The integration shall be performed using the spectrum analyzer band-power measurement function with band limits set equal to the EBW or the OBW band edges.
3. Capture graphs and record pertinent measurement data.

Ref. 558074 D01 DTS Meas Guidance v05r02, 8.3.2.2 Measurement using a spectrum analyzer (SA)

ANSI C63.10: 2013, section 11.9.2.2.4 Method AVGSA-2

<b>Maximum Conducted Output power</b>
Test parameters



#### 11.9.2.2.4 Method AVGSA-2

Method AVGSA-2 uses trace averaging across ON and OFF times of the EUT transmissions, followed by duty cycle correction. The procedure for this method is as follows:

- a) Measure the duty cycle  $D$  of the transmitter output signal as described in 11.6.
- b) Set span to at least 1.5 times the OBW.
- c) Set RBW = 1% to 5% of the OBW, not to exceed 1 MHz.
- d) Set VBW  $\geq [3 \times \text{RBW}]$ .
- e) Number of points in sweep  $\geq [2 \times \text{span} / \text{RBW}]$ . (This gives bin-to-bin spacing  $\leq \text{RBW} / 2$ , so that narrowband signals are not lost between frequency bins.)
- f) Sweep time = auto.
- g) Detector = RMS (i.e., power averaging), if available. Otherwise, use the sample detector mode.
- h) Do not use sweep triggering. Allow the sweep to “free run.”
- i) Trace average at least 100 traces in power averaging (rms) mode; however, the number of traces to be averaged shall be increased above 100 as needed such that the average accurately represents the true average over the ON and OFF periods of the transmitter.
- j) Compute power by integrating the spectrum across the OBW of the signal using the instrument’s band power measurement function with band limits set equal to the OBW band edges. If the instrument does not have a band power function, then sum the spectrum levels (in power units) at intervals equal to the RBW extending across the entire OBW of the spectrum.
- k) Add  $[10 \log (1 / D)]$ , where  $D$  is the duty cycle, to the measured power to compute the average power during the actual transmission times (because the measurement represents an average over both the ON and OFF times of the transmission). For example, add  $[10 \log (1/0.25)] = 6 \text{ dB}$  if the duty cycle is 25%.

The “measure-and-sum technique” is used for measuring in-band transmit power of a device. In the measure-and-sum approach, the conducted emission level is measured at each antenna port. The measured results at the various antenna ports are then summed mathematically to determine the total emission level from the device. Summing is performed in linear power units. (See ANSI C63.10 section 14.3 for Guidance)

<b>Tested By :</b> Said Abdelwafi, Julian Land	<b>Date of testing:</b> 02-MAR-2021 through 25-MAR-2021
<b>Test Result : PASS</b>	

#### Test Equipment

See Appendix C for list of test equipment

**Note: Limit is modified to ensure complying with both conducted power limit of 30dBm and eirp limit of 36 dBm**

## Maximum Output Power

### Frequency 2412 MHz

Mode	Tx Paths	Correlated Antenna Gain (dBi)	Tx 1 Max Power (dBm)	Tx 2 Max Power (dBm)	Tx 3 Max Power (dBm)	Tx 4 Max Power (dBm)	Duty Cycle (dB)	Total Tx Channel Power (dBm)	Limit (dBm)	Margin (dB)
CCK, 1 to 11 Mbps	1	9	22.9				1.41	24.3	27	2.67
CCK, 1 to 11 Mbps	2	9	18.8	18.8			1.41	23.2	27	3.8
CCK, 1 to 11 Mbps	3	9	14.9	14.9	14.5		1.41	20.9	27	6.07
CCK, 1 to 11 Mbps	4	9	13.8	13.9	13.5	13.5	1.41	21.1	27	5.89
Non HT20, 6 to 54 Mbps	1	9	18.4				0.37	18.7	27	8.26
Non HT20, 6 to 54 Mbps	2	9	15.6	15.5			0.37	18.9	27	8.08
Non HT20, 6 to 54 Mbps	3	9	15.6	15.5	15.1		0.37	20.5	27	6.48
Non HT20, 6 to 54 Mbps	4	9	15.6	15.5	15.1	15.4	0.37	21.8	27	5.23
Non HT20 Beam Forming, 6 to 54 Mbps	2	12	15.6	15.5			0.37	18.9	24	5.08
Non HT20 Beam Forming, 6 to 54 Mbps	3	14	14.5	14.7	14.1		0.37	19.6	22	2.43
Non HT20 Beam Forming, 6 to 54 Mbps	4	15	12.4	12.5	12.3	12.4	0.37	18.8	21	2.19
HT/VHT20, M0 to M7	1	9	17.5				0.2	17.7	27	9.27
HT/VHT20, M0 to M7	2	9	16.6	16.5			0.2	19.8	27	7.23
HT/VHT20, M8 to M15	2	9	16.6	16.5			0.2	19.8	27	7.23
HT/VHT20, M0 to M7	3	9	15.5	15.5	15.2		0.2	20.4	27	6.64
HT/VHT20, M8 to M15	3	9	15.5	15.5	15.2		0.2	20.4	27	6.64
HT/VHT20, M16 to M23	3	9	15.5	15.5	15.2		0.2	20.4	27	6.64
HT/VHT20, M0 to M7	4	9	15.5	15.5	15.2	15.4	0.2	21.6	27	5.39
HT/VHT20, M8 to M15	4	9	15.5	15.5	15.2	15.4	0.2	21.6	27	5.39

HT/VHT20, M16 to M23	4	9	15.5	15.5	15.2	15.4	0.2	21.6	27	5.39
HT/VHT20, M24 to M31	4	9	15.5	15.5	15.2	15.4	0.2	21.6	27	5.39
HT/VHT20 Beam Forming, M0 to M7	2	12	15.5	15.5			0.2	18.7	24	5.31
HT/VHT20 Beam Forming, M8 to M15	2	9	16.6	16.5			0.2	19.8	27	7.23
HT/VHT20 Beam Forming, M0 to M7	3	14	13.3	13.5	13.1		0.2	18.3	22	3.72
HT/VHT20 Beam Forming, M8 to M15	3	11	15.5	15.5	15.2		0.2	20.4	25	4.64
HT/VHT20 Beam Forming, M16 to M23	3	9	15.5	15.5	15.2		0.2	20.4	27	6.64
HT/VHT20 Beam Forming, M0 to M7	4	15	11.0	11.4	11.2	11.0	0.2	17.3	21	3.66
HT/VHT20 Beam Forming, M8 to M15	4	12	13.3	13.5	13.1	13.4	0.2	19.5	24	4.45
HT/VHT20 Beam Forming, M16 to M23	4	10	14.3	14.4	14.1	14.1	0.2	20.5	26	5.55
HT/VHT20 Beam Forming, M24 to M31	4	9	15.5	15.5	15.2	15.4	0.2	21.6	27	5.39
HT/VHT20 STBC, M0 to M7	2	9	16.6	16.5			0.2	19.8	27	7.23
HT/VHT20 STBC, M0 to M7	3	9	15.5	15.5	15.2		0.2	20.4	27	6.64
HT/VHT20 STBC, M0 to M7	4	9	15.5	15.5	15.2	15.4	0.2	21.6	27	5.39
HE20, M0 to M9 1ss	1	9	16.6				0.2	16.8	27	10.24
HE20, M0 to M9 1ss	2	9	15.6	15.7			0.26	18.9	27	8.07
HE20, M0 to M9 2ss	2	9	15.6	15.7			0.26	18.9	27	8.07
HE20, M0 to M9 1ss	3	9	15.6	15.7	15.4		0.26	20.6	27	6.38
HE20, M0 to M9 2ss	3	9	15.6	15.7	15.4		0.26	20.6	27	6.38
HE20, M0 to M9 3ss	3	9	15.6	15.7	15.4		0.26	20.6	27	6.38
HE20, M0 to M9 1ss	4	9	14.7	14.8	14.4	14.4	0.26	20.8	27	6.15
HE20, M0 to M9 2ss	4	9	14.7	14.8	14.4	14.4	0.26	20.8	27	6.15
HE20, M0 to M9 3ss	4	9	14.7	14.8	14.4	14.4	0.26	20.8	27	6.15
HE20, M0 to M9 4ss	4	9	14.7	14.8	14.4	14.4	0.26	20.8	27	6.15
HE20 Beam Forming, M0 to M9 1ss	2	12	14.7	14.8			0.26	18.0	24	6.01
HE20 Beam Forming, M0 to M9 2ss	2	9	15.6	15.7			0.26	18.9	27	8.07
HE20 Beam Forming, M0 to M9 1ss	3	14	12.7	12.8	12.5		0.26	17.7	22	4.29
HE20 Beam Forming, M0 to M9 2ss	3	11	14.7	14.8	14.4		0.26	19.6	25	5.36
HE20 Beam Forming, M0 to M9 3ss	3	9	15.6	15.7	15.4		0.26	20.6	27	6.38

HE20 Beam Forming, M0 to M9 1ss	4	15	10.6	10.7	10.6	10.5	0.26	16.9	21	4.11
HE20 Beam Forming, M0 to M9 2ss	4	12	12.7	12.8	12.5	12.5	0.26	18.9	24	5.08
HE20 Beam Forming, M0 to M9 3ss	4	10	14.7	14.8	14.4	14.4	0.26	20.8	26	5.15
HE20 Beam Forming, M0 to M9 4ss	4	9	14.7	14.8	14.4	14.4	0.26	20.8	27	6.15
HE20 STBC, M0 to M9 2ss	2	9	15.6	15.7			0.26	18.9	27	8.07
HE20 STBC, M0 to M9 2ss	3	9	15.6	15.7	15.4		0.26	20.6	27	6.38
HE20 STBC, M0 to M9 2ss	4	9	14.7	14.8	14.4	14.4	0.26	20.8	27	6.15

### Frequency 2437 MHz

Mode	Tx Paths	Correlated Antenna Gain (dBi)	Tx 1 Max Power (dBm)	Tx 2 Max Power (dBm)	Tx 3 Max Power (dBm)	Tx 4 Max Power (dBm)	Duty Cycle (dB)	Total Tx Channel Power (dBm)	Limit (dBm)	Margin (dB)
CCK, 1 to 11 Mbps	1	9	22.5				1.41	23.9	27	3.08
CCK, 1 to 11 Mbps	2	9	18.3	18.5			1.41	22.8	27	4.16
CCK, 1 to 11 Mbps	3	9	15.6	15.7	15.3		1.41	21.7	27	5.29
CCK, 1 to 11 Mbps	4	9	14.5	14.5	14.3	14.3	1.41	21.8	27	5.16
Non HT20, 6 to 54 Mbps	1	9	23.0				0.37	23.4	27	3.64
Non HT20, 6 to 54 Mbps	2	9	23.0	23.0			0.37	26.4	27	0.63
Non HT20, 6 to 54 Mbps	3	9	20.8	20.9	20.8		0.37	26.0	27	1.0
Non HT20, 6 to 54 Mbps	4	9	20.1	20.1	19.9	20.2	0.37	26.4	27	0.55
Non HT20 Beam Forming, 6 to 54 Mbps	2	12	20.1	20.1			0.37	23.4	24	0.55
Non HT20 Beam Forming, 6 to 54 Mbps	3	14	16.1	16.2	16.0		0.37	21.2	22	0.76

Non HT20 Beam Forming, 6 to 54 Mbps	4	15	14.1	14.3	14.0	14.1	0.37	20.5	21	0.49
HT/VHT20, M0 to M7	1	9	23.0				0.2	23.2	27	3.85
HT/VHT20, M0 to M7	2	9	23.0	23.0			0.2	26.2	27	0.8
HT/VHT20, M8 to M15	2	9	23.0	23.0			0.2	26.2	27	0.8
HT/VHT20, M0 to M7	3	9	21.0	21.2	20.8		0.2	26.0	27	1.04
<b>HT/VHT20, M8 to M15</b>	<b>3</b>	<b>9</b>	<b>22.0</b>	<b>21.9</b>	<b>21.7</b>		<b>0.2</b>	<b>26.8</b>	<b>27</b>	<b>0.17</b>
<b>HT/VHT20, M16 to M23</b>	<b>3</b>	<b>9</b>	<b>22.0</b>	<b>21.9</b>	<b>21.7</b>		<b>0.2</b>	<b>26.8</b>	<b>27</b>	<b>0.17</b>
HT/VHT20, M0 to M7	4	9	18.1	18.2	18.1	18.1	0.2	24.3	27	2.66
HT/VHT20, M8 to M15	4	9	20.0	20.1	19.9	20.2	0.2	26.3	27	0.73
HT/VHT20, M16 to M23	4	9	20.0	20.1	19.9	20.2	0.2	26.3	27	0.73
HT/VHT20, M24 to M31	4	9	20.0	20.1	19.9	20.2	0.2	26.3	27	0.73
HT/VHT20 Beam Forming, M0 to M7	2	12	20.0	20.1			0.2	23.2	24	0.76
HT/VHT20 Beam Forming, M8 to M15	2	9	23.0	23.0			0.2	26.2	27	0.8
HT/VHT20 Beam Forming, M0 to M7	3	14	16.2	16.1	15.8		0.2	21.0	22	1.0
<b>HT/VHT20 Beam Forming, M8 to M15</b>	<b>3</b>	<b>11</b>	<b>20.0</b>	<b>20.1</b>	<b>19.9</b>		<b>0.2</b>	<b>25.0</b>	<b>25</b>	<b>0.03</b>
HT/VHT20 Beam Forming, M16 to M23	3	9	22.0	21.9	21.7		0.2	26.8	27	0.17
HT/VHT20 Beam Forming, M0 to M7	4	15	13.9	14.1	14.0	14.2	0.2	20.2	21	0.75
HT/VHT20 Beam Forming, M8 to M15	4	12	17.1	17.2	16.8	17.1	0.2	23.3	24	0.72
HT/VHT20 Beam Forming, M16 to M23	4	10	19.0	18.9	18.8	19.2	0.2	25.2	26	0.8
HT/VHT20 Beam Forming, M24 to M31	4	9	20.0	20.1	19.9	20.2	0.2	26.3	27	0.73
HT/VHT20 STBC, M0 to M7	2	9	23.0	23.0			0.2	26.2	27	0.8
HT/VHT20 STBC, M0 to M7	3	9	22.0	21.9	21.7		0.2	26.8	27	0.17
HT/VHT20 STBC, M0 to M7	4	9	20.0	20.1	19.9	20.2	0.2	26.3	27	0.73
HE20, M0 to M9 1ss	1	9	23.1				0.26	23.4	27	3.61
HE20, M0 to M9 1ss	2	9	23.1	23.2			0.26	26.4	27	0.55
HE20, M0 to M9 2ss	2	9	23.1	23.2			0.26	26.4	27	0.55
HE20, M0 to M9 1ss	3	9	20.3	20.6	20.1		0.26	25.4	27	1.63
HE20, M0 to M9 2ss	3	9	21.0	21.4	21.1		0.26	26.2	27	0.79
HE20, M0 to M9 3ss	3	9	21.0	21.4	21.1		0.26	26.2	27	0.79
HE20, M0 to M9 1ss	4	9	19.4	19.4	19.3	19.3	0.26	25.6	27	1.35
HE20, M0 to M9 2ss	4	9	20.3	20.6	20.1	20.3	0.26	26.6	27	0.38

HE20, M0 to M9 3ss	4	9	20.3	20.6	20.1	20.3	0.26	26.6	27	0.38
HE20, M0 to M9 4ss	4	9	20.3	20.6	20.1	20.3	0.26	26.6	27	0.38
HE20 Beam Forming, M0 to M9 1ss	2	12	20.3	20.6			0.26	23.7	24	0.29
HE20 Beam Forming, M0 to M9 2ss	2	9	23.1	23.2			0.26	26.4	27	0.55
HE20 Beam Forming, M0 to M9 1ss	3	14	16.2	16.5	16.2		0.26	21.3	22	0.7
HE20 Beam Forming, M0 to M9 2ss	3	11	19.4	19.4	19.3		0.26	24.4	25	0.59
HE20 Beam Forming, M0 to M9 3ss	3	9	21.0	21.4	21.1		0.26	26.2	27	0.79
HE20 Beam Forming, M0 to M9 1ss	4	15	14.4	14.4	14.3	14.4	0.26	20.6	21	0.35
HE20 Beam Forming, M0 to M9 2ss	4	12	17.3	17.4	17.2	17.4	0.26	23.6	24	0.39
HE20 Beam Forming, M0 to M9 3ss	4	10	19.4	19.4	19.3	19.3	0.26	25.6	26	0.35
HE20 Beam Forming, M0 to M9 4ss	4	9	20.3	20.6	20.1	20.3	0.26	26.6	27	0.38
HE20 STBC, M0 to M9 2ss	2	9	23.1	23.2			0.26	26.4	27	0.55
HE20 STBC, M0 to M9 2ss	3	9	21.0	21.4	21.1		0.26	26.2	27	0.79
HE20 STBC, M0 to M9 2ss	4	9	20.3	20.6	20.1	20.3	0.26	26.6	27	0.38

### Frequency 2462 MHz

Mode	Tx Paths	Correlated Antenna Gain (dBi)	Tx 1 Max Power (dBm)	Tx 2 Max Power (dBm)	Tx 3 Max Power (dBm)	Tx 4 Max Power (dBm)	Duty Cycle (dB)	Total Tx Channel Power (dBm)	Limit (dBm)	Margin (dB)
CCK, 1 to 11 Mbps	1	9	23.0				1.41	24.4	27	2.64
CCK, 1 to 11 Mbps	2	9	20.0	20.0			1.41	24.4	27	2.56
CCK, 1 to 11 Mbps	3	9	16.0	16.0	15.8		1.41	22.1	27	4.88
CCK, 1 to 11 Mbps	4	9	13.7	13.9	13.9	13.8	1.41	21.3	27	5.72

Non HT20, 6 to 54 Mbps	1	9	17.6					0.37	17.9	27	9.08
Non HT20, 6 to 54 Mbps	2	9	15.4	15.6				0.37	18.9	27	8.1
Non HT20, 6 to 54 Mbps	3	9	14.4	14.7	14.4			0.37	19.6	27	7.36
Non HT20, 6 to 54 Mbps	4	9	13.6	13.4	13.3	13.5		0.37	19.8	27	7.15
Non HT20 Beam Forming, 6 to 54 Mbps	2	12	13.6	13.4				0.37	16.9	24	7.1
Non HT20 Beam Forming, 6 to 54 Mbps	3	14	11.2	11.4	11.2			0.37	16.4	22	5.59
Non HT20 Beam Forming, 6 to 54 Mbps	4	15	9.5	9.6	9.3	9.3		0.37	15.8	21	5.17
HT/VHT20, M0 to M7	1	9	16.4					0.2	16.6	27	10.38
HT/VHT20, M0 to M7	2	9	14.7	14.5				0.2	17.8	27	9.23
HT/VHT20, M8 to M15	2	9	14.7	14.5				0.2	17.8	27	9.23
HT/VHT20, M0 to M7	3	9	13.4	13.6	13.5			0.2	18.5	27	8.52
HT/VHT20, M8 to M15	3	9	13.4	13.6	13.5			0.2	18.5	27	8.52
HT/VHT20, M16 to M23	3	9	13.4	13.6	13.5			0.2	18.5	27	8.52
HT/VHT20, M0 to M7	4	9	12.4	12.6	12.5	12.3		0.2	18.7	27	8.32
HT/VHT20, M8 to M15	4	9	12.4	12.6	12.5	12.3		0.2	18.7	27	8.32
HT/VHT20, M16 to M23	4	9	12.4	12.6	12.5	12.3		0.2	18.7	27	8.32
HT/VHT20, M24 to M31	4	9	12.4	12.6	12.5	12.3		0.2	18.7	27	8.32
HT/VHT20 Beam Forming, M0 to M7	2	12	12.4	12.6				0.2	15.7	24	8.31
HT/VHT20 Beam Forming, M8 to M15	2	9	14.7	14.5				0.2	17.8	27	9.23
HT/VHT20 Beam Forming, M0 to M7	3	14	10.6	10.6	10.3			0.2	15.5	22	6.52
HT/VHT20 Beam Forming, M8 to M15	3	11	12.4	12.6	12.5			0.2	17.5	25	7.53
HT/VHT20 Beam Forming, M16 to M23	3	9	13.4	13.6	13.5			0.2	18.5	27	8.52
HT/VHT20 Beam Forming, M0 to M7	4	15	9.6	9.6	9.4	9.5		0.2	15.7	21	5.28
HT/VHT20 Beam Forming, M8 to M15	4	12	10.6	10.6	10.3	10.2		0.2	16.6	24	7.35
HT/VHT20 Beam Forming, M16 to M23	4	10	11.1	11.5	11.2	11.3		0.2	17.5	26	8.48
HT/VHT20 Beam Forming, M24 to M31	4	9	12.4	12.6	12.5	12.3		0.2	18.7	27	8.32
HT/VHT20 STBC, M0 to M7	2	9	14.7	14.5				0.2	17.8	27	9.23

HT/VHT20 STBC, M0 to M7	3	9	13.4	13.6	13.5		0.2	18.5	27	8.52
HT/VHT20 STBC, M0 to M7	4	9	12.4	12.6	12.5	12.3	0.2	18.7	27	8.32
HE20, M0 to M9 1ss	1	9	16.7				0.26	16.9	27	10.05
HE20, M0 to M9 1ss	2	9	13.7	13.7			0.26	17.0	27	10.03
HE20, M0 to M9 2ss	2	9	13.7	13.7			0.26	17.0	27	10.03
HE20, M0 to M9 1ss	3	9	12.8	12.8	12.8		0.26	17.8	27	9.17
HE20, M0 to M9 2ss	3	9	12.8	12.8	12.8		0.26	17.8	27	9.17
HE20, M0 to M9 3ss	3	9	12.8	12.8	12.8		0.26	17.8	27	9.17
HE20, M0 to M9 1ss	4	9	11.5	11.8	11.5	11.7	0.26	17.9	27	9.08
HE20, M0 to M9 2ss	4	9	11.5	11.8	11.5	11.7	0.26	17.9	27	9.08
HE20, M0 to M9 3ss	4	9	11.5	11.8	11.5	11.7	0.26	17.9	27	9.08
HE20, M0 to M9 4ss	4	9	11.5	11.8	11.5	11.7	0.26	17.9	27	9.08
HE20 Beam Forming, M0 to M9 1ss	2	12	11.5	11.8			0.26	14.9	24	9.05
HE20 Beam Forming, M0 to M9 2ss	2	9	13.7	13.7			0.26	17.0	27	10.03
HE20 Beam Forming, M0 to M9 1ss	3	14	9.7	9.9	9.7		0.26	14.8	22	7.21
HE20 Beam Forming, M0 to M9 2ss	3	11	11.5	11.8	11.5		0.26	16.7	25	8.33
HE20 Beam Forming, M0 to M9 3ss	3	9	12.8	12.8	12.8		0.26	17.8	27	9.17
HE20 Beam Forming, M0 to M9 1ss	4	15	8.9	8.9	8.7	8.7	0.26	15.1	21	5.93
HE20 Beam Forming, M0 to M9 2ss	4	12	9.7	9.9	9.7	9.6	0.26	16.0	24	8.0
HE20 Beam Forming, M0 to M9 3ss	4	10	11.5	11.8	11.5	11.7	0.26	17.9	26	8.08
HE20 Beam Forming, M0 to M9 4ss	4	9	11.5	11.8	11.5	11.7	0.26	17.9	27	9.08
HE20 STBC, M0 to M9 2ss	2	9	13.7	13.7			0.26	17.0	27	10.03
HE20 STBC, M0 to M9 2ss	3	9	12.8	12.8	12.8		0.26	17.8	27	9.17
HE20 STBC, M0 to M9 2ss	4	9	11.5	11.8	11.5	11.7	0.26	17.9	27	9.08

## Data Screenshots

2437 MHz: HT/VHT20 Beam Forming, M8 to M15



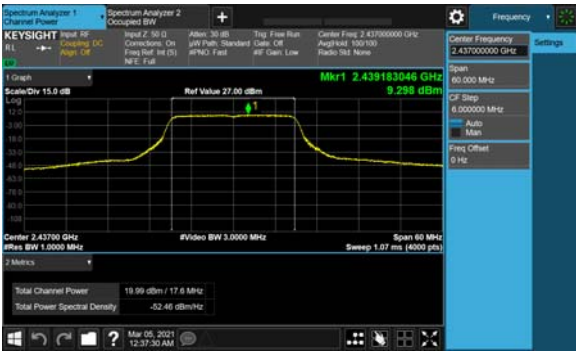

Antenna A

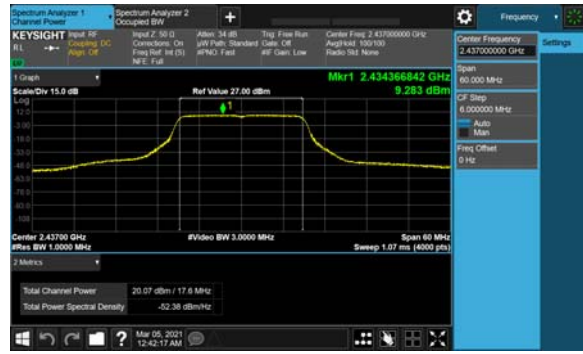

Antenna B

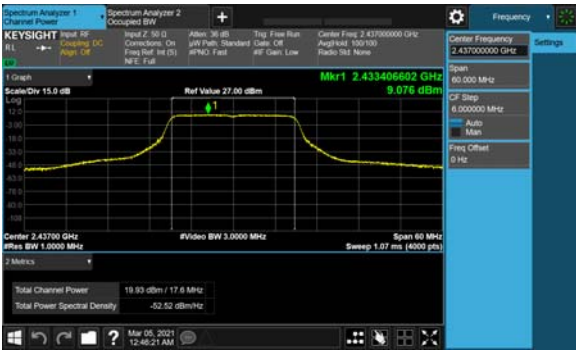

Antenna C

2437 MHz: HT/VHT20, M8 to M15

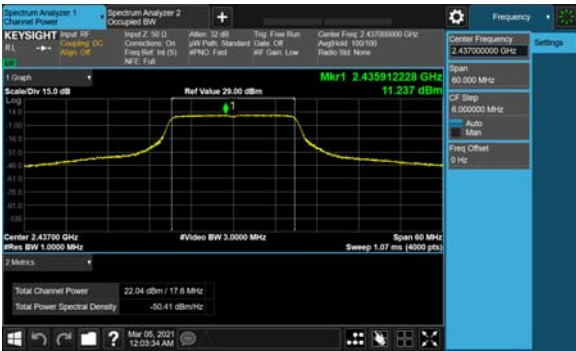

Antenna A

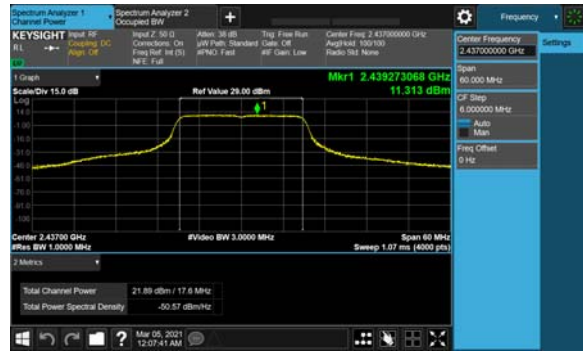

Antenna B

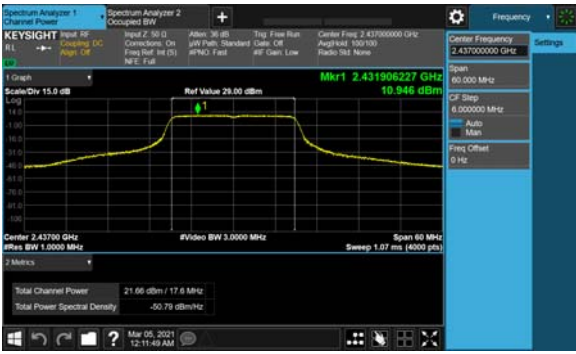

Antenna C

2437 MHz: HT/VHT20, M16 to M23

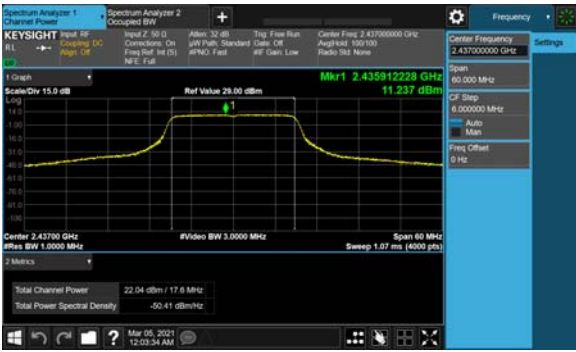

Antenna A

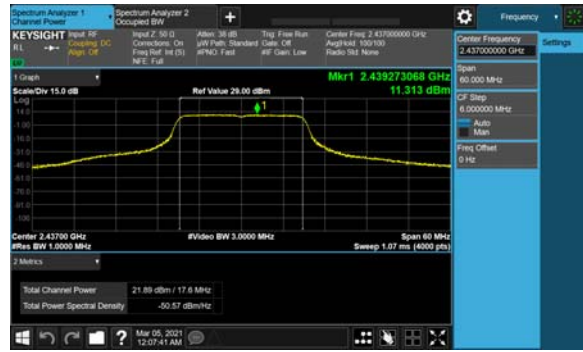

Antenna B

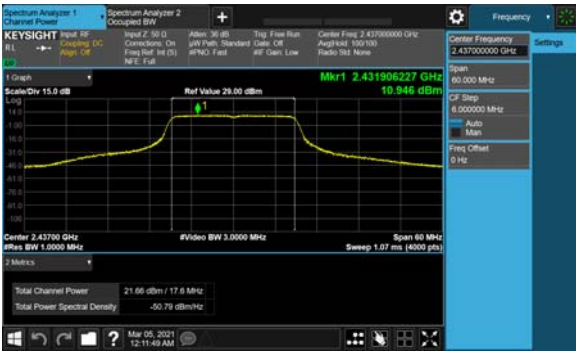

Antenna C

# A.5 Power Spectral Density

## Power Spectral Density Test Requirement

### 15.247 (e) / RSS-247 5.2 (b)

#### 5.2 Digital transmission systems

DTSS include systems that employ digital modulation techniques resulting in spectral characteristics similar to direct sequence systems. The following applies to the bands 902-928 MHz and 2400-2483.5 MHz:

b) The transmitter power spectral density conducted from the transmitter to the antenna shall not be greater than 8 dBm in any 3 kHz band during any time interval of continuous transmission. This power spectral density shall be determined in accordance with the provisions of section 5.4(d), (i.e. the power spectral density shall be determined using the same method as is used to determine the conducted output power).

## Power Spectral Density Test Method

Ref. KDB 558074 D01 DTS Meas Guidance v05r02

ANSI C63.10: 2013

<b>Power Spectral Density</b> Test Procedure
1. Set the radio in the continuous transmitting mode at full power 2. Configure Spectrum analyzer as per test parameters below and Peak search marker 3. Capture graphs and record pertinent measurement data.

Ref. KDB 558074 D01 DTS Meas Guidance v05r02, section 8.4 DTS maximum power spectral density level in the fundamental emission

ANSI C63.10: 2013, section 11.10.5 Average PSD

<b>Power Spectral Density</b> Test parameters
<b>11.10.5 Method AVGPSD-2</b>  Method AVGPSD-2 uses trace averaging across ON and OFF times of the EUT transmissions, followed by duty cycle correction.  The following procedure is applicable when the EUT cannot be configured to transmit continuously (i.e., $D < 98\%$ ), when sweep triggering/signal gating cannot be used to measure only when the EUT is transmitting at its maximum power control level, and when the transmission duty cycle is constant (i.e., duty cycle variations are less than $\pm 2\%$ ):  a) Measure the duty cycle ( $D$ ) of the transmitter output signal as described in 11.6. b) Set instrument center frequency to DTS channel center frequency. c) Set span to at least 1.5 times the OBW. d) Set RBW to: $3 \text{ kHz} \leq \text{RBW} \leq 100 \text{ kHz}$ . e) Set VBW $\geq [3 \times \text{RBW}]$ . f) Detector = power averaging (rms) or sample detector (when rms not available). g) Ensure that the number of measurement points in the sweep $\geq [2 \times \text{span} / \text{RBW}]$ . h) Sweep time = auto couple. i) Do not use sweep triggering; allow sweep to "free run." j) Employ trace averaging (rms) mode over a minimum of 100 traces. k) Use the peak marker function to determine the maximum amplitude level. l) Add $[10 \log (1 / D)]$ , where $D$ is the duty cycle measured in step a), to the measured PSD to compute the average PSD during the actual transmission time. m) If measured value exceeds requirement specified by regulatory agency, then reduce RBW (but no less than 3 kHz) and repeat (note that this may require zooming in on the emission of interest and reducing the span to meet the minimum measurement point requirement as the RBW is reduced).

The "Measure and add 10 log(N) dB technique", where N is the number of outputs, is used for measuring in-band Power Spectral Density. (See ANSI C63.10 section 14.3.2.3 )

<b>Tested By :</b> Said Abdelwafi, Julian Land	<b>Date of testing:</b> 02-MAR-2021 through 25-MAR-2021
<b>Test Result : PASS</b>	

**Test Equipment**

See Appendix C for list of test equipment

## Power Spectral Density

### Frequency 2412 MHz

Mode	Tx Paths	Correlated Antenna Gain (dBi)	Tx 1 PSD (dBm/MHz)	Tx 2 PSD (dBm/MHz)	Tx 3 PSD (dBm/MHz)	Tx 4 PSD (dBm/MHz)	Duty Cycle (dB)	Total PSD (dBm/MHz)	Limit (dBm/MHz)	Margin (dB)
CCK, 1 to 11 Mbps	1	9	1.3				1.41	2.7	5	2.32
CCK, 1 to 11 Mbps	2	12	-3.4	-2.5			1.41	1.5	2	0.49
CCK, 1 to 11 Mbps	3	14	-9.0	-7.1	-7.3		1.41	-1.6		1.57
CCK, 1 to 11 Mbps	4	15	-9.7	-8.8	-10.2	-9.7	1.41	-2.1	-1	1.14
Non HT20, 6 to 54 Mbps	1	9	-9.7				0.37	-9.3	5	14.3
Non HT20, 6 to 54 Mbps	2	12	-11.6	-12.3			0.37	-8.6	2	10.6
Non HT20, 6 to 54 Mbps	3	14	-11.6	-12.3	-12.9		0.37	-7.1		7.14
Non HT20, 6 to 54 Mbps	4	15	-11.6	-12.3	-12.9	-12.4	0.37	-5.9	-1	4.91
Non HT20 Beam Forming, 6 to 54 Mbps	2	12	-11.6	-12.3			0.37	-8.6	2	10.6
Non HT20 Beam Forming, 6 to 54 Mbps	3	14	-13.6	-12.9	-13.7		0.37	-8.3		8.26
Non HT20 Beam Forming, 6 to 54 Mbps	4	15	-15.7	-15.6	-15.8	-15.2	0.37	-9.2	-1	8.17
HT/VHT20, M0 to M7	1	9	-9.4				0.2	-9.2	5	14.24
HT/VHT20, M0 to M7	2	12	-10.3	-10.5			0.2	-7.2	2	9.19
HT/VHT20, M8 to M15	2	9	-10.3	-10.5			0.2	-7.2	5	12.19
HT/VHT20, M0 to M7	3	14	-8.7	-10.1	-8.5		0.2	-4.1		4.09
HT/VHT20, M8 to M15	3	11	-8.7	-10.1	-8.5		0.2	-4.1	3	7.09
HT/VHT20, M16 to M23	3	9	-8.7	-10.1	-8.5		0.2	-4.1	5	9.09
HT/VHT20, M0 to M7	4	15	-8.7	-10.1	-8.5	-11.7	0.2	-3.4	-1	2.37
HT/VHT20, M8 to M15	4	12	-8.7	-10.1	-8.5	-11.7	0.2	-3.4	2	5.37

HT/VHT20, M16 to M23	4	10	-8.7	-10.1	-8.5	-11.7	0.2	-3.4	4	7.37
HT/VHT20, M24 to M31	4	9	-8.7	-10.1	-8.5	-11.7	0.2	-3.4	5	8.37
HT/VHT20 Beam Forming, M0 to M7	2	12	-8.7	-10.1			0.2	-6.1	2	8.14
HT/VHT20 Beam Forming, M8 to M15	2	9	-10.3	-10.5			0.2	-7.2	5	12.19
HT/VHT20 Beam Forming, M0 to M7	3	14	-12.7	-12.6	-13.1		0.2	-7.8		7.84
HT/VHT20 Beam Forming, M8 to M15	3	11	-8.7	-10.1	-8.5		0.2	-4.1	3	7.09
HT/VHT20 Beam Forming, M16 to M23	3	9	-8.7	-10.1	-8.5		0.2	-4.1	5	9.09
HT/VHT20 Beam Forming, M0 to M7	4	15	-15.3	-15.3	-15.0	-14.9	0.2	-8.9	-1	7.92
HT/VHT20 Beam Forming, M8 to M15	4	12	-12.7	-12.6	-13.1	-13.6	0.2	-6.8	2	8.77
HT/VHT20 Beam Forming, M16 to M23	4	10	-12.2	-11.6	-11.1	-11.4	0.2	-5.3	4	9.33
HT/VHT20 Beam Forming, M24 to M31	4	9	-8.7	-10.1	-8.5	-11.7	0.2	-3.4	5	8.37
HT/VHT20 STBC, M0 to M7	2	9	-10.3	-10.5			0.2	-7.2	5	12.19
HT/VHT20 STBC, M0 to M7	3	11	-8.7	-10.1	-8.5		0.2	-4.1	3	7.09
HT/VHT20 STBC, M0 to M7	4	12	-8.7	-10.1	-8.5	-11.7	0.2	-3.4	2	5.37
HE20, M0 to M9 1ss	1	9	-9.0				0.2	-8.8	5	13.84
HE20, M0 to M9 1ss	2	12	-12.0	-12.4			0.26	-8.9	2	10.9
HE20, M0 to M9 2ss	2	9	-12.0	-12.4			0.26	-8.9	5	13.9
HE20, M0 to M9 1ss	3	14	-12.0	-12.4	-12.9		0.26	-7.4		7.38
HE20, M0 to M9 2ss	3	11	-12.0	-12.4	-12.9		0.26	-7.4	3	10.38
HE20, M0 to M9 3ss	3	9	-12.0	-12.4	-12.9		0.26	-7.4	5	12.38
HE20, M0 to M9 1ss	4	15	-12.5	-12.5	-11.4	-12.2	0.26	-5.8	-1	4.82
HE20, M0 to M9 2ss	4	12	-12.5	-12.5	-11.4	-12.2	0.26	-5.8	2	7.82
HE20, M0 to M9 3ss	4	10	-12.5	-12.5	-11.4	-12.2	0.26	-5.8	4	9.82
HE20, M0 to M9 4ss	4	9	-12.5	-12.5	-11.4	-12.2	0.26	-5.8	5	10.82
HE20 Beam Forming, M0 to M9 1ss	2	12	-12.5	-12.5			0.26	-9.2	2	11.22
HE20 Beam Forming, M0 to M9 2ss	2	9	-12.0	-12.4			0.26	-8.9	5	13.9
HE20 Beam Forming, M0 to M9 1ss	3	14	-15.0	-13.5	-15.2		0.26	-9.5		9.5
HE20 Beam Forming, M0 to M9 2ss	3	11	-12.5	-12.5	-11.4		0.26	-7.0	3	10.05
HE20 Beam Forming, M0 to M9 3ss	3	9	-12.0	-12.4	-12.9		0.26	-7.4	5	12.38

HE20 Beam Forming, M0 to M9 1ss	4	15	-16.0	-16.4	-16.0	-15.6	0.26	-9.7	-1	8.71
HE20 Beam Forming, M0 to M9 2ss	4	12	-15.0	-13.5	-15.2	-14.6	0.26	-8.3	2	10.27
HE20 Beam Forming, M0 to M9 3ss	4	10	-12.5	-12.5	-11.4	-12.2	0.26	-5.8	4	9.82
HE20 Beam Forming, M0 to M9 4ss	4	9	-12.5	-12.5	-11.4	-12.2	0.26	-5.8	5	10.82
HE20 STBC, M0 to M9 2ss	2	9	-12.0	-12.4			0.26	-8.9	5	13.9
HE20 STBC, M0 to M9 2ss	3	11	-12.0	-12.4	-12.9		0.26	-7.4	3	10.38
HE20 STBC, M0 to M9 2ss	4	12	-12.5	-12.5	-11.4	-12.2	0.26	-5.8	2	7.82

### Frequency 2437 MHz

Mode	Tx Paths	Correlated Antenna Gain (dBi)	Tx 1 PSD (dBm/MHz)	Tx 2 PSD (dBm/MHz)	Tx 3 PSD (dBm/MHz)	Tx 4 PSD (dBm/MHz)	Duty Cycle (dB)	Total PSD (dBm/MHz)	Limit (dBm/MHz)	Margin (dB)
CCK, 1 to 11 Mbps	1	9	0.3				1.41	1.7	5	3.32
CCK, 1 to 11 Mbps	2	12	-3.6	-5.0			1.41	0.1	2	1.86
CCK, 1 to 11 Mbps	3	14	-6.0	-8.3	-8.2		1.41	-1.2		1.18
<b>CCK, 1 to 11 Mbps</b>	<b>4</b>	<b>15</b>	<b>-8.8</b>	<b>-8.9</b>	<b>-8.4</b>	<b>-8.3</b>	<b>1.41</b>	<b>-1.2</b>	<b>-1</b>	<b>0.15</b>
Non HT20, 6 to 54 Mbps	1	9	-5.5				0.37	-5.1	5	10.12
Non HT20, 6 to 54 Mbps	2	12	-5.5	-5.5			0.37	-2.1	2	4.13
Non HT20, 6 to 54 Mbps	3	14	-6.0	-7.6	-7.5		0.37	-1.9		1.86
Non HT20, 6 to 54 Mbps	4	15	-8.6	-8.3	-6.6	-8.3	0.37	-1.5	-1	0.5
Non HT20 Beam Forming, 6 to 54 Mbps	2	12	-8.6	-8.3			0.37	-5.1	2	7.09
Non HT20 Beam Forming, 6 to 54 Mbps	3	14	-12.0	-12.5	-11.7		0.37	-6.9		6.9

Non HT20 Beam Forming, 6 to 54 Mbps	4	15	-14.0	-14.4	-13.3	-13.3	0.37	-7.3	-1	6.33
HT/VHT20, M0 to M7	1	9	-2.6				0.2	-2.4	5	7.41
HT/VHT20, M0 to M7	2	12	-2.6	-3.0			0.2	0.4	2	1.59
HT/VHT20, M8 to M15	2	9	-2.6	-3.0			0.2	0.4	5	4.59
HT/VHT20, M0 to M7	3	14	-4.5	-5.9	-5.9		0.2	-0.4		0.4
HT/VHT20, M8 to M15	3	11	-5.0	-3.7	-4.3		0.2	0.7	3	2.33
HT/VHT20, M16 to M23	3	9	-5.0	-3.7	-4.3		0.2	0.7	5	4.33
HT/VHT20, M0 to M7	4	15	-8.8	-8.3	-7.9	-8.4	0.2	-2.1	-1	1.14
HT/VHT20, M8 to M15	4	12	-4.7	-6.0	-7.2	-6.2	0.2	0.3	2	1.75
HT/VHT20, M16 to M23	4	10	-4.7	-6.0	-7.2	-6.2	0.2	0.3	4	3.75
HT/VHT20, M24 to M31	4	9	-4.7	-6.0	-7.2	-6.2	0.2	0.3	5	4.75
HT/VHT20 Beam Forming, M0 to M7	2	12	-4.7	-6.0			0.2	-2.1	2	4.13
HT/VHT20 Beam Forming, M8 to M15	2	9	-2.6	-3.0			0.2	0.4	5	4.59
HT/VHT20 Beam Forming, M0 to M7	3	14	-10.0	-8.6	-10.9		0.2	-4.8		4.77
HT/VHT20 Beam Forming, M8 to M15	3	11	-4.7	-6.0	-7.2		0.2	-0.9	3	3.91
HT/VHT20 Beam Forming, M16 to M23	3	9	-5.0	-3.7	-4.3		0.2	0.7	5	4.33
HT/VHT20 Beam Forming, M0 to M7	4	15	-12.6	-11.8	-12.8	-12.1	0.2	-6.1	-1	5.08
HT/VHT20 Beam Forming, M8 to M15	4	12	-9.8	-9.1	-9.2	-9.0	0.2	-3.1	2	5.05
HT/VHT20 Beam Forming, M16 to M23	4	10	-6.3	-7.1	-7.8	-7.6	0.2	-0.9	4	4.94
HT/VHT20 Beam Forming, M24 to M31	4	9	-4.7	-6.0	-7.2	-6.2	0.2	0.3	5	4.75
HT/VHT20 STBC, M0 to M7	2	9	-2.6	-3.0			0.2	0.4	5	4.59
HT/VHT20 STBC, M0 to M7	3	11	-5.0	-3.7	-4.3		0.2	0.7	3	2.33
HT/VHT20 STBC, M0 to M7	4	12	-4.7	-6.0	-7.2	-6.2	0.2	0.3	2	1.75
HE20, M0 to M9 1ss	1	9	-4.4				0.26	-4.2	5	9.17
HE20, M0 to M9 1ss	2	12	-4.4	-3.1			0.26	-0.5	2	2.45
HE20, M0 to M9 2ss	2	9	-4.4	-3.1			0.26	-0.5	5	5.45
HE20, M0 to M9 1ss	3	14	-5.8	-6.3	-6.4		0.26	-1.1		1.12
HE20, M0 to M9 2ss	3	11	-6.4	-4.7	-4.0		0.26	0.1	3	2.88
HE20, M0 to M9 3ss	3	9	-6.4	-4.7	-4.0		0.26	0.1	5	4.88
HE20, M0 to M9 1ss	4	15	-7.9	-7.3	-9.3	-8.2	0.26	-1.8	-1	0.83
HE20, M0 to M9 2ss	4	12	-5.8	-6.3	-6.4	-6.3	0.26	0.1	2	1.91
HE20, M0 to M9 3ss	4	10	-5.8	-6.3	-6.4	-6.3	0.26	0.1	4	3.91



HE20, M0 to M9 4ss	4	9	-5.8	-6.3	-6.4	-6.3	0.26	0.1	5	4.91
HE20 Beam Forming, M0 to M9 1ss	2	12	-5.8	-6.3			0.26	-2.8	2	4.78
HE20 Beam Forming, M0 to M9 2ss	2	9	-4.4	-3.1			0.26	-0.5	5	5.45
HE20 Beam Forming, M0 to M9 1ss	3	14	-10.4	-11.0	-11.0		0.26	-5.8		5.78
HE20 Beam Forming, M0 to M9 2ss	3	11	-7.9	-7.3	-9.3		0.26	-3.1	3	6.06
HE20 Beam Forming, M0 to M9 3ss	3	9	-6.4	-4.7	-4.0		0.26	0.1	5	4.88
HE20 Beam Forming, M0 to M9 1ss	4	15	-12.5	-12.4	-13.2	-12.5	0.26	-6.4	-1	5.37
HE20 Beam Forming, M0 to M9 2ss	4	12	-10.2	-9.7	-9.5	-9.8	0.26	-3.5	2	5.5
HE20 Beam Forming, M0 to M9 3ss	4	10	-7.9	-7.3	-9.3	-8.2	0.26	-1.8	4	5.83
HE20 Beam Forming, M0 to M9 4ss	4	9	-5.8	-6.3	-6.4	-6.3	0.26	0.1	5	4.91
HE20 STBC, M0 to M9 2ss	2	9	-4.4	-3.1			0.26	-0.5	5	5.45
HE20 STBC, M0 to M9 2ss	3	11	-6.4	-4.7	-4.0		0.26	0.1	3	2.88
HE20 STBC, M0 to M9 2ss	4	12	-5.8	-6.3	-6.4	-6.3	0.26	0.1	2	1.91

### Frequency 2462 MHz

Mode	Tx Paths	Correlated Antenna Gain (dBi)	Tx 1 PSD (dBm/MHz)	Tx 2 PSD (dBm/MHz)	Tx 3 PSD (dBm/MHz)	Tx 4 PSD (dBm/MHz)	Duty Cycle (dB)	Total PSD (dBm/MHz)	Limit (dBm/MHz)	Margin (dB)
CCK, 1 to 11 Mbps	1	9	0.7				1.41	2.1	5	2.9
<b>CCK, 1 to 11 Mbps</b>	<b>2</b>	<b>12</b>	<b>-3.2</b>	<b>-2.1</b>			<b>1.41</b>	<b>1.8</b>	<b>2</b>	<b>0.2</b>
CCK, 1 to 11 Mbps	3	14	-6.8	-6.0	-6.5		1.41	-0.3		0.25
<b>CCK, 1 to 11 Mbps</b>	<b>4</b>	<b>15</b>	<b>-9.2</b>	<b>-8.3</b>	<b>-8.2</b>	<b>-8.2</b>	<b>1.41</b>	<b>-1.0</b>	<b>-1</b>	<b>0.03</b>

Non HT20, 6 to 54 Mbps	1	9	-10.2				0.37	-9.9	5	14.85
Non HT20, 6 to 54 Mbps	2	12	-11.2	-11.9			0.37	-8.1	2	10.13
Non HT20, 6 to 54 Mbps	3	14	-13.5	-13.1	-12.5		0.37	-7.9		7.87
Non HT20, 6 to 54 Mbps	4	15	-15.0	-14.9	-14.8	-14.0	0.37	-8.3	-1	7.27
Non HT20 Beam Forming, 6 to 54 Mbps	2	12	-15.0	-14.9			0.37	-11.6	2	13.6
Non HT20 Beam Forming, 6 to 54 Mbps	3	14	-17.1	-15.4	-17.4		0.37	-11.4		11.43
Non HT20 Beam Forming, 6 to 54 Mbps	4	15	-19.0	-18.2	-18.2	-18.9	0.37	-12.2	-1	11.17
HT/VHT20, M0 to M7	1	9	-8.6				0.2	-8.4	5	13.37
HT/VHT20, M0 to M7	2	12	-9.5	-12.1			0.2	-7.4	2	9.42
HT/VHT20, M8 to M15	2	9	-9.5	-12.1			0.2	-7.4	5	12.42
HT/VHT20, M0 to M7	3	14	-13.8	-13.1	-11.3		0.2	-7.6		7.64
HT/VHT20, M8 to M15	3	11	-13.8	-13.1	-11.3		0.2	-7.6	3	10.64
HT/VHT20, M16 to M23	3	9	-13.8	-13.1	-11.3		0.2	-7.6	5	12.64
HT/VHT20, M0 to M7	4	15	-13.3	-13.6	-13.8	-14.5	0.2	-7.6	-1	6.57
HT/VHT20, M8 to M15	4	12	-13.3	-13.6	-13.8	-14.5	0.2	-7.6	2	9.57
HT/VHT20, M16 to M23	4	10	-13.3	-13.6	-13.8	-14.5	0.2	-7.6	4	11.57
HT/VHT20, M24 to M31	4	9	-13.3	-13.6	-13.8	-14.5	0.2	-7.6	5	12.57
HT/VHT20 Beam Forming, M0 to M7	2	12	-13.3	-13.6			0.2	-10.3	2	12.26
HT/VHT20 Beam Forming, M8 to M15	2	9	-9.5	-12.1			0.2	-7.4	5	12.42
HT/VHT20 Beam Forming, M0 to M7	3	14	-15.7	-15.1	-15.5		0.2	-10.5		10.49
HT/VHT20 Beam Forming, M8 to M15	3	11	-13.3	-13.6	-13.8		0.2	-8.6	3	11.61
HT/VHT20 Beam Forming, M16 to M23	3	9	-13.8	-13.1	-11.3		0.2	-7.6	5	12.64
HT/VHT20 Beam Forming, M0 to M7	4	15	-16.5	-16.3	-16.7	-17.2	0.2	-10.4	-1	9.42
HT/VHT20 Beam Forming, M8 to M15	4	12	-15.7	-15.1	-15.5	-15.5	0.2	-9.2	2	11.24
HT/VHT20 Beam Forming, M16 to M23	4	10	-14.5	-14.6	-13.6	-15.2	0.2	-8.2	4	12.2
HT/VHT20 Beam Forming, M24 to M31	4	9	-13.3	-13.6	-13.8	-14.5	0.2	-7.6	5	12.57
HT/VHT20 STBC, M0 to M7	2	9	-9.5	-12.1			0.2	-7.4	5	12.42

HT/VHT20 STBC, M0 to M7	3	11	-13.8	-13.1	-11.3		0.2	-7.6	3	10.64
HT/VHT20 STBC, M0 to M7	4	12	-13.3	-13.6	-13.8	-14.5	0.2	-7.6	2	9.57
HE20, M0 to M9 1ss	1	9	-9.2				0.26	-8.9	5	13.89
HE20, M0 to M9 1ss	2	12	-13.9	-13.1			0.26	-10.2	2	12.24
HE20, M0 to M9 2ss	2	9	-13.9	-13.1			0.26	-10.2	5	15.24
HE20, M0 to M9 1ss	3	14	-13.9	-13.4	-13.3		0.26	-8.5		8.49
HE20, M0 to M9 2ss	3	11	-13.9	-13.4	-13.3		0.26	-8.5	3	11.49
HE20, M0 to M9 3ss	3	9	-13.9	-13.4	-13.3		0.26	-8.5	5	13.49
HE20, M0 to M9 1ss	4	15	-14.7	-16.4	-16.2	-15.9	0.26	-9.5	-1	8.47
HE20, M0 to M9 2ss	4	12	-14.7	-16.4	-16.2	-15.9	0.26	-9.5	2	11.47
HE20, M0 to M9 3ss	4	10	-14.7	-16.4	-16.2	-15.9	0.26	-9.5	4	13.47
HE20, M0 to M9 4ss	4	9	-14.7	-16.4	-16.2	-15.9	0.26	-9.5	5	14.47
HE20 Beam Forming, M0 to M9 1ss	2	12	-14.7	-16.4			0.26	-12.2	2	14.21
HE20 Beam Forming, M0 to M9 2ss	2	9	-13.9	-13.1			0.26	-10.2	5	15.24
HE20 Beam Forming, M0 to M9 1ss	3	14	-17.7	-18.2	-17.8		0.26	-12.9		12.87
HE20 Beam Forming, M0 to M9 2ss	3	11	-14.7	-16.4	-16.2		0.26	-10.7	3	13.67
HE20 Beam Forming, M0 to M9 3ss	3	9	-13.9	-13.4	-13.3		0.26	-8.5	5	13.49
HE20 Beam Forming, M0 to M9 1ss	4	15	-19.2	-18.5	-18.5	-19.2	0.26	-12.5	-1	11.54
HE20 Beam Forming, M0 to M9 2ss	4	12	-17.7	-18.2	-17.8	-18.8	0.26	-11.8	2	13.81
HE20 Beam Forming, M0 to M9 3ss	4	10	-14.7	-16.4	-16.2	-15.9	0.26	-9.5	4	13.47
HE20 Beam Forming, M0 to M9 4ss	4	9	-14.7	-16.4	-16.2	-15.9	0.26	-9.5	5	14.47
HE20 STBC, M0 to M9 2ss	2	9	-13.9	-13.1			0.26	-10.2	5	15.24
HE20 STBC, M0 to M9 2ss	3	11	-13.9	-13.4	-13.3		0.26	-8.5	3	11.49
HE20 STBC, M0 to M9 2ss	4	12	-14.7	-16.4	-16.2	-15.9	0.26	-9.5	2	11.47

## Data Screenshots

2462 MHz: CCK, 1 to 11 Mbps



Antenna A

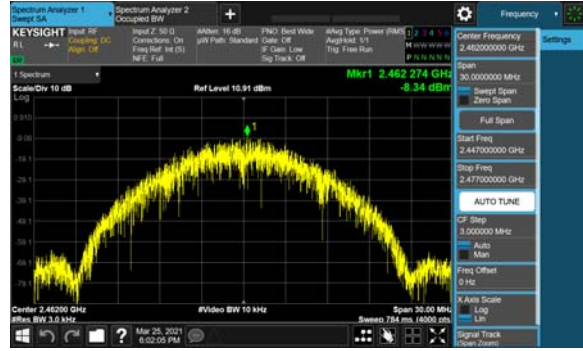

Antenna B



Antenna C



Antenna D

2437 MHz: CCK, 1 to 11 Mbps

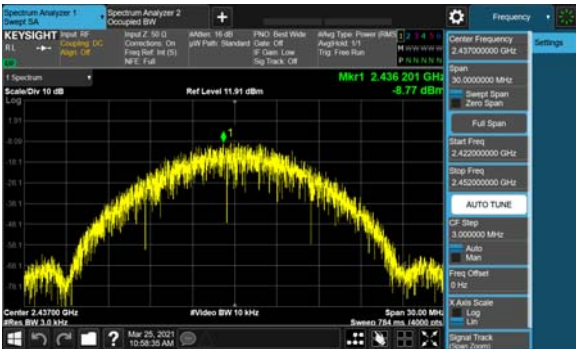

Antenna A



Antenna B



Antenna C

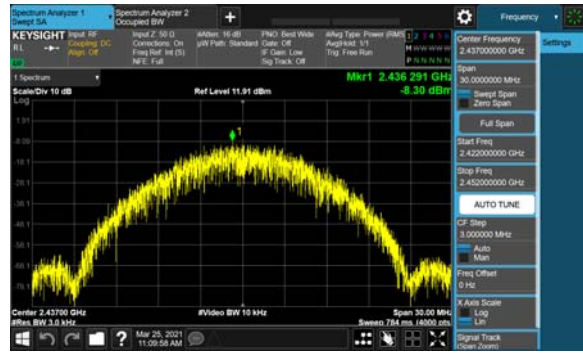

Antenna D

2462 MHz: CCK, 1 to 11 Mbps



Antenna A



Antenna B

# A.6 Conducted Spurious Emissions

## Conducted Spurious Emissions Test Requirement

### 15.205 / RSS-Gen

Radiated emissions which fall in the restricted bands, as defined in Section 15.205(a) and RSS-GEN section 8.10, must also comply with the radiated emission limits specified in Section 15.209(a) (see Section 15.205(c)) and RSS-Gen section 8.9

**RSS-Gen 8.9** Except when the requirements applicable to a given device state otherwise, emissions from licence-exempt transmitters shall comply with the field strength limits shown in Table 4 and Table 5 below. Additionally, the level of any transmitter emission shall not exceed the level of the transmitter’s fundamental emission.

**RSS-Gen 8.10 (b)** Unwanted emissions that fall into restricted bands of Table 6 shall comply with the limits specified in RSS-Gen; and (c) Unwanted emissions that do not fall within the restricted frequency bands of Table 6 shall comply either with the limits specified in the applicable RSS or with those specified in this RSS-Gen.

Use formula below to substitute conducted measurements in place of radiated measurements

$$E[\text{dB}\mu\text{V/m}] = \text{EIRP}[\text{dBm}] - 20 \log(d[\text{meters}]) + 104.77, \text{ where } E = \text{field strength and } d = 3 \text{ meter}$$

- 1) Average Plot, Limit= -41.25 dBm eirp
- 2) Peak plot, Limit = -21.25 dBm eirp

## Conducted Spurious Emissions Test Method

Ref. KDB 558074 D01 DTS Meas Guidance v05r02

ANSI C63.10: 2013

<p><b>Conducted Spurious Emissions</b> Test Procedure</p>
<ol style="list-style-type: none"> <li>1. Connect the antenna port(s) to the spectrum analyzer input.</li> <li>2. Place the radio in continuous transmit mode</li> <li>3. Configure Spectrum analyzer as per test parameters below (be sure to enter all losses between the transmitter output and the spectrum analyzer).</li> <li>4. Use the peak marker function to determine the maximum spurs amplitude level.</li> <li>5. The “measure-and-sum technique” is used for measuring in-band transmit power of a device. In the measure-and-sum approach, the conducted emission level is measured at each antenna port. The measured results at the various antenna ports are then summed mathematically to determine the total emission level from the device. Summing is performed in linear power units. The worst case output is recorded. (see ANSI C63.10 2013 section 14.3.2.2)</li> <li>6. Capture graphs and record pertinent measurement data.</li> </ol>

Ref. KDB 558074 D01 DTS Meas Guidance v05r02, section 8.1 c) 3, section 8.6 DTS emissions in restricted frequency bands

ANSI C63.10: 2013 section 11.12.2.4 (Peak) & 11.12.2.5.2 (Average)

<p><b>Conducted Spurious Emissions</b> Test parameters</p>	
<p><b>Peak</b> Span = 30MHz to 26.5GHz / 26.5GHz to 40GHz RBW = 1 MHz VBW ≥ 3 MHz Sweep = Auto</p>	<p><b>Average</b> Span = 30MHz to 26.5GHz / 26.5GHz to 40GHz RBW = 1 MHz VBW ≥ 3 MHz Sweep = Auto</p>

Detector = Peak Trace = Max Hold.	Detector = RMS Power Averaging
--------------------------------------	-----------------------------------

ANSI C63.10: 2013 section 11.12.2.2 c) add the max antenna gain + ground reflection factor (4.7 dB for frequencies between 30 MHz and 1000 MHz, and 0 dB for frequencies > 1000 MHz).

<b>Tested By :</b> Said Abdelwafi, Julian Land	<b>Date of testing:</b> 02-MAR-2021 through 25-MAR-2021
<b>Test Result : PASS</b>	

#### **Test Equipment**

See Appendix C for list of test equipment

# Conducted Spurs Average Upper

**Spectrum Analyzer 1**  
Swept SA

**KEYSIGHT** Input: RF  
R.L. → Coupling: DC  
Align: Off

Input Z: 50 Ω  
Corrections: On  
Freq Ref: Int (S)  
NFE: Full

#Atten: 0 dB  
μW Path: Standard

PNO: Fast  
Gate: Off  
IF Gain: High  
Sig Track: Off

#Avg Type: Power (RMS)  
Avg|Hold: 125/125  
Trig: Free Run

1 2 3 4 5 6  
A W W W W W  
A N N N N N

Frequency

Center Frequency  
19.000000000 GHz

Span  
14.000000000 GHz

Swept Span  
Zero Span

Full Span

Start Freq  
12.000000000 GHz

Stop Freq  
26.000000000 GHz

AUTO TUNE

CF Step  
1.400000000 GHz

Auto  
Man

Freq Offset  
0 Hz

X Axis Scale  
Log  
Lin

Signal Track  
(Span Zoom)

1 Spectrum

Scale/Div 10 dB      Ref Level -10.00 dBm

Start 12.000 GHz      #Video BW 3.0 MHz\*      Stop 26.000 GHz  
#Res BW 1.0 MHz      Sweep ~25.1 ms (1001 pts)

5 Marker Table

Mode	Trace	Scale	X	Y	Function	Function Width	Function Value
1	N	1	f	12.000 GHz	-92.55 dBm		
2	N	1	f	12.000 GHz	-92.55 dBm		
3	N	1	f	12.000 GHz	-92.55 dBm		
4	N	1	f	23.788 GHz	-81.55 dBm		
5							
6							

Windows icons: [Start] [Back] [Forward] [File Explorer] [Help] [Search] [Taskbar]

System tray: Mar 03, 2021 5:23:47 PM [Network] [Volume] [Battery]



# Conducted Spurs Peak Upper

Spectrum Analyzer 1  
Swept SA

**KEYSIGHT** Input: RF  
R.L. → Coupling: DC  
Align: Off

Input Z: 50 Ω  
Corrections: On  
Freq Ref: Int (S)  
NFE: Full

#Atten: 0 dB  
μW Path: Standard

PNO: Fast  
Gate: Off  
IF Gain: High  
Sig Track: Off

#Avg Type: Power (RMS)  
Avg|Hold: 125/125  
Trig: Free Run

1 2 3 4 5 6  
M WWW WWW W  
P N N N N N

Settings

Center Frequency  
19.000000000 GHz

Span  
14.0000000 GHz

Swept Span  
 Zero Span

Full Span

Start Freq  
12.000000000 GHz

Stop Freq  
26.000000000 GHz

AUTO TUNE

CF Step  
1.400000000 GHz

Auto  
 Man

Freq Offset  
0 Hz

X Axis Scale  
 Log  
 Lin

Signal Track  
(Span Zoom)

1 Spectrum

Scale/Div 10 dB      Ref Level -10.00 dBm

**Mkr4 25.720 GHz  
-60.07 dBm**

Start 12.000 GHz      #Video BW 3.0 MHz      Stop 26.000 GHz  
#Res BW 1.0 MHz      Sweep ~25.1 ms (1001 pts)

5 Marker Table

	Mode	Trace	Scale	X	Y	Function	Function Width	Function Value
1	N	1	f	12.000 GHz	-73.27 dBm			
2	N	1	f	12.000 GHz	-73.27 dBm			
3	N	1	f	12.000 GHz	-73.27 dBm			
4	N	1	f	25.720 GHz	-60.07 dBm			
5								
6								

Windows icons: [Start] [Back] [Forward] [File Explorer] [Help] [Search] [Taskbar]

Mar 03, 2021 5:25:37 PM

Navigation icons: [Zoom In] [Zoom Out] [Reset] [Full Screen] [Refresh]

## Conducted Spurs Average

### Frequency 2412 MHz

Mode	Tx Paths	Correlated Antenna Gain (dBi)	Tx 1 Spur Power (dBm)	Tx 2 Spur Power (dBm)	Tx 3 Spur Power (dBm)	Tx 4 Spur Power (dBm)	Duty Cycle (dB)	Total Conducted Spur (dBm)	Limit (dB)	Margin (dB)
CCK, 1 to 11 Mbps	1	9	-60.3				1.41	-49.9	-41	8.64
CCK, 1 to 11 Mbps	2	9	-61.3	-61.5			1.41	-48.0	-41	6.73
CCK, 1 to 11 Mbps	3	9	-63.5	-64.2	-66.9		1.41	-49.5	-41	8.21
CCK, 1 to 11 Mbps	4	9	-64.1	-64.5	-67.9	-69.4	1.41	-49.5	-41	8.25
Non HT20, 6 to 54 Mbps	1	9	-61.2				0.37	-51.8	-41	10.58
Non HT20, 6 to 54 Mbps	2	9	-63.1	-63.9			0.37	-51.1	-41	9.86
Non HT20, 6 to 54 Mbps	3	9	-63.1	-63.9	-66.4		0.37	-50.1	-41	8.87
Non HT20, 6 to 54 Mbps	4	9	-63.1	-63.9	-66.4	-68.1	0.37	-49.6	-41	8.31
Non HT20 Beam Forming, 6 to 54 Mbps	2	12	-63.1	-63.9			0.37	-48.1	-41	6.86
Non HT20 Beam Forming, 6 to 54 Mbps	3	14	-63.8	-64.8	-67.3		0.37	-45.9	-41	4.68
Non HT20 Beam Forming, 6 to 54 Mbps	4	15	-65.2	-65.5	-68.3	-70.0	0.37	-45.4	-41	4.18
HT/VHT20, M0 to M7	1	9	-62.0				0.2	-52.8	-41	11.55
HT/VHT20, M0 to M7	2	9	-62.4	-63.3			0.2	-50.6	-41	9.37
HT/VHT20, M8 to M15	2	9	-62.4	-63.3			0.2	-50.6	-41	9.37
HT/VHT20, M0 to M7	3	9	-63.2	-64.0	-66.5		0.2	-50.4	-41	9.14
HT/VHT20, M8 to M15	3	9	-63.2	-64.0	-66.5		0.2	-50.4	-41	9.14
HT/VHT20, M16 to M23	3	9	-63.2	-64.0	-66.5		0.2	-50.4	-41	9.14
HT/VHT20, M0 to M7	4	9	-63.2	-64.0	-66.5	-68.1	0.2	-49.8	-41	8.56
HT/VHT20, M8 to M15	4	9	-63.2	-64.0	-66.5	-68.1	0.2	-49.8	-41	8.56

HT/VHT20, M16 to M23	4	9	-63.2	-64.0	-66.5	-68.1	0.2	-49.8	-41	8.56
HT/VHT20, M24 to M31	4	9	-63.2	-64.0	-66.5	-68.1	0.2	-49.8	-41	8.56
HT/VHT20 Beam Forming, M0 to M7	2	12	-63.2	-64.0			0.2	-48.4	-41	7.12
HT/VHT20 Beam Forming, M8 to M15	2	9	-62.4	-63.3			0.2	-50.6	-41	9.37
HT/VHT20 Beam Forming, M0 to M7	3	14	-64.6	-65.3	-68.1		0.2	-46.8	-41	5.54
HT/VHT20 Beam Forming, M8 to M15	3	11	-63.2	-64.0	-66.5		0.2	-48.4	-41	7.14
HT/VHT20 Beam Forming, M16 to M23	3	9	-63.2	-64.0	-66.5		0.2	-50.4	-41	9.14
HT/VHT20 Beam Forming, M0 to M7	4	15	-66.4	-66.9	-69.3	-70.7	0.2	-46.8	-41	5.52
HT/VHT20 Beam Forming, M8 to M15	4	12	-64.6	-65.3	-68.1	-69.4	0.2	-48.2	-41	6.95
HT/VHT20 Beam Forming, M16 to M23	4	10	-63.7	-64.5	-67.1	-68.7	0.2	-49.3	-41	8.09
HT/VHT20 Beam Forming, M24 to M31	4	9	-63.2	-64.0	-66.5	-68.1	0.2	-49.8	-41	8.56
HT/VHT20 STBC, M0 to M7	2	9	-62.4	-63.3			0.2	-50.6	-41	9.37
HT/VHT20 STBC, M0 to M7	3	9	-63.2	-64.0	-66.5		0.2	-50.4	-41	9.14
HT/VHT20 STBC, M0 to M7	4	9	-63.2	-64.0	-66.5	-68.1	0.2	-49.8	-41	8.56
HE20, M0 to M9 1ss	1	9	-62.4				0.2	-53.2	-41	11.95
HE20, M0 to M9 1ss	2	9	-63.0	-63.7			0.26	-51.1	-41	9.81
HE20, M0 to M9 2ss	2	9	-63.0	-63.7			0.26	-51.1	-41	9.81
HE20, M0 to M9 1ss	3	9	-63.0	-63.7	-66.3		0.26	-50.1	-41	8.83
HE20, M0 to M9 2ss	3	9	-63.0	-63.7	-66.3		0.26	-50.1	-41	8.83
HE20, M0 to M9 3ss	3	9	-63.0	-63.7	-66.3		0.26	-50.1	-41	8.83
HE20, M0 to M9 1ss	4	9	-63.6	-64.2	-67.0	-68.4	0.26	-50.1	-41	8.84
HE20, M0 to M9 2ss	4	9	-63.6	-64.2	-67.0	-68.4	0.26	-50.1	-41	8.84
HE20, M0 to M9 3ss	4	9	-63.6	-64.2	-67.0	-68.4	0.26	-50.1	-41	8.84
HE20, M0 to M9 4ss	4	9	-63.6	-64.2	-67.0	-68.4	0.26	-50.1	-41	8.84
HE20 Beam Forming, M0 to M9 1ss	2	12	-63.6	-64.2			0.26	-48.6	-41	7.37
HE20 Beam Forming, M0 to M9 2ss	2	9	-63.0	-63.7			0.26	-51.1	-41	9.81
HE20 Beam Forming, M0 to M9 1ss	3	14	-65.3	-65.6	-68.4		0.26	-47.2	-41	5.94
HE20 Beam Forming, M0 to M9 2ss	3	11	-63.6	-64.2	-67.0		0.26	-48.7	-41	7.42
HE20 Beam Forming, M0 to M9 3ss	3	9	-63.0	-63.7	-66.3		0.26	-50.1	-41	8.83

HE20 Beam Forming, M0 to M9 1ss	4	15	-66.5	-67.0	-69.4	-70.9	0.26	-46.8	-41	5.57
HE20 Beam Forming, M0 to M9 2ss	4	12	-65.3	-65.6	-68.4	-69.5	0.26	-48.6	-41	7.31
HE20 Beam Forming, M0 to M9 3ss	4	10	-63.6	-64.2	-67.0	-68.4	0.26	-49.1	-41	7.84
HE20 Beam Forming, M0 to M9 4ss	4	9	-63.6	-64.2	-67.0	-68.4	0.26	-50.1	-41	8.84
HE20 STBC, M0 to M9 2ss	2	9	-63.0	-63.7			0.26	-51.1	-41	9.81
HE20 STBC, M0 to M9 2ss	3	9	-63.0	-63.7	-66.3		0.26	-50.1	-41	8.83
HE20 STBC, M0 to M9 2ss	4	9	-63.6	-64.2	-67.0	-68.4	0.26	-50.1	-41	8.84

### Frequency 2437 MHz

Mode	Tx Paths	Correlated Antenna Gain (dBi)	Tx 1 Spur Power (dBm)	Tx 2 Spur Power (dBm)	Tx 3 Spur Power (dBm)	Tx 4 Spur Power (dBm)	Duty Cycle (dB)	Total Conducted Spur (dBm)	Limit (dB)	Margin (dB)
CCK, 1 to 11 Mbps	1	9	-60.0				1.41	-49.6	-41	8.34
CCK, 1 to 11 Mbps	2	9	-62.6	-62.4			1.41	-49.1	-41	7.83
CCK, 1 to 11 Mbps	3	9	-65.0	-64.3	-63.8		1.41	-49.2	-41	7.91
CCK, 1 to 11 Mbps	4	9	-65.4	-65.2	-65.1	-65.6	1.41	-48.9	-41	7.64
Non HT20, 6 to 54 Mbps	1	9	-60.2				0.37	-50.8	-41	9.58
Non HT20, 6 to 54 Mbps	2	9	-60.2	-60.2			0.37	-47.8	-41	6.57
Non HT20, 6 to 54 Mbps	3	9	-60.8	-60.8	-61.1		0.37	-46.8	-41	5.51
Non HT20, 6 to 54 Mbps	4	9	-61.6	-61.4	-61.8	-62.3	0.37	-46.4	-41	5.13
Non HT20 Beam Forming, 6 to 54 Mbps	2	12	-61.6	-61.4			0.37	-46.1	-41	4.87
Non HT20 Beam Forming, 6 to 54 Mbps	3	14	-64.3	-64.2	-64.3		0.37	-45.1	-41	3.88

<b>Non HT20 Beam Forming, 6 to 54 Mbps</b>	<b>4</b>	<b>15</b>	<b>-66.1</b>	<b>-65.5</b>	<b>-65.5</b>	<b>-66.1</b>	<b>0.37</b>	<b>-44.4</b>	<b>-41</b>	<b>3.15</b>
HT/VHT20, M0 to M7	1	9	-60.3				0.2	-51.1	-41	9.85
HT/VHT20, M0 to M7	2	9	-60.3	-60.3			0.2	-48.1	-41	6.84
HT/VHT20, M8 to M15	2	9	-60.3	-60.3			0.2	-48.1	-41	6.84
HT/VHT20, M0 to M7	3	9	-61.1	-60.9	-61.2		0.2	-47.1	-41	5.85
HT/VHT20, M8 to M15	3	9	-60.5	-60.5	-61.0		0.2	-46.7	-41	5.44
HT/VHT20, M16 to M23	3	9	-60.5	-60.5	-61.0		0.2	-46.7	-41	5.44
HT/VHT20, M0 to M7	4	9	-63.1	-62.8	-63.0	-63.5	0.2	-47.9	-41	6.62
HT/VHT20, M8 to M15	4	9	-61.4	-61.5	-61.3	-62.4	0.2	-46.4	-41	5.16
HT/VHT20, M16 to M23	4	9	-61.4	-61.5	-61.3	-62.4	0.2	-46.4	-41	5.16
HT/VHT20, M24 to M31	4	9	-61.4	-61.5	-61.3	-62.4	0.2	-46.4	-41	5.16
HT/VHT20 Beam Forming, M0 to M7	2	12	-61.4	-61.5			0.2	-46.2	-41	4.99
HT/VHT20 Beam Forming, M8 to M15	2	9	-60.3	-60.3			0.2	-48.1	-41	6.84
HT/VHT20 Beam Forming, M0 to M7	3	14	-64.5	-64.0	-64.4		0.2	-45.3	-41	4.08
HT/VHT20 Beam Forming, M8 to M15	3	11	-61.4	-61.5	-61.3		0.2	-45.4	-41	4.18
HT/VHT20 Beam Forming, M16 to M23	3	9	-60.5	-60.5	-61.0		0.2	-46.7	-41	5.44
<b>HT/VHT20 Beam Forming, M0 to M7</b>	<b>4</b>	<b>15</b>	<b>-66.1</b>	<b>-65.9</b>	<b>-65.9</b>	<b>-66.2</b>	<b>0.2</b>	<b>-44.8</b>	<b>-41</b>	<b>3.56</b>
HT/VHT20 Beam Forming, M8 to M15	4	12	-63.6	-63.4	-63.5	-64.2	0.2	-45.4	-41	4.2
HT/VHT20 Beam Forming, M16 to M23	4	10	-62.3	-62.0	-62.2	-62.9	0.2	-46.1	-41	4.87
HT/VHT20 Beam Forming, M24 to M31	4	9	-61.4	-61.5	-61.3	-62.4	0.2	-46.4	-41	5.16
HT/VHT20 STBC, M0 to M7	2	9	-60.3	-60.3			0.2	-48.1	-41	6.84
HT/VHT20 STBC, M0 to M7	3	9	-60.5	-60.5	-61.0		0.2	-46.7	-41	5.44
HT/VHT20 STBC, M0 to M7	4	9	-61.4	-61.5	-61.3	-62.4	0.2	-46.4	-41	5.16
HE20, M0 to M9 1ss	1	9	-60.5				0.26	-51.2	-41	9.99
HE20, M0 to M9 1ss	2	9	-60.5	-60.4			0.26	-48.2	-41	6.93
HE20, M0 to M9 2ss	2	9	-60.5	-60.4			0.26	-48.2	-41	6.93
HE20, M0 to M9 1ss	3	9	-61.5	-61.5	-61.7		0.26	-47.5	-41	6.28
HE20, M0 to M9 2ss	3	9	-61.0	-61.0	-61.3		0.26	-47.1	-41	5.81
HE20, M0 to M9 3ss	3	9	-61.0	-61.0	-61.3		0.26	-47.1	-41	5.81
HE20, M0 to M9 1ss	4	9	-62.1	-62.0	-62.5	-62.7	0.26	-47.0	-41	5.78
HE20, M0 to M9 2ss	4	9	-61.5	-61.5	-61.7	-62.4	0.26	-46.5	-41	5.23
HE20, M0 to M9 3ss	4	9	-61.5	-61.5	-61.7	-62.4	0.26	-46.5	-41	5.23

HE20, M0 to M9 4ss	4	9	-61.5	-61.5	-61.7	-62.4	0.26	-46.5	-41	5.23
HE20 Beam Forming, M0 to M9 1ss	2	12	-61.5	-61.5			0.26	-46.2	-41	4.98
HE20 Beam Forming, M0 to M9 2ss	2	9	-60.5	-60.4			0.26	-48.2	-41	6.93
HE20 Beam Forming, M0 to M9 1ss	3	14	-64.1	-64.2	-64.0		0.26	-45.1	-41	3.82
HE20 Beam Forming, M0 to M9 2ss	3	11	-62.1	-62.0	-62.5		0.26	-46.2	-41	4.91
HE20 Beam Forming, M0 to M9 3ss	3	9	-61.0	-61.0	-61.3		0.26	-47.1	-41	5.81
<b>HE20 Beam Forming, M0 to M9 1ss</b>	<b>4</b>	<b>15</b>	<b>-65.8</b>	<b>-65.5</b>	<b>-65.1</b>	<b>-65.8</b>	<b>0.26</b>	<b>-44.3</b>	<b>-41</b>	<b>3.01</b>
HE20 Beam Forming, M0 to M9 2ss	4	12	-63.4	-63.5	-63.3	-63.9	0.26	-45.2	-41	3.99
HE20 Beam Forming, M0 to M9 3ss	4	10	-62.1	-62.0	-62.5	-62.7	0.26	-46.0	-41	4.78
HE20 Beam Forming, M0 to M9 4ss	4	9	-61.5	-61.5	-61.7	-62.4	0.26	-46.5	-41	5.23
HE20 STBC, M0 to M9 2ss	2	9	-60.5	-60.4			0.26	-48.2	-41	6.93
HE20 STBC, M0 to M9 2ss	3	9	-61.0	-61.0	-61.3		0.26	-47.1	-41	5.81
HE20 STBC, M0 to M9 2ss	4	9	-61.5	-61.5	-61.7	-62.4	0.26	-46.5	-41	5.23

#### Frequency 2462 MHz

Mode	Tx Paths	Correlated Antenna Gain (dBi)	Tx 1 Spur Power (dBm)	Tx 2 Spur Power (dBm)	Tx 3 Spur Power (dBm)	Tx 4 Spur Power (dBm)	Duty Cycle (dB)	Total Conducted Spur (dBm)	Limit (dB)	Margin (dB)
CCK, 1 to 11 Mbps	1	9	-60.4				1.41	-50.0	-41	8.74
CCK, 1 to 11 Mbps	2	9	-60.3	-61.2			1.41	-47.3	-41	6.06
CCK, 1 to 11 Mbps	3	9	-63.2	-62.8	-65.2		1.41	-48.4	-41	7.18
CCK, 1 to 11 Mbps	4	9	-64.7	-64.6	-66.2	-68.6	1.41	-49.3	-41	8.07

Non HT20, 6 to 54 Mbps	1	9	-62.0				0.37	-52.6	-41	11.38
Non HT20, 6 to 54 Mbps	2	9	-63.3	-63.8			0.37	-51.2	-41	9.92
Non HT20, 6 to 54 Mbps	3	9	-63.9	-64.3	-66.1		0.37	-50.5	-41	9.28
Non HT20, 6 to 54 Mbps	4	9	-64.7	-65.3	-66.8	-68.7	0.37	-50.7	-41	9.48
Non HT20 Beam Forming, 6 to 54 Mbps	2	12	-64.7	-65.3			0.37	-49.6	-41	8.36
Non HT20 Beam Forming, 6 to 54 Mbps	3	14	-66.3	-66.6	-68.0		0.37	-47.8	-41	6.52
Non HT20 Beam Forming, 6 to 54 Mbps	4	15	-67.3	-67.4	-69.5	-70.9	0.37	-47.1	-41	5.89
HT/VHT20, M0 to M7	1	9	-62.5				0.2	-53.3	-41	12.05
HT/VHT20, M0 to M7	2	9	-63.9	-64.3			0.2	-51.9	-41	10.64
HT/VHT20, M8 to M15	2	9	-63.9	-64.3			0.2	-51.9	-41	10.64
HT/VHT20, M0 to M7	3	9	-64.6	-64.8	-66.9		0.2	-51.3	-41	10.1
HT/VHT20, M8 to M15	3	9	-64.6	-64.8	-66.9		0.2	-51.3	-41	10.1
HT/VHT20, M16 to M23	3	9	-64.6	-64.8	-66.9		0.2	-51.3	-41	10.1
HT/VHT20, M0 to M7	4	9	-65.4	-65.6	-67.6	-69.3	0.2	-51.5	-41	10.23
HT/VHT20, M8 to M15	4	9	-65.4	-65.6	-67.6	-69.3	0.2	-51.5	-41	10.23
HT/VHT20, M16 to M23	4	9	-65.4	-65.6	-67.6	-69.3	0.2	-51.5	-41	10.23
HT/VHT20, M24 to M31	4	9	-65.4	-65.6	-67.6	-69.3	0.2	-51.5	-41	10.23
HT/VHT20 Beam Forming, M0 to M7	2	12	-65.4	-65.6			0.2	-50.3	-41	9.04
HT/VHT20 Beam Forming, M8 to M15	2	9	-63.9	-64.3			0.2	-51.9	-41	10.64
HT/VHT20 Beam Forming, M0 to M7	3	14	-66.5	-67.0	-68.7		0.2	-48.3	-41	7.08
HT/VHT20 Beam Forming, M8 to M15	3	11	-65.4	-65.6	-67.6		0.2	-50.1	-41	8.87
HT/VHT20 Beam Forming, M16 to M23	3	9	-64.6	-64.8	-66.9		0.2	-51.3	-41	10.1
HT/VHT20 Beam Forming, M0 to M7	4	15	-67.6	-67.8	-69.5	-71.0	0.2	-47.5	-41	6.3
HT/VHT20 Beam Forming, M8 to M15	4	12	-66.5	-67.0	-68.7	-70.6	0.2	-49.7	-41	8.45
HT/VHT20 Beam Forming, M16 to M23	4	10	-66.1	-66.2	-68.5	-69.9	0.2	-51.2	-41	9.93
HT/VHT20 Beam Forming, M24 to M31	4	9	-65.4	-65.6	-67.6	-69.3	0.2	-51.5	-41	10.23
HT/VHT20 STBC, M0 to M7	2	9	-63.9	-64.3			0.2	-51.9	-41	10.64

HT/VHT20 STBC, M0 to M7	3	9	-64.6	-64.8	-66.9		0.2	-51.3	-41	10.1
HT/VHT20 STBC, M0 to M7	4	9	-65.4	-65.6	-67.6	-69.3	0.2	-51.5	-41	10.23
HE20, M0 to M9 1ss	1	9	-62.4				0.26	-53.1	-41	11.89
HE20, M0 to M9 1ss	2	9	-64.5	-64.8			0.26	-52.4	-41	11.12
HE20, M0 to M9 2ss	2	9	-64.5	-64.8			0.26	-52.4	-41	11.12
HE20, M0 to M9 1ss	3	9	-65.2	-65.4	-67.8		0.26	-52.0	-41	10.7
HE20, M0 to M9 2ss	3	9	-65.2	-65.4	-67.8		0.26	-52.0	-41	10.7
HE20, M0 to M9 3ss	3	9	-65.2	-65.4	-67.8		0.26	-52.0	-41	10.7
HE20, M0 to M9 1ss	4	9	-65.9	-66.1	-68.2	-69.8	0.26	-51.9	-41	10.69
HE20, M0 to M9 2ss	4	9	-65.9	-66.1	-68.2	-69.8	0.26	-51.9	-41	10.69
HE20, M0 to M9 3ss	4	9	-65.9	-66.1	-68.2	-69.8	0.26	-51.9	-41	10.69
HE20, M0 to M9 4ss	4	9	-65.9	-66.1	-68.2	-69.8	0.26	-51.9	-41	10.69
HE20 Beam Forming, M0 to M9 1ss	2	12	-65.9	-66.1			0.26	-50.7	-41	9.48
HE20 Beam Forming, M0 to M9 2ss	2	9	-64.5	-64.8			0.26	-52.4	-41	11.12
HE20 Beam Forming, M0 to M9 1ss	3	14	-67.1	-67.3	-69.4		0.26	-48.8	-41	7.53
HE20 Beam Forming, M0 to M9 2ss	3	11	-65.9	-66.1	-68.2		0.26	-50.6	-41	9.33
HE20 Beam Forming, M0 to M9 3ss	3	9	-65.2	-65.4	-67.8		0.26	-52.0	-41	10.7
HE20 Beam Forming, M0 to M9 1ss	4	15	-67.6	-67.9	-69.5	-71.1	0.26	-47.5	-41	6.28
HE20 Beam Forming, M0 to M9 2ss	4	12	-67.1	-67.3	-69.4	-70.7	0.26	-50.1	-41	8.84
HE20 Beam Forming, M0 to M9 3ss	4	10	-65.9	-66.1	-68.2	-69.8	0.26	-50.9	-41	9.69
HE20 Beam Forming, M0 to M9 4ss	4	9	-65.9	-66.1	-68.2	-69.8	0.26	-51.9	-41	10.69
HE20 STBC, M0 to M9 2ss	2	9	-64.5	-64.8			0.26	-52.4	-41	11.12
HE20 STBC, M0 to M9 2ss	3	9	-65.2	-65.4	-67.8		0.26	-52.0	-41	10.7
HE20 STBC, M0 to M9 2ss	4	9	-65.9	-66.1	-68.2	-69.8	0.26	-51.9	-41	10.69

## Data Screenshots

2437 MHz: HE20 Beam Forming, M0 to M9 1ss





Antenna A



Antenna B



Antenna C

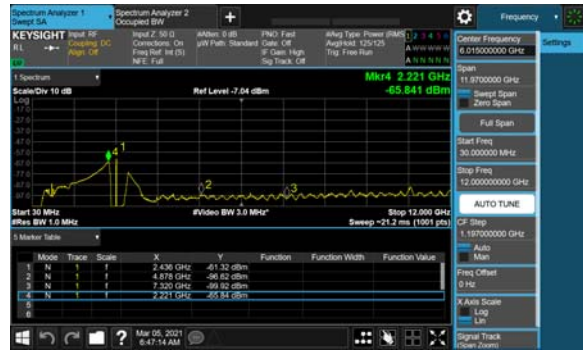

Antenna D

2437 MHz: Non HT20 Beam Forming, 6 to 54 Mbps



Antenna A

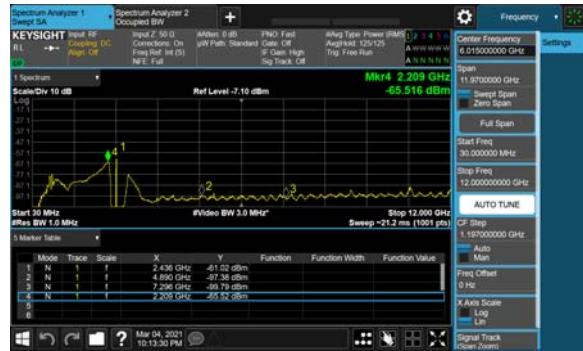

Antenna B



Antenna C



Antenna D

2437 MHz: HT/VHT20 Beam Forming, M0 to M7



Antenna A



Antenna B



Antenna C

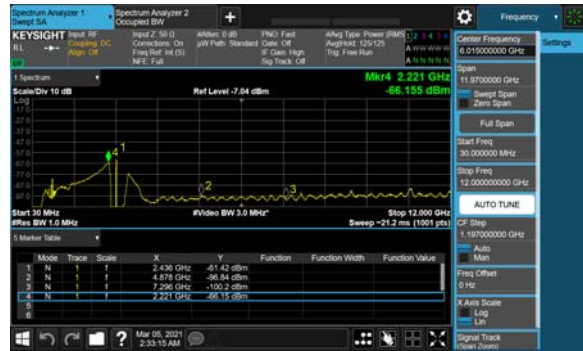

Antenna D

## Conducted Spurs Peak

### Frequency 2412 MHz

Mode	Tx Paths	Correlated Antenna Gain (dBi)	Tx 1 Spur Power (dBm)	Tx 2 Spur Power (dBm)	Tx 3 Spur Power (dBm)	Tx 4 Spur Power (dBm)	Duty Cycle (dB)	Total Conducted Spur (dBm)	Limit (dB)	Margin (dB)
CCK, 1 to 11 Mbps	1	9	-69.2				1.41	-58.8	-21	37.54
CCK, 1 to 11 Mbps	2	9	-69.6	-68.9			1.41	-55.8	-21	34.57
CCK, 1 to 11 Mbps	3	9	-68.7	-69.5	-68.6		1.41	-53.7	-21	32.48
CCK, 1 to 11 Mbps	4	9	-70.3	-69.6	-70.0	-69.0	1.41	-53.3	-21	32.02
Non HT20, 6 to 54 Mbps	1	9	-70.1				0.37	-60.7	-21	39.48
Non HT20, 6 to 54 Mbps	2	9	-69.3	-70.1			0.37	-57.3	-21	36.06
Non HT20, 6 to 54 Mbps	3	9	-69.3	-70.1	-68.8		0.37	-55.2	-21	33.98
Non HT20, 6 to 54 Mbps	4	9	-69.3	-70.1	-68.8	-69.9	0.37	-54.1	-21	32.86
Non HT20 Beam Forming, 6 to 54 Mbps	2	12	-69.3	-70.1			0.37	-54.3	-21	33.06
Non HT20 Beam Forming, 6 to 54 Mbps	3	14	-68.4	-68.8	-68.3		0.37	-49.4	-21	28.11
Non HT20 Beam Forming, 6 to 54 Mbps	4	15	-69.7	-69.7	-70.0	-69.9	0.37	-48.4	-21	27.19
HT/VHT20, M0 to M7	1	9	-69.6				0.2	-60.4	-21	39.15
HT/VHT20, M0 to M7	2	9	-69.9	-69.2			0.2	-57.3	-21	36.08
HT/VHT20, M8 to M15	2	9	-69.9	-69.2			0.2	-57.3	-21	36.08
HT/VHT20, M0 to M7	3	9	-69.7	-69.5	-70.7		0.2	-56.0	-21	34.72
HT/VHT20, M8 to M15	3	9	-69.7	-69.5	-70.7		0.2	-56.0	-21	34.72
HT/VHT20, M16 to M23	3	9	-69.7	-69.5	-70.7		0.2	-56.0	-21	34.72
HT/VHT20, M0 to M7	4	9	-69.7	-69.5	-70.7	-70.7	0.2	-54.9	-21	33.65
HT/VHT20, M8 to M15	4	9	-69.7	-69.5	-70.7	-70.7	0.2	-54.9	-21	33.65

HT/VHT20, M16 to M23	4	9	-69.7	-69.5	-70.7	-70.7	0.2	-54.9	-21	33.65
HT/VHT20, M24 to M31	4	9	-69.7	-69.5	-70.7	-70.7	0.2	-54.9	-21	33.65
HT/VHT20 Beam Forming, M0 to M7	2	12	-69.7	-69.5			0.2	-54.4	-21	33.14
HT/VHT20 Beam Forming, M8 to M15	2	9	-69.9	-69.2			0.2	-57.3	-21	36.08
HT/VHT20 Beam Forming, M0 to M7	3	14	-69.3	-69.5	-70.7		0.2	-50.8	-21	29.57
HT/VHT20 Beam Forming, M8 to M15	3	11	-69.7	-69.5	-70.7		0.2	-54.0	-21	32.72
HT/VHT20 Beam Forming, M16 to M23	3	9	-69.7	-69.5	-70.7		0.2	-56.0	-21	34.72
HT/VHT20 Beam Forming, M0 to M7	4	15	-70.3	-69.7	-69.3	-69.7	0.2	-48.5	-21	27.27
HT/VHT20 Beam Forming, M8 to M15	4	12	-69.3	-69.5	-70.7	-69.6	0.2	-51.5	-21	30.27
HT/VHT20 Beam Forming, M16 to M23	4	10	-69.4	-68.1	-70.5	-70.0	0.2	-53.2	-21	31.94
HT/VHT20 Beam Forming, M24 to M31	4	9	-69.7	-69.5	-70.7	-70.7	0.2	-54.9	-21	33.65
HT/VHT20 STBC, M0 to M7	2	9	-69.9	-69.2			0.2	-57.3	-21	36.08
HT/VHT20 STBC, M0 to M7	3	9	-69.7	-69.5	-70.7		0.2	-56.0	-21	34.72
HT/VHT20 STBC, M0 to M7	4	9	-69.7	-69.5	-70.7	-70.7	0.2	-54.9	-21	33.65
HE20, M0 to M9 1ss	1	9	-69.8				0.2	-60.6	-21	39.35
HE20, M0 to M9 1ss	2	9	-69.6	-69.1			0.26	-57.1	-21	35.82
HE20, M0 to M9 2ss	2	9	-69.6	-69.1			0.26	-57.1	-21	35.82
HE20, M0 to M9 1ss	3	9	-69.6	-69.1	-70.2		0.26	-55.6	-21	34.33
HE20, M0 to M9 2ss	3	9	-69.6	-69.1	-70.2		0.26	-55.6	-21	34.33
HE20, M0 to M9 3ss	3	9	-69.6	-69.1	-70.2		0.26	-55.6	-21	34.33
HE20, M0 to M9 1ss	4	9	-70.7	-69.7	-69.9	-69.8	0.26	-54.7	-21	33.47
HE20, M0 to M9 2ss	4	9	-70.7	-69.7	-69.9	-69.8	0.26	-54.7	-21	33.47
HE20, M0 to M9 3ss	4	9	-70.7	-69.7	-69.9	-69.8	0.26	-54.7	-21	33.47
HE20, M0 to M9 4ss	4	9	-70.7	-69.7	-69.9	-69.8	0.26	-54.7	-21	33.47
HE20 Beam Forming, M0 to M9 1ss	2	12	-70.7	-69.7			0.26	-54.9	-21	33.65
HE20 Beam Forming, M0 to M9 2ss	2	9	-69.6	-69.1			0.26	-57.1	-21	35.82
HE20 Beam Forming, M0 to M9 1ss	3	14	-69.6	-68.3	-68.8		0.26	-49.8	-21	28.58
HE20 Beam Forming, M0 to M9 2ss	3	11	-70.7	-69.7	-69.9		0.26	-54.0	-21	32.8
HE20 Beam Forming, M0 to M9 3ss	3	9	-69.6	-69.1	-70.2		0.26	-55.6	-21	34.33

HE20 Beam Forming, M0 to M9 1ss	4	15	-71.1	-69.1	-70.8	-69.6	0.26	-48.8	-21	27.54
HE20 Beam Forming, M0 to M9 2ss	4	12	-69.6	-68.3	-68.8	-69.1	0.26	-50.6	-21	29.39
HE20 Beam Forming, M0 to M9 3ss	4	10	-70.7	-69.7	-69.9	-69.8	0.26	-53.7	-21	32.47
HE20 Beam Forming, M0 to M9 4ss	4	9	-70.7	-69.7	-69.9	-69.8	0.26	-54.7	-21	33.47
HE20 STBC, M0 to M9 2ss	2	9	-69.6	-69.1			0.26	-57.1	-21	35.82
HE20 STBC, M0 to M9 2ss	3	9	-69.6	-69.1	-70.2		0.26	-55.6	-21	34.33
HE20 STBC, M0 to M9 2ss	4	9	-70.7	-69.7	-69.9	-69.8	0.26	-54.7	-21	33.47

### Frequency 2437 MHz

Mode	Tx Paths	Correlated Antenna Gain (dBi)	Tx 1 Spur Power (dBm)	Tx 2 Spur Power (dBm)	Tx 3 Spur Power (dBm)	Tx 4 Spur Power (dBm)	Duty Cycle (dB)	Total Conducted Spur (dBm)	Limit (dB)	Margin (dB)
CCK, 1 to 11 Mbps	1	9	-69.0				1.41	-58.6	-21	37.34
CCK, 1 to 11 Mbps	2	9	-68.7	-68.9			1.41	-55.4	-21	34.13
CCK, 1 to 11 Mbps	3	9	-69.5	-69.3	-70.7		1.41	-54.6	-21	33.36
CCK, 1 to 11 Mbps	4	9	-70.1	-69.3	-69.2	-68.5	1.41	-52.8	-21	31.56
Non HT20, 6 to 54 Mbps	1	9	-67.9				0.37	-58.5	-21	37.28
Non HT20, 6 to 54 Mbps	2	9	-67.9	-69.7			0.37	-56.3	-21	35.08
Non HT20, 6 to 54 Mbps	3	9	-70.5	-68.3	-69.3		0.37	-55.1	-21	33.89
Non HT20, 6 to 54 Mbps	4	9	-67.7	-68.7	-70.3	-70.1	0.37	-53.7	-21	32.43
Non HT20 Beam Forming, 6 to 54 Mbps	2	12	-67.7	-68.7			0.37	-52.8	-21	31.55
Non HT20 Beam Forming, 6 to 54 Mbps	3	14	-70.4	-70.1	-68.9		0.37	-50.6	-21	29.36

<b>Non HT20 Beam Forming, 6 to 54 Mbps</b>	<b>4</b>	<b>15</b>	<b>-69.5</b>	<b>-69.6</b>	<b>-70.1</b>	<b>-69.0</b>	<b>0.37</b>	<b>-48.1</b>	<b>-21</b>	<b>26.9</b>
HT/VHT20, M0 to M7	1	9	-69.4				0.2	-60.2	-21	38.95
HT/VHT20, M0 to M7	2	9	-69.4	-69.7			0.2	-57.3	-21	36.09
HT/VHT20, M8 to M15	2	9	-69.4	-69.7			0.2	-57.3	-21	36.09
HT/VHT20, M0 to M7	3	9	-68.5	-69.5	-70.2		0.2	-55.4	-21	34.13
HT/VHT20, M8 to M15	3	9	-70.3	-69.5	-69.8		0.2	-55.9	-21	34.64
HT/VHT20, M16 to M23	3	9	-70.3	-69.5	-69.8		0.2	-55.9	-21	34.64
HT/VHT20, M0 to M7	4	9	-70.3	-70.0	-69.4	-70.4	0.2	-54.8	-21	33.54
HT/VHT20, M8 to M15	4	9	-69.6	-69.9	-70.3	-69.8	0.2	-54.7	-21	33.42
HT/VHT20, M16 to M23	4	9	-69.6	-69.9	-70.3	-69.8	0.2	-54.7	-21	33.42
HT/VHT20, M24 to M31	4	9	-69.6	-69.9	-70.3	-69.8	0.2	-54.7	-21	33.42
HT/VHT20 Beam Forming, M0 to M7	2	12	-69.6	-69.9			0.2	-54.5	-21	33.29
HT/VHT20 Beam Forming, M8 to M15	2	9	-69.4	-69.7			0.2	-57.3	-21	36.09
HT/VHT20 Beam Forming, M0 to M7	3	14	-69.6	-70.0	-69.5		0.2	-50.7	-21	29.48
HT/VHT20 Beam Forming, M8 to M15	3	11	-69.6	-69.9	-70.3		0.2	-54.0	-21	32.71
HT/VHT20 Beam Forming, M16 to M23	3	9	-70.3	-69.5	-69.8		0.2	-55.9	-21	34.64
HT/VHT20 Beam Forming, M0 to M7	4	15	-70.8	-69.5	-69.7	-70.3	0.2	-48.8	-21	27.58
HT/VHT20 Beam Forming, M8 to M15	4	12	-69.3	-70.3	-69.5	-70.5	0.2	-51.7	-21	30.4
HT/VHT20 Beam Forming, M16 to M23	4	10	-68.5	-70.1	-70.4	-68.6	0.2	-53.1	-21	31.85
HT/VHT20 Beam Forming, M24 to M31	4	9	-69.6	-69.9	-70.3	-69.8	0.2	-54.7	-21	33.42
HT/VHT20 STBC, M0 to M7	2	9	-69.4	-69.7			0.2	-57.3	-21	36.09
HT/VHT20 STBC, M0 to M7	3	9	-70.3	-69.5	-69.8		0.2	-55.9	-21	34.64
HT/VHT20 STBC, M0 to M7	4	9	-69.6	-69.9	-70.3	-69.8	0.2	-54.7	-21	33.42
HE20, M0 to M9 1ss	1	9	-69.8				0.26	-60.5	-21	39.29
HE20, M0 to M9 1ss	2	9	-69.8	-69.6			0.26	-57.4	-21	36.18
HE20, M0 to M9 2ss	2	9	-69.8	-69.6			0.26	-57.4	-21	36.18
HE20, M0 to M9 1ss	3	9	-69.5	-69.8	-70.4		0.26	-55.9	-21	34.6
HE20, M0 to M9 2ss	3	9	-70.2	-69.4	-69.4		0.26	-55.6	-21	34.37
HE20, M0 to M9 3ss	3	9	-70.2	-69.4	-69.4		0.26	-55.6	-21	34.37
HE20, M0 to M9 1ss	4	9	-69.6	-70.1	-70.2	-69.5	0.26	-54.6	-21	33.31
HE20, M0 to M9 2ss	4	9	-69.5	-69.8	-70.4	-70.0	0.26	-54.6	-21	33.38
HE20, M0 to M9 3ss	4	9	-69.5	-69.8	-70.4	-70.0	0.26	-54.6	-21	33.38

HE20, M0 to M9 4ss	4	9	-69.5	-69.8	-70.4	-70.0	0.26	-54.6	-21	33.38
HE20 Beam Forming, M0 to M9 1ss	2	12	-69.5	-69.8			0.26	-54.4	-21	33.12
HE20 Beam Forming, M0 to M9 2ss	2	9	-69.8	-69.6			0.26	-57.4	-21	36.18
HE20 Beam Forming, M0 to M9 1ss	3	14	-69.5	-69.5	-69.3		0.26	-50.4	-21	29.15
HE20 Beam Forming, M0 to M9 2ss	3	11	-69.6	-70.1	-70.2		0.26	-53.9	-21	32.67
HE20 Beam Forming, M0 to M9 3ss	3	9	-70.2	-69.4	-69.4		0.26	-55.6	-21	34.37
<b>HE20 Beam Forming, M0 to M9 1ss</b>	<b>4</b>	<b>15</b>	<b>-68.9</b>	<b>-69.7</b>	<b>-69.6</b>	<b>-69.9</b>	<b>0.26</b>	<b>-48.2</b>	<b>-21</b>	<b>26.97</b>
HE20 Beam Forming, M0 to M9 2ss	4	12	-70.0	-70.0	-69.9	-69.7	0.26	-51.6	-21	30.36
HE20 Beam Forming, M0 to M9 3ss	4	10	-69.6	-70.1	-70.2	-69.5	0.26	-53.6	-21	32.31
HE20 Beam Forming, M0 to M9 4ss	4	9	-69.5	-69.8	-70.4	-70.0	0.26	-54.6	-21	33.38
HE20 STBC, M0 to M9 2ss	2	9	-69.8	-69.6			0.26	-57.4	-21	36.18
HE20 STBC, M0 to M9 2ss	3	9	-70.2	-69.4	-69.4		0.26	-55.6	-21	34.37
HE20 STBC, M0 to M9 2ss	4	9	-69.5	-69.8	-70.4	-70.0	0.26	-54.6	-21	33.38

#### Frequency 2462 MHz

Mode	Tx Paths	Correlated Antenna Gain (dBi)	Tx 1 Spur Power (dBm)	Tx 2 Spur Power (dBm)	Tx 3 Spur Power (dBm)	Tx 4 Spur Power (dBm)	Duty Cycle (dB)	Total Conducted Spur (dBm)	Limit (dB)	Margin (dB)
CCK, 1 to 11 Mbps	1	9	-69.5				1.41	-59.1	-21	37.84
CCK, 1 to 11 Mbps	2	9	-69.4	-68.0			1.41	-55.2	-21	33.97
CCK, 1 to 11 Mbps	3	9	-69.7	-70.0	-69.3		1.41	-54.5	-21	33.23
CCK, 1 to 11 Mbps	4	9	-70.6	-69.8	-70.1	-69.3	1.41	-53.5	-21	32.24

Non HT20, 6 to 54 Mbps	1	9	-70.3				0.37	-60.9	-21	39.68
Non HT20, 6 to 54 Mbps	2	9	-70.3	-69.5			0.37	-57.5	-21	36.26
Non HT20, 6 to 54 Mbps	3	9	-71.0	-70.3	-69.1		0.37	-55.9	-21	34.67
Non HT20, 6 to 54 Mbps	4	9	-69.3	-70.0	-69.8	-68.7	0.37	-54.0	-21	32.78
Non HT20 Beam Forming, 6 to 54 Mbps	2	12	-69.3	-70.0			0.37	-54.3	-21	33.01
Non HT20 Beam Forming, 6 to 54 Mbps	3	14	-69.8	-70.0	-69.6		0.37	-50.7	-21	29.41
<b>Non HT20 Beam Forming, 6 to 54 Mbps</b>	<b>4</b>	<b>15</b>	<b>-68.8</b>	<b>-69.9</b>	<b>-70.5</b>	<b>-69.5</b>	<b>0.37</b>	<b>-48.2</b>	<b>-21</b>	<b>26.99</b>
HT/VHT20, M0 to M7	1	9	-71.2				0.2	-62.0	-21	40.75
HT/VHT20, M0 to M7	2	9	-69.5	-69.7			0.2	-57.4	-21	36.14
HT/VHT20, M8 to M15	2	9	-69.5	-69.7			0.2	-57.4	-21	36.14
HT/VHT20, M0 to M7	3	9	-69.6	-69.4	-70.7		0.2	-55.9	-21	34.65
HT/VHT20, M8 to M15	3	9	-69.6	-69.4	-70.7		0.2	-55.9	-21	34.65
HT/VHT20, M16 to M23	3	9	-69.6	-69.4	-70.7		0.2	-55.9	-21	34.65
HT/VHT20, M0 to M7	4	9	-70.6	-69.5	-69.7	-69.8	0.2	-54.7	-21	33.41
HT/VHT20, M8 to M15	4	9	-70.6	-69.5	-69.7	-69.8	0.2	-54.7	-21	33.41
HT/VHT20, M16 to M23	4	9	-70.6	-69.5	-69.7	-69.8	0.2	-54.7	-21	33.41
HT/VHT20, M24 to M31	4	9	-70.6	-69.5	-69.7	-69.8	0.2	-54.7	-21	33.41
HT/VHT20 Beam Forming, M0 to M7	2	12	-70.6	-69.5			0.2	-54.8	-21	33.56
HT/VHT20 Beam Forming, M8 to M15	2	9	-69.5	-69.7			0.2	-57.4	-21	36.14
HT/VHT20 Beam Forming, M0 to M7	3	14	-70.2	-68.8	-70.2		0.2	-50.7	-21	29.46
HT/VHT20 Beam Forming, M8 to M15	3	11	-70.6	-69.5	-69.7		0.2	-53.9	-21	32.69
HT/VHT20 Beam Forming, M16 to M23	3	9	-69.6	-69.4	-70.7		0.2	-55.9	-21	34.65
HT/VHT20 Beam Forming, M0 to M7	4	15	-70.8	-70.1	-70.5	-69.3	0.2	-48.9	-21	27.67
HT/VHT20 Beam Forming, M8 to M15	4	12	-70.2	-68.8	-70.2	-70.1	0.2	-51.6	-21	30.31
HT/VHT20 Beam Forming, M16 to M23	4	10	-69.3	-69.5	-69.7	-69.7	0.2	-53.3	-21	32.08
HT/VHT20 Beam Forming, M24 to M31	4	9	-70.6	-69.5	-69.7	-69.8	0.2	-54.7	-21	33.41
HT/VHT20 STBC, M0 to M7	2	9	-69.5	-69.7			0.2	-57.4	-21	36.14



HT/VHT20 STBC, M0 to M7	3	9	-69.6	-69.4	-70.7		0.2	-55.9	-21	34.65
HT/VHT20 STBC, M0 to M7	4	9	-70.6	-69.5	-69.7	-69.8	0.2	-54.7	-21	33.41
HE20, M0 to M9 1ss	1	9	-70.4				0.26	-61.1	-21	39.89
HE20, M0 to M9 1ss	2	9	-70.0	-68.6			0.26	-57.0	-21	35.72
HE20, M0 to M9 2ss	2	9	-70.0	-68.6			0.26	-57.0	-21	35.72
HE20, M0 to M9 1ss	3	9	-69.6	-70.2	-69.8		0.26	-55.8	-21	34.58
HE20, M0 to M9 2ss	3	9	-69.6	-70.2	-69.8		0.26	-55.8	-21	34.58
HE20, M0 to M9 3ss	3	9	-69.6	-70.2	-69.8		0.26	-55.8	-21	34.58
HE20, M0 to M9 1ss	4	9	-70.2	-69.8	-69.4	-70.3	0.26	-54.6	-21	33.38
HE20, M0 to M9 2ss	4	9	-70.2	-69.8	-69.4	-70.3	0.26	-54.6	-21	33.38
HE20, M0 to M9 3ss	4	9	-70.2	-69.8	-69.4	-70.3	0.26	-54.6	-21	33.38
HE20, M0 to M9 4ss	4	9	-70.2	-69.8	-69.4	-70.3	0.26	-54.6	-21	33.38
HE20 Beam Forming, M0 to M9 1ss	2	12	-70.2	-69.8			0.26	-54.7	-21	33.47
HE20 Beam Forming, M0 to M9 2ss	2	9	-70.0	-68.6			0.26	-57.0	-21	35.72
HE20 Beam Forming, M0 to M9 1ss	3	14	-69.0	-68.7	-70.1		0.26	-50.2	-21	28.94
HE20 Beam Forming, M0 to M9 2ss	3	11	-70.2	-69.8	-69.4		0.26	-53.8	-21	32.5
HE20 Beam Forming, M0 to M9 3ss	3	9	-69.6	-70.2	-69.8		0.26	-55.8	-21	34.58
HE20 Beam Forming, M0 to M9 1ss	4	15	-69.4	-69.9	-69.9	-69.6	0.26	-48.4	-21	27.16
HE20 Beam Forming, M0 to M9 2ss	4	12	-69.0	-68.7	-70.1	-70.2	0.26	-51.2	-21	29.92
HE20 Beam Forming, M0 to M9 3ss	4	10	-70.2	-69.8	-69.4	-70.3	0.26	-53.6	-21	32.38
HE20 Beam Forming, M0 to M9 4ss	4	9	-70.2	-69.8	-69.4	-70.3	0.26	-54.6	-21	33.38
HE20 STBC, M0 to M9 2ss	2	9	-70.0	-68.6			0.26	-57.0	-21	35.72
HE20 STBC, M0 to M9 2ss	3	9	-69.6	-70.2	-69.8		0.26	-55.8	-21	34.58
HE20 STBC, M0 to M9 2ss	4	9	-70.2	-69.8	-69.4	-70.3	0.26	-54.6	-21	33.38

## Data Screenshots

2437 MHz: Non HT20 Beam Forming, 6 to 54 Mbps

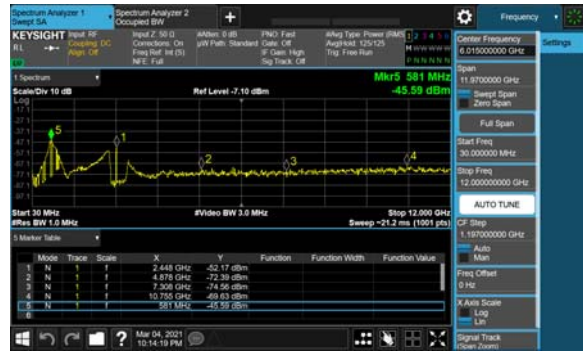
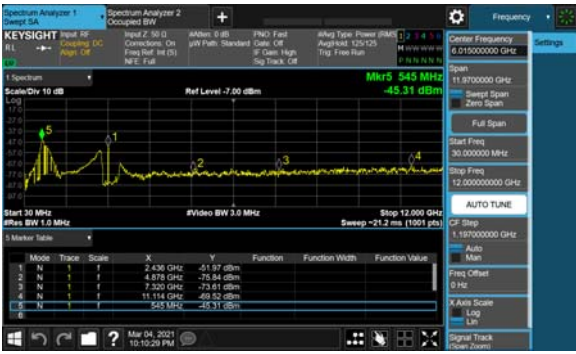

2437 MHz: HE20 Beam Forming, M0 to M9 Iss



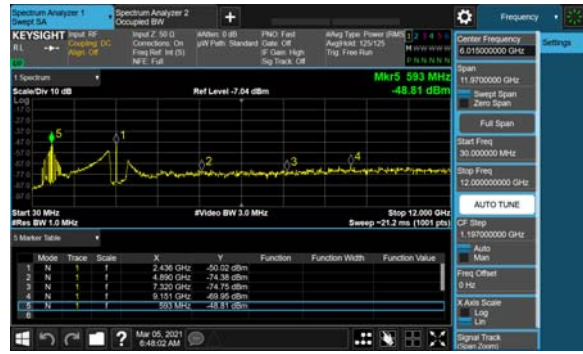

2462 MHz: Non HT20 Beam Forming, 6 to 54 Mbps

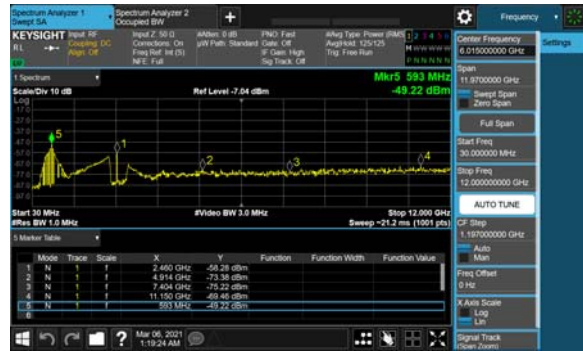
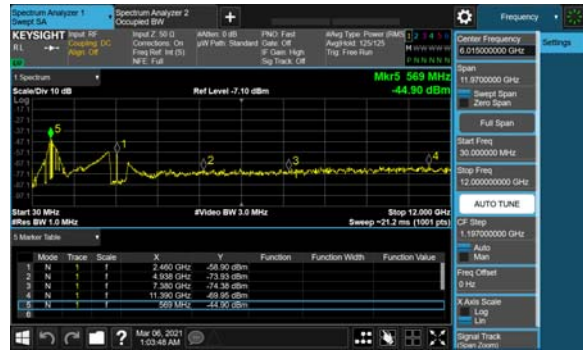
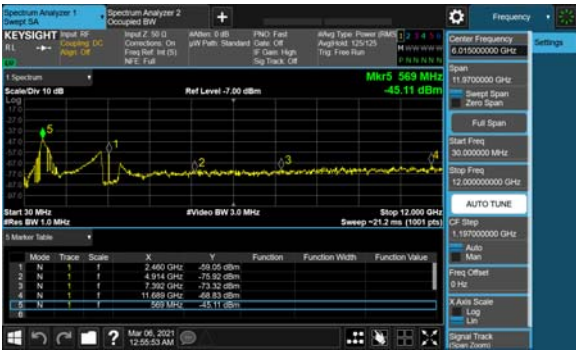

## A.7 Conducted Bandedge (Restricted Band)

### Conducted Band Edge Test Requirement

#### 15.247

(d) In any 100 kHz bandwidth outside the frequency band in which the spread spectrum or digitally modulated intentional radiator is operating, the radio frequency power that is produced by the intentional radiator shall be at least 20 dB below that in the 100 kHz bandwidth within the band that contains the highest level of the desired power, based on either an RF conducted or a radiated measurement, provided the transmitter demonstrates compliance with the peak conducted power limits. If the transmitter complies with the conducted power limits based on the use of RMS averaging over a time interval, as permitted under paragraph (b)(3) of this section, the attenuation required under this paragraph shall be 30 dB instead of 20 dB. Attenuation below the general limits specified in §15.209(a) is not required. In addition, radiated emissions which fall in the restricted bands, as defined in §15.205(a), must also comply with the radiated emission limits specified in §15.209(a) (see §15.205(c)).

#### RSS-247

##### 5.5 Unwanted emissions

In any 100 kHz bandwidth outside the frequency band in which the spread spectrum or digitally modulated device is operating, the RF power that is produced shall be at least 20 dB below that in the 100 kHz bandwidth within the band that contains the highest level of the desired power, based on either an RF conducted or a radiated measurement, provided that the transmitter demonstrates compliance with the peak conducted power limits. If the transmitter complies with the conducted power limits based on the use of root-mean-square averaging over a time interval, as permitted under section 5.4(d), the attenuation required shall be 30 dB instead of 20 dB. Attenuation below the general field strength limits specified in RSS-Gen is not required.

#### 15.205 / RSS-Gen

Radiated emissions which fall in the restricted bands, as defined in Section 15.205(a), and RSS-Gen 8.10 must also comply with the radiated emission limits specified in Section 15.209(a) (see Section 15.205(c)) and RSS-Gen 8.9.

### Conducted Bandedge Test Method

Ref. KDB 558074 D01 DTS Meas Guidance v05r02

ANSI C63.10: 2013

<b>Conducted Band edge</b> Test Procedure
<ol style="list-style-type: none"><li>1. Connect the antenna port(s) to the spectrum analyzer input.</li><li>2. Place the radio in continuous transmit mode. Use the procedures in KDB 558074 D01 DTS Meas Guidance v04 to substitute conducted measurements in place of radiated measurements.</li><li>3. Configure Spectrum analyzer as per test parameters below (be sure to enter all losses between the transmitter output and the spectrum analyzer).</li><li>4. Place a marker at the end of the restricted band closest to the transmit frequency to show compliance. Also measure any emissions in the restricted bands.</li><li>5. The “measure-and-sum technique” is used for measuring in-band transmit power of a device. In the measure-and-sum approach, the conducted emission level is measured at each antenna port. The measured results at the various antenna ports are then summed mathematically to determine the total emission level from the device. Summing is performed in linear power units. The worst case output is recorded.</li><li>6. Place a marker at the end of the restricted band closest to the transmit frequency to show compliance. Also measure any emissions in the restricted bands</li><li>7. Capture graphs and record pertinent measurement data.</li></ol>

Ref. KDB 558074 D01 DTS Meas Guidance v05r02, section 8.1 c) 3, section 8.6 DTS emissions in restricted frequency bands  
 ANSI C63.10: 2013 section 11.12.2.4 (Peak) & 11.12.2.5.2 (Average)

<b>Conducted Spurious Emissions</b>	
Test parameters	
<b>Peak</b> RBW = 1 MHz VBW $\geq$ 3 MHz Sweep = Auto Detector = Peak Trace = Max Hold.	<b>Average</b> RBW = 1 MHz VBW $\geq$ 3 MHz Sweep = Auto Detector = RMS Power Averaging

<b>Tested By :</b> Said Abdelwafi, Julian Land	<b>Date of testing:</b> 02-MAR-2021 through 25-MAR-2021
<b>Test Result : PASS</b>	

**Test Equipment**

See Appendix C for list of test equipment

# Restricted Band

## Conducted Bandedge Average Table

Frequency 2412 MHz

Mode	Tx Paths	Correlated Antenna Gain (dBi)	Tx 1 Bandedge Level (dBm)	Tx 2 Bandedge Level (dBm)	Tx 3 Bandedge Level (dBm)	Tx 4 Bandedge Level (dBm)	Duty Cycle (dB)	Total Tx Bandedge Level (dBm)	Limit (dB)	Margin (dB)
CCK, 1 to 11 Mbps	1	9	-57.6				1.41	-47.2	-41	5.94
CCK, 1 to 11 Mbps	2	9	-59.4	-60.9			1.41	-46.7	-41	5.42
CCK, 1 to 11 Mbps	3	9	-62.8	-62.9	-64.6		1.41	-48.2	-41	6.93
CCK, 1 to 11 Mbps	4	9	-63.6	-64.5	-65.7	-66.3	1.41	-48.5	-41	7.22
Non HT20, 6 to 54 Mbps	1	9	-51.1				0.37	-41.7	-41	0.48
Non HT20, 6 to 54 Mbps	2	9	-56.0	-62.2			0.37	-45.7	-41	4.45
Non HT20, 6 to 54 Mbps	3	9	-56.0	-62.2	-60.3		0.37	-44.6	-41	3.31
Non HT20, 6 to 54 Mbps	4	9	-56.0	-62.2	-60.3	-56.8	0.37	-42.8	-41	1.5
Non HT20 Beam Forming, 6 to 54 Mbps	2	12	-56.0	-62.2			0.37	-42.7	-41	1.45
Non HT20 Beam Forming, 6 to 54 Mbps	3	14	-58.6	-62.8	-61.0		0.37	-41.3	-41	0.07
<b>Non HT20 Beam Forming, 6 to 54 Mbps</b>	<b>4</b>	<b>15</b>	<b>-61.3</b>	<b>-64.7</b>	<b>-63.0</b>	<b>-62.3</b>	<b>0.37</b>	<b>-41.3</b>	<b>-41</b>	<b>0.02</b>
HT/VHT20, M0 to M7	1	9	-50.7				0.2	-41.5	-41	0.25
HT/VHT20, M0 to M7	2	9	-52.2	-57.2			0.2	-41.8	-41	0.56
HT/VHT20, M8 to M15	2	9	-52.2	-57.2			0.2	-41.8	-41	0.56
HT/VHT20, M0 to M7	3	9	-55.7	-62.8	-58.1		0.2	-44.0	-41	2.77
HT/VHT20, M8 to M15	3	9	-55.7	-62.8	-58.1		0.2	-44.0	-41	2.77
HT/VHT20, M16 to M23	3	9	-55.7	-62.8	-58.1		0.2	-44.0	-41	2.77
HT/VHT20, M0 to M7	4	9	-55.7	-62.8	-58.1	-56.0	0.2	-42.2	-41	0.93

HT/VHT20, M8 to M15	4	9	-55.7	-62.8	-58.1	-56.0	0.2	-42.2	-41	0.93
HT/VHT20, M16 to M23	4	9	-55.7	-62.8	-58.1	-56.0	0.2	-42.2	-41	0.93
HT/VHT20, M24 to M31	4	9	-55.7	-62.8	-58.1	-56.0	0.2	-42.2	-41	0.93
HT/VHT20 Beam Forming, M0 to M7	2	12	-55.7	-62.8			0.2	-42.7	-41	1.48
HT/VHT20 Beam Forming, M8 to M15	2	9	-52.2	-57.2			0.2	-41.8	-41	0.56
HT/VHT20 Beam Forming, M0 to M7	3	14	-58.1	-63.7	-61.2		0.2	-41.4	-41	0.18
HT/VHT20 Beam Forming, M8 to M15	3	11	-55.7	-62.8	-58.1		0.2	-42.0	-41	0.77
HT/VHT20 Beam Forming, M16 to M23	3	9	-55.7	-62.8	-58.1		0.2	-44.0	-41	2.77
HT/VHT20 Beam Forming, M0 to M7	4	15	-62.4	-64.2	-64.0	-63.1	0.2	-42.1	-41	0.9
HT/VHT20 Beam Forming, M8 to M15	4	12	-58.1	-63.7	-61.2	-59.8	0.2	-42.0	-41	0.78
HT/VHT20 Beam Forming, M16 to M23	4	10	-57.4	-63.0	-59.7	-58.9	0.2	-43.1	-41	1.85
HT/VHT20 Beam Forming, M24 to M31	4	9	-55.7	-62.8	-58.1	-56.0	0.2	-42.2	-41	0.93
HT/VHT20 STBC, M0 to M7	2	9	-52.2	-57.2			0.2	-41.8	-41	0.56
HT/VHT20 STBC, M0 to M7	3	9	-55.7	-62.8	-58.1		0.2	-44.0	-41	2.77
HT/VHT20 STBC, M0 to M7	4	9	-55.7	-62.8	-58.1	-56.0	0.2	-42.2	-41	0.93
HE20, M0 to M9 1ss	1	9	-50.5				0.2	-41.3	-41	0.05
HE20, M0 to M9 1ss	2	9	-54.0	-60.9			0.26	-43.9	-41	2.68
HE20, M0 to M9 2ss	2	9	-54.0	-60.9			0.26	-43.9	-41	2.68
HE20, M0 to M9 1ss	3	9	-54.0	-60.9	-56.6		0.26	-42.3	-41	1.05
HE20, M0 to M9 2ss	3	9	-54.0	-60.9	-56.6		0.26	-42.3	-41	1.05
HE20, M0 to M9 3ss	3	9	-54.0	-60.9	-56.6		0.26	-42.3	-41	1.05
HE20, M0 to M9 1ss	4	9	-55.8	-62.7	-59.1	-56.5	0.26	-42.5	-41	1.27
HE20, M0 to M9 2ss	4	9	-55.8	-62.7	-59.1	-56.5	0.26	-42.5	-41	1.27
HE20, M0 to M9 3ss	4	9	-55.8	-62.7	-59.1	-56.5	0.26	-42.5	-41	1.27
HE20, M0 to M9 4ss	4	9	-55.8	-62.7	-59.1	-56.5	0.26	-42.5	-41	1.27
HE20 Beam Forming, M0 to M9 1ss	2	12	-55.8	-62.7			0.26	-42.7	-41	1.48
HE20 Beam Forming, M0 to M9 2ss	2	9	-54.0	-60.9			0.26	-43.9	-41	2.68
HE20 Beam Forming, M0 to M9 1ss	3	14	-59.3	-63.7	-61.0		0.26	-41.9	-41	0.69
HE20 Beam Forming, M0 to M9 2ss	3	11	-55.8	-62.7	-59.1		0.26	-42.3	-41	1.06

HE20 Beam Forming, M0 to M9 3ss	3	9	-54.0	-60.9	-56.6		0.26	-42.3	-41	1.05
HE20 Beam Forming, M0 to M9 1ss	4	15	-63.6	-66.4	-63.2	-62.6	0.26	-42.4	-41	1.2
HE20 Beam Forming, M0 to M9 2ss	4	12	-59.3	-63.7	-61.0	-60.1	0.26	-42.5	-41	1.21
HE20 Beam Forming, M0 to M9 3ss	4	10	-55.8	-62.7	-59.1	-56.5	0.26	-41.5	-41	0.27
HE20 Beam Forming, M0 to M9 4ss	4	9	-55.8	-62.7	-59.1	-56.5	0.26	-42.5	-41	1.27
HE20 STBC, M0 to M9 2ss	2	9	-54.0	-60.9			0.26	-43.9	-41	2.68
HE20 STBC, M0 to M9 2ss	3	9	-54.0	-60.9	-56.6		0.26	-42.3	-41	1.05
HE20 STBC, M0 to M9 2ss	4	9	-55.8	-62.7	-59.1	-56.5	0.26	-42.5	-41	1.27

### Frequency 2462 MHz

Mode	Tx Paths	Correlated Antenna Gain (dBi)	Tx 1 Bandedge Level (dBm)	Tx 2 Bandedge Level (dBm)	Tx 3 Bandedge Level (dBm)	Tx 4 Bandedge Level (dBm)	Duty Cycle (dB)	Total Tx Bandedge Level (dBm)	Limit (dB)	Margin (dB)
CCK, 1 to 11 Mbps	1	9	-53.1				1.41	-42.7	-41	1.44
CCK, 1 to 11 Mbps	2	9	-57.3	-57.9			1.41	-44.2	-41	2.92
CCK, 1 to 11 Mbps	3	9	-63.8	-63.0	-64.0		1.41	-48.4	-41	7.15
CCK, 1 to 11 Mbps	4	9	-66.2	-64.9	-65.5	-65.5	1.41	-49.1	-41	7.82
Non HT20, 6 to 54 Mbps	1	9	-51.7				0.37	-42.3	-41	1.08
Non HT20, 6 to 54 Mbps	2	9	-54.5	-55.2			0.37	-42.5	-41	1.21
Non HT20, 6 to 54 Mbps	3	9	-55.6	-56.3	-54.6		0.37	-41.3	-41	0.06
Non HT20, 6 to 54 Mbps	4	9	-58.0	-58.3	-57.3	-56.6	0.37	-42.1	-41	0.86
Non HT20 Beam Forming, 6 to 54 Mbps	2	12	-58.0	-58.3			0.37	-42.8	-41	1.52



Non HT20 Beam Forming, 6 to 54 Mbps	3	14	-60.9	-61.1	-61.3		0.37	-42.0	-41	0.71
Non HT20 Beam Forming, 6 to 54 Mbps	4	15	-63.9	-63.3	-63.7	-64.4	0.37	-42.4	-41	1.17
HT/VHT20, M0 to M7	1	9	-51.4				0.2	-42.2	-41	0.95
HT/VHT20, M0 to M7	2	9	-53.7	-54.3			0.2	-41.8	-41	0.53
HT/VHT20, M8 to M15	2	9	-53.7	-54.3			0.2	-41.8	-41	0.53
HT/VHT20, M0 to M7	3	9	-55.9	-56.5	-54.4		0.2	-41.5	-41	0.29
HT/VHT20, M8 to M15	3	9	-55.9	-56.5	-54.4		0.2	-41.5	-41	0.29
HT/VHT20, M16 to M23	3	9	-55.9	-56.5	-54.4		0.2	-41.5	-41	0.29
HT/VHT20, M0 to M7	4	9	-57.7	-57.9	-56.9	-56.9	0.2	-42.1	-41	0.86
HT/VHT20, M8 to M15	4	9	-57.7	-57.9	-56.9	-56.9	0.2	-42.1	-41	0.86
HT/VHT20, M16 to M23	4	9	-57.7	-57.9	-56.9	-56.9	0.2	-42.1	-41	0.86
HT/VHT20, M24 to M31	4	9	-57.7	-57.9	-56.9	-56.9	0.2	-42.1	-41	0.86
HT/VHT20 Beam Forming, M0 to M7	2	12	-57.7	-57.9			0.2	-42.6	-41	1.34
HT/VHT20 Beam Forming, M8 to M15	2	9	-53.7	-54.3			0.2	-41.8	-41	0.53
HT/VHT20 Beam Forming, M0 to M7	3	14	-60.6	-61.4	-60.2		0.2	-41.7	-41	0.49
HT/VHT20 Beam Forming, M8 to M15	3	11	-57.7	-57.9	-56.9		0.2	-41.5	-41	0.26
HT/VHT20 Beam Forming, M16 to M23	3	9	-55.9	-56.5	-54.4		0.2	-41.5	-41	0.29
<b>HT/VHT20 Beam Forming, M0 to M7</b>	<b>4</b>	<b>15</b>	<b>-62.6</b>	<b>-62.7</b>	<b>-61.8</b>	<b>-63.0</b>	<b>0.2</b>	<b>-41.3</b>	<b>-41</b>	<b>0.03</b>
HT/VHT20 Beam Forming, M8 to M15	4	12	-60.6	-61.4	-60.2	-60.4	0.2	-42.4	-41	1.16
HT/VHT20 Beam Forming, M16 to M23	4	10	-59.8	-59.1	-58.8	-59.4	0.2	-43.0	-41	1.79
HT/VHT20 Beam Forming, M24 to M31	4	9	-57.7	-57.9	-56.9	-56.9	0.2	-42.1	-41	0.86
HT/VHT20 STBC, M0 to M7	2	9	-53.7	-54.3			0.2	-41.8	-41	0.53
HT/VHT20 STBC, M0 to M7	3	9	-55.9	-56.5	-54.4		0.2	-41.5	-41	0.29
HT/VHT20 STBC, M0 to M7	4	9	-57.7	-57.9	-56.9	-56.9	0.2	-42.1	-41	0.86
HE20, M0 to M9 1ss	1	9	-50.8				0.26	-41.5	-41	0.29
HE20, M0 to M9 1ss	2	9	-53.9	-54.7			0.26	-42.0	-41	0.76
HE20, M0 to M9 2ss	2	9	-53.9	-54.7			0.26	-42.0	-41	0.76
HE20, M0 to M9 1ss	3	9	-55.8	-56.6	-54.8		0.26	-41.6	-41	0.39
HE20, M0 to M9 2ss	3	9	-55.8	-56.6	-54.8		0.26	-41.6	-41	0.39
HE20, M0 to M9 3ss	3	9	-55.8	-56.6	-54.8		0.26	-41.6	-41	0.39
HE20, M0 to M9 1ss	4	9	-58.0	-57.6	-57.3	-57.3	0.26	-42.3	-41	1.01

HE20, M0 to M9 2ss	4	9	-58.0	-57.6	-57.3	-57.3	0.26	-42.3	-41	1.01
HE20, M0 to M9 3ss	4	9	-58.0	-57.6	-57.3	-57.3	0.26	-42.3	-41	1.01
HE20, M0 to M9 4ss	4	9	-58.0	-57.6	-57.3	-57.3	0.26	-42.3	-41	1.01
HE20 Beam Forming, M0 to M9 1ss	2	12	-58.0	-57.6			0.26	-42.5	-41	1.27
HE20 Beam Forming, M0 to M9 2ss	2	9	-53.9	-54.7			0.26	-42.0	-41	0.76
HE20 Beam Forming, M0 to M9 1ss	3	14	-61.3	-60.9	-61.2		0.26	-42.1	-41	0.85
HE20 Beam Forming, M0 to M9 2ss	3	11	-58.0	-57.6	-57.3		0.26	-41.6	-41	0.34
HE20 Beam Forming, M0 to M9 3ss	3	9	-55.8	-56.6	-54.8		0.26	-41.6	-41	0.39
HE20 Beam Forming, M0 to M9 1ss	4	15	-62.5	-63.0	-63.0	-62.6	0.26	-41.5	-41	0.24
HE20 Beam Forming, M0 to M9 2ss	4	12	-61.3	-60.9	-61.2	-60.3	0.26	-42.6	-41	1.37
<b>HE20 Beam Forming, M0 to M9 3ss</b>	<b>4</b>	<b>10</b>	<b>-58.0</b>	<b>-57.6</b>	<b>-57.3</b>	<b>-57.3</b>	<b>0.26</b>	<b>-41.3</b>	<b>-41</b>	<b>0.01</b>
HE20 Beam Forming, M0 to M9 4ss	4	9	-58.0	-57.6	-57.3	-57.3	0.26	-42.3	-41	1.01
HE20 STBC, M0 to M9 2ss	2	9	-53.9	-54.7			0.26	-42.0	-41	0.76
HE20 STBC, M0 to M9 2ss	3	9	-55.8	-56.6	-54.8		0.26	-41.6	-41	0.39
HE20 STBC, M0 to M9 2ss	4	9	-58.0	-57.6	-57.3	-57.3	0.26	-42.3	-41	1.01

## Data Screenshots

2462 MHz: HE20 Beam Forming, M0 to M9 3ss



Antenna A



Antenna B



Antenna C



Antenna D

2412 MHz: Non HT20 Beam Forming, 6 to 54 Mbps

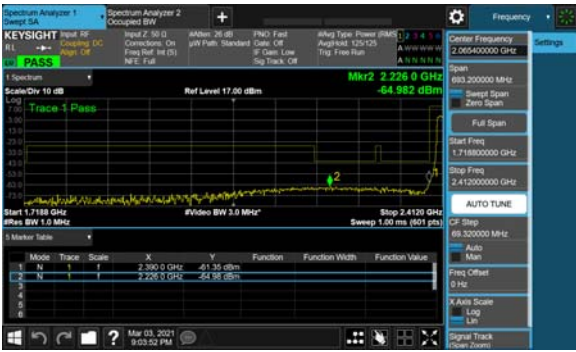

Antenna A

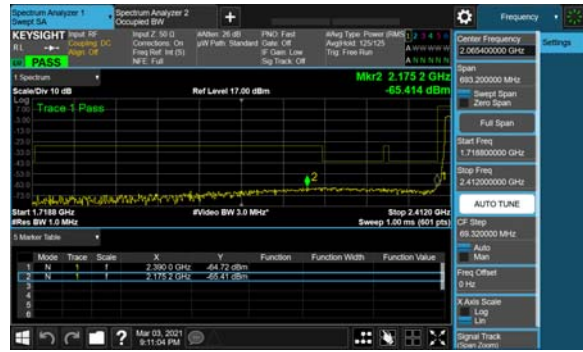

Antenna B

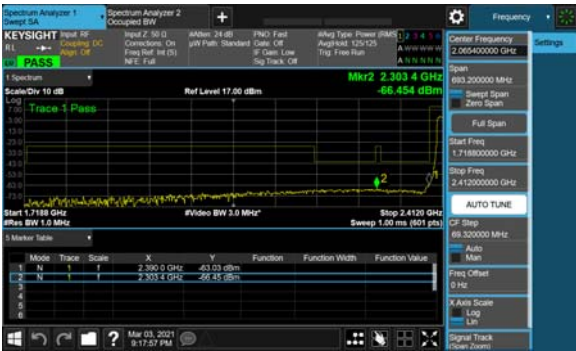

Antenna C



Antenna D

2462 MHz: HT/VHT20 Beam Forming, M0 to M7



Antenna A



Antenna B

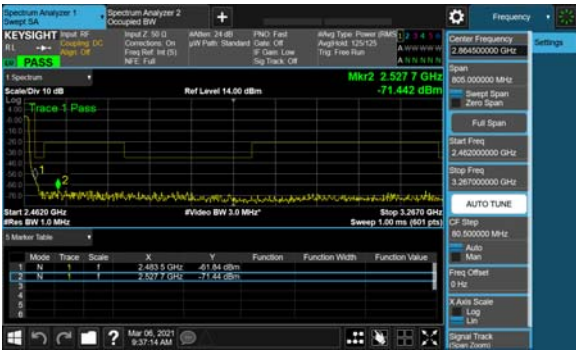

Antenna C

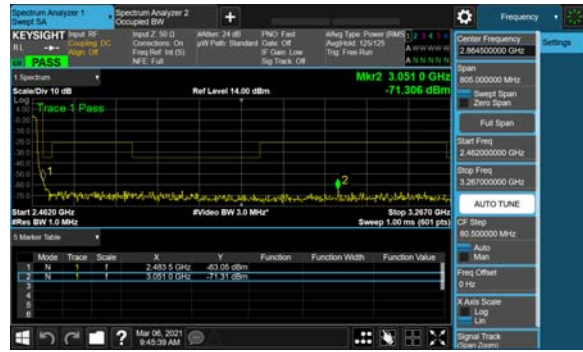

Antenna D

## Conducted Bandedge Peak Table

### Frequency 2412 MHz

Mode	Tx Paths	Correlated Antenna Gain (dBi)	Tx 1 Bandedge Level (dBm)	Tx 2 Bandedge Level (dBm)	Tx 3 Bandedge Level (dBm)	Tx 4 Bandedge Level (dBm)	Total Tx Bandedge Level (dBm)	Limit (dB)	Margin (dB)
CCK, 1 to 11 Mbps	1	9	-41.7				-31.3	-21	10.04
CCK, 1 to 11 Mbps	2	9	-46.3	-50.7			-34.5	-21	13.3
CCK, 1 to 11 Mbps	3	9	-48.7	-49.2	-50.6		-34.2	-21	13.0
CCK, 1 to 11 Mbps	4	9	-51.9	-49.1	-49.8	-49.7	-33.6	-21	12.33
Non HT20, 6 to 54 Mbps	1	9	-39.3				-29.9	-21	8.68
Non HT20, 6 to 54 Mbps	2	9	-43.0	-47.2			-32.2	-21	10.98
Non HT20, 6 to 54 Mbps	3	9	-43.0	-47.2	-45.9		-30.9	-21	9.61
Non HT20, 6 to 54 Mbps	4	9	-43.0	-47.2	-45.9	-45.6	-29.8	-21	8.51
Non HT20 Beam Forming, 6 to 54 Mbps	2	12	-43.0	-47.2			-29.2	-21	7.98
Non HT20 Beam Forming, 6 to 54 Mbps	3	14	-46.5	-49.8	-49.0		-29.1	-21	7.81
Non HT20 Beam Forming, 6 to 54 Mbps	4	15	-47.7	-49.4	-50.7	-50.0	-27.9	-21	6.67
HT/VHT20, M0 to M7	1	9	-38.5				-29.3	-21	8.05
HT/VHT20, M0 to M7	2	9	-41.9	-45.1			-31.0	-21	9.75
HT/VHT20, M8 to M15	2	9	-41.9	-45.1			-31.0	-21	9.75
HT/VHT20, M0 to M7	3	9	-45.1	-47.6	-45.6		-32.0	-21	10.75
HT/VHT20, M8 to M15	3	9	-45.1	-47.6	-45.6		-32.0	-21	10.75
HT/VHT20, M16 to M23	3	9	-45.1	-47.6	-45.6		-32.0	-21	10.75
HT/VHT20, M0 to M7	4	9	-45.1	-47.6	-45.6	-45.0	-30.5	-21	9.24
HT/VHT20, M8 to M15	4	9	-45.1	-47.6	-45.6	-45.0	-30.5	-21	9.24
HT/VHT20, M16 to M23	4	9	-45.1	-47.6	-45.6	-45.0	-30.5	-21	9.24
HT/VHT20, M24 to M31	4	9	-45.1	-47.6	-45.6	-45.0	-30.5	-21	9.24
HT/VHT20 Beam Forming, M0 to M7	2	12	-45.1	-47.6			-31.0	-21	9.71
HT/VHT20 Beam Forming, M8 to M15	2	9	-41.9	-45.1			-31.0	-21	9.75

HT/VHT20 Beam Forming, M0 to M7	3	14	-44.3	-49.6	-49.5		-28.1	-21	6.82
HT/VHT20 Beam Forming, M8 to M15	3	11	-45.1	-47.6	-45.6		-30.0	-21	8.75
HT/VHT20 Beam Forming, M16 to M23	3	9	-45.1	-47.6	-45.6		-32.0	-21	10.75
HT/VHT20 Beam Forming, M0 to M7	4	15	-51.3	-51.7	-50.9	-50.9	-30.0	-21	8.72
HT/VHT20 Beam Forming, M8 to M15	4	12	-44.3	-49.6	-49.5	-48.5	-29.1	-21	7.89
HT/VHT20 Beam Forming, M16 to M23	4	10	-45.4	-48.0	-47.5	-47.2	-30.7	-21	9.44
HT/VHT20 Beam Forming, M24 to M31	4	9	-45.1	-47.6	-45.6	-45.0	-30.5	-21	9.24
HT/VHT20 STBC, M0 to M7	2	9	-41.9	-45.1			-31.0	-21	9.75
HT/VHT20 STBC, M0 to M7	3	9	-45.1	-47.6	-45.6		-32.0	-21	10.75
HT/VHT20 STBC, M0 to M7	4	9	-45.1	-47.6	-45.6	-45.0	-30.5	-21	9.24
HE20, M0 to M9 1ss	1	9	-39.9				-30.7	-21	9.45
HE20, M0 to M9 1ss	2	9	-42.3	-43.6			-30.6	-21	9.38
HE20, M0 to M9 2ss	2	9	-42.3	-43.6			-30.6	-21	9.38
HE20, M0 to M9 1ss	3	9	-42.3	-43.6	-45.9		-29.7	-21	8.41
HE20, M0 to M9 2ss	3	9	-42.3	-43.6	-45.9		-29.7	-21	8.41
HE20, M0 to M9 3ss	3	9	-42.3	-43.6	-45.9		-29.7	-21	8.41
HE20, M0 to M9 1ss	4	9	-44.1	-47.5	-47.4	-43.3	-29.9	-21	8.64
HE20, M0 to M9 2ss	4	9	-44.1	-47.5	-47.4	-43.3	-29.9	-21	8.64
HE20, M0 to M9 3ss	4	9	-44.1	-47.5	-47.4	-43.3	-29.9	-21	8.64
HE20, M0 to M9 4ss	4	9	-44.1	-47.5	-47.4	-43.3	-29.9	-21	8.64
HE20 Beam Forming, M0 to M9 1ss	2	12	-44.1	-47.5			-30.2	-21	8.95
HE20 Beam Forming, M0 to M9 2ss	2	9	-42.3	-43.6			-30.6	-21	9.38
HE20 Beam Forming, M0 to M9 1ss	3	14	-49.0	-49.6	-48.9		-30.1	-21	8.87
HE20 Beam Forming, M0 to M9 2ss	3	11	-44.1	-47.5	-47.4		-30.0	-21	8.74
HE20 Beam Forming, M0 to M9 3ss	3	9	-42.3	-43.6	-45.9		-29.7	-21	8.41
HE20 Beam Forming, M0 to M9 1ss	4	15	-52.9	-48.2	-51.5	-52.6	-29.6	-21	8.32
HE20 Beam Forming, M0 to M9 2ss	4	12	-49.0	-49.6	-48.9	-48.2	-30.6	-21	9.36
HE20 Beam Forming, M0 to M9 3ss	4	10	-44.1	-47.5	-47.4	-43.3	-28.9	-21	7.64
HE20 Beam Forming, M0 to M9 4ss	4	9	-44.1	-47.5	-47.4	-43.3	-29.9	-21	8.64
HE20 STBC, M0 to M9 2ss	2	9	-42.3	-43.6			-30.6	-21	9.38
HE20 STBC, M0 to M9 2ss	3	9	-42.3	-43.6	-45.9		-29.7	-21	8.41
HE20 STBC, M0 to M9 2ss	4	9	-44.1	-47.5	-47.4	-43.3	-29.9	-21	8.64

Frequency 2462 MHz

Mode	Tx Paths	Correlated Antenna Gain (dBi)	Tx 1 Bandedge Level (dBm)	Tx 2 Bandedge Level (dBm)	Tx 3 Bandedge Level (dBm)	Tx 4 Bandedge Level (dBm)	Total Tx Bandedge Level (dBm)	Limit (dB)	Margin (dB)
CCK, 1 to 11 Mbps	1	9	-39.2				-28.8	-21	7.54
CCK, 1 to 11 Mbps	2	9	-46.1	-46.8			-33.0	-21	11.77
CCK, 1 to 11 Mbps	3	9	-48.8	-46.8	-50.1		-33.2	-21	11.92
CCK, 1 to 11 Mbps	4	9	-50.4	-50.1	-49.9	-50.7	-33.8	-21	12.58
Non HT20, 6 to 54 Mbps	1	9	-37.1				-27.7	-21	6.48
Non HT20, 6 to 54 Mbps	2	9	-40.5	-40.4			-28.1	-21	6.82
<b>Non HT20, 6 to 54 Mbps</b>	<b>3</b>	<b>9</b>	<b>-42.9</b>	<b>-41.8</b>	<b>-40.1</b>		<b>-27.3</b>	<b>-21</b>	<b>6.06</b>
<b>Non HT20, 6 to 54 Mbps</b>	<b>4</b>	<b>9</b>	<b>-42.3</b>	<b>-43.3</b>	<b>-43.1</b>	<b>-42.4</b>	<b>-27.4</b>	<b>-21</b>	<b>6.12</b>
Non HT20 Beam Forming, 6 to 54 Mbps	2	12	-42.3	-43.3			-27.4	-21	6.15
Non HT20 Beam Forming, 6 to 54 Mbps	3	14	-48.2	-47.1	-46.9		-28.2	-21	6.98
Non HT20 Beam Forming, 6 to 54 Mbps	4	15	-51.7	-50.7	-50.8	-50.2	-29.4	-21	8.18
HT/VHT20, M0 to M7	1	9	-36.7				-27.5	-21	6.25
HT/VHT20, M0 to M7	2	9	-41.8	-42.0			-29.7	-21	8.44
HT/VHT20, M8 to M15	2	9	-41.8	-42.0			-29.7	-21	8.44
HT/VHT20, M0 to M7	3	9	-42.3	-41.8	-41.2		-27.8	-21	6.52
HT/VHT20, M8 to M15	3	9	-42.3	-41.8	-41.2		-27.8	-21	6.52
HT/VHT20, M16 to M23	3	9	-42.3	-41.8	-41.2		-27.8	-21	6.52
HT/VHT20, M0 to M7	4	9	-42.9	-44.4	-42.4	-43.8	-28.1	-21	6.84
HT/VHT20, M8 to M15	4	9	-42.9	-44.4	-42.4	-43.8	-28.1	-21	6.84
HT/VHT20, M16 to M23	4	9	-42.9	-44.4	-42.4	-43.8	-28.1	-21	6.84
HT/VHT20, M24 to M31	4	9	-42.9	-44.4	-42.4	-43.8	-28.1	-21	6.84
HT/VHT20 Beam Forming, M0 to M7	2	12	-42.9	-44.4			-28.4	-21	7.13
HT/VHT20 Beam Forming, M8 to M15	2	9	-41.8	-42.0			-29.7	-21	8.44
HT/VHT20 Beam Forming, M0 to M7	3	14	-50.7	-50.1	-47.6		-30.3	-21	9.03

<b>HT/VHT20 Beam Forming, M8 to M15</b>	<b>3</b>	<b>11</b>	<b>-42.9</b>	<b>-44.4</b>	<b>-42.4</b>		<b>-27.2</b>	<b>-21</b>	<b>5.93</b>
HT/VHT20 Beam Forming, M16 to M23	3	9	-42.3	-41.8	-41.2		-27.8	-21	6.52
HT/VHT20 Beam Forming, M0 to M7	4	15	-49.0	-48.7	-49.7	-50.0	-28.1	-21	6.85
HT/VHT20 Beam Forming, M8 to M15	4	12	-50.7	-50.1	-47.6	-47.1	-30.4	-21	9.14
HT/VHT20 Beam Forming, M16 to M23	4	10	-44.7	-47.1	-45.5	-47.0	-29.7	-21	8.49
HT/VHT20 Beam Forming, M24 to M31	4	9	-42.9	-44.4	-42.4	-43.8	-28.1	-21	6.84
HT/VHT20 STBC, M0 to M7	2	9	-41.8	-42.0			-29.7	-21	8.44
HT/VHT20 STBC, M0 to M7	3	9	-42.3	-41.8	-41.2		-27.8	-21	6.52
HT/VHT20 STBC, M0 to M7	4	9	-42.9	-44.4	-42.4	-43.8	-28.1	-21	6.84
HE20, M0 to M9 1ss	1	9	-38.3				-29.0	-21	7.79
HE20, M0 to M9 1ss	2	9	-41.8	-41.1			-29.2	-21	7.91
HE20, M0 to M9 2ss	2	9	-41.8	-41.1			-29.2	-21	7.91
HE20, M0 to M9 1ss	3	9	-42.2	-42.7	-41.9		-28.2	-21	6.97
HE20, M0 to M9 2ss	3	9	-42.2	-42.7	-41.9		-28.2	-21	6.97
HE20, M0 to M9 3ss	3	9	-42.2	-42.7	-41.9		-28.2	-21	6.97
HE20, M0 to M9 1ss	4	9	-45.3	-43.9	-45.1	-41.5	-28.4	-21	7.13
HE20, M0 to M9 2ss	4	9	-45.3	-43.9	-45.1	-41.5	-28.4	-21	7.13
HE20, M0 to M9 3ss	4	9	-45.3	-43.9	-45.1	-41.5	-28.4	-21	7.13
HE20, M0 to M9 4ss	4	9	-45.3	-43.9	-45.1	-41.5	-28.4	-21	7.13
HE20 Beam Forming, M0 to M9 1ss	2	12	-45.3	-43.9			-29.3	-21	8.02
HE20 Beam Forming, M0 to M9 2ss	2	9	-41.8	-41.1			-29.2	-21	7.91
HE20 Beam Forming, M0 to M9 1ss	3	14	-47.1	-47.9	-47.4		-28.4	-21	7.17
HE20 Beam Forming, M0 to M9 2ss	3	11	-45.3	-43.9	-45.1		-28.7	-21	7.44
HE20 Beam Forming, M0 to M9 3ss	3	9	-42.2	-42.7	-41.9		-28.2	-21	6.97
HE20 Beam Forming, M0 to M9 1ss	4	15	-49.8	-50.4	-48.7	-50.6	-28.5	-21	7.28
HE20 Beam Forming, M0 to M9 2ss	4	12	-47.1	-47.9	-47.4	-45.5	-28.6	-21	7.34
HE20 Beam Forming, M0 to M9 3ss	4	10	-45.3	-43.9	-45.1	-41.5	-27.4	-21	6.13
HE20 Beam Forming, M0 to M9 4ss	4	9	-45.3	-43.9	-45.1	-41.5	-28.4	-21	7.13
HE20 STBC, M0 to M9 2ss	2	9	-41.8	-41.1			-29.2	-21	7.91
HE20 STBC, M0 to M9 2ss	3	9	-42.2	-42.7	-41.9		-28.2	-21	6.97
HE20 STBC, M0 to M9 2ss	4	9	-45.3	-43.9	-45.1	-41.5	-28.4	-21	7.13

## Data Screenshots



2462 MHz: HT/VHT20 Beam Forming, M8 to M15



Antenna A



Antenna B



Antenna C

2462 MHz: Non HT20, 6 to 54 Mbps



Antenna A



Antenna B

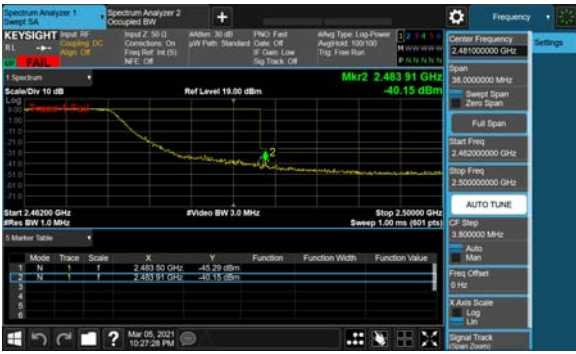

Antenna C

2462 MHz: Non HT20, 6 to 54 Mbps

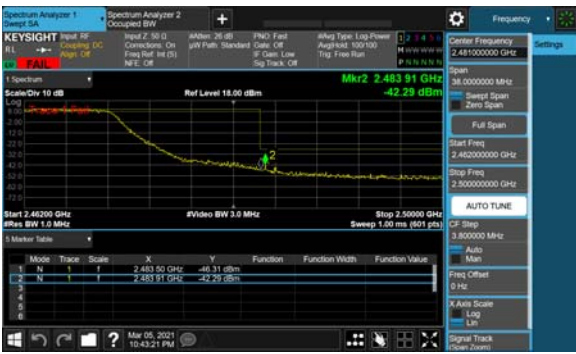

Antenna A

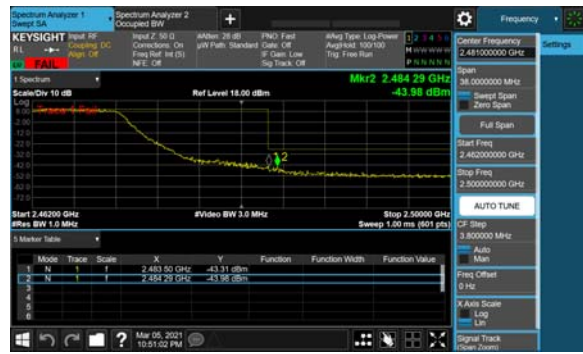

Antenna B



Antenna C



Antenna D

## A.8 Conducted Bandedge (Non-Restricted Band)

### Emissions in non-restricted frequency bands - Test Requirement

#### 15.247

(d) In any 100 kHz bandwidth outside the frequency band in which the spread spectrum or digitally modulated intentional radiator is operating, the radio frequency power that is produced by the intentional radiator shall be at least 20 dB below that in the 100 kHz bandwidth within the band that contains the highest level of the desired power, based on either an RF conducted or a radiated measurement, provided the transmitter demonstrates compliance with the peak conducted power limits. If the transmitter complies with the conducted power limits based on the use of RMS averaging over a time interval, as permitted under paragraph (b)(3) of this section, the attenuation required under this paragraph shall be 30 dB instead of 20 dB. Attenuation below the general limits specified in §15.209(a) is not required. In addition, radiated emissions which fall in the restricted bands, as defined in §15.205(a), must also comply with the radiated emission limits specified in §15.209(a) (see §15.205(c)).

**RSS-Gen 8.9** Except when the requirements applicable to a given device state otherwise, emissions from licence-exempt transmitters shall comply with the field strength limits shown in Table 4 and Table 5 below. Additionally, the level of any transmitter emission shall not exceed the level of the transmitter's fundamental emission.

**RSS-Gen 8.10 (b)** Unwanted emissions that fall into restricted bands of Table 6 shall comply with the limits specified in RSS-Gen; and (c) Unwanted emissions that do not fall within the restricted frequency bands of Table 6 shall comply either with the limits specified in the applicable RSS or with those specified in this RSS-Gen.

### Emissions in non-restricted frequency bands - Test Method

Ref. KDB 558074 D01 DTS Meas Guidance v05r02

ANSI C63.10: 2013

Emissions in non-restricted frequency bands - Conducted Test Procedure
<ol style="list-style-type: none"> <li>1. Connect the antenna port(s) to the spectrum analyzer input.</li> <li>2. Place the radio in continuous transmit mode</li> <li>3. Configure Spectrum analyzer as per test parameters below (be sure to enter all losses between the transmitter output and the spectrum analyzer).</li> <li>4. Use the marker function to determine the maximum spurs amplitude level.</li> <li>5. Capture graphs and record pertinent measurement data.</li> </ol>

Ref. KDB 558074 D01 DTS Meas Guidance v05r02 section, 8.5 DTS emissions in non-restricted frequency bands, 8.7 DTS band-edge measurements

ANSI C63.10: 2013 section 11.11.2, 11.11.3

Emissions in non-restricted frequency bands - Conducted Test parameters	
<p><b>11.11.2 Reference Level measurement</b> Establish a reference level by using the following procedure:</p> <ol style="list-style-type: none"> <li>a) Set instrument center frequency to DTS channel center frequency.</li> <li>b) Set the span to <math>\geq 1.5 \times DTS \text{ bandwidth}</math>.</li> <li>c) Set the RBW = 100 kHz.</li> <li>d) Set the VBW <math>\geq 3 \times RBW</math>.</li> <li>e) Detector = peak.</li> <li>f) Sweep time = auto couple.</li> <li>g) Trace mode = max hold.</li> <li>h) Allow trace to fully stabilize.</li> <li>i) Use the peak marker function to determine the maximum PSD level.</li> </ol>	<p><b>11.11.3 Emission Level Measurement</b></p> <ol style="list-style-type: none"> <li>a) Set the center frequency and span to encompass frequency range to be measured.</li> <li>b) Set the RBW = 100 kHz.</li> <li>c) Set the VBW <math>\geq 3 \times RBW</math>.</li> <li>d) Detector = peak.</li> <li>e) Sweep time = auto couple.</li> <li>f) Trace mode = max hold.</li> <li>g) Allow trace to fully stabilize.</li> <li>h) Use the peak marker function to determine the maximum amplitude level.</li> </ol>

<b>Tested By :</b> Said Abdelwafi, Julian Land	<b>Date of testing:</b> 02-MAR-2021 through 25-MAR-2021
<b>Test Result : PASS</b>	

### Test Equipment

See Appendix C for list of test equipment

## Non-Restricted Band

### Frequency 2412 MHz

Mode	Data Rate (Mbps)	Conducted Bandedge Delta (dB)	Limit (dBc)	Duty Cycle (dB)	Margin (dB)
CCK, 1 to 11 Mbps	11.0	55.9	>30	1.41	24.49
CCK, 1 to 11 Mbps	11.0	57.3	>30	1.41	25.89
CCK, 1 to 11 Mbps	11.0	57.8	>30	1.41	26.39
CCK, 1 to 11 Mbps	11.0	56.7	>30	1.41	25.29
Non HT20, 6 to 54 Mbps	6.0	44.3	>30	0.37	13.93
Non HT20, 6 to 54 Mbps	6.0	43.8	>30	0.37	13.43
Non HT20, 6 to 54 Mbps	6.0	43.8	>30	0.37	13.43
Non HT20, 6 to 54 Mbps	6.0	43.8	>30	0.37	13.43
Non HT20 Beam Forming, 6 to 54 Mbps	6.0	43.8	>30	0.37	13.43
Non HT20 Beam Forming, 6 to 54 Mbps	6.0	43.6	>30	0.37	13.23
Non HT20 Beam Forming, 6 to 54 Mbps	6.0	43.9	>30	0.37	13.53
HT/VHT20, M0 to M7	m0	42.9	>30	0.2	12.7
HT/VHT20, M0 to M7	m0	42.7	>30	0.2	12.5
HT/VHT20, M8 to M15	m0	42.7	>30	0.2	12.5
HT/VHT20, M0 to M7	m0	42.7	>30	0.2	12.5
HT/VHT20, M8 to M15	m0	42.7	>30	0.2	12.5
HT/VHT20, M16 to M23	m0	42.7	>30	0.2	12.5
HT/VHT20, M0 to M7	m0	42.7	>30	0.2	12.5
HT/VHT20, M8 to M15	m0	42.7	>30	0.2	12.5

HT/VHT20, M16 to M23	m0	42.7	>30	0.2	12.5
HT/VHT20, M24 to M31	m0	42.7	>30	0.2	12.5
HT/VHT20 Beam Forming, M0 to M7	m0	42.7	>30	0.2	12.5
HT/VHT20 Beam Forming, M8 to M15	m0	42.7	>30	0.2	12.5
HT/VHT20 Beam Forming, M0 to M7	m0	42.0	>30	0.2	11.8
HT/VHT20 Beam Forming, M8 to M15	m0	42.7	>30	0.2	12.5
HT/VHT20 Beam Forming, M16 to M23	m0	42.7	>30	0.2	12.5
HT/VHT20 Beam Forming, M0 to M7	m0	42.8	>30	0.2	12.6
HT/VHT20 Beam Forming, M8 to M15	m0	42.0	>30	0.2	11.8
HT/VHT20 Beam Forming, M16 to M23	m0	41.4	>30	0.2	11.2
HT/VHT20 Beam Forming, M24 to M31	m0	42.7	>30	0.2	12.5
HT/VHT20 STBC, M0 to M7	m0	42.7	>30	0.2	12.5
HT/VHT20 STBC, M0 to M7	m0	42.7	>30	0.2	12.5
HT/VHT20 STBC, M0 to M7	m0	42.7	>30	0.2	12.5
HE20, M0 to M9 1ss	m0h1	40.7	>30	0.2	10.5
HE20, M0 to M9 1ss	m0h1	39.9	>30	0.26	9.64
HE20, M0 to M9 2ss	m0h1	39.9	>30	0.26	9.64
HE20, M0 to M9 1ss	m0h1	39.9	>30	0.26	9.64
HE20, M0 to M9 2ss	m0h1	39.9	>30	0.26	9.64
HE20, M0 to M9 3ss	m0h1	39.9	>30	0.26	9.64
<b>HE20, M0 to M9 1ss</b>	<b>m0h1</b>	<b>39.6</b>	<b>&gt;30</b>	<b>0.26</b>	<b>9.34</b>
<b>HE20, M0 to M9 2ss</b>	<b>m0h1</b>	<b>39.6</b>	<b>&gt;30</b>	<b>0.26</b>	<b>9.34</b>
<b>HE20, M0 to M9 3ss</b>	<b>m0h1</b>	<b>39.6</b>	<b>&gt;30</b>	<b>0.26</b>	<b>9.34</b>
HE20, M0 to M9 4ss	m0h1	39.6	>30	0.26	9.34
HE20 Beam Forming, M0 to M9 1ss	m0h1	39.6	>30	0.26	9.34
HE20 Beam Forming, M0 to M9 2ss	m0h1	39.9	>30	0.26	9.64
HE20 Beam Forming, M0 to M9 1ss	m0h1	41.3	>30	0.26	11.04
HE20 Beam Forming, M0 to M9 2ss	m0h1	39.6	>30	0.26	9.34
HE20 Beam Forming, M0 to M9 3ss	m0h1	39.9	>30	0.26	9.64
HE20 Beam Forming, M0 to M9 1ss	m0h1	40.9	>30	0.26	10.64
HE20 Beam Forming, M0 to M9 2ss	m0h1	41.3	>30	0.26	11.04
HE20 Beam Forming, M0 to M9 3ss	m0h1	39.6	>30	0.26	9.34
HE20 Beam Forming, M0 to M9 4ss	m0h1	39.6	>30	0.26	9.34
HE20 STBC, M0 to M9 2ss	m0h1	39.9	>30	0.26	9.64
HE20 STBC, M0 to M9 2ss	m0h1	39.9	>30	0.26	9.64
HE20 STBC, M0 to M9 2ss	m0h1	39.6	>30	0.26	9.34

Frequency 2462 MHz

<b>Mode</b>	<b>Data Rate (Mbps)</b>	<b>Conducted Bandedge Delta (dB)</b>	<b>Limit (dBc)</b>	<b>Duty Cycle (dB)</b>	<b>Margin (dB)</b>
CCK, 1 to 11 Mbps	11.0	66.7	>30	1.41	35.29
CCK, 1 to 11 Mbps	11.0	67.5	>30	1.41	36.09
CCK, 1 to 11 Mbps	11.0	69.6	>30	1.41	38.19
CCK, 1 to 11 Mbps	11.0	70.0	>30	1.41	38.59
Non HT20, 6 to 54 Mbps	6.0	57.7	>30	0.37	27.33
Non HT20, 6 to 54 Mbps	6.0	54.9	>30	0.37	24.53
Non HT20, 6 to 54 Mbps	6.0	57.3	>30	0.37	26.93
Non HT20, 6 to 54 Mbps	6.0	57.6	>30	0.37	27.23
Non HT20 Beam Forming, 6 to 54 Mbps	6.0	57.6	>30	0.37	27.23
Non HT20 Beam Forming, 6 to 54 Mbps	6.0	58.3	>30	0.37	27.93
Non HT20 Beam Forming, 6 to 54 Mbps	6.0	58.8	>30	0.37	28.43
HT/VHT20, M0 to M7	m0	55.6	>30	0.2	25.4
HT/VHT20, M0 to M7	m0	56.2	>30	0.2	26.0
HT/VHT20, M8 to M15	m0	56.2	>30	0.2	26.0
HT/VHT20, M0 to M7	m0	57.1	>30	0.2	26.9
HT/VHT20, M8 to M15	m0	57.1	>30	0.2	26.9
HT/VHT20, M16 to M23	m0	57.1	>30	0.2	26.9
HT/VHT20, M0 to M7	m0	57.5	>30	0.2	27.3
HT/VHT20, M8 to M15	m0	57.5	>30	0.2	27.3
HT/VHT20, M16 to M23	m0	57.5	>30	0.2	27.3
HT/VHT20, M24 to M31	m0	57.5	>30	0.2	27.3
HT/VHT20 Beam Forming, M0 to M7	m0	57.5	>30	0.2	27.3
HT/VHT20 Beam Forming, M8 to M15	m0	56.2	>30	0.2	26.0
HT/VHT20 Beam Forming, M0 to M7	m0	58.1	>30	0.2	27.9
HT/VHT20 Beam Forming, M8 to M15	m0	57.5	>30	0.2	27.3
HT/VHT20 Beam Forming, M16 to M23	m0	57.1	>30	0.2	26.9
HT/VHT20 Beam Forming, M0 to M7	m0	59.6	>30	0.2	29.4
HT/VHT20 Beam Forming, M8 to M15	m0	58.1	>30	0.2	27.9
HT/VHT20 Beam Forming, M16 to M23	m0	58.4	>30	0.2	28.2
HT/VHT20 Beam Forming, M24 to M31	m0	57.5	>30	0.2	27.3
HT/VHT20 STBC, M0 to M7	m0	56.2	>30	0.2	26.0

HT/VHT20 STBC, M0 to M7	m0	57.1	>30	0.2	26.9
HT/VHT20 STBC, M0 to M7	m0	57.5	>30	0.2	27.3
HE20, M0 to M9 1ss	m0h1	54.2	>30	0.26	23.94
HE20, M0 to M9 1ss	m0h1	56.1	>30	0.26	25.84
HE20, M0 to M9 2ss	m0h1	56.1	>30	0.26	25.84
HE20, M0 to M9 1ss	m0h1	56.5	>30	0.26	26.24
HE20, M0 to M9 2ss	m0h1	56.5	>30	0.26	26.24
HE20, M0 to M9 3ss	m0h1	56.5	>30	0.26	26.24
HE20, M0 to M9 1ss	m0h1	58.3	>30	0.26	28.04
HE20, M0 to M9 2ss	m0h1	58.3	>30	0.26	28.04
HE20, M0 to M9 3ss	m0h1	58.3	>30	0.26	28.04
HE20, M0 to M9 4ss	m0h1	58.3	>30	0.26	28.04
HE20 Beam Forming, M0 to M9 1ss	m0h1	58.3	>30	0.26	28.04
HE20 Beam Forming, M0 to M9 2ss	m0h1	56.1	>30	0.26	25.84
HE20 Beam Forming, M0 to M9 1ss	m0h1	56.8	>30	0.26	26.54
HE20 Beam Forming, M0 to M9 2ss	m0h1	58.3	>30	0.26	28.04
HE20 Beam Forming, M0 to M9 3ss	m0h1	56.5	>30	0.26	26.24
HE20 Beam Forming, M0 to M9 1ss	m0h1	58.8	>30	0.26	28.54
HE20 Beam Forming, M0 to M9 2ss	m0h1	56.8	>30	0.26	26.54
HE20 Beam Forming, M0 to M9 3ss	m0h1	58.3	>30	0.26	28.04
HE20 Beam Forming, M0 to M9 4ss	m0h1	58.3	>30	0.26	28.04
HE20 STBC, M0 to M9 2ss	m0h1	56.1	>30	0.26	25.84
HE20 STBC, M0 to M9 2ss	m0h1	56.5	>30	0.26	26.24
HE20 STBC, M0 to M9 2ss	m0h1	58.3	>30	0.26	28.04

# Data Screenshots

2412 MHz: HE20, M0 to M9 1ss

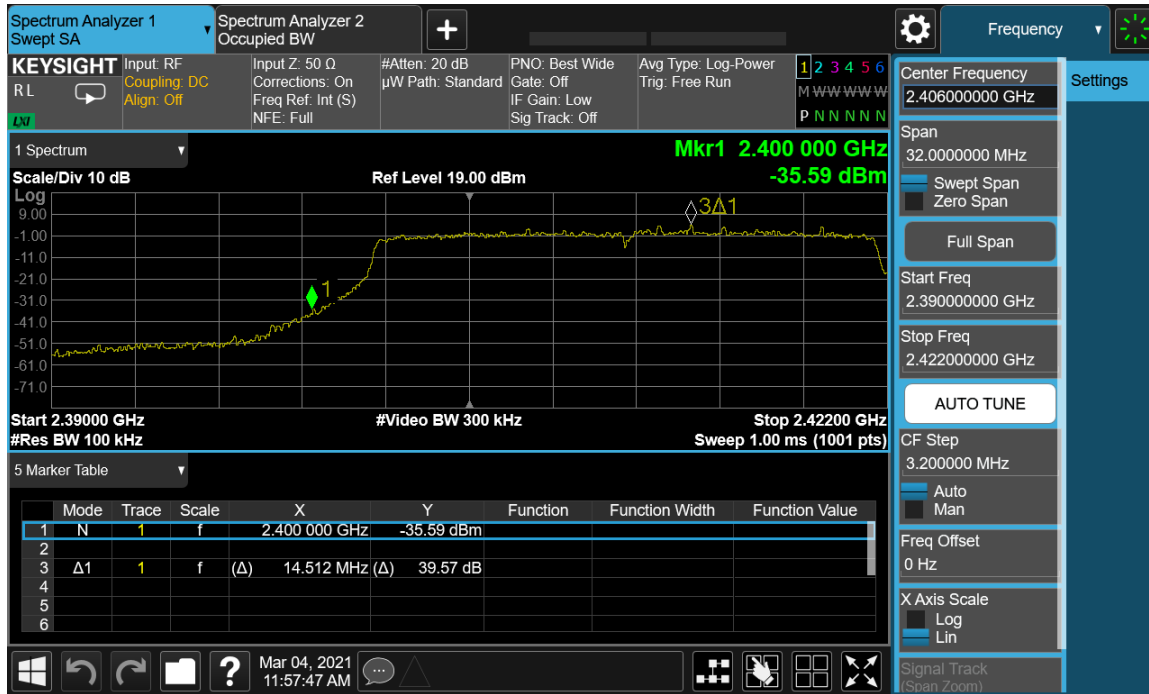

Antenna A

2412 MHz: HE20, M0 to M9 2ss

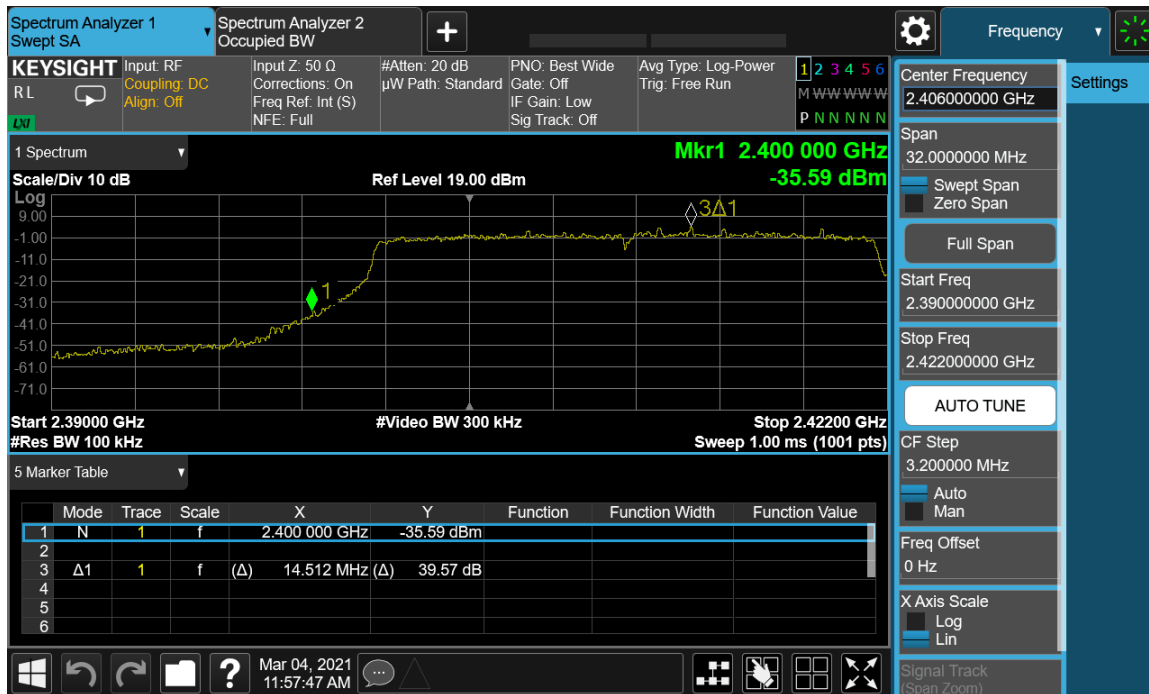

Antenna A



2412 MHz: HE20, M0 to M9 3ss

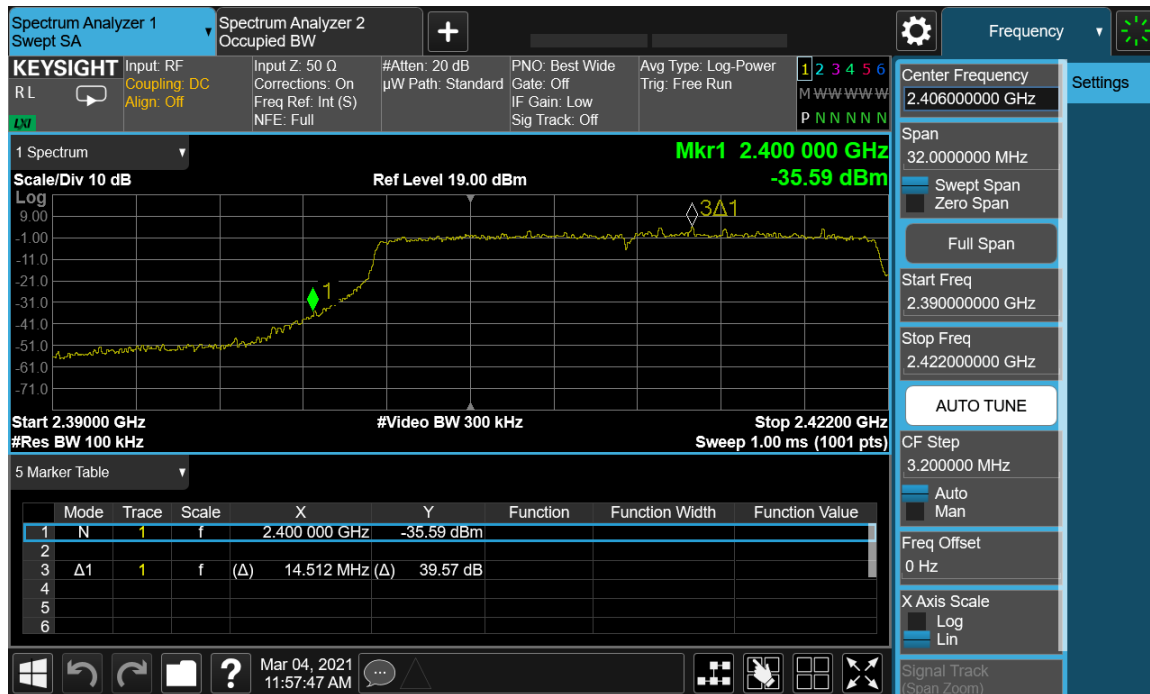

Antenna A

## Appendix B: Emission Test Results

Testing Laboratory: Cisco Systems, Inc., 125 West Tasman Drive, San Jose, CA 95134, USA

### Radiated Emission Setup Diagram-Below 1G

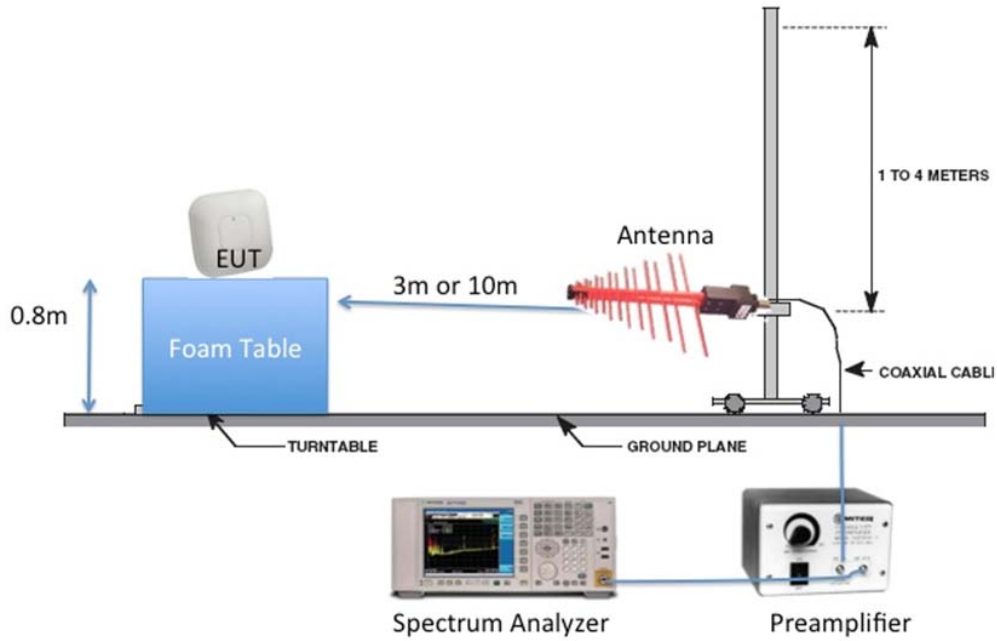

### Radiated Emission Setup Diagram-Above 1G

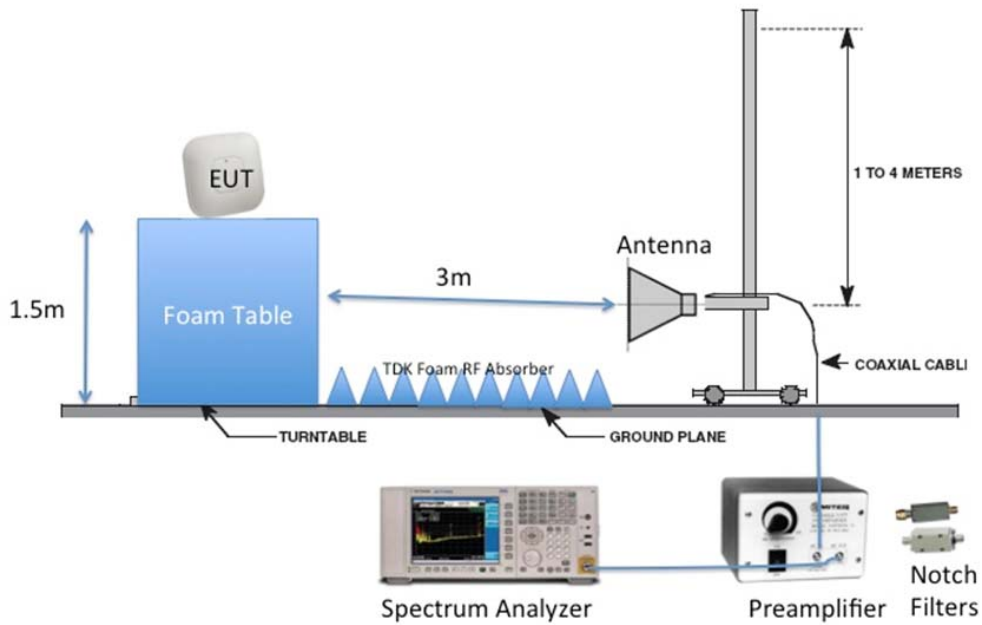

## **B.1 Radiated Spurious Emissions**

15.205 / RSS-Gen

Radiated emissions which fall in the restricted bands, as defined in Section 15.205(a) and RSS-Gen 8.10, must also comply with the radiated emission limits specified in Section 15.209(a) (see Section 15.205(c)) and RSS-Gen 8.9.

Not covered by the scope of this test report.

## **B.2 Receiver Spurious Emissions**

### **RSS-GEN:**

Receivers are required to comply with the limits of spurious emissions as set out in this section. Receiver emission measurements are to be performed as per the normative test method referenced in section 3.

Radiated emissions which fall in the restricted bands, as defined in RSS-Gen section 8.10, must also comply with the radiated emission limits specified in RSS-Gen section 8.9.

For emissions at frequencies below 1 GHz, measurements shall be performed using a CISPR quasi-peak detector and the related measurement bandwidth. At frequencies above 1 GHz, measurements shall be performed using a linear average detector with a minimum resolution bandwidth of 1 MHz.

Not covered by the scope of this test report.

## **B.3 Radiated Emissions 30MHz to 1GHz**

### **15.205 / 15.209 / RSS-Gen**

Radiated emissions which fall in the restricted bands, as defined in Section 15.205(a) and RSS-GEN section 8.10, must also comply with the radiated emission limits specified in Section 15.209(a) (see Section 15.205(c)) and RSS-Gen section 8.9.

Not covered by the scope of this test report.

## **B.4 AC Conducted Emissions**

### **FCC 15.207 (a) & RSS-Gen 8.8**

Except when the requirements applicable to a given device state otherwise, for any radio apparatus equipped to operate from the public utility AC power supply, either directly or indirectly (such as with a battery charger), the radio frequency voltage of emissions conducted back onto the AC power lines in the frequency range of 0.15 MHz to 30 MHz shall not exceed the limits shown in the table in these sections. The more stringent limit applies at the frequency range boundaries.

Not covered by the scope of this test report.

## Appendix C: List of Test Equipment Used to perform the test

Equip#	Manufacturer/ Model	Description	Last Cal	Next Due	Test Item
<b>Test Equipment used for conducted tests – Rack 9</b>					
58719	Cisco/Automation Test Insertion Loss	Rack 9	Verify Before Use	Verify Before Use	A.1-A.6
57562	Keysight (Agilent/HP)/ N9030B-550 OPT LNP EPO	PXA Signal Analyzer, 2Hz-50GHz with Options LNP and EPO	23-Jul-20	23-Jul-21	A.1-A.6
58231	NATIONAL INSTRUMENTS / PXIe-1062Q	CHASSIS	Cal Not Required	Cal Not Required	A.1-A.6
58232	NATIONAL INSTRUMENTS / PXIe-8840	Up to 2.6 GHz Quad-Core PXI Express Controller	Cal Not Required	Cal Not Required	A.1-A.6
58234	NATIONAL INSTRUMENTS / PXI-2796	40 GHz Dual 6x1 Multiplexer (SP6T)	Verify Before Use	Verify Before Use	A.1-A.6
58236	NATIONAL INSTRUMENTS / PXI-2796	40 GHz Dual 6x1 Multiplexer (SP6T)	Verify Before Use	Verify Before Use	A.1-A.6
58237	NATIONAL INSTRUMENTS / PXI-2799	Switch 1x1	Verify Before Use	Verify Before Use	A.1-A.6
56327	PASTERNAK/ PE5019-1	Torque Wrench	14-May-20	14-May-21	A.1-A.6
58256*	COMET/ T7611-4	WEB SENSOR FOR REMOTE THERMOMETER HYGROMETER	3-Feb-21	3-Feb-22	A.1-A.6

\*Please note, formal testing did not occur during the time the temperature sensor CIS#58256 was being calibrated.

## Appendix D: Abbreviation Key and Definitions

The following table defines abbreviations used within this test report.

Abbreviation	Description	Abbreviation	Description
EMC	Electro Magnetic Compatibility	°F	Degrees Fahrenheit
EMI	Electro Magnetic Interference	°C	Degrees Celsius
EUT	Equipment Under Test	Temp	Temperature
ITE	Information Technology Equipment	S/N	Serial Number
TAP	Test Assessment Schedule	Qty	Quantity
ESD	Electro Static Discharge	emf	Electromotive force
EFT	Electric Fast Transient	RMS	Root mean square
EDCS	Engineering Document Control System	Qp	Quasi Peak
Config	Configuration	Av	Average
CIS#	Cisco Number (unique identification number for Cisco test equipment)	Pk	Peak
Cal	Calibration	kHz	Kilohertz (1x10 <sup>3</sup> )
EN	European Norm	MHz	MegaHertz (1x10 <sup>6</sup> )
IEC	International Electro technical Commission	GHz	Gigahertz (1x10 <sup>9</sup> )
CISPR	International Special Committee on Radio Interference	H	Horizontal
CDN	Coupling/Decoupling Network	V	Vertical
LISN	Line Impedance Stabilization Network	dB	decibel
PE	Protective Earth	V	Volt
GND	Ground	kV	Kilovolt (1x10 <sup>3</sup> )
L1	Line 1	μV	Microvolt (1x10 <sup>-6</sup> )
L2	Line2	A	Amp
L3	Line 3	μA	Micro Amp (1x10 <sup>-6</sup> )
DC	Direct Current	mS	Milli Second (1x10 <sup>-3</sup> )
RAW	Uncorrected measurement value, as indicated by the measuring device	μS	Micro Second (1x10 <sup>-6</sup> )
RF	Radio Frequency	μS	Micro Second (1x10 <sup>-6</sup> )
SLCE	Signal Line Conducted Emissions	m	Meter
Meas dist	Measurement distance	Spec dist	Specification distance
N/A or NA	Not Applicable	SL	Signal Line (or Telecom Line)
P	Power Line	L	Live Line
N	Neutral Line	R	Return
S	Supply	AC	Alternating Current



## Appendix E: Photographs of Test Setups

EUT Photos have been omitted from this test report. Photos can be found in the supplementary exhibit included in the submission and EDCS# 21541319.

## Appendix F: Software Used to Perform Testing

Cisco Internal LabView Radio Test Automation Software:  
RF Automation Main versions: 212, 224  
RF Domain Report Generation - version 3

## Appendix G: Test Procedures

Measurements were made in accordance with

- KDB 558074 - D01 DTS Meas Guidance v05r02
- KDB 662911 - MIMO
- ANSI C63.4 2014 Unintentional Radiators
- ANSI C63.10 2013 Intentional Radiators

Test procedures are summarized below

FCC 2.4GHz Test Procedures	EDCS # 1445042
FCC 2.4GHz RSE Test Procedures	EDCS # 1480386

## Appendix H: Scope of Accreditation (A2LA certificate number 1178-01)

The scope of accreditation of Cisco Systems, Inc. can be found on the A2LA web page at:

<http://www.a2la.org/scopepdf/1178-01.pdf>

## Appendix I: Test Assessment Plan

Compliance Test Plan (Excel) EDCS# 21468206  
Target Power Tables EDCS# 19774156

## Appendix J: Worst Case Justification

N/A