

Formal Radio Test Report

FCC ID: LDK-ETHIK2360

C9124AXE-B

Cisco Catalyst C9124AX Series 802.11ax Access Point
5 GHz Secondary Radio



5725-5850 MHz

Against the following Specifications:

CFR47 Part 15.407



Cisco Systems
170 West Tasman Drive
San Jose, CA 95134

	
Author: Johanna Knudsen, Nathan Sousa Tested By: Julian Land, Mathew Blackburn, Johanna Knudsen	Approved By: Sam Kim Title: Manager, Radio Compliance Revision: 1

This report replaces any previously entered test report under EDCS – 22660220. This test report has been electronically authorized and archived using the CISCO Engineering Document Control system. Test Report Template EDCS# 11644120.

SECTION 1: OVERVIEW.....3

SECTION 2: ASSESSMENT INFORMATION4

2.1: GENERAL.....4

2.2: DATE OF TESTING5

2.3: REPORT ISSUE DATE5

2.4: TESTING FACILITIES5

2.5: EQUIPMENT ASSESSED (EUT).....6

2.6: EUT DESCRIPTION6

SECTION 3: RESULT SUMMARY8

3.1: RESULTS SUMMARY TABLE.....8

SECTION 4: SAMPLE DETAILS.....10

4.1: SAMPLE DETAILS.....10

4.2: SYSTEM DETAILS.....10

4.3: MODE OF OPERATION DETAILS11

APPENDIX A: EMISSION TEST RESULTS.....12

A.1: DUTY CYCLE13

A.2: 6dB BANDWIDTH.....17

A.3: 99% AND 26dB BANDWIDTH23

A.4: MAXIMUM CONDUCTED OUTPUT POWER29

A.5: POWER SPECTRAL DENSITY.....37

A.6: CONDUCTED SPURIOUS EMISSIONS46

A.7: CONDUCTED BANDEGE62

APPENDIX B: EMISSION TEST RESULTS.....72

B.1: RADIATED SPURIOUS EMISSIONS73

B.2: RADIATED EMISSIONS 30MHZ TO 1GHZ74

B.3: AC CONDUCTED EMISSIONS75

APPENDIX C: LIST OF TEST EQUIPMENT USED TO PERFORM THE TEST76

APPENDIX D: ABBREVIATION KEY AND DEFINITIONS81

APPENDIX E: PHOTOGRAPHS OF TEST SETUPS.....82

APPENDIX F: SOFTWARE USED TO PERFORM TESTING.....82

APPENDIX G: TEST PROCEDURES82

APPENDIX H: SCOPE OF ACCREDITATION (A2LA CERTIFICATE NUMBER 1178-01).....82

APPENDIX I: TEST ASSESSMENT PLAN82

APPENDIX J: WORST CASE JUSTIFICATION82

Section 1: Overview

The samples were assessed against the tests detailed in section 3 under the requirements of the following specifications:

Specifications:
CFR47 Part 15.407

Section 2: Assessment Information

2.1: General

This report contains an assessment of an apparatus against Electromagnetic Compatibility Standards based upon tests carried out on the samples submitted. The testing was performed by and for the use of Cisco systems Inc:

With regard to this assessment, the following points should be noted:

- a) The results contained in this report relate only to the items tested and were obtained in the period between the date of the initial assessment and the date of issue of the report. Manufactured products will not necessarily give identical results due to production and measurement tolerances.
- b) The apparatus was set up and exercised using the configuration and modes of operation defined in this report only.
- c) Where relevant, the apparatus was only assessed using the susceptibility criteria defined in this report and the Test Assessment Plan (TAP).
- d) All testing was performed under the following environmental conditions:

Temperature	15 °C to 35 °C (54 °F to 95 °F)
Atmospheric Pressure	860 mbar to 1060 mbar (25.4" to 31.3")
Humidity	10% to 75*%

- e) All AC testing was performed at one or more of the following supply voltages:

110V 60 Hz (+/-20%)

Units of Measurement

The units of measurements defined in the appendices are reported in specific terms, which are test dependent. Where radiated measurements are concerned these are defined at a particular distance. Basic voltage measurements are defined in units of [dBuV]

As an example, the basic calculation for all measurements is as follows:

$$\text{Emission level [dBuV]} = \text{Indicated voltage level [dBuV]} + \text{Cable Loss [dB]} + \text{Other correction factors [dB]}$$

The combinations of correction factors are dependent upon the exact test configurations [see test equipment lists for further details] and may include:

Antenna Factors, Pre-Amplifier Gain, LISN Loss, Pulse Limiter Loss and Filter Insertion Loss

Note: To convert the results from dBuV/m to uV/m use the following formula:

$$\text{Level in uV/m} = \text{Common Antilogarithm} [(X \text{ dBuV/m})/20] = Y \text{ uV/m}$$

Measurement Uncertainty Values

voltage and power measurements	± 2 dB
conducted EIRP measurements	± 1.4 dB
radiated measurements	± 3.2 dB
frequency measurements	± 2.4 10 ⁻⁷
temperature measurements	± 0.54°
humidity measurements	± 2.3%
DC and low frequency measurements	± 2.5%

Where relevant measurement uncertainty levels have been estimated for tests performed on the apparatus. This uncertainty represents an expanded uncertainty expressed at approximately the 95% confidence level using a coverage factor of k=2.

Radiated emissions (expanded uncertainty, confidence interval 95%)

30 MHz – 300 MHz	± 3.8 dB
300 MHz – 1000 MHz	± 4.3 dB
1 GHz – 10 GHz	± 4.0 dB
10 GHz – 18GHz	± 8.2 dB
18GHz – 26.5GHz	± 4.1 dB
26.5GHz – 40GHz	± 3.9 dB

Conducted emissions (expanded uncertainty, confidence interval 95%)

30 MHz – 40 GHz	± 0.38 dB
-----------------	-----------

A product is considered to comply with a requirement if the nominal measured value is below the limit line. The product is considered to not be in compliance in case the nominal measured value is above the limit line.

This report must not be reproduced except in full, without written approval of Cisco Systems.

2.2: Date of testing

23-JUL-2021 to 26-JUL-2021; 28-JUL-2021 to 31-JUL-2021; 17-AUG-2021 to 27-AUG-2021; 30-AUG-2021 to 04-SEP-2021; 07-SEP-2021 to 09-SEP-2021; 25-OCT-2021; 25-OCT-2021

2.3: Report Issue Date

6-DEC-21

Cisco uses an electronic system to issue, store and control the revision of test reports. This system is called the Engineering Document Control System (EDCS). The actual report issue date is embedded into the original file on EDCS. Any copies of this report, either electronic or paper, that are not on EDCS must be considered uncontrolled.

2.4: Testing facilities

This assessment was performed by:

Testing Laboratory
Cisco Systems, Inc.
125 West Tasman Drive (Building P)
San Jose, CA 95134
USA

Headquarters
Cisco Systems, Inc.,
170 West Tasman Drive
San Jose, CA 95134,
USA

Registration Numbers for Industry Canada

Cisco System Site	Address	Site Identifier
Building P, 10m Chamber	125 West Tasman Dr San Jose, CA 95134	Company #: 2461N-2
Building P, 5m Chamber	125 West Tasman Dr San Jose, CA 95134	Company #: 2461N-1
Building 7, 5m Chamber	425 E. Tasman Drive San Jose, California 95134 United States	Company #: 2461N-3

Test Engineer(s):

Johanna Knudsen, Julian Land, Mathew Blackburn

2.5: Equipment Assessed (EUT)

C9124AXE

2.6: EUT Description

The Cisco Catalyst 9124AX Series outdoor access points are next-generation Wi-Fi 6 access points encased in a rugged and robust design that service providers and enterprises can easily deploy.

The radio supports the following modes of operation. The modes are further defined in the radio Theory of Operation. The modes included in this report represent the worst-case data for all modes.

802.11a (6 – 54 Mbps)
 802.11a Beam Forming (6 – 54 Mbps)
 802.11n/ac HT/VHT20 (MCS0 – MCS15)
 802.11n/ac HT/VHT20 Beam Forming (MCS0 – MCS15)
 802.11n/ac HT/VHT20 STBC (MCS0 – MCS7)
 802.11ax HE20 (MCS0 – MCS9) 1 SS
 802.11ax HE20 (MCS0 – MCS9) 2 SS
 802.11ax HE20 Beam Forming (MCS0 – MCS9) 1 SS
 802.11ax HE20 Beam Forming (MCS0 – MCS9) 2 SS
 802.11ax HE20 STBC (MCS0 – MCS9) 2 SS

802.11a non-HT40 (6 – 54 Mbps)
 802.11n/ac HT/VHT40 (MCS0 – MCS15)
 802.11n/ac HT/VHT40 Beam Forming (MCS0 – MCS15)
 802.11n/ac HT/VHT40 STBC (MCS0 – MCS7)
 802.11ax HE40 (MCS0 – MCS9) 1 SS
 802.11ax HE40 (MCS0 – MCS9) 2 SS
 802.11ax HE40 Beam Forming (MCS0 – MCS9) 1 SS
 802.11ax HE40 Beam Forming (MCS0 – MCS9) 2 SS
 802.11ax HE40 STBC (MCS0 – MCS9) 2 SS

802.11a non-HT80 (6 – 54 Mbps)
 802.11n/ac HT/VHT80 (MCS0 – MCS9) 1 SS
 802.11n/ac HT/VHT80 (MCS0 – MCS9) 2 SS
 802.11n/ac HT/VHT80 Beam Forming (MCS0 – MCS9) 1 SS
 802.11n/ac HT/VHT80 Beam Forming (MCS0 – MCS9) 2 SS
 802.11n/ac HT/VHT80 STBC (MCS0 – MCS9) 1 SS
 802.11ax HE80 (MCS0 – MCS9) 1 SS
 802.11ax HE80 (MCS0 – MCS9) 2 SS
 802.11ax HE80 Beam Forming (MCS0 – MCS9) 1 SS
 802.11ax HE80 Beam Forming (MCS0 – MCS9) 2 SS
 802.11ax HE80 STBC (MCS0 – MCS9) 1 SS

The following antennas are supported by this product series. Please note, the antenna information has been provided by the customer (the Cisco business unit). The data included in this report represent the worst-case data for all antennas.

Frequency	Antenna Name		Antenna Gain
5 GHz	TX/RX: External	Antenna 1	14 dBi (Side Lobe: 5 dBi)

Section 3: Result Summary

3.1: Results Summary Table

Conducted emissions

Basic Standard	Technical Requirements / Details	Result
FCC 15.407	6dB Bandwidth: (e) Within the 5.725-5.85 GHz band, the minimum 6 dB bandwidth of U-NII devices shall be at least 500 kHz.	Pass
FCC 15.407	99% & 26 dB Bandwidth: The 99% occupied bandwidth is the frequency bandwidth such that, below its lower and above its upper frequency limits, the mean powers are each equal to 0.5% of the total mean power of the given emission. There is no limit for 99% OBW. The 26 dB emission is the width of the emission that is constrained by the frequencies associated with the two outermost amplitude points (upper and lower frequencies) that are attenuated by 26 dB relative to the maximum level measured in the fundamental emission.	Pass
FCC 15.407	Output Power: (3) For the band 5.725-5.85 GHz, the maximum conducted output power over the frequency band of operation shall not exceed 1 W. ... If transmitting antennas of directional gain greater than 6 dBi are used, both the maximum conducted output power and the maximum power spectral density shall be reduced by the amount in dB that the directional gain of the antenna exceeds 6 dBi. However, fixed point-to-point U-NII devices operating in this band may employ transmitting antennas with directional gain greater than 6 dBi without any corresponding reduction in transmitter conducted power.	Pass
FCC 15.407	Power Spectral Density: (3) For the band 5.725-5.85 GHz... the maximum power spectral density shall not exceed 30 dBm in any 500-kHz band. If transmitting antennas of directional gain greater than 6 dBi are used, both the maximum conducted output power and the maximum power spectral density shall be reduced by the amount in dB that the directional gain of the antenna exceeds 6 dBi. However, fixed point-to-point U-NII devices operating in this band may employ transmitting antennas with directional gain greater than 6 dBi without any corresponding reduction in transmitter conducted power.	Pass
FCC 15.407	Conducted Spurious Emissions / Band-Edge: (4) For transmitters operating in the 5.725-5.85 GHz band: (i) All emissions shall be limited to a level of -27 dBm/MHz at 75 MHz or more above or below the band edge increasing linearly to 10 dBm/MHz at 25 MHz above or below the band edge, and from 25 MHz above or below the band edge increasing linearly to a level of 15.6 dBm/MHz at 5 MHz above or below the band edge, and from 5 MHz above or below the band edge increasing linearly to a level of 27 dBm/MHz at the band edge.	Pass
FCC 15.407 FCC 15.205 FCC 15.209	Restricted band: Unwanted emissions must comply with the general field strength limits set forth in §15.209. (7) The provisions of §15.205 apply to intentional radiators operating under this section.	Pass

Radiated Emissions (General requirements)

Basic Standard	Technical Requirements / Details	Result
FCC 15.407 FCC 15.205 FCC 15.209	TX Spurious Emissions: Unwanted emissions must comply with the general field strength limits set forth in §15.209. (7) The provisions of §15.205 apply to intentional radiators operating under this section.	Not covered by the scope of this report
FCC 15.207	AC conducted Emissions: Except when the requirements applicable to a given device state otherwise, for any radio apparatus equipped to operate from the public utility AC power supply, either directly or indirectly (such as with a battery charger), the radio frequency voltage of emissions conducted back onto the AC power lines in the frequency range of 0.15 MHz to 30 MHz shall not exceed the limits shown in the table in these sections. The more stringent limit applies at the frequency range boundaries.	Not covered by the scope of this report

* MPE calculation is recorded in a separate report

Section 4: Sample Details

Note: Each sample was evaluated to ensure that its condition was suitable to be used as a test sample prior to the commencement of testing.

4.1: Sample Details

Sample No.	Equipment Details	Manufacturer	Hardware Rev.	Serial Number
S01	C9124AXE-B (Used in Rack 2)	Foxconn (For Cisco)	PP	FOC25028JEV
S02	C9124AXE-B (Used in Rack 3)	Foxconn (For Cisco)	PP	FOC25042JPW
S03	C9124AXE-B (Used in Rack 8)	Foxconn (For Cisco)	PP	FOC252811S1
S04	C9124AXE-B (Used in Rack 8)	Foxconn (For Cisco)	PP	FOC25292AQ4
S05	C9124AXE-B (Used in Rack 9)	Foxconn (For Cisco)	PP	FOC25220CP1
S06	C9124AXE-B (Used in Rack 9)	Foxconn (For Cisco)	PP	FOC25292APS
S07	C9124AXE-B (Used in Rack 9)	Foxconn (For Cisco)	PP	FOC25028JFG
S08	C9124AXE-B (Used in Rack 4)	Foxconn (For Cisco)	PP	FOC25028JBJ

4.2: System Details

System #	Description	Samples
1	EUT (used in Rack 2)	S01
2	EUT (used in Rack 3)	S02
3	EUT (used in Rack 8)	S03
3	EUT (used in Rack 8)	S04
4	EUT (used in Rack 9)	S05
4	EUT (used in Rack 9)	S06
4	EUT (used in Rack 9)	S07
5	EUT (used in Rack 4)	S08

4.3: Mode of Operation Details

Mode#	Description	Comments
1	Continuously Transmitting Testing using Rack 2	AP Running Image: 8.8.1.10 Cisco AP Software, (ap1g6a), [cheetah-build9:/san1/BUILD/workspace/c176_throttle_mfg/label/mfg-ap1g6a] Compiled Wed Jul 7 22:15:45 GMT 2021
2	Continuously Transmitting Testing using Rack 3	AP Running Image: 8.8.1.10 Cisco AP Software, (ap1g6a), [cheetah-build9:/san1/BUILD/workspace/c176_throttle_mfg/label/mfg-ap1g6a] Compiled Wed Jul 7 22:15:45 GMT 2021
3	Continuously Transmitting Testing using Rack 8 23-JUL-2021 to 23-AUG-2021	AP Running Image: 8.8.1.10 Cisco AP Software, (ap1g6a), [cheetah-build9:/san1/BUILD/workspace/c176_throttle_mfg/label/mfg-ap1g6a] Compiled Wed Jul 14 22:18:33 GMT 2021
3	Continuously Transmitting Testing using Rack 8 24-AUG-2021	AP Running Image: 8.8.1.10 Cisco AP Software, (ap1g6a), [sjc-ads-5182:/nobackup/maruthib/c176lthaca] Compiled Wed Jul 28 23:16:09 PDT 2021
4	Continuously Transmitting Testing using Rack 9 26-JUL-2021 to 25-AUG-2021	AP Running Image: 8.8.1.10 Cisco AP Software, (ap1g6a), [cheetah-build9:/san1/BUILD/workspace/c176_throttle_mfg/label/mfg-ap1g6a] Compiled Wed Jul 14 22:18:33 GMT 2021
4	Continuously Transmitting Testing using Rack 9 26-AUG-2021; 25-OCT-2021	AP Running Image: 8.8.1.10 Cisco AP Software, (ap1g6a), [sjc-ads-5182:/nobackup/maruthib/c176lthaca] Compiled Wed Jul 28 23:16:09 PDT 2021
4	Continuously Transmitting Testing using Rack 9 23-JUL-2021 to 25-JUL-2021	AP Running Image: 8.8.1.10 Cisco AP Software, (ap1g6a), [cheetah-build9:/san1/BUILD/workspace/c175_throttle_mfg/label/mfg-ap1g6a] Compiled Wed Apr 14 18:59:06 GMT 2021
5	Continuously Transmitting Testing using Rack 4	AP Running Image: 8.8.1.10 Cisco AP Software, (ap1g6a), [cheetah-build9:/san1/BUILD/workspace/c175_throttle_mfg/label/mfg-ap1g6a] Compiled Wed Apr 14 18:59:06 GMT 2021

Appendix A: Emission Test Results

Conducted Test Setup Diagram

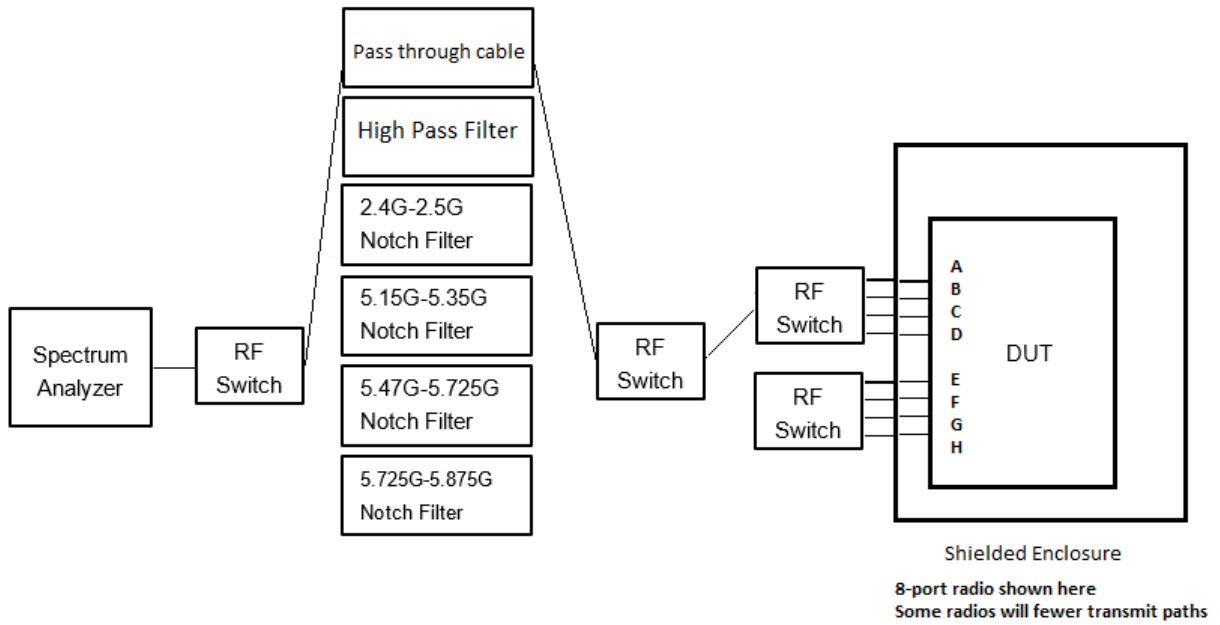

A.1: Duty Cycle

Duty Cycle Test Requirement

From KDB 789033 D02 General UNII Test Procedures New Rules v02r01:

B. Duty Cycle (x), Transmission Duration (T), and Maximum Power Control Level

1. All measurements are to be performed with the EUT transmitting at 100 percent duty cycle at its maximum power control level; however, if 100 percent duty cycle cannot be achieved, measurements of duty cycle, x, and maximum-power transmission duration, T, are required for each tested mode of operation.

Duty Cycle Test Method

From KDB 789033 D02 General UNII Test Procedures New Rules v02r01:

B. Duty Cycle (x), Transmission Duration (T), and Maximum Power Control Level

The zero-span mode on a spectrum analyzer or EMI receiver, if the response time and spacing between bins on the sweep are sufficient to permit accurate measurements of the on and off times of the transmitted signal. Set the center frequency of the instrument to the center frequency of the transmission. Set $RBW \geq EBW$ if possible; otherwise, set RBW to the largest available value. Set $VBW \geq RBW$. Set detector = peak or average. The zero-span measurement method shall not be used unless both RBW and VBW are $> 50/T$, where T is defined in section II.B.1.a), and the number of sweep points across duration T exceeds 100. (For example, if VBW and/or RBW are limited to 3 MHz, then the zero-span method of measuring duty cycle shall not be used if $T \leq 16.7$ microseconds.)

Duty Cycle Test Information

Tested By: Johanna Knudsen, Julian Land, Mathew Blackburn	Date of testing: 30-AUG-2021; 03-SEP-2021
Test Result: PASS	

Test Equipment

See Appendix C for list of test equipment

Duty Cycle Data Table

Duty Cycle table and screen captures are shown below for Power/PSD modes.

Frequency (MHz)	Mode	Data Rate (Mbps)	Duty Cycle (dB)
5690	Non HT80, 6 to 54 Mbps	6.0	0.3574
	VHT80, M0 to M9 1ss	m0x1	0.89162
	HE80, M0 to M9 1ss	m0h1	0.22505
5710	Non HT40, 6 to 54 Mbps	6.0	0.32358
	HT/VHT40, M0 to M7	m0	0.33061
	HE40, M0 to M9 1ss	m0h1	0.27242
5720	Non HT20, 6 to 54 Mbps	6.0	0.5022
	HT/VHT20, M0 to M7	m0	0.30584
	HE20, M0 to M9 1ss	m0h1	0.27057
5745	Non HT20, 6 to 54 Mbps	6.0	0.5022
	HT/VHT20, M0 to M7	m0	0.30584
	HE20, M0 to M9 1ss	m0h1	0.27057
5755	Non HT40, 6 to 54 Mbps	6.0	0.32358
	HT/VHT40, M0 to M7	m0	0.89963
	HE40, M0 to M9 1ss	m0h1	0.27242
5775	Non HT80, 6 to 54 Mbps	6.0	0.3574
	VHT80, M0 to M9 1ss	m0x1	0.89162
	HE80, M0 to M9 1ss	m0h1	0.22505
5785	Non HT20, 6 to 54 Mbps	6.0	0.5022
	HT/VHT20, M0 to M7	m0	0.30584
	HE20, M0 to M9 1ss	m0h1	0.27057
5795	Non HT40, 6 to 54 Mbps	6.0	0.32358
	HT/VHT40, M0 to M7	m0	0.33061
	HE40, M0 to M9 1ss	m0h1	0.27242
5825	Non HT20, 6 to 54 Mbps	6.0	0.5022
	HT/VHT20, M0 to M7	m0	0.30584
	HE20, M0 to M9 1ss	m0h1	0.27057

Data Screenshots

5755 MHz: HT/VHT40, M0 to M7

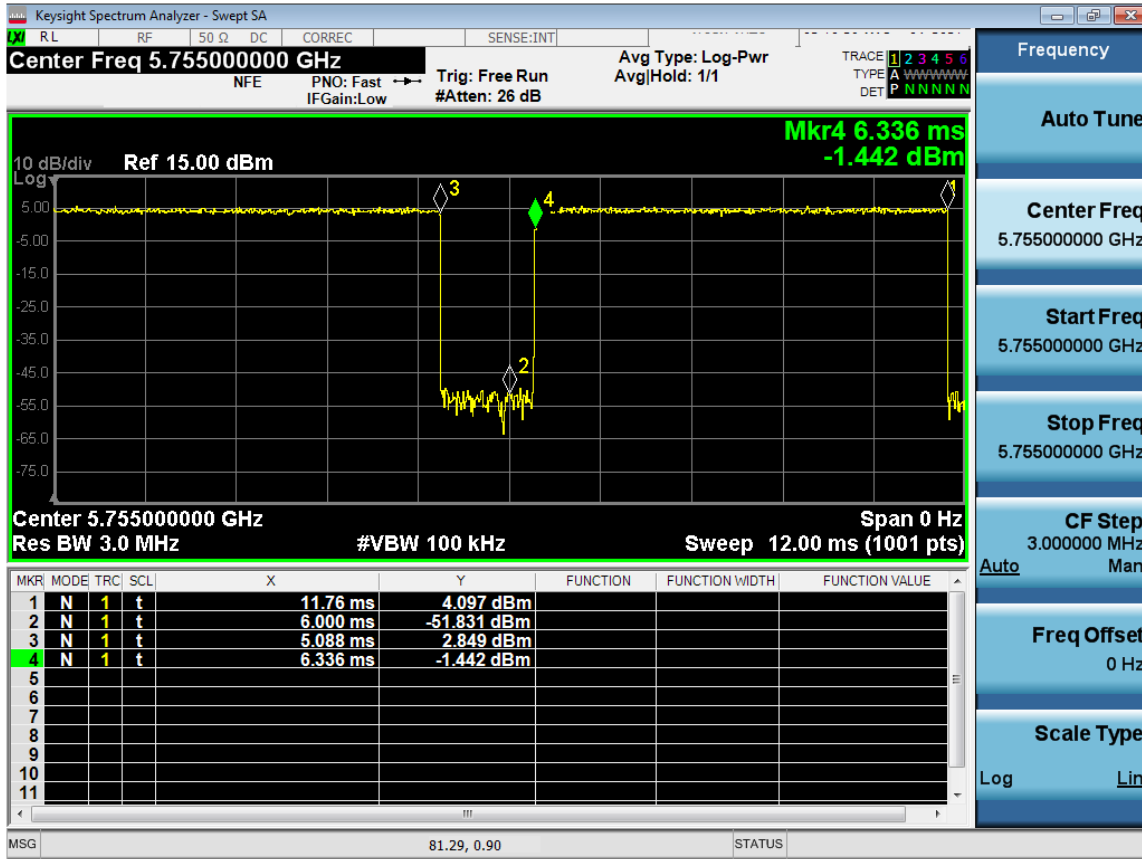

Antenna A

5775 MHz: VHT80, M0 to M9 1ss

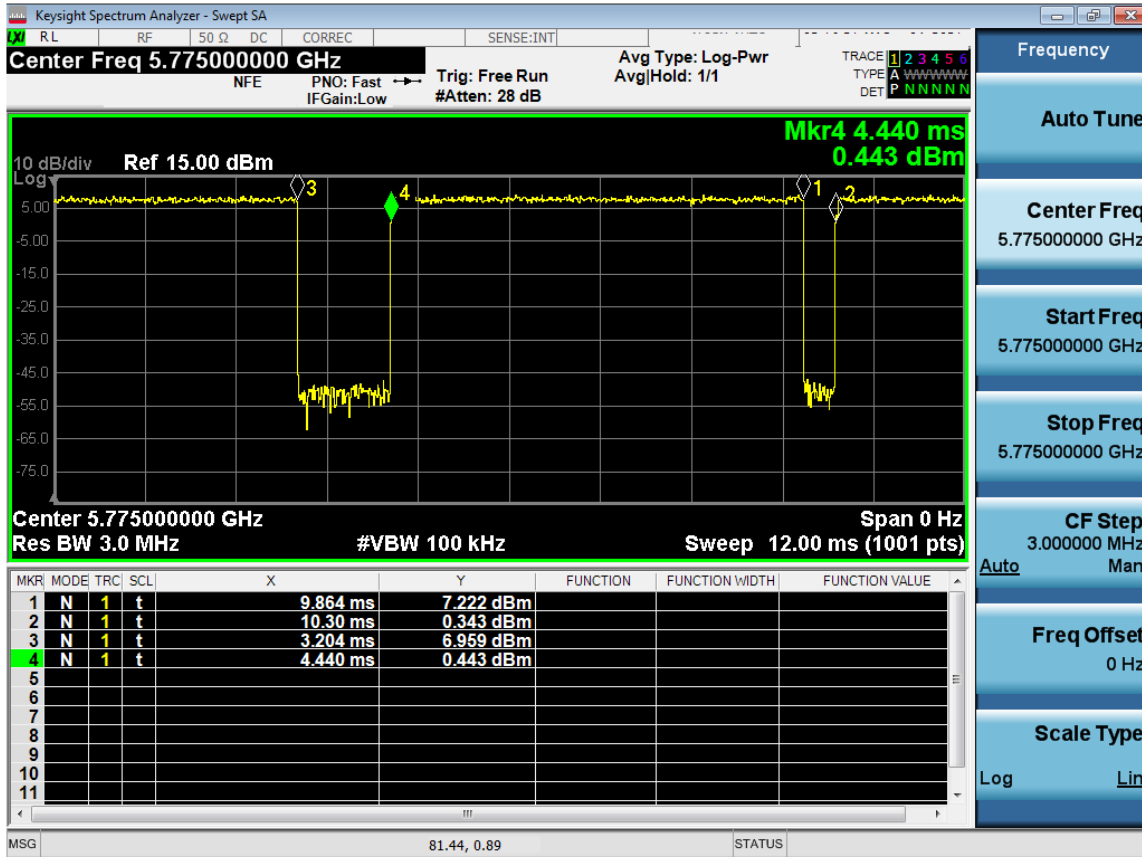

Antenna A

A.2: 6dB Bandwidth

6dB Bandwidth Test Requirement

15.407 e:

Within the 5.725-5.85 GHz band, the minimum 6 dB bandwidth of U-NII devices shall be at least 500 kHz

Emission bandwidth (EBW) in U-NII bands:

Band-crossing emissions: For an emission that crosses the boundary between two adjacent U-NII bands, the boundary frequency between the bands serves as one edge for defining the portion of the EBW that falls within a particular U-NII band. □However, the -26 dB points are measured relative to the highest point on the contiguous segment—regardless of which band contains that highest point (Figure3).

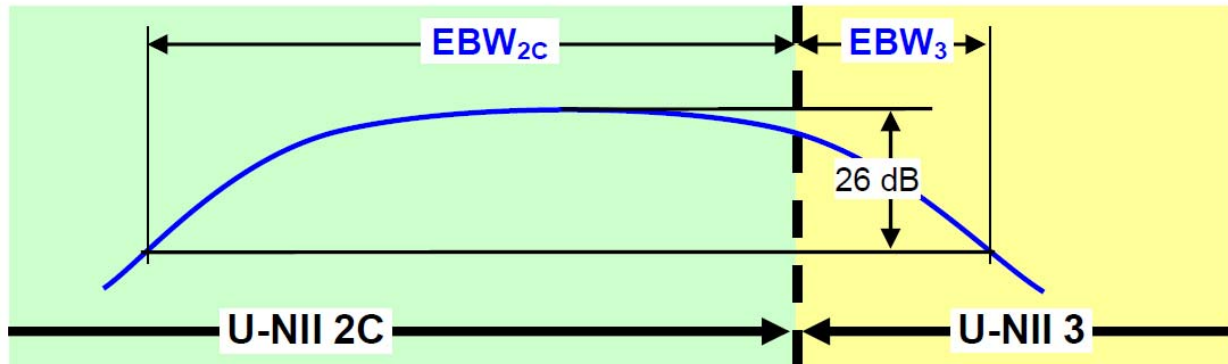

Figure 3. Emission Bandwidth (EBW) within a Band for Band-Crossing Signals

6dB Bandwidth Test Procedure

Ref. ANSI C63.10:2013

From KDB 789033 D02 General UNII Test Procedures New Rules v02r01

Section C. Bandwidth Measurement

6 BW
Test Procedure
<ol style="list-style-type: none"> 1. Set the radio in the continuous transmitting mode. 2. Allow the trace to stabilize. 3. Setting the x-dB bandwidth mode to -6dB within the measurement set up function. 4. Select the automatic OBW measurement function of an instrument to perform bandwidth measurement. 5. Capture graphs and record pertinent measurement data.

Ref. ANSI C63.10: 2013 section 11.8.2 Option 2

From KDB 789033 D02 General UNII Test Procedures New Rules v02r01

Section C. Bandwidth Measurement

6 BW	
Test parameters	
2. Minimum Emission Bandwidth for the band 5.725-5.85 GHz	
a) Set RBW = 100 kHz.	
b) Set the video bandwidth (VBW) $\geq 3 \times$ RBW.	
c) Detector = Peak.	
d) Trace mode = max hold.	
e) Sweep = auto couple.	
f) Allow the trace to stabilize.	
g) Measure the maximum width of the emission that is constrained by the frequencies associated with the two outermost amplitude points (upper and lower frequencies) that are attenuated by 6 dB relative to the maximum level measured in the fundamental emission.	
Note: The automatic bandwidth measurement capability of a spectrum analyzer or EMI receiver may be employed if it implements the functionality described above.	
Tested By: Johanna Knudsen, Julian Land, Mathew Blackburn	Date of testing: 25-JUL-2021 to 26-JUL-2021; 30-JUL-2021 to 31-JUL-2021; 20-AUG-2021 to 23-AUG-2021; 30-AUG-2021 to 2-SEP-2021;
Test Result: PASS	

Test Equipment

See Appendix C for list of test equipment

6 dB Bandwidth Tables

Frequency (MHz)	Mode	Data Rate (Mbps)	6dB BW (MHz)	Limit (kHz)	Margin (MHz)
5690	Non HT80, 6 to 54 Mbps	6.0	3.1	>500	2.6
	VHT80, M0 to M9 1ss	m0x1	3.2	>500	2.7
	HE80, M0 to M9 1ss	m0h1	4.0	>500	3.5
5710	Non HT40, 6 to 54 Mbps	6.0	3.2	>500	2.7
	HT/VHT40, M0 to M7	m0	3.1	>500	2.6
	HE40, M0 to M9 1ss	m0h1	4.1	>500	3.6
5720	Non HT20, 6 to 54 Mbps	6.0	3.2	>500	2.7
	HT/VHT20, M0 to M7	m0	3.8	>500	3.3
	HE20, M0 to M9 1ss	m0h1	4.4	>500	3.9
5745	Non HT20, 6 to 54 Mbps	6.0	16.0	>500	15.5
	HT/VHT20, M0 to M7	m0	17.2	>500	16.7
	HE20, M0 to M9 1ss	m0h1	18.8	>500	18.3
5755	Non HT40, 6 to 54 Mbps	6.0	35.5	>500	35.0
	HT/VHT40, M0 to M7	m0	35.8	>500	35.3
	HE40, M0 to M9 1ss	m0h1	37.9	>500	37.4
5775	Non HT80, 6 to 54 Mbps	6.0	75.3	>500	74.8
	VHT80, M0 to M9 1ss	m0x1	72.4	>500	71.9
	HE80, M0 to M9 1ss	m0h1	77.4	>500	76.9
5785	Non HT20, 6 to 54 Mbps	6.0	16.0	>500	15.5
	HT/VHT20, M0 to M7	m0	16.9	>500	16.4
	HE20, M0 to M9 1ss	m0h1	18.7	>500	18.2
5795	Non HT40, 6 to 54 Mbps	6.0	35.9	>500	35.4
	HT/VHT40, M0 to M7	m0	35.9	>500	35.4
	HE40, M0 to M9 1ss	m0h1	37.7	>500	37.2
5825	Non HT20, 6 to 54 Mbps	6.0	16.0	>500	15.5
	HT/VHT20, M0 to M7	m0	17.2	>500	16.7
	HE20, M0 to M9 1ss	m0h1	15.0	>500	14.5

Data Screenshots

5690 MHz: Non HT80, 6 to 54 Mbps

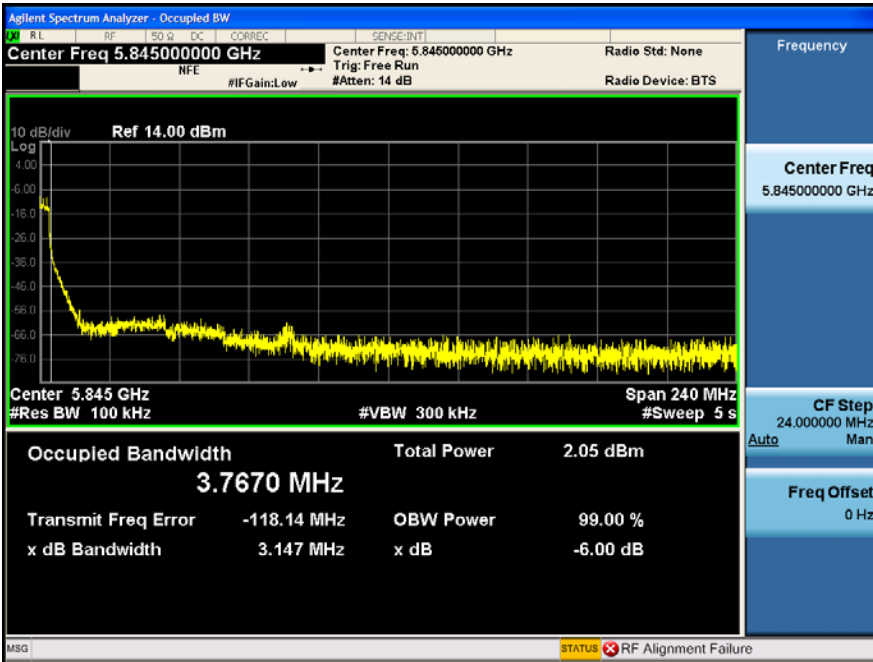

Antenna A

5710 MHz: HT/VHT40, M0 to M7



Antenna A

5690 MHz: VHT80, M0 to M9 1ss

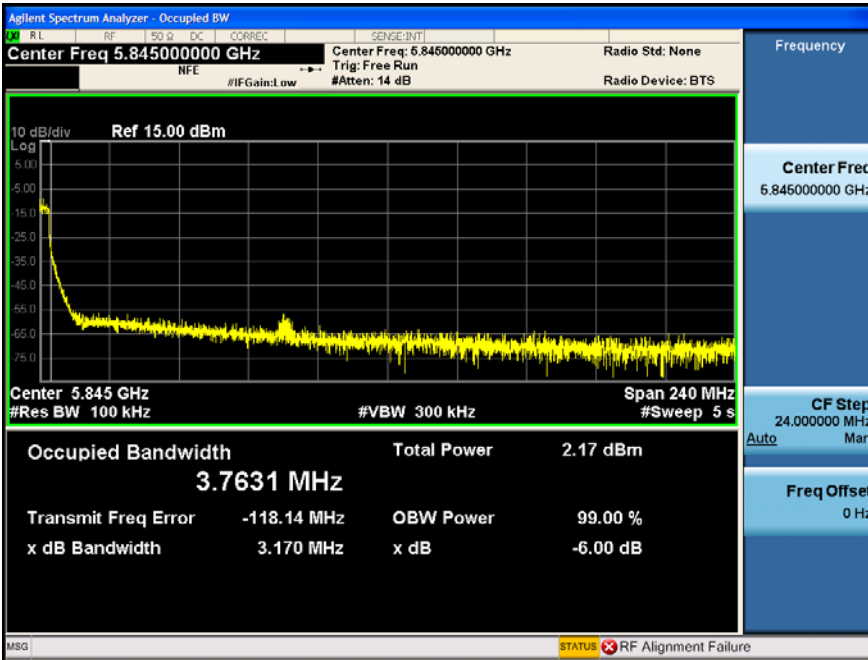

Antenna A

5745 MHz: Non HT20, 6 to 54 Mbps

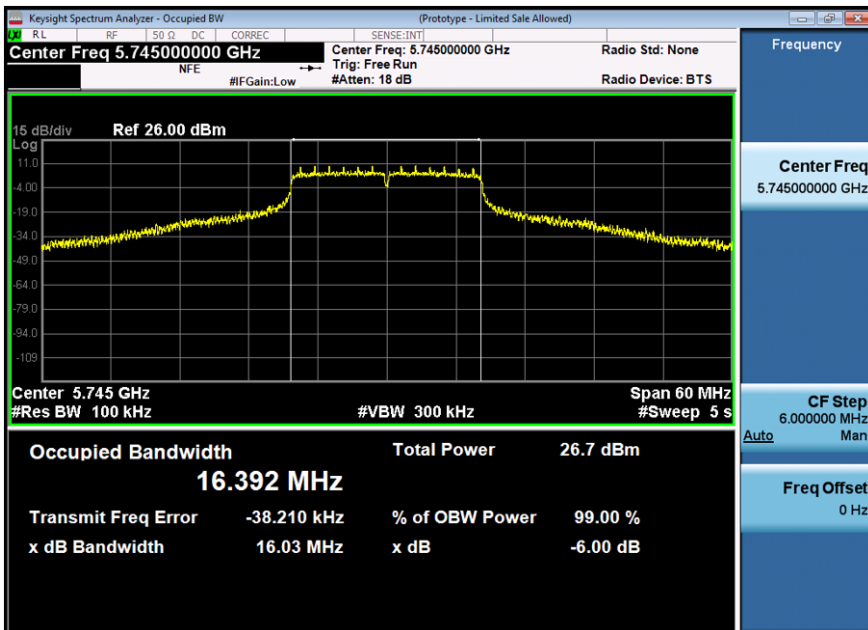

Antenna A

5755 MHz: HT/VHT40, M0 to M7

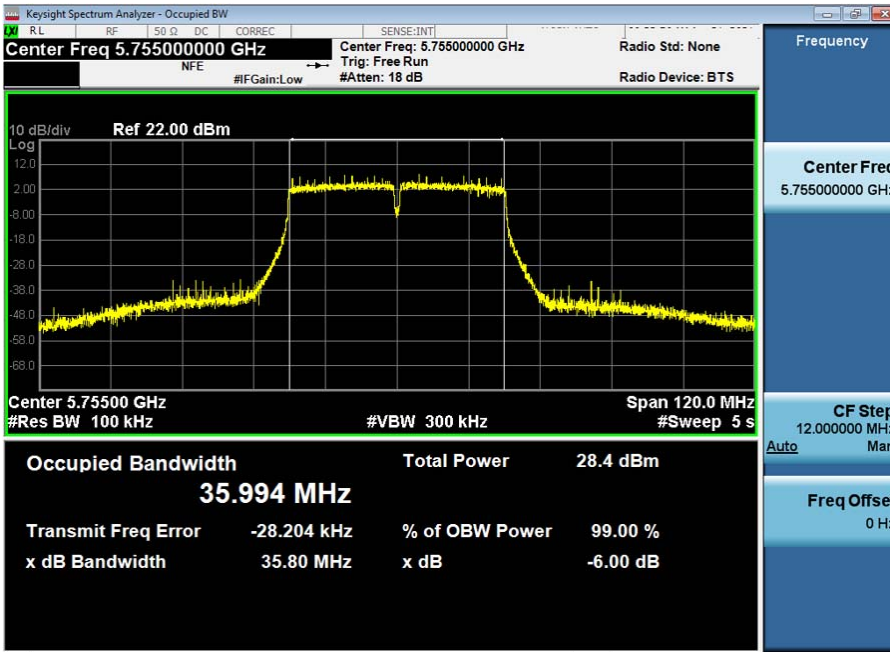

Antenna A

5775 MHz: HE80, M0 to M9 1ss

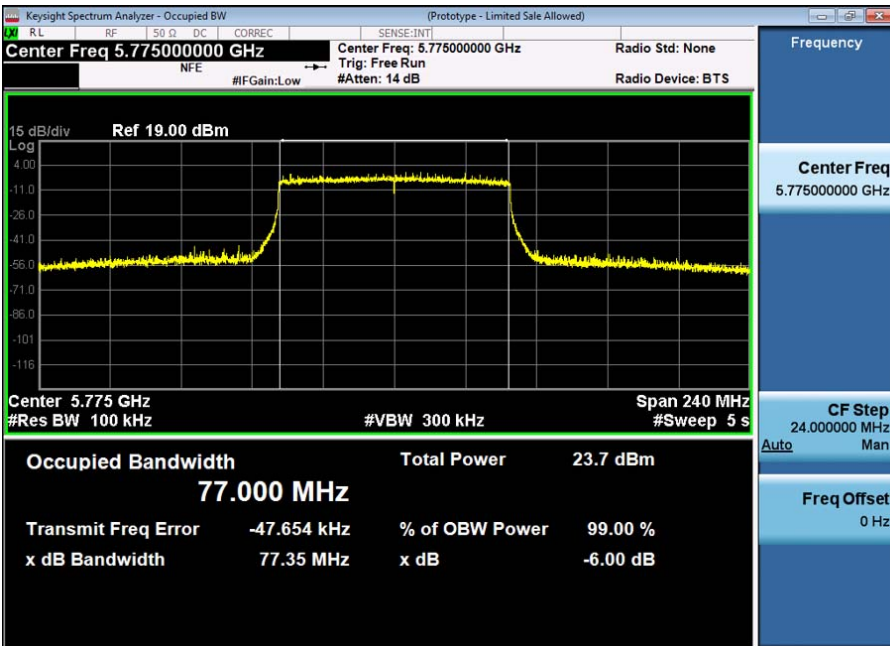

Antenna A

A.3: 99% and 26dB Bandwidth

99% and 26dB Bandwidth Test Requirement

There is no requirement for the value of bandwidth. However, the 26dB BW (EBW) is used to calculate the power limits in 15.407 (a) (2).

Power measurements are made using the 99% Bandwidth as the integration bandwidth.

Band-crossing emissions: For an emission that crosses the boundary between two adjacent U-NII bands, the boundary frequency between the bands serves as one edge for defining the portion of the EBW that falls within a particular U-NII band. □ However, the -26 dB points are measured relative to the highest point on the contiguous segment—regardless of which band contains that highest point (Figure4).

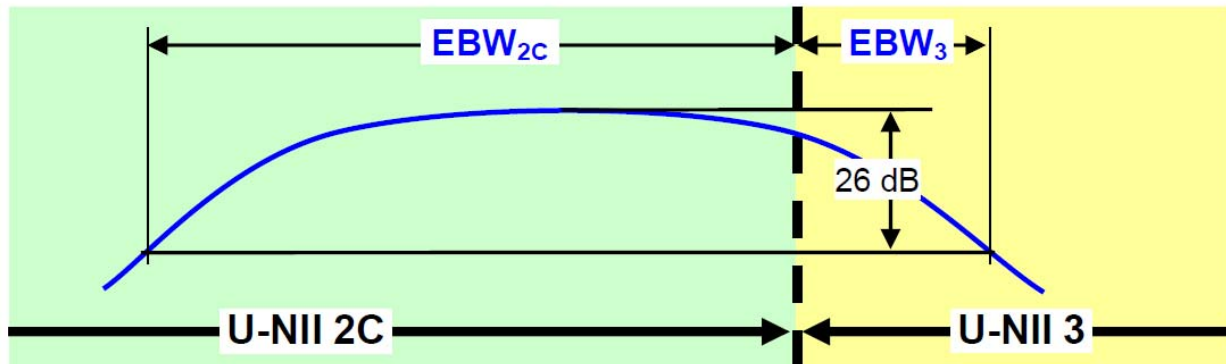

Figure 3. Emission Bandwidth (EBW) within a Band for Band-Crossing Signals

99% and 26dB Bandwidth Test Procedure

The 99-percent occupied bandwidth is the frequency bandwidth such that, below its lower and above its upper frequency limits, the mean powers are each equal to 0.5 % of the total mean power of the given emission. Measurement of the 99-percent occupied bandwidth is required only as a condition for using the optional band-edge measurement techniques described in section II.G.3.d). Measurements of 99-percent occupied bandwidth may also optionally be used in lieu of the EBW to define the minimum frequency range over which the spectrum is integrated when measuring maximum conducted output power as described in section II.E. However, the EBW must be measured to determine bandwidth dependent limits on maximum conducted output power in accordance with 15.407(a).

From KDB 789033 D02 General UNII Test Procedures New Rules v02r01

Section D. 99 Percent Occupied Bandwidth

99% BW Test Parameters
<ol style="list-style-type: none"> 1. Set center frequency to the nominal EUT channel center frequency. 2. Set span = 1.5 times to 5.0 times the OBW. 3. Set RBW = 1 % to 5 % of the OBW 4. Set VBW $\geq 3 \cdot$ RBW 5. Video averaging is not permitted. Where practical, a sample detection and single sweep mode shall be used. Otherwise, peak detection and max hold mode (until the trace stabilizes) shall be used. 6. Use the 99 % power bandwidth function of the instrument (if available).

From KDB 789033 D02 General UNII Test Procedures New Rules v02r01

Section C. Measurement Bandwidth, Section 1

26 BW Test parameters
X dB BW = -26dB (using the OBW function of the spectrum analyzer) Emission Bandwidth (EBW) a) Set RBW = approximately 1% of the emission bandwidth. b) Set the VBW > RBW. c) Detector = Peak. d) Trace mode = max hold. e) Measure the maximum width of the emission that is 26 dB down from the maximum of the emission. Compare this with the RBW setting of the analyzer. Readjust RBW and repeat measurement as needed until the RBW/EBW ratio is approximately 1%.

Tested By: Johanna Knudsen, Julian Land, Mathew Blackburn	Date of testing: 23-JUL-2021 to 26-JUL-2021; 28-JUL-2021 to 31-JUL-2021; 17-AUG-2021 to 27-AUG-2021; 30-AUG-2021 to 04-SEP-2021; 07-SEP-2021 to 08-SEP-2021
Test Result: PASS	

Test Equipment

See Appendix C for list of test equipment

99% and 26dB Bandwidth Table

Frequency (MHz)	Mode	Data Rate (Mbps)	26dB BW (MHz)	99% BW (MHz)
5690	Non HT80, 6 to 54 Mbps	6.0	5.0	3.935
	VHT80, M0 to M9 1ss	m0x1	5.3	4.006
	HE80, M0 to M9 1ss	m0h1	5.4	4.349
5710	Non HT40, 6 to 54 Mbps	6.0	4.8	3.628
	HT/VHT40, M0 to M7	m0	4.8	3.719
	HE40, M0 to M9 1ss	m0h1	5.5	4.253
5720	Non HT20, 6 to 54 Mbps	6.0	4.5	3.529
	HT/VHT20, M0 to M7	m0	5.2	4.139
	HE20, M0 to M9 1ss	m0h1	5.5	4.675
5745	Non HT20, 6 to 54 Mbps	6.0	19.2	16.336
	HT/VHT20, M0 to M7	m0	20.3	17.536
	HE20, M0 to M9 1ss	m0h1	21.2	18.905
5755	Non HT40, 6 to 54 Mbps	6.0	39.2	36.003
	HT/VHT40, M0 to M7	m0	39.4	35.939
	HE40, M0 to M9 1ss	m0h1	40.2	37.661
5775	Non HT80, 6 to 54 Mbps	6.0	79.8	75.439
	VHT80, M0 to M9 1ss	m0x1	79.5	75.289
	HE80, M0 to M9 1ss	m0h1	80.2	77.123
5785	Non HT20, 6 to 54 Mbps	6.0	19.1	16.331
	HT/VHT20, M0 to M7	m0	20.5	17.542
	HE20, M0 to M9 1ss	m0h1	21.2	18.91
5795	Non HT40, 6 to 54 Mbps	6.0	39.2	35.984
	HT/VHT40, M0 to M7	m0	39.4	35.974
	HE40, M0 to M9 1ss	m0h1	40.4	37.703
5825	Non HT20, 6 to 54 Mbps	6.0	19.1	16.328
	HT/VHT20, M0 to M7	m0	20.4	17.531
	HE20, M0 to M9 1ss	m0h1	21.1	18.898

Data Screenshots

5720 MHz: Non HT20, 6 to 54 Mbps



Antenna A

5710 MHz: Non HT40, 6 to 54 Mbps

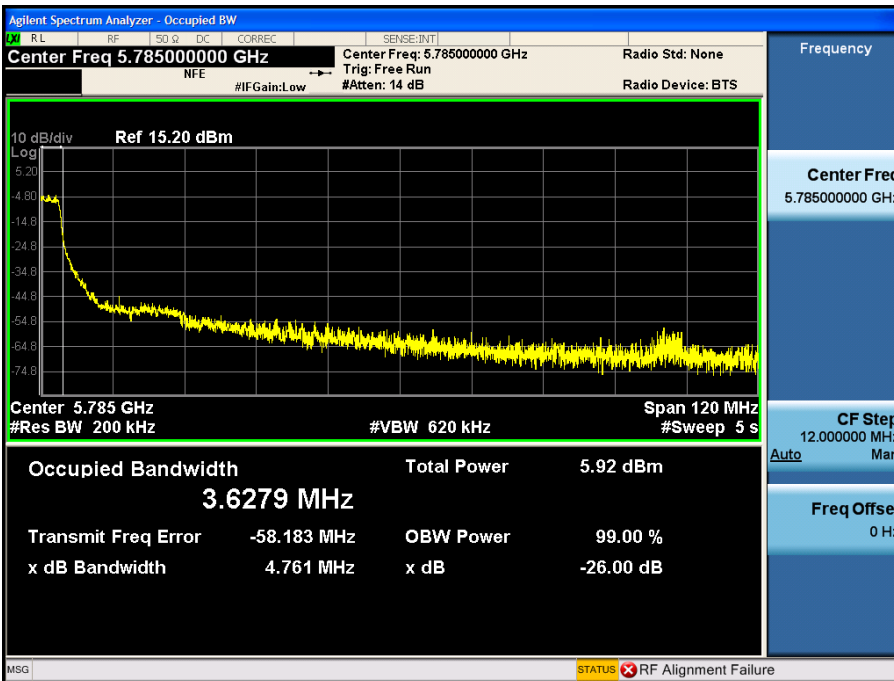

Antenna A

5710 MHz: HT/VHT40, M0 to M7

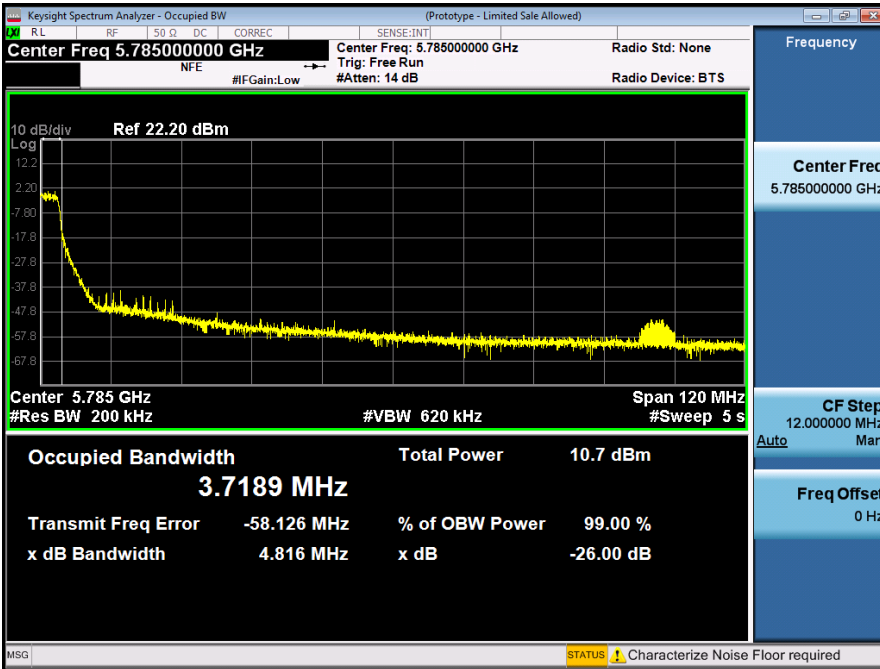

Antenna A

5745 MHz: Non HT20 Beam Forming, 6 to 54 Mbps

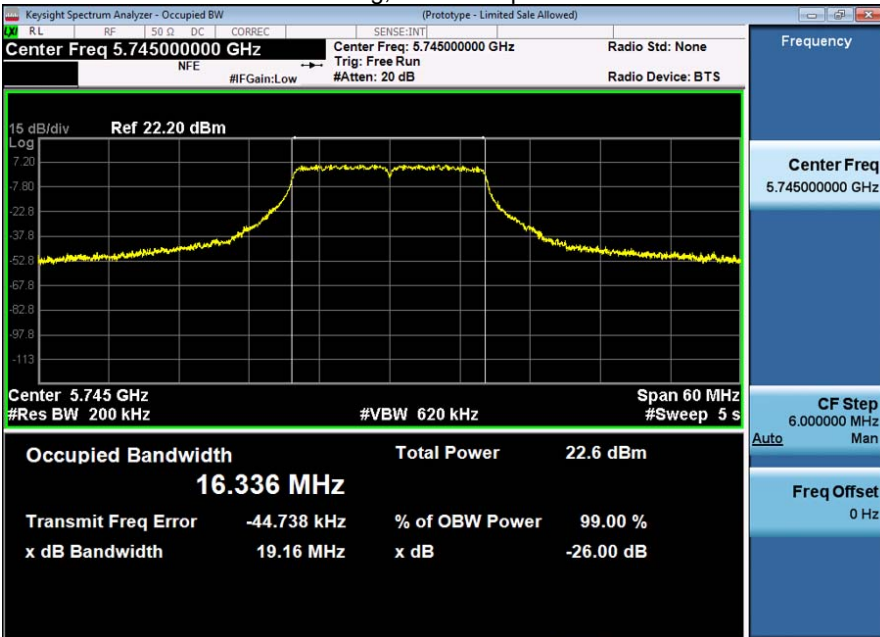

Antenna A

5755 MHz: HT/VHT40 Beam Forming, M0 to M7

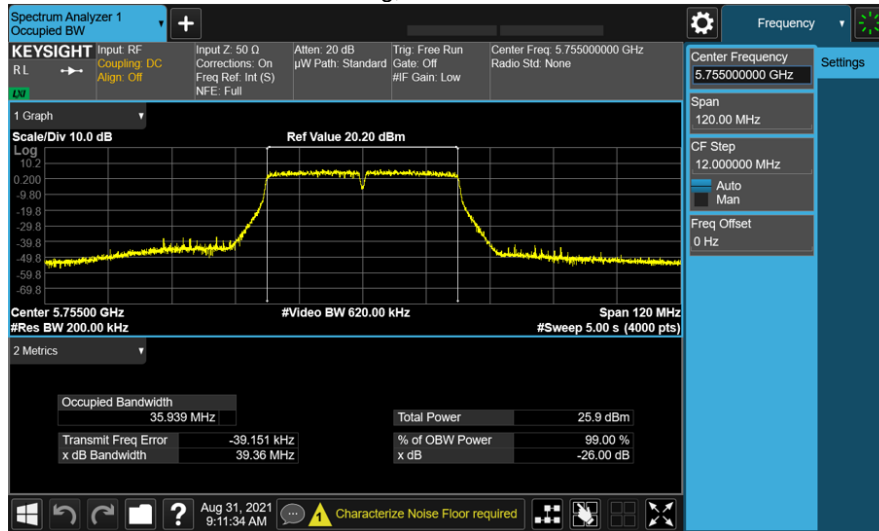

Antenna A

5775 MHz: HE80, M0 to M9 1ss

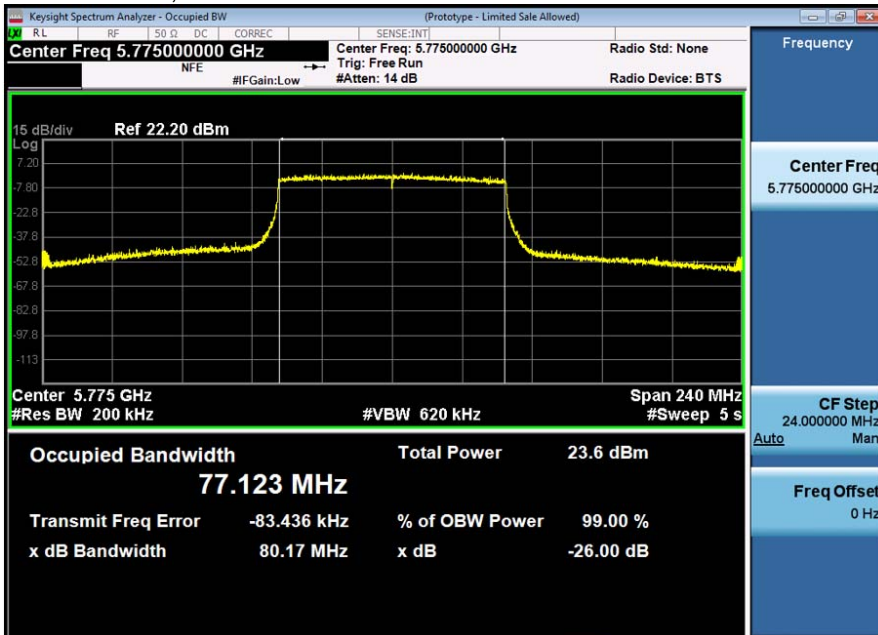

Antenna A

A.4: Maximum Conducted Output Power

Maximum Conducted Output Power Test Requirement

15.407 a) (3):

For the band 5.725-5.85 GHz, the maximum conducted output power over the frequency band of operation shall not exceed 1 W. If transmitting antennas of directional gain greater than 6 dBi are used, both the maximum conducted output power and the maximum power spectral density shall be reduced by the amount in dB that the directional gain of the antenna exceeds 6 dBi. However, fixed point-to-point U-NII devices operating in this band may employ transmitting antennas with directional gain greater than 6 dBi without any corresponding reduction in transmitter conducted power. Fixed, point-to-point operations exclude the use of point-to-multipoint systems, omnidirectional applications, and multiple collocated transmitters transmitting the same information. The operator of the U-NII device, or if the equipment is professionally installed, the installer, is responsible for ensuring that systems employing high gain directional antennas are used exclusively for fixed, point-to-point operations.

Band-Crossing Signals:

When measuring the portion of the maximum conducted output power within a single U-NII band, the power shall be integrated across only the portion of the EBW that falls within that band. That is, if an EBW extends across the boundary between two adjacent bands, the boundary frequency between the bands serves as one edge of the frequency range to be integrated. Integration across an entire U-NII band without regard to 26 dB points is also acceptable for determining conducted output power within that band.

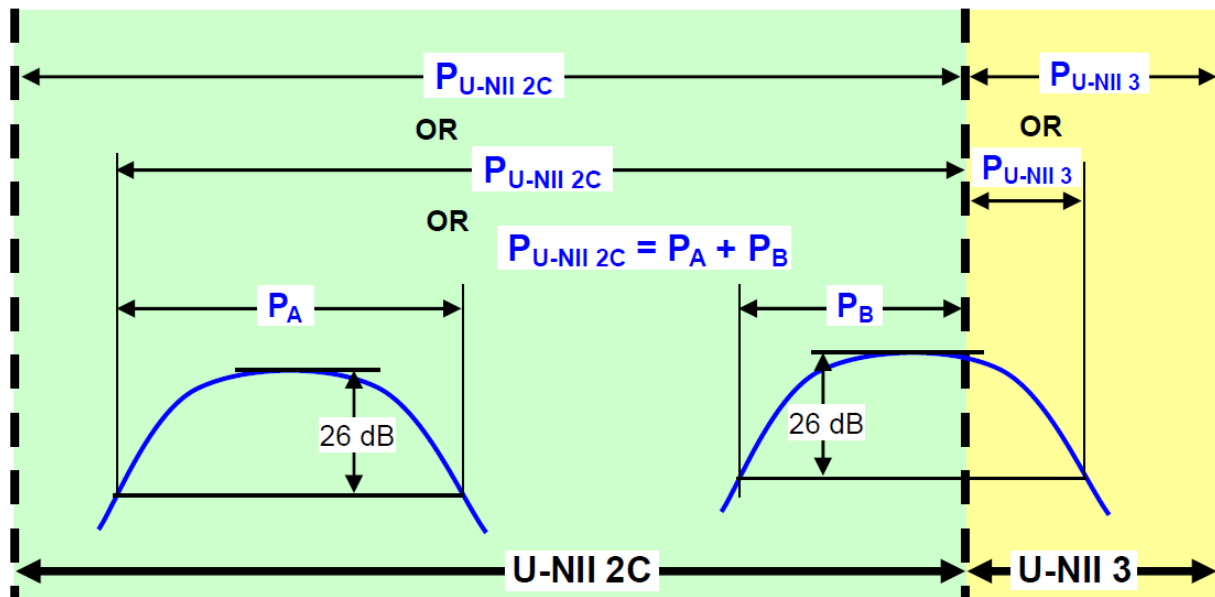

Conducted output power within a U-NII band: Integrate over the band or integrate over a span including the 26 dB EBWs of transmission segments within the band or integrate over 26 dB EBW of each transmission segment in the band and sum.

Figure 4. Conducted Output Power Measurement Examples

Maximum Conducted Output Power Test Procedure

Ref. KDB 789033 D02 General UNII Test Procedures New Rules v02r01
ANSI C63.10: 2013

Maximum Conducted Output Power Test Procedure
<ol style="list-style-type: none"> 1. Set the radio in the continuous transmitting mode at full power 2. Compute power by integrating the spectrum across the EBW (or alternatively entire 99% OBW) of the signal using the instrument's band power measurement function. The integration shall be performed using the spectrum analyzer band-power measurement function with band limits set equal to the EBW or the OBW band edges. 3. Capture graphs and record pertinent measurement data.

Ref. KDB 789033 D02 General UNII Test Procedures New Rules v02r01
2. Measurement using a Spectrum Analyzer or EMI Receiver (SA), (d) Method SA-2

Maximum Conducted Output Power Test parameters
<p>FCC, AUS/NZ, Taiwan, India: Method SA-2 (trace averaging across on and off times of the EUT transmissions, followed by duty cycle correction).</p> <ol style="list-style-type: none"> (i) Measure the duty cycle, x, of the transmitter output signal as described in section II.B. (ii) Set span to encompass the EBW (or, alternatively, the entire 99% occupied bandwidth) of the signal. (iii) Set RBW = 1 MHz. (iv) Set VBW \geq 3 MHz. (v) Number of points in sweep \geq 2 Span / RBW. (This ensures that bin-to-bin spacing is \leq RBW/2, so that narrowband signals are not lost between frequency bins.) (vi) Sweep time = auto. (vii) Detector = RMS (i.e., power averaging), if available. Otherwise, use sample detector mode. (viii) Do not use sweep triggering. Allow the sweep to "free run". (ix) Trace average at least 100 traces in power averaging (i.e., RMS) mode; however, the number of traces to be averaged shall be increased above 100 as needed to ensure that the average accurately represents the true average over the on and off periods of the transmitter. (x) Compute power by integrating the spectrum across the EBW (or, alternatively, the entire 99% occupied bandwidth) of the signal using the instrument's band power measurement function with band limits set equal to the EBW (or occupied bandwidth)

The "measure-and-sum technique" is used for measuring in-band transmit power of a device. In the measure-and-sum approach, the conducted emission level is measured at each antenna port. The measured results at the various antenna ports are then summed mathematically to determine the total emission level from the device. Summing is performed in linear power units. ANSI C63.10 section 14.3.2.2

Samples, Systems, and Modes

Tested By: Johanna Knudsen, Julian Land, Mathew Blackburn	Date of testing: 23-JUL-2021 to 26-JUL-2021; 28-JUL-2021 to 31-JUL-2021; 17-AUG-2021 to 27-AUG-2021; 30-AUG-2021 to 04-SEP-2021; 07-SEP-2021 to 08-SEP-2021
Test Result: PASS	

Test Equipment

See Appendix C for list of test equipment

Maximum Conducted Tables**Frequency 5690 MHz**

Mode	Tx Paths	Correlated Antenna Gain (dBi)	Tx 1 Max Power (dBm)	Tx 2 Max Power (dBm)	Duty Cycle (dB)	Total Tx Channel Power (dBm)	Limit (dBm)	Margin (dB)
Non HT80, 6 to 54 Mbps	1	14	-0.9		0.36	-0.5	22	22.5
Non HT80, 6 to 54 Mbps	2	14	-5.0	-1.8	0.36	0.2	22	21.76
VHT80, M0 to M9 1ss	1	14	-1.6		0.89	-0.7	22	22.75
VHT80, M0 to M9 1ss	2	14	-4.6	-1.3	0.89	1.3	22	20.71
VHT80, M0 to M9 2ss	2	14	-4.6	-1.3	0.89	1.3	22	20.71
VHT80 Beam Forming, M0 to M9 1ss	2	14	-4.6	-1.3	0.89	1.3	22	20.71
VHT80 Beam Forming, M0 to M9 2ss	2	14	-4.6	-1.3	0.89	1.3	22	20.71
VHT80 STBC, M0 to M9 1ss	2	14	-4.6	-1.3	0.89	1.3	22	20.71
HE80, M0 to M9 1ss	1	14	-0.1		0.23	0.1	22	21.87
HE80, M0 to M9 1ss	2	14	-4.4	-1.0	0.23	0.8	22	21.18
HE80, M0 to M9 2ss	2	14	-4.4	-1.0	0.23	0.8	22	21.18
HE80 Beam Forming, M0 to M9 1ss	2	14	-4.4	-1.0	0.23	0.8	22	21.18
HE80 Beam Forming, M0 to M9 2ss	2	14	-4.4	-1.0	0.23	0.8	22	21.18
HE80 STBC, M0 to M9 1ss	2	14	-4.4	-1.0	0.23	0.8	22	21.18

Frequency 5710 MHz

Mode	Tx Paths	Correlated Antenna Gain (dBi)	Tx 1 Max Power (dBm)	Tx 2 Max Power (dBm)	Duty Cycle (dB)	Total Tx Channel Power (dBm)	Limit (dBm)	Margin (dB)
Non HT40, 6 to 54 Mbps	1	14	4.6		0.32	5.0	22	17.04
Non HT40, 6 to 54 Mbps	2	14	-0.9	2.3	0.32	4.3	22	17.7
HT/VHT40, M0 to M7	1	14	3.9		0.33	4.3	22	17.75
HT/VHT40, M0 to M7	2	14	-1.3	1.6	0.33	3.7	22	18.26
HT/VHT40, M8 to M15	2	14	-1.3	1.6	0.33	3.7	22	18.26
HT/VHT40 Beam Forming, M0 to M7	2	14	-1.3	1.6	0.33	3.7	22	18.26
HT/VHT40 Beam Forming, M8 to M15	2	14	-1.3	1.6	0.33	3.7	22	18.26
HT/VHT40 STBC, M0 to M7	2	14	-1.3	1.6	0.33	3.7	22	18.26
HE40, M0 to M9 1ss	1	14	5.2		0.27	5.5	22	16.49
HE40, M0 to M9 1ss	2	14	-0.3	2.8	0.27	4.8	22	17.17
HE40, M0 to M9 2ss	2	14	-0.3	2.8	0.27	4.8	22	17.17
HE40 Beam Forming, M0 to M9 1ss	2	14	-0.3	2.8	0.27	4.8	22	17.17
HE40 Beam Forming, M0 to M9 2ss	2	14	-0.3	2.8	0.27	4.8	22	17.17
HE40 STBC, M0 to M9 2ss	2	14	-0.3	2.8	0.27	4.8	22	17.17

Frequency 5720 MHz

Mode	Tx Paths	Correlated Antenna Gain (dBi)	Tx 1 Max Power (dBm)	Tx 2 Max Power (dBm)	Duty Cycle (dB)	Total Tx Channel Power (dBm)	Limit (dBm)	Margin (dB)
Non HT20, 6 to 54 Mbps	1	14	5.5		0.5	6.0	22	15.98
HT/VHT20, M0 to M7	1	14	5.6		0.31	5.9	22	16.12
HT/VHT20, M0 to M7	2	14	1.2	4.1	0.31	6.2	22	15.78
HT/VHT20, M8 to M15	2	14	1.2	4.1	0.31	6.2	22	15.78
HT/VHT20 Beam Forming, M0 to M7	2	14	1.2	4.1	0.31	6.2	22	15.78
HT/VHT20 Beam Forming, M8 to M15	2	14	1.2	4.1	0.31	6.2	22	15.78
HT/VHT20 STBC, M0 to M7	2	14	1.2	4.1	0.31	6.2	22	15.78
HE20, M0 to M9 1ss	1	14	6.5		0.27	6.7	22	15.26
HE20, M0 to M9 1ss	2	14	1.8	4.9	0.27	6.9	22	15.09
HE20, M0 to M9 2ss	2	14	1.8	4.9	0.27	6.9	22	15.09
HE20 Beam Forming, M0 to M9 1ss	2	14	1.8	4.9	0.27	6.9	22	15.09
HE20 Beam Forming, M0 to M9 2ss	2	14	1.8	4.9	0.27	6.9	22	15.09
HE20 STBC, M0 to M9 2ss	2	14	1.8	4.9	0.27	6.9	22	15.09

Frequency 5745 MHz

Mode	Tx Paths	Correlated Antenna Gain (dBi)	Tx 1 Max Power (dBm)	Tx 2 Max Power (dBm)	Duty Cycle (dB)	Total Tx Channel Power (dBm)	Limit (dBm)	Margin (dB)
Non HT20, 6 to 54 Mbps	1	14	20.3		0.5	20.8	22	1.23
Non HT20, 6 to 54 Mbps	2	14	15.7	18.7	0.5	21.0	22	0.99
Non HT20 Beam Forming, 6 to 54 Mbps	2	14	15.7	18.7	0.5	21.0	22	0.99
HT/VHT20, M0 to M7	1	14	20.1		0.31	20.4	22	1.61
HT/VHT20, M0 to M7	2	14	15.5	18.5	0.31	20.6	22	1.42
HT/VHT20, M8 to M15	2	14	15.5	18.5	0.31	20.6	22	1.42
HT/VHT20 Beam Forming, M0 to M7	2	14	15.5	18.5	0.31	20.6	22	1.42
HT/VHT20 Beam Forming, M8 to M15	2	14	15.5	18.5	0.31	20.6	22	1.42
HT/VHT20 STBC, M0 to M7	2	14	15.5	18.5	0.31	20.6	22	1.42
HE20, M0 to M9 1ss	1	14	20.6		0.27	20.9	22	1.15
HE20, M0 to M9 1ss	2	14	16.0	19.0	0.27	21.0	22	0.96
HE20, M0 to M9 2ss	2	14	16.0	19.0	0.27	21.0	22	0.96
HE20 Beam Forming, M0 to M9 1ss	2	14	16.0	19.0	0.27	21.0	22	0.96
HE20 Beam Forming, M0 to M9 2ss	2	14	16.0	19.0	0.27	21.0	22	0.96
HE20 STBC, M0 to M9 2ss	2	14	16.0	19.0	0.27	21.0	22	0.96

Frequency 5755 MHz

Mode	Tx Paths	Correlated Antenna Gain (dBi)	Tx 1 Max Power (dBm)	Tx 2 Max Power (dBm)	Duty Cycle (dB)	Total Tx Channel Power (dBm)	Limit (dBm)	Margin (dB)
Non HT40, 6 to 54 Mbps	1	14	19.8		0.32	20.1	22	1.91
Non HT40, 6 to 54 Mbps	2	14	13.6	19.0	0.2	20.3	22	1.73
HT/VHT40, M0 to M7	1	14	20.2		0.33	20.5	22	1.52
HT/VHT40, M0 to M7	2	14	13.5	18.9	0.9	20.9	22	1.11
HT/VHT40, M8 to M15	2	14	13.5	18.9	0.9	20.9	22	1.11
HT/VHT40 Beam Forming, M0 to M7	2	14	13.5	18.9	0.9	20.9	22	1.11
HT/VHT40 Beam Forming, M8 to M15	2	14	13.5	18.9	0.9	20.9	22	1.11
HT/VHT40 STBC, M0 to M7	2	14	13.5	18.9	0.9	20.9	22	1.11
HE40, M0 to M9 1ss	1	14	20.7		0.27	20.9	22	1.07
HE40, M0 to M9 1ss	2	14	14.1	19.4	0.27	20.8	22	1.24
HE40, M0 to M9 2ss	2	14	14.1	19.4	0.27	20.8	22	1.24
HE40 Beam Forming, M0 to M9 1ss	2	14	14.1	19.4	0.27	20.8	22	1.24
HE40 Beam Forming, M0 to M9 2ss	2	14	14.1	19.4	0.27	20.8	22	1.24
HE40 STBC, M0 to M9 2ss	2	14	14.1	19.4	0.27	20.8	22	1.24

Frequency 5775 MHz

Mode	Tx Paths	Correlated Antenna Gain (dBi)	Tx 1 Max Power (dBm)	Tx 2 Max Power (dBm)	Duty Cycle (dB)	Total Tx Channel Power (dBm)	Limit (dBm)	Margin (dB)
Non HT80, 6 to 54 Mbps	1	14	18.9		0.36	19.3	22	2.71
Non HT80, 6 to 54 Mbps	2	14	13.2	18.7	0.21	20.0	22	1.99
VHT80, M0 to M9 1ss	1	14	18.8		0.89	19.7	22	2.3
VHT80, M0 to M9 1ss	2	14	15.1	18.1	0.89	20.8	22	1.24
VHT80, M0 to M9 2ss	2	14	15.1	18.1	0.89	20.8	22	1.24
VHT80 Beam Forming, M0 to M9 1ss	2	14	15.1	18.1	0.89	20.8	22	1.24
VHT80 Beam Forming, M0 to M9 2ss	2	14	15.1	18.1	0.89	20.8	22	1.24
VHT80 STBC, M0 to M9 1ss	2	14	15.1	18.1	0.89	20.8	22	1.24
HE80, M0 to M9 1ss	1	14	18.7		0.23	18.9	22	3.09
HE80, M0 to M9 1ss	2	14	15.7	18.9	0.23	20.8	22	1.17
HE80, M0 to M9 2ss	2	14	15.7	18.9	0.23	20.8	22	1.17
HE80 Beam Forming, M0 to M9 1ss	2	14	15.7	18.9	0.23	20.8	22	1.17
HE80 Beam Forming, M0 to M9 2ss	2	14	15.7	18.9	0.23	20.8	22	1.17
HE80 STBC, M0 to M9 1ss	2	14	15.7	18.9	0.23	20.8	22	1.17

Frequency 5785 MHz

Mode	Tx Paths	Correlated Antenna Gain (dBi)	Tx 1 Max Power (dBm)	Tx 2 Max Power (dBm)	Duty Cycle (dB)	Total Tx Channel Power (dBm)	Limit (dBm)	Margin (dB)
Non HT20, 6 to 54 Mbps	1	14	20.1		0.5	20.6	22	1.41
Non HT20, 6 to 54 Mbps	2	14	13.5	16.8	0.5	19.0	22	3.02
Non HT20 Beam Forming, 6 to 54 Mbps	2	14	13.5	16.8	0.5	19.0	22	3.02
HT/VHT20, M0 to M7	1	14	19.8		0.31	20.1	22	1.89
HT/VHT20, M0 to M7	2	14	13.1	16.6	0.31	18.5	22	3.5
HT/VHT20, M8 to M15	2	14	13.1	16.6	0.31	18.5	22	3.5
HT/VHT20 Beam Forming, M0 to M7	2	14	13.1	16.6	0.31	18.5	22	3.5
HT/VHT20 Beam Forming, M8 to M15	2	14	13.1	16.6	0.31	18.5	22	3.5
HT/VHT20 STBC, M0 to M7	2	14	13.1	16.6	0.31	18.5	22	3.5
HE20, M0 to M9 1ss	1	14	20.2		0.27	20.5	22	1.5
HE20, M0 to M9 1ss	2	14	15.6	20.1	0.27	21.7	22	0.31
HE20, M0 to M9 2ss	2	14	15.6	20.1	0.27	21.7	22	0.31
HE20 Beam Forming, M0 to M9 1ss	2	14	15.6	20.1	0.27	21.7	22	0.31
HE20 Beam Forming, M0 to M9 2ss	2	14	15.6	20.1	0.27	21.7	22	0.31
HE20 STBC, M0 to M9 2ss	2	14	15.6	20.1	0.27	21.7	22	0.31

Frequency 5795 MHz

Mode	Tx Paths	Correlated Antenna Gain (dBi)	Tx 1 Max Power (dBm)	Tx 2 Max Power (dBm)	Duty Cycle (dB)	Total Tx Channel Power (dBm)	Limit (dBm)	Margin (dB)
Non HT40, 6 to 54 Mbps	1	14	19.5		0.32	19.8	22	2.21
Non HT40, 6 to 54 Mbps	2	14	13.2	16.6	0.32	18.6	22	3.41
HT/VHT40, M0 to M7	1	14	19.9		0.33	20.2	22	1.79
HT/VHT40, M0 to M7	2	14	15.0	18.4	0.33	20.4	22	1.64
HT/VHT40, M8 to M15	2	14	15.0	18.4	0.33	20.4	22	1.64
HT/VHT40 Beam Forming, M0 to M7	2	14	15.0	18.4	0.33	20.4	22	1.64
HT/VHT40 Beam Forming, M8 to M15	2	14	15.0	18.4	0.33	20.4	22	1.64
HT/VHT40 STBC, M0 to M7	2	14	15.0	18.4	0.33	20.4	22	1.64
HE40, M0 to M9 1ss	1	14	20.3		0.27	20.6	22	1.38
HE40, M0 to M9 1ss	2	14	15.5	20.1	0.27	21.7	22	0.34
HE40, M0 to M9 2ss	2	14	15.5	20.1	0.27	21.7	22	0.34
HE40 Beam Forming, M0 to M9 1ss	2	14	15.5	20.1	0.27	21.7	22	0.34
HE40 Beam Forming, M0 to M9 2ss	2	14	15.5	20.1	0.27	21.7	22	0.34
HE40 STBC, M0 to M9 2ss	2	14	15.5	20.1	0.27	21.7	22	0.34

Frequency 5825 MHz

Mode	Tx Paths	Correlated Antenna Gain (dBi)	Tx 1 Max Power (dBm)	Tx 2 Max Power (dBm)	Duty Cycle (dB)	Total Tx Channel Power (dBm)	Limit (dBm)	Margin (dB)
Non HT20, 6 to 54 Mbps	1	14	20.0		0.5	20.5	22	1.52
Non HT20, 6 to 54 Mbps	2	14	15.4	18.5	0.5	20.7	22	1.29
Non HT20 Beam Forming, 6 to 54 Mbps	2	14	15.4	18.5	0.5	20.7	22	1.29
HT/VHT20, M0 to M7	1	14	19.8		0.31	20.1	22	1.86
HT/VHT20, M0 to M7	2	14	15.1	18.2	0.31	20.2	22	1.78
HT/VHT20, M8 to M15	2	14	15.1	18.2	0.31	20.2	22	1.78
HT/VHT20 Beam Forming, M0 to M7	2	14	15.1	18.2	0.31	20.2	22	1.78
HT/VHT20 Beam Forming, M8 to M15	2	14	15.1	18.2	0.31	20.2	22	1.78
HT/VHT20 STBC, M0 to M7	2	14	15.1	18.2	0.31	20.2	22	1.78
HE20, M0 to M9 1ss	1	14	20.2		0.27	20.5	22	1.48
HE20, M0 to M9 1ss	2	14	15.5	18.8	0.27	20.8	22	1.22
HE20, M0 to M9 2ss	2	14	15.5	18.8	0.27	20.8	22	1.22
HE20 Beam Forming, M0 to M9 1ss	2	14	15.5	18.8	0.27	20.8	22	1.22
HE20 Beam Forming, M0 to M9 2ss	2	14	15.5	18.8	0.27	20.8	22	1.22
HE20 STBC, M0 to M9 2ss	2	14	15.5	18.8	0.27	20.8	22	1.22

Data Screenshots

5785 MHz: HE20, M0 to M9 1ss

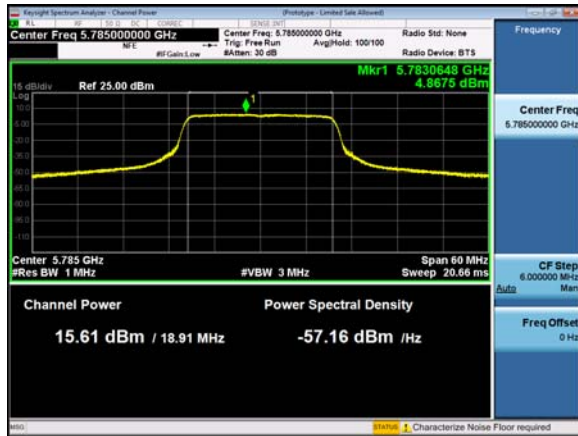

Antenna A

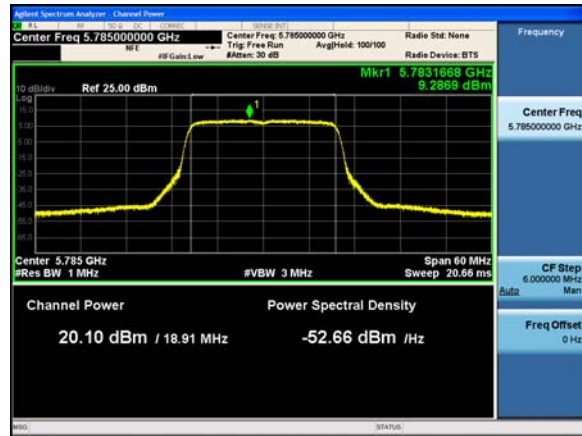

Antenna B

5785 MHz: HE20, M0 to M9 2ss

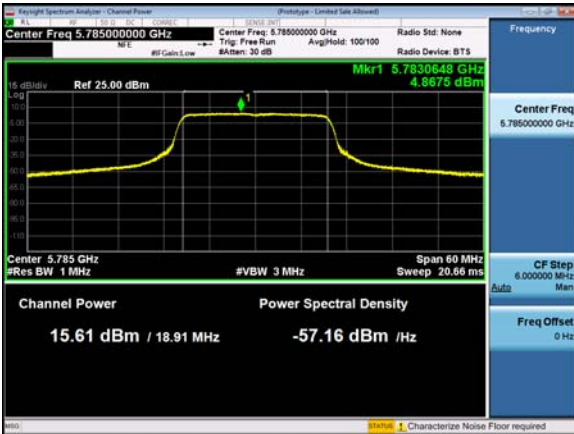

Antenna A

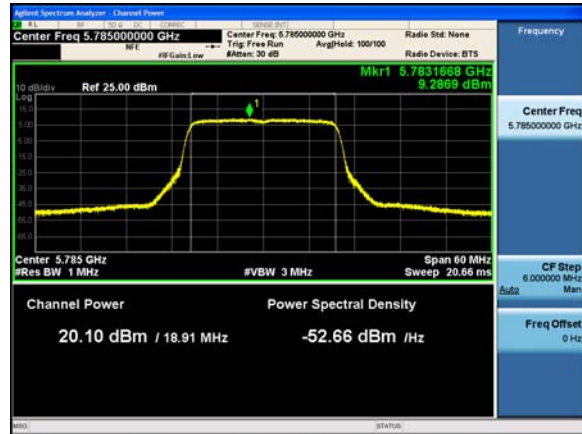

Antenna B

5785 MHz: HE20 Beam Forming, M0 to M9 1ss

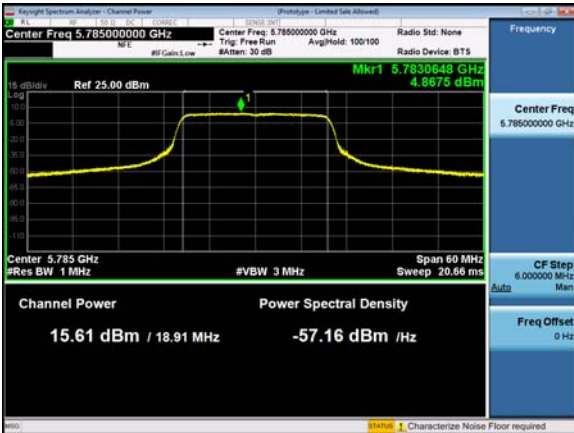

Antenna A

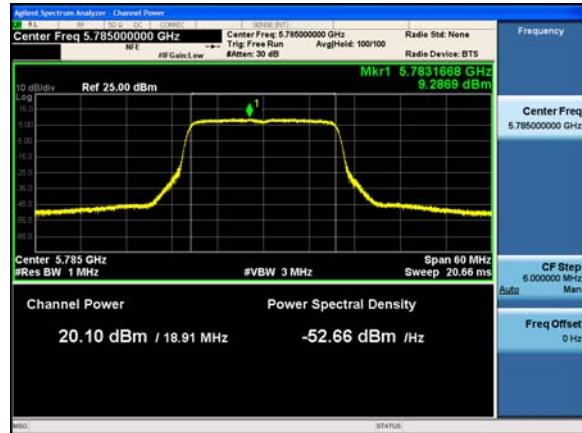

Antenna B

A.5: Power Spectral Density

Power Spectral Density Test Requirement

15.407:

(3) For the band 5.725-5.85 GHz...the maximum power spectral density shall not exceed 30 dBm in any 500-kHz band. If transmitting antennas of directional gain greater than 6 dBi are used, both the maximum conducted output power and the maximum power spectral density shall be reduced by the amount in dB that the directional gain of the antenna exceeds 6 dBi. However, fixed point-to-point U-NII devices operating in this band may employ transmitting antennas with directional gain greater than 6 dBi without any corresponding reduction in transmitter conducted power. Fixed, point-to-point operations exclude the use of point-to-multipoint systems, omnidirectional applications, and multiple collocated transmitters transmitting the same information. The operator of the U-NII device, or if the equipment is professionally installed, the installer, is responsible for ensuring that systems employing high gain directional antennas are used exclusively for fixed, point-to-point operations.

(5) The maximum power spectral density is measured as a conducted emission by direct connection of a calibrated test instrument to the equipment under test. If the device cannot be connected directly, alternative techniques acceptable to the Commission may be used. Measurements in the 5.725-5.85 GHz band are made over a reference bandwidth of 500 kHz or the 26 dB emission bandwidth of the device, whichever is less. Measurements in the 5.15-5.25 GHz, 5.25-5.35 GHz, and the 5.47-5.725 GHz bands are made over a bandwidth of 1 MHz or the 26 dB emission bandwidth of the device, whichever is less. A narrower resolution bandwidth can be used, provided that the measured power is integrated over the full reference bandwidth.

Band-Crossing Signals:

When measuring the portion of the maximum conducted output power within a single U-NII band, the power shall be integrated across only the portion of the EBW that falls within that band. That is, if an EBW extends across the boundary between two adjacent bands, the boundary frequency between the bands serves as one edge of the frequency range to be integrated. Integration across an entire U-NII band without regard to 26 dB points is also acceptable for determining conducted output power within that band.

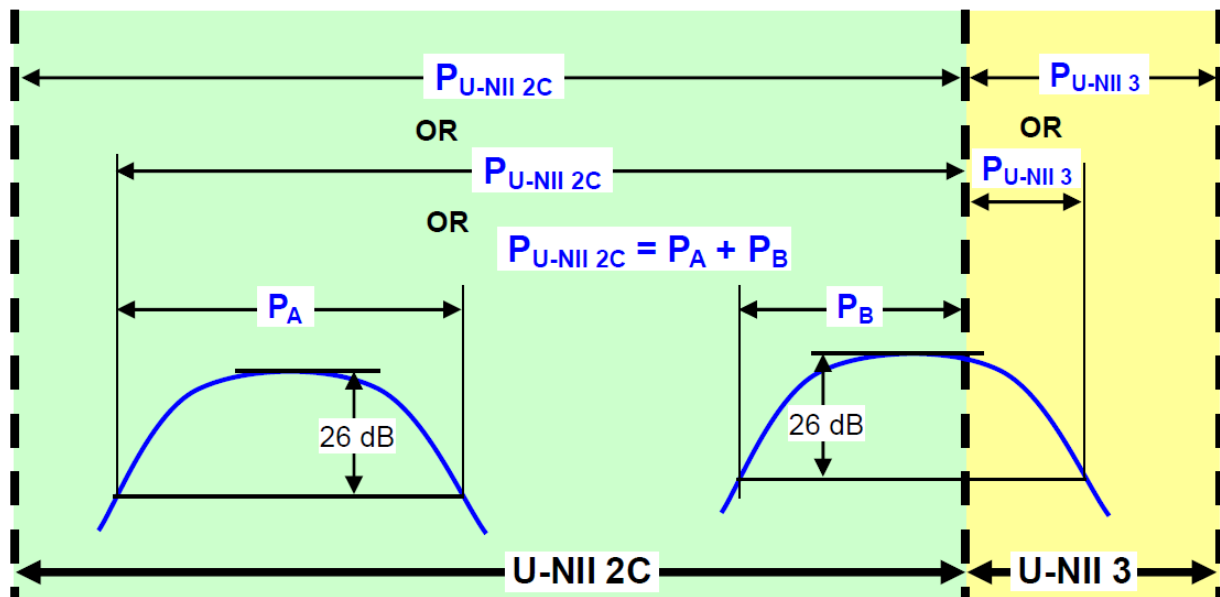

Conducted output power within a U-NII band: Integrate over the band or integrate over a span including the 26 dB EBWs of transmission segments within the band or integrate over 26 dB EBW of each transmission segment in the band and sum.

Figure 4. Conducted Output Power Measurement Examples

Power Spectral Density Test Procedure

Ref. KDB 789033 D02 General UNII Test Procedures New Rules v02r01

F. Maximum Power Spectral Density (PSD)

ANSI C63.10:2013

**Power Spectral Density
Test Procedure**

The rules requires “maximum power spectral density” measurements where the intent is to measure the maximum value of the time average of the power spectral density measured during a period of continuous transmission.

1. Create an average power spectrum for the EUT operating mode being tested by following the instructions in section II.E.2. for measuring maximum conducted output power using a spectrum analyzer or EMI receiver: select the appropriate test method (SA-1, SA-2, SA-3, or alternatives to each) and apply it up to, but not including, the step labeled, “Compute power...”. (This procedure is required even if the maximum conducted output power measurement was performed using a power meter, method PM.)

2. Use the peak search function on the instrument to find the peak of the spectrum and record its value.

3. Make the following adjustments to the peak value of the spectrum, if applicable: a) If Method SA-2 or SA-2 Alternative was used, add $10 \log(1/x)$, where x is the duty cycle, to the peak of the spectrum.

b) If Method SA-3 Alternative was used and the linear mode was used in step II.E.2.g)(viii), add 1 dB to the final result to compensate for the difference between linear averaging and power averaging.

4. The result is the Maximum PSD over 1 MHz reference bandwidth.

5. For devices operating in the bands 5.15-5.25 GHz, 5.25-5.35 GHz, and 5.47-5.725 GHz, the above procedures make use of 1 MHz RBW to satisfy directly the 1 MHz reference bandwidth specified in § 15.407(a)(5). **For devices operating in the band 5.725-5.85 GHz, the rules specify a measurement bandwidth of 500 kHz.**

Ref. KDB 789033 D02 General UNII Test Procedures New Rules v02r01

2. Measurement using a Spectrum Analyzer or EMI Receiver (SA), (d) Method SA-2

<p>Power Spectral Density Test parameters</p> <p>Method SA-2 (trace averaging across on and off times of the EUT transmissions, followed by duty cycle correction).</p> <p>(i) Measure the duty cycle, x, of the transmitter output signal as described in section II.B.</p> <p>(ii) Set span to encompass the EBW (or, alternatively, the entire 99% occupied bandwidth) of the signal.</p> <p>(iii) Set RBW = 1 MHz. (this should be 500kHz per KDB789033, Section F, (5))</p> <p>(iv) Set VBW \geq 3 MHz.</p> <p>(v) Number of points in sweep \geq 2 Span / RBW. (This ensures that bin-to-bin spacing is \leq RBW/2, so that narrowband signals are not lost between frequency bins.)</p> <p>(vi) Sweep time = auto.</p> <p>(vii) Detector = RMS (i.e., power averaging), if available. Otherwise, use sample detector mode.</p> <p>(viii) Do not use sweep triggering. Allow the sweep to “free run”.</p> <p>(ix) Trace average at least 100 traces in power averaging (i.e., RMS) mode; however, the number of traces to be averaged shall be increased above 100 as needed to ensure that the average accurately represents the true average over the on and off periods of the transmitter.</p> <p>(x) Compute power by integrating the spectrum across the EBW (or, alternatively, the entire 99% occupied bandwidth) of the signal using the instrument’s band power measurement function with band limits set equal to the EBW (or occupied bandwidth)</p> <p>F. Maximum Power Spectral Density (PSD)</p> <p>2. Use the peak search function on the instrument to find the peak of the spectrum and record its value.</p> <p>3. Make the following adjustments to the peak value of the spectrum, if applicable: a) If Method SA-2 or SA-2 Alternative was used, add $10 \log(1/x)$, where x is the duty cycle, to the peak of the spectrum.</p> <p>5. ... For devices operating in the band 5.725-5.85 GHz, the rules specify a measurement bandwidth of 500 kHz.</p>
--

The “measure-and-sum technique” is used for measuring in-band transmit power of a device. In the measure-and-sum approach, the conducted emission level is measured at each antenna port. The measured results at the various antenna ports are then summed mathematically to determine the total emission level from the device. Summing is performed in linear power units. ANSI C63.10 section 14.3.2.2

<p>Tested By: Johanna Knudsen, Julian Land, Mathew Blackburn</p>	<p>Date of testing: 23-JUL-2021 to 26-JUL-2021; 28-JUL-2021 to 31-JUL-2021; 17-AUG-2021 to 27-AUG-2021; 30-AUG-2021 to 04-SEP-2021; 07-SEP-2021 to 08-SEP-2021</p>
<p>Test Result: PASS</p>	

Test Equipment

See Appendix C for list of test equipment

Power Spectral Density Tables

Frequency 5690 MHz

Mode	Tx Paths	Correlated Antenna Gain (dBi)	Tx 1 PSD (dBm/500 kHz)	Tx 2 PSD (dBm/500 kHz)	Duty Cycle (dB)	Total PSD (dBm/500 kHz)	Limit (dBm/500 kHz)	Margin (dB)
Non HT80, 6 to 54 Mbps	1	14	-7.8		0.36	-7.4	22	29.39
Non HT80, 6 to 54 Mbps	2	14	-12.2	-9.1	0.36	-7.0	22	29.04
VHT80, M0 to M9 1ss	1	14	-8.4		0.89	-7.5	22	29.53
VHT80, M0 to M9 1ss	2	14	-12.0	-8.8	0.89	-6.2	22	28.19
VHT80, M0 to M9 2ss	2	14	-12.0	-8.8	0.89	-6.2	22	28.19
VHT80 Beam Forming, M0 to M9 1ss	2	14	-12.0	-8.8	0.89	-6.2	22	28.19
VHT80 Beam Forming, M0 to M9 2ss	2	14	-12.0	-8.8	0.89	-6.2	22	28.19
VHT80 STBC, M0 to M9 1ss	2	14	-12.0	-8.8	0.89	-6.2	22	28.19
HE80, M0 to M9 1ss	1	14	-8.0		0.23	-7.8	22	29.8
HE80, M0 to M9 1ss	2	14	-12.4	-9.3	0.23	-7.3	22	29.35
HE80, M0 to M9 2ss	2	14	-12.4	-9.3	0.23	-7.3	22	29.35
HE80 Beam Forming, M0 to M9 1ss	2	14	-12.4	-9.3	0.23	-7.3	22	29.35
HE80 Beam Forming, M0 to M9 2ss	2	14	-12.4	-9.3	0.23	-7.3	22	29.35
HE80 STBC, M0 to M9 1ss	2	14	-12.4	-9.3	0.23	-7.3	22	29.35

Frequency 5710 MHz

Mode	Tx Paths	Correlated Antenna Gain (dBi)	Tx 1 PSD (dBm/500 kHz)	Tx 2 PSD (dBm/500 kHz)	Duty Cycle (dB)	Total PSD (dBm/500 kHz)	Limit (dBm/500 kHz)	Margin (dB)
Non HT40, 6 to 54 Mbps	1	14	-1.6		0.32	-1.3	22	23.32
Non HT40, 6 to 54 Mbps	2	14	-8.3	-4.8	0.32	-2.9	22	24.86
HT/VHT40, M0 to M7	1	14	-2.8		0.33	-2.5	22	24.5
HT/VHT40, M0 to M7	2	14	-8.6	-5.6	0.33	-3.5	22	25.49
HT/VHT40, M8 to M15	2	14	-8.6	-5.6	0.33	-3.5	22	25.49
HT/VHT40 Beam Forming, M0 to M7	2	14	-8.6	-5.6	0.33	-3.5	22	25.49
HT/VHT40 Beam Forming, M8 to M15	2	14	-8.6	-5.6	0.33	-3.5	22	25.49
HT/VHT40 STBC, M0 to M7	2	14	-8.6	-5.6	0.33	-3.5	22	25.49
HE40, M0 to M9 1ss	1	14	-2.0		0.27	-1.8	22	23.77
HE40, M0 to M9 1ss	2	14	-7.9	-5.1	0.27	-3.0	22	25.04
HE40, M0 to M9 2ss	2	14	-7.9	-5.1	0.27	-3.0	22	25.04
HE40 Beam Forming, M0 to M9 1ss	2	14	-7.9	-5.1	0.27	-3.0	22	25.04
HE40 Beam Forming, M0 to M9 2ss	2	14	-7.9	-5.1	0.27	-3.0	22	25.04
HE40 STBC, M0 to M9 2ss	2	14	-7.9	-5.1	0.27	-3.0	22	25.04

Frequency 5720 MHz

Mode	Tx Paths	Correlated Antenna Gain (dBi)	Tx 1 PSD (dBm/500 kHz)	Tx 2 PSD (dBm/500 kHz)	Duty Cycle (dB)	Total PSD (dBm/500 kHz)	Limit (dBm/500 kHz)	Margin (dB)
Non HT20, 6 to 54 Mbps	1	14	-0.8		0.5	-0.3	22	22.25
HT/VHT20, M0 to M7	1	14	-1.1		0.31	-0.8	22	22.84
HT/VHT20, M0 to M7	2	14	-6.5	-3.7	0.31	-1.6	22	23.58
HT/VHT20, M8 to M15	2	14	-6.5	-3.7	0.31	-1.6	22	23.58
HT/VHT20 Beam Forming, M0 to M7	2	14	-6.5	-3.7	0.31	-1.6	22	23.58
HT/VHT20 Beam Forming, M8 to M15	2	14	-6.5	-3.7	0.31	-1.6	22	23.58
HT/VHT20 STBC, M0 to M7	2	14	-6.5	-3.7	0.31	-1.6	22	23.58
HE20, M0 to M9 1ss	1	14	-1.2		0.27	-1.0	22	22.97
HE20, M0 to M9 1ss	2	14	-6.6	-3.0	0.27	-1.2	22	23.19
HE20, M0 to M9 2ss	2	14	-6.6	-3.0	0.27	-1.2	22	23.19
HE20 Beam Forming, M0 to M9 1ss	2	14	-6.6	-3.0	0.27	-1.2	22	23.19
HE20 Beam Forming, M0 to M9 2ss	2	14	-6.6	-3.0	0.27	-1.2	22	23.19
HE20 STBC, M0 to M9 2ss	2	14	-6.6	-3.0	0.27	-1.2	22	23.19

Frequency 5745 MHz

Mode	Tx Paths	Correlated Antenna Gain (dBi)	Tx 1 PSD (dBm/500 kHz)	Tx 2 PSD (dBm/500 kHz)	Duty Cycle (dB)	Total PSD (dBm/500 kHz)	Limit (dBm/500 kHz)	Margin (dB)
Non HT20, 6 to 54 Mbps	1	14	7.3		0.5	7.9	22	14.15
Non HT20, 6 to 54 Mbps	2	14	2.7	5.9	0.5	8.1	22	13.91
Non HT20 Beam Forming, 6 to 54 Mbps	2	14	2.7	5.9	0.5	8.1	22	13.91
HT/VHT20, M0 to M7	1	14	7.0		0.31	7.3	22	14.7
HT/VHT20, M0 to M7	2	14	2.7	5.2	0.31	7.4	22	14.55
HT/VHT20, M8 to M15	2	14	2.7	5.2	0.31	7.4	22	14.55
HT/VHT20 Beam Forming, M0 to M7	2	14	2.7	5.2	0.31	7.4	22	14.55
HT/VHT20 Beam Forming, M8 to M15	2	14	2.7	5.2	0.31	7.4	22	14.55
HT/VHT20 STBC, M0 to M7	2	14	2.7	5.2	0.31	7.4	22	14.55
HE20, M0 to M9 1ss	1	14	7.2		0.27	7.4	22	14.56
HE20, M0 to M9 1ss	2	14	2.3	5.4	0.27	7.4	22	14.62
HE20, M0 to M9 2ss	2	14	2.3	5.4	0.27	7.4	22	14.62
HE20 Beam Forming, M0 to M9 1ss	2	14	2.3	5.4	0.27	7.4	22	14.62
HE20 Beam Forming, M0 to M9 2ss	2	14	2.3	5.4	0.27	7.4	22	14.62
HE20 STBC, M0 to M9 2ss	2	14	2.3	5.4	0.27	7.4	22	14.62

Frequency 5755 MHz

Mode	Tx Paths	Correlated Antenna Gain (dBi)	Tx 1 PSD (dBm/500 kHz)	Tx 2 PSD (dBm/500 kHz)	Duty Cycle (dB)	Total PSD (dBm/500 kHz)	Limit (dBm/500 kHz)	Margin (dB)
Non HT40, 6 to 54 Mbps	1	14	3.8		0.32	4.2	22	17.84
Non HT40, 6 to 54 Mbps	2	14	-2.2	2.9	0.2	4.2	22	17.76
HT/VHT40, M0 to M7	1	14	2.7		0.33	3.0	22	18.96
HT/VHT40, M0 to M7	2	14	-2.6	2.2	0.9	4.3	22	17.68
HT/VHT40, M8 to M15	2	14	-2.6	2.2	0.9	4.3	22	17.68
HT/VHT40 Beam Forming, M0 to M7	2	14	-2.6	2.2	0.9	4.3	22	17.68
HT/VHT40 Beam Forming, M8 to M15	2	14	-2.6	2.2	0.9	4.3	22	17.68
HT/VHT40 STBC, M0 to M7	2	14	-2.6	2.2	0.9	4.3	22	17.68
HE40, M0 to M9 1ss	1	14	4.0		0.27	4.3	22	17.71
HE40, M0 to M9 1ss	2	14	-2.5	2.7	0.27	4.2	22	17.85
HE40, M0 to M9 2ss	2	14	-2.5	2.7	0.27	4.2	22	17.85
HE40 Beam Forming, M0 to M9 1ss	2	14	-2.5	2.7	0.27	4.2	22	17.85
HE40 Beam Forming, M0 to M9 2ss	2	14	-2.5	2.7	0.27	4.2	22	17.85
HE40 STBC, M0 to M9 2ss	2	14	-2.5	2.7	0.27	4.2	22	17.85

Frequency 5775 MHz

Mode	Tx Paths	Correlated Antenna Gain (dBi)	Tx 1 PSD (dBm/500 kHz)	Tx 2 PSD (dBm/500 kHz)	Duty Cycle (dB)	Total PSD (dBm/500 kHz)	Limit (dBm/500 kHz)	Margin (dB)
Non HT80, 6 to 54 Mbps	1	14	0.4		0.36	0.7	22	21.29
Non HT80, 6 to 54 Mbps	2	14	-5.5	-0.1	0.21	1.2	22	20.82
VHT80, M0 to M9 1ss	1	14	-1.0		0.89	-0.1	22	22.15
VHT80, M0 to M9 1ss	2	14	-4.4	-1.4	0.89	1.3	22	20.74
VHT80, M0 to M9 2ss	2	14	-4.4	-1.4	0.89	1.3	22	20.74
VHT80 Beam Forming, M0 to M9 1ss	2	14	-4.4	-1.4	0.89	1.3	22	20.74
VHT80 Beam Forming, M0 to M9 2ss	2	14	-4.4	-1.4	0.89	1.3	22	20.74
VHT80 STBC, M0 to M9 1ss	2	14	-4.4	-1.4	0.89	1.3	22	20.74
HE80, M0 to M9 1ss	1	14	-0.5		0.23	-0.3	22	22.32
HE80, M0 to M9 1ss	2	14	-3.6	-0.7	0.23	1.3	22	20.7
HE80, M0 to M9 2ss	2	14	-3.6	-0.7	0.23	1.3	22	20.7
HE80 Beam Forming, M0 to M9 1ss	2	14	-3.6	-0.7	0.23	1.3	22	20.7
HE80 Beam Forming, M0 to M9 2ss	2	14	-3.6	-0.7	0.23	1.3	22	20.7
HE80 STBC, M0 to M9 1ss	2	14	-3.6	-0.7	0.23	1.3	22	20.7

Frequency 5785 MHz

Mode	Tx Paths	Correlated Antenna Gain (dBi)	Tx 1 PSD (dBm/500 kHz)	Tx 2 PSD (dBm/500 kHz)	Duty Cycle (dB)	Total PSD (dBm/500 kHz)	Limit (dBm/500 kHz)	Margin (dB)
Non HT20, 6 to 54 Mbps	1	14	7.1		0.5	7.6	22	14.35
Non HT20, 6 to 54 Mbps	2	14	0.6	4.3	0.5	6.3	22	15.68
Non HT20 Beam Forming, 6 to 54 Mbps	2	14	0.6	4.3	0.5	6.3	22	15.68
HT/VHT20, M0 to M7	1	14	6.4		0.31	6.7	22	15.29
HT/VHT20, M0 to M7	2	14	-0.1	3.4	0.31	5.3	22	16.67
HT/VHT20, M8 to M15	2	14	-0.1	3.4	0.31	5.3	22	16.67
HT/VHT20 Beam Forming, M0 to M7	2	14	-0.1	3.4	0.31	5.3	22	16.67
HT/VHT20 Beam Forming, M8 to M15	2	14	-0.1	3.4	0.31	5.3	22	16.67
HT/VHT20 STBC, M0 to M7	2	14	-0.1	3.4	0.31	5.3	22	16.67
HE20, M0 to M9 1ss	1	14	6.9		0.27	7.1	22	14.88
HE20, M0 to M9 1ss	2	14	2.1	6.2	0.27	7.9	22	14.13
HE20, M0 to M9 2ss	2	14	2.1	6.2	0.27	7.9	22	14.13
HE20 Beam Forming, M0 to M9 1ss	2	14	2.1	6.2	0.27	7.9	22	14.13
HE20 Beam Forming, M0 to M9 2ss	2	14	2.1	6.2	0.27	7.9	22	14.13
HE20 STBC, M0 to M9 2ss	2	14	2.1	6.2	0.27	7.9	22	14.13

Frequency 5795 MHz

Mode	Tx Paths	Correlated Antenna Gain (dBi)	Tx 1 PSD (dBm/500 kHz)	Tx 2 PSD (dBm/500 kHz)	Duty Cycle (dB)	Total PSD (dBm/500 kHz)	Limit (dBm/500 kHz)	Margin (dB)
Non HT40, 6 to 54 Mbps	1	14	3.6		0.32	3.9	22	18.09
Non HT40, 6 to 54 Mbps	2	14	-2.8	1.0	0.32	2.8	22	19.17
HT/VHT40, M0 to M7	1	14	3.3		0.33	3.6	22	18.36
HT/VHT40, M0 to M7	2	14	-1.1	2.4	0.33	4.4	22	17.64
HT/VHT40, M8 to M15	2	14	-1.1	2.4	0.33	4.4	22	17.64
HT/VHT40 Beam Forming, M0 to M7	2	14	-1.1	2.4	0.33	4.4	22	17.64
HT/VHT40 Beam Forming, M8 to M15	2	14	-1.1	2.4	0.33	4.4	22	17.64
HT/VHT40 STBC, M0 to M7	2	14	-1.1	2.4	0.33	4.4	22	17.64
HE40, M0 to M9 1ss	1	14	4.1		0.27	4.4	22	17.6
HE40, M0 to M9 1ss	2	14	-1.0	3.2	0.27	4.9	22	17.11
HE40, M0 to M9 2ss	2	14	-1.0	3.2	0.27	4.9	22	17.11
HE40 Beam Forming, M0 to M9 1ss	2	14	-1.0	3.2	0.27	4.9	22	17.11
HE40 Beam Forming, M0 to M9 2ss	2	14	-1.0	3.2	0.27	4.9	22	17.11
HE40 STBC, M0 to M9 2ss	2	14	-1.0	3.2	0.27	4.9	22	17.11

Frequency 5825 MHz

Mode	Tx Paths	Correlated Antenna Gain (dBi)	Tx 1 PSD (dBm/500 kHz)	Tx 2 PSD (dBm/500 kHz)	Duty Cycle (dB)	Total PSD (dBm/500 kHz)	Limit (dBm/500 kHz)	Margin (dB)
Non HT20, 6 to 54 Mbps	1	14	7.2		0.5	7.7	22	14.31
Non HT20, 6 to 54 Mbps	2	14	2.3	5.8	0.5	7.9	22	14.13
Non HT20 Beam Forming, 6 to 54 Mbps	2	14	2.3	5.8	0.5	7.9	22	14.13
HT/VHT20, M0 to M7	1	14	6.4		0.31	6.7	22	15.29
HT/VHT20, M0 to M7	2	14	1.9	5.0	0.31	7.0	22	14.97
HT/VHT20, M8 to M15	2	14	1.9	5.0	0.31	7.0	22	14.97
HT/VHT20 Beam Forming, M0 to M7	2	14	1.9	5.0	0.31	7.0	22	14.97
HT/VHT20 Beam Forming, M8 to M15	2	14	1.9	5.0	0.31	7.0	22	14.97
HT/VHT20 STBC, M0 to M7	2	14	1.9	5.0	0.31	7.0	22	14.97
HE20, M0 to M9 1ss	1	14	6.8		0.27	7.1	22	14.93
HE20, M0 to M9 1ss	2	14	2.2	4.9	0.27	7.0	22	14.97
HE20, M0 to M9 2ss	2	14	2.2	4.9	0.27	7.0	22	14.97
HE20 Beam Forming, M0 to M9 1ss	2	14	2.2	4.9	0.27	7.0	22	14.97
HE20 Beam Forming, M0 to M9 2ss	2	14	2.2	4.9	0.27	7.0	22	14.97
HE20 STBC, M0 to M9 2ss	2	14	2.2	4.9	0.27	7.0	22	14.97

Data Screenshots

5745 MHz: Non HT20, 6 to 54 Mbps

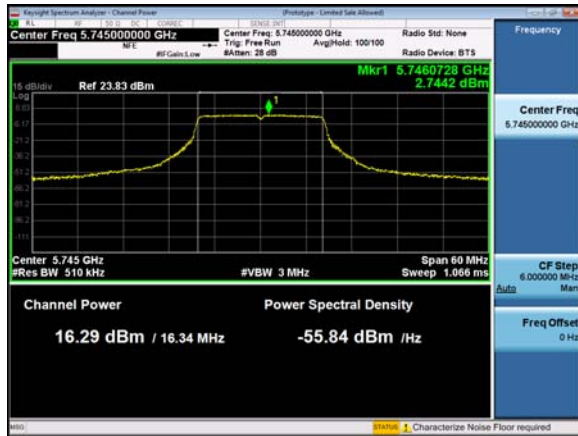

Antenna A

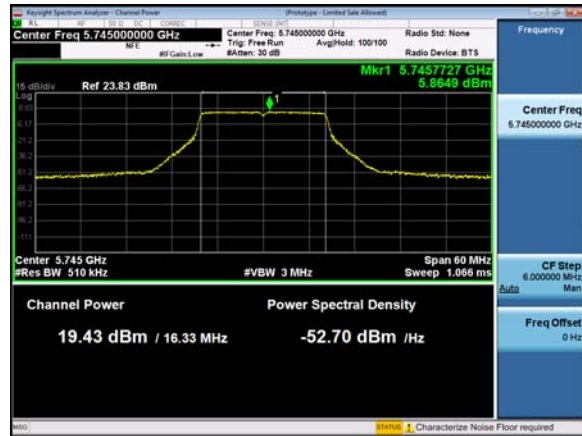

Antenna B

5745 MHz: Non HT20 Beam Forming, 6 to 54 Mbps

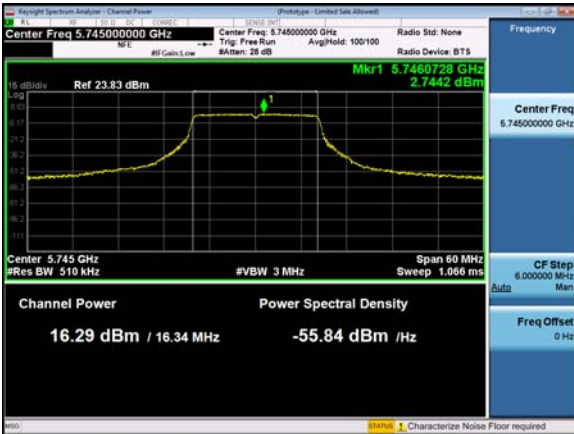

Antenna A

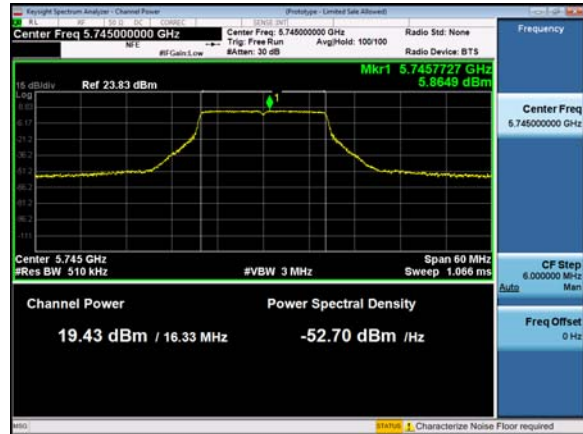

Antenna B

5825 MHz: Non HT20, 6 to 54 Mbps

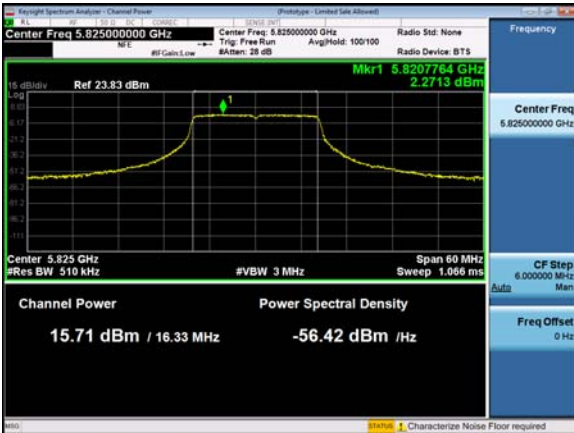

Antenna A

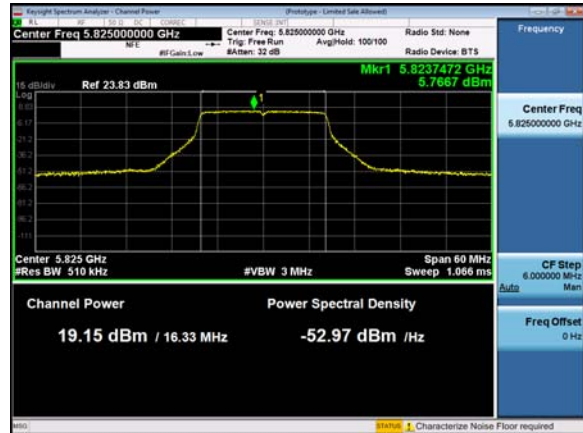

Antenna B

A.6: Conducted Spurious Emissions

Conducted Spurious Emissions Test Requirement

15.407:

(b) Undesirable emission limits. Except as shown in paragraph (b)(7) of this section, the maximum emissions outside of the frequency bands of operation shall be attenuated in accordance with the following limits:

(4) For transmitters operating in the 5.725-5.85 GHz band:

(i) All emissions shall be limited to a level of -27 dBm/MHz at 75 MHz or more above or below the band edge increasing linearly to 10 dBm/MHz at 25 MHz above or below the band edge, and from 25 MHz above or below the band edge increasing linearly to a level of 15.6 dBm/MHz at 5 MHz above or below the band edge, and from 5 MHz above or below the band edge increasing linearly to a level of 27 dBm/MHz at the band edge.

(6) Unwanted emissions below 1 GHz must comply with the general field strength limits set forth in §15.209.

(7) The provisions of §15.205 apply to intentional radiators operating under this section.

15.205 | 15.209:

Radiated emissions which fall in the restricted bands, as defined in Section 15.205(a), must also comply with the radiated emission limits specified in Section 15.209(a) (see Section 15.205(c)).

Use formula below to substitute conducted measurements in place of radiated measurements

$$E[\text{dB}\mu\text{V}/\text{m}] = \text{EIRP}[\text{dBm}] - 20 \log(d[\text{meters}]) + 104.77, \text{ where } E = \text{field strength and } d = 3 \text{ meter}$$

1) Average Plot, Limit= -41.25 dBm eirp

2) Peak plot, Limit = -21.25 dBm eirp

Conducted Spurious Emissions Test Procedure

From KDB 789033 D02 General UNII Test Procedures New Rules v02r01

ANSI C63.10: 2013

Conducted Spurious Emissions Test Procedure
<ol style="list-style-type: none"> 1. Connect the antenna port(s) to the spectrum analyzer input. 2. Place the radio in continuous transmit mode 3. Configure Spectrum analyzer as per test parameters below (be sure to enter all losses between the transmitter output and the spectrum analyzer). 4. Use the peak marker function to determine the maximum spurs amplitude level. 5. Out-of-band and spurious emissions tests are performed on each output individually without summing or adding $10 \log(N)$ since the measurements are made relative to the in-band emissions on the individual outputs. The worst-case output is recorded. 6. Capture graphs and record pertinent measurement data. <p>ISED:</p> <ol style="list-style-type: none"> 1. Connect the antenna port(s) to the spectrum analyzer input. 2. Place the radio in continuous transmit mode 3. Configure Spectrum analyzer as per test parameters below (be sure to enter all losses between the transmitter output and the spectrum analyzer). 4. Use the peak marker function to determine the maximum spurs amplitude level. 5. The "measure-and-sum technique" is used for measuring in-band transmit power of a device. In the measure-and-sum approach, the conducted emission level is measured at each antenna port. The measured results at the various antenna ports are then summed mathematically to determine the total emission level from the device. Summing is performed in linear power units. The worst-case output is recorded. (see ANSI C63.10:2013 section 14.3.2.2) 6. Capture graphs and record pertinent measurement data.

Ref. KDB 789033 D02 General UNII Test Procedures New Rules v02r01, Sec. 5 (Peak), Sec. 6 (Average Method AD)
ANSI C63.10: 2013 Section 12.7.6 (Peak), Section 12.7.7.2 (Method AD)

Conducted Spurious Emissions Test parameters	
Peak Span = 30MHz to 26.5GHz / 26.5GHz to 40GHz RBW = 1 MHz VBW ≥ 3 MHz Sweep = Auto couple Detector = Peak Trace = Max Hold.	Average Span = 30MHz to 26.5GHz / 26.5GHz to 40GHz RBW = 1 MHz VBW ≥ 3 MHz Sweep = Auto couple Detector = RMS Power Averaging

Add the max antenna gain + ground reflection factor (4.7 dB for frequencies between 30 MHz and 1000 MHz, and 0 dB for frequencies > 1000 MHz).

Tested By: Johanna Knudsen, Julian Land, Mathew Blackburn	Date of testing: 23-JUL-2021 to 26-JUL-2021; 28-JUL-2021 to 31-JUL-2021; 17-AUG-2021 to 27-AUG-2021; 30-AUG-2021 to 04-SEP-2021; 07-SEP-2021 to 08-SEP-2021
Test Result: PASS	

Test Equipment

See Appendix C for list of test equipment

Conducted Spurs Average Upper

Frequency 5745 MHz

Mode	Tx Paths	Correlated Antenna Gain (dBi)	Tx 1 Spur Power (dBm)	Duty Cycle (dB)	Total Conducted Spur (dBm)	Limit (dB)	Margin (dB)
Non HT20, 6 to 54 Mbps	1	14	-74.2	0.5	-59.7	-41	18.47

Data Screenshots

5745 MHz: Non HT20, 6 to 54 Mbps

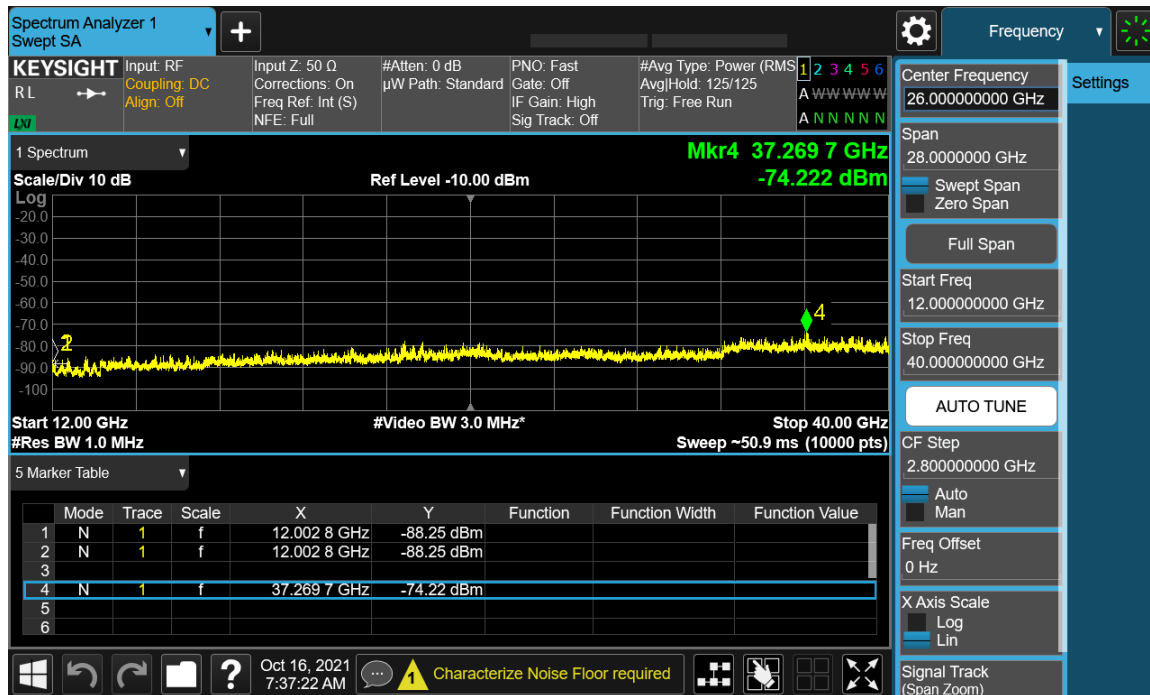

Antenna A

Conducted Spurs Peak Upper

Frequency 5745 MHz

Mode	Tx Paths	Correlated Antenna Gain (dBi)	Tx 1 Spur Power (dBm)	Duty Cycle (dB)	Total Conducted Spur (dBm)	Limit (dB)	Margin (dB)
Non HT20, 6 to 54 Mbps	1	14	-54.0	0.5	-39.5	-21	18.28

Data Screenshots

5745 MHz: Non HT20, 6 to 54 Mbps

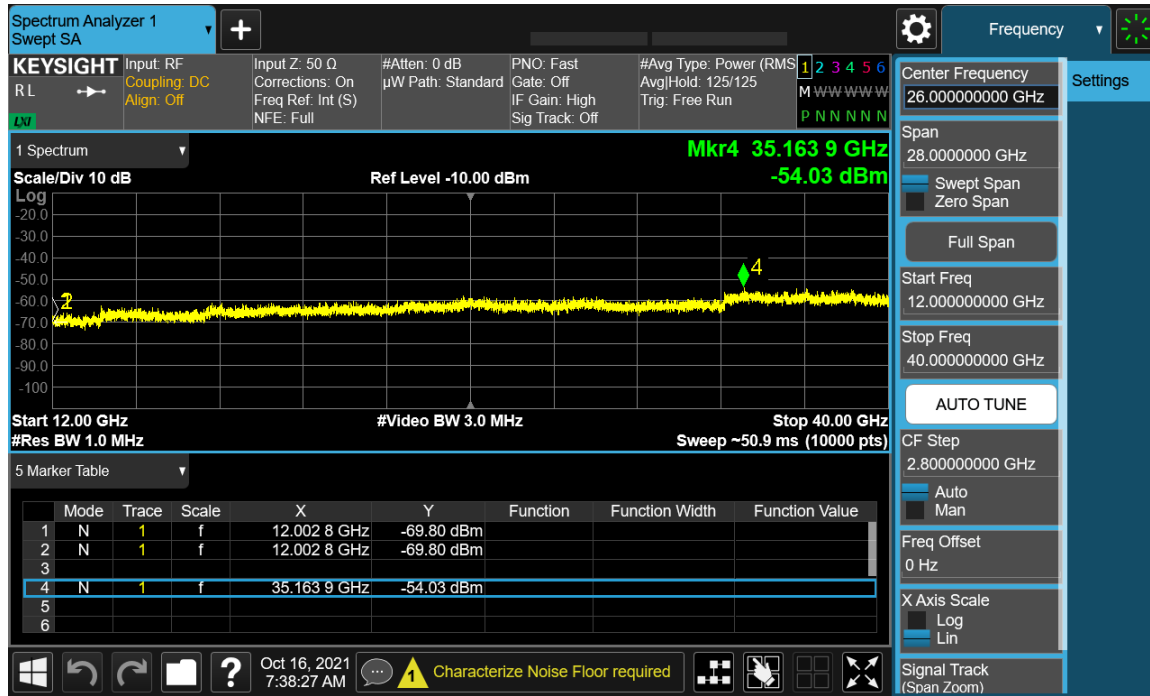

Antenna A

Conducted Spurs Average**Frequency 5690 MHz**

Mode	Tx Paths	Correlated Antenna Gain (dBi)	Tx 1 Spur Power (dBm)	Tx 2 Spur Power (dBm)	Duty Cycle (dB)	Total Conducted Spur (dBm)	Limit (dB)	Margin (dB)
Non HT80, 6 to 54 Mbps	1	14	-63.3		0.36	-48.9	-41	7.69
Non HT80, 6 to 54 Mbps	2	14	-69.7	-65.2	0.36	-49.5	-41	8.27
VHT80, M0 to M9 1ss	1	14	-64.8		0.89	-49.9	-41	8.66
VHT80, M0 to M9 1ss	2	14	-67.9	-65.0	0.89	-48.3	-41	7.06
VHT80, M0 to M9 2ss	2	14	-67.9	-65.0	0.89	-48.3	-41	7.06
VHT80 Beam Forming, M0 to M9 1ss	2	14	-67.9	-65.0	0.89	-48.3	-41	7.06
VHT80 Beam Forming, M0 to M9 2ss	2	14	-67.9	-65.0	0.89	-48.3	-41	7.06
VHT80 STBC, M0 to M9 1ss	2	14	-67.9	-65.0	0.89	-48.3	-41	7.06
HE80, M0 to M9 1ss	1	14	-61.3		0.23	-47.1	-41	5.82
HE80, M0 to M9 1ss	2	14	-69.6	-65.0	0.23	-49.5	-41	8.23
HE80, M0 to M9 2ss	2	14	-69.6	-65.0	0.23	-49.5	-41	8.23
HE80 Beam Forming, M0 to M9 1ss	2	14	-69.6	-65.0	0.23	-49.5	-41	8.23
HE80 Beam Forming, M0 to M9 2ss	2	14	-69.6	-65.0	0.23	-49.5	-41	8.23
HE80 STBC, M0 to M9 1ss	2	14	-69.6	-65.0	0.23	-49.5	-41	8.23

Frequency 5710 MHz

Mode	Tx Paths	Correlated Antenna Gain (dBi)	Tx 1 Spur Power (dBm)	Tx 2 Spur Power (dBm)	Duty Cycle (dB)	Total Conducted Spur (dBm)	Limit (dB)	Margin (dB)
Non HT40, 6 to 54 Mbps	1	14	-62.3		0.32	-48.0	-41	6.73
Non HT40, 6 to 54 Mbps	2	14	-69.8	-69.5	0.32	-52.3	-41	11.06
HT/VHT40, M0 to M7	1	14	-63.0		0.33	-48.7	-41	7.42
HT/VHT40, M0 to M7	2	14	-69.7	-69.3	0.33	-52.2	-41	10.9
HT/VHT40, M8 to M15	2	14	-69.7	-69.3	0.33	-52.2	-41	10.9
HT/VHT40 Beam Forming, M0 to M7	2	14	-69.7	-69.3	0.33	-52.2	-41	10.9
HT/VHT40 Beam Forming, M8 to M15	2	14	-69.7	-69.3	0.33	-52.2	-41	10.9
HT/VHT40 STBC, M0 to M7	2	14	-69.7	-69.3	0.33	-52.2	-41	10.9
HE40, M0 to M9 1ss	1	14	-62.6		0.27	-48.3	-41	7.08
HE40, M0 to M9 1ss	2	14	-69.7	-65.0	0.27	-49.5	-41	8.21
HE40, M0 to M9 2ss	2	14	-69.7	-65.0	0.27	-49.5	-41	8.21
HE40 Beam Forming, M0 to M9 1ss	2	14	-69.7	-65.0	0.27	-49.5	-41	8.21
HE40 Beam Forming, M0 to M9 2ss	2	14	-69.7	-65.0	0.27	-49.5	-41	8.21
HE40 STBC, M0 to M9 2ss	2	14	-69.7	-65.0	0.27	-49.5	-41	8.21

Frequency 5720 MHz

Mode	Tx Paths	Correlated Antenna Gain (dBi)	Tx 1 Spur Power (dBm)	Tx 2 Spur Power (dBm)	Duty Cycle (dB)	Total Conducted Spur (dBm)	Limit (dB)	Margin (dB)
Non HT20, 6 to 54 Mbps	1	14	-68.1		0.5	-53.6	-41	12.35
HT/VHT20, M0 to M7	1	14	-68.4		0.31	-54.1	-41	12.84
HT/VHT20, M0 to M7	2	14	-69.7	-70.0	0.31	-52.5	-41	11.28
HT/VHT20, M8 to M15	2	14	-69.7	-70.0	0.31	-52.5	-41	11.28
HT/VHT20 Beam Forming, M0 to M7	2	14	-69.7	-70.0	0.31	-52.5	-41	11.28
HT/VHT20 Beam Forming, M8 to M15	2	14	-69.7	-70.0	0.31	-52.5	-41	11.28
HT/VHT20 STBC, M0 to M7	2	14	-69.7	-70.0	0.31	-52.5	-41	11.28
HE20, M0 to M9 1ss	1	14	-68.2		0.27	-53.9	-41	12.68
HE20, M0 to M9 1ss	2	14	-69.7	-69.5	0.27	-52.3	-41	11.07
HE20, M0 to M9 2ss	2	14	-69.7	-69.5	0.27	-52.3	-41	11.07
HE20 Beam Forming, M0 to M9 1ss	2	14	-69.7	-69.5	0.27	-52.3	-41	11.07
HE20 Beam Forming, M0 to M9 2ss	2	14	-69.7	-69.5	0.27	-52.3	-41	11.07
HE20 STBC, M0 to M9 2ss	2	14	-69.7	-69.5	0.27	-52.3	-41	11.07

Frequency 5745 MHz

Mode	Tx Paths	Correlated Antenna Gain (dBi)	Tx 1 Spur Power (dBm)	Tx 2 Spur Power (dBm)	Duty Cycle (dB)	Total Conducted Spur (dBm)	Limit (dB)	Margin (dB)
Non HT20, 6 to 54 Mbps	1	14	-58.1		0.5	-43.6	-41	2.35
Non HT20, 6 to 54 Mbps	2	14	-61.2	-58.3	0.5	-42.0	-41	0.75
Non HT20 Beam Forming, 6 to 54 Mbps	2	14	-61.2	-58.3	0.5	-42.0	-41	0.75
HT/VHT20, M0 to M7	1	14	-57.9		0.31	-43.6	-41	2.34
HT/VHT20, M0 to M7	2	14	-61.2	-58.4	0.31	-42.3	-41	1.01
HT/VHT20, M8 to M15	2	14	-61.2	-58.4	0.31	-42.3	-41	1.01
HT/VHT20 Beam Forming, M0 to M7	2	14	-61.2	-58.4	0.31	-42.3	-41	1.01
HT/VHT20 Beam Forming, M8 to M15	2	14	-61.2	-58.4	0.31	-42.3	-41	1.01
HT/VHT20 STBC, M0 to M7	2	14	-61.2	-58.4	0.31	-42.3	-41	1.01
HE20, M0 to M9 1ss	1	14	-57.8		0.27	-43.5	-41	2.28
HE20, M0 to M9 1ss	2	14	-61.2	-58.3	0.27	-42.2	-41	0.98
HE20, M0 to M9 2ss	2	14	-61.2	-58.3	0.27	-42.2	-41	0.98
HE20 Beam Forming, M0 to M9 1ss	2	14	-61.2	-58.3	0.27	-42.2	-41	0.98
HE20 Beam Forming, M0 to M9 2ss	2	14	-61.2	-58.3	0.27	-42.2	-41	0.98
HE20 STBC, M0 to M9 2ss	2	14	-61.2	-58.3	0.27	-42.2	-41	0.98

Frequency 5755 MHz

Mode	Tx Paths	Correlated Antenna Gain (dBi)	Tx 1 Spur Power (dBm)	Tx 2 Spur Power (dBm)	Duty Cycle (dB)	Total Conducted Spur (dBm)	Limit (dB)	Margin (dB)
Non HT40, 6 to 54 Mbps	1	14	-58.0		0.32	-43.7	-41	2.43
Non HT40, 6 to 54 Mbps	2	14	-61.6	-59.1	0.2	-43.0	-41	1.71
HT/VHT40, M0 to M7	1	14	-57.8		0.33	-43.5	-41	2.22
HT/VHT40, M0 to M7	2	14	-61.4	-60.0	0.9	-42.7	-41	1.48
HT/VHT40, M8 to M15	2	14	-61.4	-60.0	0.9	-42.7	-41	1.48
HT/VHT40 Beam Forming, M0 to M7	2	14	-61.4	-60.0	0.9	-42.7	-41	1.48
HT/VHT40 Beam Forming, M8 to M15	2	14	-61.4	-60.0	0.9	-42.7	-41	1.48
HT/VHT40 STBC, M0 to M7	2	14	-61.4	-60.0	0.9	-42.7	-41	1.48
HE40, M0 to M9 1ss	1	14	-57.6		0.27	-43.3	-41	2.08
HE40, M0 to M9 1ss	2	14	-61.3	-59.1	0.27	-42.8	-41	1.53
HE40, M0 to M9 2ss	2	14	-61.3	-59.1	0.27	-42.8	-41	1.53
HE40 Beam Forming, M0 to M9 1ss	2	14	-61.3	-59.1	0.27	-42.8	-41	1.53
HE40 Beam Forming, M0 to M9 2ss	2	14	-61.3	-59.1	0.27	-42.8	-41	1.53
HE40 STBC, M0 to M9 2ss	2	14	-61.3	-59.1	0.27	-42.8	-41	1.53

Frequency 5775 MHz

Mode	Tx Paths	Correlated Antenna Gain (dBi)	Tx 1 Spur Power (dBm)	Tx 2 Spur Power (dBm)	Duty Cycle (dB)	Total Conducted Spur (dBm)	Limit (dB)	Margin (dB)
Non HT80, 6 to 54 Mbps	1	14	-56.9		0.36	-42.5	-41	1.29
Non HT80, 6 to 54 Mbps	2	14	-60.8	-59.9	0.21	-43.1	-41	1.85
VHT80, M0 to M9 1ss	1	14	-56.7		0.89	-41.8	-41	0.56
VHT80, M0 to M9 1ss	2	14	-61.0	-58.1	0.89	-41.4	-41	0.16
VHT80, M0 to M9 2ss	2	14	-61.0	-58.1	0.89	-41.4	-41	0.16
VHT80 Beam Forming, M0 to M9 1ss	2	14	-61.0	-58.1	0.89	-41.4	-41	0.16
VHT80 Beam Forming, M0 to M9 2ss	2	14	-61.0	-58.1	0.89	-41.4	-41	0.16
VHT80 STBC, M0 to M9 1ss	2	14	-61.0	-58.1	0.89	-41.4	-41	0.16
HE80, M0 to M9 1ss	1	14	-56.8		0.23	-42.6	-41	1.32
HE80, M0 to M9 1ss	2	14	-60.6	-57.7	0.23	-41.7	-41	0.43
HE80, M0 to M9 2ss	2	14	-60.6	-57.7	0.23	-41.7	-41	0.43
HE80 Beam Forming, M0 to M9 1ss	2	14	-60.6	-57.7	0.23	-41.7	-41	0.43
HE80 Beam Forming, M0 to M9 2ss	2	14	-60.6	-57.7	0.23	-41.7	-41	0.43
HE80 STBC, M0 to M9 1ss	2	14	-60.6	-57.7	0.23	-41.7	-41	0.43

Frequency 5785 MHz

Mode	Tx Paths	Correlated Antenna Gain (dBi)	Tx 1 Spur Power (dBm)	Tx 2 Spur Power (dBm)	Duty Cycle (dB)	Total Conducted Spur (dBm)	Limit (dB)	Margin (dB)
Non HT20, 6 to 54 Mbps	1	14	-60.0		0.5	-45.5	-41	4.25
Non HT20, 6 to 54 Mbps	2	14	-63.1	-58.6	0.5	-42.8	-41	1.53
Non HT20 Beam Forming, 6 to 54 Mbps	2	14	-63.1	-58.6	0.5	-42.8	-41	1.53
HT/VHT20, M0 to M7	1	14	-60.3		0.31	-46.0	-41	4.74
HT/VHT20, M0 to M7	2	14	-63.3	-58.9	0.31	-43.2	-41	2.0
HT/VHT20, M8 to M15	2	14	-63.3	-58.9	0.31	-43.2	-41	2.0
HT/VHT20 Beam Forming, M0 to M7	2	14	-63.3	-58.9	0.31	-43.2	-41	2.0
HT/VHT20 Beam Forming, M8 to M15	2	14	-63.3	-58.9	0.31	-43.2	-41	2.0
HT/VHT20 STBC, M0 to M7	2	14	-63.3	-58.9	0.31	-43.2	-41	2.0
HE20, M0 to M9 1ss	1	14	-59.9		0.27	-45.6	-41	4.38
HE20, M0 to M9 1ss	2	14	-62.6	-59.6	0.27	-43.6	-41	2.32
HE20, M0 to M9 2ss	2	14	-62.6	-59.6	0.27	-43.6	-41	2.32
HE20 Beam Forming, M0 to M9 1ss	2	14	-62.6	-59.6	0.27	-43.6	-41	2.32
HE20 Beam Forming, M0 to M9 2ss	2	14	-62.6	-59.6	0.27	-43.6	-41	2.32
HE20 STBC, M0 to M9 2ss	2	14	-62.6	-59.6	0.27	-43.6	-41	2.32

Frequency 5795 MHz

Mode	Tx Paths	Correlated Antenna Gain (dBi)	Tx 1 Spur Power (dBm)	Tx 2 Spur Power (dBm)	Duty Cycle (dB)	Total Conducted Spur (dBm)	Limit (dB)	Margin (dB)
Non HT40, 6 to 54 Mbps	1	14	-59.8		0.32	-45.5	-41	4.23
Non HT40, 6 to 54 Mbps	2	14	-62.4	-59.3	0.32	-43.2	-41	2.0
HT/VHT40, M0 to M7	1	14	-59.7		0.33	-45.4	-41	4.12
HT/VHT40, M0 to M7	2	14	-62.6	-56.6	0.33	-41.3	-41	0.05
HT/VHT40, M8 to M15	2	14	-62.6	-56.6	0.33	-41.3	-41	0.05
HT/VHT40 Beam Forming, M0 to M7	2	14	-62.6	-56.6	0.33	-41.3	-41	0.05
HT/VHT40 Beam Forming, M8 to M15	2	14	-62.6	-56.6	0.33	-41.3	-41	0.05
HT/VHT40 STBC, M0 to M7	2	14	-62.6	-56.6	0.33	-41.3	-41	0.05
HE40, M0 to M9 1ss	1	14	-59.4		0.27	-45.1	-41	3.88
HE40, M0 to M9 1ss	2	14	-62.3	-59.0	0.27	-43.1	-41	1.81
HE40, M0 to M9 2ss	2	14	-62.3	-59.0	0.27	-43.1	-41	1.81
HE40 Beam Forming, M0 to M9 1ss	2	14	-62.3	-59.0	0.27	-43.1	-41	1.81
HE40 Beam Forming, M0 to M9 2ss	2	14	-62.3	-59.0	0.27	-43.1	-41	1.81
HE40 STBC, M0 to M9 2ss	2	14	-62.3	-59.0	0.27	-43.1	-41	1.81

Frequency 5825 MHz

Mode	Tx Paths	Correlated Antenna Gain (dBi)	Tx 1 Spur Power (dBm)	Tx 2 Spur Power (dBm)	Duty Cycle (dB)	Total Conducted Spur (dBm)	Limit (dB)	Margin (dB)
Non HT20, 6 to 54 Mbps	1	14	-59.1		0.5	-44.6	-41	3.35
Non HT20, 6 to 54 Mbps	2	14	-62.0	-59.0	0.5	-42.7	-41	1.48
Non HT20 Beam Forming, 6 to 54 Mbps	2	14	-62.0	-59.0	0.5	-42.7	-41	1.48
HT/VHT20, M0 to M7	1	14	-58.5		0.31	-44.2	-41	2.94
HT/VHT20, M0 to M7	2	14	-61.9	-59.3	0.31	-43.1	-41	1.84
HT/VHT20, M8 to M15	2	14	-61.9	-59.3	0.31	-43.1	-41	1.84
HT/VHT20 Beam Forming, M0 to M7	2	14	-61.9	-59.3	0.31	-43.1	-41	1.84
HT/VHT20 Beam Forming, M8 to M15	2	14	-61.9	-59.3	0.31	-43.1	-41	1.84
HT/VHT20 STBC, M0 to M7	2	14	-61.9	-59.3	0.31	-43.1	-41	1.84
HE20, M0 to M9 1ss	1	14	-58.4		0.27	-44.1	-41	2.88
HE20, M0 to M9 1ss	2	14	-61.9	-58.9	0.27	-42.9	-41	1.62
HE20, M0 to M9 2ss	2	14	-61.9	-58.9	0.27	-42.9	-41	1.62
HE20 Beam Forming, M0 to M9 1ss	2	14	-61.9	-58.9	0.27	-42.9	-41	1.62
HE20 Beam Forming, M0 to M9 2ss	2	14	-61.9	-58.9	0.27	-42.9	-41	1.62
HE20 STBC, M0 to M9 2ss	2	14	-61.9	-58.9	0.27	-42.9	-41	1.62

Data Screenshots

5795 MHz: HT/VHT40, M0 to M7

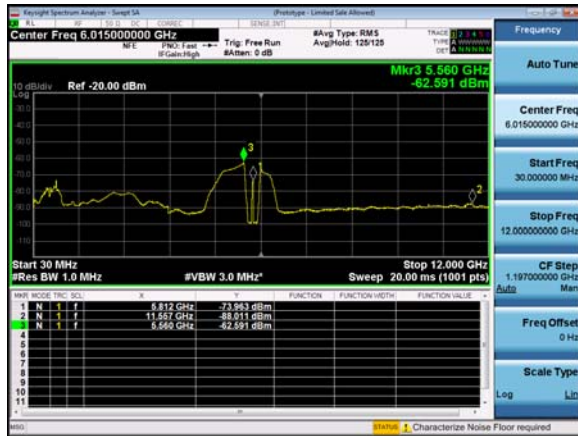

Antenna A



Antenna B

5795 MHz: HT/VHT40, M8 to M15

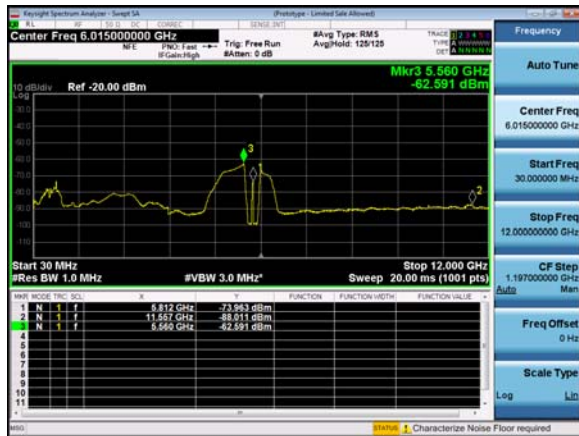

Antenna A



Antenna B

5795 MHz: HT/VHT40 Beam Forming, M0 to M7

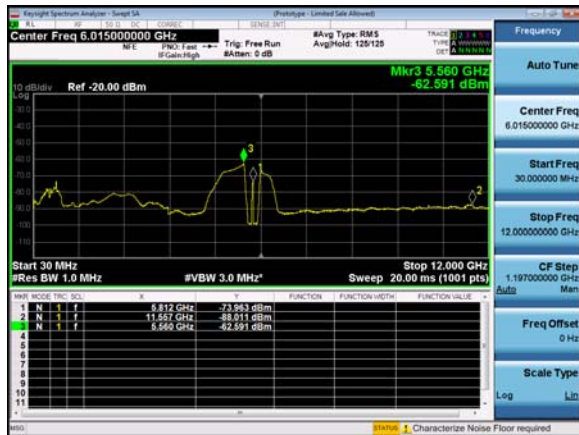

Antenna A



Antenna B

Conducted Spurs Peak**Frequency 5690 MHz**

Mode	Tx Paths	Correlated Antenna Gain (dBi)	Tx 1 Spur Power (dBm)	Tx 2 Spur Power (dBm)	Duty Cycle (dB)	Total Conducted Spur (dBm)	Limit (dB)	Margin (dB)
Non HT80, 6 to 54 Mbps	1	14	-58.6		0.36	-44.2	-21	22.99
Non HT80, 6 to 54 Mbps	2	14	-60.5	-56.4	0.36	-40.6	-21	19.37
VHT80, M0 to M9 1ss	1	14	-58.0		0.89	-43.1	-21	21.86
VHT80, M0 to M9 1ss	2	14	-56.9	-56.1	0.89	-38.6	-21	17.33
VHT80, M0 to M9 2ss	2	14	-56.9	-56.1	0.89	-38.6	-21	17.33
VHT80 Beam Forming, M0 to M9 1ss	2	14	-56.9	-56.1	0.89	-38.6	-21	17.33
VHT80 Beam Forming, M0 to M9 2ss	2	14	-56.9	-56.1	0.89	-38.6	-21	17.33
VHT80 STBC, M0 to M9 1ss	2	14	-56.9	-56.1	0.89	-38.6	-21	17.33
HE80, M0 to M9 1ss	1	14	-54.0		0.23	-39.8	-21	18.52
HE80, M0 to M9 1ss	2	14	-60.8	-55.7	0.23	-40.3	-21	19.06
HE80, M0 to M9 2ss	2	14	-60.8	-55.7	0.23	-40.3	-21	19.06
HE80 Beam Forming, M0 to M9 1ss	2	14	-60.8	-55.7	0.23	-40.3	-21	19.06
HE80 Beam Forming, M0 to M9 2ss	2	14	-60.8	-55.7	0.23	-40.3	-21	19.06
HE80 STBC, M0 to M9 1ss	2	14	-60.8	-55.7	0.23	-40.3	-21	19.06

Frequency 5710 MHz

Mode	Tx Paths	Correlated Antenna Gain (dBi)	Tx 1 Spur Power (dBm)	Tx 2 Spur Power (dBm)	Duty Cycle (dB)	Total Conducted Spur (dBm)	Limit (dB)	Margin (dB)
Non HT40, 6 to 54 Mbps	1	14	-53.1		0.32	-38.8	-21	17.53
Non HT40, 6 to 54 Mbps	2	14	-60.6	-60.5	0.32	-43.2	-21	21.97
HT/VHT40, M0 to M7	1	14	-53.5		0.33	-39.2	-21	17.92
HT/VHT40, M0 to M7	2	14	-60.7	-59.6	0.33	-42.8	-21	21.52
HT/VHT40, M8 to M15	2	14	-60.7	-59.6	0.33	-42.8	-21	21.52
HT/VHT40 Beam Forming, M0 to M7	2	14	-60.7	-59.6	0.33	-42.8	-21	21.52
HT/VHT40 Beam Forming, M8 to M15	2	14	-60.7	-59.6	0.33	-42.8	-21	21.52
HT/VHT40 STBC, M0 to M7	2	14	-60.7	-59.6	0.33	-42.8	-21	21.52
HE40, M0 to M9 1ss	1	14	-53.7		0.27	-39.4	-21	18.18
HE40, M0 to M9 1ss	2	14	-61.3	-56.2	0.27	-40.8	-21	19.51
HE40, M0 to M9 2ss	2	14	-61.3	-56.2	0.27	-40.8	-21	19.51
HE40 Beam Forming, M0 to M9 1ss	2	14	-61.3	-56.2	0.27	-40.8	-21	19.51
HE40 Beam Forming, M0 to M9 2ss	2	14	-61.3	-56.2	0.27	-40.8	-21	19.51
HE40 STBC, M0 to M9 2ss	2	14	-61.3	-56.2	0.27	-40.8	-21	19.51

Frequency 5720 MHz

Mode	Tx Paths	Correlated Antenna Gain (dBi)	Tx 1 Spur Power (dBm)	Tx 2 Spur Power (dBm)	Duty Cycle (dB)	Total Conducted Spur (dBm)	Limit (dB)	Margin (dB)
Non HT20, 6 to 54 Mbps	1	14	-59.0		0.5	-44.5	-21	23.25
HT/VHT20, M0 to M7	1	14	-58.8		0.31	-44.5	-21	23.24
HT/VHT20, M0 to M7	2	14	-61.7	-60.0	0.31	-43.5	-21	22.2
HT/VHT20, M8 to M15	2	14	-61.7	-60.0	0.31	-43.5	-21	22.2
HT/VHT20 Beam Forming, M0 to M7	2	14	-61.7	-60.0	0.31	-43.5	-21	22.2
HT/VHT20 Beam Forming, M8 to M15	2	14	-61.7	-60.0	0.31	-43.5	-21	22.2
HT/VHT20 STBC, M0 to M7	2	14	-61.7	-60.0	0.31	-43.5	-21	22.2
HE20, M0 to M9 1ss	1	14	-58.2		0.27	-43.9	-21	22.68
HE20, M0 to M9 1ss	2	14	-61.5	-59.6	0.27	-43.2	-21	21.92
HE20, M0 to M9 2ss	2	14	-61.5	-59.6	0.27	-43.2	-21	21.92
HE20 Beam Forming, M0 to M9 1ss	2	14	-61.5	-59.6	0.27	-43.2	-21	21.92
HE20 Beam Forming, M0 to M9 2ss	2	14	-61.5	-59.6	0.27	-43.2	-21	21.92
HE20 STBC, M0 to M9 2ss	2	14	-61.5	-59.6	0.27	-43.2	-21	21.92

Frequency 5745 MHz

Mode	Tx Paths	Correlated Antenna Gain (dBi)	Tx 1 Spur Power (dBm)	Tx 2 Spur Power (dBm)	Duty Cycle (dB)	Total Conducted Spur (dBm)	Limit (dB)	Margin (dB)
Non HT20, 6 to 54 Mbps	1	14	-51.1		0.5	-36.6	-21	15.35
Non HT20, 6 to 54 Mbps	2	14	-54.0	-49.1	0.5	-33.4	-21	12.13
Non HT20 Beam Forming, 6 to 54 Mbps	2	14	-54.0	-49.1	0.5	-33.4	-21	12.13
HT/VHT20, M0 to M7	1	14	-50.9		0.31	-36.6	-21	15.34
HT/VHT20, M0 to M7	2	14	-54.7	-48.8	0.31	-33.5	-21	12.25
HT/VHT20, M8 to M15	2	14	-54.7	-48.8	0.31	-33.5	-21	12.25
HT/VHT20 Beam Forming, M0 to M7	2	14	-54.7	-48.8	0.31	-33.5	-21	12.25
HT/VHT20 Beam Forming, M8 to M15	2	14	-54.7	-48.8	0.31	-33.5	-21	12.25
HT/VHT20 STBC, M0 to M7	2	14	-54.7	-48.8	0.31	-33.5	-21	12.25
HE20, M0 to M9 1ss	1	14	-51.0		0.27	-36.7	-21	15.48
HE20, M0 to M9 1ss	2	14	-54.1	-49.0	0.27	-33.6	-21	12.31
HE20, M0 to M9 2ss	2	14	-54.1	-49.0	0.27	-33.6	-21	12.31
HE20 Beam Forming, M0 to M9 1ss	2	14	-54.1	-49.0	0.27	-33.6	-21	12.31
HE20 Beam Forming, M0 to M9 2ss	2	14	-54.1	-49.0	0.27	-33.6	-21	12.31
HE20 STBC, M0 to M9 2ss	2	14	-54.1	-49.0	0.27	-33.6	-21	12.31

Frequency 5755 MHz

Mode	Tx Paths	Correlated Antenna Gain (dBi)	Tx 1 Spur Power (dBm)	Tx 2 Spur Power (dBm)	Duty Cycle (dB)	Total Conducted Spur (dBm)	Limit (dB)	Margin (dB)
Non HT40, 6 to 54 Mbps	1	14	-50.9		0.32	-36.6	-21	15.33
Non HT40, 6 to 54 Mbps	2	14	-53.7	-52.7	0.2	-36.0	-21	14.71
HT/VHT40, M0 to M7	1	14	-50.4		0.33	-36.1	-21	14.82
HT/VHT40, M0 to M7	2	14	-53.1	-51.7	0.9	-34.4	-21	13.18
HT/VHT40, M8 to M15	2	14	-53.1	-51.7	0.9	-34.4	-21	13.18
HT/VHT40 Beam Forming, M0 to M7	2	14	-53.1	-51.7	0.9	-34.4	-21	13.18
HT/VHT40 Beam Forming, M8 to M15	2	14	-53.1	-51.7	0.9	-34.4	-21	13.18
HT/VHT40 STBC, M0 to M7	2	14	-53.1	-51.7	0.9	-34.4	-21	13.18
HE40, M0 to M9 1ss	1	14	-51.5		0.27	-37.2	-21	15.98
HE40, M0 to M9 1ss	2	14	-53.7	-51.7	0.27	-35.3	-21	14.05
HE40, M0 to M9 2ss	2	14	-53.7	-51.7	0.27	-35.3	-21	14.05
HE40 Beam Forming, M0 to M9 1ss	2	14	-53.7	-51.7	0.27	-35.3	-21	14.05
HE40 Beam Forming, M0 to M9 2ss	2	14	-53.7	-51.7	0.27	-35.3	-21	14.05
HE40 STBC, M0 to M9 2ss	2	14	-53.7	-51.7	0.27	-35.3	-21	14.05

Frequency 5775 MHz

Mode	Tx Paths	Correlated Antenna Gain (dBi)	Tx 1 Spur Power (dBm)	Tx 2 Spur Power (dBm)	Duty Cycle (dB)	Total Conducted Spur (dBm)	Limit (dB)	Margin (dB)
Non HT80, 6 to 54 Mbps	1	14	-49.4		0.36	-35.0	-21	13.79
Non HT80, 6 to 54 Mbps	2	14	-53.1	-51.0	0.21	-34.7	-21	13.45
VHT80, M0 to M9 1ss	1	14	-51.1		0.89	-36.2	-21	14.96
VHT80, M0 to M9 1ss	2	14	-52.8	-48.0	0.89	-31.9	-21	10.62
VHT80, M0 to M9 2ss	2	14	-52.8	-48.0	0.89	-31.9	-21	10.62
VHT80 Beam Forming, M0 to M9 1ss	2	14	-52.8	-48.0	0.89	-31.9	-21	10.62
VHT80 Beam Forming, M0 to M9 2ss	2	14	-52.8	-48.0	0.89	-31.9	-21	10.62
VHT80 STBC, M0 to M9 1ss	2	14	-52.8	-48.0	0.89	-31.9	-21	10.62
HE80, M0 to M9 1ss	1	14	-50.9		0.23	-36.7	-21	15.42
HE80, M0 to M9 1ss	2	14	-53.4	-48.4	0.23	-33.0	-21	11.73
HE80, M0 to M9 2ss	2	14	-53.4	-48.4	0.23	-33.0	-21	11.73
HE80 Beam Forming, M0 to M9 1ss	2	14	-53.4	-48.4	0.23	-33.0	-21	11.73
HE80 Beam Forming, M0 to M9 2ss	2	14	-53.4	-48.4	0.23	-33.0	-21	11.73
HE80 STBC, M0 to M9 1ss	2	14	-53.4	-48.4	0.23	-33.0	-21	11.73

Frequency 5785 MHz

Mode	Tx Paths	Correlated Antenna Gain (dBi)	Tx 1 Spur Power (dBm)	Tx 2 Spur Power (dBm)	Duty Cycle (dB)	Total Conducted Spur (dBm)	Limit (dB)	Margin (dB)
Non HT20, 6 to 54 Mbps	1	14	-50.4		0.5	-35.9	-21	14.65
Non HT20, 6 to 54 Mbps	2	14	-53.9	-51.7	0.5	-35.1	-21	13.9
Non HT20 Beam Forming, 6 to 54 Mbps	2	14	-53.9	-51.7	0.5	-35.1	-21	13.9
HT/VHT20, M0 to M7	1	14	-50.8		0.31	-36.5	-21	15.24
HT/VHT20, M0 to M7	2	14	-54.4	-52.1	0.31	-35.8	-21	14.53
HT/VHT20, M8 to M15	2	14	-54.4	-52.1	0.31	-35.8	-21	14.53
HT/VHT20 Beam Forming, M0 to M7	2	14	-54.4	-52.1	0.31	-35.8	-21	14.53
HT/VHT20 Beam Forming, M8 to M15	2	14	-54.4	-52.1	0.31	-35.8	-21	14.53
HT/VHT20 STBC, M0 to M7	2	14	-54.4	-52.1	0.31	-35.8	-21	14.53
HE20, M0 to M9 1ss	1	14	-50.7		0.27	-36.4	-21	15.18
HE20, M0 to M9 1ss	2	14	-53.3	-49.4	0.27	-33.6	-21	12.4
HE20, M0 to M9 2ss	2	14	-53.3	-49.4	0.27	-33.6	-21	12.4
HE20 Beam Forming, M0 to M9 1ss	2	14	-53.3	-49.4	0.27	-33.6	-21	12.4
HE20 Beam Forming, M0 to M9 2ss	2	14	-53.3	-49.4	0.27	-33.6	-21	12.4
HE20 STBC, M0 to M9 2ss	2	14	-53.3	-49.4	0.27	-33.6	-21	12.4

Frequency 5795 MHz

Mode	Tx Paths	Correlated Antenna Gain (dBi)	Tx 1 Spur Power (dBm)	Tx 2 Spur Power (dBm)	Duty Cycle (dB)	Total Conducted Spur (dBm)	Limit (dB)	Margin (dB)
Non HT40, 6 to 54 Mbps	1	14	-50.7		0.32	-36.4	-21	15.13
Non HT40, 6 to 54 Mbps	2	14	-53.9	-52.1	0.32	-35.6	-21	14.32
HT/VHT40, M0 to M7	1	14	-50.6		0.33	-36.3	-21	15.02
HT/VHT40, M0 to M7	2	14	-53.2	-48.6	0.33	-33.0	-21	11.73
HT/VHT40, M8 to M15	2	14	-53.2	-48.6	0.33	-33.0	-21	11.73
HT/VHT40 Beam Forming, M0 to M7	2	14	-53.2	-48.6	0.33	-33.0	-21	11.73
HT/VHT40 Beam Forming, M8 to M15	2	14	-53.2	-48.6	0.33	-33.0	-21	11.73
HT/VHT40 STBC, M0 to M7	2	14	-53.2	-48.6	0.33	-33.0	-21	11.73
HE40, M0 to M9 1ss	1	14	-49.8		0.27	-35.5	-21	14.28
HE40, M0 to M9 1ss	2	14	-54.2	-48.2	0.27	-33.0	-21	11.7
HE40, M0 to M9 2ss	2	14	-54.2	-48.2	0.27	-33.0	-21	11.7
HE40 Beam Forming, M0 to M9 1ss	2	14	-54.2	-48.2	0.27	-33.0	-21	11.7
HE40 Beam Forming, M0 to M9 2ss	2	14	-54.2	-48.2	0.27	-33.0	-21	11.7
HE40 STBC, M0 to M9 2ss	2	14	-54.2	-48.2	0.27	-33.0	-21	11.7

Frequency 5825 MHz

Mode	Tx Paths	Correlated Antenna Gain (dBi)	Tx 1 Spur Power (dBm)	Tx 2 Spur Power (dBm)	Duty Cycle (dB)	Total Conducted Spur (dBm)	Limit (dB)	Margin (dB)
Non HT20, 6 to 54 Mbps	1	14	-50.2		0.5	-35.7	-21	14.45
Non HT20, 6 to 54 Mbps	2	14	-52.8	-48.2	0.5	-32.4	-21	11.15
Non HT20 Beam Forming, 6 to 54 Mbps	2	14	-52.8	-48.2	0.5	-32.4	-21	11.15
HT/VHT20, M0 to M7	1	14	-49.1		0.31	-34.8	-21	13.54
HT/VHT20, M0 to M7	2	14	-52.6	-48.3	0.31	-32.6	-21	11.37
HT/VHT20, M8 to M15	2	14	-52.6	-48.3	0.31	-32.6	-21	11.37
HT/VHT20 Beam Forming, M0 to M7	2	14	-52.6	-48.3	0.31	-32.6	-21	11.37
HT/VHT20 Beam Forming, M8 to M15	2	14	-52.6	-48.3	0.31	-32.6	-21	11.37
HT/VHT20 STBC, M0 to M7	2	14	-52.6	-48.3	0.31	-32.6	-21	11.37
HE20, M0 to M9 1ss	1	14	-49.3		0.27	-35.0	-21	13.78
HE20, M0 to M9 1ss	2	14	-52.2	-48.6	0.27	-32.8	-21	11.51
HE20, M0 to M9 2ss	2	14	-52.2	-48.6	0.27	-32.8	-21	11.51
HE20 Beam Forming, M0 to M9 1ss	2	14	-52.2	-48.6	0.27	-32.8	-21	11.51
HE20 Beam Forming, M0 to M9 2ss	2	14	-52.2	-48.6	0.27	-32.8	-21	11.51
HE20 STBC, M0 to M9 2ss	2	14	-52.2	-48.6	0.27	-32.8	-21	11.51

Data Screenshots

5775 MHz: VHT80, M0 to M9 1ss

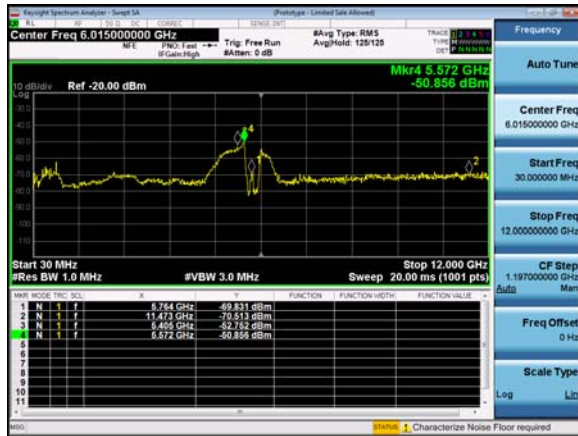

Antenna A

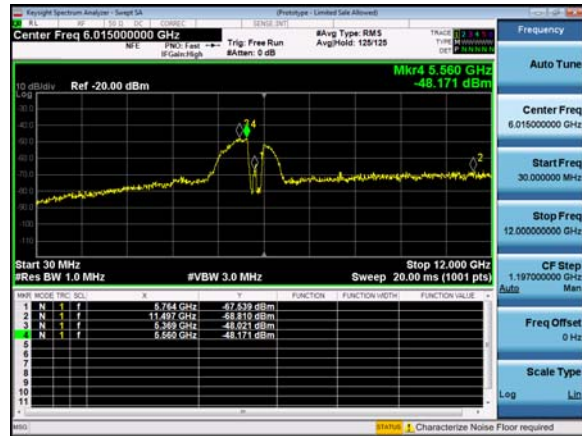

Antenna B

5775 MHz: VHT80, M0 to M9 2ss

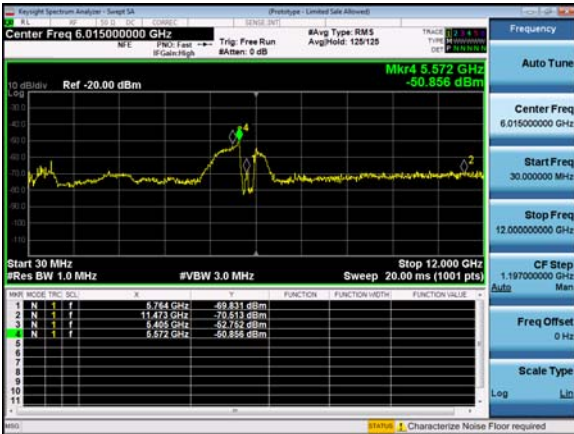

Antenna A

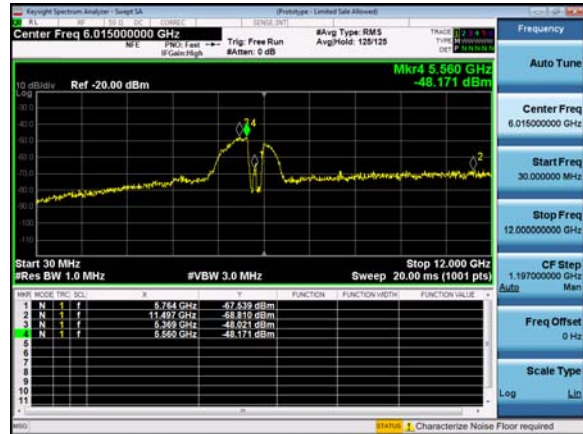

Antenna B

5775 MHz: VHT80 Beam Forming, M0 to M9 1ss



Antenna A



Antenna B

A.7: Conducted Bandedge

Conducted Band Edge Test Requirement

15.407:

(b) Undesirable emission limits. Except as shown in paragraph (b)(7) of this section, the maximum emissions outside of the frequency bands of operation shall be attenuated in accordance with the following limits:

(4) For transmitters operating in the 5.725-5.85 GHz band:

(i) All emissions shall be limited to a level of -27 dBm/MHz at 75 MHz or more above or below the band edge increasing linearly to 10 dBm/MHz at 25 MHz above or below the band edge, and from 25 MHz above or below the band edge increasing linearly to a level of 15.6 dBm/MHz at 5 MHz above or below the band edge, and from 5 MHz above or below the band edge increasing linearly to a level of 27 dBm/MHz at the band edge.

(6) Unwanted emissions below 1 GHz must comply with the general field strength limits set forth in §15.209.

(7) The provisions of §15.205 apply to intentional radiators operating under this section.

(8) When measuring the emission limits, the nominal carrier frequency shall be adjusted as close to the upper and lower frequency band edges as the design of the equipment permits

KDB 789033 D02 General UNII Test Procedures New Rules v02r01:

2. Unwanted Emissions that fall Outside of the Restricted Bands

a) For all measurements, follow the requirements in II.G.3. "General Requirements for Unwanted Emissions Measurements."

b) At frequencies below 1000 MHz, use the procedure described in II.G.4. "Procedure for Unwanted Emissions Measurements Below 1000 MHz."

c) At frequencies above 1000 MHz, use the procedure for maximum emissions described in II.G.5., "Procedure for Unwanted Emissions Measurements Above 1000 MHz."

(i) Sections 15.407(b)(1-3) specifies the unwanted emissions limit for the U-NII-1 and U-NII-2 bands. As specified, emissions above 1000 MHz that are outside of the restricted bands are subject to a peak emission limit of -27 dBm/MHz.

(ii) Section 15.407(b)(4) specifies the unwanted emissions limit for the U-NII-3 band. A band emissions mask is specified in Section 15.407(b)(4)(i). The emission limits are based on the use of a peak detector.

Conducted Band Edge Test Procedure

Ref. 789033 D02 General UNII Test Procedures New Rules v02r01

ANSI C63.10: 2013

Conducted Band Edge Test Procedure
<ol style="list-style-type: none"> 1. Connect the antenna port(s) to the spectrum analyzer input. 2. Place the radio in continuous transmit mode. Use the procedures in KDB 789033 D02 General UNII Test Procedures New Rules v02r01 to substitute conducted measurements in place of radiated measurements. 3. Configure Spectrum analyzer as per test parameters below (be sure to enter all losses between the transmitter output and the spectrum analyzer). 4. Record the marker. Also measure any emissions in the restricted bands. 5. The "measure-and-sum technique" is used for measuring in-band transmit power of a device. In the measure-and-sum approach, the conducted emission level is measured at each antenna port. The measured results at the various antenna ports are then summed mathematically to determine the total emission level from the device. Summing is performed in linear power units. The worst-case output is recorded. 6. Place a marker at the end of the restricted band closest to the transmit frequency to show compliance. Also measure any emissions in the restricted bands 7. Capture graphs and record pertinent measurement data.

Ref. 789033 D02 General UNII Test Procedures New Rules v02r01

ANSI C63.10: 2013 Section 12.7.6 (Peak), Section 12.7.7.2 (Method AD)

Conducted Spurious Emissions Test parameters	
Peak Span = 30MHz to 26.5GHz / 26.5GHz to 40GHz RBW = 1 MHz VBW ≥ 3 MHz Sweep = Auto couple Detector = Peak Trace = Max Hold.	Average Span = 30MHz to 26.5GHz / 26.5GHz to 40GHz RBW = 1 MHz VBW ≥ 3 MHz Sweep = Auto couple Detector = RMS Power Averaging
Tested By: Johanna Knudsen, Julian Land, Mathew Blackburn	Date of testing: 30-JUL-2021 to 31-JUL-2021; 03-AUG-2021; 25-OCT-2021
Test Result: PASS	

Test Equipment

See Appendix C for list of test equipment

Conducted Bandedge Peak 15407L**Frequency 5745 MHz**

Mode	Tx Paths	Correlated Antenna Gain (dBi)	Tx 1 Bandedge Level (dBm)	Tx 2 Bandedge Level (dBm)	Total Tx Bandedge Level (dBm)	Limit (dB)	Margin (dB)
Non HT20, 6 to 54 Mbps	1	14	-53.0		-38.8	-27	11.75
Non HT20, 6 to 54 Mbps	2	14	-55.6	-54.8	-37.9	-27	10.92
Non HT20 Beam Forming, 6 to 54 Mbps	2	14	-55.6	-54.8	-37.9	-27	10.92
HT/VHT20, M0 to M7	1	14	-53.6		-39.4	-27	12.35
HT/VHT20, M0 to M7	2	14	-56.0	-53.5	-37.3	-27	10.31
HT/VHT20, M8 to M15	2	14	-56.0	-53.5	-37.3	-27	10.31
HT/VHT20 Beam Forming, M0 to M7	2	14	-56.0	-53.5	-37.3	-27	10.31
HT/VHT20 Beam Forming, M8 to M15	2	14	-56.0	-53.5	-37.3	-27	10.31
HT/VHT20 STBC, M0 to M7	2	14	-56.0	-53.5	-37.3	-27	10.31
HE20, M0 to M9 1ss	1	14	-51.6		-37.4	-27	10.35
HE20, M0 to M9 1ss	2	14	-57.7	-54.2	-38.3	-27	11.35
HE20, M0 to M9 2ss	2	14	-57.7	-54.2	-38.3	-27	11.35
HE20 Beam Forming, M0 to M9 1ss	2	14	-57.7	-54.2	-38.3	-27	11.35
HE20 Beam Forming, M0 to M9 2ss	2	14	-57.7	-54.2	-38.3	-27	11.35
HE20 STBC, M0 to M9 2ss	2	14	-57.7	-54.2	-38.3	-27	11.35

Frequency 5755 MHz

Mode	Tx Paths	Correlated Antenna Gain (dBi)	Tx 1 Bandedge Level (dBm)	Tx 2 Bandedge Level (dBm)	Total Tx Bandedge Level (dBm)	Limit (dB)	Margin (dB)
Non HT40, 6 to 54 Mbps	1	14	-47.3		-33.1	-27	6.05
Non HT40, 6 to 54 Mbps	2	14	-52.4	-54.6	-36.1	-27	9.1
HT/VHT40, M0 to M7	1	14	-49.3		-35.1	-27	8.05
HT/VHT40, M0 to M7	2	14	-56.5	-57.4	-39.7	-27	12.67
HT/VHT40, M8 to M15	2	14	-56.5	-57.4	-39.7	-27	12.67
HT/VHT40 Beam Forming, M0 to M7	2	14	-56.5	-57.4	-39.7	-27	12.67
HT/VHT40 Beam Forming, M8 to M15	2	14	-56.5	-57.4	-39.7	-27	12.67
HT/VHT40 STBC, M0 to M7	2	14	-56.5	-57.4	-39.7	-27	12.67
HE40, M0 to M9 1ss	1	14	-51.3		-37.1	-27	10.05
HE40, M0 to M9 1ss	2	14	-53.1	-57.0	-37.4	-27	10.37
HE40, M0 to M9 2ss	2	14	-53.1	-57.0	-37.4	-27	10.37
HE40 Beam Forming, M0 to M9 1ss	2	14	-53.1	-57.0	-37.4	-27	10.37
HE40 Beam Forming, M0 to M9 2ss	2	14	-53.1	-57.0	-37.4	-27	10.37
HE40 STBC, M0 to M9 2ss	2	14	-53.1	-57.0	-37.4	-27	10.37

Frequency 5775 MHz

Mode	Tx Paths	Correlated Antenna Gain (dBi)	Tx 1 Bandedge Level (dBm)	Tx 2 Bandedge Level (dBm)	Total Tx Bandedge Level (dBm)	Limit (dB)	Margin (dB)
Non HT80, 6 to 54 Mbps	1	14	-43.7		-29.5	-27	2.45
Non HT80, 6 to 54 Mbps	2	14	-52.5	-53.6	-35.8	-27	8.76
VHT80, M0 to M9 1ss	1	14	-43.8		-29.6	-27	2.55
VHT80, M0 to M9 1ss	2	14	-55.6	-52.7	-36.7	-27	9.65
VHT80, M0 to M9 2ss	2	14	-55.6	-52.7	-36.7	-27	9.65
VHT80 Beam Forming, M0 to M9 1ss	2	14	-55.6	-52.7	-36.7	-27	9.65
VHT80 Beam Forming, M0 to M9 2ss	2	14	-55.6	-52.7	-36.7	-27	9.65
VHT80 STBC, M0 to M9 1ss	2	14	-55.6	-52.7	-36.7	-27	9.65
HE80, M0 to M9 1ss	1	14	-45.3		-31.1	-27	4.05
HE80, M0 to M9 1ss	2	14	-54.5	-52.1	-35.9	-27	8.88
HE80, M0 to M9 2ss	2	14	-54.5	-52.1	-35.9	-27	8.88
HE80 Beam Forming, M0 to M9 1ss	2	14	-54.5	-52.1	-35.9	-27	8.88
HE80 Beam Forming, M0 to M9 2ss	2	14	-54.5	-52.1	-35.9	-27	8.88
HE80 STBC, M0 to M9 1ss	2	14	-54.5	-52.1	-35.9	-27	8.88

Data Screenshots

5775 MHz: Non HT80, 6 to 54 Mbps

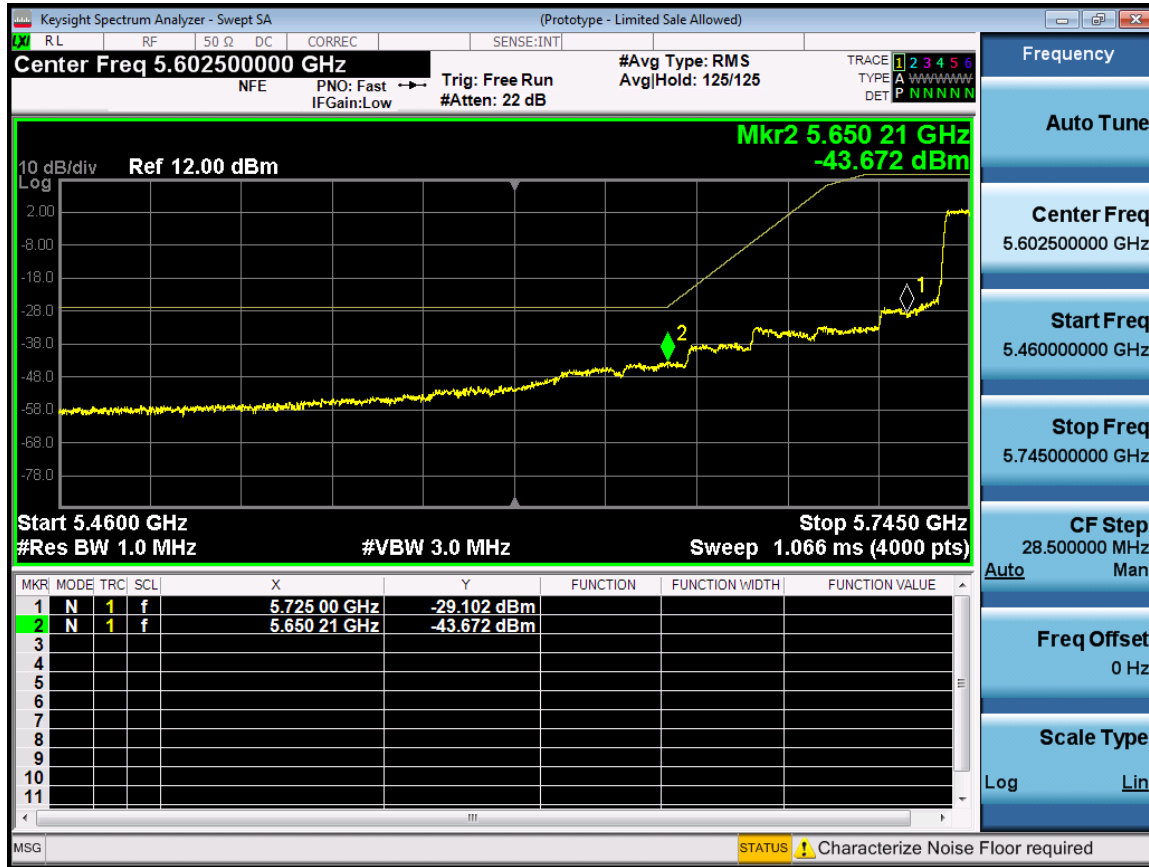

Antenna A

5775 MHz: VHT80, M0 to M9 1ss

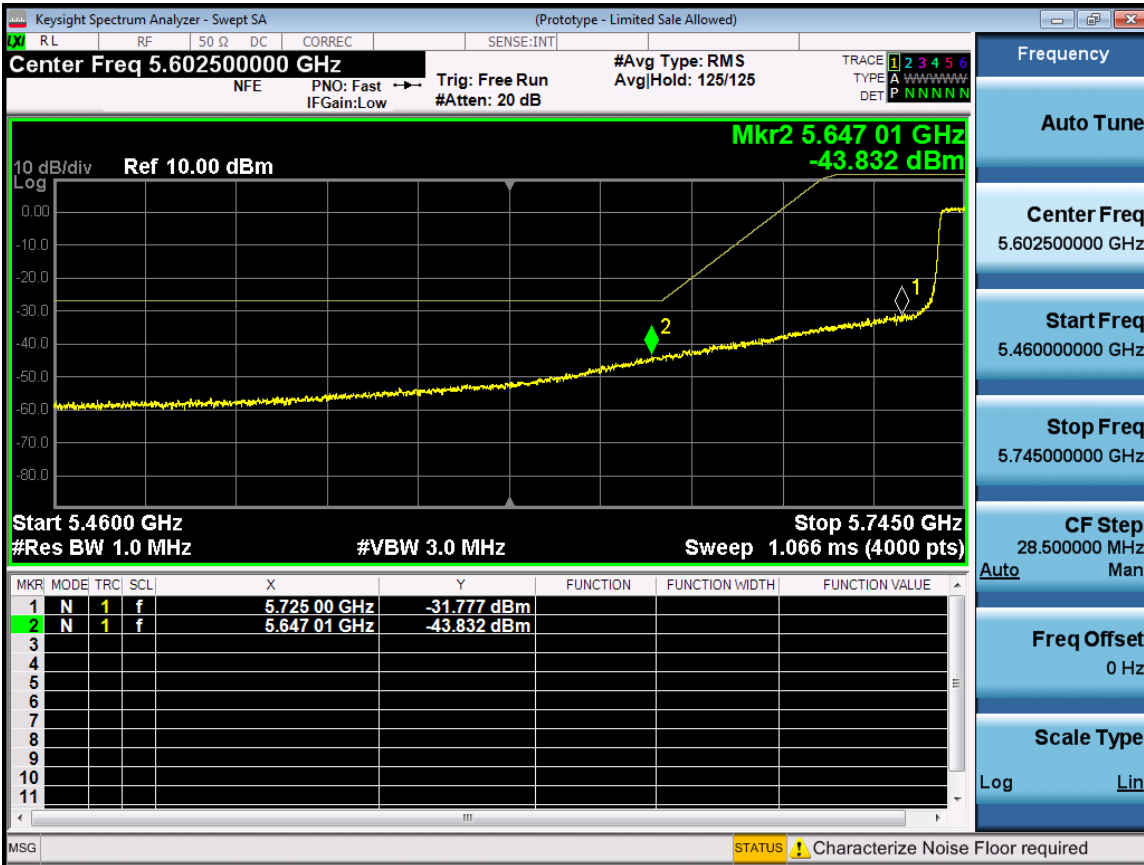

Antenna A

5775 MHz: HE80, M0 to M9 1ss

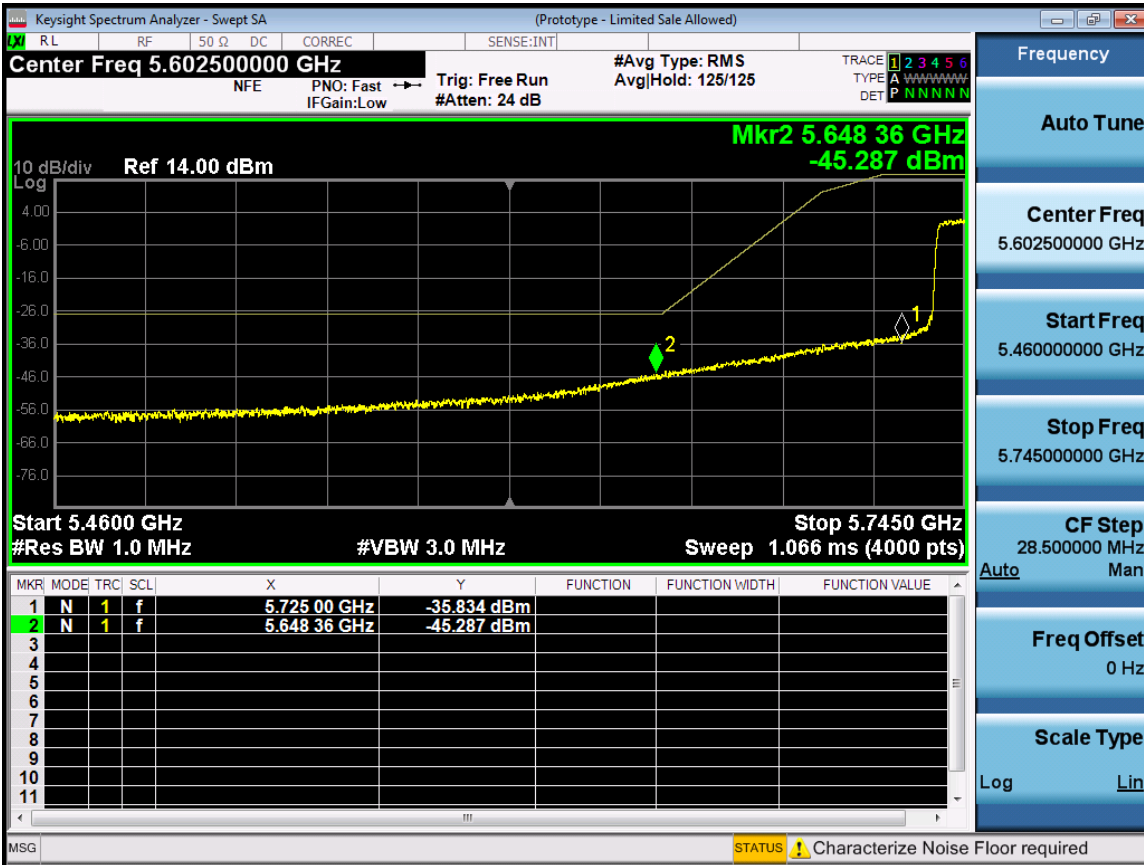

Antenna A

Conducted Bandedge Peak 15407R**Frequency 5785 MHz**

Mode	Tx Paths	Correlated Antenna Gain (dBi)	Tx 1 Bandedge Level (dBm)	Tx 2 Bandedge Level (dBm)	Total Tx Bandedge Level (dBm)	Limit (dB)	Margin (dB)
Non HT20, 6 to 54 Mbps	1	14	-53.6		-39.4	-27	12.35
Non HT20, 6 to 54 Mbps	2	14	-59.4	-62.5	-43.4	-27	16.42
Non HT20 Beam Forming, 6 to 54 Mbps	2	14	-59.4	-62.5	-43.4	-27	16.42
HT/VHT20, M0 to M7	1	14	-55.5		-41.3	-27	14.25
HT/VHT20, M0 to M7	2	14	-59.5	-62.1	-43.3	-27	16.35
HT/VHT20, M8 to M15	2	14	-59.5	-62.1	-43.3	-27	16.35
HT/VHT20 Beam Forming, M0 to M7	2	14	-59.5	-62.1	-43.3	-27	16.35
HT/VHT20 Beam Forming, M8 to M15	2	14	-59.5	-62.1	-43.3	-27	16.35
HT/VHT20 STBC, M0 to M7	2	14	-59.5	-62.1	-43.3	-27	16.35
HE20, M0 to M9 1ss	1	14	-53.9		-39.7	-27	12.65
HE20, M0 to M9 1ss	2	14	-57.7	-51.2	-36.1	-27	9.07
HE20, M0 to M9 2ss	2	14	-57.7	-51.2	-36.1	-27	9.07
HE20 Beam Forming, M0 to M9 1ss	2	14	-57.7	-51.2	-36.1	-27	9.07
HE20 Beam Forming, M0 to M9 2ss	2	14	-57.7	-51.2	-36.1	-27	9.07
HE20 STBC, M0 to M9 2ss	2	14	-57.7	-51.2	-36.1	-27	9.07

Frequency 5795 MHz

Mode	Tx Paths	Correlated Antenna Gain (dBi)	Tx 1 Bandedge Level (dBm)	Tx 2 Bandedge Level (dBm)	Total Tx Bandedge Level (dBm)	Limit (dB)	Margin (dB)
Non HT40, 6 to 54 Mbps	1	14	-51.1		-36.9	-27	9.85
Non HT40, 6 to 54 Mbps	2	14	-59.1	-61.8	-43.0	-27	15.98
HT/VHT40, M0 to M7	1	14	-53.9		-39.7	-27	12.65
HT/VHT40, M0 to M7	2	14	-59.7	-57.2	-41.0	-27	14.01
HT/VHT40, M8 to M15	2	14	-59.7	-57.2	-41.0	-27	14.01
HT/VHT40 Beam Forming, M0 to M7	2	14	-59.7	-57.2	-41.0	-27	14.01
HT/VHT40 Beam Forming, M8 to M15	2	14	-59.7	-57.2	-41.0	-27	14.01
HT/VHT40 STBC, M0 to M7	2	14	-59.7	-57.2	-41.0	-27	14.01
HE40, M0 to M9 1ss	1	14	-53.2		-39.0	-27	11.95
HE40, M0 to M9 1ss	2	14	-57.7	-52.9	-37.4	-27	10.41
HE40, M0 to M9 2ss	2	14	-57.7	-52.9	-37.4	-27	10.41
HE40 Beam Forming, M0 to M9 1ss	2	14	-57.7	-52.9	-37.4	-27	10.41
HE40 Beam Forming, M0 to M9 2ss	2	14	-57.7	-52.9	-37.4	-27	10.41
HE40 STBC, M0 to M9 2ss	2	14	-57.7	-52.9	-37.4	-27	10.41

Frequency 5825 MHz

Mode	Tx Paths	Correlated Antenna Gain (dBi)	Tx 1 Bandedge Level (dBm)	Tx 2 Bandedge Level (dBm)	Total Tx Bandedge Level (dBm)	Limit (dB)	Margin (dB)
Non HT20, 6 to 54 Mbps	1	14	-55.2		-41.0	-27	13.95
Non HT20, 6 to 54 Mbps	2	14	-56.4	-54.0	-37.8	-27	10.78
Non HT20 Beam Forming, 6 to 54 Mbps	2	14	-56.4	-54.0	-37.8	-27	10.78
HT/VHT20, M0 to M7	1	14	-53.8		-39.6	-27	12.55
HT/VHT20, M0 to M7	2	14	-59.5	-57.3	-41.0	-27	14.0
HT/VHT20, M8 to M15	2	14	-59.5	-57.3	-41.0	-27	14.0
HT/VHT20 Beam Forming, M0 to M7	2	14	-59.5	-57.3	-41.0	-27	14.0
HT/VHT20 Beam Forming, M8 to M15	2	14	-59.5	-57.3	-41.0	-27	14.0
HT/VHT20 STBC, M0 to M7	2	14	-59.5	-57.3	-41.0	-27	14.0
HE20, M0 to M9 1ss	1	14	-52.0		-37.8	-27	10.75
HE20, M0 to M9 1ss	2	14	-58.0	-53.5	-37.9	-27	10.93
HE20, M0 to M9 2ss	2	14	-58.0	-53.5	-37.9	-27	10.93
HE20 Beam Forming, M0 to M9 1ss	2	14	-58.0	-53.5	-37.9	-27	10.93
HE20 Beam Forming, M0 to M9 2ss	2	14	-58.0	-53.5	-37.9	-27	10.93
HE20 STBC, M0 to M9 2ss	2	14	-58.0	-53.5	-37.9	-27	10.93

Data Screenshots

5785 MHz: HE20, M0 to M9 1ss

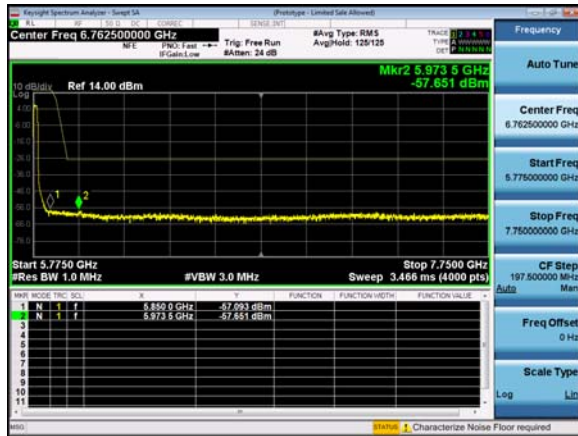

Antenna A

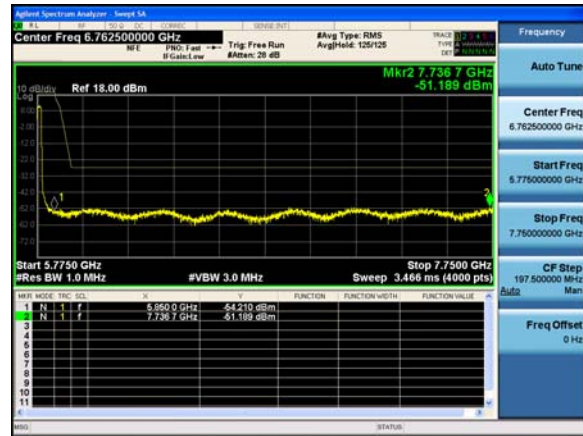

Antenna B

5785 MHz: HE20, M0 to M9 2ss

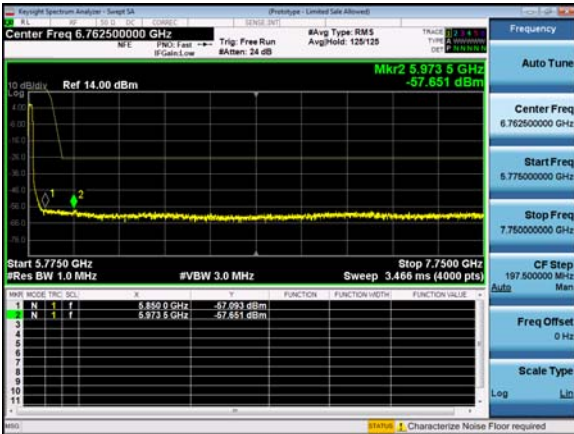

Antenna A

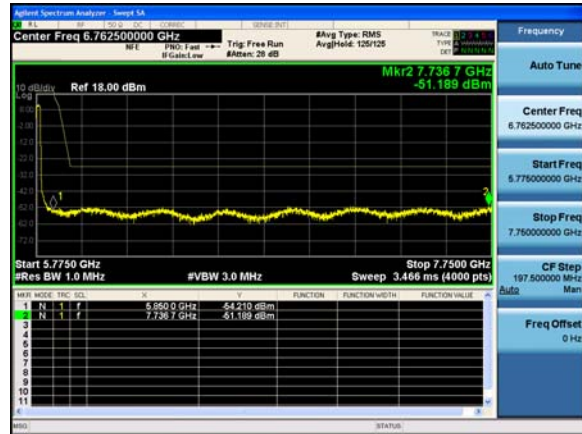

Antenna B

5785 MHz: HE20 Beam Forming, M0 to M9 1ss



Antenna A

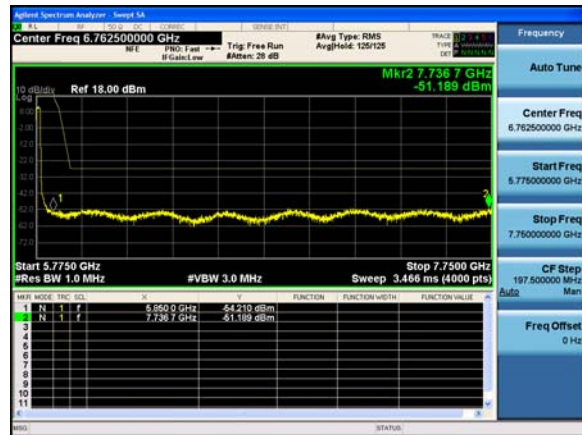

Antenna B

Appendix B: Emission Test Results

Testing Laboratory: Cisco Systems, Inc., 125 West Tasman Drive, San Jose, CA 95134, USA

Radiated Emission Setup Diagram-Below 1G

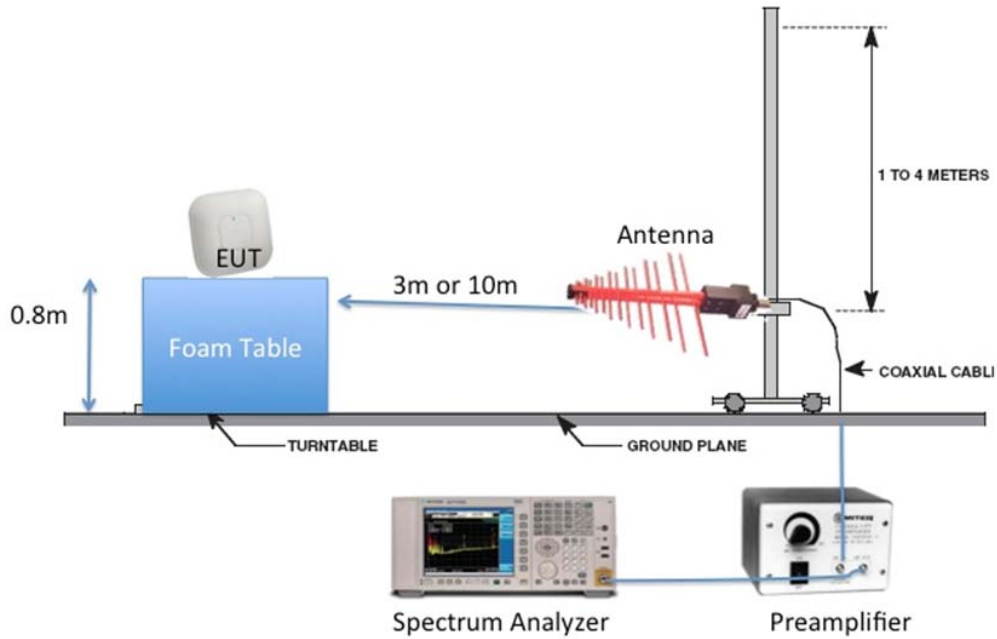

Radiated Emission Setup Diagram-Above 1G

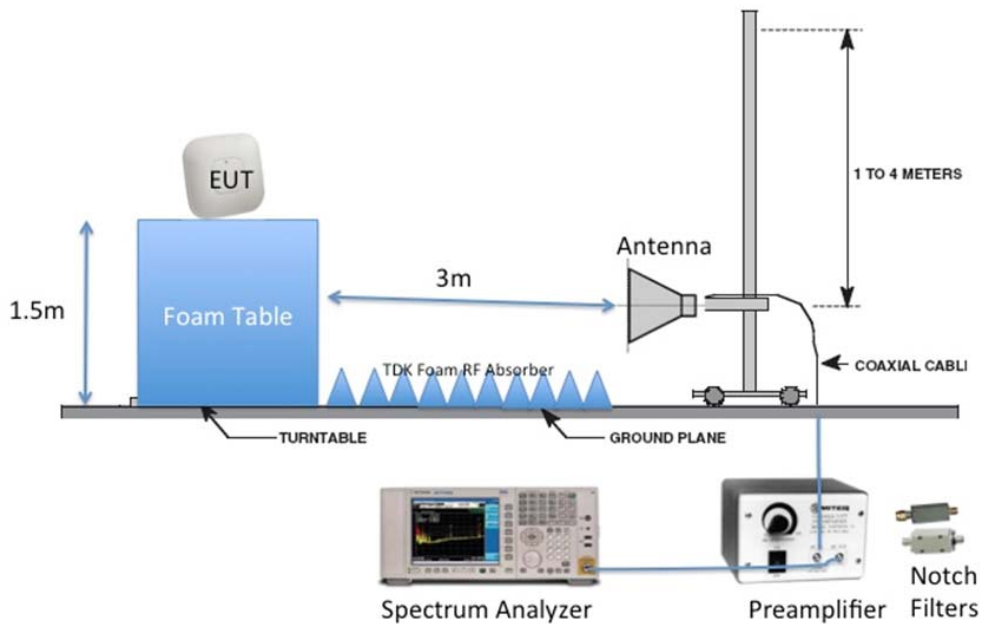

B.1: Radiated Spurious Emissions

FCC 15.205 | 15.407

Radiated emissions which fall in the restricted bands, as defined in Section 15.205(a), must also comply with the radiated emission limits specified in Section 15.209(a) (see Section 15.205(c)).

Not covered by the scope of this test report.

B.2: Radiated Emissions 30MHz to 1GHz

FCC 15.209 | 15.205 | 15.407

Radiated emissions which fall in the restricted bands, as defined in Section 15.205(a), must also comply with the radiated emission limits specified in Section 15.209(a) (see Section 15.205(c)) and RSS-Gen §8.9.

Ref. ANSI C63.10: 2013 section 6.5

Not covered by the scope of this test report.

B.3: AC Conducted Emissions

FCC 15.207

Except when the requirements applicable to a given device state otherwise, for any radio apparatus equipped to operate from the public utility AC power supply, either directly or indirectly (such as with a battery charger), the radio frequency voltage of emissions conducted back onto the AC power lines in the frequency range of 0.15 MHz to 30 MHz shall not exceed the limits shown in the table in these sections. The more stringent limit applies at the frequency range boundaries.

Measurement Procedure

Accordance with ANSI C63.10:2013 section 6.2

Not covered by the scope of this test report.

Appendix C: List of Test Equipment Used to perform the test

Equip#	Manufacturer/ Model	Description	Last Cal	Next Due	Test Item
Test Equipment used for conducted tests – Rack 2					
49515	Keysight (Agilent/HP)/N5182B	MXG X-Series RF Vector Signal Generator	16-Oct-20	16-Oct-21	A.1-A.6
49516	Keysight/ (Agilent/HP)/ N9030A-550	PXA Signal Analyzer, 3Hz to 50GHz	11-Nov-20	11-Nov-21	A.1-A.6
57476	Cisco/Automatio n Test Insertion Loss	Rack 2	Verify Before Use	Verify Before Use	A.1-A.6
46065	National Instruments/ PXI-1042Q	8 slot PXI chassis	Cal Not Required	Cal Not Required	A.1-A.6
57237	National Instruments/ PXI-8115	Embedded Controller	Cal Not Required	Cal Not Required	A.1-A.6
54686	National Instruments/ PXI-2796	40 GHz Dual 6x1 Multiplexer (SP6T)	Verify Before Use	Verify Before Use	A.1-A.6
57245	National Instruments/ PXI-2799	Switch 1x1	Verify Before Use	Verify Before Use	A.1-A.6
56091	National Instruments/ PXI-2796	40 GHz Dual 6x1 Multiplexer (SP6T)	Verify Before Use	Verify Before Use	A.1-A.6
54235	PASTERNAK/ PE5019-1	Torque Wrench	9-Mar-21	9-Mar-22	A.1-A.6
58256	COMET/ T7611- 4	WEB SENSOR FOR REMOTE THERMOMETE R HYGROMETER	3-Feb-21	3-Feb-22	A.1-A.6

Equip#	Manufacturer/ Model	Description	Last Cal	Next Due	Test Item
Test Equipment used for conducted tests – Rack 3					
55108	Keysight/ (Agilent/HP)/ N9030A-550	PXA Signal Analyzer, 3Hz to 50GHz	03-Feb-21	03-Feb-22	A.1-A.6
57476	Cisco/Automatio n Test Insertion Loss	Rack 3	Verify Before Use	Verify Before Use	A.1-A.6
55093	National Instruments/ PXI-1042Q	8 slot PXI chassis	Cal Not Required	Cal Not Required	A.1-A.6
57238	National Instruments/ PXI-8115	Embedded Controller	Cal Not Required	Cal Not Required	A.1-A.6
57247	National Instruments/ PXI-2796	40 GHz Dual 6x1 Multiplexer (SP6T)	Verify Before Use	Verify Before Use	A.1-A.6
57248	National Instruments/ PXI-2799	Switch 1x1	Verify Before Use	Verify Before Use	A.1-A.6
56092	National Instruments/ PXI-2796	40 GHz Dual 6x1 Multiplexer (SP6T)	Verify Before Use	Verify Before Use	A.1-A.6
54235	PASTERNAK/ PE5019-1	Torque Wrench	9-Mar-21	9-Mar-22	A.1-A.6
58256	COMET/ T7611- 4	WEB SENSOR FOR REMOTE THERMOMETE R HYGROMETER	3-Feb-21	3-Feb-22	A.1-A.6

Equip#	Manufacturer/ Model	Description	Last Cal	Next Due	Test Item
Test Equipment used for conducted tests – Rack 8					
58720	Cisco/Automation Test Insertion Loss	Rack 8	Verify Before Use	Verify Before Use	A.1-A.6
57562	Keysight (Agilent/HP) / N9030B-550 OPT LNP EP0	PXA Signal Analyzer, 2Hz-50GHz with Options LNP and EP0	28-Jul-21	28-Jul-22	A.1-A.6
58205	NATIONAL INSTRUMENTS / PXIe-1062Q	CHASSIS	Cal Not Required	Cal Not Required	A.1-A.6
58206	NATIONAL INSTRUMENTS / PXIe-8840	Up to 2.6 GHz Quad-Core PXI Express Controller	Cal Not Required	Cal Not Required	A.1-A.6
58208	NATIONAL INSTRUMENTS / PXI-2796	40 GHz Dual 6x1 Multiplexer (SP6T)	Verify Before Use	Verify Before Use	A.1-A.6
58210	NATIONAL INSTRUMENTS / PXI-2796	40 GHz Dual 6x1 Multiplexer (SP6T)	Verify Before Use	Verify Before Use	A.1-A.6
58211	NATIONAL INSTRUMENTS / PXI-2799	Switch 1x1	Verify Before Use	Verify Before Use	A.1-A.6
54235	PASTERNAK/ PE5019-1	Torque Wrench	9-Mar-21	9-Mar-22	A.1-A.6
58256	COMET/ T7611-4	WEB SENSOR FOR REMOTE THERMOMETER HYGROMETER	3-Feb-21	3-Feb-22	A.1-A.6

Equipment #	Manufacturer/ Model	Description	Last Cal	Next Due	Test Item
Test Equipment used for conducted tests – Rack 9					
58719	Cisco/Automation Test Insertion Loss	Rack 9	Verify Before Use	Verify Before Use	A.1-A.6
53614	Keysight (Agilent/HP)/ N9030B-550 OPT LNP EP0	PXA Signal Analyzer, 2Hz-50GHz with Options LNP and EP0	1-Jul-21	1-Jul-22	A.1-A.6
58231	NATIONAL INSTRUMENTS / PXIe-1062Q	CHASSIS	Cal Not Required	Cal Not Required	A.1-A.6
58232	NATIONAL INSTRUMENTS / PXIe-8840	Up to 2.6 GHz Quad-Core PXI Express Controller	Cal Not Required	Cal Not Required	A.1-A.6
58234	NATIONAL INSTRUMENTS / PXI-2796	40 GHz Dual 6x1 Multiplexer (SP6T)	Verify Before Use	Verify Before Use	A.1-A.6
58236	NATIONAL INSTRUMENTS / PXI-2796	40 GHz Dual 6x1 Multiplexer (SP6T)	Verify Before Use	Verify Before Use	A.1-A.6
58237	NATIONAL INSTRUMENTS / PXI-2799	Switch 1x1	Verify Before Use	Verify Before Use	A.1-A.6
54235	PASTERNAK/ PE5019-1	Torque Wrench	9-Mar-21	9-Mar-22	A.1-A.6
58256	COMET/ T7611-4	WEB SENSOR FOR REMOTE THERMOMETER HYGROMETER	3-Feb-21	3-Feb-22	A.1-A.6

Equip#	Manufacturer/ Model	Description	Last Cal	Next Due	Test Item
Test Equipment used for conducted tests – Rack 4					
57478	Cisco/Automation Test Insertion Loss	Rack 4	Verify Before Use	Verify Before Use	A.1-A.6
58702	Keysight (Agilent/HP)/ N9030B-550	PXA Signal Analyzer, 2Hz- 50GHz	15-Oct-20	15-Oct-21	A.1-A.6
55096	National Instruments/ PXI- 1042	CHASSIS, PXI	Cal Not Required	Cal Not Required	A.1-A.6
57239	National Instruments/ PXI- 8115	Embedded Controller	Cal Not Required	Cal Not Required	A.1-A.6
57250	National Instruments/ PXI- 2796	40 GHz Dual 6x1 Multiplexer (SP6T)	Verify Before Use	Verify Before Use	A.1-A.6
57251	National Instruments/ PXI- 2799	Switch 1x1	Verify Before Use	Verify Before Use	A.1-A.6
56093	National Instruments/ PXI-2796	40 GHz Dual 6x1 Multiplexer (SP6T)	Verify Before Use	Verify Before Use	A.1-A.6
54235	PASTERNAK/ PE5019-1	Torque Wrench	9-Mar-21	9-Mar-22	A.1-A.6
58256	COMET/ T7611- 4	WEB SENSOR FOR REMOTE THERMOMETER HYGROMETER	3-Feb-21	3-Feb-22	A.1-A.6

Appendix D: Abbreviation Key and Definitions

The following table defines abbreviations used within this test report.

Abbreviation	Description	Abbreviation	Description
EMC	Electro Magnetic Compatibility	°F	Degrees Fahrenheit
EMI	Electro Magnetic Interference	°C	Degrees Celsius
EUT	Equipment Under Test	Temp	Temperature
ITE	Information Technology Equipment	S/N	Serial Number
TAP	Test Assessment Schedule	Qty	Quantity
ESD	Electro Static Discharge	emf	Electromotive force
EFT	Electric Fast Transient	RMS	Root mean square
EDCS	Engineering Document Control System	Qp	Quasi Peak
Config	Configuration	Av	Average
CIS#	Cisco Number (unique identification number for Cisco test equipment)	Pk	Peak
Cal	Calibration	kHz	Kilohertz (1x10 ³)
EN	European Norm	MHz	MegaHertz (1x10 ⁶)
IEC	International Electro technical Commission	GHz	Gigahertz (1x10 ⁹)
CISPR	International Special Committee on Radio Interference	H	Horizontal
CDN	Coupling/Decoupling Network	V	Vertical
LISN	Line Impedance Stabilization Network	dB	decibel
PE	Protective Earth	V	Volt
GND	Ground	kV	Kilovolt (1x10 ³)
L1	Line 1	µV	Microvolt (1x10 ⁻⁶)
L2	Line2	A	Amp
L3	Line 3	µA	Micro Amp (1x10 ⁻⁶)
DC	Direct Current	mS	Milli Second (1x10 ⁻³)
RAW	Uncorrected measurement value, as indicated by the measuring device	µS	Micro Second (1x10 ⁻⁶)
RF	Radio Frequency	µS	Micro Second (1x10 ⁻⁶)
SLCE	Signal Line Conducted Emissions	m	Meter
Meas dist	Measurement distance	Spec dist	Specification distance
N/A or NA	Not Applicable	SL	Signal Line (or Telecom Line)
P	Power Line	L	Live Line
N	Neutral Line	R	Return
S	Supply	AC	Alternating Current

Appendix E: Photographs of Test Setups

EUT Photos have been omitted from this test report. Photos can be found in the supplementary exhibit included in the submission and EDCS# 22609793.

Appendix F: Software Used to Perform Testing

Cisco Internal LabView Radio Test Automation Software:

RF Automation Main versions: 201, 205, 210, 212, 214, 220
RF Domain Report Generation - version 3

Appendix G: Test Procedures

Measurements were made in accordance with:

- KDB Publication No. 789033 - D02 General UNII Test Procedures New Rules v02r01
- KDB Publication No. 662911 - MIMO
- ANSI C63.4 2014 Unintentional Radiators
- ANSI C63.10 2013 Intentional Radiators

Test procedures are summarized below:

FCC 5GHz Test Procedures	EDCS # 1445048
FCC 5GHz RSE Test Procedures	EDCS # 1511600

Appendix H: Scope of Accreditation (A2LA certificate number 1178-01)

The scope of accreditation of Cisco Systems, Inc. can be found on the A2LA web page at:

<http://www.a2la.org/scopepdf/1178-01.pdf>

Appendix I: Test Assessment Plan

Compliance Test Plan (Excel) EDCS# 21468207
Target Power Tables EDCS# 21389500

Appendix J: Worst Case Justification

N/A

End