

Formal Radio Test Report

FCC ID: LDK-ETHIK2360

C9124AXE-B

Cisco Catalyst C9124AX Series 802.11ax Access Point
5 GHz Primary Radio



5150 – 5250 MHz

Against the following Specifications:

CFR47 Part 15.407



Cisco Systems
170 West Tasman Drive
San Jose, CA 95134

	
Author: Johanna Knudsen, Nathan Sousa Tested By: Johanna Knudsen, Julian Land, & Mathew Blackburn	Approved By: Sam Kim Title: Manager, Radio Compliance Revision: 1

This report replaces any previously entered test report under EDCS – 22656207. This test report has been electronically authorized and archived using the CISCO Engineering Document Control system. Test Report Template EDCS# 11644122.

SECTION 1: OVERVIEW	3
SECTION 2: ASSESSMENT INFORMATION	4
2.1: GENERAL	4
2.2: DATE OF TESTING	5
2.3: REPORT ISSUE DATE	5
2.4: TESTING FACILITIES	5
2.5: EQUIPMENT ASSESSED (EUT)	6
2.6: EUT DESCRIPTION.....	6
SECTION 3: RESULT SUMMARY	8
3.1: RESULTS SUMMARY TABLE	8
SECTION 4: SAMPLE DETAILS	11
4.1: SAMPLE DETAILS	11
4.2: SYSTEM DETAILS.....	11
4.3: MODE OF OPERATION DETAILS.....	12
APPENDIX A: EMISSION TEST RESULTS	13
A.1: DUTY CYCLE	14
A.2: 99% AND 26DB BANDWIDTH.....	17
A.3: MAXIMUM CONDUCTED OUTPUT POWER.....	21
A.4: POWER SPECTRAL DENSITY	47
A.5: CONDUCTED SPURIOUS EMISSIONS.....	61
A.6: CONDUCTED BAND EDGE.....	89
APPENDIX B: EMISSION TEST RESULTS	103
B.1: RADIATED SPURIOUS EMISSIONS	104
B.2: RADIATED EMISSIONS 30MHZ TO 1GHZ.....	105
B.3: AC CONDUCTED EMISSIONS	106
APPENDIX C: LIST OF TEST EQUIPMENT USED TO PERFORM THE TEST	107
APPENDIX D: ABBREVIATION KEY AND DEFINITIONS	112
APPENDIX E: PHOTOGRAPHS OF TEST SETUPS	113
APPENDIX F: SOFTWARE USED TO PERFORM TESTING	113
APPENDIX G: TEST PROCEDURES	113
APPENDIX H: SCOPE OF ACCREDITATION (A2LA CERTIFICATE NUMBER 1178-01)	113
APPENDIX I: TEST ASSESSMENT PLAN	113
APPENDIX J: WORST CASE JUSTIFICATION	113

Section 1: Overview

The samples were assessed against the tests detailed in section 3 under the requirements of the following specifications:

Specifications:
CFR47 Part 15.407

Section 2: Assessment Information

2.1: General

This report contains an assessment of an apparatus against Electromagnetic Compatibility Standards based upon tests carried out on the samples submitted. The testing was performed by and for the use of Cisco systems Inc:

With regard to this assessment, the following points should be noted:

- a) The results contained in this report relate only to the items tested and were obtained in the period between the date of the initial assessment and the date of issue of the report. Manufactured products will not necessarily give identical results due to production and measurement tolerances.
- b) The apparatus was set up and exercised using the configuration and modes of operation defined in this report only.
- c) Where relevant, the apparatus was only assessed using the susceptibility criteria defined in this report and the Test Assessment Plan (TAP).
- d) All testing was performed under the following environmental conditions:

Temperature	15 °C to 35 °C (54 °F to 95 °F)
Atmospheric Pressure	860 mbar to 1060 mbar (25.4" to 31.3")
Humidity	10% to 75*%

- e) All AC testing was performed at one or more of the following supply voltages:

110V 60 Hz (+/-20%)

Units of Measurement

The units of measurements defined in the appendices are reported in specific terms, which are test dependent. Where radiated measurements are concerned these are defined at a particular distance. Basic voltage measurements are defined in units of [dBuV]

As an example, the basic calculation for all measurements is as follows:

$$\text{Emission level [dBuV]} = \text{Indicated voltage level [dBuV]} + \text{Cable Loss [dB]} + \text{Other correction factors [dB]}$$

The combinations of correction factors are dependent upon the exact test configurations [see test equipment lists for further details] and may include:

Antenna Factors, Pre-Amplifier Gain, LISN Loss, Pulse Limiter Loss and Filter Insertion Loss

Note: To convert the results from dBuV/m to uV/m use the following formula:

$$\text{Level in uV/m} = \text{Common Antilogarithm} [(X \text{ dBuV/m})/20] = Y \text{ uV/m}$$

Measurement Uncertainty Values

voltage and power measurements	± 2 dB
conducted EIRP measurements	± 1.4 dB
radiated measurements	± 3.2 dB
frequency measurements	± 2.4 10 ⁻⁷
temperature measurements	± 0.54°
humidity measurements	± 2.3%
DC and low frequency measurements	± 2.5%

Where relevant measurement uncertainty levels have been estimated for tests performed on the apparatus. This uncertainty represents an expanded uncertainty expressed at approximately the 95% confidence level using a coverage factor of $k=2$.

Radiated emissions (expanded uncertainty, confidence interval 95%)

30 MHz – 300 MHz	± 3.8 dB
300 MHz – 1000 MHz	± 4.3 dB
1 GHz – 10 GHz	± 4.0 dB
10 GHz – 18GHz	± 8.2 dB
18GHz – 26.5GHz	± 4.1 dB
26.5GHz – 40GHz	± 3.9 dB

Conducted emissions (expanded uncertainty, confidence interval 95%)

30 MHz – 40 GHz	± 0.38 dB
-----------------	---------------

A product is considered to comply with a requirement if the nominal measured value is below the limit line. The product is considered to not be in compliance in case the nominal measured value is above the limit line.

This report must not be reproduced except in full, without written approval of Cisco Systems.

2.2: Date of testing

26-JUL-2021 to 28-AUG-2021; 01-SEP-2021 to 04-SEP-2021; 11-SEP-2021 to 14-SEP-2021

2.3: Report Issue Date

6-DEC-21

Cisco uses an electronic system to issue, store and control the revision of test reports. This system is called the Engineering Document Control System (EDCS). The actual report issue date is embedded into the original file on EDCS. Any copies of this report, either electronic or paper, that are not on EDCS must be considered uncontrolled.

2.4: Testing facilities

This assessment was performed by:

Testing Laboratory
Cisco Systems, Inc.
125 West Tasman Drive (Building P)
San Jose, CA 95134
USA

Headquarters
Cisco Systems, Inc.,
170 West Tasman Drive
San Jose, CA 95134,
USA

Registration Numbers for Industry Canada

Cisco System Site	Address	Site Identifier
Building P, 10m Chamber	125 West Tasman Dr San Jose, CA 95134	Company #: 2461N-2
Building P, 5m Chamber	125 West Tasman Dr San Jose, CA 95134	Company #: 2461N-1
Building 7, 5m Chamber	425 E. Tasman Drive San Jose, California 95134 United States	Company #: 2461N-3

Test Engineer(s):

Johanna Knudsen, Julian Land, Mathew Blackburn

2.5: Equipment Assessed (EUT)

C9124AXE

2.6: EUT Description

The Cisco Catalyst 9124AX Series outdoor access points are next-generation Wi-Fi 6 access points encased in a rugged and robust design that service providers and enterprises can easily deploy.

The radio supports the following modes of operation. The modes are further defined in the radio Theory of Operation. The modes included in this report represent the worst-case data for all modes.

802.11a non-HT20 (6 – 54 Mbps)
 802.11a non-HT20 Beam Forming (6 – 54 Mbps)
 802.11n/ac HT/VHT20 (MCS0 – MCS31)
 802.11n/ac HT/VHT20 Beam Forming (MCS0 – MCS31)
 802.11n/ac HT/VHT20 STBC (MCS0 – MCS7)
 802.11ax HE20 (MCS0 – MCS9) 1 SS
 802.11ax HE20 (MCS0 – MCS9) 2 SS
 802.11ax HE20 (MCS0 – MCS9) 3 SS
 802.11ax HE20 (MCS0 – MCS9) 4 SS
 802.11ax HE20 Beam Forming (MCS0 – MCS9) 1 SS
 802.11ax HE20 Beam Forming (MCS0 – MCS9) 2 SS
 802.11ax HE20 Beam Forming (MCS0 – MCS9) 3 SS
 802.11ax HE20 Beam Forming (MCS0 – MCS9) 4 SS
 802.11ax HE20 STBC (MCS0 – MCS9) 2 SS

802.11a non-HT40 (6 – 54 Mbps)
 802.11n/ac HT/VHT40 (MCS0 – MCS31)
 802.11n/ac HT/VHT40 Beam Forming (MCS0 – MCS31)
 802.11n/ac HT/VHT40 STBC (MCS0 – MCS7)
 802.11ax HE40 (MCS0 – MCS9) 1 SS
 802.11ax HE40 (MCS0 – MCS9) 2 SS
 802.11ax HE40 (MCS0 – MCS9) 3 SS
 802.11ax HE40 (MCS0 – MCS9) 4 SS
 802.11ax HE40 Beam Forming (MCS0 – MCS9) 1 SS
 802.11ax HE40 Beam Forming (MCS0 – MCS9) 2 SS
 802.11ax HE40 Beam Forming (MCS0 – MCS9) 3 SS
 802.11ax HE40 Beam Forming (MCS0 – MCS9) 4 SS
 802.11ax HE40 STBC (MCS0 – MCS9) 2 SS

802.11a non-HT80 (6 – 54 Mbps)
 802.11n/ac HT/VHT80 (MCS0 – MCS9) 1 SS
 802.11n/ac HT/VHT80 (MCS0 – MCS9) 2 SS
 802.11n/ac HT/VHT80 (MCS0 – MCS9) 3 SS
 802.11n/ac HT/VHT80 (MCS0 – MCS9) 4 SS
 802.11n/ac HT/VHT80 Beam Forming (MCS0 – MCS9) 1 SS

802.11n/ac HT/VHT80 Beam Forming (MCS0 – MCS9) 2 SS
 802.11n/ac HT/VHT80 Beam Forming (MCS0 – MCS9) 3 SS
 802.11n/ac HT/VHT80 Beam Forming (MCS0 – MCS9) 4 SS
 802.11n/ac HT/VHT80 STBC (MCS0 – MCS9) 1 SS
 802.11ax HE80 (MCS0 – MCS9) 1 SS
 802.11ax HE80 (MCS0 – MCS9) 2 SS
 802.11ax HE80 (MCS0 – MCS9) 3 SS
 802.11ax HE80 (MCS0 – MCS9) 4 SS
 802.11ax HE80 Beam Forming (MCS0 – MCS9) 1 SS
 802.11ax HE80 Beam Forming (MCS0 – MCS9) 2 SS
 802.11ax HE80 Beam Forming (MCS0 – MCS9) 3 SS
 802.11ax HE80 Beam Forming (MCS0 – MCS9) 4 SS
 802.11ax HE80 STBC (MCS0 – MCS9) 1 SS

The following antennas are supported by this product series. Please note, the antenna information has been provided by the customer (the Cisco business unit). The data included in this report represent the worst-case data for all antennas.

Frequency	Antenna Name		Antenna Gain
5 GHz	TX/RX: External	Antenna 1	14 dBi (Side Lobe: 5 dBi)

Section 3: Result Summary

3.1: Results Summary Table

Conducted emissions

Basic Standard	Technical Requirements / Details	Result
FCC 15.407	<p>99% & 26 dB Bandwidth: The 99% occupied bandwidth is the frequency bandwidth such that, below its lower and above its upper frequency limits, the mean powers are each equal to 0.5% of the total mean power of the given emission. There is no limit for 99% OBW.</p> <p>The 26 dB emission is the width of the emission that is constrained by the frequencies associated with the two outermost amplitude points (upper and lower frequencies) that are attenuated by 26 dB relative to the maximum level measured in the fundamental emission.</p>	Pass
FCC 15.407	<p>Output Power: (1) For the band 5.15-5.25 GHz.</p> <p>(i) For an outdoor access point operating in the band 5.15-5.25 GHz, the maximum conducted output power over the frequency band of operation shall not exceed 1 W provided the maximum antenna gain does not exceed 6 dBi. ...If transmitting antennas of directional gain greater than 6 dBi are used, both the maximum conducted output power ...shall be reduced by the amount in dB that the directional gain of the antenna exceeds 6 dBi. The maximum e.i.r.p. at any elevation angle above 30 degrees as measured from the horizon must not exceed 125 mW (21 dBm).</p> <p>(ii) For an indoor access point operating in the band 5.15-5.25 GHz, the maximum conducted output power over the frequency band of operation shall not exceed 1 W provided the maximum antenna gain does not exceed 6 dBi. ... If transmitting antennas of directional gain greater than 6 dBi are used, both the maximum conducted output power and the maximum power spectral density shall be reduced by the amount in dB that the directional gain of the antenna exceeds 6 dBi.</p> <p>(iii) For fixed point-to-point access points operating in the band 5.15-5.25 GHz, the maximum conducted output power over the frequency band of operation shall not exceed 1 W. ...Fixed point-to-point U-NII devices may employ antennas with directional gain up to 23 dBi without any corresponding reduction in the maximum conducted output power or maximum power spectral density. For fixed point-to-point transmitters that employ a directional antenna gain greater than 23 dBi, a 1 dB reduction in maximum conducted output power and maximum power spectral density is required for each 1 dB of antenna gain in excess of 23 dBi. Fixed, point-to-point operations exclude the use of point-to-multipoint systems, omnidirectional applications, and multiple collocated transmitters transmitting the same information. The operator of the U-NII device, or if the equipment is professionally installed, the installer, is responsible for ensuring that systems employing high gain directional antennas are used exclusively for fixed, point-to-point operations.</p> <p>(iv) For mobile and portable client devices in the 5.15-5.25 GHz band, the maximum conducted output power over the frequency band of operation shall not exceed 250 mW provided the maximum antenna gain does not exceed 6 dBi. In addition, the maximum power spectral density shall not exceed 11 dBm in any 1 megahertz band. If transmitting antennas of directional gain greater than 6 dBi are used, both the maximum conducted output power and the maximum power spectral density shall be reduced by the amount in dB that the directional gain of the antenna exceeds 6 dBi.</p>	Pass

FCC 15.407	<p>Power Spectral Density:</p> <p>(i) For an outdoor access point operating in the band 5.15-5.25 GHz...the maximum power spectral density shall not exceed 17 dBm in any 1 megahertz band. If transmitting antennas of directional gain greater than 6 dBi are used, both the maximum conducted output power and the maximum power spectral density shall be reduced by the amount in dB that the directional gain of the antenna exceeds 6 dBi. The maximum e.i.r.p. at any elevation angle above 30 degrees as measured from the horizon must not exceed 125 mW (21 dBm).</p> <p>(ii) For an indoor access point operating in the band 5.15-5.25 GHz... the maximum power spectral density shall not exceed 17 dBm in any 1 megahertz band. If transmitting antennas of directional gain greater than 6 dBi are used, both the maximum conducted output power and the maximum power spectral density shall be reduced by the amount in dB that the directional gain of the antenna exceeds 6 dBi.</p> <p>(iii) For fixed point-to-point access points operating in the band 5.15-5.25 GHz ...the maximum power spectral density shall not exceed 17 dBm in any 1 megahertz band. Fixed point-to-point U-NII devices may employ antennas with directional gain up to 23 dBi without any corresponding reduction in the ... maximum power spectral density. For fixed point-to-point transmitters that employ a directional antenna gain greater than 23 dBi, a 1 dB reduction in maximum conducted output power and maximum power spectral density is required for each 1 dB of antenna gain in excess of 23 dBi. Fixed, point-to-point operations exclude the use of point-to-multipoint systems, omnidirectional applications, and multiple collocated transmitters transmitting the same information. The operator of the U-NII device, or if the equipment is professionally installed, the installer, is responsible for ensuring that systems employing high gain directional antennas are used exclusively for fixed, point-to-point operations.</p> <p>(iv) For mobile and portable client devices in the 5.15-5.25 GHz band...the maximum power spectral density shall not exceed 11 dBm in any 1 megahertz band. If transmitting antennas of directional gain greater than 6 dBi are used... the maximum power spectral density shall be reduced by the amount in dB that the directional gain of the antenna exceeds 6 dBi.</p>	Pass
FCC 15.407	<p>Conducted Spurious Emissions / Band-Edge:</p> <p>For transmitters operating in the 5.15-5.25 GHz band: all emissions outside of the 5.15-5.35 GHz band shall not exceed an EIRP of -27dBm/MHz.</p>	Pass
FCC 15.407 FCC 15.209 FCC 15.205	<p>Restricted band:</p> <p>Unwanted emissions falling within the restricted bands, as defined in FCC 15.205 (a) must also comply with the radiated emission limits specified in FCC 15.209 (a)</p>	Pass

Radiated Emissions (General requirements)

Basic Standard	Technical Requirements / Details	Result
FCC 15.209 FCC 15.205	<p>TX Spurious Emissions: Except as provided elsewhere in this subpart, the emissions from an intentional radiator shall not exceed the field strength levels specified in the field strength limits table in this section.</p>	Not covered in the scope of this report
FCC 15.207	<p>AC Conducted Emissions: Except when the requirements applicable to a given device state otherwise, for any radio apparatus equipped to operate from the public utility AC power supply, either directly or indirectly (such as with a battery charger), the radio frequency voltage of emissions conducted back onto the AC power lines in the frequency range of 0.15 MHz to 30 MHz shall not exceed the limits shown in the table in these sections. The more stringent limit applies at the frequency range boundaries.</p>	Not covered in the scope of this report

Section 4: Sample Details

Note: Each sample was evaluated to ensure that its condition was suitable to be used as a test sample prior to the commencement of testing.

4.1: Sample Details

Sample No.	Equipment Details	Manufacturer	Hardware Rev.	Serial Number
S01	C9124AXE-B (Used in Rack 2)	Foxconn (For Cisco)	PP	FOC25028JEV
S02	C9124AXE-B (Used in Rack 3)	Foxconn (For Cisco)	PP	FOC25042JPW
S03	C9124AXE-B (Used in Rack 8)	Foxconn (For Cisco)	PP	FOC252811S1
S04	C9124AXE-B (Used in Rack 8)	Foxconn (For Cisco)	PP	FOC25292AQ4
S05	C9124AXE-B (Used in Rack 9)	Foxconn (For Cisco)	PP	FOC25220CP1
S06	C9124AXE-B (Used in Rack 9)	Foxconn (For Cisco)	PP	FOC25292APS
S07	C9124AXE-B (Used in Rack 9)	Foxconn (For Cisco)	PP	FOC25028JFG
S08	C9124AXE-B (Used in Rack 4)	Foxconn (For Cisco)	PP	FOC25028JBJ

4.2: System Details

System #	Description	Samples
1	EUT (used in Rack 2)	S01
2	EUT (used in Rack 3)	S02
3	EUT (used in Rack 8)	S03
3	EUT (used in Rack 8)	S04
4	EUT (used in Rack 9)	S05
4	EUT (used in Rack 9)	S06
4	EUT (used in Rack 9)	S07
5	EUT (used in Rack 4)	S08

4.3: Mode of Operation Details

Mode#	Description	Comments
1	Continuously Transmitting Testing using Rack 2	AP Running Image: 8.8.1.10 Cisco AP Software, (ap1g6a), [cheetah-build9:/san1/BUILD/workspace/c176_throttle_mfg/label/mfg-ap1g6a] Compiled Wed Jul 7 22:15:45 GMT 2021
2	Continuously Transmitting Testing using Rack 3	AP Running Image: 8.8.1.10 Cisco AP Software, (ap1g6a), [cheetah-build9:/san1/BUILD/workspace/c176_throttle_mfg/label/mfg-ap1g6a] Compiled Wed Jul 7 22:15:45 GMT 2021
3	Continuously Transmitting Testing using Rack 8 23-JUL-2021 to 23-AUG-2021	AP Running Image: 8.8.1.10 Cisco AP Software, (ap1g6a), [cheetah-build9:/san1/BUILD/workspace/c176_throttle_mfg/label/mfg-ap1g6a] Compiled Wed Jul 14 22:18:33 GMT 2021
3	Continuously Transmitting Testing using Rack 8 24-AUG-2021	AP Running Image: 8.8.1.10 Cisco AP Software, (ap1g6a), [sjc-ads-5182:/nobackup/maruthib/c176lthaca] Compiled Wed Jul 28 23:16:09 PDT 2021
4	Continuously Transmitting Testing using Rack 9 26-JUL-2021 to 25-AUG-2021	AP Running Image: 8.8.1.10 Cisco AP Software, (ap1g6a), [cheetah-build9:/san1/BUILD/workspace/c176_throttle_mfg/label/mfg-ap1g6a] Compiled Wed Jul 14 22:18:33 GMT 2021
5	Continuously Transmitting Testing using Rack 9 26-AUG-2021	AP Running Image: 8.8.1.10 Cisco AP Software, (ap1g6a), [sjc-ads-5182:/nobackup/maruthib/c176lthaca] Compiled Wed Jul 28 23:16:09 PDT 2021
6	Continuously Transmitting Testing using Rack 9 23-JUL-2021 to 25-JUL-2021	AP Running Image: 8.8.1.10 Cisco AP Software, (ap1g6a), [cheetah-build9:/san1/BUILD/workspace/c175_throttle_mfg/label/mfg-ap1g6a] Compiled Wed Apr 14 18:59:06 GMT 2021
7	Continuously Transmitting Testing using Rack 4	AP Running Image: 8.8.1.10 Cisco AP Software, (ap1g6a), [cheetah-build9:/san1/BUILD/workspace/c175_throttle_mfg/label/mfg-ap1g6a] Compiled Wed Apr 14 18:59:06 GMT 2021

Appendix A: Emission Test Results

Conducted Test Setup Diagram

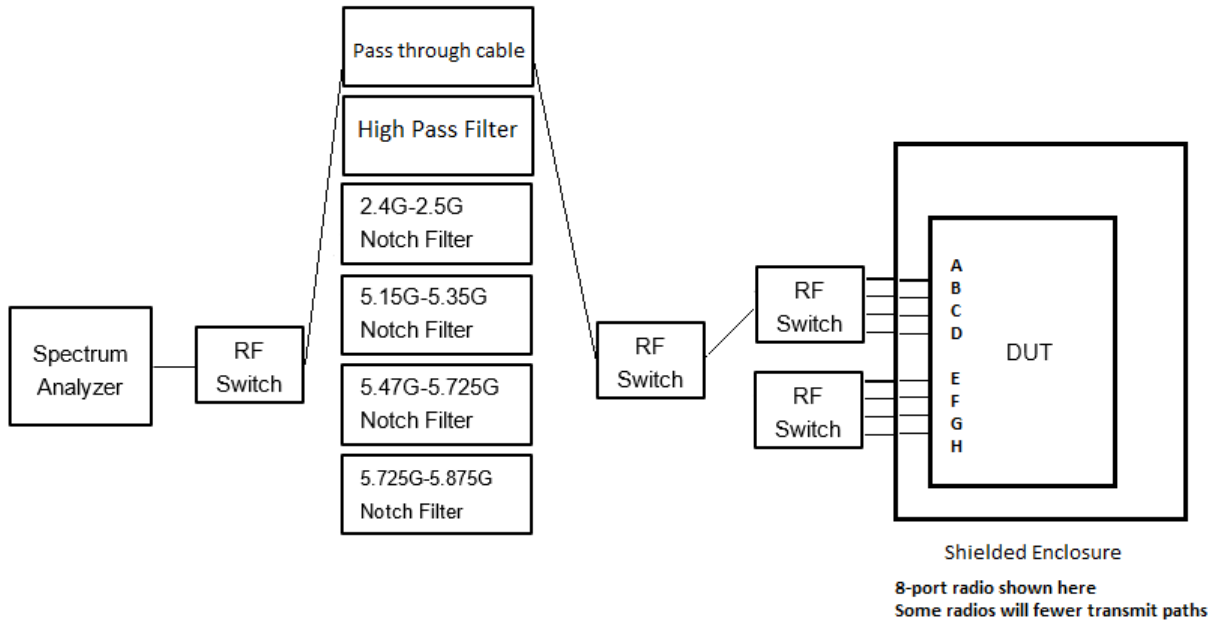

A.1: Duty Cycle

Duty Cycle Test Requirement

From KDB 789033 D02 General UNII Test Procedures New Rules v02r01

B. Duty Cycle (x), Transmission Duration (T), and Maximum Power Control Level

1. All measurements are to be performed with the EUT transmitting at 100 percent duty cycle at its maximum power control level; however, if 100 percent duty cycle cannot be achieved, measurements of duty cycle, x , and maximum-power transmission duration, T , are required for each tested mode of operation.

Duty Cycle Test Method

From KDB 789033 D02 General UNII Test Procedures New Rules v02r01:

B. Duty Cycle (x), Transmission Duration (T), and Maximum Power Control Level

The zero-span mode on a spectrum analyzer or EMI receiver, if the response time and spacing between bins on the sweep are sufficient to permit accurate measurements of the on and off times of the transmitted signal. Set the center frequency of the instrument to the center frequency of the transmission. Set $RBW \geq EBW$ if possible; otherwise, set RBW to the largest available value. Set $VBW \geq RBW$. Set detector = peak or average. The zero-span measurement method shall not be used unless both RBW and VBW are $> 50/T$, where T is defined in section II.B.1.a), and the number of sweep points across duration T exceeds 100. (For example, if VBW and/or RBW are limited to 3 MHz, then the zero-span method of measuring duty cycle shall not be used if $T \leq 16.7$ microseconds.)

Duty Cycle Test Information

Tested By: Johanna Knudsen, Julian Land, Mathew Blackburn	Date of testing: 26-JUL-2021 to 29-JUL-2021; 11-SEP-2021 to 12-SEP-2021
Test Result: PASS	

Test Equipment

See Appendix C for list of test equipment

Duty Cycle Data Table

Duty Cycle table and screen captures are shown below for Power/PSD modes.

Frequency (MHz)	Mode	Data Rate (Mbps)	Duty Cycle (dB)
5180	Non HT20, 6 to 54 Mbps	6.0	0.2558
	HT/VHT20, M0 to M7	m0	0.30305
	HE20, M0 to M9 1ss	m0h1	0.21774
5190	Non HT40, 6 to 54 Mbps	6.0	0.33202
	HT/VHT40, M0 to M7	m0	0.85075
	HE40, M0 to M9 1ss	m0h1	0.22368
5210	Non HT80, 6 to 54 Mbps	6.0	0.33248
	VHT80, M0 to M9 1ss	m0x1	0.33061
	HE80, M0 to M9 1ss	m0h1	0.26272
5220	Non HT20, 6 to 54 Mbps	6.0	0.2558
	HT/VHT20, M0 to M7	m0	0.30305
	HE20, M0 to M9 1ss	m0h1	0.21774
5230	Non HT40, 6 to 54 Mbps	6.0	0.33202
	HT/VHT40, M0 to M7	m0	0.85075
	HE40, M0 to M9 1ss	m0h1	0.22368
5240	Non HT20, 6 to 54 Mbps	6.0	0.2558
	HT/VHT20, M0 to M7	m0	0.30305
	HE20, M0 to M9 1ss	m0h1	0.21774

Data Screenshots

5190 MHz: HT/VHT40, M0 to M7

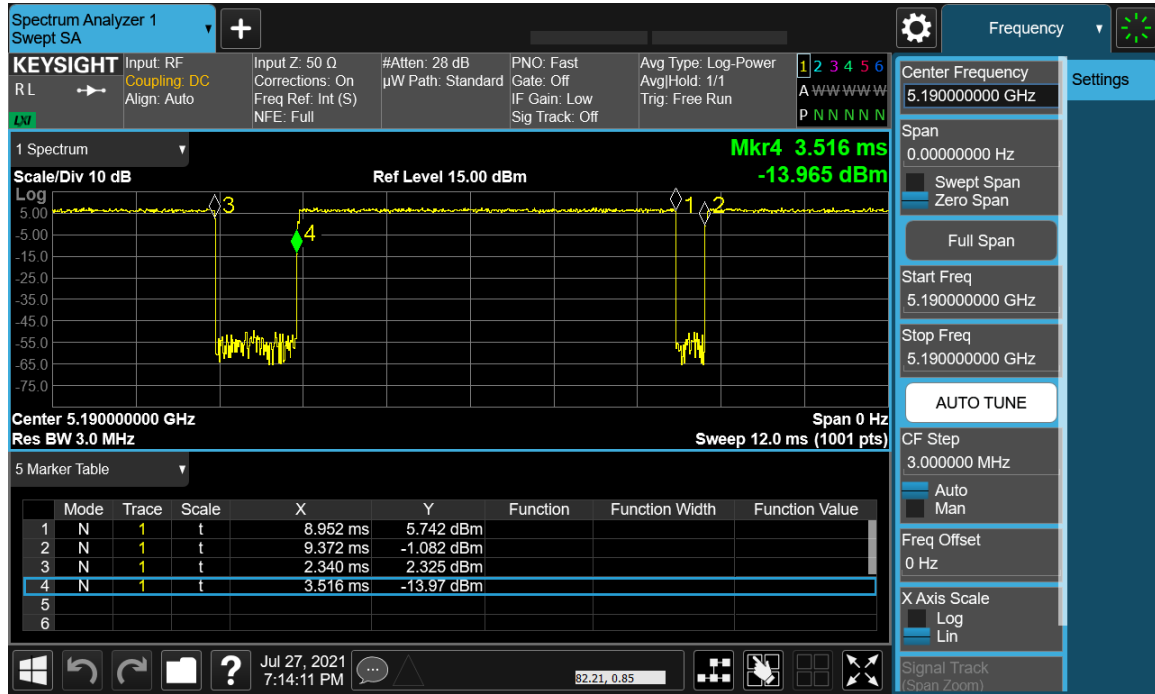

Antenna A

5210 MHz: Non HT80, 6 to 54 Mbps

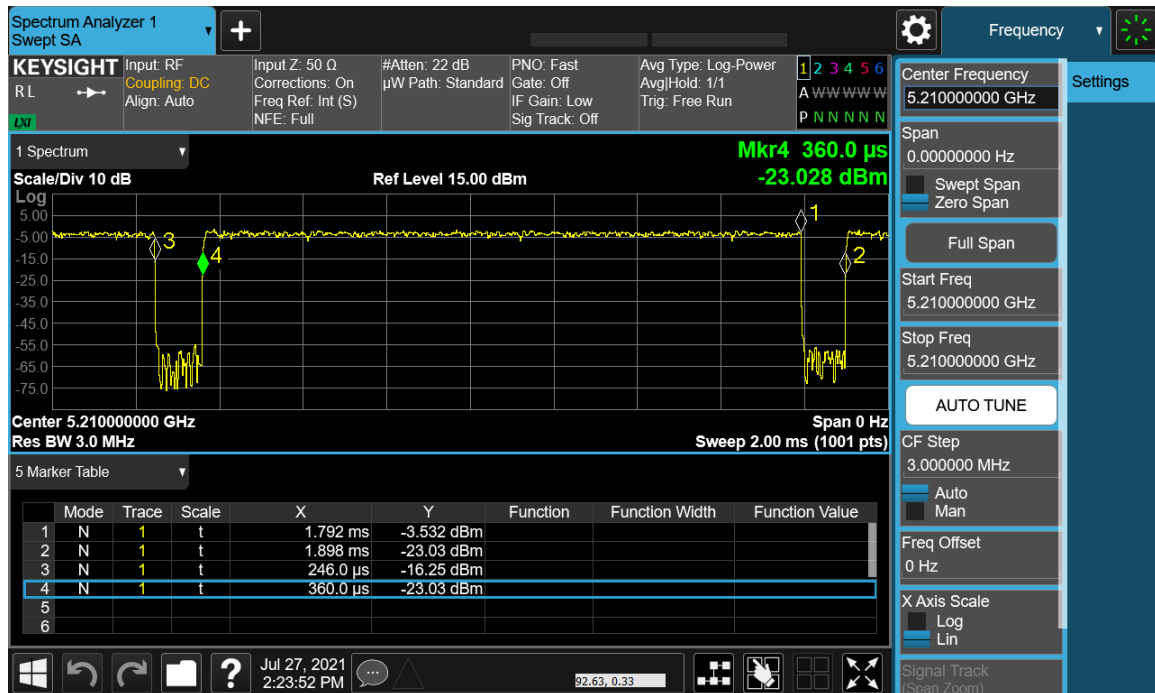

Antenna A

A.2: 99% and 26dB Bandwidth

99% and 26dB Bandwidth Test Requirement

For the FCC:

There is no requirement for the value of bandwidth.

Power measurements are made using the 99% Bandwidth as the integration bandwidth.

99% and 26dB Bandwidth Test Procedure

The 99-percent occupied bandwidth is the frequency bandwidth such that, below its lower and above its upper frequency limits, the mean powers are each equal to 0.5 % of the total mean power of the given emission. Measurement of the 99-percent occupied bandwidth is required only as a condition for using the optional band-edge measurement techniques described in section II.G.3.d). Measurements of 99-percent occupied bandwidth may also optionally be used in lieu of the EBW to define the minimum frequency range over which the spectrum is integrated when measuring maximum conducted output power as described in section II.E. However, the EBW must be measured to determine bandwidth dependent limits on maximum conducted output power in accordance with 15.407(a).

Ref. KDB 789033 Section D. 99 Percent Occupied Bandwidth

99% BW Test Parameters
<ol style="list-style-type: none"> 1. Set center frequency to the nominal EUT channel center frequency. 2. Set span = 1.5 times to 5.0 times the OBW. 3. Set RBW = 1 % to 5 % of the OBW 4. Set VBW $\geq 3 \cdot RBW$. Video averaging is not permitted. Where practical, a sample detection and single sweep mode shall be used. Otherwise, peak detection and max hold mode (until the trace stabilizes) shall be used.6. Use the 99 % power bandwidth function of the instrument (if available).

Ref KDB 789033 in Section C. Measurement Bandwidth, Section 1

26 BW Test parameters
X dB BW = -26dB (using the OBW function of the spectrum analyzer) Emission Bandwidth (EBW) <ol style="list-style-type: none"> a) Set RBW = approximately 1% of the emission bandwidth. b) Set the VBW > RBW. c) Detector = Peak. d) Trace mode = max hold. e) Measure the maximum width of the emission that is 26 dB down from the maximum of the emission. Compare this with the RBW setting of the analyzer. Readjust RBW and repeat measurement as needed until the RBW/EBW ratio is approximately 1%.

Tested By: Johanna Knudsen, Julian Land, Mathew Blackburn	Date of testing: 26-JUL-2021 to 28-AUG-2021; 1-SEP-2021 to 4-SEP-2021; 11-SEP-2021 to 14-SEP-2021
Test Result: PASS	

Test Equipment

See Appendix C for list of test equipment

99% and 26dB Bandwidth Table

Frequency (MHz)	Mode	Data Rate (Mbps)	26dB BW (MHz)	99% BW (MHz)
5180	Non HT20, 6 to 54 Mbps	6.0	19.1	16.333
	HT/VHT20, M0 to M7	m0	20.4	17.536
	HE20 Beam Forming, M0 to M9 1ss	m0h1	21.0	18.897
5190	Non HT40, 6 to 54 Mbps	6.0	39.3	35.985
	HT/VHT40, M0 to M7	m0	39.1	35.936
	HE40 Beam Forming, M0 to M9 1ss	m0h1	39.9	37.696
5210	Non HT80, 6 to 54 Mbps	6.0	79.7	75.474
	VHT80 Beam Forming, M0 to M9 1ss	m0x1	79.6	75.235
	HE80, M0 to M9 1ss	m0h1	80.2	77.005
5220	Non HT20, 6 to 54 Mbps	6.0	19.2	16.32
	HT/VHT20, M0 to M7	m0	20.6	17.537
	HE20, M0 to M9 1ss	m0h1	20.9	18.892
5230	Non HT40, 6 to 54 Mbps	6.0	39.1	35.97
	HT/VHT40 Beam Forming, M0 to M7	m0	39.3	35.909
	HE40, M0 to M9 1ss	m0h1	40.0	37.651
5240	Non HT20 Beam Forming, 6 to 54 Mbps	6.0	19.0	16.333
	HT/VHT20, M0 to M7	m0	20.5	17.549
	HE20 Beam Forming, M0 to M9 1ss	m0h1	20.9	18.907

Data Screenshots

5220 MHz: Non HT20, 6 to 54 Mbps



Antenna A

5190 MHz: HT/VHT40, M0 to M7

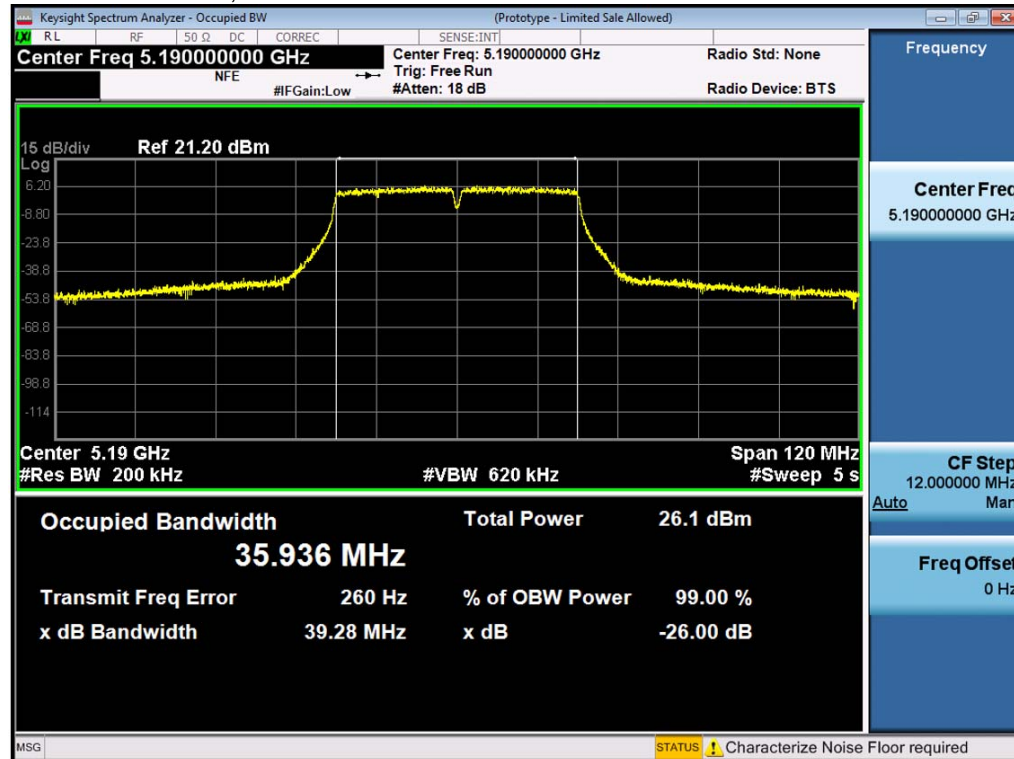

Antenna A

A.3: Maximum Conducted Output Power

Maximum Conducted Output Power Test Requirement

15.407 General technical requirements, (a) *Power limits: (1) For the band 5.15-5.25 GHz:*

(i) For an outdoor access point operating in the band 5.15-5.25 GHz, the maximum conducted output power over the frequency band of operation shall not exceed 1 W provided the maximum antenna gain does not exceed 6 dBi. ... If transmitting antennas of directional gain greater than 6 dBi are used, both the maximum conducted output power and the maximum power spectral density shall be reduced by the amount in dB that the directional gain of the antenna exceeds 6 dBi. The maximum e.i.r.p. at any elevation angle above 30 degrees as measured from the horizon must not exceed 125 mW (21 dBm).

(ii) For an indoor access point operating in the band 5.15-5.25 GHz, the maximum conducted output power over the frequency band of operation shall not exceed 1 W provided the maximum antenna gain does not exceed 6 dBi. ...If transmitting antennas of directional gain greater than 6 dBi are used, both the maximum conducted output power and the maximum power spectral density shall be reduced by the amount in dB that the directional gain of the antenna exceeds 6 dBi.

(iii) For fixed point-to-point access points operating in the band 5.15-5.25 GHz, the maximum conducted output power over the frequency band of operation shall not exceed 1 W. ...Fixed point-to-point U-NII devices may employ antennas with directional gain up to 23 dBi without any corresponding reduction in the maximum conducted output power or maximum power spectral density. For fixed point-to-point transmitters that employ a directional antenna gain greater than 23 dBi, a 1 dB reduction in maximum conducted output power and maximum power spectral density is required for each 1 dB of antenna gain in excess of 23 dBi. Fixed, point-to-point operations exclude the use of point-to-multipoint systems, omnidirectional applications, and multiple collocated transmitters transmitting the same information. The operator of the U-NII device, or if the equipment is professionally installed, the installer, is responsible for ensuring that systems employing high gain directional antennas are used exclusively for fixed, point-to-point operations.

(iv) For client devices in the 5.15-5.25 GHz band, the maximum conducted output power over the frequency band of operation shall not exceed 250 mW provided the maximum antenna gain does not exceed 6 dBi. In addition, the maximum power spectral density shall not exceed 11 dBm in any 1 megahertz band. If transmitting antennas of directional gain greater than 6 dBi are used, both the maximum conducted output power and the maximum power spectral density shall be reduced by the amount in dB that the directional gain of the antenna exceeds 6 dBi.

Maximum Conducted Output Power Test Procedure

Ref. KDB 789033 D02 General UNII Test Procedures New Rules v02r01
ANSI C63.10: 2013

Maximum Conducted Output Power Test Procedure
<ol style="list-style-type: none"> 1. Set the radio in the continuous transmitting mode at full power 2. Compute power by integrating the spectrum across the EBW (or alternatively entire 99% OBW) of the signal using the instrument's band power measurement function. The integration shall be performed using the spectrum analyzer band-power measurement function with band limits set equal to the EBW or the OBW band edges. 3. Capture graphs and record pertinent measurement data.

Ref. KDB 789033 D02 General UNII Test Procedures New Rules v02r01**2. Measurement using a Spectrum Analyzer or EMI Receiver (SA), (d) Method SA-2**

Maximum Conducted Output Power
Test parameters Method SA-2 (trace averaging across on and off times of the EUT transmissions, followed by duty cycle correction). (i) Measure the duty cycle, x , of the transmitter output signal as described in section II.B. (ii) Set span to encompass the EBW (or, alternatively, the entire 99% occupied bandwidth) of the signal. (iii) Set RBW = 1 MHz. (iv) Set VBW \geq 3 MHz. (v) Number of points in sweep \geq 2 Span / RBW. (This ensures that bin-to-bin spacing is \leq RBW/2, so that narrowband signals are not lost between frequency bins.) (vi) Sweep time = auto. (vii) Detector = RMS (i.e., power averaging), if available. Otherwise, use sample detector mode. (viii) Do not use sweep triggering. Allow the sweep to “free run”. (ix) Trace average at least 100 traces in power averaging (i.e., RMS) mode; however, the number of traces to be averaged shall be increased above 100 as needed to ensure that the average accurately represents the true average over the on and off periods of the transmitter. (x) Compute power by integrating the spectrum across the EBW (or, alternatively, the entire 99% occupied bandwidth) of the signal using the instrument’s band power measurement function with band limits set equal to the EBW (or occupied bandwidth)

The “measure-and-sum technique” is used for measuring in-band transmit power of a device. In the measure-and-sum approach, the conducted emission level is measured at each antenna port. The measured results at the various antenna ports are then summed mathematically to determine the total emission level from the device. Summing is performed in linear power units. ANSI C63.10 section 14.3.2.2

Tested By: Johanna Knudsen, Julian Land, Mathew Blackburn	Date of testing: 26-JUL-2021 to 28-AUG-2021; 01-SEP-2021 to 04-SEP-2021; 11-SEP-2021 to 14-SEP-2021
Test Result: PASS	

Test Equipment

See Appendix C for list of test equipment

Maximum Output Power**Frequency 5180 MHz**

Mode	Tx Paths	Correlated Antenna Gain (dBi)	Tx 1 Max Power (dBm)	Tx 2 Max Power (dBm)	Tx 3 Max Power (dBm)	Tx 4 Max Power (dBm)	Duty Cycle (dB)	Total Tx Channel Power (dBm)	Limit (dBm)	Margin (dB)
Non HT20, 6 to 54 Mbps	1	14	14.6				0.26	14.8	22	7.16
Non HT20, 6 to 54 Mbps	2	14	7.0	12.1			0.26	13.5	22	8.47
Non HT20, 6 to 54 Mbps	3	14	6.0	11.2	10.5		0.26	14.8	22	7.19
Non HT20, 6 to 54 Mbps	4	14	4.9	10.4	9.4	9.3	0.26	15.2	22	6.81
Non HT20 Beam Forming, 6 to 54 Mbps	2	14	7.0	12.1			0.26	13.5	22	8.47
Non HT20 Beam Forming, 6 to 54 Mbps	3	17	3.9	9.1	8.4		0.26	12.7	19	6.31
Non HT20 Beam Forming, 6 to 54 Mbps	4	17	1.3	7.0	6.6	6.7	0.26	12.2	19	6.83
HT/VHT20, M0 to M7	1	14	14.4				0.3	14.7	22	7.34
HT/VHT20, M0 to M7	2	14	6.7	12.0			0.3	13.4	22	8.57
HT/VHT20, M8 to M15	2	14	6.7	12.0			0.3	13.4	22	8.57
HT/VHT20, M0 to M7	3	14	6.7	12.0	11.4		0.3	15.7	22	6.34
HT/VHT20, M8 to M15	3	14	6.7	12.0	11.4		0.3	15.7	22	6.34
HT/VHT20, M16 to M23	3	14	6.7	12.0	11.4		0.3	15.7	22	6.34
HT/VHT20, M0 to M7	4	14	4.7	10.2	9.2	9.2	0.3	15.1	22	6.94
HT/VHT20, M8 to M15	4	14	4.7	10.2	9.2	9.2	0.3	15.1	22	6.94
HT/VHT20, M16 to M23	4	14	4.7	10.2	9.2	9.2	0.3	15.1	22	6.94
HT/VHT20, M24 to M31	4	14	4.7	10.2	9.2	9.2	0.3	15.1	22	6.94
HT/VHT20 Beam Forming, M0 to M7	2	14	6.7	12.0			0.3	13.4	22	8.57
HT/VHT20 Beam Forming, M8 to M15	2	14	6.7	12.0			0.3	13.4	22	8.57
HT/VHT20 Beam Forming, M0 to M7	3	17	3.6	9.0	8.1		0.3	12.5	19	6.45
HT/VHT20 Beam Forming, M8 to M15	3	14	6.7	12.0	11.4		0.3	15.7	22	6.34
HT/VHT20 Beam Forming, M16 to M23	3	14	6.7	12.0	11.4		0.3	15.7	22	6.34
HT/VHT20 Beam Forming, M0 to M7	4	17	1.0	6.8	6.4	6.4	0.3	12.0	19	7.02
HT/VHT20 Beam Forming, M8 to M15	4	14	4.7	10.2	9.2	9.2	0.3	15.1	22	6.94
HT/VHT20 Beam Forming, M16 to M23	4	14	4.7	10.2	9.2	9.2	0.3	15.1	22	6.94
HT/VHT20 Beam Forming, M24 to M31	4	14	4.7	10.2	9.2	9.2	0.3	15.1	22	6.94
HT/VHT20 STBC, M0 to M7	2	14	6.7	12.0			0.3	13.4	22	8.57
HT/VHT20 STBC, M0 to M7	3	14	6.7	12.0	11.4		0.3	15.7	22	6.34
HT/VHT20 STBC, M0 to M7	4	14	4.7	10.2	9.2	9.2	0.3	15.1	22	6.94
HE20, M0 to M9 1ss	1	14	14.7				0.22	14.9	22	7.05
HE20, M0 to M9 1ss	2	14	7.2	12.4			0.22	13.8	22	8.25
HE20, M0 to M9 2ss	2	14	7.2	12.4			0.22	13.8	22	8.25
HE20, M0 to M9 1ss	3	14	7.2	12.4	11.7		0.22	16.0	22	6.05
HE20, M0 to M9 2ss	3	14	7.2	12.4	11.7		0.22	16.0	22	6.05

HE20, M0 to M9 3ss	3	14	7.2	12.4	11.7		0.22	16.0	22	6.05
HE20, M0 to M9 1ss	4	14	5.2	10.5	9.7	9.5	0.22	15.4	22	6.62
HE20, M0 to M9 2ss	4	14	5.2	10.5	9.7	9.5	0.22	15.4	22	6.62
HE20, M0 to M9 3ss	4	14	5.2	10.5	9.7	9.5	0.22	15.4	22	6.62
HE20, M0 to M9 4ss	4	14	5.2	10.5	9.7	9.5	0.22	15.4	22	6.62
HE20 Beam Forming, M0 to M9 1ss	2	14	7.2	12.4			0.22	13.8	22	8.25
HE20 Beam Forming, M0 to M9 2ss	2	14	7.2	12.4			0.22	13.8	22	8.25
HE20 Beam Forming, M0 to M9 1ss	3	17	4.1	9.4	8.6		0.22	12.9	19	6.1
HE20 Beam Forming, M0 to M9 2ss	3	14	7.2	12.4	11.7		0.22	16.0	22	6.05
HE20 Beam Forming, M0 to M9 3ss	3	14	7.2	12.4	11.7		0.22	16.0	22	6.05
HE20 Beam Forming, M0 to M9 1ss	4	17	1.5	7.3	6.8	6.9	0.22	12.4	19	6.63
HE20 Beam Forming, M0 to M9 2ss	4	14	5.2	10.5	9.7	9.5	0.22	15.4	22	6.62
HE20 Beam Forming, M0 to M9 3ss	4	14	5.2	10.5	9.7	9.5	0.22	15.4	22	6.62
HE20 Beam Forming, M0 to M9 4ss	4	14	5.2	10.5	9.7	9.5	0.22	15.4	22	6.62
HE20 STBC, M0 to M9 2ss	2	14	7.2	12.4			0.22	13.8	22	8.25
HE20 STBC, M0 to M9 2ss	3	14	7.2	12.4	11.7		0.22	16.0	22	6.05
HE20 STBC, M0 to M9 2ss	4	14	5.2	10.5	9.7	9.5	0.22	15.4	22	6.62

Frequency 5190 MHz

Mode	Tx Paths	Correlated Antenna Gain (dBi)	Tx 1 Max Power (dBm)	Tx 2 Max Power (dBm)	Tx 3 Max Power (dBm)	Tx 4 Max Power (dBm)	Duty Cycle (dB)	Total Tx Channel Power (dBm)	Limit (dBm)	Margin (dB)
Non HT40, 6 to 54 Mbps	1	14	10.4				0.33	10.7	22	11.31
Non HT40, 6 to 54 Mbps	2	14	5.6	11.2			0.33	12.6	22	9.43
Non HT40, 6 to 54 Mbps	3	14	4.5	10.3	9.3		0.33	13.8	22	8.23
Non HT40, 6 to 54 Mbps	4	14	4.5	10.3	9.3	9.0	0.33	15.1	22	6.9
HT/VHT40, M0 to M7	1	14	11.2				0.33	11.5	22	10.47
HT/VHT40, M0 to M7	2	14	5.5	11.2			0.85	13.1	22	8.9
HT/VHT40, M8 to M15	2	14	5.5	11.2			0.85	13.1	22	8.9
HT/VHT40, M0 to M7	3	14	4.5	10.2	9.2		0.85	14.2	22	7.79
HT/VHT40, M8 to M15	3	14	4.5	10.2	9.2		0.85	14.2	22	7.79
HT/VHT40, M16 to M23	3	14	4.5	10.2	9.2		0.85	14.2	22	7.79
HT/VHT40, M0 to M7	4	14	3.4	9.1	8.0	7.8	0.85	14.4	22	7.58
HT/VHT40, M8 to M15	4	14	3.4	9.1	8.0	7.8	0.85	14.4	22	7.58
HT/VHT40, M16 to M23	4	14	3.4	9.1	8.0	7.8	0.85	14.4	22	7.58
HT/VHT40, M24 to M31	4	14	3.4	9.1	8.0	7.8	0.85	14.4	22	7.58
HT/VHT40 Beam Forming, M0 to M7	2	14	5.5	11.2			0.85	13.1	22	8.9
HT/VHT40 Beam Forming, M8 to M15	2	14	5.5	11.2			0.85	13.1	22	8.9
HT/VHT40 Beam Forming, M0 to M7	3	17	1.4	7.8	7.5		0.85	12.0	19	7.04
HT/VHT40 Beam Forming, M8 to M15	3	14	4.5	10.2	9.2		0.85	14.2	22	7.79
HT/VHT40 Beam Forming, M16 to M23	3	14	4.5	10.2	9.2		0.85	14.2	22	7.79
HT/VHT40 Beam Forming, M0 to M7	4	17	1.0	6.7	6.4	6.3	0.85	12.5	19	6.51
HT/VHT40 Beam Forming, M8 to M15	4	14	3.4	9.1	8.0	7.8	0.85	14.4	22	7.58

HT/VHT40 Beam Forming, M16 to M23	4	14	3.4	9.1	8.0	7.8	0.85	14.4	22	7.58
HT/VHT40 Beam Forming, M24 to M31	4	14	3.4	9.1	8.0	7.8	0.85	14.4	22	7.58
HT/VHT40 STBC, M0 to M7	2	14	5.5	11.2			0.85	13.1	22	8.9
HT/VHT40 STBC, M0 to M7	3	14	4.5	10.2	9.2		0.85	14.2	22	7.79
HT/VHT40 STBC, M0 to M7	4	14	3.4	9.1	8.0	7.8	0.85	14.4	22	7.58
HE40, M0 to M9 1ss	1	14	10.7				0.22	10.9	22	11.05
HE40, M0 to M9 1ss	2	14	6.0	11.7			0.22	13.0	22	9.01
HE40, M0 to M9 2ss	2	14	6.0	11.7			0.22	13.0	22	9.01
HE40, M0 to M9 1ss	3	14	5.0	10.8	9.8		0.22	14.2	22	7.84
HE40, M0 to M9 2ss	3	14	5.0	10.8	9.8		0.22	14.2	22	7.84
HE40, M0 to M9 3ss	3	14	5.0	10.8	9.8		0.22	14.2	22	7.84
HE40, M0 to M9 1ss	4	14	4.0	9.7	8.7	8.4	0.22	14.4	22	7.62
HE40, M0 to M9 2ss	4	14	4.0	9.7	8.7	8.4	0.22	14.4	22	7.62
HE40, M0 to M9 3ss	4	14	4.0	9.7	8.7	8.4	0.22	14.4	22	7.62
HE40, M0 to M9 4ss	4	14	4.0	9.7	8.7	8.4	0.22	14.4	22	7.62
HE40 Beam Forming, M0 to M9 1ss	2	14	6.0	11.7			0.22	13.0	22	9.01
HE40 Beam Forming, M0 to M9 2ss	2	14	6.0	11.7			0.22	13.0	22	9.01
HE40 Beam Forming, M0 to M9 1ss	3	17	2.9	9.5	9.0		0.22	13.0	19	6.01
HE40 Beam Forming, M0 to M9 2ss	3	14	5.0	10.8	9.8		0.22	14.2	22	7.84
HE40 Beam Forming, M0 to M9 3ss	3	14	5.0	10.8	9.8		0.22	14.2	22	7.84
HE40 Beam Forming, M0 to M9 1ss	4	17	1.5	7.3	6.9	6.8	0.22	12.4	19	6.62
HE40 Beam Forming, M0 to M9 2ss	4	14	4.0	9.7	8.7	8.4	0.22	14.4	22	7.62
HE40 Beam Forming, M0 to M9 3ss	4	14	4.0	9.7	8.7	8.4	0.22	14.4	22	7.62
HE40 Beam Forming, M0 to M9 4ss	4	14	4.0	9.7	8.7	8.4	0.22	14.4	22	7.62
HE40 STBC, M0 to M9 2ss	2	14	6.0	11.7			0.22	13.0	22	9.01
HE40 STBC, M0 to M9 2ss	3	14	5.0	10.8	9.8		0.22	14.2	22	7.84
HE40 STBC, M0 to M9 2ss	4	14	4.0	9.7	8.7	8.4	0.22	14.4	22	7.62

Frequency 5210 MHz

Mode	Tx Paths	Correlated Antenna Gain (dBi)	Tx 1 Max Power (dBm)	Tx 2 Max Power (dBm)	Tx 3 Max Power (dBm)	Tx 4 Max Power (dBm)	Duty Cycle (dB)	Total Tx Channel Power (dBm)	Limit (dBm)	Margin (dB)
Non HT80, 6 to 54 Mbps	1	14	10.4				0.33	10.7	22	11.27
Non HT80, 6 to 54 Mbps	2	14	5.5	11.6			0.33	12.9	22	9.07
Non HT80, 6 to 54 Mbps	3	14	5.5	11.6	10.7		0.33	15.1	22	6.89
Non HT80, 6 to 54 Mbps	4	14	4.5	10.8	9.7	8.8	0.33	15.3	22	6.67
VHT80, M0 to M9 1ss	1	14	12.3				0.33	12.6	22	9.38
VHT80, M0 to M9 1ss	2	14	5.5	11.7			0.33	13.0	22	9.03
VHT80, M0 to M9 2ss	2	14	5.5	11.7			0.33	13.0	22	9.03
VHT80, M0 to M9 1ss	3	14	4.5	10.8	9.7		0.33	14.2	22	7.84
VHT80, M0 to M9 2ss	3	14	4.5	10.8	9.7		0.33	14.2	22	7.84
VHT80, M0 to M9 3ss	3	14	4.5	10.8	9.7		0.33	14.2	22	7.84
VHT80, M0 to M9 1ss	4	14	3.5	9.6	8.3	7.4	0.33	14.1	22	7.93
VHT80, M0 to M9 2ss	4	14	3.5	9.6	8.3	7.4	0.33	14.1	22	7.93
VHT80, M0 to M9 3ss	4	14	3.5	9.6	8.3	7.4	0.33	14.1	22	7.93
VHT80, M0 to M9 4ss	4	14	3.5	9.6	8.3	7.4	0.33	14.1	22	7.93
VHT80 Beam Forming, M0 to M9 1ss	2	14	5.5	11.7			0.33	13.0	22	9.03
VHT80 Beam Forming, M0 to M9 2ss	2	14	5.5	11.7			0.33	13.0	22	9.03
VHT80 Beam Forming, M0 to M9 1ss	3	17	2.5	8.2	8.1		0.33	12.1	19	6.93
VHT80 Beam Forming, M0 to M9 2ss	3	14	4.5	10.8	9.7		0.33	14.2	22	7.84
VHT80 Beam Forming, M0 to M9 3ss	3	14	4.5	10.8	9.7		0.33	14.2	22	7.84
VHT80 Beam Forming, M0 to M9 1ss	4	17	1.0	6.1	6.3	5.2	0.33	11.4	19	7.56
VHT80 Beam Forming, M0 to M9 2ss	4	14	3.5	9.6	8.3	7.4	0.33	14.1	22	7.93
VHT80 Beam Forming, M0 to M9 3ss	4	14	3.5	9.6	8.3	7.4	0.33	14.1	22	7.93
VHT80 Beam Forming, M0 to M9 4ss	4	14	3.5	9.6	8.3	7.4	0.33	14.1	22	7.93
VHT80 STBC, M0 to M9 1ss	2	14	5.5	11.7			0.33	13.0	22	9.03
VHT80 STBC, M0 to M9 1ss	3	14	4.5	10.8	9.7		0.33	14.2	22	7.84
VHT80 STBC, M0 to M9 1ss	4	14	3.5	9.6	8.3	7.4	0.33	14.1	22	7.93
HE80, M0 to M9 1ss	1	14	10.9				0.26	11.2	22	10.82
HE80, M0 to M9 1ss	2	14	6.1	11.9			0.26	13.2	22	8.8
HE80, M0 to M9 2ss	2	14	6.1	11.9			0.26	13.2	22	8.8
HE80, M0 to M9 1ss	3	14	5.2	11.4	10.3		0.26	14.7	22	7.29
HE80, M0 to M9 2ss	3	14	5.2	11.4	10.3		0.26	14.7	22	7.29
HE80, M0 to M9 3ss	3	14	5.2	11.4	10.3		0.26	14.7	22	7.29
HE80, M0 to M9 1ss	4	14	4.1	10.3	8.9	7.9	0.26	14.6	22	7.38
HE80, M0 to M9 2ss	4	14	4.1	10.3	8.9	7.9	0.26	14.6	22	7.38
HE80, M0 to M9 3ss	4	14	4.1	10.3	8.9	7.9	0.26	14.6	22	7.38
HE80, M0 to M9 4ss	4	14	4.1	10.3	8.9	7.9	0.26	14.6	22	7.38
HE80 Beam Forming, M0 to M9 1ss	2	14	6.1	11.9			0.26	13.2	22	8.8

HE80 Beam Forming, M0 to M9 2ss	2	14	6.1	11.9			0.26	13.2	22	8.8
HE80 Beam Forming, M0 to M9 1ss	3	17	3.1	8.8	8.8		0.26	12.6	19	6.38
HE80 Beam Forming, M0 to M9 2ss	3	14	5.2	11.4	10.3		0.26	14.7	22	7.29
HE80 Beam Forming, M0 to M9 3ss	3	14	5.2	11.4	10.3		0.26	14.7	22	7.29
HE80 Beam Forming, M0 to M9 1ss	4	17	0.6	5.7	6.0	4.8	0.26	11.0	19	8.01
HE80 Beam Forming, M0 to M9 2ss	4	14	4.1	10.3	8.9	7.9	0.26	14.6	22	7.38
HE80 Beam Forming, M0 to M9 3ss	4	14	4.1	10.3	8.9	7.9	0.26	14.6	22	7.38
HE80 Beam Forming, M0 to M9 4ss	4	14	4.1	10.3	8.9	7.9	0.26	14.6	22	7.38
HE80 STBC, M0 to M9 1ss	2	14	6.1	11.9			0.26	13.2	22	8.8
HE80 STBC, M0 to M9 1ss	3	14	5.2	11.4	10.3		0.26	14.7	22	7.29
HE80 STBC, M0 to M9 1ss	4	14	4.1	10.3	8.9	7.9	0.26	14.6	22	7.38

Frequency 5220 MHz

Mode	Tx Paths	Correlated Antenna Gain (dBi)	Tx 1 Max Power (dBm)	Tx 2 Max Power (dBm)	Tx 3 Max Power (dBm)	Tx 4 Max Power (dBm)	Duty Cycle (dB)	Total Tx Channel Power (dBm)	Limit (dBm)	Margin (dB)
Non HT20, 6 to 54 Mbps	1	14	15.2				0.26	15.5	22	6.52
Non HT20, 6 to 54 Mbps	2	14	6.7	12.5			0.26	13.8	22	8.19
Non HT20, 6 to 54 Mbps	3	14	5.7	11.7	10.8		0.26	15.1	22	6.91
Non HT20, 6 to 54 Mbps	4	14	4.8	10.6	9.7	8.9	0.26	15.3	22	6.73
Non HT20 Beam Forming, 6 to 54 Mbps	2	14	6.7	12.5			0.26	13.8	22	8.19
Non HT20 Beam Forming, 6 to 54 Mbps	3	17	3.8	9.6	8.3		0.26	12.9	19	6.13
Non HT20 Beam Forming, 6 to 54 Mbps	4	17	1.3	6.4	6.6	5.8	0.26	11.7	19	7.26
HT/VHT20, M0 to M7	1	14	15.0				0.3	15.3	22	6.69
HT/VHT20, M0 to M7	2	14	6.5	12.4			0.3	13.7	22	8.29
HT/VHT20, M8 to M15	2	14	6.5	12.4			0.3	13.7	22	8.29
HT/VHT20, M0 to M7	3	14	6.5	12.4	11.6		0.3	15.9	22	6.11
HT/VHT20, M8 to M15	3	14	6.5	12.4	11.6		0.3	15.9	22	6.11
HT/VHT20, M16 to M23	3	14	6.5	12.4	11.6		0.3	15.9	22	6.11
HT/VHT20, M0 to M7	4	14	4.6	10.4	9.5	8.8	0.3	15.1	22	6.85
HT/VHT20, M8 to M15	4	14	4.6	10.4	9.5	8.8	0.3	15.1	22	6.85
HT/VHT20, M16 to M23	4	14	4.6	10.4	9.5	8.8	0.3	15.1	22	6.85
HT/VHT20, M24 to M31	4	14	4.6	10.4	9.5	8.8	0.3	15.1	22	6.85
HT/VHT20 Beam Forming, M0 to M7	2	14	6.5	12.4			0.3	13.7	22	8.29
HT/VHT20 Beam Forming, M8 to M15	2	14	6.5	12.4			0.3	13.7	22	8.29
HT/VHT20 Beam Forming, M0 to M7	3	17	3.6	9.4	8.1		0.3	12.7	19	6.27
HT/VHT20 Beam Forming, M8 to M15	3	14	6.5	12.4	11.6		0.3	15.9	22	6.11

HT/VHT20 Beam Forming, M16 to M23	3	14	6.5	12.4	11.6		0.3	15.9	22	6.11
HT/VHT20 Beam Forming, M0 to M7	4	17	1.0	6.1	6.3	5.5	0.3	11.5	19	7.5
HT/VHT20 Beam Forming, M8 to M15	4	14	4.6	10.4	9.5	8.8	0.3	15.1	22	6.85
HT/VHT20 Beam Forming, M16 to M23	4	14	4.6	10.4	9.5	8.8	0.3	15.1	22	6.85
HT/VHT20 Beam Forming, M24 to M31	4	14	4.6	10.4	9.5	8.8	0.3	15.1	22	6.85
HT/VHT20 STBC, M0 to M7	2	14	6.5	12.4			0.3	13.7	22	8.29
HT/VHT20 STBC, M0 to M7	3	14	6.5	12.4	11.6		0.3	15.9	22	6.11
HT/VHT20 STBC, M0 to M7	4	14	4.6	10.4	9.5	8.8	0.3	15.1	22	6.85
HE20, M0 to M9 1ss	1	14	15.4				0.22	15.6	22	6.4
HE20, M0 to M9 1ss	2	14	6.9	12.9			0.22	14.1	22	7.94
HE20, M0 to M9 2ss	2	14	6.9	12.9			0.22	14.1	22	7.94
HE20, M0 to M9 1ss	3	14	5.9	12.0	11.1		0.22	15.3	22	6.69
HE20, M0 to M9 2ss	3	14	5.9	12.0	11.1		0.22	15.3	22	6.69
HE20, M0 to M9 3ss	3	14	5.9	12.0	11.1		0.22	15.3	22	6.69
HE20, M0 to M9 1ss	4	14	4.9	11.0	10.0	9.2	0.22	15.5	22	6.47
HE20, M0 to M9 2ss	4	14	4.9	11.0	10.0	9.2	0.22	15.5	22	6.47
HE20, M0 to M9 3ss	4	14	4.9	11.0	10.0	9.2	0.22	15.5	22	6.47
HE20, M0 to M9 4ss	4	14	4.9	11.0	10.0	9.2	0.22	15.5	22	6.47
HE20 Beam Forming, M0 to M9 1ss	2	14	6.9	12.9			0.22	14.1	22	7.94
HE20 Beam Forming, M0 to M9 2ss	2	14	6.9	12.9			0.22	14.1	22	7.94
HE20 Beam Forming, M0 to M9 1ss	3	17	1.7	9.2	8.4		0.22	12.5	19	6.53
HE20 Beam Forming, M0 to M9 2ss	3	14	5.9	12.0	11.1		0.22	15.3	22	6.69
HE20 Beam Forming, M0 to M9 3ss	3	14	5.9	12.0	11.1		0.22	15.3	22	6.69
HE20 Beam Forming, M0 to M9 1ss	4	17	1.5	6.6	6.8	6.0	0.22	11.9	19	7.09
HE20 Beam Forming, M0 to M9 2ss	4	14	4.9	11.0	10.0	9.2	0.22	15.5	22	6.47
HE20 Beam Forming, M0 to M9 3ss	4	14	4.9	11.0	10.0	9.2	0.22	15.5	22	6.47
HE20 Beam Forming, M0 to M9 4ss	4	14	4.9	11.0	10.0	9.2	0.22	15.5	22	6.47
HE20 STBC, M0 to M9 2ss	2	14	6.9	12.9			0.22	14.1	22	7.94
HE20 STBC, M0 to M9 2ss	3	14	5.9	12.0	11.1		0.22	15.3	22	6.69
HE20 STBC, M0 to M9 2ss	4	14	4.9	11.0	10.0	9.2	0.22	15.5	22	6.47

Frequency 5230 MHz

Mode	Tx Paths	Correlated Antenna Gain (dBi)	Tx 1 Max Power (dBm)	Tx 2 Max Power (dBm)	Tx 3 Max Power (dBm)	Tx 4 Max Power (dBm)	Duty Cycle (dB)	Total Tx Channel Power (dBm)	Limit (dBm)	Margin (dB)
Non HT40, 6 to 54 Mbps	1	14	15.0				0.33	15.3	22	6.68
Non HT40, 6 to 54 Mbps	2	14	6.6	12.4			0.33	13.7	22	8.27
Non HT40, 6 to 54 Mbps	3	14	5.7	11.5	10.9		0.33	15.1	22	6.91
Non HT40, 6 to 54 Mbps	4	14	4.7	10.5	9.8	9.1	0.33	15.4	22	6.65
HT/VHT40, M0 to M7	1	14	15.1				0.85	15.9	22	6.07
HT/VHT40, M0 to M7	2	14	6.5	12.4			0.85	14.2	22	7.76
HT/VHT40, M8 to M15	2	14	6.5	12.4			0.85	14.2	22	7.76
HT/VHT40, M0 to M7	3	14	5.7	11.5	11.0		0.85	15.7	22	6.33
HT/VHT40, M8 to M15	3	14	5.7	11.5	11.0		0.85	15.7	22	6.33
HT/VHT40, M16 to M23	3	14	5.7	11.5	11.0		0.85	15.7	22	6.33
HT/VHT40, M0 to M7	4	14	4.7	10.6	9.8	9.1	0.85	15.9	22	6.06
HT/VHT40, M8 to M15	4	14	4.7	10.6	9.8	9.1	0.85	15.9	22	6.06
HT/VHT40, M16 to M23	4	14	4.7	10.6	9.8	9.1	0.85	15.9	22	6.06
HT/VHT40, M24 to M31	4	14	4.7	10.6	9.8	9.1	0.85	15.9	22	6.06
HT/VHT40 Beam Forming, M0 to M7	2	14	6.5	12.4			0.85	14.2	22	7.76
HT/VHT40 Beam Forming, M8 to M15	2	14	6.5	12.4			0.85	14.2	22	7.76
HT/VHT40 Beam Forming, M0 to M7	3	17	1.5	8.7	8.3		0.85	12.8	19	6.23
HT/VHT40 Beam Forming, M8 to M15	3	14	5.7	11.5	11.0		0.85	15.7	22	6.33
HT/VHT40 Beam Forming, M16 to M23	3	14	5.7	11.5	11.0		0.85	15.7	22	6.33
HT/VHT40 Beam Forming, M0 to M7	4	17	1.0	6.1	6.4	5.9	0.85	12.2	19	6.81
HT/VHT40 Beam Forming, M8 to M15	4	14	4.7	10.6	9.8	9.1	0.85	15.9	22	6.06
HT/VHT40 Beam Forming, M16 to M23	4	14	4.7	10.6	9.8	9.1	0.85	15.9	22	6.06
HT/VHT40 Beam Forming, M24 to M31	4	14	4.7	10.6	9.8	9.1	0.85	15.9	22	6.06
HT/VHT40 STBC, M0 to M7	2	14	6.5	12.4			0.85	14.2	22	7.76
HT/VHT40 STBC, M0 to M7	3	14	5.7	11.5	11.0		0.85	15.7	22	6.33
HT/VHT40 STBC, M0 to M7	4	14	4.7	10.6	9.8	9.1	0.85	15.9	22	6.06
HE40, M0 to M9 1ss	1	14	15.5				0.22	15.8	22	6.25
HE40, M0 to M9 1ss	2	14	7.0	13.0			0.22	14.2	22	7.81
HE40, M0 to M9 2ss	2	14	7.0	13.0			0.22	14.2	22	7.81
HE40, M0 to M9 1ss	3	14	6.1	12.1	11.4		0.22	15.5	22	6.45
HE40, M0 to M9 2ss	3	14	6.1	12.1	11.4		0.22	15.5	22	6.45
HE40, M0 to M9 3ss	3	14	6.1	12.1	11.4		0.22	15.5	22	6.45
HE40, M0 to M9 1ss	4	14	5.1	11.0	10.3	9.6	0.22	15.8	22	6.24
HE40, M0 to M9 2ss	4	14	5.1	11.0	10.3	9.6	0.22	15.8	22	6.24
HE40, M0 to M9 3ss	4	14	5.1	11.0	10.3	9.6	0.22	15.8	22	6.24
HE40, M0 to M9 4ss	4	14	5.1	11.0	10.3	9.6	0.22	15.8	22	6.24
HE40 Beam Forming, M0 to M9 1ss	2	14	7.0	13.0			0.22	14.2	22	7.81
HE40 Beam Forming, M0 to M9 2ss	2	14	7.0	13.0			0.22	14.2	22	7.81

HE40 Beam Forming, M0 to M9 1ss	3	17	1.9	9.1	8.8		0.22	12.6	19	6.41
HE40 Beam Forming, M0 to M9 2ss	3	14	6.1	12.1	11.4		0.22	15.5	22	6.45
HE40 Beam Forming, M0 to M9 3ss	3	14	6.1	12.1	11.4		0.22	15.5	22	6.45
HE40 Beam Forming, M0 to M9 1ss	4	17	1.4	6.6	7.0	6.4	0.22	12.1	19	6.93
HE40 Beam Forming, M0 to M9 2ss	4	14	5.1	11.0	10.3	9.6	0.22	15.8	22	6.24
HE40 Beam Forming, M0 to M9 3ss	4	14	5.1	11.0	10.3	9.6	0.22	15.8	22	6.24
HE40 Beam Forming, M0 to M9 4ss	4	14	5.1	11.0	10.3	9.6	0.22	15.8	22	6.24
HE40 STBC, M0 to M9 2ss	2	14	7.0	13.0			0.22	14.2	22	7.81
HE40 STBC, M0 to M9 2ss	3	14	6.1	12.1	11.4		0.22	15.5	22	6.45
HE40 STBC, M0 to M9 2ss	4	14	5.1	11.0	10.3	9.6	0.22	15.8	22	6.24

Frequency 5240 MHz

Mode	Tx Paths	Correlated Antenna Gain (dBi)	Tx 1 Max Power (dBm)	Tx 2 Max Power (dBm)	Tx 3 Max Power (dBm)	Tx 4 Max Power (dBm)	Duty Cycle (dB)	Total Tx Channel Power (dBm)	Limit (dBm)	Margin (dB)
Non HT20, 6 to 54 Mbps	1	14	14.9				0.26	15.1	22	6.86
Non HT20, 6 to 54 Mbps	2	14	7.2	14.9			0.26	15.8	22	6.19
Non HT20, 6 to 54 Mbps	3	14	6.2	12.1	11.8		0.26	15.7	22	6.25
Non HT20, 6 to 54 Mbps	4	14	4.4	10.3	9.5	9.2	0.26	15.1	22	6.87
Non HT20 Beam Forming, 6 to 54 Mbps	2	14	7.2	14.9			0.26	15.8	22	6.19
Non HT20 Beam Forming, 6 to 54 Mbps	3	17	3.4	9.2	8.5		0.26	12.7	19	6.29
Non HT20 Beam Forming, 6 to 54 Mbps	4	17	2.4	7.8	7.6	6.7	0.26	12.8	19	6.18
HT/VHT20, M0 to M7	1	14	14.8				0.3	15.1	22	6.86
HT/VHT20, M0 to M7	2	14	7.0	14.7			0.3	15.7	22	6.31
HT/VHT20, M8 to M15	2	14	7.0	14.7			0.3	15.7	22	6.31
HT/VHT20, M0 to M7	3	14	6.1	11.9	11.5		0.3	15.6	22	6.41
HT/VHT20, M8 to M15	3	14	6.1	11.9	11.5		0.3	15.6	22	6.41
HT/VHT20, M16 to M23	3	14	6.1	11.9	11.5		0.3	15.6	22	6.41
HT/VHT20, M0 to M7	4	14	4.2	10.1	9.4	9.0	0.3	15.0	22	6.98
HT/VHT20, M8 to M15	4	14	4.2	10.1	9.4	9.0	0.3	15.0	22	6.98
HT/VHT20, M16 to M23	4	14	4.2	10.1	9.4	9.0	0.3	15.0	22	6.98
HT/VHT20, M24 to M31	4	14	4.2	10.1	9.4	9.0	0.3	15.0	22	6.98
HT/VHT20 Beam Forming, M0 to M7	2	14	7.0	14.7			0.3	15.7	22	6.31
HT/VHT20 Beam Forming, M8 to M15	2	14	7.0	14.7			0.3	15.7	22	6.31
HT/VHT20 Beam Forming, M0 to M7	3	17	3.2	9.1	8.2		0.3	12.6	19	6.43
HT/VHT20 Beam Forming, M8 to M15	3	14	6.1	11.9	11.5		0.3	15.6	22	6.41
HT/VHT20 Beam Forming, M16 to M23	3	14	6.1	11.9	11.5		0.3	15.6	22	6.41
HT/VHT20 Beam Forming, M0 to M7	4	17	2.2	7.6	7.4	6.5	0.3	12.7	19	6.3
HT/VHT20 Beam Forming, M8 to M15	4	14	4.2	10.1	9.4	9.0	0.3	15.0	22	6.98
HT/VHT20 Beam Forming, M16 to M23	4	14	4.2	10.1	9.4	9.0	0.3	15.0	22	6.98

HT/VHT20 Beam Forming, M24 to M31	4	14	4.2	10.1	9.4	9.0	0.3	15.0	22	6.98
HT/VHT20 STBC, M0 to M7	2	14	7.0	14.7			0.3	15.7	22	6.31
HT/VHT20 STBC, M0 to M7	3	14	6.1	11.9	11.5		0.3	15.6	22	6.41
HT/VHT20 STBC, M0 to M7	4	14	4.2	10.1	9.4	9.0	0.3	15.0	22	6.98
HE20, M0 to M9 1ss	1	14	15.2				0.22	15.4	22	6.57
HE20, M0 to M9 1ss	2	14	6.5	12.3			0.22	13.5	22	8.49
HE20, M0 to M9 2ss	2	14	6.5	12.3			0.22	13.5	22	8.49
HE20, M0 to M9 1ss	3	14	6.5	12.3	11.9		0.22	15.9	22	6.14
HE20, M0 to M9 2ss	3	14	6.5	12.3	11.9		0.22	15.9	22	6.14
HE20, M0 to M9 3ss	3	14	6.5	12.3	11.9		0.22	15.9	22	6.14
HE20, M0 to M9 1ss	4	14	4.6	10.4	9.7	9.3	0.22	15.2	22	6.76
HE20, M0 to M9 2ss	4	14	4.6	10.4	9.7	9.3	0.22	15.2	22	6.76
HE20, M0 to M9 3ss	4	14	4.6	10.4	9.7	9.3	0.22	15.2	22	6.76
HE20, M0 to M9 4ss	4	14	4.6	10.4	9.7	9.3	0.22	15.2	22	6.76
HE20 Beam Forming, M0 to M9 1ss	2	14	6.5	12.3			0.22	13.5	22	8.49
HE20 Beam Forming, M0 to M9 2ss	2	14	6.5	12.3			0.22	13.5	22	8.49
HE20 Beam Forming, M0 to M9 1ss	3	17	3.5	9.5	8.6		0.22	12.9	19	6.14
HE20 Beam Forming, M0 to M9 2ss	3	14	6.5	12.3	11.9		0.22	15.9	22	6.14
HE20 Beam Forming, M0 to M9 3ss	3	14	6.5	12.3	11.9		0.22	15.9	22	6.14
HE20 Beam Forming, M0 to M9 1ss	4	17	2.6	7.9	7.7	6.8	0.22	12.9	19	6.07
HE20 Beam Forming, M0 to M9 2ss	4	14	4.6	10.4	9.7	9.3	0.22	15.2	22	6.76
HE20 Beam Forming, M0 to M9 3ss	4	14	4.6	10.4	9.7	9.3	0.22	15.2	22	6.76
HE20 Beam Forming, M0 to M9 4ss	4	14	4.6	10.4	9.7	9.3	0.22	15.2	22	6.76
HE20 STBC, M0 to M9 2ss	2	14	6.5	12.3			0.22	13.5	22	8.49
HE20 STBC, M0 to M9 2ss	3	14	6.5	12.3	11.9		0.22	15.9	22	6.14
HE20 STBC, M0 to M9 2ss	4	14	4.6	10.4	9.7	9.3	0.22	15.2	22	6.76

Data Screenshots

5190 MHz: HE40 Beam Forming, M0 to M9 1ss



Antenna A

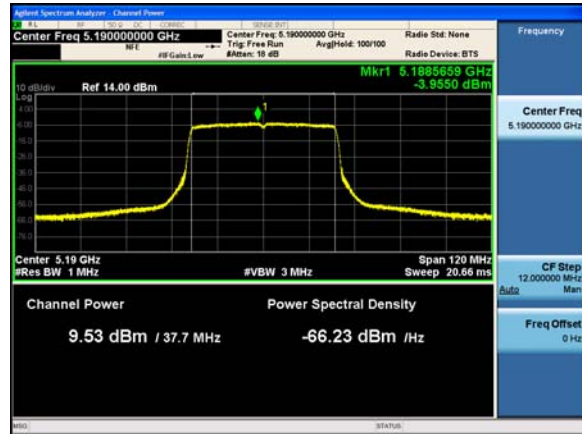

Antenna B

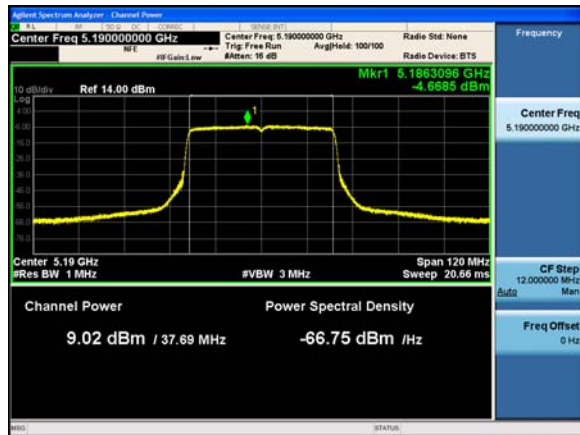

Antenna C

5180 MHz: HE20, M0 to M9 1ss



Antenna A



Antenna B



Antenna C

5180 MHz: HE20, M0 to M9 2ss



Antenna A



Antenna B



Antenna C

Maximum Transmit Power > 30°**Frequency 5180 MHz**

Mode	Tx Paths	Correlated Antenna Gain (dBi)	Tx 1 Max Power (dBm)	Tx 2 Max Power (dBm)	Tx 3 Max Power (dBm)	Tx 4 Max Power (dBm)	Duty Cycle (dB)	Total Radiated Channel Power (dBm)	Limit (dBm)	Margin (dB)
Non HT20, 6 to 54 Mbps	1	5	14.6				0.26	19.8	21	1.16
Non HT20, 6 to 54 Mbps	2	5	7.0	12.1			0.26	18.5	21	2.47
Non HT20, 6 to 54 Mbps	3	5	6.0	11.2	10.5		0.26	19.8	21	1.19
Non HT20, 6 to 54 Mbps	4	5	4.9	10.4	9.4	9.3	0.26	20.2	21	0.81
Non HT20 Beam Forming, 6 to 54 Mbps	2	5	7.0	12.1			0.26	18.5	21	2.47
Non HT20 Beam Forming, 6 to 54 Mbps	3	8	3.9	9.1	8.4		0.26	20.7	21	0.31
Non HT20 Beam Forming, 6 to 54 Mbps	4	8	1.3	7.0	6.6	6.7	0.26	20.2	21	0.83
HT/VHT20, M0 to M7	1	5	14.4				0.3	19.7	21	1.34
HT/VHT20, M0 to M7	2	5	6.7	12.0			0.3	18.4	21	2.57
HT/VHT20, M8 to M15	2	5	6.7	12.0			0.3	18.4	21	2.57
HT/VHT20, M0 to M7	3	5	6.7	12.0	11.4		0.3	20.7	21	0.34
HT/VHT20, M8 to M15	3	5	6.7	12.0	11.4		0.3	20.7	21	0.34
HT/VHT20, M16 to M23	3	5	6.7	12.0	11.4		0.3	20.7	21	0.34
HT/VHT20, M0 to M7	4	5	4.7	10.2	9.2	9.2	0.3	20.1	21	0.94
HT/VHT20, M8 to M15	4	5	4.7	10.2	9.2	9.2	0.3	20.1	21	0.94
HT/VHT20, M16 to M23	4	5	4.7	10.2	9.2	9.2	0.3	20.1	21	0.94
HT/VHT20, M24 to M31	4	5	4.7	10.2	9.2	9.2	0.3	20.1	21	0.94
HT/VHT20 Beam Forming, M0 to M7	2	5	6.7	12.0			0.3	18.4	21	2.57
HT/VHT20 Beam Forming, M8 to M15	2	5	6.7	12.0			0.3	18.4	21	2.57
HT/VHT20 Beam Forming, M0 to M7	3	8	3.6	9.0	8.1		0.3	20.5	21	0.45
HT/VHT20 Beam Forming, M8 to M15	3	5	6.7	12.0	11.4		0.3	20.7	21	0.34
HT/VHT20 Beam Forming, M16 to M23	3	5	6.7	12.0	11.4		0.3	20.7	21	0.34
HT/VHT20 Beam Forming, M0 to M7	4	8	1.0	6.8	6.4	6.4	0.3	20.0	21	1.02
HT/VHT20 Beam Forming, M8 to M15	4	5	4.7	10.2	9.2	9.2	0.3	20.1	21	0.94
HT/VHT20 Beam Forming, M16 to M23	4	5	4.7	10.2	9.2	9.2	0.3	20.1	21	0.94
HT/VHT20 Beam Forming, M24 to M31	4	5	4.7	10.2	9.2	9.2	0.3	20.1	21	0.94
HT/VHT20 STBC, M0 to M7	2	5	6.7	12.0			0.3	18.4	21	2.57
HT/VHT20 STBC, M0 to M7	3	5	6.7	12.0	11.4		0.3	20.7	21	0.34
HT/VHT20 STBC, M0 to M7	4	5	4.7	10.2	9.2	9.2	0.3	20.1	21	0.94
HE20, M0 to M9 1ss	1	5	14.7				0.22	19.9	21	1.05
HE20, M0 to M9 1ss	2	5	7.2	12.4			0.22	18.8	21	2.25
HE20, M0 to M9 2ss	2	5	7.2	12.4			0.22	18.8	21	2.25
HE20, M0 to M9 1ss	3	5	7.2	12.4	11.7		0.22	21.0	21	0.05
HE20, M0 to M9 2ss	3	5	7.2	12.4	11.7		0.22	21.0	21	0.05

HE20, M0 to M9 3ss	3	5	7.2	12.4	11.7		0.22	21.0	21	0.05
HE20, M0 to M9 1ss	4	5	5.2	10.5	9.7	9.5	0.22	20.4	21	0.62
HE20, M0 to M9 2ss	4	5	5.2	10.5	9.7	9.5	0.22	20.4	21	0.62
HE20, M0 to M9 3ss	4	5	5.2	10.5	9.7	9.5	0.22	20.4	21	0.62
HE20, M0 to M9 4ss	4	5	5.2	10.5	9.7	9.5	0.22	20.4	21	0.62
HE20 Beam Forming, M0 to M9 1ss	2	5	7.2	12.4			0.22	18.8	21	2.25
HE20 Beam Forming, M0 to M9 2ss	2	5	7.2	12.4			0.22	18.8	21	2.25
HE20 Beam Forming, M0 to M9 1ss	3	8	4.1	9.4	8.6		0.22	20.9	21	0.1
HE20 Beam Forming, M0 to M9 2ss	3	5	7.2	12.4	11.7		0.22	21.0	21	0.05
HE20 Beam Forming, M0 to M9 3ss	3	5	7.2	12.4	11.7		0.22	21.0	21	0.05
HE20 Beam Forming, M0 to M9 1ss	4	8	1.5	7.3	6.8	6.9	0.22	20.4	21	0.63
HE20 Beam Forming, M0 to M9 2ss	4	5	5.2	10.5	9.7	9.5	0.22	20.4	21	0.62
HE20 Beam Forming, M0 to M9 3ss	4	5	5.2	10.5	9.7	9.5	0.22	20.4	21	0.62
HE20 Beam Forming, M0 to M9 4ss	4	5	5.2	10.5	9.7	9.5	0.22	20.4	21	0.62
HE20 STBC, M0 to M9 2ss	2	5	7.2	12.4			0.22	18.8	21	2.25
HE20 STBC, M0 to M9 2ss	3	5	7.2	12.4	11.7		0.22	21.0	21	0.05
HE20 STBC, M0 to M9 2ss	4	5	5.2	10.5	9.7	9.5	0.22	20.4	21	0.62

Frequency 5190 MHz

Mode	Tx Paths	Correlated Antenna Gain (dBi)	Tx 1 Max Power (dBm)	Tx 2 Max Power (dBm)	Tx 3 Max Power (dBm)	Tx 4 Max Power (dBm)	Duty Cycle (dB)	Total Radiated Channel Power (dBm)	Limit (dBm)	Margin (dB)
Non HT40, 6 to 54 Mbps	1	5	10.4				0.33	15.7	21	5.31
Non HT40, 6 to 54 Mbps	2	5	5.6	11.2			0.33	17.6	21	3.43
Non HT40, 6 to 54 Mbps	3	5	4.5	10.3	9.3		0.33	18.8	21	2.23
Non HT40, 6 to 54 Mbps	4	5	4.5	10.3	9.3	9.0	0.33	20.1	21	0.9
HT/VHT40, M0 to M7	1	5	11.2				0.33	16.5	21	4.47
HT/VHT40, M0 to M7	2	5	5.5	11.2			0.85	18.1	21	2.9
HT/VHT40, M8 to M15	2	5	5.5	11.2			0.85	18.1	21	2.9
HT/VHT40, M0 to M7	3	5	4.5	10.2	9.2		0.85	19.2	21	1.79
HT/VHT40, M8 to M15	3	5	4.5	10.2	9.2		0.85	19.2	21	1.79
HT/VHT40, M16 to M23	3	5	4.5	10.2	9.2		0.85	19.2	21	1.79
HT/VHT40, M0 to M7	4	5	3.4	9.1	8.0	7.8	0.85	19.4	21	1.58
HT/VHT40, M8 to M15	4	5	3.4	9.1	8.0	7.8	0.85	19.4	21	1.58
HT/VHT40, M16 to M23	4	5	3.4	9.1	8.0	7.8	0.85	19.4	21	1.58
HT/VHT40, M24 to M31	4	5	3.4	9.1	8.0	7.8	0.85	19.4	21	1.58
HT/VHT40 Beam Forming, M0 to M7	2	5	5.5	11.2			0.85	18.1	21	2.9
HT/VHT40 Beam Forming, M8 to M15	2	5	5.5	11.2			0.85	18.1	21	2.9
HT/VHT40 Beam Forming, M0 to M7	3	8	1.4	7.8	7.5		0.85	20.0	21	1.04
HT/VHT40 Beam Forming, M8 to M15	3	5	4.5	10.2	9.2		0.85	19.2	21	1.79
HT/VHT40 Beam Forming, M16 to M23	3	5	4.5	10.2	9.2		0.85	19.2	21	1.79
HT/VHT40 Beam Forming, M0 to M7	4	8	1.0	6.7	6.4	6.3	0.85	20.5	21	0.51
HT/VHT40 Beam Forming, M8 to M15	4	5	3.4	9.1	8.0	7.8	0.85	19.4	21	1.58

HT/VHT40 Beam Forming, M16 to M23	4	5	3.4	9.1	8.0	7.8	0.85	19.4	21	1.58
HT/VHT40 Beam Forming, M24 to M31	4	5	3.4	9.1	8.0	7.8	0.85	19.4	21	1.58
HT/VHT40 STBC, M0 to M7	2	5	5.5	11.2			0.85	18.1	21	2.9
HT/VHT40 STBC, M0 to M7	3	5	4.5	10.2	9.2		0.85	19.2	21	1.79
HT/VHT40 STBC, M0 to M7	4	5	3.4	9.1	8.0	7.8	0.85	19.4	21	1.58
HE40, M0 to M9 1ss	1	5	10.7				0.22	15.9	21	5.05
HE40, M0 to M9 1ss	2	5	6.0	11.7			0.22	18.0	21	3.01
HE40, M0 to M9 2ss	2	5	6.0	11.7			0.22	18.0	21	3.01
HE40, M0 to M9 1ss	3	5	5.0	10.8	9.8		0.22	19.2	21	1.84
HE40, M0 to M9 2ss	3	5	5.0	10.8	9.8		0.22	19.2	21	1.84
HE40, M0 to M9 3ss	3	5	5.0	10.8	9.8		0.22	19.2	21	1.84
HE40, M0 to M9 1ss	4	5	4.0	9.7	8.7	8.4	0.22	19.4	21	1.62
HE40, M0 to M9 2ss	4	5	4.0	9.7	8.7	8.4	0.22	19.4	21	1.62
HE40, M0 to M9 3ss	4	5	4.0	9.7	8.7	8.4	0.22	19.4	21	1.62
HE40, M0 to M9 4ss	4	5	4.0	9.7	8.7	8.4	0.22	19.4	21	1.62
HE40 Beam Forming, M0 to M9 1ss	2	5	6.0	11.7			0.22	18.0	21	3.01
HE40 Beam Forming, M0 to M9 2ss	2	5	6.0	11.7			0.22	18.0	21	3.01
HE40 Beam Forming, M0 to M9 1ss	3	8	2.9	9.5	9.0		0.22	21.0	21	0.01
HE40 Beam Forming, M0 to M9 2ss	3	5	5.0	10.8	9.8		0.22	19.2	21	1.84
HE40 Beam Forming, M0 to M9 3ss	3	5	5.0	10.8	9.8		0.22	19.2	21	1.84
HE40 Beam Forming, M0 to M9 1ss	4	8	1.5	7.3	6.9	6.8	0.22	20.4	21	0.62
HE40 Beam Forming, M0 to M9 2ss	4	5	4.0	9.7	8.7	8.4	0.22	19.4	21	1.62
HE40 Beam Forming, M0 to M9 3ss	4	5	4.0	9.7	8.7	8.4	0.22	19.4	21	1.62
HE40 Beam Forming, M0 to M9 4ss	4	5	4.0	9.7	8.7	8.4	0.22	19.4	21	1.62
HE40 STBC, M0 to M9 2ss	2	5	6.0	11.7			0.22	18.0	21	3.01
HE40 STBC, M0 to M9 2ss	3	5	5.0	10.8	9.8		0.22	19.2	21	1.84
HE40 STBC, M0 to M9 2ss	4	5	4.0	9.7	8.7	8.4	0.22	19.4	21	1.62

Frequency 5210 MHz

Mode	Tx Paths	Correlated Antenna Gain (dBi)	Tx 1 Max Power (dBm)	Tx 2 Max Power (dBm)	Tx 3 Max Power (dBm)	Tx 4 Max Power (dBm)	Duty Cycle (dB)	Total Radiated Channel Power (dBm)	Limit (dBm)	Margin (dB)
Non HT80, 6 to 54 Mbps	1	5	10.4				0.33	15.7	21	5.27
Non HT80, 6 to 54 Mbps	2	5	5.5	11.6			0.33	17.9	21	3.07
Non HT80, 6 to 54 Mbps	3	5	5.5	11.6	10.7		0.33	20.1	21	0.89
Non HT80, 6 to 54 Mbps	4	5	4.5	10.8	9.7	8.8	0.33	20.3	21	0.67
VHT80, M0 to M9 1ss	1	5	12.3				0.33	17.6	21	3.38
VHT80, M0 to M9 1ss	2	5	5.5	11.7			0.33	18.0	21	3.03
VHT80, M0 to M9 2ss	2	5	5.5	11.7			0.33	18.0	21	3.03
VHT80, M0 to M9 1ss	3	5	4.5	10.8	9.7		0.33	19.2	21	1.84
VHT80, M0 to M9 2ss	3	5	4.5	10.8	9.7		0.33	19.2	21	1.84
VHT80, M0 to M9 3ss	3	5	4.5	10.8	9.7		0.33	19.2	21	1.84
VHT80, M0 to M9 1ss	4	5	3.5	9.6	8.3	7.4	0.33	19.1	21	1.93
VHT80, M0 to M9 2ss	4	5	3.5	9.6	8.3	7.4	0.33	19.1	21	1.93
VHT80, M0 to M9 3ss	4	5	3.5	9.6	8.3	7.4	0.33	19.1	21	1.93
VHT80, M0 to M9 4ss	4	5	3.5	9.6	8.3	7.4	0.33	19.1	21	1.93
VHT80 Beam Forming, M0 to M9 1ss	2	5	5.5	11.7			0.33	18.0	21	3.03
VHT80 Beam Forming, M0 to M9 2ss	2	5	5.5	11.7			0.33	18.0	21	3.03
VHT80 Beam Forming, M0 to M9 1ss	3	8	2.5	8.2	8.1		0.33	20.1	21	0.93
VHT80 Beam Forming, M0 to M9 2ss	3	5	4.5	10.8	9.7		0.33	19.2	21	1.84
VHT80 Beam Forming, M0 to M9 3ss	3	5	4.5	10.8	9.7		0.33	19.2	21	1.84
VHT80 Beam Forming, M0 to M9 1ss	4	8	1.0	6.1	6.3	5.2	0.33	19.4	21	1.56
VHT80 Beam Forming, M0 to M9 2ss	4	5	3.5	9.6	8.3	7.4	0.33	19.1	21	1.93
VHT80 Beam Forming, M0 to M9 3ss	4	5	3.5	9.6	8.3	7.4	0.33	19.1	21	1.93
VHT80 Beam Forming, M0 to M9 4ss	4	5	3.5	9.6	8.3	7.4	0.33	19.1	21	1.93
VHT80 STBC, M0 to M9 1ss	2	5	5.5	11.7			0.33	18.0	21	3.03
VHT80 STBC, M0 to M9 1ss	3	5	4.5	10.8	9.7		0.33	19.2	21	1.84
VHT80 STBC, M0 to M9 1ss	4	5	3.5	9.6	8.3	7.4	0.33	19.1	21	1.93
HE80, M0 to M9 1ss	1	5	10.9				0.26	16.2	21	4.82
HE80, M0 to M9 1ss	2	5	6.1	11.9			0.26	18.2	21	2.8
HE80, M0 to M9 2ss	2	5	6.1	11.9			0.26	18.2	21	2.8
HE80, M0 to M9 1ss	3	5	5.2	11.4	10.3		0.26	19.7	21	1.29
HE80, M0 to M9 2ss	3	5	5.2	11.4	10.3		0.26	19.7	21	1.29
HE80, M0 to M9 3ss	3	5	5.2	11.4	10.3		0.26	19.7	21	1.29
HE80, M0 to M9 1ss	4	5	4.1	10.3	8.9	7.9	0.26	19.6	21	1.38
HE80, M0 to M9 2ss	4	5	4.1	10.3	8.9	7.9	0.26	19.6	21	1.38
HE80, M0 to M9 3ss	4	5	4.1	10.3	8.9	7.9	0.26	19.6	21	1.38
HE80, M0 to M9 4ss	4	5	4.1	10.3	8.9	7.9	0.26	19.6	21	1.38
HE80 Beam Forming, M0 to M9 1ss	2	5	6.1	11.9			0.26	18.2	21	2.8
HE80 Beam Forming, M0 to M9 2ss	2	5	6.1	11.9			0.26	18.2	21	2.8

HE80 Beam Forming, M0 to M9 1ss	3	8	3.1	8.8	8.8		0.26	20.6	21	0.38
HE80 Beam Forming, M0 to M9 2ss	3	5	5.2	11.4	10.3		0.26	19.7	21	1.29
HE80 Beam Forming, M0 to M9 3ss	3	5	5.2	11.4	10.3		0.26	19.7	21	1.29
HE80 Beam Forming, M0 to M9 1ss	4	8	0.6	5.7	6.0	4.8	0.26	19.0	21	2.01
HE80 Beam Forming, M0 to M9 2ss	4	5	4.1	10.3	8.9	7.9	0.26	19.6	21	1.38
HE80 Beam Forming, M0 to M9 3ss	4	5	4.1	10.3	8.9	7.9	0.26	19.6	21	1.38
HE80 Beam Forming, M0 to M9 4ss	4	5	4.1	10.3	8.9	7.9	0.26	19.6	21	1.38
HE80 STBC, M0 to M9 1ss	2	5	6.1	11.9			0.26	18.2	21	2.8
HE80 STBC, M0 to M9 1ss	3	5	5.2	11.4	10.3		0.26	19.7	21	1.29
HE80 STBC, M0 to M9 1ss	4	5	4.1	10.3	8.9	7.9	0.26	19.6	21	1.38

Frequency 5220 MHz

Mode	Tx Paths	Correlated Antenna Gain (dBi)	Tx 1 Max Power (dBm)	Tx 2 Max Power (dBm)	Tx 3 Max Power (dBm)	Tx 4 Max Power (dBm)	Duty Cycle (dB)	Total Radiated Channel Power (dBm)	Limit (dBm)	Margin (dB)
Non HT20, 6 to 54 Mbps	1	5	15.2				0.26	20.5	21	0.52
Non HT20, 6 to 54 Mbps	2	5	6.7	12.5			0.26	18.8	21	2.19
Non HT20, 6 to 54 Mbps	3	5	5.7	11.7	10.8		0.26	20.1	21	0.91
Non HT20, 6 to 54 Mbps	4	5	4.8	10.6	9.7	8.9	0.26	20.3	21	0.73
Non HT20 Beam Forming, 6 to 54 Mbps	2	5	6.7	12.5			0.26	18.8	21	2.19
Non HT20 Beam Forming, 6 to 54 Mbps	3	8	3.8	9.6	8.3		0.26	20.9	21	0.13
Non HT20 Beam Forming, 6 to 54 Mbps	4	8	1.3	6.4	6.6	5.8	0.26	19.7	21	1.26
HT/VHT20, M0 to M7	1	5	15.0				0.3	20.3	21	0.69
HT/VHT20, M0 to M7	2	5	6.5	12.4			0.3	18.7	21	2.29
HT/VHT20, M8 to M15	2	5	6.5	12.4			0.3	18.7	21	2.29
HT/VHT20, M0 to M7	3	5	6.5	12.4	11.6		0.3	20.9	21	0.11
HT/VHT20, M8 to M15	3	5	6.5	12.4	11.6		0.3	20.9	21	0.11
HT/VHT20, M16 to M23	3	5	6.5	12.4	11.6		0.3	20.9	21	0.11
HT/VHT20, M0 to M7	4	5	4.6	10.4	9.5	8.8	0.3	20.1	21	0.85
HT/VHT20, M8 to M15	4	5	4.6	10.4	9.5	8.8	0.3	20.1	21	0.85
HT/VHT20, M16 to M23	4	5	4.6	10.4	9.5	8.8	0.3	20.1	21	0.85
HT/VHT20, M24 to M31	4	5	4.6	10.4	9.5	8.8	0.3	20.1	21	0.85
HT/VHT20 Beam Forming, M0 to M7	2	5	6.5	12.4			0.3	18.7	21	2.29
HT/VHT20 Beam Forming, M8 to M15	2	5	6.5	12.4			0.3	18.7	21	2.29
HT/VHT20 Beam Forming, M0 to M7	3	8	3.6	9.4	8.1		0.3	20.7	21	0.27
HT/VHT20 Beam Forming, M8 to M15	3	5	6.5	12.4	11.6		0.3	20.9	21	0.11
HT/VHT20 Beam Forming, M16 to M23	3	5	6.5	12.4	11.6		0.3	20.9	21	0.11
HT/VHT20 Beam Forming, M0 to M7	4	8	1.0	6.1	6.3	5.5	0.3	19.5	21	1.5
HT/VHT20 Beam Forming, M8 to M15	4	5	4.6	10.4	9.5	8.8	0.3	20.1	21	0.85
HT/VHT20 Beam Forming, M16 to M23	4	5	4.6	10.4	9.5	8.8	0.3	20.1	21	0.85

HT/VHT20 Beam Forming, M24 to M31	4	5	4.6	10.4	9.5	8.8	0.3	20.1	21	0.85
HT/VHT20 STBC, M0 to M7	2	5	6.5	12.4			0.3	18.7	21	2.29
HT/VHT20 STBC, M0 to M7	3	5	6.5	12.4	11.6		0.3	20.9	21	0.11
HT/VHT20 STBC, M0 to M7	4	5	4.6	10.4	9.5	8.8	0.3	20.1	21	0.85
HE20, M0 to M9 1ss	1	5	15.4				0.22	20.6	21	0.4
HE20, M0 to M9 1ss	2	5	6.9	12.9			0.22	19.1	21	1.94
HE20, M0 to M9 2ss	2	5	6.9	12.9			0.22	19.1	21	1.94
HE20, M0 to M9 1ss	3	5	5.9	12.0	11.1		0.22	20.3	21	0.69
HE20, M0 to M9 2ss	3	5	5.9	12.0	11.1		0.22	20.3	21	0.69
HE20, M0 to M9 3ss	3	5	5.9	12.0	11.1		0.22	20.3	21	0.69
HE20, M0 to M9 1ss	4	5	4.9	11.0	10.0	9.2	0.22	20.5	21	0.47
HE20, M0 to M9 2ss	4	5	4.9	11.0	10.0	9.2	0.22	20.5	21	0.47
HE20, M0 to M9 3ss	4	5	4.9	11.0	10.0	9.2	0.22	20.5	21	0.47
HE20, M0 to M9 4ss	4	5	4.9	11.0	10.0	9.2	0.22	20.5	21	0.47
HE20 Beam Forming, M0 to M9 1ss	2	5	6.9	12.9			0.22	19.1	21	1.94
HE20 Beam Forming, M0 to M9 2ss	2	5	6.9	12.9			0.22	19.1	21	1.94
HE20 Beam Forming, M0 to M9 1ss	3	8	1.7	9.2	8.4		0.22	20.5	21	0.53
HE20 Beam Forming, M0 to M9 2ss	3	5	5.9	12.0	11.1		0.22	20.3	21	0.69
HE20 Beam Forming, M0 to M9 3ss	3	5	5.9	12.0	11.1		0.22	20.3	21	0.69
HE20 Beam Forming, M0 to M9 1ss	4	8	1.5	6.6	6.8	6.0	0.22	19.9	21	1.09
HE20 Beam Forming, M0 to M9 2ss	4	5	4.9	11.0	10.0	9.2	0.22	20.5	21	0.47
HE20 Beam Forming, M0 to M9 3ss	4	5	4.9	11.0	10.0	9.2	0.22	20.5	21	0.47
HE20 Beam Forming, M0 to M9 4ss	4	5	4.9	11.0	10.0	9.2	0.22	20.5	21	0.47
HE20 STBC, M0 to M9 2ss	2	5	6.9	12.9			0.22	19.1	21	1.94
HE20 STBC, M0 to M9 2ss	3	5	5.9	12.0	11.1		0.22	20.3	21	0.69
HE20 STBC, M0 to M9 2ss	4	5	4.9	11.0	10.0	9.2	0.22	20.5	21	0.47

Frequency 5230 MHz

Mode	Tx Paths	Correlated Antenna Gain (dBi)	Tx 1 Max Power (dBm)	Tx 2 Max Power (dBm)	Tx 3 Max Power (dBm)	Tx 4 Max Power (dBm)	Duty Cycle (dB)	Total Radiated Channel Power (dBm)	Limit (dBm)	Margin (dB)
Non HT40, 6 to 54 Mbps	1	5	15.0				0.33	20.3	21	0.68
Non HT40, 6 to 54 Mbps	2	5	6.6	12.4			0.33	18.7	21	2.27
Non HT40, 6 to 54 Mbps	3	5	5.7	11.5	10.9		0.33	20.1	21	0.91
Non HT40, 6 to 54 Mbps	4	5	4.7	10.5	9.8	9.1	0.33	20.4	21	0.65
HT/VHT40, M0 to M7	1	5	15.1				0.85	20.9	21	0.07
HT/VHT40, M0 to M7	2	5	6.5	12.4			0.85	19.2	21	1.76
HT/VHT40, M8 to M15	2	5	6.5	12.4			0.85	19.2	21	1.76
HT/VHT40, M0 to M7	3	5	5.7	11.5	11.0		0.85	20.7	21	0.33
HT/VHT40, M8 to M15	3	5	5.7	11.5	11.0		0.85	20.7	21	0.33
HT/VHT40, M16 to M23	3	5	5.7	11.5	11.0		0.85	20.7	21	0.33
HT/VHT40, M0 to M7	4	5	4.7	10.6	9.8	9.1	0.85	20.9	21	0.06
HT/VHT40, M8 to M15	4	5	4.7	10.6	9.8	9.1	0.85	20.9	21	0.06
HT/VHT40, M16 to M23	4	5	4.7	10.6	9.8	9.1	0.85	20.9	21	0.06
HT/VHT40, M24 to M31	4	5	4.7	10.6	9.8	9.1	0.85	20.9	21	0.06
HT/VHT40 Beam Forming, M0 to M7	2	5	6.5	12.4			0.85	19.2	21	1.76
HT/VHT40 Beam Forming, M8 to M15	2	5	6.5	12.4			0.85	19.2	21	1.76
HT/VHT40 Beam Forming, M0 to M7	3	8	1.5	8.7	8.3		0.85	20.8	21	0.23
HT/VHT40 Beam Forming, M8 to M15	3	5	5.7	11.5	11.0		0.85	20.7	21	0.33
HT/VHT40 Beam Forming, M16 to M23	3	5	5.7	11.5	11.0		0.85	20.7	21	0.33
HT/VHT40 Beam Forming, M0 to M7	4	8	1.0	6.1	6.4	5.9	0.85	20.2	21	0.81
HT/VHT40 Beam Forming, M8 to M15	4	5	4.7	10.6	9.8	9.1	0.85	20.9	21	0.06
HT/VHT40 Beam Forming, M16 to M23	4	5	4.7	10.6	9.8	9.1	0.85	20.9	21	0.06
HT/VHT40 Beam Forming, M24 to M31	4	5	4.7	10.6	9.8	9.1	0.85	20.9	21	0.06
HT/VHT40 STBC, M0 to M7	2	5	6.5	12.4			0.85	19.2	21	1.76
HT/VHT40 STBC, M0 to M7	3	5	5.7	11.5	11.0		0.85	20.7	21	0.33
HT/VHT40 STBC, M0 to M7	4	5	4.7	10.6	9.8	9.1	0.85	20.9	21	0.06
HE40, M0 to M9 1ss	1	5	15.5				0.22	20.8	21	0.25
HE40, M0 to M9 1ss	2	5	7.0	13.0			0.22	19.2	21	1.81
HE40, M0 to M9 2ss	2	5	7.0	13.0			0.22	19.2	21	1.81
HE40, M0 to M9 1ss	3	5	6.1	12.1	11.4		0.22	20.5	21	0.45
HE40, M0 to M9 2ss	3	5	6.1	12.1	11.4		0.22	20.5	21	0.45
HE40, M0 to M9 3ss	3	5	6.1	12.1	11.4		0.22	20.5	21	0.45
HE40, M0 to M9 1ss	4	5	5.1	11.0	10.3	9.6	0.22	20.8	21	0.24
HE40, M0 to M9 2ss	4	5	5.1	11.0	10.3	9.6	0.22	20.8	21	0.24
HE40, M0 to M9 3ss	4	5	5.1	11.0	10.3	9.6	0.22	20.8	21	0.24
HE40, M0 to M9 4ss	4	5	5.1	11.0	10.3	9.6	0.22	20.8	21	0.24
HE40 Beam Forming, M0 to M9 1ss	2	5	7.0	13.0			0.22	19.2	21	1.81
HE40 Beam Forming, M0 to M9 2ss	2	5	7.0	13.0			0.22	19.2	21	1.81

HE40 Beam Forming, M0 to M9 1ss	3	8	1.9	9.1	8.8		0.22	20.6	21	0.41
HE40 Beam Forming, M0 to M9 2ss	3	5	6.1	12.1	11.4		0.22	20.5	21	0.45
HE40 Beam Forming, M0 to M9 3ss	3	5	6.1	12.1	11.4		0.22	20.5	21	0.45
HE40 Beam Forming, M0 to M9 1ss	4	8	1.4	6.6	7.0	6.4	0.22	20.1	21	0.93
HE40 Beam Forming, M0 to M9 2ss	4	5	5.1	11.0	10.3	9.6	0.22	20.8	21	0.24
HE40 Beam Forming, M0 to M9 3ss	4	5	5.1	11.0	10.3	9.6	0.22	20.8	21	0.24
HE40 Beam Forming, M0 to M9 4ss	4	5	5.1	11.0	10.3	9.6	0.22	20.8	21	0.24
HE40 STBC, M0 to M9 2ss	2	5	7.0	13.0			0.22	19.2	21	1.81
HE40 STBC, M0 to M9 2ss	3	5	6.1	12.1	11.4		0.22	20.5	21	0.45
HE40 STBC, M0 to M9 2ss	4	5	5.1	11.0	10.3	9.6	0.22	20.8	21	0.24

Frequency 5240 MHz

Mode	Tx Paths	Correlated Antenna Gain (dBi)	Tx 1 Max Power (dBm)	Tx 2 Max Power (dBm)	Tx 3 Max Power (dBm)	Tx 4 Max Power (dBm)	Duty Cycle (dB)	Total Radiated Channel Power (dBm)	Limit (dBm)	Margin (dB)
Non HT20, 6 to 54 Mbps	1	5	14.9				0.26	20.1	21	0.86
Non HT20, 6 to 54 Mbps	2	5	7.2	14.9			0.26	20.8	21	0.19
Non HT20, 6 to 54 Mbps	3	5	6.2	12.1	11.8		0.26	20.7	21	0.25
Non HT20, 6 to 54 Mbps	4	5	4.4	10.3	9.5	9.2	0.26	20.1	21	0.87
Non HT20 Beam Forming, 6 to 54 Mbps	2	5	7.2	14.9			0.26	20.8	21	0.19
Non HT20 Beam Forming, 6 to 54 Mbps	3	8	3.4	9.2	8.5		0.26	20.7	21	0.29
Non HT20 Beam Forming, 6 to 54 Mbps	4	8	2.4	7.8	7.6	6.7	0.26	20.8	21	0.18
HT/VHT20, M0 to M7	1	5	14.8				0.3	20.1	21	0.86
HT/VHT20, M0 to M7	2	5	7.0	14.7			0.3	20.7	21	0.31
HT/VHT20, M8 to M15	2	5	7.0	14.7			0.3	20.7	21	0.31
HT/VHT20, M0 to M7	3	5	6.1	11.9	11.5		0.3	20.6	21	0.41
HT/VHT20, M8 to M15	3	5	6.1	11.9	11.5		0.3	20.6	21	0.41
HT/VHT20, M16 to M23	3	5	6.1	11.9	11.5		0.3	20.6	21	0.41
HT/VHT20, M0 to M7	4	5	4.2	10.1	9.4	9.0	0.3	20.0	21	0.98
HT/VHT20, M8 to M15	4	5	4.2	10.1	9.4	9.0	0.3	20.0	21	0.98
HT/VHT20, M16 to M23	4	5	4.2	10.1	9.4	9.0	0.3	20.0	21	0.98
HT/VHT20, M24 to M31	4	5	4.2	10.1	9.4	9.0	0.3	20.0	21	0.98
HT/VHT20 Beam Forming, M0 to M7	2	5	7.0	14.7			0.3	20.7	21	0.31
HT/VHT20 Beam Forming, M8 to M15	2	5	7.0	14.7			0.3	20.7	21	0.31
HT/VHT20 Beam Forming, M0 to M7	3	8	3.2	9.1	8.2		0.3	20.6	21	0.43
HT/VHT20 Beam Forming, M8 to M15	3	5	6.1	11.9	11.5		0.3	20.6	21	0.41
HT/VHT20 Beam Forming, M16 to M23	3	5	6.1	11.9	11.5		0.3	20.6	21	0.41
HT/VHT20 Beam Forming, M0 to M7	4	8	2.2	7.6	7.4	6.5	0.3	20.7	21	0.3
HT/VHT20 Beam Forming, M8 to M15	4	5	4.2	10.1	9.4	9.0	0.3	20.0	21	0.98
HT/VHT20 Beam Forming, M16 to M23	4	5	4.2	10.1	9.4	9.0	0.3	20.0	21	0.98

HT/VHT20 Beam Forming, M24 to M31	4	5	4.2	10.1	9.4	9.0	0.3	20.0	21	0.98
HT/VHT20 STBC, M0 to M7	2	5	7.0	14.7			0.3	20.7	21	0.31
HT/VHT20 STBC, M0 to M7	3	5	6.1	11.9	11.5		0.3	20.6	21	0.41
HT/VHT20 STBC, M0 to M7	4	5	4.2	10.1	9.4	9.0	0.3	20.0	21	0.98
HE20, M0 to M9 1ss	1	5	15.2				0.22	20.4	21	0.57
HE20, M0 to M9 1ss	2	5	6.5	12.3			0.22	18.5	21	2.49
HE20, M0 to M9 2ss	2	5	6.5	12.3			0.22	18.5	21	2.49
HE20, M0 to M9 1ss	3	5	6.5	12.3	11.9		0.22	20.9	21	0.14
HE20, M0 to M9 2ss	3	5	6.5	12.3	11.9		0.22	20.9	21	0.14
HE20, M0 to M9 3ss	3	5	6.5	12.3	11.9		0.22	20.9	21	0.14
HE20, M0 to M9 1ss	4	5	4.6	10.4	9.7	9.3	0.22	20.2	21	0.76
HE20, M0 to M9 2ss	4	5	4.6	10.4	9.7	9.3	0.22	20.2	21	0.76
HE20, M0 to M9 3ss	4	5	4.6	10.4	9.7	9.3	0.22	20.2	21	0.76
HE20, M0 to M9 4ss	4	5	4.6	10.4	9.7	9.3	0.22	20.2	21	0.76
HE20 Beam Forming, M0 to M9 1ss	2	5	6.5	12.3			0.22	18.5	21	2.49
HE20 Beam Forming, M0 to M9 2ss	2	5	6.5	12.3			0.22	18.5	21	2.49
HE20 Beam Forming, M0 to M9 1ss	3	8	3.5	9.5	8.6		0.22	20.9	21	0.14
HE20 Beam Forming, M0 to M9 2ss	3	5	6.5	12.3	11.9		0.22	20.9	21	0.14
HE20 Beam Forming, M0 to M9 3ss	3	5	6.5	12.3	11.9		0.22	20.9	21	0.14
HE20 Beam Forming, M0 to M9 1ss	4	8	2.6	7.9	7.7	6.8	0.22	20.9	21	0.07
HE20 Beam Forming, M0 to M9 2ss	4	5	4.6	10.4	9.7	9.3	0.22	20.2	21	0.76
HE20 Beam Forming, M0 to M9 3ss	4	5	4.6	10.4	9.7	9.3	0.22	20.2	21	0.76
HE20 Beam Forming, M0 to M9 4ss	4	5	4.6	10.4	9.7	9.3	0.22	20.2	21	0.76
HE20 STBC, M0 to M9 2ss	2	5	6.5	12.3			0.22	18.5	21	2.49
HE20 STBC, M0 to M9 2ss	3	5	6.5	12.3	11.9		0.22	20.9	21	0.14
HE20 STBC, M0 to M9 2ss	4	5	4.6	10.4	9.7	9.3	0.22	20.2	21	0.76

Data Screenshots

5190 MHz: HE40 Beam Forming, M0 to M9 1ss

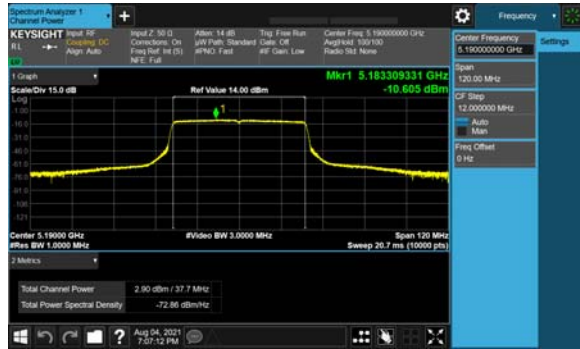

Antenna A

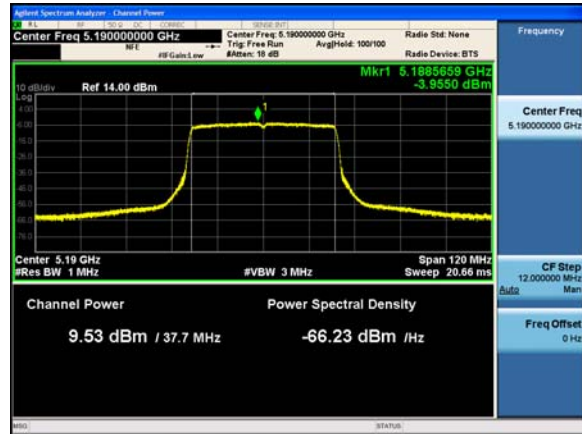

Antenna B

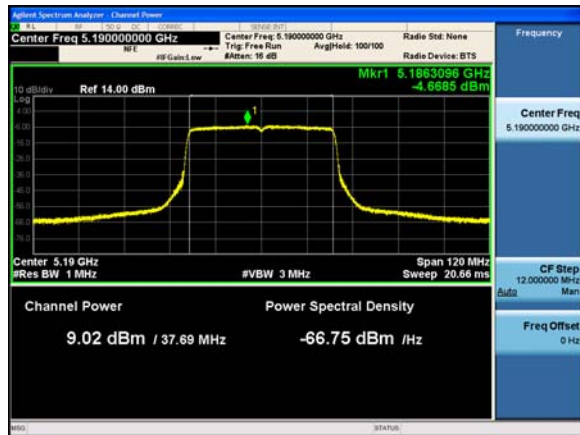

Antenna C

5180 MHz: HE20, M0 to M9 1ss

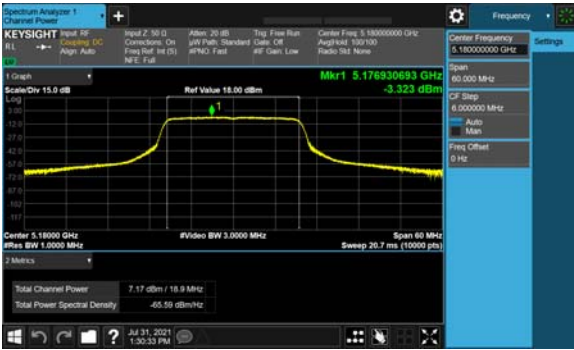

Antenna A



Antenna B



Antenna C

5180 MHz: HE20, M0 to M9 2ss

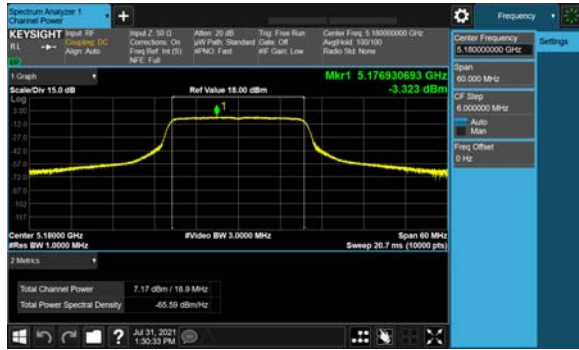

Antenna A

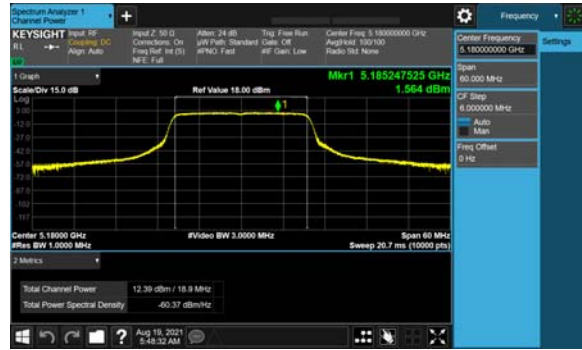

Antenna B



Antenna C

A.4: Power Spectral Density

Power Spectral Density Test Requirement

15.407 General technical requirements, (a) *Power limits: (1) For the band 5.15-5.25 GHz:*

(i) For an outdoor access point operating in the band 5.15-5.25 GHz ... the maximum power spectral density shall not exceed 17 dBm in any 1 megahertz band. If transmitting antennas of directional gain greater than 6 dBi are used, both the maximum conducted output power and the maximum power spectral density shall be reduced by the amount in dB that the directional gain of the antenna exceeds 6 dBi.

(ii) For an indoor access point operating in the band 5.15-5.25 GHz... the maximum power spectral density shall not exceed 17 dBm in any 1 megahertz band. If transmitting antennas of directional gain greater than 6 dBi are used, both the maximum conducted output power and the maximum power spectral density shall be reduced by the amount in dB that the directional gain of the antenna exceeds 6 dBi.

(iii) For fixed point-to-point access points operating in the band 5.15-5.25 GHz...the maximum power spectral density shall not exceed 17 dBm in any 1 megahertz band. Fixed point-to-point U-NII devices may employ antennas with directional gain up to 23 dBi without any corresponding reduction in the maximum conducted output power or maximum power spectral density. For fixed point-to-point transmitters that employ a directional antenna gain greater than 23 dBi, a 1 dB reduction in maximum conducted output power and maximum power spectral density is required for each 1 dB of antenna gain in excess of 23 dBi. Fixed, point-to-point operations exclude the use of point-to-multipoint systems, omnidirectional applications, and multiple collocated transmitters transmitting the same information. The operator of the U-NII device, or if the equipment is professionally installed, the installer, is responsible for ensuring that systems employing high gain directional antennas are used exclusively for fixed, point-to-point operations.

(iv) For client devices in the 5.15-5.25 GHz band, the maximum power spectral density shall not exceed 11 dBm in any 1 megahertz band. If transmitting antennas of directional gain greater than 6 dBi are used, both the maximum conducted output power and the maximum power spectral density shall be reduced by the amount in dB that the directional gain of the antenna exceeds 6 dBi.

Power Spectral Density Test Procedure

Ref. KDB 789033 D02 General UNII Test Procedures New Rules v02r01

F. Maximum Power Spectral Density (PSD)

Power Spectral Density Test Procedure
<p>The rules requires “maximum power spectral density” measurements where the intent is to measure the maximum value of the time average of the power spectral density measured during a period of continuous transmission.</p> <ol style="list-style-type: none"> 1. Create an average power spectrum for the EUT operating mode being tested by following the instructions in section II.E.2. for measuring maximum conducted output power using a spectrum analyzer or EMI receiver: select the appropriate test method (SA-1, SA-2, SA-3, or alternatives to each) and apply it up to, but not including, the step labeled, “Compute power...”. (This procedure is required even if the maximum conducted output power measurement was performed using a power meter, method PM.) 2. Use the peak search function on the instrument to find the peak of the spectrum and record its value. 3. Make the following adjustments to the peak value of the spectrum, if applicable: a) If Method SA-2 or SA-2 Alternative was used, add $10 \log(1/x)$, where x is the duty cycle, to the peak of the spectrum. b) If Method SA-3 Alternative was used and the linear mode was used in step II.E.2.g)(viii), add 1 dB to the final result to compensate for the difference between linear averaging and power averaging. 4. The result is the Maximum PSD over 1 MHz reference bandwidth.

Ref. KDB 789033 D02 General UNII Test Procedures New Rules v02r01**2. Measurement using a Spectrum Analyzer or EMI Receiver (SA), (d) Method SA-2**

<p>Power Spectral Density Test parameters</p> <p>Method SA-2 (trace averaging across on and off times of the EUT transmissions, followed by duty cycle correction).</p> <p>(i) Measure the duty cycle, x, of the transmitter output signal as described in section II.B.</p> <p>(ii) Set span to encompass the EBW (or, alternatively, the entire 99% occupied bandwidth) of the signal.</p> <p>(iii) Set RBW = 1 MHz.</p> <p>(iv) Set VBW \geq 3 MHz.</p> <p>(v) Number of points in sweep \geq 2 Span / RBW. (This ensures that bin-to-bin spacing is \leq RBW/2, so that narrowband signals are not lost between frequency bins.)</p> <p>(vi) Sweep time = auto.</p> <p>(vii) Detector = RMS (i.e., power averaging), if available. Otherwise, use sample detector mode.</p> <p>(viii) Do not use sweep triggering. Allow the sweep to “free run”.</p> <p>(ix) Trace average at least 100 traces in power averaging (i.e., RMS) mode; however, the number of traces to be averaged shall be increased above 100 as needed to ensure that the average accurately represents the true average over the on and off periods of the transmitter.</p> <p>(x) Compute power by integrating the spectrum across the EBW (or, alternatively, the entire 99% occupied bandwidth) of the signal using the instrument’s band power measurement function with band limits set equal to the EBW (or occupied bandwidth)</p> <p>F. Maximum Power Spectral Density (PSD)</p> <p>2. Use the peak search function on the instrument to find the peak of the spectrum and record its value.</p> <p>3. Make the following adjustments to the peak value of the spectrum, if applicable: a) If Method SA-2 or SA-2 Alternative was used, add $10 \log(1/x)$, where x is the duty cycle, to the peak of the spectrum.</p>

The “measure-and-sum technique” is used for measuring in-band transmit power of a device. In the measure-and-sum approach, the conducted emission level is measured at each antenna port. The measured results at the various antenna ports are then summed mathematically to determine the total emission level from the device. Summing is performed in linear power units. ANSI C63.10 section 14.3.2.2

<p>Tested By: Johanna Knudsen, Julian Land, Mathew Blackburn</p>	<p>Date of testing: 28-JUL-2021 to 30-JUL-2021; 01-AUG-2021 to 02-AUG-2021; 06-AUG-2021; 11-AUG-2021 to 14-AUG-2021; 18-AUG-2021 to 19-AUG-2021; 23-AUG-2021 to 24-AUG-2021; 03-SEP-2021 to 04-SEP-2021</p>
<p>Test Result: PASS</p>	

Test Equipment

See Appendix C for list of test equipment

Power Spectral Density

Frequency 5180 MHz

Mode	Tx Paths	Correlated Antenna Gain (dBi)	Tx 1 PSD (dBm/MHz)	Tx 2 PSD (dBm/MHz)	Tx 3 PSD (dBm/MHz)	Tx 4 PSD (dBm/MHz)	Duty Cycle (dB)	Total PSD (dBm/MHz)	Limit (dBm/MHz)	Margin (dB)
Non HT20, 6 to 54 Mbps	1	14	4.3				0.26	4.6	9	4.4
Non HT20, 6 to 54 Mbps	2	14	-3.3	2.0			0.26	3.4	9	5.64
Non HT20, 6 to 54 Mbps	3	17	-4.5	1.0	0.2		0.26	4.5	6	1.51
Non HT20, 6 to 54 Mbps	4	17	-5.4		-0.9	-1.2	0.26	4.8	6	1.2
Non HT20 Beam Forming, 6 to 54 Mbps	2	14	-3.3	2.0			0.26	3.4	9	5.64
Non HT20 Beam Forming, 6 to 54 Mbps	3	17	-6.4	-1.2	-1.7		0.26	2.4	6	3.57
Non HT20 Beam Forming, 6 to 54 Mbps	4	17	-9.1	-3.1	-3.8	-3.7	0.26	1.9	6	4.11
HT/VHT20, M0 to M7	1	14	3.9				0.3	4.2	9	4.79
HT/VHT20, M0 to M7	2	14	-3.8	1.5			0.3	2.9	9	6.11
HT/VHT20, M8 to M15	2	14	-3.8	1.5			0.3	2.9	9	6.11
HT/VHT20, M0 to M7	3	17	-3.8	1.5	0.8		0.3	5.1	6	0.92
HT/VHT20, M8 to M15	3	14	-3.8	1.5	0.8		0.3	5.1	9	3.92
HT/VHT20, M16 to M23	3	14	-3.8	1.5	0.8		0.3	5.1	9	3.92
HT/VHT20, M0 to M7	4	17	-5.9	-0.3	-1.4	-1.5	0.3	4.5	6	1.52
HT/VHT20, M8 to M15	4	14	-5.9	-0.3	-1.4	-1.5	0.3	4.5	9	4.52
HT/VHT20, M16 to M23	4	14	-5.9	-0.3	-1.4	-1.5	0.3	4.5	9	4.52
HT/VHT20, M24 to M31	4	14	-5.9	-0.3	-1.4	-1.5	0.3	4.5	9	4.52
HT/VHT20 Beam Forming, M0 to M7	2	14	-3.8	1.5			0.3	2.9	9	6.11
HT/VHT20 Beam Forming, M8 to M15	2	14	-3.8	1.5			0.3	2.9	9	6.11
HT/VHT20 Beam Forming, M0 to M7	3	17	-7.0	-1.5	-2.4		0.3	2.0	6	3.99
HT/VHT20 Beam Forming, M8 to M15	3	14	-3.8	1.5	0.8		0.3	5.1	9	3.92
HT/VHT20 Beam Forming, M16 to M23	3	14	-3.8	1.5	0.8		0.3	5.1	9	3.92
HT/VHT20 Beam Forming, M0 to M7	4	17	-9.4	-3.7	-4.0	-4.3	0.3	1.5	6	4.53
HT/VHT20 Beam Forming, M8 to M15	4	14	-5.9	-0.3	-1.4	-1.5	0.3	4.5	9	4.52
HT/VHT20 Beam Forming, M16 to M23	4	14	-5.9	-0.3	-1.4	-1.5	0.3	4.5	9	4.52
HT/VHT20 Beam Forming, M24 to M31	4	14	-5.9	-0.3	-1.4	-1.5	0.3	4.5	9	4.52
HT/VHT20 STBC, M0 to M7	2	14	-3.8	1.5			0.3	2.9	9	6.11
HT/VHT20 STBC, M0 to M7	3	14	-3.8	1.5	0.8		0.3	5.1	9	3.92
HT/VHT20 STBC, M0 to M7	4	14	-5.9	-0.3	-1.4	-1.5	0.3	4.5	9	4.52
HE20, M0 to M9 1ss	1	14	3.9				0.22	4.1	9	4.89
HE20, M0 to M9 1ss	2	14	-3.3	1.6			0.22	3.0	9	6.0
HE20, M0 to M9 2ss	2	14	-3.3	1.6			0.22	3.0	9	6.0
HE20, M0 to M9 1ss	3	17	-3.3	1.6	0.9		0.22	5.2	6	0.82
HE20, M0 to M9 2ss	3	14	-3.3	1.6	0.9		0.22	5.2	9	3.82

HE20, M0 to M9 3ss	3	14	-3.3	1.6	0.9		0.22	5.2	9	3.82
HE20, M0 to M9 1ss	4	17	-5.6	-0.3	-1.0	-1.3	0.22	4.6	6	1.39
HE20, M0 to M9 2ss	4	14	-5.6	-0.3	-1.0	-1.3	0.22	4.6	9	4.39
HE20, M0 to M9 3ss	4	14	-5.6	-0.3	-1.0	-1.3	0.22	4.6	9	4.39
HE20, M0 to M9 4ss	4	14	-5.6	-0.3	-1.0	-1.3	0.22	4.6	9	4.39
HE20 Beam Forming, M0 to M9 1ss	2	14	-3.3	1.6			0.22	3.0	9	6.0
HE20 Beam Forming, M0 to M9 2ss	2	14	-3.3	1.6			0.22	3.0	9	6.0
HE20 Beam Forming, M0 to M9 1ss	3	17	-6.4	-1.4	-2.0		0.22	2.2	6	3.77
HE20 Beam Forming, M0 to M9 2ss	3	14	-3.3	1.6	0.9		0.22	5.2	9	3.82
HE20 Beam Forming, M0 to M9 3ss	3	14	-3.3	1.6	0.9		0.22	5.2	9	3.82
HE20 Beam Forming, M0 to M9 1ss	4	17	-9.1	-3.3	-3.9	-3.8	0.22	1.7	6	4.26
HE20 Beam Forming, M0 to M9 2ss	4	14	-5.6	-0.3	-1.0	-1.3	0.22	4.6	9	4.39
HE20 Beam Forming, M0 to M9 3ss	4	14	-5.6	-0.3	-1.0	-1.3	0.22	4.6	9	4.39
HE20 Beam Forming, M0 to M9 4ss	4	14	-5.6	-0.3	-1.0	-1.3	0.22	4.6	9	4.39
HE20 STBC, M0 to M9 2ss	2	14	-3.3	1.6			0.22	3.0	9	6.0
HE20 STBC, M0 to M9 2ss	3	14	-3.3	1.6	0.9		0.22	5.2	9	3.82
HE20 STBC, M0 to M9 2ss	4	14	-5.6	-0.3	-1.0	-1.3	0.22	4.6	9	4.39

Frequency 5190 MHz

Mode	Tx Paths	Correlated Antenna Gain (dBi)	Tx 1 PSD (dBm/MHz)	Tx 2 PSD (dBm/MHz)	Tx 3 PSD (dBm/MHz)	Tx 4 PSD (dBm/MHz)	Duty Cycle (dB)	Total PSD (dBm/MHz)	Limit (dBm/MHz)	Margin (dB)
Non HT40, 6 to 54 Mbps	1	14	-2.9				0.33	-2.5	9	11.53
Non HT40, 6 to 54 Mbps	2	14	-7.5	-2.1			0.33	-0.7	9	9.65
Non HT40, 6 to 54 Mbps	3	17	-8.4	-3.1	-3.8		0.33	0.6	6	5.44
Non HT40, 6 to 54 Mbps	4	17	-8.4	-3.1	-3.8	-4.1	0.33	1.9	6	4.08
HT/VHT40, M0 to M7	1	14	-1.7				0.33	-1.4	9	10.38
HT/VHT40, M0 to M7	2	14	-7.7	-2.3			0.85	-0.3	9	9.35
HT/VHT40, M8 to M15	2	14	-7.7	-2.3			0.85	-0.3	9	9.35
HT/VHT40, M0 to M7	3	17	-8.9	-3.1	-4.2		0.85	0.9	6	5.14
HT/VHT40, M8 to M15	3	14	-8.9	-3.1	-4.2		0.85	0.9	9	8.14
HT/VHT40, M16 to M23	3	14	-8.9	-3.1	-4.2		0.85	0.9	9	8.14
HT/VHT40, M0 to M7	4	17	-9.9	-4.5	-5.6	-5.4	0.85	0.9	6	5.07
HT/VHT40, M8 to M15	4	14	-9.9	-4.5	-5.6	-5.4	0.85	0.9	9	8.07
HT/VHT40, M16 to M23	4	14	-9.9	-4.5	-5.6	-5.4	0.85	0.9	9	8.07
HT/VHT40, M24 to M31	4	14	-9.9	-4.5	-5.6	-5.4	0.85	0.9	9	8.07
HT/VHT40 Beam Forming, M0 to M7	2	14	-7.7	-2.3			0.85	-0.3	9	9.35
HT/VHT40 Beam Forming, M8 to M15	2	14	-7.7	-2.3			0.85	-0.3	9	9.35
HT/VHT40 Beam Forming, M0 to M7	3	17	-12.0	-5.8	-6.1		0.85	-1.6	6	7.55
HT/VHT40 Beam Forming, M8 to M15	3	14	-8.9	-3.1	-4.2		0.85	0.9	9	8.14
HT/VHT40 Beam Forming, M16 to M23	3	14	-8.9	-3.1	-4.2		0.85	0.9	9	8.14
HT/VHT40 Beam Forming, M0 to M7	4	17	-12.4	-6.8	-7.3	-7.1	0.85	-1.1	6	7.06
HT/VHT40 Beam Forming, M8 to M15	4	14	-9.9	-4.5	-5.6	-5.4	0.85	0.9	9	8.07

HT/VHT40 Beam Forming, M16 to M23	4	14	-9.9	-4.5	-5.6	-5.4	0.85	0.9	9	8.07
HT/VHT40 Beam Forming, M24 to M31	4	14	-9.9	-4.5	-5.6	-5.4	0.85	0.9	9	8.07
HT/VHT40 STBC, M0 to M7	2	14	-7.7	-2.3			0.85	-0.3	9	9.35
HT/VHT40 STBC, M0 to M7	3	14	-8.9	-3.1	-4.2		0.85	0.9	9	8.14
HT/VHT40 STBC, M0 to M7	4	14	-9.9	-4.5	-5.6	-5.4	0.85	0.9	9	8.07
HE40, M0 to M9 1ss	1	14	-2.9				0.22	-2.7	9	11.69
HE40, M0 to M9 1ss	2	14	-7.3	-2.1			0.22	-0.7	9	9.69
HE40, M0 to M9 2ss	2	14	-7.3	-2.1			0.22	-0.7	9	9.69
HE40, M0 to M9 1ss	3	17	-8.5	-2.6	-3.9		0.22	0.6	6	5.4
HE40, M0 to M9 2ss	3	14	-8.5	-2.6	-3.9		0.22	0.6	9	8.4
HE40, M0 to M9 3ss	3	14	-8.5	-2.6	-3.9		0.22	0.6	9	8.4
HE40, M0 to M9 1ss	4	17	-9.7	-3.8	-4.9	-5.0	0.22	0.9	6	5.1
HE40, M0 to M9 2ss	4	14	-9.7	-3.8	-4.9	-5.0	0.22	0.9	9	8.1
HE40, M0 to M9 3ss	4	14	-9.7	-3.8	-4.9	-5.0	0.22	0.9	9	8.1
HE40, M0 to M9 4ss	4	14	-9.7	-3.8	-4.9	-5.0	0.22	0.9	9	8.1
HE40 Beam Forming, M0 to M9 1ss	2	14	-7.3	-2.1			0.22	-0.7	9	9.69
HE40 Beam Forming, M0 to M9 2ss	2	14	-7.3	-2.1			0.22	-0.7	9	9.69
HE40 Beam Forming, M0 to M9 1ss	3	17	-10.6	-4.0	-4.7		0.22	-0.6	6	6.58
HE40 Beam Forming, M0 to M9 2ss	3	14	-8.5	-2.6	-3.9		0.22	0.6	9	8.4
HE40 Beam Forming, M0 to M9 3ss	3	14	-8.5	-2.6	-3.9		0.22	0.6	9	8.4
HE40 Beam Forming, M0 to M9 1ss	4	17	-12.0	-6.1	-6.7	-6.8	0.22	-1.2	6	7.15
HE40 Beam Forming, M0 to M9 2ss	4	14	-9.7	-3.8	-4.9	-5.0	0.22	0.9	9	8.1
HE40 Beam Forming, M0 to M9 3ss	4	14	-9.7	-3.8	-4.9	-5.0	0.22	0.9	9	8.1
HE40 Beam Forming, M0 to M9 4ss	4	14	-9.7	-3.8	-4.9	-5.0	0.22	0.9	9	8.1
HE40 STBC, M0 to M9 2ss	2	14	-7.3	-2.1			0.22	-0.7	9	9.69
HE40 STBC, M0 to M9 2ss	3	14	-8.5	-2.6	-3.9		0.22	0.6	9	8.4
HE40 STBC, M0 to M9 2ss	4	14	-9.7	-3.8	-4.9	-5.0	0.22	0.9	9	8.1

Frequency 5210 MHz

Mode	Tx Paths	Correlated Antenna Gain (dBi)	Tx 1 PSD (dBm/MHz)	Tx 2 PSD (dBm/MHz)	Tx 3 PSD (dBm/MHz)	Tx 4 PSD (dBm/MHz)	Duty Cycle (dB)	Total PSD (dBm/MHz)	Limit (dBm/MHz)	Margin (dB)
Non HT80, 6 to 54 Mbps	1	14	-5.4				0.33	-5.1	9	14.08
Non HT80, 6 to 54 Mbps	2	14	-10.4	-4.3			0.33	-3.0	9	12.0
Non HT80, 6 to 54 Mbps	3	17	-10.4	-4.3	-5.3		0.33	-0.9	6	6.88
Non HT80, 6 to 54 Mbps	4	17	-11.2	-5.1	-6.4	-7.4	0.33	-0.7	6	6.65
VHT80, M0 to M9 1ss	1	14	-4.1				0.33	-3.8	9	12.8
VHT80, M0 to M9 1ss	2	14	-11.2	-4.9			0.33	-3.7	9	12.65
VHT80, M0 to M9 2ss	2	14	-11.2	-4.9			0.33	-3.7	9	12.65
VHT80, M0 to M9 1ss	3	17	-12.1	-5.8	-7.0		0.33	-2.5	6	8.47
VHT80, M0 to M9 2ss	3	14	-12.1	-5.8	-7.0		0.33	-2.5	9	11.47
VHT80, M0 to M9 3ss	3	14	-12.1	-5.8	-7.0		0.33	-2.5	9	11.47
VHT80, M0 to M9 1ss	4	17	-12.9	-6.9	-8.4	-9.3	0.33	-2.5	6	8.54
VHT80, M0 to M9 2ss	4	14	-12.9	-6.9	-8.4	-9.3	0.33	-2.5	9	11.54
VHT80, M0 to M9 3ss	4	14	-12.9	-6.9	-8.4	-9.3	0.33	-2.5	9	11.54
VHT80, M0 to M9 4ss	4	14	-12.9	-6.9	-8.4	-9.3	0.33	-2.5	9	11.54
VHT80 Beam Forming, M0 to M9 1ss	2	14	-11.2	-4.9			0.33	-3.7	9	12.65
VHT80 Beam Forming, M0 to M9 2ss	2	14	-11.2	-4.9			0.33	-3.7	9	12.65
VHT80 Beam Forming, M0 to M9 1ss	3	17	-13.9	-8.3	-8.4		0.33	-4.4	6	10.44
VHT80 Beam Forming, M0 to M9 2ss	3	14	-12.1	-5.8	-7.0		0.33	-2.5	9	11.47
VHT80 Beam Forming, M0 to M9 3ss	3	14	-12.1	-5.8	-7.0		0.33	-2.5	9	11.47
VHT80 Beam Forming, M0 to M9 1ss	4	17	-15.7	-10.8	-10.4	-11.4	0.33	-5.3	6	11.3
VHT80 Beam Forming, M0 to M9 2ss	4	14	-12.9	-6.9	-8.4	-9.3	0.33	-2.5	9	11.54
VHT80 Beam Forming, M0 to M9 3ss	4	14	-12.9	-6.9	-8.4	-9.3	0.33	-2.5	9	11.54
VHT80 Beam Forming, M0 to M9 4ss	4	14	-12.9	-6.9	-8.4	-9.3	0.33	-2.5	9	11.54
VHT80 STBC, M0 to M9 1ss	2	14	-11.2	-4.9			0.33	-3.7	9	12.65
VHT80 STBC, M0 to M9 1ss	3	14	-12.1	-5.8	-7.0		0.33	-2.5	9	11.47
VHT80 STBC, M0 to M9 1ss	4	14	-12.9	-6.9	-8.4	-9.3	0.33	-2.5	9	11.54
HE80, M0 to M9 1ss	1	14	-5.7				0.26	-5.5	9	14.47
HE80, M0 to M9 1ss	2	14	-10.6	-4.8			0.26	-3.5	9	12.54
HE80, M0 to M9 2ss	2	14	-10.6	-4.8			0.26	-3.5	9	12.54
HE80, M0 to M9 1ss	3	17	-11.4	-4.8	-6.3		0.26	-1.7	6	7.66
HE80, M0 to M9 2ss	3	14	-11.4	-4.8	-6.3		0.26	-1.7	9	10.66
HE80, M0 to M9 3ss	3	14	-11.4	-4.8	-6.3		0.26	-1.7	9	10.66
HE80, M0 to M9 1ss	4	17	-12.3	-6.3	-7.6	-9.0	0.26	-2.0	6	8.02
HE80, M0 to M9 2ss	4	14	-12.3	-6.3	-7.6	-9.0	0.26	-2.0	9	11.02
HE80, M0 to M9 3ss	4	14	-12.3	-6.3	-7.6	-9.0	0.26	-2.0	9	11.02
HE80, M0 to M9 4ss	4	14	-12.3	-6.3	-7.6	-9.0	0.26	-2.0	9	11.02
HE80 Beam Forming, M0 to M9 1ss	2	14	-10.6	-4.8			0.26	-3.5	9	12.54

HE80 Beam Forming, M0 to M9 2ss	2	14	-10.6	-4.8			0.26	-3.5	9	12.54
HE80 Beam Forming, M0 to M9 1ss	3	17	-13.3	-8.1	-7.9		0.26	-4.1	6	10.15
HE80 Beam Forming, M0 to M9 2ss	3	14	-11.4	-4.8	-6.3		0.26	-1.7	9	10.66
HE80 Beam Forming, M0 to M9 3ss	3	14	-11.4	-4.8	-6.3		0.26	-1.7	9	10.66
HE80 Beam Forming, M0 to M9 1ss	4	17	-16.1	-11.0	-10.8	-11.7	0.26	-5.7	6	11.67
HE80 Beam Forming, M0 to M9 2ss	4	14	-12.3	-6.3	-7.6	-9.0	0.26	-2.0	9	11.02
HE80 Beam Forming, M0 to M9 3ss	4	14	-12.3	-6.3	-7.6	-9.0	0.26	-2.0	9	11.02
HE80 Beam Forming, M0 to M9 4ss	4	14	-12.3	-6.3	-7.6	-9.0	0.26	-2.0	9	11.02
HE80 STBC, M0 to M9 1ss	2	14	-10.6	-4.8			0.26	-3.5	9	12.54
HE80 STBC, M0 to M9 1ss	3	14	-11.4	-4.8	-6.3		0.26	-1.7	9	10.66
HE80 STBC, M0 to M9 1ss	4	14	-12.3	-6.3	-7.6	-9.0	0.26	-2.0	9	11.02

Frequency 5220 MHz

Mode	Tx Paths	Correlated Antenna Gain (dBi)	Tx 1 PSD (dBm/MHz)	Tx 2 PSD (dBm/MHz)	Tx 3 PSD (dBm/MHz)	Tx 4 PSD (dBm/MHz)	Duty Cycle (dB)	Total PSD (dBm/MHz)	Limit (dBm/MHz)	Margin (dB)
Non HT20, 6 to 54 Mbps	1	14	5.0				0.26	5.3	9	3.75
Non HT20, 6 to 54 Mbps	2	14	-3.4	2.3			0.26	3.6	9	5.44
Non HT20, 6 to 54 Mbps	3	17	-4.2	1.3	0.6		0.26	4.9	6	1.14
Non HT20, 6 to 54 Mbps	4	17	-5.4	0.3	-0.6	-1.2	0.26	5.0	6	0.98
Non HT20 Beam Forming, 6 to 54 Mbps	2	14	-3.4	2.3			0.26	3.6	9	5.44
Non HT20 Beam Forming, 6 to 54 Mbps	3	17	-6.3	-0.6	-1.7		0.26	2.8	6	3.24
Non HT20 Beam Forming, 6 to 54 Mbps	4	17	-8.9	-3.8	-3.5	-4.5	0.26	1.5	6	4.47
HT/VHT20, M0 to M7	1	14	4.5				0.3	4.9	9	4.15
HT/VHT20, M0 to M7	2	14	-4.0	1.9			0.3	3.2	9	5.81
HT/VHT20, M8 to M15	2	14	-4.0	1.9			0.3	3.2	9	5.81
HT/VHT20, M0 to M7	3	17	-4.0	1.9	1.2		0.3	5.4	6	0.57
HT/VHT20, M8 to M15	3	14	-4.0	1.9	1.2		0.3	5.4	9	3.57
HT/VHT20, M16 to M23	3	14	-4.0	1.9	1.2		0.3	5.4	9	3.57
HT/VHT20, M0 to M7	4	17	-5.6	-0.2	-0.7	-1.7	0.3	4.7	6	1.32
HT/VHT20, M8 to M15	4	14	-5.6	-0.2	-0.7	-1.7	0.3	4.7	9	4.32
HT/VHT20, M16 to M23	4	14	-5.6	-0.2	-0.7	-1.7	0.3	4.7	9	4.32
HT/VHT20, M24 to M31	4	14	-5.6	-0.2	-0.7	-1.7	0.3	4.7	9	4.32
HT/VHT20 Beam Forming, M0 to M7	2	14	-4.0	1.9			0.3	3.2	9	5.81
HT/VHT20 Beam Forming, M8 to M15	2	14	-4.0	1.9			0.3	3.2	9	5.81
HT/VHT20 Beam Forming, M0 to M7	3	17	-6.8	-1.3	-2.5		0.3	2.1	6	3.89
HT/VHT20 Beam Forming, M8 to M15	3	14	-4.0	1.9	1.2		0.3	5.4	9	3.57

HT/VHT20 Beam Forming, M16 to M23	3	14	-4.0	1.9	1.2		0.3	5.4	9	3.57
HT/VHT20 Beam Forming, M0 to M7	4	17	-9.6	-4.6	-4.3	-4.9	0.3	0.9	6	5.08
HT/VHT20 Beam Forming, M8 to M15	4	14	-5.6	-0.2	-0.7	-1.7	0.3	4.7	9	4.32
HT/VHT20 Beam Forming, M16 to M23	4	14	-5.6	-0.2	-0.7	-1.7	0.3	4.7	9	4.32
HT/VHT20 Beam Forming, M24 to M31	4	14	-5.6	-0.2	-0.7	-1.7	0.3	4.7	9	4.32
HT/VHT20 STBC, M0 to M7	2	14	-4.0	1.9			0.3	3.2	9	5.81
HT/VHT20 STBC, M0 to M7	3	14	-4.0	1.9	1.2		0.3	5.4	9	3.57
HT/VHT20 STBC, M0 to M7	4	14	-5.6	-0.2	-0.7	-1.7	0.3	4.7	9	4.32
HE20, M0 to M9 1ss	1	14	4.7				0.22	4.9	9	4.05
HE20, M0 to M9 1ss	2	14	-3.4	2.0			0.22	3.3	9	5.71
HE20, M0 to M9 2ss	2	14	-3.4	2.0			0.22	3.3	9	5.71
HE20, M0 to M9 1ss	3	17	-4.9	1.2	0.2		0.22	4.5	6	1.49
HE20, M0 to M9 2ss	3	14	-4.9	1.2	0.2		0.22	4.5	9	4.49
HE20, M0 to M9 3ss	3	14	-4.9	1.2	0.2		0.22	4.5	9	4.49
HE20, M0 to M9 1ss	4	17	-5.9	0.3	-0.6	-1.5	0.22	4.9	6	1.14
HE20, M0 to M9 2ss	4	14	-5.9	0.3	-0.6	-1.5	0.22	4.9	9	4.14
HE20, M0 to M9 3ss	4	14	-5.9	0.3	-0.6	-1.5	0.22	4.9	9	4.14
HE20, M0 to M9 4ss	4	14	-5.9	0.3	-0.6	-1.5	0.22	4.9	9	4.14
HE20 Beam Forming, M0 to M9 1ss	2	14	-3.4	2.0			0.22	3.3	9	5.71
HE20 Beam Forming, M0 to M9 2ss	2	14	-3.4	2.0			0.22	3.3	9	5.71
HE20 Beam Forming, M0 to M9 1ss	3	17	-8.9	-1.6	-2.2		0.22	1.8	6	4.24
HE20 Beam Forming, M0 to M9 2ss	3	14	-4.9	1.2	0.2		0.22	4.5	9	4.49
HE20 Beam Forming, M0 to M9 3ss	3	14	-4.9	1.2	0.2		0.22	4.5	9	4.49
HE20 Beam Forming, M0 to M9 1ss	4	17	-9.3	-4.2	-3.8	-4.9	0.22	1.1	6	4.86
HE20 Beam Forming, M0 to M9 2ss	4	14	-5.9	0.3	-0.6	-1.5	0.22	4.9	9	4.14
HE20 Beam Forming, M0 to M9 3ss	4	14	-5.9	0.3	-0.6	-1.5	0.22	4.9	9	4.14
HE20 Beam Forming, M0 to M9 4ss	4	14	-5.9	0.3	-0.6	-1.5	0.22	4.9	9	4.14
HE20 STBC, M0 to M9 2ss	2	14	-3.4	2.0			0.22	3.3	9	5.71
HE20 STBC, M0 to M9 2ss	3	14	-4.9	1.2	0.2		0.22	4.5	9	4.49
HE20 STBC, M0 to M9 2ss	4	14	-5.9	0.3	-0.6	-1.5	0.22	4.9	9	4.14

Frequency 5230 MHz

Mode	Tx Paths	Correlated Antenna Gain (dBi)	Tx 1 PSD (dBm/MHz)	Tx 2 PSD (dBm/MHz)	Tx 3 PSD (dBm/MHz)	Tx 4 PSD (dBm/MHz)	Duty Cycle (dB)	Total PSD (dBm/MHz)	Limit (dBm/MHz)	Margin (dB)
Non HT40, 6 to 54 Mbps	1	14	2.1				0.33	2.4	9	6.61
Non HT40, 6 to 54 Mbps	2	14	-6.5	-0.9			0.33	0.5	9	8.53
Non HT40, 6 to 54 Mbps	3	17	-7.4	-1.8	-2.5		0.33	1.8	6	4.17
Non HT40, 6 to 54 Mbps	4	17	-8.6	-2.9	-3.5	-4.0	0.33	2.1	6	3.9
HT/VHT40, M0 to M7	1	14	1.8				0.85	2.7	9	6.32
HT/VHT40, M0 to M7	2	14	-6.7	-0.9			0.85	1.0	9	8.03
HT/VHT40, M8 to M15	2	14	-6.7	-0.9			0.85	1.0	9	8.03
HT/VHT40, M0 to M7	3	17	-7.6	-2.0	-2.5		0.85	2.2	6	3.81
HT/VHT40, M8 to M15	3	14	-7.6	-2.0	-2.5		0.85	2.2	9	6.81
HT/VHT40, M16 to M23	3	14	-7.6	-2.0	-2.5		0.85	2.2	9	6.81
HT/VHT40, M0 to M7	4	17	-8.7	-3.0	-3.6	-4.5	0.85	2.4	6	3.57
HT/VHT40, M8 to M15	4	14	-8.7	-3.0	-3.6	-4.5	0.85	2.4	9	6.57
HT/VHT40, M16 to M23	4	14	-8.7	-3.0	-3.6	-4.5	0.85	2.4	9	6.57
HT/VHT40, M24 to M31	4	14	-8.7	-3.0	-3.6	-4.5	0.85	2.4	9	6.57
HT/VHT40 Beam Forming, M0 to M7	2	14	-6.7	-0.9			0.85	1.0	9	8.03
HT/VHT40 Beam Forming, M8 to M15	2	14	-6.7	-0.9			0.85	1.0	9	8.03
HT/VHT40 Beam Forming, M0 to M7	3	17	-11.8	-4.6	-5.1		0.85	-0.6	6	6.6
HT/VHT40 Beam Forming, M8 to M15	3	14	-7.6	-2.0	-2.5		0.85	2.2	9	6.81
HT/VHT40 Beam Forming, M16 to M23	3	14	-7.6	-2.0	-2.5		0.85	2.2	9	6.81
HT/VHT40 Beam Forming, M0 to M7	4	17	-12.1	-7.2	-7.1	-7.7	0.85	-1.2	6	7.25
HT/VHT40 Beam Forming, M8 to M15	4	14	-8.7	-3.0	-3.6	-4.5	0.85	2.4	9	6.57
HT/VHT40 Beam Forming, M16 to M23	4	14	-8.7	-3.0	-3.6	-4.5	0.85	2.4	9	6.57
HT/VHT40 Beam Forming, M24 to M31	4	14	-8.7	-3.0	-3.6	-4.5	0.85	2.4	9	6.57
HT/VHT40 STBC, M0 to M7	2	14	-6.7	-0.9			0.85	1.0	9	8.03
HT/VHT40 STBC, M0 to M7	3	14	-7.6	-2.0	-2.5		0.85	2.2	9	6.81
HT/VHT40 STBC, M0 to M7	4	14	-8.7	-3.0	-3.6	-4.5	0.85	2.4	9	6.57
HE40, M0 to M9 1ss	1	14	2.0				0.22	2.3	9	6.75
HE40, M0 to M9 1ss	2	14	-6.5	-0.7			0.22	0.5	9	8.46
HE40, M0 to M9 2ss	2	14	-6.5	-0.7			0.22	0.5	9	8.46
HE40, M0 to M9 1ss	3	17	-7.3	-1.3	-2.0		0.22	2.1	6	3.88
HE40, M0 to M9 2ss	3	14	-7.3	-1.3	-2.0		0.22	2.1	9	6.88
HE40, M0 to M9 3ss	3	14	-7.3	-1.3	-2.0		0.22	2.1	9	6.88
HE40, M0 to M9 1ss	4	17	-8.4	-2.5	-3.4	-3.7	0.22	2.3	6	3.73
HE40, M0 to M9 2ss	4	14	-8.4	-2.5	-3.4	-3.7	0.22	2.3	9	6.73
HE40, M0 to M9 3ss	4	14	-8.4	-2.5	-3.4	-3.7	0.22	2.3	9	6.73
HE40, M0 to M9 4ss	4	14	-8.4	-2.5	-3.4	-3.7	0.22	2.3	9	6.73
HE40 Beam Forming, M0 to M9 1ss	2	14	-6.5	-0.7			0.22	0.5	9	8.46
HE40 Beam Forming, M0 to M9 2ss	2	14	-6.5	-0.7			0.22	0.5	9	8.46

HE40 Beam Forming, M0 to M9 1ss	3	17	-11.5	-4.7	-5.1		0.22	-1.2	6	7.21
HE40 Beam Forming, M0 to M9 2ss	3	14	-7.3	-1.3	-2.0		0.22	2.1	9	6.88
HE40 Beam Forming, M0 to M9 3ss	3	14	-7.3	-1.3	-2.0		0.22	2.1	9	6.88
HE40 Beam Forming, M0 to M9 1ss	4	17	-12.3	-7.0	-6.7	-7.4	0.22	-1.6	6	7.61
HE40 Beam Forming, M0 to M9 2ss	4	14	-8.4	-2.5	-3.4	-3.7	0.22	2.3	9	6.73
HE40 Beam Forming, M0 to M9 3ss	4	14	-8.4	-2.5	-3.4	-3.7	0.22	2.3	9	6.73
HE40 Beam Forming, M0 to M9 4ss	4	14	-8.4	-2.5	-3.4	-3.7	0.22	2.3	9	6.73
HE40 STBC, M0 to M9 2ss	2	14	-6.5	-0.7			0.22	0.5	9	8.46
HE40 STBC, M0 to M9 2ss	3	14	-7.3	-1.3	-2.0		0.22	2.1	9	6.88
HE40 STBC, M0 to M9 2ss	4	14	-8.4	-2.5	-3.4	-3.7	0.22	2.3	9	6.73

Frequency 5240 MHz

Mode	Tx Paths	Correlated Antenna Gain (dBi)	Tx 1 PSD (dBm/MHz)	Tx 2 PSD (dBm/MHz)	Tx 3 PSD (dBm/MHz)	Tx 4 PSD (dBm/MHz)	Duty Cycle (dB)	Total PSD (dBm/MHz)	Limit (dBm/MHz)	Margin (dB)
Non HT20, 6 to 54 Mbps	1	14	4.7				0.26	5.0	9	4.03
Non HT20, 6 to 54 Mbps	2	14	-3.1	4.5			0.26	5.5	9	3.54
Non HT20, 6 to 54 Mbps	3	17	-4.1	1.9	1.5		0.26	5.5	6	0.52
Non HT20, 6 to 54 Mbps	4	17	-6.0		-0.7	-1.0	0.26	4.9	6	1.1
Non HT20 Beam Forming, 6 to 54 Mbps	2	14	-3.1	4.5			0.26	5.5	9	3.54
Non HT20 Beam Forming, 6 to 54 Mbps	3	17	-6.9	-1.0	-1.9		0.26	2.4	6	3.61
Non HT20 Beam Forming, 6 to 54 Mbps	4	17	-8.2	-2.6	-2.5	-3.7	0.26	2.6	6	3.43
HT/VHT20, M0 to M7	1	14	4.3				0.3	4.6	9	4.36
HT/VHT20, M0 to M7	2	14	-3.6	4.3			0.3	5.2	9	3.75
HT/VHT20, M8 to M15	2	14	-3.6	4.3			0.3	5.2	9	3.75
HT/VHT20, M0 to M7	3	17	-4.7	1.4	1.0		0.3	5.1	6	0.94
HT/VHT20, M8 to M15	3	14	-4.7	1.4	1.0		0.3	5.1	9	3.94
HT/VHT20, M16 to M23	3	14	-4.7	1.4	1.0		0.3	5.1	9	3.94
HT/VHT20, M0 to M7	4	17	-6.3	-0.3	-0.9	-1.5	0.3	4.6	6	1.4
HT/VHT20, M8 to M15	4	14	-6.3	-0.3	-0.9	-1.5	0.3	4.6	9	4.4
HT/VHT20, M16 to M23	4	14	-6.3	-0.3	-0.9	-1.5	0.3	4.6	9	4.4
HT/VHT20, M24 to M31	4	14	-6.3	-0.3	-0.9	-1.5	0.3	4.6	9	4.4
HT/VHT20 Beam Forming, M0 to M7	2	14	-3.6	4.3			0.3	5.2	9	3.75
HT/VHT20 Beam Forming, M8 to M15	2	14	-3.6	4.3			0.3	5.2	9	3.75
HT/VHT20 Beam Forming, M0 to M7	3	17	-7.5	-1.5	-2.3		0.3	2.0	6	4.0
HT/VHT20 Beam Forming, M8 to M15	3	14	-4.7	1.4	1.0		0.3	5.1	9	3.94
HT/VHT20 Beam Forming, M16 to M23	3	14	-4.7	1.4	1.0		0.3	5.1	9	3.94
HT/VHT20 Beam Forming, M0 to M7	4	17	-8.5	-2.8	-3.4	-4.0	0.3	2.1	6	3.86
HT/VHT20 Beam Forming, M8 to M15	4	14	-6.3	-0.3	-0.9	-1.5	0.3	4.6	9	4.4
HT/VHT20 Beam Forming, M16 to M23	4	14	-6.3	-0.3	-0.9	-1.5	0.3	4.6	9	4.4

HT/VHT20 Beam Forming, M24 to M31	4	14	-6.3	-0.3	-0.9	-1.5	0.3	4.6	9	4.4
HT/VHT20 STBC, M0 to M7	2	14	-3.6	4.3			0.3	5.2	9	3.75
HT/VHT20 STBC, M0 to M7	3	14	-4.7	1.4	1.0		0.3	5.1	9	3.94
HT/VHT20 STBC, M0 to M7	4	14	-6.3	-0.3	-0.9	-1.5	0.3	4.6	9	4.4
HE20, M0 to M9 1ss	1	14	4.4				0.22	4.7	9	4.35
HE20, M0 to M9 1ss	2	14	-4.4	1.5			0.22	2.7	9	6.29
HE20, M0 to M9 2ss	2	14	-4.4	1.5			0.22	2.7	9	6.29
HE20, M0 to M9 1ss	3	17	-4.4	1.5	1.1		0.22	5.1	6	0.91
HE20, M0 to M9 2ss	3	14	-4.4	1.5	1.1		0.22	5.1	9	3.91
HE20, M0 to M9 3ss	3	14	-4.4	1.5	1.1		0.22	5.1	9	3.91
HE20, M0 to M9 1ss	4	17	-6.0	-0.5	-1.2	-1.5	0.22	4.4	6	1.6
HE20, M0 to M9 2ss	4	14	-6.0	-0.5	-1.2	-1.5	0.22	4.4	9	4.6
HE20, M0 to M9 3ss	4	14	-6.0	-0.5	-1.2	-1.5	0.22	4.4	9	4.6
HE20, M0 to M9 4ss	4	14	-6.0	-0.5	-1.2	-1.5	0.22	4.4	9	4.6
HE20 Beam Forming, M0 to M9 1ss	2	14	-4.4	1.5			0.22	2.7	9	6.29
HE20 Beam Forming, M0 to M9 2ss	2	14	-4.4	1.5			0.22	2.7	9	6.29
HE20 Beam Forming, M0 to M9 1ss	3	17	-7.3	-1.4	-1.9		0.22	2.1	6	3.85
HE20 Beam Forming, M0 to M9 2ss	3	14	-4.4	1.5	1.1		0.22	5.1	9	3.91
HE20 Beam Forming, M0 to M9 3ss	3	14	-4.4	1.5	1.1		0.22	5.1	9	3.91
HE20 Beam Forming, M0 to M9 1ss	4	17	-8.2	-2.8	-3.0	-4.0	0.22	2.2	6	3.8
HE20 Beam Forming, M0 to M9 2ss	4	14	-6.0	-0.5	-1.2	-1.5	0.22	4.4	9	4.6
HE20 Beam Forming, M0 to M9 3ss	4	14	-6.0	-0.5	-1.2	-1.5	0.22	4.4	9	4.6
HE20 Beam Forming, M0 to M9 4ss	4	14	-6.0	-0.5	-1.2	-1.5	0.22	4.4	9	4.6
HE20 STBC, M0 to M9 2ss	2	14	-4.4	1.5			0.22	2.7	9	6.29
HE20 STBC, M0 to M9 2ss	3	14	-4.4	1.5	1.1		0.22	5.1	9	3.91
HE20 STBC, M0 to M9 2ss	4	14	-6.0	-0.5	-1.2	-1.5	0.22	4.4	9	4.6

Data Screenshots

5240 MHz: Non HT20, 6 to 54 Mbps

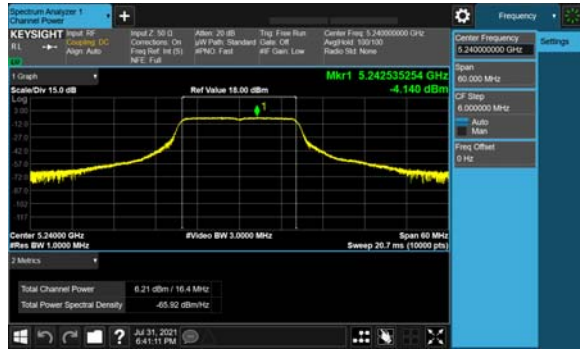

Antenna A

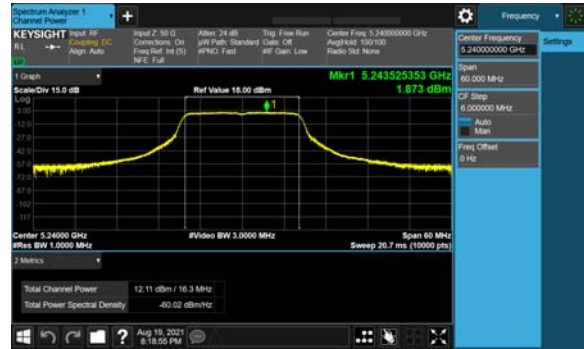

Antenna B

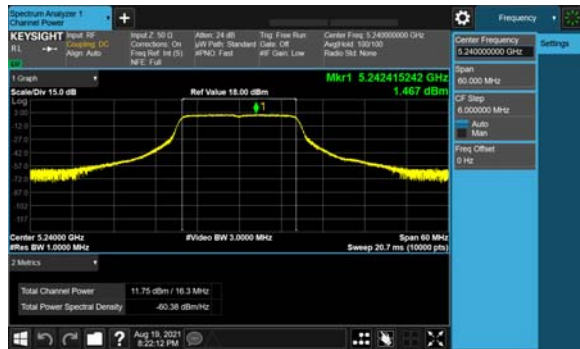

Antenna C

5220 MHz: HT/VHT20, M0 to M7



Antenna A

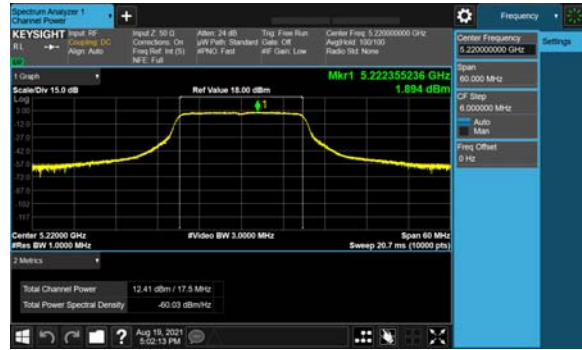

Antenna B

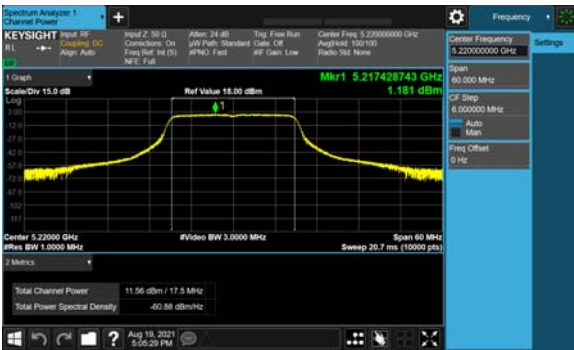

Antenna C

5180 MHz: HE20, M0 to M9 1ss



Antenna A



Antenna B



Antenna C

A.5: Conducted Spurious Emissions

Conducted Spurious Emissions Test Requirement

15.407(b)

Undesirable emission limits. Except as shown in paragraph (b)(7) of this section, the maximum emissions outside of the frequency bands of operation shall be attenuated in accordance with the following limits:

- (1) For transmitters operating in the 5.15-5.25 GHz band: All emissions outside of the 5.15-5.35 GHz band shall not exceed an e.i.r.p. of -27 dBm/MHz.
- (5) The emission measurements shall be performed using a minimum resolution bandwidth of 1 MHz. A lower resolution bandwidth may be employed near the band edge, when necessary, provided the measured energy is integrated to show the total power over 1 MHz.
- (6) Unwanted emissions below 1 GHz must comply with the general field strength limits set forth in §15.209.
- (7) The provisions of §15.205 apply to intentional radiators operating under this section.
- (8) When measuring the emission limits, the nominal carrier frequency shall be adjusted as close to the upper and lower frequency band edges as the design of the equipment permits.

Radiated emissions which fall in the restricted bands, as defined in Section 15.205(a), must also comply with the radiated emission limits specified in Section 15.209(a) (see Section 15.205(c)).

Use formula below to substitute conducted measurements in place of radiated measurements

$$E[\text{dB}\mu\text{V}/\text{m}] = \text{EIRP}[\text{dBm}] - 20 \log(d[\text{meters}]) + 104.77, \text{ where } E = \text{field strength and } d = 3 \text{ meter}$$

- 1) Average Plot, Limit= -41.25 dBm eirp
- 2) Peak plot, Limit = -21.25 dBm eirp

KDB 789033 D02 General UNII Test Procedures New Rules v02r01

2. Unwanted Emissions that fall Outside of the Restricted Bands

- a) For all measurements, follow the requirements in II.G.3. *“General Requirements for Unwanted Emissions Measurements.”*
- b) At frequencies below 1000 MHz, use the procedure described in II.G.4. *“Procedure for Unwanted Emissions Measurements Below 1000 MHz.”*
- c) At frequencies above 1000 MHz, use the procedure for maximum emissions described in II.G.5., *“Procedure for Unwanted Emissions Measurements Above 1000 MHz.”*
- (i) Sections 15.407(b)(1-3) specifies the unwanted emissions limit for the U-NII-1 and U-NII-2 bands. As specified, emissions above 1000 MHz that are outside of the restricted bands are subject to a peak emission limit of -27 dBm/MHz.

Conducted Spurious Emissions Test Procedure**Ref. ANSI C63.10: 2013****KDB 789033 D02 General UNII Test Procedures New Rules v02r01**

Conducted Spurious Emissions Test Procedure
<ol style="list-style-type: none"> 1. Connect the antenna port(s) to the spectrum analyzer input. 2. Place the radio in continuous transmit mode 3. Configure Spectrum analyzer as per test parameters below (be sure to enter all losses between the transmitter output and the spectrum analyzer). 4. Use the peak marker function to determine the maximum spurs amplitude level. 5. The “measure-and-sum technique” is used for measuring in-band transmit power of a device. In the measure-and-sum approach, the conducted emission level is measured at each antenna port. The measured results at the various antenna ports are then summed mathematically to determine the total emission level from the device. Summing is performed in linear power units. The worst-case output is recorded. (See ANSI C63.10:2013 section 14.3.2.2) 6. Capture graphs and record pertinent measurement data.

Ref. ANSI C63.10: 2013 section 12.7.6 (Peak) and 12.7.7.2 (Average)**KDB 789033 D02 General UNII Test Procedures New Rules v02r01, Sec. 5 (Peak), Sec. 6 (Average Method AD)**

Conducted Spurious Emissions Test parameters	
Peak RBW = 1 MHz VBW ≥ 3 MHz Sweep = Auto Detector = Peak Trace = Max Hold.	Average RBW = 1 MHz VBW ≥ 3 MHz Sweep = Auto Detector = RMS Power Averaging

Add the max antenna gain + ground reflection factor (4.7 dB for frequencies between 30 MHz and 1000 MHz, and 0 dB for frequencies > 1000 MHz).

Tested By: Johanna Knudsen, Julian Land, Mathew Blackburn	Date of testing: 26-JUL-2021 to 28-AUG-2021; 01-SEP-2021 to 04-SEP-2021; 11-SEP-2021 to 14-SEP-2021
Test Result: PASS	

Test Equipment

See Appendix C for list of test equipment

Conducted Spurs Average Upper

Frequency 5180 MHz

Mode	Tx Paths	Correlated Antenna Gain (dBi)	Tx 1 Spur Power (dBm)	Duty Cycle (dB)	Total Conducted Spur (dBm)	Limit (dB)	Margin (dB)
Non HT20, 6 to 54 Mbps	1	14	-67.2	0.26	-53.0	-41	11.73

Data Screenshots

5180 MHz: Non HT20, 6 to 54 Mbps

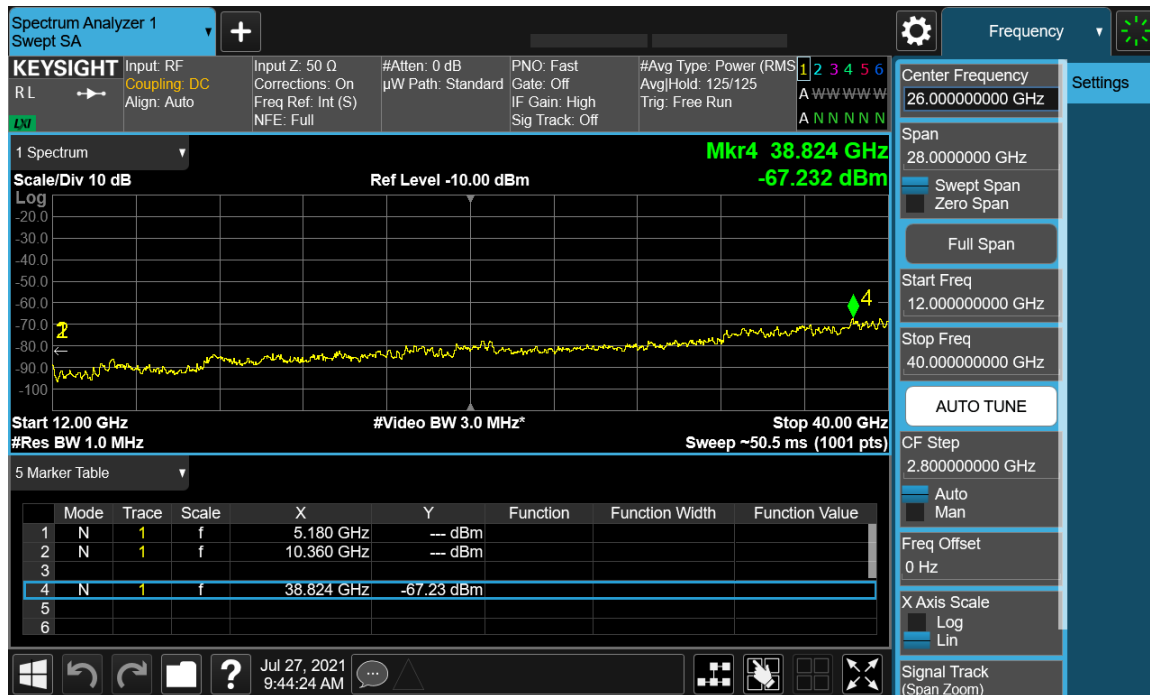

Antenna A

Conducted Spurs Peak Upper

Frequency 5180 MHz

Mode	Tx Paths	Correlated Antenna Gain (dBi)	Tx 1 Spur Power (dBm)	Duty Cycle (dB)	Total Conducted Spur (dBm)	Limit (dB)	Margin (dB)
Non HT20, 6 to 54 Mbps	1	14	-46.2	0.26	-31.9	-21	10.66

Data Screenshots

5180 MHz: Non HT20, 6 to 54 Mbps

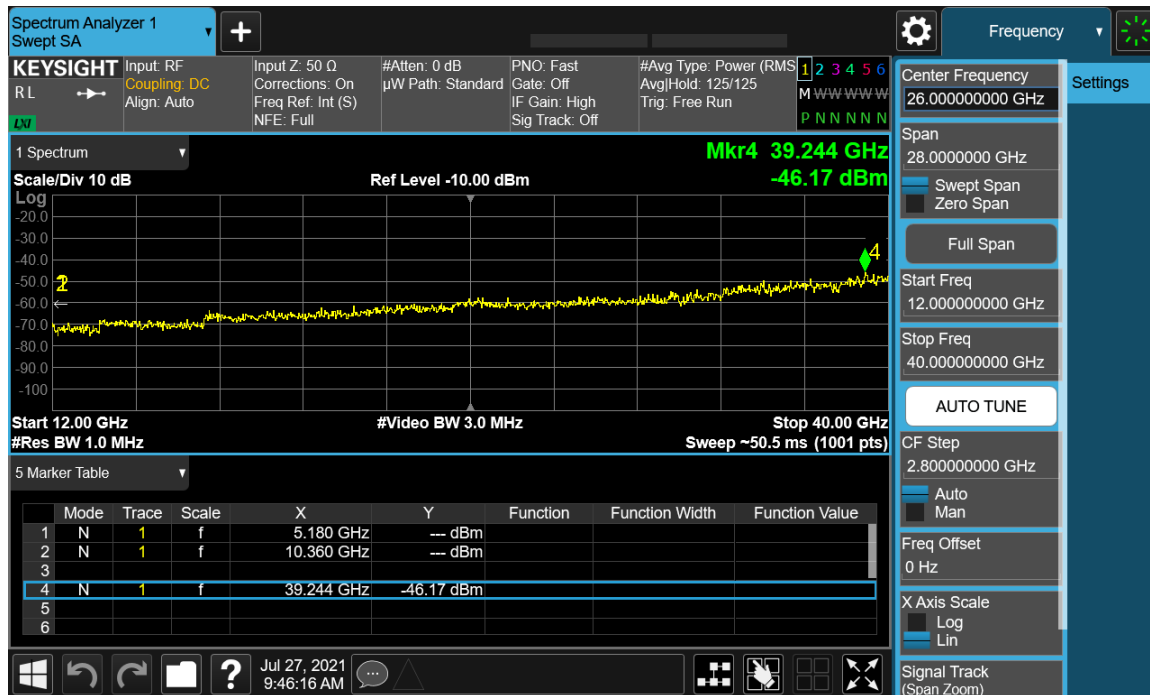

Antenna A

Conducted Spurs Average

Frequency 5180 MHz

Mode	Tx Paths	Correlated Antenna Gain (dBi)	Tx 1 Spur Power (dBm)	Tx 2 Spur Power (dBm)	Tx 3 Spur Power (dBm)	Tx 4 Spur Power (dBm)	Duty Cycle (dB)	Total Conducted Spur (dBm)	Limit (dB)	Margin (dB)
Non HT20, 6 to 54 Mbps	1	14	-63.6				0.26	-49.3	-41	8.09
Non HT20, 6 to 54 Mbps	2	14	-72.2	-68.8			0.26	-52.9	-41	11.66
Non HT20, 6 to 54 Mbps	3	14	-72.0	-69.1	-67.0		0.26	-49.9	-41	8.63
Non HT20, 6 to 54 Mbps	4	14	-72.4	-69.0	-66.5	-68.0	0.26	-48.2	-41	6.97
Non HT20 Beam Forming, 6 to 54 Mbps	2	14	-72.2	-68.8			0.26	-52.9	-41	11.66
Non HT20 Beam Forming, 6 to 54 Mbps	3	17	-72.0	-68.9	-66.5		0.26	-46.6	-41	5.31
Non HT20 Beam Forming, 6 to 54 Mbps	4	17	-75.4	-74.1	-72.2	-72.6	0.26	-50.1	-41	8.87
HT/VHT20, M0 to M7	1	14	-63.4				0.3	-49.1	-41	7.85
HT/VHT20, M0 to M7	2	14	-72.2	-65.3			0.3	-50.2	-41	8.94
HT/VHT20, M8 to M15	2	14	-72.2	-65.3			0.3	-50.2	-41	8.94
HT/VHT20, M0 to M7	3	14	-72.2	-65.3	-67.1		0.3	-48.3	-41	7.04
HT/VHT20, M8 to M15	3	14	-72.2	-65.3	-67.1		0.3	-48.3	-41	7.04
HT/VHT20, M16 to M23	3	14	-72.2	-65.3	-67.1		0.3	-48.3	-41	7.04
HT/VHT20, M0 to M7	4	14	-72.5	-68.9	-66.7	-68.0	0.3	-48.2	-41	6.99
HT/VHT20, M8 to M15	4	14	-72.5	-68.9	-66.7	-68.0	0.3	-48.2	-41	6.99
HT/VHT20, M16 to M23	4	14	-72.5	-68.9	-66.7	-68.0	0.3	-48.2	-41	6.99
HT/VHT20, M24 to M31	4	14	-72.5	-68.9	-66.7	-68.0	0.3	-48.2	-41	6.99
HT/VHT20 Beam Forming, M0 to M7	2	14	-72.2	-65.3			0.3	-50.2	-41	8.94
HT/VHT20 Beam Forming, M8 to M15	2	14	-72.2	-65.3			0.3	-50.2	-41	8.94
HT/VHT20 Beam Forming, M0 to M7	3	17	-72.2	-69.0	-66.4		0.3	-46.5	-41	5.26
HT/VHT20 Beam Forming, M8 to M15	3	14	-72.2	-65.3	-67.1		0.3	-48.3	-41	7.04
HT/VHT20 Beam Forming, M16 to M23	3	14	-72.2	-65.3	-67.1		0.3	-48.3	-41	7.04
HT/VHT20 Beam Forming, M0 to M7	4	17	-75.7	-74.5	-72.1	-72.6	0.3	-50.2	-41	8.92
HT/VHT20 Beam Forming, M8 to M15	4	14	-72.5	-68.9	-66.7	-68.0	0.3	-48.2	-41	6.99
HT/VHT20 Beam Forming, M16 to M23	4	14	-72.5	-68.9	-66.7	-68.0	0.3	-48.2	-41	6.99
HT/VHT20 Beam Forming, M24 to M31	4	14	-72.5	-68.9	-66.7	-68.0	0.3	-48.2	-41	6.99
HT/VHT20 STBC, M0 to M7	2	14	-72.2	-65.3			0.3	-50.2	-41	8.94
HT/VHT20 STBC, M0 to M7	3	14	-72.2	-65.3	-67.1		0.3	-48.3	-41	7.04
HT/VHT20 STBC, M0 to M7	4	14	-72.5	-68.9	-66.7	-68.0	0.3	-48.2	-41	6.99
HE20, M0 to M9 1ss	1	14	-63.2				0.22	-49.0	-41	7.73
HE20, M0 to M9 1ss	2	14	-67.8	-64.8			0.22	-48.8	-41	7.57
HE20, M0 to M9 2ss	2	14	-67.8	-64.8			0.22	-48.8	-41	7.57
HE20, M0 to M9 1ss	3	14	-67.8	-64.8	-66.8		0.22	-47.3	-41	6.04
HE20, M0 to M9 2ss	3	14	-67.8	-64.8	-66.8		0.22	-47.3	-41	6.04

HE20, M0 to M9 3ss	3	14	-67.8	-64.8	-66.8		0.22	-47.3	-41	6.04
HE20, M0 to M9 1ss	4	14	-72.0	-68.8	-66.8	-68.1	0.22	-48.3	-41	7.06
HE20, M0 to M9 2ss	4	14	-72.0	-68.8	-66.8	-68.1	0.22	-48.3	-41	7.06
HE20, M0 to M9 3ss	4	14	-72.0	-68.8	-66.8	-68.1	0.22	-48.3	-41	7.06
HE20, M0 to M9 4ss	4	14	-72.0	-68.8	-66.8	-68.1	0.22	-48.3	-41	7.06
HE20 Beam Forming, M0 to M9 1ss	2	14	-67.8	-64.8			0.22	-48.8	-41	7.57
HE20 Beam Forming, M0 to M9 2ss	2	14	-67.8	-64.8			0.22	-48.8	-41	7.57
HE20 Beam Forming, M0 to M9 1ss	3	17	-72.0	-69.0	-66.8		0.22	-46.8	-41	5.53
HE20 Beam Forming, M0 to M9 2ss	3	14	-67.8	-64.8	-66.8		0.22	-47.3	-41	6.04
HE20 Beam Forming, M0 to M9 3ss	3	14	-67.8	-64.8	-66.8		0.22	-47.3	-41	6.04
HE20 Beam Forming, M0 to M9 1ss	4	17	-75.1	-74.4	-71.8	-72.4	0.22	-50.0	-41	8.73
HE20 Beam Forming, M0 to M9 2ss	4	14	-72.0	-68.8	-66.8	-68.1	0.22	-48.3	-41	7.06
HE20 Beam Forming, M0 to M9 3ss	4	14	-72.0	-68.8	-66.8	-68.1	0.22	-48.3	-41	7.06
HE20 Beam Forming, M0 to M9 4ss	4	14	-72.0	-68.8	-66.8	-68.1	0.22	-48.3	-41	7.06
HE20 STBC, M0 to M9 2ss	2	14	-67.8	-64.8			0.22	-48.8	-41	7.57
HE20 STBC, M0 to M9 2ss	3	14	-67.8	-64.8	-66.8		0.22	-47.3	-41	6.04
HE20 STBC, M0 to M9 2ss	4	14	-72.0	-68.8	-66.8	-68.1	0.22	-48.3	-41	7.06

Frequency 5190 MHz

Mode	Tx Paths	Correlated Antenna Gain (dBi)	Tx 1 Spur Power (dBm)	Tx 2 Spur Power (dBm)	Tx 3 Spur Power (dBm)	Tx 4 Spur Power (dBm)	Duty Cycle (dB)	Total Conducted Spur (dBm)	Limit (dB)	Margin (dB)
Non HT40, 6 to 54 Mbps	1	14	-67.5				0.33	-53.2	-41	11.92
Non HT40, 6 to 54 Mbps	2	14	-71.9	-69.0			0.33	-52.9	-41	11.62
Non HT40, 6 to 54 Mbps	3	14	-72.0	-68.8	-66.6		0.33	-49.5	-41	8.25
Non HT40, 6 to 54 Mbps	4	14	-72.0	-68.8	-66.6	-68.0	0.33	-48.1	-41	6.84
HT/VHT40, M0 to M7	1	14	-67.7				0.33	-53.4	-41	12.12
HT/VHT40, M0 to M7	2	14	-72.0	-69.2			0.85	-52.5	-41	11.27
HT/VHT40, M8 to M15	2	14	-72.0	-69.2			0.85	-52.5	-41	11.27
HT/VHT40, M0 to M7	3	14	-72.3	-69.0	-66.8		0.85	-49.2	-41	7.95
HT/VHT40, M8 to M15	3	14	-72.3	-69.0	-66.8		0.85	-49.2	-41	7.95
HT/VHT40, M16 to M23	3	14	-72.3	-69.0	-66.8		0.85	-49.2	-41	7.95
HT/VHT40, M0 to M7	4	14	-72.3	-68.9	-66.4	-68.0	0.85	-47.6	-41	6.3
HT/VHT40, M8 to M15	4	14	-72.3	-68.9	-66.4	-68.0	0.85	-47.6	-41	6.3
HT/VHT40, M16 to M23	4	14	-72.3	-68.9	-66.4	-68.0	0.85	-47.6	-41	6.3
HT/VHT40, M24 to M31	4	14	-72.3	-68.9	-66.4	-68.0	0.85	-47.6	-41	6.3
HT/VHT40 Beam Forming, M0 to M7	2	14	-72.0	-69.2			0.85	-52.5	-41	11.27
HT/VHT40 Beam Forming, M8 to M15	2	14	-72.0	-69.2			0.85	-52.5	-41	11.27
HT/VHT40 Beam Forming, M0 to M7	3	17	-75.0	-74.7	-71.5		0.85	-50.8	-41	9.55

HT/VHT40 Beam Forming, M8 to M15	3	14	-72.3	-69.0	-66.8		0.85	-49.2	-41	7.95
HT/VHT40 Beam Forming, M16 to M23	3	14	-72.3	-69.0	-66.8		0.85	-49.2	-41	7.95
HT/VHT40 Beam Forming, M0 to M7	4	17	-75.6	-74.8	-72.2	-73.0	0.85	-49.8	-41	8.57
HT/VHT40 Beam Forming, M8 to M15	4	14	-72.3	-68.9	-66.4	-68.0	0.85	-47.6	-41	6.3
HT/VHT40 Beam Forming, M16 to M23	4	14	-72.3	-68.9	-66.4	-68.0	0.85	-47.6	-41	6.3
HT/VHT40 Beam Forming, M24 to M31	4	14	-72.3	-68.9	-66.4	-68.0	0.85	-47.6	-41	6.3
HT/VHT40 STBC, M0 to M7	2	14	-72.0	-69.2			0.85	-52.5	-41	11.27
HT/VHT40 STBC, M0 to M7	3	14	-72.3	-69.0	-66.8		0.85	-49.2	-41	7.95
HT/VHT40 STBC, M0 to M7	4	14	-72.3	-68.9	-66.4	-68.0	0.85	-47.6	-41	6.3
HE40, M0 to M9 1ss	1	14	-67.5				0.22	-53.3	-41	12.03
HE40, M0 to M9 1ss	2	14	-72.0	-69.0			0.22	-53.0	-41	11.76
HE40, M0 to M9 2ss	2	14	-72.0	-69.0			0.22	-53.0	-41	11.76
HE40, M0 to M9 1ss	3	14	-71.9	-68.8	-66.4		0.22	-49.5	-41	8.24
HE40, M0 to M9 2ss	3	14	-71.9	-68.8	-66.4		0.22	-49.5	-41	8.24
HE40, M0 to M9 3ss	3	14	-71.9	-68.8	-66.4		0.22	-49.5	-41	8.24
HE40, M0 to M9 1ss	4	14	-71.8	-68.7	-66.7	-67.6	0.22	-48.1	-41	6.83
HE40, M0 to M9 2ss	4	14	-71.8	-68.7	-66.7	-67.6	0.22	-48.1	-41	6.83
HE40, M0 to M9 3ss	4	14	-71.8	-68.7	-66.7	-67.6	0.22	-48.1	-41	6.83
HE40, M0 to M9 4ss	4	14	-71.8	-68.7	-66.7	-67.6	0.22	-48.1	-41	6.83
HE40 Beam Forming, M0 to M9 1ss	2	14	-72.0	-69.0			0.22	-53.0	-41	11.76
HE40 Beam Forming, M0 to M9 2ss	2	14	-72.0	-69.0			0.22	-53.0	-41	11.76
HE40 Beam Forming, M0 to M9 1ss	3	17	-72.1	-70.7	-68.0		0.22	-47.9	-41	6.68
HE40 Beam Forming, M0 to M9 2ss	3	14	-71.9	-68.8	-66.4		0.22	-49.5	-41	8.24
HE40 Beam Forming, M0 to M9 3ss	3	14	-71.9	-68.8	-66.4		0.22	-49.5	-41	8.24
HE40 Beam Forming, M0 to M9 1ss	4	17	-74.9	-73.9	-71.8	-72.4	0.22	-49.8	-41	8.59
HE40 Beam Forming, M0 to M9 2ss	4	14	-71.8	-68.7	-66.7	-67.6	0.22	-48.1	-41	6.83
HE40 Beam Forming, M0 to M9 3ss	4	14	-71.8	-68.7	-66.7	-67.6	0.22	-48.1	-41	6.83
HE40 Beam Forming, M0 to M9 4ss	4	14	-71.8	-68.7	-66.7	-67.6	0.22	-48.1	-41	6.83
HE40 STBC, M0 to M9 2ss	2	14	-72.0	-69.0			0.22	-53.0	-41	11.76
HE40 STBC, M0 to M9 2ss	3	14	-71.9	-68.8	-66.4		0.22	-49.5	-41	8.24
HE40 STBC, M0 to M9 2ss	4	14	-71.8	-68.7	-66.7	-67.6	0.22	-48.1	-41	6.83

Frequency 5210 MHz

Mode	Tx Paths	Correlated Antenna Gain (dBi)	Tx 1 Spur Power (dBm)	Tx 2 Spur Power (dBm)	Tx 3 Spur Power (dBm)	Tx 4 Spur Power (dBm)	Duty Cycle (dB)	Total Conducted Spur (dBm)	Limit (dB)	Margin (dB)
Non HT80, 6 to 54 Mbps	1	14	-67.5				0.33	-53.2	-41	11.92
Non HT80, 6 to 54 Mbps	2	14	-72.1	-68.6			0.33	-52.7	-41	11.41
Non HT80, 6 to 54 Mbps	3	14	-72.1	-68.6	-66.2		0.33	-49.2	-41	7.99
Non HT80, 6 to 54 Mbps	4	14	-71.9	-68.8	-66.4	-67.3	0.33	-47.8	-41	6.55
VHT80, M0 to M9 1ss	1	14	-63.2				0.33	-48.9	-41	7.62
VHT80, M0 to M9 1ss	2	14	-72.4	-68.8			0.33	-52.9	-41	11.65
VHT80, M0 to M9 2ss	2	14	-72.4	-68.8			0.33	-52.9	-41	11.65
VHT80, M0 to M9 1ss	3	14	-72.2	-68.4	-66.7		0.33	-49.5	-41	8.2
VHT80, M0 to M9 2ss	3	14	-72.2	-68.4	-66.7		0.33	-49.5	-41	8.2
VHT80, M0 to M9 3ss	3	14	-72.2	-68.4	-66.7		0.33	-49.5	-41	8.2
VHT80, M0 to M9 1ss	4	14	-72.1	-68.6	-66.8	-67.6	0.33	-48.0	-41	6.77
VHT80, M0 to M9 2ss	4	14	-72.1	-68.6	-66.8	-67.6	0.33	-48.0	-41	6.77
VHT80, M0 to M9 3ss	4	14	-72.1	-68.6	-66.8	-67.6	0.33	-48.0	-41	6.77
VHT80, M0 to M9 4ss	4	14	-72.1	-68.6	-66.8	-67.6	0.33	-48.0	-41	6.77
VHT80 Beam Forming, M0 to M9 1ss	2	14	-72.4	-68.8			0.33	-52.9	-41	11.65
VHT80 Beam Forming, M0 to M9 2ss	2	14	-72.4	-68.8			0.33	-52.9	-41	11.65
VHT80 Beam Forming, M0 to M9 1ss	3	17	-72.3	-71.9	-67.9		0.33	-48.1	-41	6.86
VHT80 Beam Forming, M0 to M9 2ss	3	14	-72.2	-68.4	-66.7		0.33	-49.5	-41	8.2
VHT80 Beam Forming, M0 to M9 3ss	3	14	-72.2	-68.4	-66.7		0.33	-49.5	-41	8.2
VHT80 Beam Forming, M0 to M9 1ss	4	17	-75.2	-74.3	-71.7	-72.2	0.33	-49.8	-41	8.51
VHT80 Beam Forming, M0 to M9 2ss	4	14	-72.1	-68.6	-66.8	-67.6	0.33	-48.0	-41	6.77
VHT80 Beam Forming, M0 to M9 3ss	4	14	-72.1	-68.6	-66.8	-67.6	0.33	-48.0	-41	6.77
VHT80 Beam Forming, M0 to M9 4ss	4	14	-72.1	-68.6	-66.8	-67.6	0.33	-48.0	-41	6.77
VHT80 STBC, M0 to M9 1ss	2	14	-72.4	-68.8			0.33	-52.9	-41	11.65
VHT80 STBC, M0 to M9 1ss	3	14	-72.2	-68.4	-66.7		0.33	-49.5	-41	8.2
VHT80 STBC, M0 to M9 1ss	4	14	-72.1	-68.6	-66.8	-67.6	0.33	-48.0	-41	6.77
HE80, M0 to M9 1ss	1	14	-67.5				0.26	-53.2	-41	11.99
HE80, M0 to M9 1ss	2	14	-72.0	-71.3			0.26	-54.4	-41	13.11
HE80, M0 to M9 2ss	2	14	-72.0	-71.3			0.26	-54.4	-41	13.11
HE80, M0 to M9 1ss	3	14	-72.1	-68.4	-66.3		0.26	-49.3	-41	8.05
HE80, M0 to M9 2ss	3	14	-72.1	-68.4	-66.3		0.26	-49.3	-41	8.05
HE80, M0 to M9 3ss	3	14	-72.1	-68.4	-66.3		0.26	-49.3	-41	8.05
HE80, M0 to M9 1ss	4	14	-72.0	-68.4	-66.1	-67.2	0.26	-47.7	-41	6.4
HE80, M0 to M9 2ss	4	14	-72.0	-68.4	-66.1	-67.2	0.26	-47.7	-41	6.4
HE80, M0 to M9 3ss	4	14	-72.0	-68.4	-66.1	-67.2	0.26	-47.7	-41	6.4
HE80, M0 to M9 4ss	4	14	-72.0	-68.4	-66.1	-67.2	0.26	-47.7	-41	6.4
HE80 Beam Forming, M0 to M9 1ss	2	14	-72.0	-71.3			0.26	-54.4	-41	13.11

HE80 Beam Forming, M0 to M9 2ss	2	14	-72.0	-71.3			0.26	-54.4	-41	13.11
HE80 Beam Forming, M0 to M9 1ss	3	17	-71.9	-71.2	-67.7		0.26	-47.8	-41	6.57
HE80 Beam Forming, M0 to M9 2ss	3	14	-72.1	-68.4	-66.3		0.26	-49.3	-41	8.05
HE80 Beam Forming, M0 to M9 3ss	3	14	-72.1	-68.4	-66.3		0.26	-49.3	-41	8.05
HE80 Beam Forming, M0 to M9 1ss	4	17	-75.5	-74.1	-71.7	-72.2	0.26	-49.8	-41	8.59
HE80 Beam Forming, M0 to M9 2ss	4	14	-72.0	-68.4	-66.1	-67.2	0.26	-47.7	-41	6.4
HE80 Beam Forming, M0 to M9 3ss	4	14	-72.0	-68.4	-66.1	-67.2	0.26	-47.7	-41	6.4
HE80 Beam Forming, M0 to M9 4ss	4	14	-72.0	-68.4	-66.1	-67.2	0.26	-47.7	-41	6.4
HE80 STBC, M0 to M9 1ss	2	14	-72.0	-71.3			0.26	-54.4	-41	13.11
HE80 STBC, M0 to M9 1ss	3	14	-72.1	-68.4	-66.3		0.26	-49.3	-41	8.05
HE80 STBC, M0 to M9 1ss	4	14	-72.0	-68.4	-66.1	-67.2	0.26	-47.7	-41	6.4

Frequency 5220 MHz

Mode	Tx Paths	Correlated Antenna Gain (dBi)	Tx 1 Spur Power (dBm)	Tx 2 Spur Power (dBm)	Tx 3 Spur Power (dBm)	Tx 4 Spur Power (dBm)	Duty Cycle (dB)	Total Conducted Spur (dBm)	Limit (dB)	Margin (dB)
Non HT20, 6 to 54 Mbps	1	14	-63.4				0.26	-49.1	-41	7.89
Non HT20, 6 to 54 Mbps	2	14	-72.0	-65.2			0.26	-50.1	-41	8.87
Non HT20, 6 to 54 Mbps	3	14	-72.1	-69.3	-67.0		0.26	-50.0	-41	8.71
Non HT20, 6 to 54 Mbps	4	14	-72.3	-69.3	-66.8	-67.7	0.26	-48.3	-41	7.05
Non HT20 Beam Forming, 6 to 54 Mbps	2	14	-72.0	-65.2			0.26	-50.1	-41	8.87
Non HT20 Beam Forming, 6 to 54 Mbps	3	17	-72.1	-69.0	-67.0		0.26	-46.9	-41	5.62
Non HT20 Beam Forming, 6 to 54 Mbps	4	17	-75.6	-74.3	-72.0	-72.3	0.26	-50.0	-41	8.78
HT/VHT20, M0 to M7	1	14	-63.5				0.3	-49.2	-41	7.95
HT/VHT20, M0 to M7	2	14	-72.3	-65.4			0.3	-50.3	-41	9.04
HT/VHT20, M8 to M15	2	14	-72.3	-65.4			0.3	-50.3	-41	9.04
HT/VHT20, M0 to M7	3	14	-72.3	-65.4	-67.0		0.3	-48.3	-41	7.07
HT/VHT20, M8 to M15	3	14	-72.3	-65.4	-67.0		0.3	-48.3	-41	7.07
HT/VHT20, M16 to M23	3	14	-72.3	-65.4	-67.0		0.3	-48.3	-41	7.07
HT/VHT20, M0 to M7	4	14	-72.4	-69.1	-66.8	-68.0	0.3	-48.3	-41	7.06
HT/VHT20, M8 to M15	4	14	-72.4	-69.1	-66.8	-68.0	0.3	-48.3	-41	7.06
HT/VHT20, M16 to M23	4	14	-72.4	-69.1	-66.8	-68.0	0.3	-48.3	-41	7.06
HT/VHT20, M24 to M31	4	14	-72.4	-69.1	-66.8	-68.0	0.3	-48.3	-41	7.06
HT/VHT20 Beam Forming, M0 to M7	2	14	-72.3	-65.4			0.3	-50.3	-41	9.04
HT/VHT20 Beam Forming, M8 to M15	2	14	-72.3	-65.4			0.3	-50.3	-41	9.04
HT/VHT20 Beam Forming, M0 to M7	3	17	-72.1	-69.1	-67.0		0.3	-46.9	-41	5.6
HT/VHT20 Beam Forming, M8 to M15	3	14	-72.3	-65.4	-67.0		0.3	-48.3	-41	7.07

HT/VHT20 Beam Forming, M16 to M23	3	14	-72.3	-65.4	-67.0		0.3	-48.3	-41	7.07
HT/VHT20 Beam Forming, M0 to M7	4	17	-75.3	-74.6	-71.9	-72.5	0.3	-50.0	-41	8.78
HT/VHT20 Beam Forming, M8 to M15	4	14	-72.4	-69.1	-66.8	-68.0	0.3	-48.3	-41	7.06
HT/VHT20 Beam Forming, M16 to M23	4	14	-72.4	-69.1	-66.8	-68.0	0.3	-48.3	-41	7.06
HT/VHT20 Beam Forming, M24 to M31	4	14	-72.4	-69.1	-66.8	-68.0	0.3	-48.3	-41	7.06
HT/VHT20 STBC, M0 to M7	2	14	-72.3	-65.4			0.3	-50.3	-41	9.04
HT/VHT20 STBC, M0 to M7	3	14	-72.3	-65.4	-67.0		0.3	-48.3	-41	7.07
HT/VHT20 STBC, M0 to M7	4	14	-72.4	-69.1	-66.8	-68.0	0.3	-48.3	-41	7.06
HE20, M0 to M9 1ss	1	14	-63.4				0.22	-49.2	-41	7.93
HE20, M0 to M9 1ss	2	14	-67.7	-64.9			0.22	-48.9	-41	7.6
HE20, M0 to M9 2ss	2	14	-67.7	-64.9			0.22	-48.9	-41	7.6
HE20, M0 to M9 1ss	3	14	-72.1	-69.1	-66.7		0.22	-49.8	-41	8.53
HE20, M0 to M9 2ss	3	14	-72.1	-69.1	-66.7		0.22	-49.8	-41	8.53
HE20, M0 to M9 3ss	3	14	-72.1	-69.1	-66.7		0.22	-49.8	-41	8.53
HE20, M0 to M9 1ss	4	14	-72.5	-69.0	-66.7	-68.1	0.22	-48.4	-41	7.12
HE20, M0 to M9 2ss	4	14	-72.5	-69.0	-66.7	-68.1	0.22	-48.4	-41	7.12
HE20, M0 to M9 3ss	4	14	-72.5	-69.0	-66.7	-68.1	0.22	-48.4	-41	7.12
HE20, M0 to M9 4ss	4	14	-72.5	-69.0	-66.7	-68.1	0.22	-48.4	-41	7.12
HE20 Beam Forming, M0 to M9 1ss	2	14	-67.7	-64.9			0.22	-48.9	-41	7.6
HE20 Beam Forming, M0 to M9 2ss	2	14	-67.7	-64.9			0.22	-48.9	-41	7.6
HE20 Beam Forming, M0 to M9 1ss	3	17	-72.1	-71.7	-70.6		0.22	-49.4	-41	8.18
HE20 Beam Forming, M0 to M9 2ss	3	14	-72.1	-69.1	-66.7		0.22	-49.8	-41	8.53
HE20 Beam Forming, M0 to M9 3ss	3	14	-72.1	-69.1	-66.7		0.22	-49.8	-41	8.53
HE20 Beam Forming, M0 to M9 1ss	4	17	-75.2	-74.3	-71.7	-72.3	0.22	-49.9	-41	8.66
HE20 Beam Forming, M0 to M9 2ss	4	14	-72.5	-69.0	-66.7	-68.1	0.22	-48.4	-41	7.12
HE20 Beam Forming, M0 to M9 3ss	4	14	-72.5	-69.0	-66.7	-68.1	0.22	-48.4	-41	7.12
HE20 Beam Forming, M0 to M9 4ss	4	14	-72.5	-69.0	-66.7	-68.1	0.22	-48.4	-41	7.12
HE20 STBC, M0 to M9 2ss	2	14	-67.7	-64.9			0.22	-48.9	-41	7.6
HE20 STBC, M0 to M9 2ss	3	14	-72.1	-69.1	-66.7		0.22	-49.8	-41	8.53
HE20 STBC, M0 to M9 2ss	4	14	-72.5	-69.0	-66.7	-68.1	0.22	-48.4	-41	7.12

Frequency 5230 MHz

Mode	Tx Paths	Correlated Antenna Gain (dBi)	Tx 1 Spur Power (dBm)	Tx 2 Spur Power (dBm)	Tx 3 Spur Power (dBm)	Tx 4 Spur Power (dBm)	Duty Cycle (dB)	Total Conducted Spur (dBm)	Limit (dB)	Margin (dB)
Non HT40, 6 to 54 Mbps	1	14	-63.3				0.33	-49.0	-41	7.72
Non HT40, 6 to 54 Mbps	2	14	-72.0	-65.5			0.33	-50.3	-41	9.04
Non HT40, 6 to 54 Mbps	3	14	-71.8	-69.6	-66.5		0.33	-49.7	-41	8.4
Non HT40, 6 to 54 Mbps	4	14	-71.9	-69.9	-66.6	-67.8	0.33	-48.3	-41	7.0
HT/VHT40, M0 to M7	1	14	-62.9				0.85	-48.0	-41	6.8
HT/VHT40, M0 to M7	2	14	-72.2	-65.8			0.85	-50.1	-41	8.8
HT/VHT40, M8 to M15	2	14	-72.2	-65.8			0.85	-50.1	-41	8.8
HT/VHT40, M0 to M7	3	14	-72.4	-69.8	-66.6		0.85	-49.3	-41	8.09
HT/VHT40, M8 to M15	3	14	-72.4	-69.8	-66.6		0.85	-49.3	-41	8.09
HT/VHT40, M16 to M23	3	14	-72.4	-69.8	-66.6		0.85	-49.3	-41	8.09
HT/VHT40, M0 to M7	4	14	-72.3	-69.8	-67.1	-67.8	0.85	-48.0	-41	6.7
HT/VHT40, M8 to M15	4	14	-72.3	-69.8	-67.1	-67.8	0.85	-48.0	-41	6.7
HT/VHT40, M16 to M23	4	14	-72.3	-69.8	-67.1	-67.8	0.85	-48.0	-41	6.7
HT/VHT40, M24 to M31	4	14	-72.3	-69.8	-67.1	-67.8	0.85	-48.0	-41	6.7
HT/VHT40 Beam Forming, M0 to M7	2	14	-72.2	-65.8			0.85	-50.1	-41	8.8
HT/VHT40 Beam Forming, M8 to M15	2	14	-72.2	-65.8			0.85	-50.1	-41	8.8
HT/VHT40 Beam Forming, M0 to M7	3	17	-75.5	-72.5	-71.3		0.85	-50.1	-41	8.9
HT/VHT40 Beam Forming, M8 to M15	3	14	-72.4	-69.8	-66.6		0.85	-49.3	-41	8.09
HT/VHT40 Beam Forming, M16 to M23	3	14	-72.4	-69.8	-66.6		0.85	-49.3	-41	8.09
HT/VHT40 Beam Forming, M0 to M7	4	17	-75.6	-75.2	-72.1	-72.3	0.85	-49.6	-41	8.39
HT/VHT40 Beam Forming, M8 to M15	4	14	-72.3	-69.8	-67.1	-67.8	0.85	-48.0	-41	6.7
HT/VHT40 Beam Forming, M16 to M23	4	14	-72.3	-69.8	-67.1	-67.8	0.85	-48.0	-41	6.7
HT/VHT40 Beam Forming, M24 to M31	4	14	-72.3	-69.8	-67.1	-67.8	0.85	-48.0	-41	6.7
HT/VHT40 STBC, M0 to M7	2	14	-72.2	-65.8			0.85	-50.1	-41	8.8
HT/VHT40 STBC, M0 to M7	3	14	-72.4	-69.8	-66.6		0.85	-49.3	-41	8.09
HT/VHT40 STBC, M0 to M7	4	14	-72.3	-69.8	-67.1	-67.8	0.85	-48.0	-41	6.7
HE40, M0 to M9 1ss	1	14	-63.0				0.22	-48.8	-41	7.53
HE40, M0 to M9 1ss	2	14	-71.8	-65.7			0.22	-50.5	-41	9.27
HE40, M0 to M9 2ss	2	14	-71.8	-65.7			0.22	-50.5	-41	9.27
HE40, M0 to M9 1ss	3	14	-72.1	-65.6	-66.3		0.22	-48.2	-41	6.96
HE40, M0 to M9 2ss	3	14	-72.1	-65.6	-66.3		0.22	-48.2	-41	6.96
HE40, M0 to M9 3ss	3	14	-72.1	-65.6	-66.3		0.22	-48.2	-41	6.96
HE40, M0 to M9 1ss	4	14	-72.1	-69.6	-66.5	-67.6	0.22	-48.2	-41	6.98
HE40, M0 to M9 2ss	4	14	-72.1	-69.6	-66.5	-67.6	0.22	-48.2	-41	6.98
HE40, M0 to M9 3ss	4	14	-72.1	-69.6	-66.5	-67.6	0.22	-48.2	-41	6.98
HE40, M0 to M9 4ss	4	14	-72.1	-69.6	-66.5	-67.6	0.22	-48.2	-41	6.98
HE40 Beam Forming, M0 to M9 1ss	2	14	-71.8	-65.7			0.22	-50.5	-41	9.27
HE40 Beam Forming, M0 to M9 2ss	2	14	-71.8	-65.7			0.22	-50.5	-41	9.27

HE40 Beam Forming, M0 to M9 1ss	3	17	-72.1	-72.2	-71.1		0.22	-49.8	-41	8.53
HE40 Beam Forming, M0 to M9 2ss	3	14	-72.1	-65.6	-66.3		0.22	-48.2	-41	6.96
HE40 Beam Forming, M0 to M9 3ss	3	14	-72.1	-65.6	-66.3		0.22	-48.2	-41	6.96
HE40 Beam Forming, M0 to M9 1ss	4	17	-75.1	-75.0	-71.7	-72.0	0.22	-49.9	-41	8.67
HE40 Beam Forming, M0 to M9 2ss	4	14	-72.1	-69.6	-66.5	-67.6	0.22	-48.2	-41	6.98
HE40 Beam Forming, M0 to M9 3ss	4	14	-72.1	-69.6	-66.5	-67.6	0.22	-48.2	-41	6.98
HE40 Beam Forming, M0 to M9 4ss	4	14	-72.1	-69.6	-66.5	-67.6	0.22	-48.2	-41	6.98
HE40 STBC, M0 to M9 2ss	2	14	-71.8	-65.7			0.22	-50.5	-41	9.27
HE40 STBC, M0 to M9 2ss	3	14	-72.1	-65.6	-66.3		0.22	-48.2	-41	6.96
HE40 STBC, M0 to M9 2ss	4	14	-72.1	-69.6	-66.5	-67.6	0.22	-48.2	-41	6.98

Frequency 5240 MHz

Mode	Tx Paths	Correlated Antenna Gain (dBi)	Tx 1 Spur Power (dBm)	Tx 2 Spur Power (dBm)	Tx 3 Spur Power (dBm)	Tx 4 Spur Power (dBm)	Duty Cycle (dB)	Total Conducted Spur (dBm)	Limit (dB)	Margin (dB)
Non HT20, 6 to 54 Mbps	1	14	-63.3				0.26	-49.0	-41	7.79
Non HT20, 6 to 54 Mbps	2	14	-67.8	-65.9			0.26	-49.5	-41	8.23
Non HT20, 6 to 54 Mbps	3	14	-72.0	-66.0	-66.8		0.26	-48.6	-41	7.31
Non HT20, 6 to 54 Mbps	4	14	-72.2	-69.7	-66.7	-67.6	0.26	-48.3	-41	7.05
Non HT20 Beam Forming, 6 to 54 Mbps	2	14	-67.8	-65.9			0.26	-49.5	-41	8.23
Non HT20 Beam Forming, 6 to 54 Mbps	3	17	-72.4	-69.8	-66.6		0.26	-46.9	-41	5.68
Non HT20 Beam Forming, 6 to 54 Mbps	4	17	-72.4	-72.2	-67.6	-72.0	0.26	-47.2	-41	6.0
HT/VHT20, M0 to M7	1	14	-63.3				0.3	-49.0	-41	7.75
HT/VHT20, M0 to M7	2	14	-68.1	-66.0			0.3	-49.6	-41	8.36
HT/VHT20, M8 to M15	2	14	-68.1	-66.0			0.3	-49.6	-41	8.36
HT/VHT20, M0 to M7	3	14	-72.2	-70.0	-66.8		0.3	-50.0	-41	8.77
HT/VHT20, M8 to M15	3	14	-72.2	-70.0	-66.8		0.3	-50.0	-41	8.77
HT/VHT20, M16 to M23	3	14	-72.2	-70.0	-66.8		0.3	-50.0	-41	8.77
HT/VHT20, M0 to M7	4	14	-72.5	-70.0	-67.0	-68.0	0.3	-48.6	-41	7.34
HT/VHT20, M8 to M15	4	14	-72.5	-70.0	-67.0	-68.0	0.3	-48.6	-41	7.34
HT/VHT20, M16 to M23	4	14	-72.5	-70.0	-67.0	-68.0	0.3	-48.6	-41	7.34
HT/VHT20, M24 to M31	4	14	-72.5	-70.0	-67.0	-68.0	0.3	-48.6	-41	7.34
HT/VHT20 Beam Forming, M0 to M7	2	14	-68.1	-66.0			0.3	-49.6	-41	8.36
HT/VHT20 Beam Forming, M8 to M15	2	14	-68.1	-66.0			0.3	-49.6	-41	8.36
HT/VHT20 Beam Forming, M0 to M7	3	17	-72.3	-69.9	-67.0		0.3	-47.1	-41	5.88
HT/VHT20 Beam Forming, M8 to M15	3	14	-72.2	-70.0	-66.8		0.3	-50.0	-41	8.77
HT/VHT20 Beam Forming, M16 to M23	3	14	-72.2	-70.0	-66.8		0.3	-50.0	-41	8.77
HT/VHT20 Beam Forming, M0 to M7	4	17	-72.4	-72.4	-67.8	-72.2	0.3	-47.4	-41	6.12
HT/VHT20 Beam Forming, M8 to M15	4	14	-72.5	-70.0	-67.0	-68.0	0.3	-48.6	-41	7.34
HT/VHT20 Beam Forming, M16 to M23	4	14	-72.5	-70.0	-67.0	-68.0	0.3	-48.6	-41	7.34

HT/VHT20 Beam Forming, M24 to M31	4	14	-72.5	-70.0	-67.0	-68.0	0.3	-48.6	-41	7.34
HT/VHT20 STBC, M0 to M7	2	14	-68.1	-66.0			0.3	-49.6	-41	8.36
HT/VHT20 STBC, M0 to M7	3	14	-72.2	-70.0	-66.8		0.3	-50.0	-41	8.77
HT/VHT20 STBC, M0 to M7	4	14	-72.5	-70.0	-67.0	-68.0	0.3	-48.6	-41	7.34
HE20, M0 to M9 1ss	1	14	-63.2				0.22	-49.0	-41	7.73
HE20, M0 to M9 1ss	2	14	-67.7	-65.8			0.22	-49.4	-41	8.17
HE20, M0 to M9 2ss	2	14	-67.7	-65.8			0.22	-49.4	-41	8.17
HE20, M0 to M9 1ss	3	14	-67.7	-65.8	-66.6		0.22	-47.6	-41	6.39
HE20, M0 to M9 2ss	3	14	-67.7	-65.8	-66.6		0.22	-47.6	-41	6.39
HE20, M0 to M9 3ss	3	14	-67.7	-65.8	-66.6		0.22	-47.6	-41	6.39
HE20, M0 to M9 1ss	4	14	-72.5	-69.9	-66.9	-67.9	0.22	-48.6	-41	7.33
HE20, M0 to M9 2ss	4	14	-72.5	-69.9	-66.9	-67.9	0.22	-48.6	-41	7.33
HE20, M0 to M9 3ss	4	14	-72.5	-69.9	-66.9	-67.9	0.22	-48.6	-41	7.33
HE20, M0 to M9 4ss	4	14	-72.5	-69.9	-66.9	-67.9	0.22	-48.6	-41	7.33
HE20 Beam Forming, M0 to M9 1ss	2	14	-67.7	-65.8			0.22	-49.4	-41	8.17
HE20 Beam Forming, M0 to M9 2ss	2	14	-67.7	-65.8			0.22	-49.4	-41	8.17
HE20 Beam Forming, M0 to M9 1ss	3	17	-72.3	-69.9	-66.9		0.22	-47.2	-41	5.9
HE20 Beam Forming, M0 to M9 2ss	3	14	-67.7	-65.8	-66.6		0.22	-47.6	-41	6.39
HE20 Beam Forming, M0 to M9 3ss	3	14	-67.7	-65.8	-66.6		0.22	-47.6	-41	6.39
HE20 Beam Forming, M0 to M9 1ss	4	17	-72.3	-69.8	-67.6	-69.0	0.22	-46.1	-41	4.87
HE20 Beam Forming, M0 to M9 2ss	4	14	-72.5	-69.9	-66.9	-67.9	0.22	-48.6	-41	7.33
HE20 Beam Forming, M0 to M9 3ss	4	14	-72.5	-69.9	-66.9	-67.9	0.22	-48.6	-41	7.33
HE20 Beam Forming, M0 to M9 4ss	4	14	-72.5	-69.9	-66.9	-67.9	0.22	-48.6	-41	7.33
HE20 STBC, M0 to M9 2ss	2	14	-67.7	-65.8			0.22	-49.4	-41	8.17
HE20 STBC, M0 to M9 2ss	3	14	-67.7	-65.8	-66.6		0.22	-47.6	-41	6.39
HE20 STBC, M0 to M9 2ss	4	14	-72.5	-69.9	-66.9	-67.9	0.22	-48.6	-41	7.33

Data Screenshots

5240 MHz: HE20 Beam Forming, M0 to M9 1ss

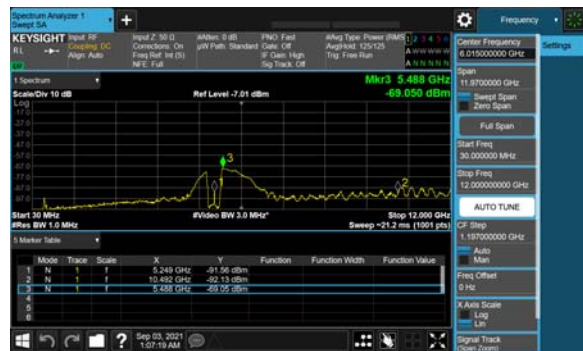
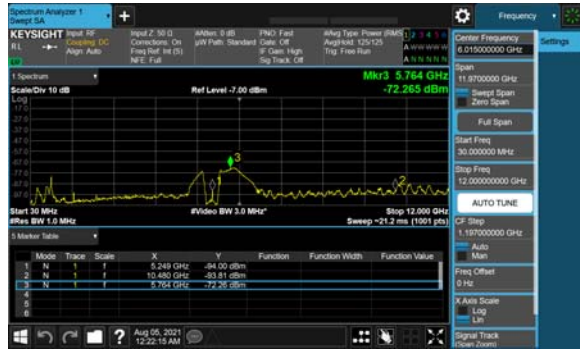

5180 MHz: HT/VHT20 Beam Forming, M0 to M7



Antenna A



Antenna B



Antenna C

5180 MHz: Non HT20 Beam Forming, 6 to 54 Mbps



Antenna A



Antenna B



Antenna C

Conducted Spurs Peak**Frequency 5180 MHz**

Mode	Tx Paths	Correlated Antenna Gain (dBi)	Tx 1 Spur Power (dBm)	Tx 2 Spur Power (dBm)	Tx 3 Spur Power (dBm)	Tx 4 Spur Power (dBm)	Duty Cycle (dB)	Total Conducted Spur (dBm)	Limit (dB)	Margin (dB)
Non HT20, 6 to 54 Mbps	1	14	-56.6				0.26	-42.3	-27	15.34
Non HT20, 6 to 54 Mbps	2	14	-63.7	-59.2			0.26	-43.6	-27	16.63
Non HT20, 6 to 54 Mbps	3	14	-63.3	-58.6	-59.9		0.26	-41.2	-27	14.16
Non HT20, 6 to 54 Mbps	4	14	-63.4	-60.3	-59.3	-59.6	0.26	-40.1	-27	13.11
Non HT20 Beam Forming, 6 to 54 Mbps	2	14	-63.7	-59.2			0.26	-43.6	-27	16.63
Non HT20 Beam Forming, 6 to 54 Mbps	3	17	-63.8	-61.2	-59.3		0.26	-39.0	-27	12.03
Non HT20 Beam Forming, 6 to 54 Mbps	4	17	-64.3	-63.9	-63.4	-63.3	0.26	-40.4	-27	13.43
HT/VHT20, M0 to M7	1	14	-55.9				0.3	-41.6	-27	14.6
HT/VHT20, M0 to M7	2	14	-64.5	-58.1			0.3	-42.9	-27	15.9
HT/VHT20, M8 to M15	2	14	-64.5	-58.1			0.3	-42.9	-27	15.9
HT/VHT20, M0 to M7	3	14	-64.5	-58.1	-59.4		0.3	-40.9	-27	13.85
HT/VHT20, M8 to M15	3	14	-64.5	-58.1	-59.4		0.3	-40.9	-27	13.85
HT/VHT20, M16 to M23	3	14	-64.5	-58.1	-59.4		0.3	-40.9	-27	13.85
HT/VHT20, M0 to M7	4	14	-63.8	-61.0	-59.9	-59.9	0.3	-40.6	-27	13.57
HT/VHT20, M8 to M15	4	14	-63.8	-61.0	-59.9	-59.9	0.3	-40.6	-27	13.57
HT/VHT20, M16 to M23	4	14	-63.8	-61.0	-59.9	-59.9	0.3	-40.6	-27	13.57
HT/VHT20, M24 to M31	4	14	-63.8	-61.0	-59.9	-59.9	0.3	-40.6	-27	13.57
HT/VHT20 Beam Forming, M0 to M7	2	14	-64.5	-58.1			0.3	-42.9	-27	15.9
HT/VHT20 Beam Forming, M8 to M15	2	14	-64.5	-58.1			0.3	-42.9	-27	15.9
HT/VHT20 Beam Forming, M0 to M7	3	17	-63.7	-59.6	-59.1		0.3	-38.3	-27	11.3
HT/VHT20 Beam Forming, M8 to M15	3	14	-64.5	-58.1	-59.4		0.3	-40.9	-27	13.85
HT/VHT20 Beam Forming, M16 to M23	3	14	-64.5	-58.1	-59.4		0.3	-40.9	-27	13.85
HT/VHT20 Beam Forming, M0 to M7	4	17	-63.9	-64.5	-63.6	-63.0	0.3	-40.4	-27	13.39
HT/VHT20 Beam Forming, M8 to M15	4	14	-63.8	-61.0	-59.9	-59.9	0.3	-40.6	-27	13.57
HT/VHT20 Beam Forming, M16 to M23	4	14	-63.8	-61.0	-59.9	-59.9	0.3	-40.6	-27	13.57
HT/VHT20 Beam Forming, M24 to M31	4	14	-63.8	-61.0	-59.9	-59.9	0.3	-40.6	-27	13.57
HT/VHT20 STBC, M0 to M7	2	14	-64.5	-58.1			0.3	-42.9	-27	15.9
HT/VHT20 STBC, M0 to M7	3	14	-64.5	-58.1	-59.4		0.3	-40.9	-27	13.85
HT/VHT20 STBC, M0 to M7	4	14	-63.8	-61.0	-59.9	-59.9	0.3	-40.6	-27	13.57
HE20, M0 to M9 1ss	1	14	-55.3				0.22	-41.1	-27	14.08
HE20, M0 to M9 1ss	2	14	-60.9	-58.1			0.22	-42.1	-27	15.05
HE20, M0 to M9 2ss	2	14	-60.9	-58.1			0.22	-42.1	-27	15.05
HE20, M0 to M9 1ss	3	14	-60.9	-58.1	-59.9		0.22	-40.5	-27	13.49
HE20, M0 to M9 2ss	3	14	-60.9	-58.1	-59.9		0.22	-40.5	-27	13.49

HE20, M0 to M9 3ss	3	14	-60.9	-58.1	-59.9		0.22	-40.5	-27	13.49
HE20, M0 to M9 1ss	4	14	-65.0	-61.6	-59.0	-59.1	0.22	-40.3	-27	13.34
HE20, M0 to M9 2ss	4	14	-65.0	-61.6	-59.0	-59.1	0.22	-40.3	-27	13.34
HE20, M0 to M9 3ss	4	14	-65.0	-61.6	-59.0	-59.1	0.22	-40.3	-27	13.34
HE20, M0 to M9 4ss	4	14	-65.0	-61.6	-59.0	-59.1	0.22	-40.3	-27	13.34
HE20 Beam Forming, M0 to M9 1ss	2	14	-60.9	-58.1			0.22	-42.1	-27	15.05
HE20 Beam Forming, M0 to M9 2ss	2	14	-60.9	-58.1			0.22	-42.1	-27	15.05
HE20 Beam Forming, M0 to M9 1ss	3	17	-64.1	-60.7	-59.6		0.22	-39.1	-27	12.1
HE20 Beam Forming, M0 to M9 2ss	3	14	-60.9	-58.1	-59.9		0.22	-40.5	-27	13.49
HE20 Beam Forming, M0 to M9 3ss	3	14	-60.9	-58.1	-59.9		0.22	-40.5	-27	13.49
HE20 Beam Forming, M0 to M9 1ss	4	17	-63.2	-64.3	-63.5	-62.9	0.22	-40.2	-27	13.21
HE20 Beam Forming, M0 to M9 2ss	4	14	-65.0	-61.6	-59.0	-59.1	0.22	-40.3	-27	13.34
HE20 Beam Forming, M0 to M9 3ss	4	14	-65.0	-61.6	-59.0	-59.1	0.22	-40.3	-27	13.34
HE20 Beam Forming, M0 to M9 4ss	4	14	-65.0	-61.6	-59.0	-59.1	0.22	-40.3	-27	13.34
HE20 STBC, M0 to M9 2ss	2	14	-60.9	-58.1			0.22	-42.1	-27	15.05
HE20 STBC, M0 to M9 2ss	3	14	-60.9	-58.1	-59.9		0.22	-40.5	-27	13.49
HE20 STBC, M0 to M9 2ss	4	14	-65.0	-61.6	-59.0	-59.1	0.22	-40.3	-27	13.34

Frequency 5190 MHz

Mode	Tx Paths	Correlated Antenna Gain (dBi)	Tx 1 Spur Power (dBm)	Tx 2 Spur Power (dBm)	Tx 3 Spur Power (dBm)	Tx 4 Spur Power (dBm)	Duty Cycle (dB)	Total Conducted Spur (dBm)	Limit (dB)	Margin (dB)
Non HT40, 6 to 54 Mbps	1	14	-59.5				0.33	-45.2	-27	18.17
Non HT40, 6 to 54 Mbps	2	14	-63.9	-61.6			0.33	-45.3	-27	18.26
Non HT40, 6 to 54 Mbps	3	14	-63.7	-60.6	-58.8		0.33	-41.5	-27	14.49
Non HT40, 6 to 54 Mbps	4	14	-63.7	-60.6	-58.8	-56.8	0.33	-38.9	-27	11.94
HT/VHT40, M0 to M7	1	14	-59.4				0.33	-45.1	-27	18.07
HT/VHT40, M0 to M7	2	14	-62.8	-59.7			0.85	-43.1	-27	16.12
HT/VHT40, M8 to M15	2	14	-62.8	-59.7			0.85	-43.1	-27	16.12
HT/VHT40, M0 to M7	3	14	-64.1	-59.8	-58.8		0.85	-40.7	-27	13.75
HT/VHT40, M8 to M15	3	14	-64.1	-59.8	-58.8		0.85	-40.7	-27	13.75
HT/VHT40, M16 to M23	3	14	-64.1	-59.8	-58.8		0.85	-40.7	-27	13.75
HT/VHT40, M0 to M7	4	14	-64.3	-60.7	-59.7	-59.0	0.85	-39.6	-27	12.64
HT/VHT40, M8 to M15	4	14	-64.3	-60.7	-59.7	-59.0	0.85	-39.6	-27	12.64
HT/VHT40, M16 to M23	4	14	-64.3	-60.7	-59.7	-59.0	0.85	-39.6	-27	12.64
HT/VHT40, M24 to M31	4	14	-64.3	-60.7	-59.7	-59.0	0.85	-39.6	-27	12.64
HT/VHT40 Beam Forming, M0 to M7	2	14	-62.8	-59.7			0.85	-43.1	-27	16.12
HT/VHT40 Beam Forming, M8 to M15	2	14	-62.8	-59.7			0.85	-43.1	-27	16.12
HT/VHT40 Beam Forming, M0 to M7	3	17	-66.6	-63.7	-62.8		0.85	-41.5	-27	14.47

HT/VHT40 Beam Forming, M8 to M15	3	14	-64.1	-59.8	-58.8		0.85	-40.7	-27	13.75
HT/VHT40 Beam Forming, M16 to M23	3	14	-64.1	-59.8	-58.8		0.85	-40.7	-27	13.75
HT/VHT40 Beam Forming, M0 to M7	4	17	-64.9	-64.0	-63.6	-62.5	0.85	-39.8	-27	12.79
HT/VHT40 Beam Forming, M8 to M15	4	14	-64.3	-60.7	-59.7	-59.0	0.85	-39.6	-27	12.64
HT/VHT40 Beam Forming, M16 to M23	4	14	-64.3	-60.7	-59.7	-59.0	0.85	-39.6	-27	12.64
HT/VHT40 Beam Forming, M24 to M31	4	14	-64.3	-60.7	-59.7	-59.0	0.85	-39.6	-27	12.64
HT/VHT40 STBC, M0 to M7	2	14	-62.8	-59.7			0.85	-43.1	-27	16.12
HT/VHT40 STBC, M0 to M7	3	14	-64.1	-59.8	-58.8		0.85	-40.7	-27	13.75
HT/VHT40 STBC, M0 to M7	4	14	-64.3	-60.7	-59.7	-59.0	0.85	-39.6	-27	12.64
HE40, M0 to M9 1ss	1	14	-60.0				0.22	-45.8	-27	18.78
HE40, M0 to M9 1ss	2	14	-63.9	-60.9			0.22	-44.9	-27	17.91
HE40, M0 to M9 2ss	2	14	-63.9	-60.9			0.22	-44.9	-27	17.91
HE40, M0 to M9 1ss	3	14	-64.0	-60.6	-59.7		0.22	-42.1	-27	15.08
HE40, M0 to M9 2ss	3	14	-64.0	-60.6	-59.7		0.22	-42.1	-27	15.08
HE40, M0 to M9 3ss	3	14	-64.0	-60.6	-59.7		0.22	-42.1	-27	15.08
HE40, M0 to M9 1ss	4	14	-64.4	-60.3	-59.6	-58.9	0.22	-40.1	-27	13.12
HE40, M0 to M9 2ss	4	14	-64.4	-60.3	-59.6	-58.9	0.22	-40.1	-27	13.12
HE40, M0 to M9 3ss	4	14	-64.4	-60.3	-59.6	-58.9	0.22	-40.1	-27	13.12
HE40, M0 to M9 4ss	4	14	-64.4	-60.3	-59.6	-58.9	0.22	-40.1	-27	13.12
HE40 Beam Forming, M0 to M9 1ss	2	14	-63.9	-60.9			0.22	-44.9	-27	17.91
HE40 Beam Forming, M0 to M9 2ss	2	14	-63.9	-60.9			0.22	-44.9	-27	17.91
HE40 Beam Forming, M0 to M9 1ss	3	17	-63.9	-62.0	-61.3		0.22	-40.3	-27	13.27
HE40 Beam Forming, M0 to M9 2ss	3	14	-64.0	-60.6	-59.7		0.22	-42.1	-27	15.08
HE40 Beam Forming, M0 to M9 3ss	3	14	-64.0	-60.6	-59.7		0.22	-42.1	-27	15.08
HE40 Beam Forming, M0 to M9 1ss	4	17	-64.8	-62.7	-63.4	-64.3	0.22	-40.5	-27	13.48
HE40 Beam Forming, M0 to M9 2ss	4	14	-64.4	-60.3	-59.6	-58.9	0.22	-40.1	-27	13.12
HE40 Beam Forming, M0 to M9 3ss	4	14	-64.4	-60.3	-59.6	-58.9	0.22	-40.1	-27	13.12
HE40 Beam Forming, M0 to M9 4ss	4	14	-64.4	-60.3	-59.6	-58.9	0.22	-40.1	-27	13.12
HE40 STBC, M0 to M9 2ss	2	14	-63.9	-60.9			0.22	-44.9	-27	17.91
HE40 STBC, M0 to M9 2ss	3	14	-64.0	-60.6	-59.7		0.22	-42.1	-27	15.08
HE40 STBC, M0 to M9 2ss	4	14	-64.4	-60.3	-59.6	-58.9	0.22	-40.1	-27	13.12

Frequency 5210 MHz

Mode	Tx Paths	Correlated Antenna Gain (dBi)	Tx 1 Spur Power (dBm)	Tx 2 Spur Power (dBm)	Tx 3 Spur Power (dBm)	Tx 4 Spur Power (dBm)	Duty Cycle (dB)	Total Conducted Spur (dBm)	Limit (dB)	Margin (dB)
Non HT80, 6 to 54 Mbps	1	14	-59.3				0.33	-45.0	-27	17.97

Non HT80, 6 to 54 Mbps	2	14	-63.6	-61.0				0.33	-44.8	-27	17.77
Non HT80, 6 to 54 Mbps	3	14	-63.6	-61.0	-59.1			0.33	-41.8	-27	14.76
Non HT80, 6 to 54 Mbps	4	14	-64.0	-61.2	-58.8	-59.2		0.33	-40.0	-27	13.01
VHT80, M0 to M9 1ss	1	14	-55.2					0.33	-40.9	-27	13.87
VHT80, M0 to M9 1ss	2	14	-63.8	-59.1				0.33	-43.5	-27	16.5
VHT80, M0 to M9 2ss	2	14	-63.8	-59.1				0.33	-43.5	-27	16.5
VHT80, M0 to M9 1ss	3	14	-64.2	-60.8	-58.5			0.33	-41.5	-27	14.48
VHT80, M0 to M9 2ss	3	14	-64.2	-60.8	-58.5			0.33	-41.5	-27	14.48
VHT80, M0 to M9 3ss	3	14	-64.2	-60.8	-58.5			0.33	-41.5	-27	14.48
VHT80, M0 to M9 1ss	4	14	-63.9	-60.7	-59.3	-58.8		0.33	-39.9	-27	12.93
VHT80, M0 to M9 2ss	4	14	-63.9	-60.7	-59.3	-58.8		0.33	-39.9	-27	12.93
VHT80, M0 to M9 3ss	4	14	-63.9	-60.7	-59.3	-58.8		0.33	-39.9	-27	12.93
VHT80, M0 to M9 4ss	4	14	-63.9	-60.7	-59.3	-58.8		0.33	-39.9	-27	12.93
VHT80 Beam Forming, M0 to M9 1ss	2	14	-63.8	-59.1				0.33	-43.5	-27	16.5
VHT80 Beam Forming, M0 to M9 2ss	2	14	-63.8	-59.1				0.33	-43.5	-27	16.5
VHT80 Beam Forming, M0 to M9 1ss	3	17	-63.3	-62.8	-60.8			0.33	-40.1	-27	13.06
VHT80 Beam Forming, M0 to M9 2ss	3	14	-64.2	-60.8	-58.5			0.33	-41.5	-27	14.48
VHT80 Beam Forming, M0 to M9 3ss	3	14	-64.2	-60.8	-58.5			0.33	-41.5	-27	14.48
VHT80 Beam Forming, M0 to M9 1ss	4	17	-64.1	-63.7	-63.4	-63.7		0.33	-40.4	-27	13.37
VHT80 Beam Forming, M0 to M9 2ss	4	14	-63.9	-60.7	-59.3	-58.8		0.33	-39.9	-27	12.93
VHT80 Beam Forming, M0 to M9 3ss	4	14	-63.9	-60.7	-59.3	-58.8		0.33	-39.9	-27	12.93
VHT80 Beam Forming, M0 to M9 4ss	4	14	-63.9	-60.7	-59.3	-58.8		0.33	-39.9	-27	12.93
VHT80 STBC, M0 to M9 1ss	2	14	-63.8	-59.1				0.33	-43.5	-27	16.5
VHT80 STBC, M0 to M9 1ss	3	14	-64.2	-60.8	-58.5			0.33	-41.5	-27	14.48
VHT80 STBC, M0 to M9 1ss	4	14	-63.9	-60.7	-59.3	-58.8		0.33	-39.9	-27	12.93
HE80, M0 to M9 1ss	1	14	-59.9					0.26	-45.6	-27	18.64
HE80, M0 to M9 1ss	2	14	-64.0	-62.0				0.26	-45.6	-27	18.61
HE80, M0 to M9 2ss	2	14	-64.0	-62.0				0.26	-45.6	-27	18.61
HE80, M0 to M9 1ss	3	14	-63.6	-61.7	-59.3			0.26	-42.1	-27	15.14
HE80, M0 to M9 2ss	3	14	-63.6	-61.7	-59.3			0.26	-42.1	-27	15.14
HE80, M0 to M9 3ss	3	14	-63.6	-61.7	-59.3			0.26	-42.1	-27	15.14
HE80, M0 to M9 1ss	4	14	-64.1	-60.5	-59.1	-59.0		0.26	-40.0	-27	12.97
HE80, M0 to M9 2ss	4	14	-64.1	-60.5	-59.1	-59.0		0.26	-40.0	-27	12.97
HE80, M0 to M9 3ss	4	14	-64.1	-60.5	-59.1	-59.0		0.26	-40.0	-27	12.97
HE80, M0 to M9 4ss	4	14	-64.1	-60.5	-59.1	-59.0		0.26	-40.0	-27	12.97
HE80 Beam Forming, M0 to M9 1ss	2	14	-64.0	-62.0				0.26	-45.6	-27	18.61
HE80 Beam Forming, M0 to M9 2ss	2	14	-64.0	-62.0				0.26	-45.6	-27	18.61
HE80 Beam Forming, M0 to M9 1ss	3	17	-64.1	-61.8	-61.0			0.26	-40.1	-27	13.08
HE80 Beam Forming, M0 to M9 2ss	3	14	-63.6	-61.7	-59.3			0.26	-42.1	-27	15.14
HE80 Beam Forming, M0 to M9 3ss	3	14	-63.6	-61.7	-59.3			0.26	-42.1	-27	15.14
HE80 Beam Forming, M0 to M9 1ss	4	17	-64.4	-62.4	-63.7	-63.5		0.26	-40.2	-27	13.16
HE80 Beam Forming, M0 to M9 2ss	4	14	-64.1	-60.5	-59.1	-59.0		0.26	-40.0	-27	12.97

HE80 Beam Forming, M0 to M9 3ss	4	14	-64.1	-60.5	-59.1	-59.0	0.26	-40.0	-27	12.97
HE80 Beam Forming, M0 to M9 4ss	4	14	-64.1	-60.5	-59.1	-59.0	0.26	-40.0	-27	12.97
HE80 STBC, M0 to M9 1ss	2	14	-64.0	-62.0			0.26	-45.6	-27	18.61
HE80 STBC, M0 to M9 1ss	3	14	-63.6	-61.7	-59.3		0.26	-42.1	-27	15.14
HE80 STBC, M0 to M9 1ss	4	14	-64.1	-60.5	-59.1	-59.0	0.26	-40.0	-27	12.97

Frequency 5220 MHz

Mode	Tx Paths	Correlated Antenna Gain (dBi)	Tx 1 Spur Power (dBm)	Tx 2 Spur Power (dBm)	Tx 3 Spur Power (dBm)	Tx 4 Spur Power (dBm)	Duty Cycle (dB)	Total Conducted Spur (dBm)	Limit (dB)	Margin (dB)
Non HT20, 6 to 54 Mbps	1	14	-56.5				0.26	-42.2	-27	15.24
Non HT20, 6 to 54 Mbps	2	14	-63.5	-58.0			0.26	-42.7	-27	15.67
Non HT20, 6 to 54 Mbps	3	14	-64.8	-62.0	-58.4		0.26	-41.9	-27	14.93
Non HT20, 6 to 54 Mbps	4	14	-64.5	-61.4	-59.6	-59.8	0.26	-40.7	-27	13.66
Non HT20 Beam Forming, 6 to 54 Mbps	2	14	-63.5	-58.0			0.26	-42.7	-27	15.67
Non HT20 Beam Forming, 6 to 54 Mbps	3	17	-64.7	-59.8	-59.3		0.26	-38.7	-27	11.66
Non HT20 Beam Forming, 6 to 54 Mbps	4	17	-64.4	-64.3	-64.0	-62.8	0.26	-40.5	-27	13.55
HT/VHT20, M0 to M7	1	14	-56.1				0.3	-41.8	-27	14.8
HT/VHT20, M0 to M7	2	14	-64.8	-57.5			0.3	-42.5	-27	15.46
HT/VHT20, M8 to M15	2	14	-64.8	-57.5			0.3	-42.5	-27	15.46
HT/VHT20, M0 to M7	3	14	-64.8	-57.5	-59.2		0.3	-40.5	-27	13.5
HT/VHT20, M8 to M15	3	14	-64.8	-57.5	-59.2		0.3	-40.5	-27	13.5
HT/VHT20, M16 to M23	3	14	-64.8	-57.5	-59.2		0.3	-40.5	-27	13.5
HT/VHT20, M0 to M7	4	14	-64.5	-60.2	-60.4	-60.4	0.3	-40.7	-27	13.74
HT/VHT20, M8 to M15	4	14	-64.5	-60.2	-60.4	-60.4	0.3	-40.7	-27	13.74
HT/VHT20, M16 to M23	4	14	-64.5	-60.2	-60.4	-60.4	0.3	-40.7	-27	13.74
HT/VHT20, M24 to M31	4	14	-64.5	-60.2	-60.4	-60.4	0.3	-40.7	-27	13.74
HT/VHT20 Beam Forming, M0 to M7	2	14	-64.8	-57.5			0.3	-42.5	-27	15.46
HT/VHT20 Beam Forming, M8 to M15	2	14	-64.8	-57.5			0.3	-42.5	-27	15.46
HT/VHT20 Beam Forming, M0 to M7	3	17	-64.1	-60.7	-60.0		0.3	-39.2	-27	12.19
HT/VHT20 Beam Forming, M8 to M15	3	14	-64.8	-57.5	-59.2		0.3	-40.5	-27	13.5
HT/VHT20 Beam Forming, M16 to M23	3	14	-64.8	-57.5	-59.2		0.3	-40.5	-27	13.5
HT/VHT20 Beam Forming, M0 to M7	4	17	-63.2	-63.4	-64.0	-64.2	0.3	-40.4	-27	13.36
HT/VHT20 Beam Forming, M8 to M15	4	14	-64.5	-60.2	-60.4	-60.4	0.3	-40.7	-27	13.74
HT/VHT20 Beam Forming, M16 to M23	4	14	-64.5	-60.2	-60.4	-60.4	0.3	-40.7	-27	13.74
HT/VHT20 Beam Forming, M24 to M31	4	14	-64.5	-60.2	-60.4	-60.4	0.3	-40.7	-27	13.74
HT/VHT20 STBC, M0 to M7	2	14	-64.8	-57.5			0.3	-42.5	-27	15.46
HT/VHT20 STBC, M0 to M7	3	14	-64.8	-57.5	-59.2		0.3	-40.5	-27	13.5

HT/VHT20 STBC, M0 to M7	4	14	-64.5	-60.2	-60.4	-60.4	0.3	-40.7	-27	13.74
HE20, M0 to M9 1ss	1	14	-55.7				0.22	-41.5	-27	14.48
HE20, M0 to M9 1ss	2	14	-60.6	-57.6			0.22	-41.6	-27	14.62
HE20, M0 to M9 2ss	2	14	-60.6	-57.6			0.22	-41.6	-27	14.62
HE20, M0 to M9 1ss	3	14	-63.0	-60.9	-59.9		0.22	-42.1	-27	15.1
HE20, M0 to M9 2ss	3	14	-63.0	-60.9	-59.9		0.22	-42.1	-27	15.1
HE20, M0 to M9 3ss	3	14	-63.0	-60.9	-59.9		0.22	-42.1	-27	15.1
HE20, M0 to M9 1ss	4	14	-65.0	-60.6	-59.7	-59.7	0.22	-40.6	-27	13.56
HE20, M0 to M9 2ss	4	14	-65.0	-60.6	-59.7	-59.7	0.22	-40.6	-27	13.56
HE20, M0 to M9 3ss	4	14	-65.0	-60.6	-59.7	-59.7	0.22	-40.6	-27	13.56
HE20, M0 to M9 4ss	4	14	-65.0	-60.6	-59.7	-59.7	0.22	-40.6	-27	13.56
HE20 Beam Forming, M0 to M9 1ss	2	14	-60.6	-57.6			0.22	-41.6	-27	14.62
HE20 Beam Forming, M0 to M9 2ss	2	14	-60.6	-57.6			0.22	-41.6	-27	14.62
HE20 Beam Forming, M0 to M9 1ss	3	17	-64.1	-61.1	-61.6		0.22	-40.1	-27	13.09
HE20 Beam Forming, M0 to M9 2ss	3	14	-63.0	-60.9	-59.9		0.22	-42.1	-27	15.1
HE20 Beam Forming, M0 to M9 3ss	3	14	-63.0	-60.9	-59.9		0.22	-42.1	-27	15.1
HE20 Beam Forming, M0 to M9 1ss	4	17	-64.3	-64.2	-63.6	-62.1	0.22	-40.2	-27	13.22
HE20 Beam Forming, M0 to M9 2ss	4	14	-65.0	-60.6	-59.7	-59.7	0.22	-40.6	-27	13.56
HE20 Beam Forming, M0 to M9 3ss	4	14	-65.0	-60.6	-59.7	-59.7	0.22	-40.6	-27	13.56
HE20 Beam Forming, M0 to M9 4ss	4	14	-65.0	-60.6	-59.7	-59.7	0.22	-40.6	-27	13.56
HE20 STBC, M0 to M9 2ss	2	14	-60.6	-57.6			0.22	-41.6	-27	14.62
HE20 STBC, M0 to M9 2ss	3	14	-63.0	-60.9	-59.9		0.22	-42.1	-27	15.1
HE20 STBC, M0 to M9 2ss	4	14	-65.0	-60.6	-59.7	-59.7	0.22	-40.6	-27	13.56

Frequency 5230 MHz

Mode	Tx Paths	Correlated Antenna Gain (dBi)	Tx 1 Spur Power (dBm)	Tx 2 Spur Power (dBm)	Tx 3 Spur Power (dBm)	Tx 4 Spur Power (dBm)	Duty Cycle (dB)	Total Conducted Spur (dBm)	Limit (dB)	Margin (dB)
Non HT40, 6 to 54 Mbps	1	14	-56.3				0.33	-42.0	-27	14.97
Non HT40, 6 to 54 Mbps	2	14	-63.9	-58.7			0.33	-43.2	-27	16.22
Non HT40, 6 to 54 Mbps	3	14	-64.1	-62.1	-58.9		0.33	-42.1	-27	15.06
Non HT40, 6 to 54 Mbps	4	14	-64.2	-61.5	-59.0	-59.3	0.33	-40.2	-27	13.2
HT/VHT40, M0 to M7	1	14	-56.0				0.85	-41.1	-27	14.15
HT/VHT40, M0 to M7	2	14	-64.3	-57.7			0.85	-42.0	-27	14.99
HT/VHT40, M8 to M15	2	14	-64.3	-57.7			0.85	-42.0	-27	14.99
HT/VHT40, M0 to M7	3	14	-64.7	-61.4	-59.2		0.85	-41.6	-27	14.6
HT/VHT40, M8 to M15	3	14	-64.7	-61.4	-59.2		0.85	-41.6	-27	14.6
HT/VHT40, M16 to M23	3	14	-64.7	-61.4	-59.2		0.85	-41.6	-27	14.6
HT/VHT40, M0 to M7	4	14	-64.1	-62.3	-58.8	-59.6	0.85	-39.8	-27	12.84
HT/VHT40, M8 to M15	4	14	-64.1	-62.3	-58.8	-59.6	0.85	-39.8	-27	12.84
HT/VHT40, M16 to M23	4	14	-64.1	-62.3	-58.8	-59.6	0.85	-39.8	-27	12.84
HT/VHT40, M24 to M31	4	14	-64.1	-62.3	-58.8	-59.6	0.85	-39.8	-27	12.84
HT/VHT40 Beam Forming, M0 to M7	2	14	-64.3	-57.7			0.85	-42.0	-27	14.99
HT/VHT40 Beam Forming, M8 to M15	2	14	-64.3	-57.7			0.85	-42.0	-27	14.99
HT/VHT40 Beam Forming, M0 to M7	3	17	-66.5	-63.7	-63.0		0.85	-41.5	-27	14.54
HT/VHT40 Beam Forming, M8 to M15	3	14	-64.7	-61.4	-59.2		0.85	-41.6	-27	14.6
HT/VHT40 Beam Forming, M16 to M23	3	14	-64.7	-61.4	-59.2		0.85	-41.6	-27	14.6
HT/VHT40 Beam Forming, M0 to M7	4	17	-63.5	-63.2	-64.0	-63.5	0.85	-39.7	-27	12.67
HT/VHT40 Beam Forming, M8 to M15	4	14	-64.1	-62.3	-58.8	-59.6	0.85	-39.8	-27	12.84
HT/VHT40 Beam Forming, M16 to M23	4	14	-64.1	-62.3	-58.8	-59.6	0.85	-39.8	-27	12.84
HT/VHT40 Beam Forming, M24 to M31	4	14	-64.1	-62.3	-58.8	-59.6	0.85	-39.8	-27	12.84
HT/VHT40 STBC, M0 to M7	2	14	-64.3	-57.7			0.85	-42.0	-27	14.99
HT/VHT40 STBC, M0 to M7	3	14	-64.7	-61.4	-59.2		0.85	-41.6	-27	14.6
HT/VHT40 STBC, M0 to M7	4	14	-64.1	-62.3	-58.8	-59.6	0.85	-39.8	-27	12.84
HE40, M0 to M9 1ss	1	14	-56.2				0.22	-42.0	-27	14.98
HE40, M0 to M9 1ss	2	14	-62.9	-57.6			0.22	-42.3	-27	15.25
HE40, M0 to M9 2ss	2	14	-62.9	-57.6			0.22	-42.3	-27	15.25
HE40, M0 to M9 1ss	3	14	-64.3	-58.4	-59.2		0.22	-41.0	-27	13.98
HE40, M0 to M9 2ss	3	14	-64.3	-58.4	-59.2		0.22	-41.0	-27	13.98
HE40, M0 to M9 3ss	3	14	-64.3	-58.4	-59.2		0.22	-41.0	-27	13.98
HE40, M0 to M9 1ss	4	14	-64.5	-60.9	-59.5	-59.3	0.22	-40.4	-27	13.38
HE40, M0 to M9 2ss	4	14	-64.5	-60.9	-59.5	-59.3	0.22	-40.4	-27	13.38
HE40, M0 to M9 3ss	4	14	-64.5	-60.9	-59.5	-59.3	0.22	-40.4	-27	13.38
HE40, M0 to M9 4ss	4	14	-64.5	-60.9	-59.5	-59.3	0.22	-40.4	-27	13.38
HE40 Beam Forming, M0 to M9 1ss	2	14	-62.9	-57.6			0.22	-42.3	-27	15.25

HE40 Beam Forming, M0 to M9 2ss	2	14	-62.9	-57.6			0.22	-42.3	-27	15.25
HE40 Beam Forming, M0 to M9 1ss	3	17	-65.2	-63.7	-62.7		0.22	-41.8	-27	14.75
HE40 Beam Forming, M0 to M9 2ss	3	14	-64.3	-58.4	-59.2		0.22	-41.0	-27	13.98
HE40 Beam Forming, M0 to M9 3ss	3	14	-64.3	-58.4	-59.2		0.22	-41.0	-27	13.98
HE40 Beam Forming, M0 to M9 1ss	4	17	-63.7	-63.7	-63.5	-61.9	0.22	-39.9	-27	12.89
HE40 Beam Forming, M0 to M9 2ss	4	14	-64.5	-60.9	-59.5	-59.3	0.22	-40.4	-27	13.38
HE40 Beam Forming, M0 to M9 3ss	4	14	-64.5	-60.9	-59.5	-59.3	0.22	-40.4	-27	13.38
HE40 Beam Forming, M0 to M9 4ss	4	14	-64.5	-60.9	-59.5	-59.3	0.22	-40.4	-27	13.38
HE40 STBC, M0 to M9 2ss	2	14	-62.9	-57.6			0.22	-42.3	-27	15.25
HE40 STBC, M0 to M9 2ss	3	14	-64.3	-58.4	-59.2		0.22	-41.0	-27	13.98
HE40 STBC, M0 to M9 2ss	4	14	-64.5	-60.9	-59.5	-59.3	0.22	-40.4	-27	13.38

Frequency 5240 MHz

Mode	Tx Paths	Correlated Antenna Gain (dBi)	Tx 1 Spur Power (dBm)	Tx 2 Spur Power (dBm)	Tx 3 Spur Power (dBm)	Tx 4 Spur Power (dBm)	Duty Cycle (dB)	Total Conducted Spur (dBm)	Limit (dB)	Margin (dB)
Non HT20, 6 to 54 Mbps	1	14	-56.8				0.26	-42.5	-27	15.54
Non HT20, 6 to 54 Mbps	2	14	-60.4	-57.7			0.26	-41.6	-27	14.58
Non HT20, 6 to 54 Mbps	3	14	-65.0	-58.1	-59.6		0.26	-41.0	-27	14.03
Non HT20, 6 to 54 Mbps	4	14	-63.8	-62.7	-58.9	-60.0	0.26	-40.6	-27	13.64
Non HT20 Beam Forming, 6 to 54 Mbps	2	14	-60.4	-57.7			0.26	-41.6	-27	14.58
Non HT20 Beam Forming, 6 to 54 Mbps	3	17	-63.9	-62.1	-60.1		0.26	-39.7	-27	12.73
Non HT20 Beam Forming, 6 to 54 Mbps	4	17	-64.2	-63.7	-60.1	-62.5	0.26	-39.0	-27	12.04
HT/VHT20, M0 to M7	1	14	-55.9				0.3	-41.6	-27	14.6
HT/VHT20, M0 to M7	2	14	-60.7	-57.6			0.3	-41.6	-27	14.57
HT/VHT20, M8 to M15	2	14	-60.7	-57.6			0.3	-41.6	-27	14.57
HT/VHT20, M0 to M7	3	14	-64.0	-62.0	-59.0		0.3	-42.1	-27	15.1
HT/VHT20, M8 to M15	3	14	-64.0	-62.0	-59.0		0.3	-42.1	-27	15.1
HT/VHT20, M16 to M23	3	14	-64.0	-62.0	-59.0		0.3	-42.1	-27	15.1
HT/VHT20, M0 to M7	4	14	-64.8	-61.6	-59.1	-59.9	0.3	-40.5	-27	13.54
HT/VHT20, M8 to M15	4	14	-64.8	-61.6	-59.1	-59.9	0.3	-40.5	-27	13.54
HT/VHT20, M16 to M23	4	14	-64.8	-61.6	-59.1	-59.9	0.3	-40.5	-27	13.54
HT/VHT20, M24 to M31	4	14	-64.8	-61.6	-59.1	-59.9	0.3	-40.5	-27	13.54
HT/VHT20 Beam Forming, M0 to M7	2	14	-60.7	-57.6			0.3	-41.6	-27	14.57
HT/VHT20 Beam Forming, M8 to M15	2	14	-60.7	-57.6			0.3	-41.6	-27	14.57
HT/VHT20 Beam Forming, M0 to M7	3	17	-63.5	-62.4	-60.1		0.3	-39.7	-27	12.69
HT/VHT20 Beam Forming, M8 to M15	3	14	-64.0	-62.0	-59.0		0.3	-42.1	-27	15.1

HT/VHT20 Beam Forming, M16 to M23	3	14	-64.0	-62.0	-59.0		0.3	-42.1	-27	15.1
HT/VHT20 Beam Forming, M0 to M7	4	17	-65.2	-63.9	-59.9	-63.1	0.3	-39.2	-27	12.23
HT/VHT20 Beam Forming, M8 to M15	4	14	-64.8	-61.6	-59.1	-59.9	0.3	-40.5	-27	13.54
HT/VHT20 Beam Forming, M16 to M23	4	14	-64.8	-61.6	-59.1	-59.9	0.3	-40.5	-27	13.54
HT/VHT20 Beam Forming, M24 to M31	4	14	-64.8	-61.6	-59.1	-59.9	0.3	-40.5	-27	13.54
HT/VHT20 STBC, M0 to M7	2	14	-60.7	-57.6			0.3	-41.6	-27	14.57
HT/VHT20 STBC, M0 to M7	3	14	-64.0	-62.0	-59.0		0.3	-42.1	-27	15.1
HT/VHT20 STBC, M0 to M7	4	14	-64.8	-61.6	-59.1	-59.9	0.3	-40.5	-27	13.54
HE20, M0 to M9 1ss	1	14	-56.1				0.22	-41.9	-27	14.88
HE20, M0 to M9 1ss	2	14	-59.8	-58.4			0.22	-41.8	-27	14.82
HE20, M0 to M9 2ss	2	14	-59.8	-58.4			0.22	-41.8	-27	14.82
HE20, M0 to M9 1ss	3	14	-59.8	-58.4	-59.1		0.22	-40.1	-27	13.07
HE20, M0 to M9 2ss	3	14	-59.8	-58.4	-59.1		0.22	-40.1	-27	13.07
HE20, M0 to M9 3ss	3	14	-59.8	-58.4	-59.1		0.22	-40.1	-27	13.07
HE20, M0 to M9 1ss	4	14	-64.9	-60.6	-59.9	-60.0	0.22	-40.7	-27	13.71
HE20, M0 to M9 2ss	4	14	-64.9	-60.6	-59.9	-60.0	0.22	-40.7	-27	13.71
HE20, M0 to M9 3ss	4	14	-64.9	-60.6	-59.9	-60.0	0.22	-40.7	-27	13.71
HE20, M0 to M9 4ss	4	14	-64.9	-60.6	-59.9	-60.0	0.22	-40.7	-27	13.71
HE20 Beam Forming, M0 to M9 1ss	2	14	-59.8	-58.4			0.22	-41.8	-27	14.82
HE20 Beam Forming, M0 to M9 2ss	2	14	-59.8	-58.4			0.22	-41.8	-27	14.82
HE20 Beam Forming, M0 to M9 1ss	3	17	-65.2	-62.0	-59.6		0.22	-39.7	-27	12.71
HE20 Beam Forming, M0 to M9 2ss	3	14	-59.8	-58.4	-59.1		0.22	-40.1	-27	13.07
HE20 Beam Forming, M0 to M9 3ss	3	14	-59.8	-58.4	-59.1		0.22	-40.1	-27	13.07
HE20 Beam Forming, M0 to M9 1ss	4	17	-64.0	-62.5	-60.0	-61.3	0.22	-38.5	-27	11.47
HE20 Beam Forming, M0 to M9 2ss	4	14	-64.9	-60.6	-59.9	-60.0	0.22	-40.7	-27	13.71
HE20 Beam Forming, M0 to M9 3ss	4	14	-64.9	-60.6	-59.9	-60.0	0.22	-40.7	-27	13.71
HE20 Beam Forming, M0 to M9 4ss	4	14	-64.9	-60.6	-59.9	-60.0	0.22	-40.7	-27	13.71
HE20 STBC, M0 to M9 2ss	2	14	-59.8	-58.4			0.22	-41.8	-27	14.82
HE20 STBC, M0 to M9 2ss	3	14	-59.8	-58.4	-59.1		0.22	-40.1	-27	13.07
HE20 STBC, M0 to M9 2ss	4	14	-64.9	-60.6	-59.9	-60.0	0.22	-40.7	-27	13.71

Data Screenshots

5180 MHz: HT/VHT20 Beam Forming, M0 to M7



Antenna A

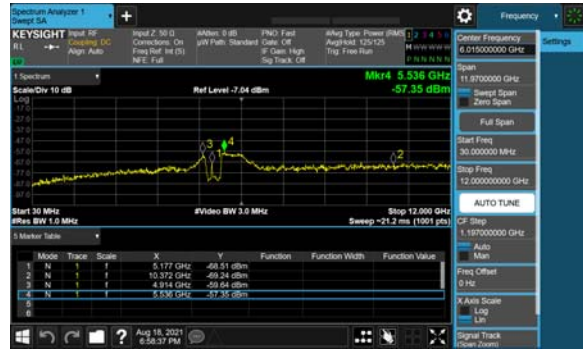

Antenna B

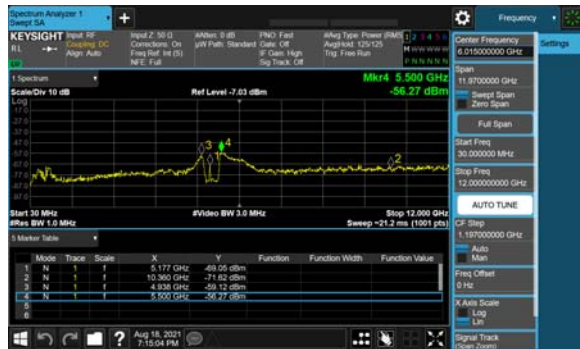

Antenna C

5240 MHz: HE20 Beam Forming, M0 to M9 1ss



Antenna A



Antenna B



Antenna C



Antenna D

5220 MHz: Non HT20 Beam Forming, 6 to 54 Mbps



A.6: Conducted Band Edge

Conducted Band Edge Test Requirement

15.407(b)

Undesirable emission limits. Except as shown in paragraph (b)(7) of this section, the maximum emissions outside of the frequency bands of operation shall be attenuated in accordance with the following limits:

- (1) For transmitters operating in the 5.15-5.25 GHz band: All emissions outside of the 5.15-5.35 GHz band shall not exceed an e.i.r.p. of -27 dBm/MHz.
- (5) The emission measurements shall be performed using a minimum resolution bandwidth of 1 MHz. A lower resolution bandwidth may be employed near the band edge, when necessary, provided the measured energy is integrated to show the total power over 1 MHz.
- (6) Unwanted emissions below 1 GHz must comply with the general field strength limits set forth in §15.209.
- (7) The provisions of §15.205 apply to intentional radiators operating under this section.
- (8) When measuring the emission limits, the nominal carrier frequency shall be adjusted as close to the upper and lower frequency band edges as the design of the equipment permits.

Radiated emissions which fall in the restricted bands, as defined in Section 15.205(a), must also comply with the radiated emission limits specified in Section 15.209(a) (see Section 15.205(c)).

Use formula below to substitute conducted measurements in place of radiated measurements

$$E[\text{dB}\mu\text{V}/\text{m}] = \text{EIRP}[\text{dBm}] - 20 \log(d[\text{meters}]) + 104.77, \text{ where } E = \text{field strength and } d = 3 \text{ meter}$$

- 1) Average Plot, Limit= -41.25 dBm eirp
- 2) Peak plot, Limit = -21.25 dBm eirp

KDB 789033 D02 General UNII Test Procedures New Rules v02r01

2. Unwanted Emissions that fall Outside of the Restricted Bands

- a) For all measurements, follow the requirements in II.G.3. “General Requirements for Unwanted Emissions Measurements.”
- b) At frequencies below 1000 MHz, use the procedure described in II.G.4. “Procedure for Unwanted Emissions Measurements Below 1000 MHz.”
- c) At frequencies above 1000 MHz, use the procedure for maximum emissions described in II.G.5., “Procedure for Unwanted Emissions Measurements Above 1000 MHz.”
- (i) Sections 15.407(b)(1-3) specifies the unwanted emissions limit for the U-NII-1 and U-NII-2 bands. As specified, emissions above 1000 MHz that are outside of the restricted bands are subject to a peak emission limit of -27 dBm/MHz.

Conducted Band Edge Test Procedure

Ref. ANSI C63.10: 2013

KDB 789033 D02 General UNII Test Procedures New Rules v02r01

Conducted Spurious Emissions Test Procedure
<ol style="list-style-type: none"> 1. Connect the antenna port(s) to the spectrum analyzer input. 2. Place the radio in continuous transmit mode 3. Configure Spectrum analyzer as per test parameters below (be sure to enter all losses between the transmitter output and the spectrum analyzer). 4. Use the peak marker function to determine the maximum spurs amplitude level. 5. The “measure-and-sum technique” is used for measuring in-band transmit power of a device. In the measure-and-sum approach, the conducted emission level is measured at each antenna port. The measured results at the various antenna ports are then summed mathematically to determine the total emission level from the device. Summing is performed in linear power units. The worst case output is recorded. (see ANSI C63.10:2013 section 14.3.2.2) 6. Capture graphs and record pertinent measurement data.

Ref. ANSI C63.10: 2013 section 12.7.6 (Peak) and 12.7.7.2 (Average)**KDB 789033 D02 General UNII Test Procedures New Rules v02r01, Sec. 5 (Peak), Sec. 6 (Average Method AD)**

Conducted Spurious Emissions Test parameters	
Peak RBW = 1 MHz VBW ≥ 3 MHz Sweep = Auto Detector = Peak Trace = Max Hold.	Average RBW = 1 MHz VBW ≥ 3 MHz Sweep = Auto Detector = RMS Power Averaging
Tested By: Johanna Knudsen, Julian Land, Mathew Blackburn	Date of testing: 26-JUL-2021 to 28-JUL-2021; 30-JUL-2021 to 01-AUG-2021; 03-AUG-2021 to 11-AUG-2021; 13-AUG-2021 to 25-AUG-2021; 27-AUG-2021; 01-SEP-2021 to 04-SEP-2021; 11-SEP-2021 to 14-SEP-2021
Test Result: PASS	

Test Equipment

See Appendix C for list of test equipment

Conducted Bandedge Average**Frequency 5180 MHz**

Mode	Tx Paths	Correlated Antenna Gain (dBi)	Tx 1 Bandedge Level (dBm)	Tx 2 Bandedge Level (dBm)	Tx 3 Bandedge Level (dBm)	Tx 4 Bandedge Level (dBm)	Duty Cycle (dB)	Total Tx Bandedge Level (dBm)	Limit (dB)	Margin (dB)
Non HT20, 6 to 54 Mbps	1	14	-57.3				0.26	-43.0	-41	1.79
Non HT20, 6 to 54 Mbps	2	14	-68.2	-63.9			0.26	-48.3	-41	7.02
Non HT20, 6 to 54 Mbps	3	14	-68.9	-63.7	-64.9		0.26	-46.3	-41	5.05
Non HT20, 6 to 54 Mbps	4	14	-69.4	-65.5	-65.9	-64.8	0.26	-45.8	-41	4.56
Non HT20 Beam Forming, 6 to 54 Mbps	2	14	-68.2	-63.9			0.26	-48.3	-41	7.02
Non HT20 Beam Forming, 6 to 54 Mbps	3	17	-69.1	-64.2	-66.1		0.26	-44.0	-41	2.75
Non HT20 Beam Forming, 6 to 54 Mbps	4	17	-70.4	-69.4	-68.5	-69.9	0.26	-46.2	-41	4.97
HT/VHT20, M0 to M7	1	14	-56.8				0.3	-42.5	-41	1.25
HT/VHT20, M0 to M7	2	14	-68.3	-62.3			0.3	-47.0	-41	5.77
HT/VHT20, M8 to M15	2	14	-68.3	-62.3			0.3	-47.0	-41	5.77
HT/VHT20, M0 to M7	3	14	-68.3	-62.3	-65.1		0.3	-45.5	-41	4.25
HT/VHT20, M8 to M15	3	14	-68.3	-62.3	-65.1		0.3	-45.5	-41	4.25
HT/VHT20, M16 to M23	3	14	-68.3	-62.3	-65.1		0.3	-45.5	-41	4.25
HT/VHT20, M0 to M7	4	14	-69.3	-64.5	-66.7	-65.0	0.3	-45.7	-41	4.44
HT/VHT20, M8 to M15	4	14	-69.3	-64.5	-66.7	-65.0	0.3	-45.7	-41	4.44
HT/VHT20, M16 to M23	4	14	-69.3	-64.5	-66.7	-65.0	0.3	-45.7	-41	4.44
HT/VHT20, M24 to M31	4	14	-69.3	-64.5	-66.7	-65.0	0.3	-45.7	-41	4.44
HT/VHT20 Beam Forming, M0 to M7	2	14	-68.3	-62.3			0.3	-47.0	-41	5.77
HT/VHT20 Beam Forming, M8 to M15	2	14	-68.3	-62.3			0.3	-47.0	-41	5.77
HT/VHT20 Beam Forming, M0 to M7	3	17	-69.9	-65.7	-65.5		0.3	-44.5	-41	3.3
HT/VHT20 Beam Forming, M8 to M15	3	14	-68.3	-62.3	-65.1		0.3	-45.5	-41	4.25
HT/VHT20 Beam Forming, M16 to M23	3	14	-68.3	-62.3	-65.1		0.3	-45.5	-41	4.25
HT/VHT20 Beam Forming, M0 to M7	4	17	-71.1	-68.2	-69.3	-69.2	0.3	-46.0	-41	4.76
HT/VHT20 Beam Forming, M8 to M15	4	14	-69.3	-64.5	-66.7	-65.0	0.3	-45.7	-41	4.44
HT/VHT20 Beam Forming, M16 to M23	4	14	-69.3	-64.5	-66.7	-65.0	0.3	-45.7	-41	4.44
HT/VHT20 Beam Forming, M24 to M31	4	14	-69.3	-64.5	-66.7	-65.0	0.3	-45.7	-41	4.44
HT/VHT20 STBC, M0 to M7	2	14	-68.3	-62.3			0.3	-47.0	-41	5.77
HT/VHT20 STBC, M0 to M7	3	14	-68.3	-62.3	-65.1		0.3	-45.5	-41	4.25
HT/VHT20 STBC, M0 to M7	4	14	-69.3	-64.5	-66.7	-65.0	0.3	-45.7	-41	4.44
HE20, M0 to M9 1ss	1	14	-56.0				0.22	-41.8	-41	0.53
HE20, M0 to M9 1ss	2	14	-65.1	-60.0			0.22	-44.6	-41	3.36
HE20, M0 to M9 2ss	2	14	-65.1	-60.0			0.22	-44.6	-41	3.36
HE20, M0 to M9 1ss	3	14	-65.1	-60.0	-64.7		0.22	-43.6	-41	2.36
HE20, M0 to M9 2ss	3	14	-65.1	-60.0	-64.7		0.22	-43.6	-41	2.36

HE20, M0 to M9 3ss	3	14	-65.1	-60.0	-64.7		0.22	-43.6	-41	2.36
HE20, M0 to M9 1ss	4	14	-69.9	-63.2	-65.3	-64.4	0.22	-44.9	-41	3.6
HE20, M0 to M9 2ss	4	14	-69.9	-63.2	-65.3	-64.4	0.22	-44.9	-41	3.6
HE20, M0 to M9 3ss	4	14	-69.9	-63.2	-65.3	-64.4	0.22	-44.9	-41	3.6
HE20, M0 to M9 4ss	4	14	-69.9	-63.2	-65.3	-64.4	0.22	-44.9	-41	3.6
HE20 Beam Forming, M0 to M9 1ss	2	14	-65.1	-60.0			0.22	-44.6	-41	3.36
HE20 Beam Forming, M0 to M9 2ss	2	14	-65.1	-60.0			0.22	-44.6	-41	3.36
HE20 Beam Forming, M0 to M9 1ss	3	17	-69.8	-65.5	-64.9		0.22	-44.3	-41	3.02
HE20 Beam Forming, M0 to M9 2ss	3	14	-65.1	-60.0	-64.7		0.22	-43.6	-41	2.36
HE20 Beam Forming, M0 to M9 3ss	3	14	-65.1	-60.0	-64.7		0.22	-43.6	-41	2.36
HE20 Beam Forming, M0 to M9 1ss	4	17	-71.3	-65.3	-68.5	-68.3	0.22	-44.6	-41	3.35
HE20 Beam Forming, M0 to M9 2ss	4	14	-69.9	-63.2	-65.3	-64.4	0.22	-44.9	-41	3.6
HE20 Beam Forming, M0 to M9 3ss	4	14	-69.9	-63.2	-65.3	-64.4	0.22	-44.9	-41	3.6
HE20 Beam Forming, M0 to M9 4ss	4	14	-69.9	-63.2	-65.3	-64.4	0.22	-44.9	-41	3.6
HE20 STBC, M0 to M9 2ss	2	14	-65.1	-60.0			0.22	-44.6	-41	3.36
HE20 STBC, M0 to M9 2ss	3	14	-65.1	-60.0	-64.7		0.22	-43.6	-41	2.36
HE20 STBC, M0 to M9 2ss	4	14	-69.9	-63.2	-65.3	-64.4	0.22	-44.9	-41	3.6

Frequency 5190 MHz

Mode	Tx Paths	Correlated Antenna Gain (dBi)	Tx 1 Bandedge Level (dBm)	Tx 2 Bandedge Level (dBm)	Tx 3 Bandedge Level (dBm)	Tx 4 Bandedge Level (dBm)	Duty Cycle (dB)	Total Tx Bandedge Level (dBm)	Limit (dB)	Margin (dB)
Non HT40, 6 to 54 Mbps	1	14	-57.2				0.33	-42.9	-41	1.62
Non HT40, 6 to 54 Mbps	2	14	-64.3	-59.3			0.33	-43.8	-41	2.52
Non HT40, 6 to 54 Mbps	3	14	-66.6	-63.1	-64.1		0.33	-45.3	-41	4.01
Non HT40, 6 to 54 Mbps	4	14	-66.6	-63.1	-64.1	-63.3	0.33	-43.7	-41	2.47
HT/VHT40, M0 to M7	1	14	-56.5				0.33	-42.2	-41	0.92
HT/VHT40, M0 to M7	2	14	-63.9	-59.6			0.85	-43.4	-41	2.13
HT/VHT40, M8 to M15	2	14	-63.9	-59.6			0.85	-43.4	-41	2.13
HT/VHT40, M0 to M7	3	14	-65.1	-60.1	-62.7		0.85	-42.5	-41	1.29
HT/VHT40, M8 to M15	3	14	-65.1	-60.1	-62.7		0.85	-42.5	-41	1.29
HT/VHT40, M16 to M23	3	14	-65.1	-60.1	-62.7		0.85	-42.5	-41	1.29
HT/VHT40, M0 to M7	4	14	-66.6	-61.8	-63.9	-62.4	0.85	-42.4	-41	1.2
HT/VHT40, M8 to M15	4	14	-66.6	-61.8	-63.9	-62.4	0.85	-42.4	-41	1.2
HT/VHT40, M16 to M23	4	14	-66.6	-61.8	-63.9	-62.4	0.85	-42.4	-41	1.2
HT/VHT40, M24 to M31	4	14	-66.6	-61.8	-63.9	-62.4	0.85	-42.4	-41	1.2
HT/VHT40 Beam Forming, M0 to M7	2	14	-63.9	-59.6			0.85	-43.4	-41	2.13
HT/VHT40 Beam Forming, M8 to M15	2	14	-63.9	-59.6			0.85	-43.4	-41	2.13
HT/VHT40 Beam Forming, M0 to M7	3	17	-69.0	-64.3	-63.4		0.85	-42.4	-41	1.1
HT/VHT40 Beam Forming, M8 to M15	3	14	-65.1	-60.1	-62.7		0.85	-42.5	-41	1.29
HT/VHT40 Beam Forming, M16 to M23	3	14	-65.1	-60.1	-62.7		0.85	-42.5	-41	1.29
HT/VHT40 Beam Forming, M0 to M7	4	17	-70.2	-66.5	-66.5	-64.8	0.85	-42.7	-41	1.48
HT/VHT40 Beam Forming, M8 to M15	4	14	-66.6	-61.8	-63.9	-62.4	0.85	-42.4	-41	1.2

HT/VHT40 Beam Forming, M16 to M23	4	14	-66.6	-61.8	-63.9	-62.4	0.85	-42.4	-41	1.2
HT/VHT40 Beam Forming, M24 to M31	4	14	-66.6	-61.8	-63.9	-62.4	0.85	-42.4	-41	1.2
HT/VHT40 STBC, M0 to M7	2	14	-63.9	-59.6			0.85	-43.4	-41	2.13
HT/VHT40 STBC, M0 to M7	3	14	-65.1	-60.1	-62.7		0.85	-42.5	-41	1.29
HT/VHT40 STBC, M0 to M7	4	14	-66.6	-61.8	-63.9	-62.4	0.85	-42.4	-41	1.2
HE40, M0 to M9 1ss	1	14	-57.5				0.22	-43.3	-41	2.03
HE40, M0 to M9 1ss	2	14	-62.2	-58.1			0.22	-42.4	-41	1.2
HE40, M0 to M9 2ss	2	14	-62.2	-58.1			0.22	-42.4	-41	1.2
HE40, M0 to M9 1ss	3	14	-63.3	-59.2	-60.1		0.22	-41.5	-41	0.3
HE40, M0 to M9 2ss	3	14	-63.3	-59.2	-60.1		0.22	-41.5	-41	0.3
HE40, M0 to M9 3ss	3	14	-63.3	-59.2	-60.1		0.22	-41.5	-41	0.3
HE40, M0 to M9 1ss	4	14	-65.9	-61.0	-62.6	-61.4	0.22	-42.1	-41	0.86
HE40, M0 to M9 2ss	4	14	-65.9	-61.0	-62.6	-61.4	0.22	-42.1	-41	0.86
HE40, M0 to M9 3ss	4	14	-65.9	-61.0	-62.6	-61.4	0.22	-42.1	-41	0.86
HE40, M0 to M9 4ss	4	14	-65.9	-61.0	-62.6	-61.4	0.22	-42.1	-41	0.86
HE40 Beam Forming, M0 to M9 1ss	2	14	-62.2	-58.1			0.22	-42.4	-41	1.2
HE40 Beam Forming, M0 to M9 2ss	2	14	-62.2	-58.1			0.22	-42.4	-41	1.2
HE40 Beam Forming, M0 to M9 1ss	3	17	-67.2	-62.6	-62.4		0.22	-41.6	-41	0.34
HE40 Beam Forming, M0 to M9 2ss	3	14	-63.3	-59.2	-60.1		0.22	-41.5	-41	0.3
HE40 Beam Forming, M0 to M9 3ss	3	14	-63.3	-59.2	-60.1		0.22	-41.5	-41	0.3
HE40 Beam Forming, M0 to M9 1ss	4	17	-67.9	-65.0	-65.2	-63.3	0.22	-41.8	-41	0.56
HE40 Beam Forming, M0 to M9 2ss	4	14	-65.9	-61.0	-62.6	-61.4	0.22	-42.1	-41	0.86
HE40 Beam Forming, M0 to M9 3ss	4	14	-65.9	-61.0	-62.6	-61.4	0.22	-42.1	-41	0.86
HE40 Beam Forming, M0 to M9 4ss	4	14	-65.9	-61.0	-62.6	-61.4	0.22	-42.1	-41	0.86
HE40 STBC, M0 to M9 2ss	2	14	-62.2	-58.1			0.22	-42.4	-41	1.2
HE40 STBC, M0 to M9 2ss	3	14	-63.3	-59.2	-60.1		0.22	-41.5	-41	0.3
HE40 STBC, M0 to M9 2ss	4	14	-65.9	-61.0	-62.6	-61.4	0.22	-42.1	-41	0.86

Frequency 5210 MHz

Mode	Tx Paths	Correlated Antenna Gain (dBi)	Tx 1 Bandedge Level (dBm)	Tx 2 Bandedge Level (dBm)	Tx 3 Bandedge Level (dBm)	Tx 4 Bandedge Level (dBm)	Duty Cycle (dB)	Total Tx Bandedge Level (dBm)	Limit (dB)	Margin (dB)
Non HT80, 6 to 54 Mbps	1	14	-57.8				0.33	-43.5	-41	2.22
Non HT80, 6 to 54 Mbps	2	14	-63.2	-59.3			0.33	-43.5	-41	2.23
Non HT80, 6 to 54 Mbps	3	14	-63.2	-59.3	-60.2		0.33	-41.5	-41	0.25
Non HT80, 6 to 54 Mbps	4	14	-64.6	-61.1	-62.5	-62.5	0.33	-42.2	-41	0.9
VHT80, M0 to M9 1ss	1	14	-56.5				0.33	-42.2	-41	0.92
VHT80, M0 to M9 1ss	2	14	-62.8	-58.2			0.33	-42.6	-41	1.33
VHT80, M0 to M9 2ss	2	14	-62.8	-58.2			0.33	-42.6	-41	1.33
VHT80, M0 to M9 1ss	3	14	-64.7	-59.5	-60.5		0.33	-42.0	-41	0.7
VHT80, M0 to M9 2ss	3	14	-64.7	-59.5	-60.5		0.33	-42.0	-41	0.7
VHT80, M0 to M9 3ss	3	14	-64.7	-59.5	-60.5		0.33	-42.0	-41	0.7
VHT80, M0 to M9 1ss	4	14	-65.1	-61.2	-63.3	-62.4	0.33	-42.4	-41	1.17
VHT80, M0 to M9 2ss	4	14	-65.1	-61.2	-63.3	-62.4	0.33	-42.4	-41	1.17
VHT80, M0 to M9 3ss	4	14	-65.1	-61.2	-63.3	-62.4	0.33	-42.4	-41	1.17
VHT80, M0 to M9 4ss	4	14	-65.1	-61.2	-63.3	-62.4	0.33	-42.4	-41	1.17
VHT80 Beam Forming, M0 to M9 1ss	2	14	-62.8	-58.2			0.33	-42.6	-41	1.33
VHT80 Beam Forming, M0 to M9 2ss	2	14	-62.8	-58.2			0.33	-42.6	-41	1.33
VHT80 Beam Forming, M0 to M9 1ss	3	17	-66.7	-63.2	-62.4		0.33	-41.6	-41	0.39
VHT80 Beam Forming, M0 to M9 2ss	3	14	-64.7	-59.5	-60.5		0.33	-42.0	-41	0.7
VHT80 Beam Forming, M0 to M9 3ss	3	14	-64.7	-59.5	-60.5		0.33	-42.0	-41	0.7
VHT80 Beam Forming, M0 to M9 1ss	4	17	-67.7	-65.8	-64.1	-65.9	0.33	-42.3	-41	1.09
VHT80 Beam Forming, M0 to M9 2ss	4	14	-65.1	-61.2	-63.3	-62.4	0.33	-42.4	-41	1.17
VHT80 Beam Forming, M0 to M9 3ss	4	14	-65.1	-61.2	-63.3	-62.4	0.33	-42.4	-41	1.17
VHT80 Beam Forming, M0 to M9 4ss	4	14	-65.1	-61.2	-63.3	-62.4	0.33	-42.4	-41	1.17
VHT80 STBC, M0 to M9 1ss	2	14	-62.8	-58.2			0.33	-42.6	-41	1.33
VHT80 STBC, M0 to M9 1ss	3	14	-64.7	-59.5	-60.5		0.33	-42.0	-41	0.7
VHT80 STBC, M0 to M9 1ss	4	14	-65.1	-61.2	-63.3	-62.4	0.33	-42.4	-41	1.17
HE80, M0 to M9 1ss	1	14	-58.0				0.26	-43.7	-41	2.49
HE80, M0 to M9 1ss	2	14	-61.7	-58.2			0.26	-42.3	-41	1.08
HE80, M0 to M9 2ss	2	14	-61.7	-58.2			0.26	-42.3	-41	1.08
HE80, M0 to M9 1ss	3	14	-64.6	-59.0	-59.9		0.26	-41.5	-41	0.29
HE80, M0 to M9 2ss	3	14	-64.6	-59.0	-59.9		0.26	-41.5	-41	0.29
HE80, M0 to M9 3ss	3	14	-64.6	-59.0	-59.9		0.26	-41.5	-41	0.29
HE80, M0 to M9 1ss	4	14	-65.6	-60.4	-61.6	-62.4	0.26	-41.8	-41	0.59
HE80, M0 to M9 2ss	4	14	-65.6	-60.4	-61.6	-62.4	0.26	-41.8	-41	0.59
HE80, M0 to M9 3ss	4	14	-65.6	-60.4	-61.6	-62.4	0.26	-41.8	-41	0.59
HE80, M0 to M9 4ss	4	14	-65.6	-60.4	-61.6	-62.4	0.26	-41.8	-41	0.59
HE80 Beam Forming, M0 to M9 1ss	2	14	-61.7	-58.2			0.26	-42.3	-41	1.08
HE80 Beam Forming, M0 to M9 2ss	2	14	-61.7	-58.2			0.26	-42.3	-41	1.08

HE80 Beam Forming, M0 to M9 1ss	3	17	-66.5	-63.5	-62.0		0.26	-41.6	-41	0.34
HE80 Beam Forming, M0 to M9 2ss	3	14	-64.6	-59.0	-59.9		0.26	-41.5	-41	0.29
HE80 Beam Forming, M0 to M9 3ss	3	14	-64.6	-59.0	-59.9		0.26	-41.5	-41	0.29
HE80 Beam Forming, M0 to M9 1ss	4	17	-69.2	-66.8	-64.9	-66.7	0.26	-43.4	-41	2.11
HE80 Beam Forming, M0 to M9 2ss	4	14	-65.6	-60.4	-61.6	-62.4	0.26	-41.8	-41	0.59
HE80 Beam Forming, M0 to M9 3ss	4	14	-65.6	-60.4	-61.6	-62.4	0.26	-41.8	-41	0.59
HE80 Beam Forming, M0 to M9 4ss	4	14	-65.6	-60.4	-61.6	-62.4	0.26	-41.8	-41	0.59
HE80 STBC, M0 to M9 1ss	2	14	-61.7	-58.2			0.26	-42.3	-41	1.08
HE80 STBC, M0 to M9 1ss	3	14	-64.6	-59.0	-59.9		0.26	-41.5	-41	0.29
HE80 STBC, M0 to M9 1ss	4	14	-65.6	-60.4	-61.6	-62.4	0.26	-41.8	-41	0.59

Data Screenshots

5210 MHz: Non HT80, 6 to 54 Mbps

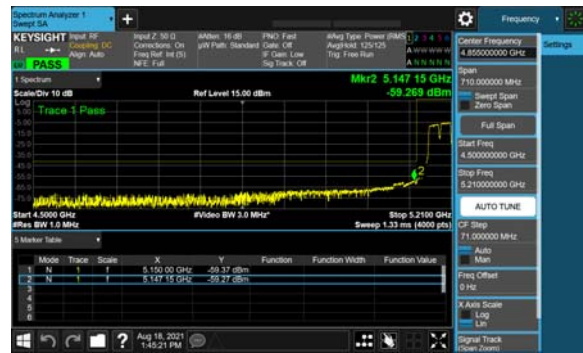

5210 MHz: HE80, M0 to M9 1ss

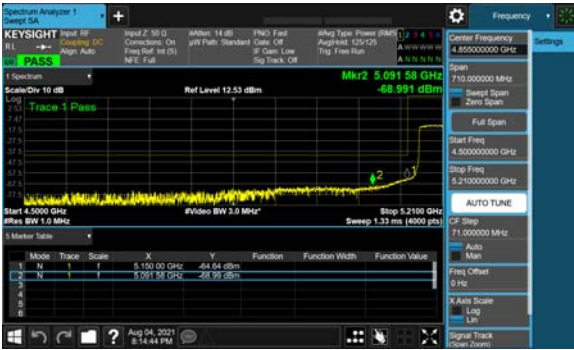

Antenna A



Antenna B



Antenna C

5210 MHz: HE80, M0 to M9 2ss



Antenna A



Antenna B



Antenna C

Conducted Bandedge Peak**Frequency 5180 MHz**

Mode	Tx Paths	Correlated Antenna Gain (dBi)	Tx 1 Bandedge Level (dBm)	Tx 2 Bandedge Level (dBm)	Tx 3 Bandedge Level (dBm)	Tx 4 Bandedge Level (dBm)	Total Tx Bandedge Level (dBm)	Limit (dB)	Margin (dB)
Non HT20, 6 to 54 Mbps	1	14	-46.4				-32.1	-27	5.14
Non HT20, 6 to 54 Mbps	2	14	-54.9	-47.4			-32.4	-27	5.43
Non HT20, 6 to 54 Mbps	3	14	-55.2	-47.3	-52.2		-31.3	-27	4.32
Non HT20, 6 to 54 Mbps	4	14	-55.3	-53.3	-54.1	-53.7	-33.8	-27	6.76
Non HT20 Beam Forming, 6 to 54 Mbps	2	14	-54.9	-47.4			-32.4	-27	5.43
Non HT20 Beam Forming, 6 to 54 Mbps	3	17	-56.4	-53.9	-54.2		-32.7	-27	5.67
Non HT20 Beam Forming, 6 to 54 Mbps	4	17	-58.1	-56.9	-56.3	-55.6	-33.4	-27	6.35
HT/VHT20, M0 to M7	1	14	-45.3				-31.0	-27	4.0
HT/VHT20, M0 to M7	2	14	-54.8	-52.6			-36.2	-27	9.25
HT/VHT20, M8 to M15	2	14	-54.8	-52.6			-36.2	-27	9.25
HT/VHT20, M0 to M7	3	14	-54.8	-52.6	-52.4		-34.1	-27	7.07
HT/VHT20, M8 to M15	3	14	-54.8	-52.6	-52.4		-34.1	-27	7.07
HT/VHT20, M16 to M23	3	14	-54.8	-52.6	-52.4		-34.1	-27	7.07
HT/VHT20, M0 to M7	4	14	-56.1	-53.9	-53.0	-50.1	-32.4	-27	5.41
HT/VHT20, M8 to M15	4	14	-56.1	-53.9	-53.0	-50.1	-32.4	-27	5.41
HT/VHT20, M16 to M23	4	14	-56.1	-53.9	-53.0	-50.1	-32.4	-27	5.41
HT/VHT20, M24 to M31	4	14	-56.1	-53.9	-53.0	-50.1	-32.4	-27	5.41
HT/VHT20 Beam Forming, M0 to M7	2	14	-54.8	-52.6			-36.2	-27	9.25
HT/VHT20 Beam Forming, M8 to M15	2	14	-54.8	-52.6			-36.2	-27	9.25
HT/VHT20 Beam Forming, M0 to M7	3	17	-56.4	-54.2	-54.3		-32.8	-27	5.78
HT/VHT20 Beam Forming, M8 to M15	3	14	-54.8	-52.6	-52.4		-34.1	-27	7.07
HT/VHT20 Beam Forming, M16 to M23	3	14	-54.8	-52.6	-52.4		-34.1	-27	7.07
HT/VHT20 Beam Forming, M0 to M7	4	17	-57.7	-56.9	-56.1	-56.6	-33.5	-27	6.46
HT/VHT20 Beam Forming, M8 to M15	4	14	-56.1	-53.9	-53.0	-50.1	-32.4	-27	5.41
HT/VHT20 Beam Forming, M16 to M23	4	14	-56.1	-53.9	-53.0	-50.1	-32.4	-27	5.41
HT/VHT20 Beam Forming, M24 to M31	4	14	-56.1	-53.9	-53.0	-50.1	-32.4	-27	5.41
HT/VHT20 STBC, M0 to M7	2	14	-54.8	-52.6			-36.2	-27	9.25
HT/VHT20 STBC, M0 to M7	3	14	-54.8	-52.6	-52.4		-34.1	-27	7.07
HT/VHT20 STBC, M0 to M7	4	14	-56.1	-53.9	-53.0	-50.1	-32.4	-27	5.41
HE20, M0 to M9 1ss	1	14	-45.0				-30.8	-27	3.78
HE20, M0 to M9 1ss	2	14	-53.5	-50.3			-34.4	-27	7.38
HE20, M0 to M9 2ss	2	14	-53.5	-50.3			-34.4	-27	7.38
HE20, M0 to M9 1ss	3	14	-53.5	-50.3	-52.2		-32.8	-27	5.81
HE20, M0 to M9 2ss	3	14	-53.5	-50.3	-52.2		-32.8	-27	5.81
HE20, M0 to M9 3ss	3	14	-53.5	-50.3	-52.2		-32.8	-27	5.81
HE20, M0 to M9 1ss	4	14	-57.0	-52.6	-53.7	-50.4	-32.6	-27	5.59
HE20, M0 to M9 2ss	4	14	-57.0	-52.6	-53.7	-50.4	-32.6	-27	5.59
HE20, M0 to M9 3ss	4	14	-57.0	-52.6	-53.7	-50.4	-32.6	-27	5.59
HE20, M0 to M9 4ss	4	14	-57.0	-52.6	-53.7	-50.4	-32.6	-27	5.59
HE20 Beam Forming, M0 to M9 1ss	2	14	-53.5	-50.3			-34.4	-27	7.38
HE20 Beam Forming, M0 to M9 2ss	2	14	-53.5	-50.3			-34.4	-27	7.38
HE20 Beam Forming, M0 to M9 1ss	3	17	-56.6	-54.2	-54.2		-32.9	-27	5.87
HE20 Beam Forming, M0 to M9 2ss	3	14	-53.5	-50.3	-52.2		-32.8	-27	5.81
HE20 Beam Forming, M0 to M9 3ss	3	14	-53.5	-50.3	-52.2		-32.8	-27	5.81
HE20 Beam Forming, M0 to M9 1ss	4	17	-56.4	-51.6	-51.8	-56.6	-30.2	-27	3.23

HE20 Beam Forming, M0 to M9 2ss	4	14	-57.0	-52.6	-53.7	-50.4	-32.6	-27	5.59
HE20 Beam Forming, M0 to M9 3ss	4	14	-57.0	-52.6	-53.7	-50.4	-32.6	-27	5.59
HE20 Beam Forming, M0 to M9 4ss	4	14	-57.0	-52.6	-53.7	-50.4	-32.6	-27	5.59
HE20 STBC, M0 to M9 2ss	2	14	-53.5	-50.3			-34.4	-27	7.38
HE20 STBC, M0 to M9 2ss	3	14	-53.5	-50.3	-52.2		-32.8	-27	5.81
HE20 STBC, M0 to M9 2ss	4	14	-57.0	-52.6	-53.7	-50.4	-32.6	-27	5.59

Frequency 5190 MHz

Mode	Tx Paths	Correlated Antenna Gain (dBi)	Tx 1 Bandedge Level (dBm)	Tx 2 Bandedge Level (dBm)	Tx 3 Bandedge Level (dBm)	Tx 4 Bandedge Level (dBm)	Total Tx Bandedge Level (dBm)	Limit (dB)	Margin (dB)
Non HT40, 6 to 54 Mbps	1	14	-42.9				-28.6	-27	1.57
Non HT40, 6 to 54 Mbps	2	14	-47.9	-42.7			-27.2	-27	0.22
Non HT40, 6 to 54 Mbps	3	14	-48.7	-51.4	-53.4		-31.6	-27	4.64
Non HT40, 6 to 54 Mbps	4	14	-48.7	-51.4	-53.4	-52.9	-30.8	-27	3.83
HT/VHT40, M0 to M7	1	14	-41.5				-27.2	-27	0.17
HT/VHT40, M0 to M7	2	14	-52.8	-47.4			-31.4	-27	4.45
HT/VHT40, M8 to M15	2	14	-52.8	-47.4			-31.4	-27	4.45
HT/VHT40, M0 to M7	3	14	-52.7	-49.2	-53.2		-31.7	-27	4.69
HT/VHT40, M8 to M15	3	14	-52.7	-49.2	-53.2		-31.7	-27	4.69
HT/VHT40, M16 to M23	3	14	-52.7	-49.2	-53.2		-31.7	-27	4.69
HT/VHT40, M0 to M7	4	14	-55.2	-52.9	-51.9	-53.4	-32.3	-27	5.32
HT/VHT40, M8 to M15	4	14	-55.2	-52.9	-51.9	-53.4	-32.3	-27	5.32
HT/VHT40, M16 to M23	4	14	-55.2	-52.9	-51.9	-53.4	-32.3	-27	5.32
HT/VHT40, M24 to M31	4	14	-55.2	-52.9	-51.9	-53.4	-32.3	-27	5.32
HT/VHT40 Beam Forming, M0 to M7	2	14	-52.8	-47.4			-31.4	-27	4.45
HT/VHT40 Beam Forming, M8 to M15	2	14	-52.8	-47.4			-31.4	-27	4.45
HT/VHT40 Beam Forming, M0 to M7	3	17	-59.1	-52.8	-53.6		-31.8	-27	4.8
HT/VHT40 Beam Forming, M8 to M15	3	14	-52.7	-49.2	-53.2		-31.7	-27	4.69
HT/VHT40 Beam Forming, M16 to M23	3	14	-52.7	-49.2	-53.2		-31.7	-27	4.69
HT/VHT40 Beam Forming, M0 to M7	4	17	-51.0	-54.7	-56.6	-53.2	-29.5	-27	2.52
HT/VHT40 Beam Forming, M8 to M15	4	14	-55.2	-52.9	-51.9	-53.4	-32.3	-27	5.32
HT/VHT40 Beam Forming, M16 to M23	4	14	-55.2	-52.9	-51.9	-53.4	-32.3	-27	5.32
HT/VHT40 Beam Forming, M24 to M31	4	14	-55.2	-52.9	-51.9	-53.4	-32.3	-27	5.32
HT/VHT40 STBC, M0 to M7	2	14	-52.8	-47.4			-31.4	-27	4.45
HT/VHT40 STBC, M0 to M7	3	14	-52.7	-49.2	-53.2		-31.7	-27	4.69
HT/VHT40 STBC, M0 to M7	4	14	-55.2	-52.9	-51.9	-53.4	-32.3	-27	5.32
HE40, M0 to M9 1ss	1	14	-46.2				-32.0	-27	4.98
HE40, M0 to M9 1ss	2	14	-52.2	-47.9			-32.3	-27	5.3
HE40, M0 to M9 2ss	2	14	-52.2	-47.9			-32.3	-27	5.3
HE40, M0 to M9 1ss	3	14	-49.1	-46.9	-51.9		-29.8	-27	2.85
HE40, M0 to M9 2ss	3	14	-49.1	-46.9	-51.9		-29.8	-27	2.85
HE40, M0 to M9 3ss	3	14	-49.1	-46.9	-51.9		-29.8	-27	2.85
HE40, M0 to M9 1ss	4	14	-54.2	-51.9	-52.1	-51.8	-32.2	-27	5.15
HE40, M0 to M9 2ss	4	14	-54.2	-51.9	-52.1	-51.8	-32.2	-27	5.15
HE40, M0 to M9 3ss	4	14	-54.2	-51.9	-52.1	-51.8	-32.2	-27	5.15
HE40, M0 to M9 4ss	4	14	-54.2	-51.9	-52.1	-51.8	-32.2	-27	5.15
HE40 Beam Forming, M0 to M9 1ss	2	14	-52.2	-47.9			-32.3	-27	5.3
HE40 Beam Forming, M0 to M9 2ss	2	14	-52.2	-47.9			-32.3	-27	5.3
HE40 Beam Forming, M0 to M9 1ss	3	17	-56.5	-53.1	-51.7		-31.3	-27	4.35
HE40 Beam Forming, M0 to M9 2ss	3	14	-49.1	-46.9	-51.9		-29.8	-27	2.85

HE40 Beam Forming, M0 to M9 3ss	3	14	-49.1	-46.9	-51.9		-29.8	-27	2.85
HE40 Beam Forming, M0 to M9 1ss	4	17	-56.6	-54.0	-53.5	-54.2	-31.2	-27	4.18
HE40 Beam Forming, M0 to M9 2ss	4	14	-54.2	-51.9	-52.1	-51.8	-32.2	-27	5.15
HE40 Beam Forming, M0 to M9 3ss	4	14	-54.2	-51.9	-52.1	-51.8	-32.2	-27	5.15
HE40 Beam Forming, M0 to M9 4ss	4	14	-54.2	-51.9	-52.1	-51.8	-32.2	-27	5.15
HE40 STBC, M0 to M9 2ss	2	14	-52.2	-47.9			-32.3	-27	5.3
HE40 STBC, M0 to M9 2ss	3	14	-49.1	-46.9	-51.9		-29.8	-27	2.85
HE40 STBC, M0 to M9 2ss	4	14	-54.2	-51.9	-52.1	-51.8	-32.2	-27	5.15

Frequency 5210 MHz

Mode	Tx Paths	Correlated Antenna Gain (dBi)	Tx 1 Bandedge Level (dBm)	Tx 2 Bandedge Level (dBm)	Tx 3 Bandedge Level (dBm)	Tx 4 Bandedge Level (dBm)	Total Tx Bandedge Level (dBm)	Limit (dB)	Margin (dB)
Non HT80, 6 to 54 Mbps	1	14	-41.7				-27.4	-27	0.37
Non HT80, 6 to 54 Mbps	2	14	-51.9	-46.4			-31.0	-27	3.99
Non HT80, 6 to 54 Mbps	3	14	-51.9	-46.4	-48.0		-29.1	-27	2.11
Non HT80, 6 to 54 Mbps	4	14	-46.1	-50.9	-52.1	-51.8	-29.1	-27	2.09
VHT80, M0 to M9 1ss	1	14	-45.7				-31.4	-27	4.37
VHT80, M0 to M9 1ss	2	14	-48.3	-47.0			-30.3	-27	3.26
VHT80, M0 to M9 2ss	2	14	-48.3	-47.0			-30.3	-27	3.26
VHT80, M0 to M9 1ss	3	14	-52.1	-49.3	-50.9		-31.5	-27	4.51
VHT80, M0 to M9 2ss	3	14	-52.1	-49.3	-50.9		-31.5	-27	4.51
VHT80, M0 to M9 3ss	3	14	-52.1	-49.3	-50.9		-31.5	-27	4.51
VHT80, M0 to M9 1ss	4	14	-52.5	-50.3	-51.4	-51.9	-31.1	-27	4.1
VHT80, M0 to M9 2ss	4	14	-52.5	-50.3	-51.4	-51.9	-31.1	-27	4.1
VHT80, M0 to M9 3ss	4	14	-52.5	-50.3	-51.4	-51.9	-31.1	-27	4.1
VHT80, M0 to M9 4ss	4	14	-52.5	-50.3	-51.4	-51.9	-31.1	-27	4.1
VHT80 Beam Forming, M0 to M9 1ss	2	14	-48.3	-47.0			-30.3	-27	3.26
VHT80 Beam Forming, M0 to M9 2ss	2	14	-48.3	-47.0			-30.3	-27	3.26
VHT80 Beam Forming, M0 to M9 1ss	3	17	-55.7	-50.9	-52.2		-30.4	-27	3.4
VHT80 Beam Forming, M0 to M9 2ss	3	14	-52.1	-49.3	-50.9		-31.5	-27	4.51
VHT80 Beam Forming, M0 to M9 3ss	3	14	-52.1	-49.3	-50.9		-31.5	-27	4.51
VHT80 Beam Forming, M0 to M9 1ss	4	17	-53.7	-54.5	-52.9	-54.2	-30.4	-27	3.43
VHT80 Beam Forming, M0 to M9 2ss	4	14	-52.5	-50.3	-51.4	-51.9	-31.1	-27	4.1
VHT80 Beam Forming, M0 to M9 3ss	4	14	-52.5	-50.3	-51.4	-51.9	-31.1	-27	4.1
VHT80 Beam Forming, M0 to M9 4ss	4	14	-52.5	-50.3	-51.4	-51.9	-31.1	-27	4.1
VHT80 STBC, M0 to M9 1ss	2	14	-48.3	-47.0			-30.3	-27	3.26
VHT80 STBC, M0 to M9 1ss	3	14	-52.1	-49.3	-50.9		-31.5	-27	4.51
VHT80 STBC, M0 to M9 1ss	4	14	-52.5	-50.3	-51.4	-51.9	-31.1	-27	4.1
HE80, M0 to M9 1ss	1	14	-45.0				-30.7	-27	3.74
HE80, M0 to M9 1ss	2	14	-48.1	-44.5			-28.7	-27	1.66
HE80, M0 to M9 2ss	2	14	-48.1	-44.5			-28.7	-27	1.66
HE80, M0 to M9 1ss	3	14	-52.3	-49.1	-49.4		-31.0	-27	4.01
HE80, M0 to M9 2ss	3	14	-52.3	-49.1	-49.4		-31.0	-27	4.01
HE80, M0 to M9 3ss	3	14	-52.3	-49.1	-49.4		-31.0	-27	4.01
HE80, M0 to M9 1ss	4	14	-54.5	-50.3	-52.5	-51.6	-31.7	-27	4.69
HE80, M0 to M9 2ss	4	14	-54.5	-50.3	-52.5	-51.6	-31.7	-27	4.69
HE80, M0 to M9 3ss	4	14	-54.5	-50.3	-52.5	-51.6	-31.7	-27	4.69
HE80, M0 to M9 4ss	4	14	-54.5	-50.3	-52.5	-51.6	-31.7	-27	4.69
HE80 Beam Forming, M0 to M9 1ss	2	14	-48.1	-44.5			-28.7	-27	1.66
HE80 Beam Forming, M0 to M9 2ss	2	14	-48.1	-44.5			-28.7	-27	1.66

HE80 Beam Forming, M0 to M9 1ss	3	17	-48.4	-50.8	-50.5		-27.7	-27	0.73
HE80 Beam Forming, M0 to M9 2ss	3	14	-52.3	-49.1	-49.4		-31.0	-27	4.01
HE80 Beam Forming, M0 to M9 3ss	3	14	-52.3	-49.1	-49.4		-31.0	-27	4.01
HE80 Beam Forming, M0 to M9 1ss	4	17	-57.1	-54.0	-54.2	-54.4	-31.5	-27	4.48
HE80 Beam Forming, M0 to M9 2ss	4	14	-54.5	-50.3	-52.5	-51.6	-31.7	-27	4.69
HE80 Beam Forming, M0 to M9 3ss	4	14	-54.5	-50.3	-52.5	-51.6	-31.7	-27	4.69
HE80 Beam Forming, M0 to M9 4ss	4	14	-54.5	-50.3	-52.5	-51.6	-31.7	-27	4.69
HE80 STBC, M0 to M9 1ss	2	14	-48.1	-44.5			-28.7	-27	1.66
HE80 STBC, M0 to M9 1ss	3	14	-52.3	-49.1	-49.4		-31.0	-27	4.01
HE80 STBC, M0 to M9 1ss	4	14	-54.5	-50.3	-52.5	-51.6	-31.7	-27	4.69

Data Screenshots

5190 MHz: HT/VHT40, M0 to M7

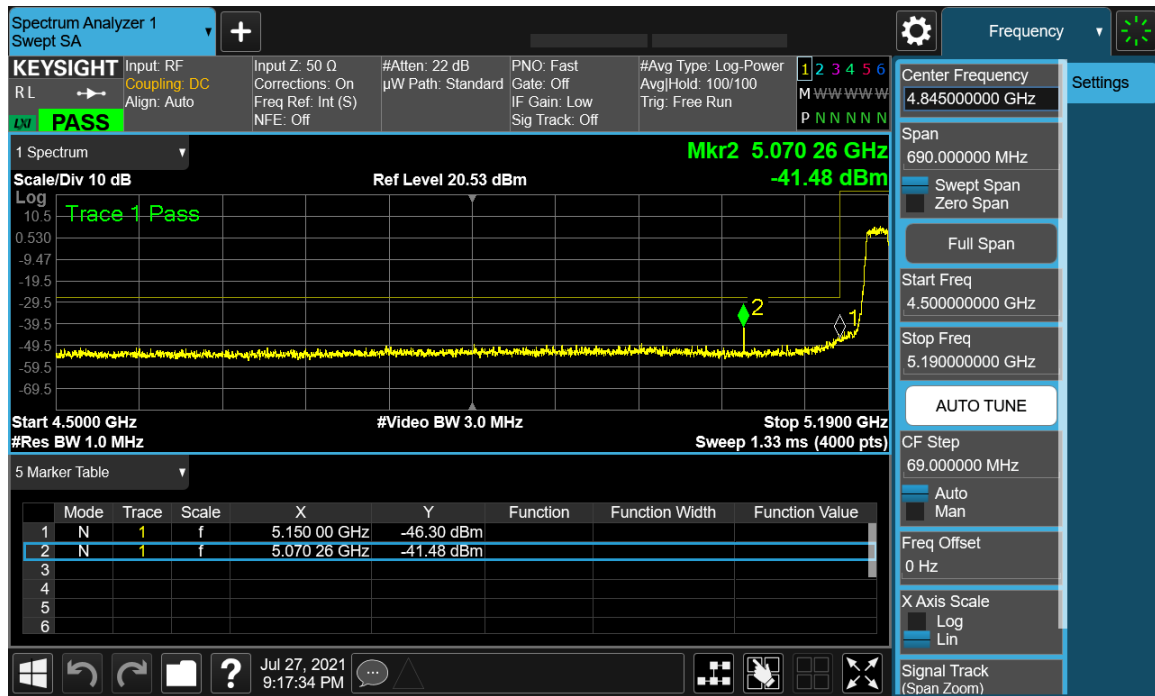

Antenna A

5190 MHz: Non HT40, 6 to 54 Mbps



Antenna A



Antenna B

5210 MHz: Non HT80, 6 to 54 Mbps

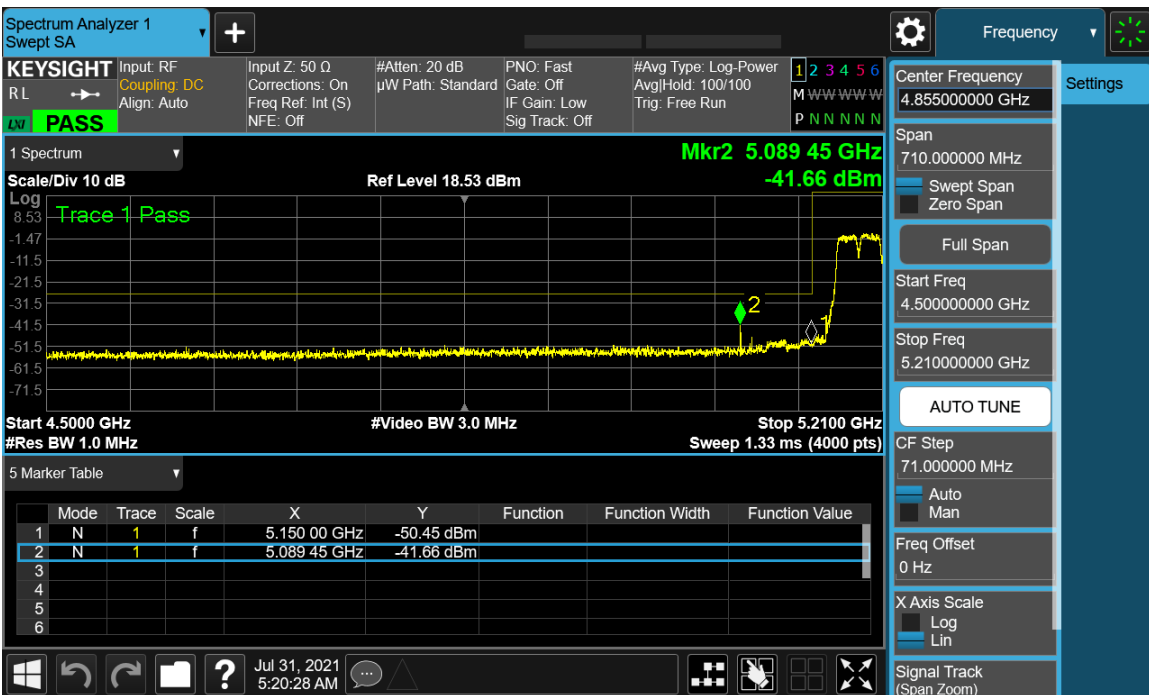

Antenna A

Appendix B: Emission Test Results

Testing Laboratory: Cisco Systems, Inc., 125 West Tasman Drive, San Jose, CA 95134, USA

Radiated Emission Setup Diagram-Below 1G

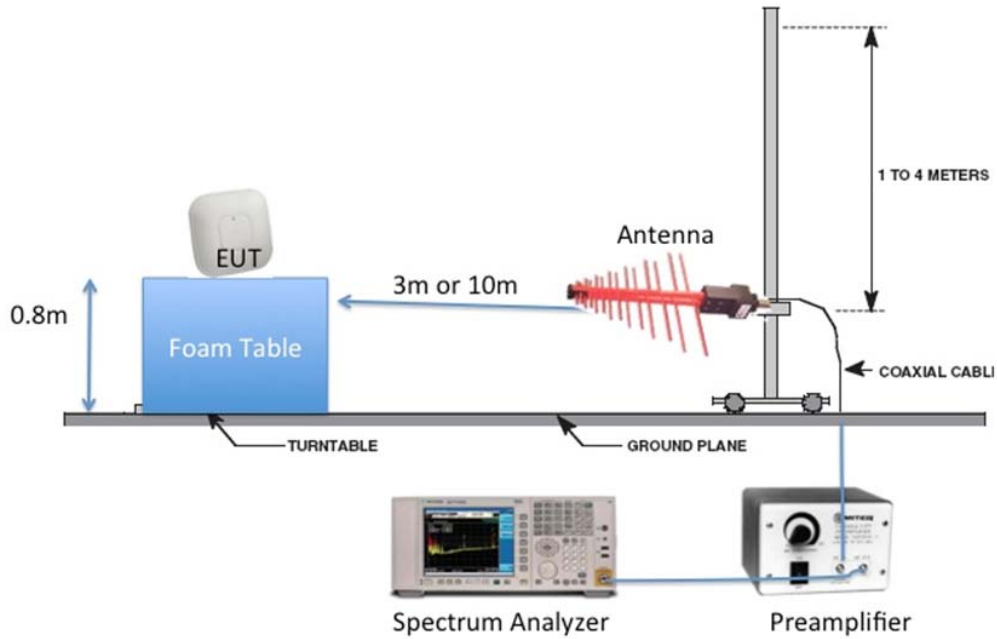

Radiated Emission Setup Diagram-Above 1G

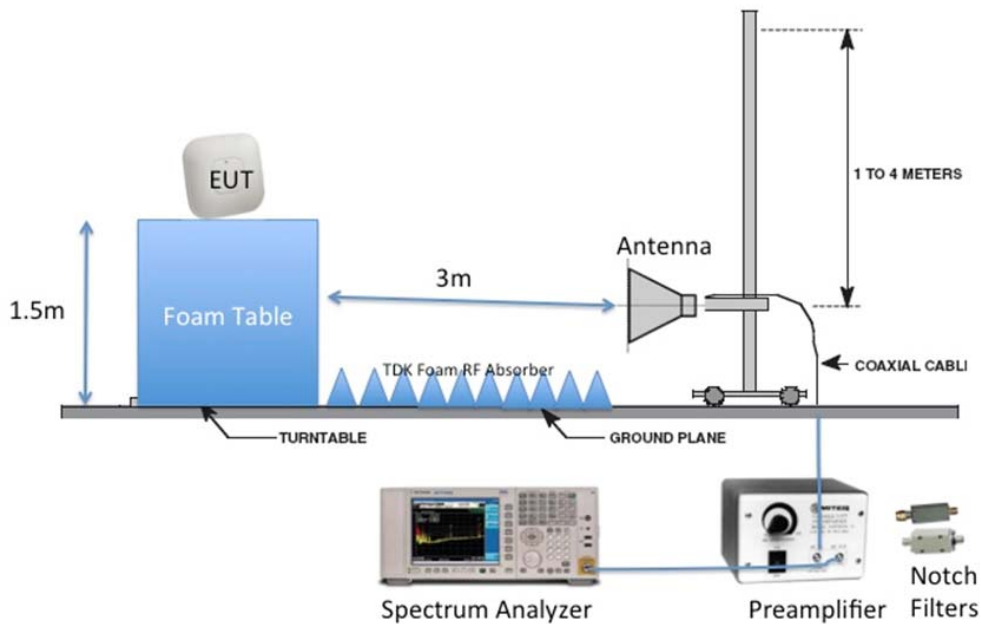

B.1: Radiated Spurious Emissions

FCC 15.205 | 15.407

Radiated emissions which fall in the restricted bands, as defined in Section 15.205(a), must also comply with the radiated emission limits specified in Section 15.209(a) (see Section 15.205(c)).

Not covered by the scope of this test report.

B.2: Radiated Emissions 30MHz to 1GHz

FCC 15.209 | 15.205 | 15.407

Radiated emissions which fall in the restricted bands, as defined in Section 15.205(a), must also comply with the radiated emission limits specified in Section 15.209(a) (see Section 15.205(c)).

Ref. ANSI C63.10: 2013 section 6.5

Not covered by the scope of this test report.

B.3: AC Conducted Emissions

FCC 15.207

Except when the requirements applicable to a given device state otherwise, for any radio apparatus equipped to operate from the public utility AC power supply, either directly or indirectly (such as with a battery charger), the radio frequency voltage of emissions conducted back onto the AC power lines in the frequency range of 0.15 MHz to 30 MHz shall not exceed the limits shown in the table in these sections. The more stringent limit applies at the frequency range boundaries.

Measurement Procedure:

Accordance with ANSI C63.10:2013 section 6.2

Not covered by the scope of this test report.

Appendix C: List of Test Equipment Used to perform the test

Equip#	Manufacturer/ Model	Description	Last Cal	Next Due	Test Item
Test Equipment used for conducted tests – Rack 2					
49515	Keysight (Agilent/HP)/N5182B	MXG X-Series RF Vector Signal Generator	16-Oct-20	16-Oct-21	A.1-A.6
49516	Keysight/ (Agilent/HP)/ N9030A-550	PXA Signal Analyzer, 3Hz to 50GHz	11-Nov-20	11-Nov-21	A.1-A.6
57476	Cisco/Automatio n Test Insertion Loss	Rack 2	Verify Before Use	Verify Before Use	A.1-A.6
46065	National Instruments/ PXI-1042Q	8 slot PXI chassis	Cal Not Required	Cal Not Required	A.1-A.6
57237	National Instruments/ PXI-8115	Embedded Controller	Cal Not Required	Cal Not Required	A.1-A.6
54686	National Instruments/ PXI-2796	40 GHz Dual 6x1 Multiplexer (SP6T)	Verify Before Use	Verify Before Use	A.1-A.6
57245	National Instruments/ PXI-2799	Switch 1x1	Verify Before Use	Verify Before Use	A.1-A.6
56091	National Instruments/ PXI-2796	40 GHz Dual 6x1 Multiplexer (SP6T)	Verify Before Use	Verify Before Use	A.1-A.6
54235	PASTERNAK/ PE5019-1	Torque Wrench	9-Mar-21	9-Mar-22	A.1-A.6
58256	COMET/ T7611- 4	WEB SENSOR FOR REMOTE THERMOMETE R HYGROMETER	3-Feb-21	3-Feb-22	A.1-A.6

Equip#	Manufacturer/ Model	Description	Last Cal	Next Due	Test Item
Test Equipment used for conducted tests – Rack 3					
55108	Keysight/ (Agilent/HP)/ N9030A-550	PXA Signal Analyzer, 3Hz to 50GHz	03-Feb-21	03-Feb-22	A.1-A.6
57476	Cisco/Automatio n Test Insertion Loss	Rack 3	Verify Before Use	Verify Before Use	A.1-A.6
55093	National Instruments/ PXI-1042Q	8 slot PXI chassis	Cal Not Required	Cal Not Required	A.1-A.6
57238	National Instruments/ PXI-8115	Embedded Controller	Cal Not Required	Cal Not Required	A.1-A.6
57247	National Instruments/ PXI-2796	40 GHz Dual 6x1 Multiplexer (SP6T)	Verify Before Use	Verify Before Use	A.1-A.6
57248	National Instruments/ PXI-2799	Switch 1x1	Verify Before Use	Verify Before Use	A.1-A.6
56092	National Instruments/ PXI-2796	40 GHz Dual 6x1 Multiplexer (SP6T)	Verify Before Use	Verify Before Use	A.1-A.6
54235	PASTERNAK/ PE5019-1	Torque Wrench	9-Mar-21	9-Mar-22	A.1-A.6
58256	COMET/ T7611- 4	WEB SENSOR FOR REMOTE THERMOMETE R HYGROMETER	3-Feb-21	3-Feb-22	A.1-A.6

Equip#	Manufacturer/ Model	Description	Last Cal	Next Due	Test Item
Test Equipment used for conducted tests – Rack 8					
58720	Cisco/Automation Test Insertion Loss	Rack 8	Verify Before Use	Verify Before Use	A.1-A.6
57562	Keysight (Agilent/HP) / N9030B-550 OPT LNP EPO	PXA Signal Analyzer, 2Hz-50GHz with Options LNP and EPO	28-Jul-21	28-Jul-22	A.1-A.6
58205	NATIONAL INSTRUMENTS / PXIe-1062Q	CHASSIS	Cal Not Required	Cal Not Required	A.1-A.6
58206	NATIONAL INSTRUMENTS / PXIe-8840	Up to 2.6 GHz Quad-Core PXI Express Controller	Cal Not Required	Cal Not Required	A.1-A.6
58208	NATIONAL INSTRUMENTS / PXI-2796	40 GHz Dual 6x1 Multiplexer (SP6T)	Verify Before Use	Verify Before Use	A.1-A.6
58210	NATIONAL INSTRUMENTS / PXI-2796	40 GHz Dual 6x1 Multiplexer (SP6T)	Verify Before Use	Verify Before Use	A.1-A.6
58211	NATIONAL INSTRUMENTS / PXI-2799	Switch 1x1	Verify Before Use	Verify Before Use	A.1-A.6
54235	PASTERNAK/ PE5019-1	Torque Wrench	9-Mar-21	9-Mar-22	A.1-A.6
58256	COMET/ T7611-4	WEB SENSOR FOR REMOTE THERMOMETER HYGROMETER	3-Feb-21	3-Feb-22	A.1-A.6

Equipment #	Manufacturer/ Model	Description	Last Cal	Next Due	Test Item
Test Equipment used for conducted tests – Rack 9					
58719	Cisco/Automation Test Insertion Loss	Rack 9	Verify Before Use	Verify Before Use	A.1-A.6
53614	Keysight (Agilent/HP)/ N9030B-550 OPT LNP EPO	PXA Signal Analyzer, 2Hz-50GHz with Options LNP and EPO	1-Jul-21	1-Jul-22	A.1-A.6
58231	NATIONAL INSTRUMENTS / PXIe-1062Q	CHASSIS	Cal Not Required	Cal Not Required	A.1-A.6
58232	NATIONAL INSTRUMENTS / PXIe-8840	Up to 2.6 GHz Quad-Core PXI Express Controller	Cal Not Required	Cal Not Required	A.1-A.6
58234	NATIONAL INSTRUMENTS / PXI-2796	40 GHz Dual 6x1 Multiplexer (SP6T)	Verify Before Use	Verify Before Use	A.1-A.6
58236	NATIONAL INSTRUMENTS / PXI-2796	40 GHz Dual 6x1 Multiplexer (SP6T)	Verify Before Use	Verify Before Use	A.1-A.6
58237	NATIONAL INSTRUMENTS / PXI-2799	Switch 1x1	Verify Before Use	Verify Before Use	A.1-A.6
54235	PASTERNAK/ PE5019-1	Torque Wrench	9-Mar-21	9-Mar-22	A.1-A.6
58256	COMET/ T7611-4	WEB SENSOR FOR REMOTE THERMOMETER HYGROMETER	3-Feb-21	3-Feb-22	A.1-A.6

Equip#	Manufacturer/ Model	Description	Last Cal	Next Due	Test Item
Test Equipment used for conducted tests – Rack 4					
57478	Cisco/Automation Test Insertion Loss	Rack 4	Verify Before Use	Verify Before Use	A.1-A.6
58702	Keysight (Agilent/HP)/ N9030B-550	PXA Signal Analyzer, 2Hz- 50GHz	15-Oct-20	15-Oct-21	A.1-A.6
55096	National Instruments/ PXI- 1042	CHASSIS, PXI	Cal Not Required	Cal Not Required	A.1-A.6
57239	National Instruments/ PXI- 8115	Embedded Controller	Cal Not Required	Cal Not Required	A.1-A.6
57250	National Instruments/ PXI- 2796	40 GHz Dual 6x1 Multiplexer (SP6T)	Verify Before Use	Verify Before Use	A.1-A.6
57251	National Instruments/ PXI- 2799	Switch 1x1	Verify Before Use	Verify Before Use	A.1-A.6
56093	National Instruments/ PXI-2796	40 GHz Dual 6x1 Multiplexer (SP6T)	Verify Before Use	Verify Before Use	A.1-A.6
54235	PASTERNAK/ PE5019-1	Torque Wrench	9-Mar-21	9-Mar-22	A.1-A.6
58256	COMET/ T7611- 4	WEB SENSOR FOR REMOTE THERMOMETER HYGROMETER	3-Feb-21	3-Feb-22	A.1-A.6

Appendix D: Abbreviation Key and Definitions

The following table defines abbreviations used within this test report.

Abbreviation	Description	Abbreviation	Description
EMC	Electro Magnetic Compatibility	°F	Degrees Fahrenheit
EMI	Electro Magnetic Interference	°C	Degrees Celsius
EUT	Equipment Under Test	Temp	Temperature
ITE	Information Technology Equipment	S/N	Serial Number
TAP	Test Assessment Schedule	Qty	Quantity
ESD	Electro Static Discharge	emf	Electromotive force
EFT	Electric Fast Transient	RMS	Root mean square
EDCS	Engineering Document Control System	Qp	Quasi Peak
Config	Configuration	Av	Average
CIS#	Cisco Number (unique identification number for Cisco test equipment)	Pk	Peak
Cal	Calibration	kHz	Kilohertz (1x10 ³)
EN	European Norm	MHz	MegaHertz (1x10 ⁶)
IEC	International Electro technical Commission	GHz	Gigahertz (1x10 ⁹)
CISPR	International Special Committee on Radio Interference	H	Horizontal
CDN	Coupling/Decoupling Network	V	Vertical
LISN	Line Impedance Stabilization Network	dB	decibel
PE	Protective Earth	V	Volt
GND	Ground	kV	Kilovolt (1x10 ³)
L1	Line 1	µV	Microvolt (1x10 ⁻⁶)
L2	Line2	A	Amp
L3	Line 3	µA	Micro Amp (1x10 ⁻⁶)
DC	Direct Current	mS	Milli Second (1x10 ⁻³)
RAW	Uncorrected measurement value, as indicated by the measuring device	µS	Micro Second (1x10 ⁻⁶)
RF	Radio Frequency	µS	Micro Second (1x10 ⁻⁶)
SLCE	Signal Line Conducted Emissions	m	Meter
Meas dist	Measurement distance	Spec dist	Specification distance
N/A or NA	Not Applicable	SL	Signal Line (or Telecom Line)
P	Power Line	L	Live Line
N	Neutral Line	R	Return
S	Supply	AC	Alternating Current

Appendix E: Photographs of Test Setups

EUT Photos have been omitted from this test report. Photos can be found in the supplementary exhibit included in the submission and EDCS# 22609793.

Appendix F: Software Used to Perform Testing

Cisco Internal LabView Radio Test Automation Software:

RF Automation Main versions: 230, 232, 233, 234
RF Domain Report Generation - version 3

Appendix G: Test Procedures

Measurements were made in accordance with:

- KDB Publication No. 789033 - D02 General UNII Test Procedures New Rules v02r01
- KDB Publication No. 662911 - MIMO
- ANSI C63.4 2014 Unintentional Radiators
- ANSI C63.10 2013 Intentional Radiators

Test procedures are summarized below:

FCC 5GHz Test Procedures	EDCS # 1445048
FCC 5GHz RSE Test Procedures	EDCS # 1511600

Appendix H: Scope of Accreditation (A2LA certificate number 1178-01)

The scope of accreditation of Cisco Systems, Inc. can be found on the A2LA web page at:

<http://www.a2la.org/scopepdf/1178-01.pdf>

Appendix I: Test Assessment Plan

Compliance Test Plan (Excel) EDCS# 21468207
Target Power Tables EDCS# 21389500

Appendix J: Worst Case Justification

N/A

End