

<https://cisco.com/go/headsets>



Printed in PRC



78-101053-0 1

© 2018 Cisco Systems, Inc. All rights reserved.

Cisco Headset 500 Series



Model 561
Model 562
with Multi-base



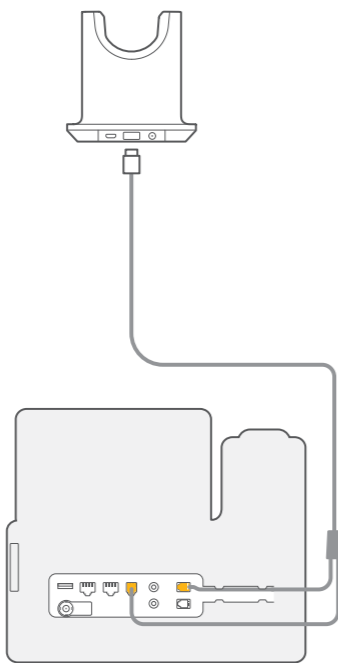
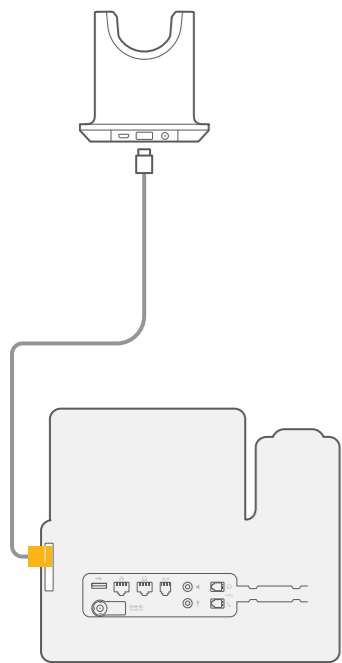

AUX

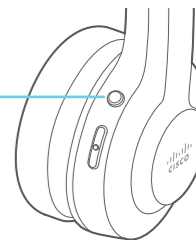
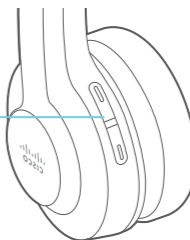
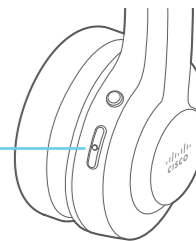
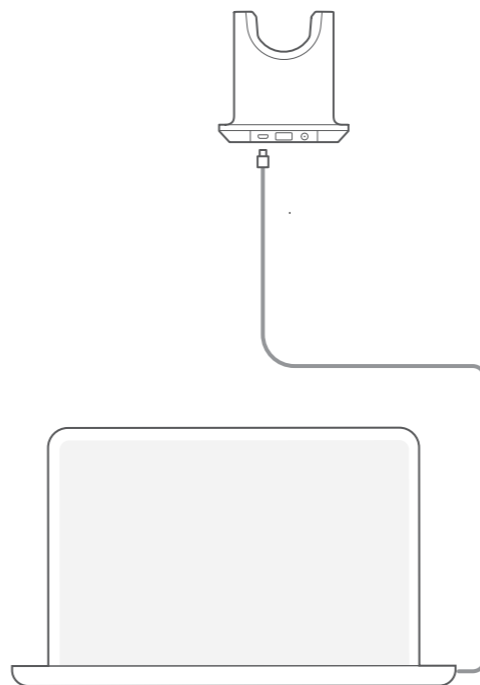

https://cisco.com/go/headset_support

Cisco Headset 561 and Cisco Headset 562 with Multi-Base

For Cisco IP Phone 8800 Series on Cisco Unified Communications Manager



High Sound Pressure—Avoid listening to high volume levels for long periods to prevent possible hearing damage.

When you plug in your headset, lower the volume of the headset speaker before you put the headset on. If you remember to lower the volume before you take the headset off, the volume will start lower when you plug in your headset again.

Be aware of your surroundings. When you use your headset, it may block out important external sounds, particularly in emergencies or in noisy environments. Don't use the headset while driving. Don't leave your headset or headset cables in an area where people or pets can trip over them. Always supervise children who are near your headset or headset cables.

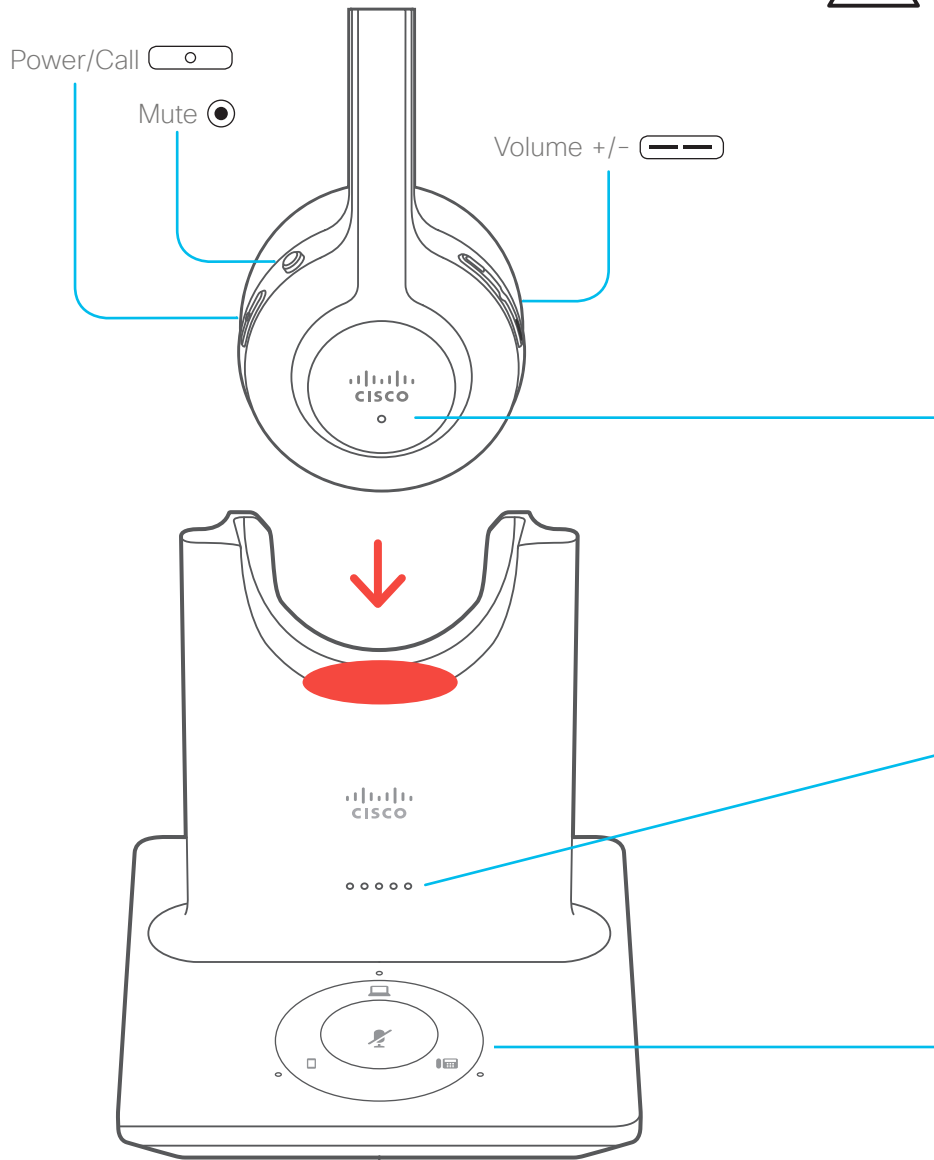

Headset LED status indication

Incoming Call	Blinking red
Active Call	Steady red
Headset paired with dock	White LED blinking every 4 seconds
Headset and dock not paired	White LED blinking rapidly

Base LED status indication

Battery strength	LEDs show solid as battery charges
System update	LEDs blink in sequence left to right.
Headset and dock not paired	All LEDs blinking

Sources

- Mobile
- Computer
- Deskphone

Source Call Status

Incoming Call	Blinking Green	
Active Call	Steady Green	
Muted Call	Steady Red	

Turn on/off your headset

Hold  for 4 seconds.
You will hear a tone indicating headset status.

Make a call

Press .

Put a call on hold

Press .

End a call

Hold  for 2 seconds.

Reject a call

Press  twice.

Adjust your volume

Press .

Mute yourself on a call

Press .



Unmute yourself on a call

Press  again.



End a call and answer an incoming call

1. Hold  for 2 seconds.
2. Press .

End a call and resume a held call

1. Hold  for 2 seconds.
2. Select the call you would like to resume.
3. Press .



Put a call on hold and resume a call

1. Press .
2. Optional: Select the call you would like to resume.
3. Press  again.

Put a call on hold and answer an incoming call

Press .

End a call and answer a call from a different source.

1. Press  for 2 seconds.
2. Select the call source on the dock.
3. Press  again.

Adjust your bass and treble (USB only)

1. Press **Applications** .
2. Select **Accessories** > **Cisco Headset**.
3. Press **Setup** and select **Speaker** > **Tuning**.
4. Press the Navigation cluster, left or right, to adjust the tuning.

Adjust your speaker feedback (USB only)

1. Press **Applications** .
2. Select **Accessories** > **Cisco Headset**.
3. Press **Setup** and select **Speaker** > **Sidetone**.
4. Press the Navigation cluster, up or down, to adjust the sidetone.
The sidetone is low by default.
5. Select **Set** to apply your settings.

Adjust your microphone volume (USB only)

1. Press **Applications** .
2. Select **Accessories** > **Cisco Headset**.
3. Press **Setup** and select **Microphone** > **Gain**.
4. Press the Navigation cluster, left or right, to adjust the gain.

Test your microphone (USB only)

1. Press **Applications** .
2. Select **Accessories** > **Cisco Headset**.
3. Press **Setup** and select **Microphone** > **Test**.
4. Press **Record** and speak into the microphone.
5. Press **Stop rec** when you finish speaking.
6. Press **Play** to review your test recording.

For more information, visit:

<http://www.cisco.com/go/ipphones/7800>
<http://www.cisco.com/go/ipphones/8800>
<http://www.cisco.com/go/headsets>

Cisco and the Cisco logo are trademarks or registered trademarks of Cisco and/or its affiliates in the U.S. and other countries. To view a list of Cisco trademarks, go to this URL: www.cisco.com/go/trademarks. Third-party trademarks mentioned are the property of their respective owners. The use of the word partner does not imply a partnership relationship between Cisco and any other company. (1110R)

FCC Warning:

This device complies with part 15 of the FCC Rules. Operation is subject to the following two conditions:

(1) This device may not cause harmful interference, and (2) this device must accept any interference received, including interference that may cause undesired operation. Any Changes or modifications not expressly approved by the party responsible for compliance could void the user's authority to operate the equipment.

Note: This equipment has been tested and found to comply with the limits for a Class B digital device, pursuant to part 15 of the FCC Rules. These limits are designed to provide reasonable protection against harmful interference in a residential installation. This equipment generates, uses and can radiate radio frequency energy and, if not installed and used in accordance with the instructions, may cause harmful interference to radio communications. However, there is no guarantee that interference will not occur in a particular installation. If this equipment does cause harmful interference to radio or television reception, which can be determined by turning the equipment off and on, the user is encouraged to try to correct the interference by one or more of the following measures:

- Reorient or relocate the receiving antenna.
- Increase the separation between the equipment and receiver.
- Connect the equipment into an outlet on a circuit different from that to which the receiver is connected.
- Consult the dealer or an experienced radio/TV technician for help.

FCC Exposure to Radio Frequency (RF) Signals

For Handset

This is a radio transmitter and receiver. It is designed and manufactured not to exceed the emission limits for exposure to radio frequency (RF) energy set by the Federal Communications Commission (FCC) of the U.S. Government. These limits are part of comprehensive guidelines and establish permitted levels of RF energy for the general population. The guidelines are based on the safety standards previously set by both U.S. and international standards bodies. These standards include a substantial safety margin designed to assure the safety of all persons, regardless of age and health. This device and its antenna must not be collocated or operating in conjunction with any other antenna or transmitter. This product has been shown to be capable of compliance for localized specific absorption rate (SAR) for uncontrolled environment/general population exposure limits specified in ANSI/IEEE Std. C95.1-1992 and had been tested in accordance with the measurement procedures specified in FCC/OET Bulletin 65 Supplement C (2001) and IEEE 1528.

For Base

This equipment complies with FCC radiation exposure limits set forth for an uncontrolled environment. This equipment should be installed and operated with minimum distance 20cm between the radiator& your body.

This transmitter must not be co-located or operating in conjunction with any other antenna or transmitter.

ISED Warning:

This device complies with ISED licence-exempt RSS standard(s). Operation is subject to the following two conditions:

- (1) this device may not cause interference, and
- (2) this device must accept any interference, including interference that may cause undesired operation of the device.

Le présent appareil est conforme aux CNR d'ISED applicables aux appareils radio exempts de licence. L'exploitation est autorisée aux deux conditions suivantes :

- (1) l'appareil ne doit pas produire de brouillage, et
- (2) l'utilisateur de l'appareil doit accepter tout brouillage radioélectrique subi, même si le brouillage est susceptible d'en compromettre le fonctionnement.

The device has been tested and compliance with SAR limits, users can obtain Canadian information on RF exposure and compliance

Le présent appareil est conforme. Après examen de ce matériel aux limites DAS et/ou aux limites d'intensité de champ RF, les utilisateurs peuvent sur l'exposition aux radiofréquences et la conformité and compliance d'acquérir

ISED Specific Absorption Rate (SAR) information

For Handset

SAR tests are conducted using standard operating positions accepted by the ISED with device transmitting at its highest certified power level in all tested frequency bands, although the SAR is determined at the highest certified power level, the actual SAR level of the device while operating can be well below the maximum value. Before a new model device is available for sale to the public, it must be tested and certified to the ISED that it does not exceed the exposure limit established by the ISED, tests for each device are performed in positions and locations as required by the ISED. For body worn operation, this model device has been tested and meets the ISED RF exposure guidelines when used with an accessory designated for this product or when used with an accessory that contains no metal.

For Base

This equipment complies with ISED radiation exposure limits set forth for an uncontrolled environment. This equipment should be installed and operated with minimum distance 20cm between the radiator & your body.

This transmitter must not be co-located or operating in conjunction with any other antenna or transmitter.

ISED Radiation Exposure Statement:

For Handset

SAR l'utilisation des règles sma l'emplacement Le matériel de transmission et fonctionnant dans tous les essais à la certification, même si la puissance suprême a décidé le niveau, utilisation spécifique peut être très en deçà de la valeur de référence maximale. Types de matériel sont vendus au public un ancien, d'essai et de certification de l'exposition, limite maximum sma,

chaque document et l'emplacement du matériel d'essai et conformément au document. Le modèle en physique, matériel d'essai et conforme aux directives d'exposition des radiofréquences sma quand une annexe désigné pour ce produit lors de leur utilisation ou des pièces de rechange ne contiennent pas de métal.

For Base

Cet équipement est conforme aux limites d'exposition aux radiations ISEDC définies pour un environnement non contrôlé. Cet équipement doit être installé et utilisé avec une distance minimale de 20 cm entre le radiateur et votre corps.

Cet émetteur ne doit pas être situé ou fonctionner conjointement avec une autre antenne ou un autre émetteur.