



# RADIO TEST REPORT

**FCC ID** : LDK-9160S2579  
**Equipment** : Catalyst Wireless 9166D1 Series Wi-Fi 6E Access Point  
**Brand Name** : CISCO  
**Model Name** : CW9166D1-B, CW9166D1-MR  
**Applicant** : Cisco Systems Inc  
125 West Tasman Drive San Jose California United States 95134-1706  
**Manufacturer** : Cisco Systems Inc  
125 West Tasman Drive San Jose California United States 95134-1706  
**Standard** : 47 CFR FCC Part 15.247

The product was received on Jan. 17, 2023, and testing was started from Mar. 13, 2023 and completed on May 08, 2023. We, Sporton International Inc. Hsinchu Laboratory, would like to declare that the tested sample has been evaluated in accordance with the procedures given in ANSI C63.10-2013 and shown compliance with the applicable technical standards.

The test results in this report apply exclusively to the tested model / sample. Without written approval of Sporton International Inc. Hsinchu Laboratory, the test report shall not be reproduced except in full.

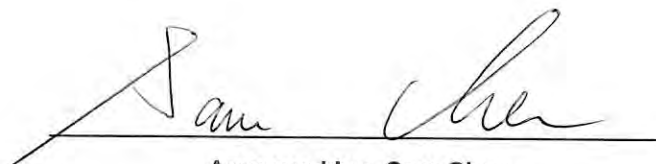

Approved by: Sam Chen

**Sporton International Inc. Hsinchu Laboratory**

No. 8, Ln. 724, Bo'ai St., Zhubei City, Hsinchu County 302010, Taiwan (R.O.C.)



## Table of Contents

**History of this test report.....3**

**Summary of Test Result.....4**

**1 General Description .....5**

1.1 Information.....5

1.2 Applicable Standards .....11

1.3 Testing Location Information .....11

1.4 Measurement Uncertainty .....11

**2 Test Configuration of EUT .....12**

2.1 Test Channel Mode .....12

2.2 The Worst Case Measurement Configuration .....13

2.3 EUT Operation during Test .....16

2.4 Accessories .....16

2.5 Support Equipment.....16

2.6 Test Setup Diagram .....18

**3 Transmitter Test Result .....21**

3.1 AC Power-line Conducted Emissions .....21

3.2 DTS Bandwidth.....23

3.3 Maximum Conducted Output Power .....24

3.4 Power Spectral Density .....26

3.5 Emissions in Non-restricted Frequency Bands .....28

3.6 Emissions in Restricted Frequency Bands.....29

**4 Test Equipment and Calibration Data .....34**

**Appendix A. Test Results of AC Power-line Conducted Emissions**

**Appendix B. Test Results of DTS Bandwidth**

**Appendix C. Test Results of Maximum Conducted Output Power**

**Appendix D. Test Results of Power Spectral Density**

**Appendix E. Test Results of Emissions in Non-restricted Frequency Bands**

**Appendix F. Test Results of Emissions in Restricted Frequency Bands**

**Appendix G. Test Photos**

**Photographs of EUT v01**



### History of this test report

<b>Report No.</b>	<b>Version</b>	<b>Description</b>	<b>Issued Date</b>
FR313002AE	01	Initial issue of report	Jun. 14, 2023
FR313002AE	02	Revising the RF General Information on section 1.1.1	Jun. 19, 2023



## Summary of Test Result

Report Clause	Ref Std. Clause	Test Items	Result (PASS/FAIL)	Remark
1.1.2	15.203	Antenna Requirement	PASS	-
3.1	15.207	AC Power-line Conducted Emissions	PASS	-
3.2	15.247(a)	DTS Bandwidth	PASS	-
3.3	15.247(b)	Maximum Conducted Output Power	PASS	-
3.4	15.247(e)	Power Spectral Density	PASS	-
3.5	15.247(d)	Emissions in Non-restricted Frequency Bands	PASS	-
3.6	15.247(d)	Emissions in Restricted Frequency Bands	PASS	-

**Conformity Assessment Condition:**

1. The test results (PASS/FAIL) with all measurement uncertainty excluded are presented against the regulation limits or in accordance with the requirements stipulated by the applicant/manufacturee who shall bear all the risks of non-compliance that may potentially occur if measurement uncertainty is taken into account.
2. The measurement uncertainty please refer to each test result in the chapter "Measurement Uncertainty".

**Disclaimer:**

1. The product specifications of the EUT presented in the test report that may affect the test assessments are declared by the manufacturer who shall take full responsibility for the authenticity.
2. The test configuration, test mode and test software were written in this test report are declared by the manufacturer.

**Reviewed by: Sam Chen****Report Producer: Vicky Huang**



# 1 General Description

## 1.1 Information

### 1.1.1 RF General Information

Frequency Range (MHz)	IEEE Std.	Ch. Frequency (MHz)	Channel Number
2400-2483.5	802.15.4	2405-2480	11-26 [16]

**<Radio 4>**

Band	Mode	BWch (MHz)	Nant
2.4-2.4835GHz	Zigbee	3	1TX/1RX

Note:

- ♦ Zigbee uses a O-QPSK (250kbps) modulation.
- ♦ BWch is the nominal channel bandwidth.



**1.1.2 Antenna Information**

Ant.	Brand	Model Name	Ant. Type	Connector	Gain (dBi)
1	CISCO	95XEAM15.G04 WIFI 2/5G_4	Dipole	I-PEX	Note2
2	CISCO	95XEAM15.G03 WIFI 2/5G_3	Dipole	I-PEX	
3	CISCO	95XEAM15.G02 WIFI 2/5G_2	Dipole	I-PEX	
4	CISCO	95XEAM15.G01 WIFI 2/5G_1	Dipole	I-PEX	
5	CISCO	95XEAM15.G05 WIFI 5/6G_1	Dipole	I-PEX	
6	CISCO	95XEAM15.G06 WIFI 5/6G_2	Dipole	I-PEX	
7	CISCO	95XEAM15.G07 WIFI 5/6G_3	Dipole	I-PEX	
8	CISCO	95XEAM15.G08 WIFI 5/6G_4	Dipole	I-PEX	
9	CISCO	95XEAM15.G10 AUX_2	Dipole	I-PEX	
10	CISCO	95XEAM15.G09 AUX_1	Dipole	I-PEX	
11	CISCO	95XEAM15.G11 IOT	Loop	I-PEX	

Ant.	Port											
	R1: WLAN 2.4GHz			R1: WLAN 5GHz UNII 1~3			R2: WLAN 5GHz UNII 2C~3/ WLAN 6GHz			R3: WLAN 2.4GHz / 5GHz UNII 1~3/ WLAN 6GHz		R4: Bluetooth/ Zigbee
	1TX	2TX	4TX	1TX	2TX	4TX	1TX	2TX	4TX	1TX/2RX	1TX	
1	-	-	3	-	-	3	-	-	-	-	-	
2	-	2	2	-	2	2	-	-	-	-	-	
3	1	1	1	1	1	1	-	-	-	-	-	
4	-	-	4	-	-	4	-	-	-	-	-	
5	-	-	-	-	-	-	-	2	2	-	-	
6	-	-	-	-	-	-	1	1	1	-	-	
7	-	-	-	-	-	-	-	-	3	-	-	
8	-	-	-	-	-	-	-	-	4	-	-	
9	-	-	-	-	-	-	-	-	-	1	-	
10	-	-	-	-	-	-	-	-	-	2	-	
11	-	-	-	-	-	-	-	-	-	-	1	

Note1: R means Radio.

Note2:

Ant.	Antenna Gain (dBi)						
	R1: WLAN 2.4GHz	R1: WLAN 5GHz UNII 1~3					
		5.2G	5.3G	5.6G	5.785G		
1	6.57	5.21	4.46	4.78	5.2		
2	4.11	4.59	4.32	4.02	4.45		
3	5.46	4.55	3.8	3.49	3.89		
4	6.55	4.84	4.48	3.62	5.02		
Ant.	R2: WLAN 5GHz UNII 2C~3/WLAN 6GHz						
	5.6G	5.785G	6.175G	6.475G	6.695G	6.995G	
	5	7.48	6.28	6.49	5.9	7.49	7.42
	6	7.11	8.01	6	4.87	7.65	8.32
	7	7.24	6.68	5.88	4.86	7.37	7.26
8	6.57	7.32	6.34	7.31	6.46	6.82	
Ant.	R3: WLAN 2.4GHz/5GHz UNII 1~3/WLAN 6GHz						
	WLAN 2.4GHz		WLAN 5GHz UNII 1~3		WLAN 6GHz		
	9	6.9		6.6		6.8	
10	6.9		6.6		6.8		
Ant.	R4: Bluetooth/Zigbee						
	11	8.8					



Note3:

Item	Directional Gain (dBi)						
	R1: WLAN 2.4GHz	R1: WLAN 5GHz UNII 1~3					
		5.2G	5.3G	5.6G	5.785G		
2T1S	5.49	5.02	4.37	4.05	4.48		
2T2S	5.46	4.59	4.32	4.02	4.45		
4T1S	8.71	8.02	7.47	6.91	7.51		
4T2S	6.57	5.21	4.48	4.78	5.2		
4T4S	6.57	5.21	4.48	4.78	5.2		
Item	R2: WLAN 5GHz UNII 2C~3/WLAN 6GHz						
	5.6G	5.785G	6.175G	6.475G	6.695G	6.995G	
2T1S	7.66	8.11	6.51	6.24	7.67	8.38	
2T2S	7.48	8.01	6.49	5.9	7.65	8.32	
4T1S	9.91	10.4	9.21	9.03	10.32	10.71	
4T2S	7.48	8.01	6.49	7.31	7.65	8.32	
4T4S	7.48	8.01	6.49	7.31	7.65	8.32	

Note4: 80+80MHz Directional gain information

Type	Maximum Output Power	Power Spectral Density
Non-BF	Directional gain = Max.gain + array gain. For power measurements on IEEE 802.11 devices Array Gain = 0 dB (i.e., no array gain) for N ANT ≤ 4	$DirectionalGain = 10 \cdot \log \left[ \frac{\sum_{j=1}^{N_{ANT}} \left( \sum_{k=1}^{N_{ANT}} g_{j,k} \right)^2}{N_{ANT}} \right]$
BF	$DirectionalGain = 10 \cdot \log \left[ \frac{\sum_{j=1}^{N_{ANT}} \left( \sum_{k=1}^{N_{ANT}} g_{j,k} \right)^2}{N_{ANT}} \right]$	$DirectionalGain = 10 \cdot \log \left[ \frac{\sum_{j=1}^{N_{ANT}} \left( \sum_{k=1}^{N_{ANT}} g_{j,k} \right)^2}{N_{ANT}} \right]$

Ex.

Directional Gain (NSS1) formula:

$$DirectionalGain = 10 \cdot \log \left[ \frac{\sum_{j=1}^{N_{ANT}} \left( \sum_{k=1}^{N_{ANT}} g_{j,k} \right)^2}{N_{ANT}} \right]$$

NSS1(g1,1) = 10<sup>G1/20</sup> ; NSS1(g1,2) = 10<sup>G2/20</sup> ; NSS1(g1,3) = 10<sup>G3/20</sup> ; NSS1(g1,4) = 10<sup>G4/20</sup>

g<sub>j,k</sub> = (NSS1(g1,1) + NSS1(g1,2) + NSS1(g1,3) + NSS1(g1,4))<sup>2</sup>

DG = 10 log[(NSS1(g1,1) + NSS1(g1,2) + NSS1(g1,3) + NSS1(g1,4))<sup>2</sup> / N<sub>ANT</sub>] => 10

log[(10<sup>G1/20</sup> + 10<sup>G2/20</sup> + 10<sup>G3/20</sup> + 10<sup>G4/20</sup>)<sup>2</sup> / N<sub>ANT</sub>]

Where ;

For 80+80

5G Band1 G1 = 5.21 dBi; G2 = 4.59 dBi; G3 = 4.55 dBi; G4 = 4.84 dB

5G Band2 G1 = 4.46 dBi; G2 = 4.32 dBi; G3 = 3.80 dBi; G4 = 4.48 dBi

5G Band3 G1 = 4.78 dBi; G2 = 4.02 dBi; G3 = 3.49 dBi; G4 = 3.62 dBi

For 2T1S

5G Band1 DG = 4.55 dBi

5G Band2 DG = 4.48 dBi

For 4T1S

5G Band1 DG = 7.58 dBi

5G Band2 DG = 7.48 dBi

For 2T2S

5G Band3 DG = 3.62 dBi

For 4T2S

5G Band3 DG = 7.01 dBi



Note5: The above information (except gain of Radio 1 and Radio 2) was declared by manufacturer.  
Note6: Radio 1 (WLAN 2.4/5GHz UNII 1~3(except 80+80MHz)), Radio 2 (5GHz UNII 2C~3/6GHz UNII 5~8): The directional gain is measured which follows the procedure of KDB 662911 D03.  
Radio 1 (5GHz UNII 1~2C(80+80MHz)): Maximum Directional Gain following KDB662911 D01

Note7: The EUT has eleven antennas.

**For WLAN 2.4GHz function (Radio 1):**

**For IEEE 802.11b/g/n/VHT/ax mode (1TX,2TX,4TX/4RX):**

For 1TX

Only Port 1 can be use as transmitting antenna.

For 2TX

Only Port 1 and Port 2 can be use as transmitting antenna.

Port 1 and Port 2 could transmit simultaneously.

For 4TX

Port 1, Port 2, Port 3 and Port 4 can be use as transmitting antenna.

Port 1, Port 2, Port 3 and Port 4 could transmit simultaneously.

For 4RX

Port 1, Port 2, Port 3 and Port 4 can be used as receiving antennas.

Port 1, Port 2, Port 3 and Port 4 could receive simultaneously.

**For WLAN 5GHz function (Radio 1 and Radio 2):**

**For IEEE 802.11a/n/ac/ax mode (1TX,2TX,4TX/4RX):**

For 1TX

Only Port 1 can be use as transmitting antenna.

For 2TX

Only Port 1 and Port 2 can be use as transmitting antenna.

Port 1 and Port 2 could transmit simultaneously.

For 4TX

Port 1, Port 2, Port 3 and Port 4 can be use as transmitting antenna.

Port 1, Port 2, Port 3 and Port 4 could transmit simultaneously.

For Radio 1 80+80MHz 2TX

Only Port 1 and Port 4 can be use as transmitting antenna.

Port 1 and Port 4 could transmit simultaneously.

For 4RX

Port 1, Port 2, Port 3 and Port 4 can be used as receiving antennas.

Port 1, Port 2, Port 3 and Port 4 could receive simultaneously.

**For WLAN 6GHz UNII 5~8 (Radio 2):**

**For IEEE 802.11ax mode (1TX,2TX,4TX/4RX):**

For 1TX

Only Port 1 can be use as transmitting antenna.

For 2TX

Only Port 1 and Port 2 can be use as transmitting antenna.

Port 1 and Port 2 could transmit simultaneously.

For 4TX

Port 1, Port 2, Port 3 and Port 4 can be use as transmitting antenna.

Port 1, Port 2, Port 3 and Port 4 could transmit simultaneously.

For 4RX

Port 1, Port 2, Port 3 and Port 4 can be used as receiving antennas.

Port 1, Port 2, Port 3 and Port 4 could receive simultaneously.

**For Scanning Radio 3:**

**For WLAN 2.4GHz function**

**For 802.11b/g/n/VHT/ax mode (1TX/2RX):**

For 1TX

Only Port 1 can be use as transmitting antenna.

For 2RX

Port 1 and Port 2 can be used as receiving antennas.

Port 1 and Port 2 could receive simultaneously.





**For WLAN 5GHz function**

**For IEEE 802.11a/n/ac/ax mode (1TX/2RX):**

For 1TX

Only Port 1 can be use as transmitting antenna.

For 2RX

Port 1 and Port 2 can be used as receiving antennas.

Port 1 and Port 2 could receive simultaneously.

**For WLAN 6GHz UNII 5~8:**

**For IEEE 802.11ax mode (1TX/2RX):**

For 1TX

Only Port 1 can be use as transmitting antenna.

For 2RX

Port 1 and Port 2 can be used as receiving antennas.

Port 1 and Port 2 could receive simultaneously.

**For Bluetooth/Zigbee function (Radio 4):**

**For Bluetooth/Zigbee mode (1TX/1RX):**

Only Port 1 can be used as transmitting/receiving antenna.

**1.1.3 Mode Test Duty Cycle**

Mode	DC	DCF(dB)	T(s)	VBW(Hz) ≥ 1/T
Zigbee	1	0	n/a (DC>=0.98)	n/a (DC>=0.98)

Note:

- ◆ DC is Duty Cycle.
- ◆ DCF is Duty Cycle Factor.

**1.1.4 EUT Operational Condition**

<b>EUT Power Type</b>	From Power Adapter or PoE		
<b>Function</b>	<input checked="" type="checkbox"/> Point-to-multipoint	<input type="checkbox"/> Point-to-point	
<b>Test Software Version</b>	Tera Term V4.75		

Note: The above information was declared by manufacturer.

**1.1.5 Table for Multiple Listing**

Model Name	SW	R1: 2.4GHz	R1: 5GHz Low Band or R1: 5GHz Full Band	R2: 5GHz High Band or 6GHz	R3: 2.4GHz/ 5GHz/6GHz	R4: Bluetooth or Zigbee
CW9166D1-B	Cisco	V	V (With 80+80MHz)	V	V	V (Disable Zigbee function by SW)
CW9166D1-MR	Meraki	V	V (Without 80+80MHz)	V	V	V

Note1: From the above models, model: CW9166D1-MR was selected as representative model for the test and its data was recorded in this report.

Note2: The above information was declared by manufacturer.



**1.1.6 Table for Radio function**

Radio \ Function	WLAN 2.4GHz	WLAN 5GHz UNII 1~2A	WLAN 5GHz UNII 2C~3	WLAN 6GHz	Bluetooth	Zigbee
1 (Iron Radio)	V	V	V	-	-	-
2 (Pine Radio)	-	-	V	V	-	-
3 (Scanning Radio)	V	V	V	V	-	-
4	-	-	-	-	V	V

Note1: The above information was declared by manufacturer.

Note2: For WLAN 2.4GHz: The Radio 1 and Radio 3 can't operate at the same frequency.

For WLAN 5GHz: The Radio 1 ~ 3 can't operate at the same frequency.

For WLAN 6GHz: The Radio 2 ~ 3 can't operate at the same frequency simultaneously.

**1.1.7 Table for EUT Operation Function**

Mode	Operation Function
1	R1: 2.4GHz/5GHz Low Band+R2: 5GHz High band+R3: 2.4GHz+R4: Bluetooth
2	R1: 2.4GHz/5GHz Low Band+R2: 5GHz High band+R3: 5GHz+R4: Bluetooth
3	R1: 2.4GHz/5GHz Low Band+R2: 5GHz High band+R3: 6GHz+R4: Bluetooth
4	R1: 2.4GHz/5GHz Full Band+R2: 6GHz+R3: 2.4GHz+R4: Bluetooth
5	R1: 2.4GHz/5GHz Full Band+R2: 6GHz+R3: 5GHz+R4: Bluetooth
6	R1: 2.4GHz/5GHz Full Band+R2: 6GHz+R3: 6GHz+R4: Bluetooth
7	R1: 2.4GHz/5GHz Low Band+R2: 5GHz High band+R3: 2.4GHz+R4: Zigbee
8	R1: 2.4GHz/5GHz Low Band+R2: 5GHz High band+R3: 5GHz+R4: Zigbee
9	R1: 2.4GHz/5GHz Low Band+R2: 5GHz High band+R3: 6GHz+R4: Zigbee
10	R1: 2.4GHz/5GHz Full Band+R2: 6GHz+R3: 2.4GHz+R4: Zigbee
11	R1: 2.4GHz/5GHz Full Band+R2: 6GHz+R3: 5GHz+R4: Zigbee
12	R1: 2.4GHz/5GHz Full Band+R2: 6GHz+R3: 6GHz+R4: Zigbee

Note: The above information was declared by manufacturer.



## 1.2 Applicable Standards

According to the specifications of the manufacturer, the EUT must comply with the requirements of the following standards:

- ◆ 47 CFR FCC Part 15.247
- ◆ ANSI C63.10-2013

The following reference test guidance is not within the scope of accreditation of TAF.

- ◆ FCC KDB 558074 D01 v05r02
- ◆ FCC KDB 414788 D01 v01r01

## 1.3 Testing Location Information

Testing Location Information	
Test Lab. : Sporton International Inc. Hsinchu Laboratory	
Hsinchu	ADD: No.8, Ln. 724, Bo'ai St., Zhubei City, Hsinchu County 302010, Taiwan (R.O.C.)
(TAF: 3787)	TEL: 886-3-656-9065 FAX: 886-3-656-9085
Test site Designation No. TW3787 with FCC.	
Conformity Assessment Body Identifier (CABID) TW3787 with ISED.	

Test Condition	Test Site No.	Test Engineer	Test Environment (°C / %)	Test Date
RF Conducted	TH03-CB	Gino Huang	22.6~24.3 / 59~63	Mar. 23, 2023~ Apr. 26, 2023
Radiated for below 1GHz	10CH01-CB	Elvin Yeh	23~24 / 56~57	Apr. 21, 2023
Radiated for above 1GHz-cabinet	03CH06-CB	Richard Pai	21.7~22.8 / 56~59	Mar. 13, 2023~ May 08, 2023
AC Conduction	CO01-CB	Summer Li	22~23 / 53~54	Apr. 21, 2023~ Apr. 24, 2023

## 1.4 Measurement Uncertainty

ISO/IEC 17025 requires that an estimate of the measurement uncertainties associated with the emissions test results be included in the report. The measurement uncertainties given below are based on a 95% confidence level (based on a coverage factor (k=2))

Test Items	Uncertainty	Remark
Conducted Emission (150kHz ~ 30MHz)	3.4 dB	Confidence levels of 95%
Radiated Emission (9kHz ~ 30MHz)	5.0 dB	Confidence levels of 95%
Radiated Emission (30MHz ~ 1,000MHz)	5.4 dB	Confidence levels of 95%
Radiated Emission (1GHz ~ 18GHz)	5.2 dB	Confidence levels of 95%
Radiated Emission (18GHz ~ 40GHz)	4.7 dB	Confidence levels of 95%
Conducted Emission	3.2 dB	Confidence levels of 95%
Output Power Measurement	0.8 dB	Confidence levels of 95%
Power Density Measurement	3.2 dB	Confidence levels of 95%
Bandwidth Measurement	2.0 %	Confidence levels of 95%



## 2 Test Configuration of EUT

### 2.1 Test Channel Mode

<Radio 4>

Mode	Power Setting
Zigbee	-
2405MHz	13
2440MHz	20
2475MHz	17
2480MHz	5



## 2.2 The Worst Case Measurement Configuration

The Worst Case Mode for Following Conformance Tests	
<b>Tests Item</b>	AC power-line conducted emissions
<b>Condition</b>	AC power-line conducted measurement for line and neutral Test Voltage: 120Vac / 60Hz
<b>Operating Mode</b>	Normal Link(WLAN and Bluetooth), CTX(Zigbee)
1	R1: 2.4GHz/5GHz Low Band+R2: 5GHz High band+R3: 2.4GHz+R4: Bluetooth+Adapter
2	R1: 2.4GHz/5GHz Low Band+R2: 5GHz High band+R3: 5GHz+R4: Bluetooth+Adapter
3	R1: 2.4GHz/5GHz Low Band+R2: 5GHz High band+R3: 6GHz+R4: Bluetooth+Adapter
4	R1: 2.4GHz/5GHz Full Band+R2: 6GHz+R3: 2.4GHz+R4: Bluetooth+Adapter
5	R1: 2.4GHz/5GHz Full Band+R2: 6GHz+R3: 5GHz+R4: Bluetooth+Adapter
6	R1: 2.4GHz/5GHz Full Band+R2: 6GHz+R3: 6GHz+R4: Bluetooth+Adapter
7	R1: 2.4GHz/5GHz Low Band+R2: 5GHz High band+R3: 2.4GHz+R4: Zigbee+Adapter
8	R1: 2.4GHz/5GHz Low Band+R2: 5GHz High band+R3: 5GHz+R4: Zigbee+Adapter
9	R1: 2.4GHz/5GHz Low Band+R2: 5GHz High band+R3: 6GHz+R4: Zigbee+Adapter
10	R1: 2.4GHz/5GHz Full Band+R2: 6GHz+R3: 2.4GHz+R4: Zigbee+Adapter
11	R1: 2.4GHz/5GHz Full Band+R2: 6GHz+R3: 5GHz+R4: Zigbee+Adapter
12	R1: 2.4GHz/5GHz Full Band+R2: 6GHz+R3: 6GHz+R4: Zigbee+Adapter
Mode 7 has been evaluated to be the worst case among Mode 1~12, thus measurement for Mode 13~17 will follow this same test mode.	
13	R1: 2.4GHz/5GHz Low Band+R2: 5GHz High band+R3: 2.4GHz+R4: Zigbee+PoE1
14	R1: 2.4GHz/5GHz Low Band+R2: 5GHz High band+R3: 2.4GHz+R4: Zigbee+PoE2
15	R1: 2.4GHz/5GHz Low Band+R2: 5GHz High band+R3: 2.4GHz+R4: Zigbee+PoE3
16	R1: 2.4GHz/5GHz Low Band+R2: 5GHz High band+R3: 2.4GHz+R4: Zigbee+PoE4
17	R1: 2.4GHz/5GHz Low Band+R2: 5GHz High band+R3: 2.4GHz+R4: Zigbee+PoE5
For operating mode 13 is the worst case and it was record in this test report.	

The Worst Case Mode for Following Conformance Tests	
<b>Tests Item</b>	DTS Bandwidth Maximum Conducted Output Power Power Spectral Density Emissions in Non-restricted Frequency Bands
<b>Test Condition</b>	Conducted measurement at transmit chains
1	R4: 1T1S



The Worst Case Mode for Following Conformance Tests	
<b>Tests Item</b>	Emissions in Restricted Frequency Bands
<b>Test Condition</b>	Radiated measurement If EUT consist of multiple antenna assembly (multiple antenna are used in EUT regardless of spatial multiplexing MIMO configuration), the radiated test should be performed with highest antenna gain of each antenna type.
<b>Operating Mode &lt; 1GHz</b>	Normal Link(WLAN and Bluetooth), CTX(Zigbee)
1	EUT in Z axis-R1: 2.4GHz/5GHz Low Band+R2: 5GHz High band+R3: 2.4GHz+R4: Bluetooth+Adapter
2	EUT in Y axis-R1: 2.4GHz/5GHz Low Band+R2: 5GHz High band+R3: 2.4GHz+R4: Bluetooth+Adapter
3	EUT in X axis-R1: 2.4GHz/5GHz Low Band+R2: 5GHz High band+R3: 2.4GHz+R4: Bluetooth+Adapter
Mode 1 has been evaluated to be the worst case among Mode 1~3, thus measurement for Mode 4 ~ 14 will follow this same test mode.	
4	EUT in Z axis-R1: 2.4GHz/5GHz Low Band+R2: 5GHz High band+R3: 5GHz+R4: Bluetooth+Adapter
5	EUT in Z axis-R1: 2.4GHz/5GHz Low Band+R2: 5GHz High band+R3: 6GHz+R4: Bluetooth+Adapter
6	EUT in Z axis-R1: 2.4GHz/5GHz Full Band+R2: 6GHz+R3: 2.4GHz+R4: Bluetooth +Adapter
7	EUT in Z axis-R1: 2.4GHz/5GHz Full Band+R2: 6GHz+R3: 5GHz+R4: Bluetooth +Adapter
8	EUT in Z axis-R1: 2.4GHz/5GHz Full Band+R2: 6GHz+R3: 6GHz+R4: Bluetooth +Adapter
9	EUT in Z axis-R1: 2.4GHz/5GHz Low Band+R2: 5GHz High band+R3: 2.4GHz+R4: Zigbee +Adapter
10	EUT in Z axis-R1: 2.4GHz/5GHz Low Band+R2: 5GHz High band+R3: 5GHz+R4: Zigbee +Adapter
11	EUT in Z axis-R1: 2.4GHz/5GHz Low Band+R2: 5GHz High band+R3: 6GHz+R4: Zigbee +Adapter
12	EUT in Z axis-R1: 2.4GHz/5GHz Full Band+R2: 6GHz+R3: 2.4GHz+R4: Zigbee +Adapter
13	EUT in Z axis-R1: 2.4GHz/5GHz Full Band+R2: 6GHz+R3: 5GHz+R4: Zigbee+Adapter
14	EUT in Z axis-R1: 2.4GHz/5GHz Full Band+R2: 6GHz+R3: 6GHz+R4: Zigbee+Adapter
Mode 12 has been evaluated to be the worst case among Mode 1~14, thus measurement for Mode 15 ~ 19 will follow this same test mode.	
15	EUT in Z axis-R1: 2.4GHz/5GHz Full Band+R2: 6GHz+R3: 2.4GHz+R4: Zigbee+PoE1
16	EUT in Z axis-R1: 2.4GHz/5GHz Full Band+R2: 6GHz+R3: 2.4GHz+R4: Zigbee+PoE2
17	EUT in Z axis-R1: 2.4GHz/5GHz Full Band+R2: 6GHz+R3: 2.4GHz+R4: Zigbee+PoE3
18	EUT in Z axis-R1: 2.4GHz/5GHz Full Band+R2: 6GHz+R3: 2.4GHz+R4: Zigbee+PoE4
19	EUT in Z axis-R1: 2.4GHz/5GHz Full Band+R2: 6GHz+R3: 2.4GHz+R4: Zigbee+PoE5
For operating mode 12 is the worst case and it was record in this test report.	



The Worst Case Mode for Following Conformance Tests	
<b>Tests Item</b>	Emissions in Restricted Frequency Bands
<b>Test Condition</b>	Conducted measurement at transmit chains
<b>Operating Mode &gt; 1GHz</b>	CTX(Harmonic and bandedge)
1	R4: 1T1S
<b>Test Condition</b>	Radiated measurement If EUT consist of multiple antenna assembly (multiple antenna are used in EUT regardless of spatial multiplexing MIMO configuration), the radiated test should be performed with highest antenna gain of each antenna type.
<b>Operating Mode &gt; 1GHz</b>	CTX(Cabinet)
After evaluating, and the worst case was found as below. So the measurement will follow this same test configuration.	
1	R4: 1T1S_EUT in Z axis

The Worst Case Mode for Following Conformance Tests	
<b>Tests Item</b>	Simultaneous Transmission Analysis - Co-location RF Exposure Evaluation
<b>Operating Mode</b>	
1	R1: 2.4GHz/5GHz Low Band+R2: 5GHz High band+R3: 2.4GHz+R4: Bluetooth
2	R1: 2.4GHz/5GHz Low Band+R2: 5GHz High band+R3: 5GHz+R4: Bluetooth
3	R1: 2.4GHz/5GHz Low Band+R2: 5GHz High band+R3: 6GHz+R4: Bluetooth
4	R1: 2.4GHz/5GHz Full Band+R2: 6GHz+R3: 2.4GHz+R4: Bluetooth
5	R1: 2.4GHz/5GHz Full Band+R2: 6GHz+R3: 5GHz+R4: Bluetooth
6	R1: 2.4GHz/5GHz Full Band+R2: 6GHz+R3: 6GHz+R4: Bluetooth
7	R1: 2.4GHz/5GHz Low Band+R2: 5GHz High band+R3: 2.4GHz+R4: Zigbee
8	R1: 2.4GHz/5GHz Low Band+R2: 5GHz High band+R3: 5GHz+R4: Zigbee
9	R1: 2.4GHz/5GHz Low Band+R2: 5GHz High band+R3: 6GHz+R4: Zigbee
10	R1: 2.4GHz/5GHz Full Band+R2: 6GHz+R3: 2.4GHz+R4: Zigbee
11	R1: 2.4GHz/5GHz Full Band+R2: 6GHz+R3: 5GHz+R4: Zigbee
12	R1: 2.4GHz/5GHz Full Band+R2: 6GHz+R3: 6GHz+R4: Zigbee
Refer to Sporton Test Report No.: FA313002 for Co-location RF Exposure Evaluation.	



Note: The Adapter and PoEs are for measurement only, would not be marketed.

Adapter and PoEs information as below:

Power	Brand	Model
Adapter	UMEC	MA-PWR-50WAC
PoE 1	PHIHONG	POEA33U-1ATE (MA-INJ-4)
PoE 2	PHIHONG	POE60U-1BT-X (MA-INJ-6)
PoE 3	Delta	ADH-65AR B (AIR-PWRINJ7)
PoE 4	Microchip	PD-9001GR/AT/AC (AIR-PWRINJ6)
PoE 5	PHIHONG	POE29U-1AT (AIR-PWRINJ6)

### 2.3 EUT Operation during Test

For CTX Mode:  
The EUT was programmed to be in continuously transmitting mode.

For Normal Link Mode:  
During the test, the EUT operation to normal function.

### 2.4 Accessories

Wall-mounted rack\*1

### 2.5 Support Equipment

For AC Conduction:

Support Equipment				
No.	Equipment	Brand Name	Model Name	FCC ID
A	PoE IN LAN PC	DELL	T3400	N/A
B	6G Client	CISCO	CM66D	N/A
C	6G NB	DELL	PP13S	N/A
D	5G NB	DELL	PP13S	N/A
E	2.4G NB	DELL	PP13S	N/A
F	Flash disk3.0	TDK	TF30	N/A
G	PoE 1	PHIHONG	POEA33U-1ATE (MA-INJ-4)	N/A





**For Radiated (below 1GHz):**

<b>Support Equipment</b>				
<b>No.</b>	<b>Equipment</b>	<b>Brand Name</b>	<b>Model Name</b>	<b>FCC ID</b>
A	LAN PC	DELL	T3400	N/A
B	6G Client	CISCO	CM66D	N/A
C	6G NB	DELL	PP13S	N/A
D	2.4G NB	DELL	PP13S	N/A
E	5G NB	DELL	PP13S	N/A
F	Flash disk3.0	TDK	TF30	N/A
G	Adapter	UMEC	MA-PWR-50WAC	N/A

**For Radiated (above 1GHz)-Cabinet and RF Conducted:**

<b>Support Equipment</b>				
<b>No.</b>	<b>Equipment</b>	<b>Brand Name</b>	<b>Model Name</b>	<b>FCC ID</b>
A	NB	DELL	E4300	N/A
B	PoE 5	PHIHONG	POE29U-1AT (AIR-PWRINJ6)	N/A

## 2.6 Test Setup Diagram

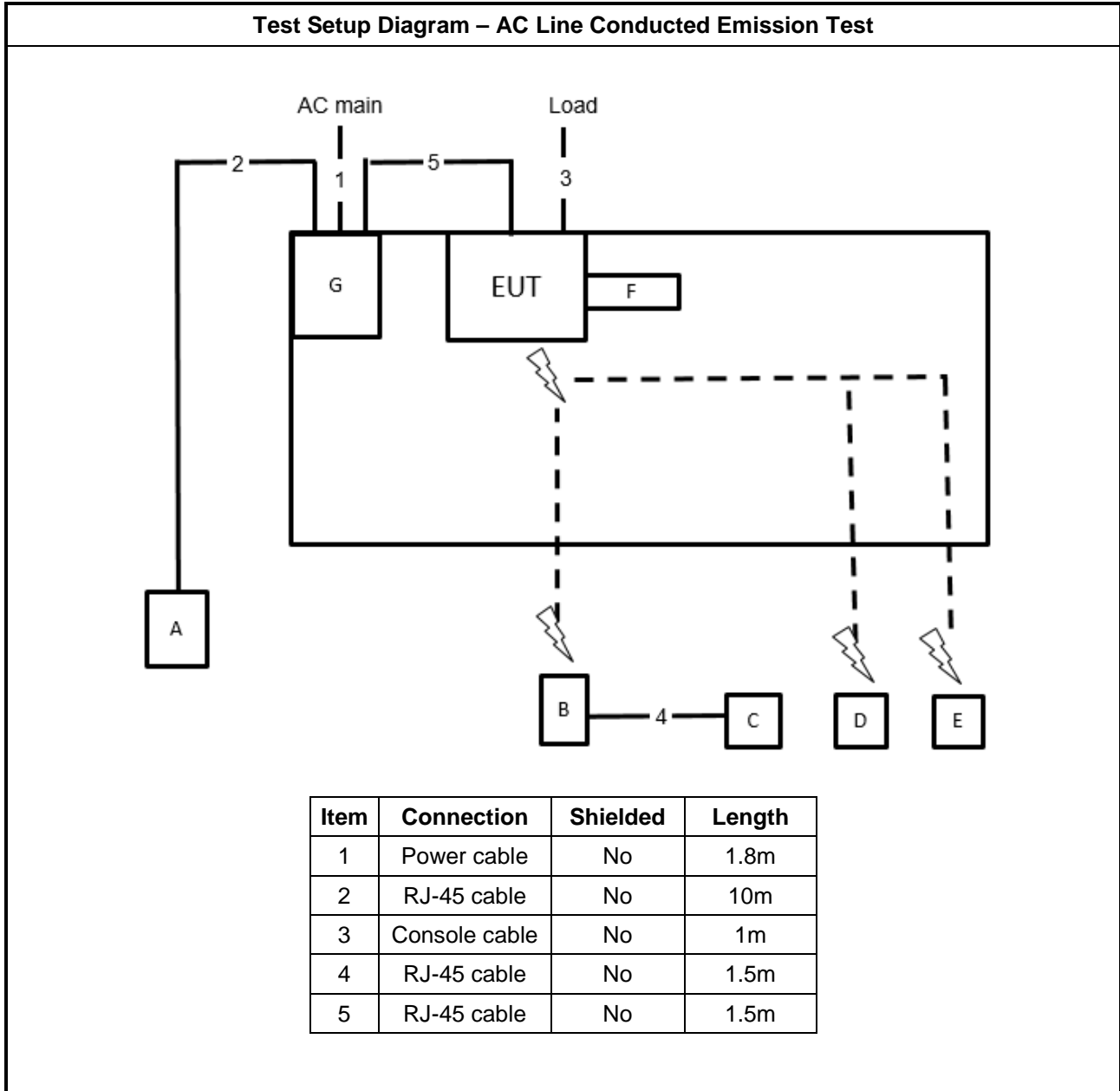

**Test Setup Diagram - Radiated Test < 1GHz**

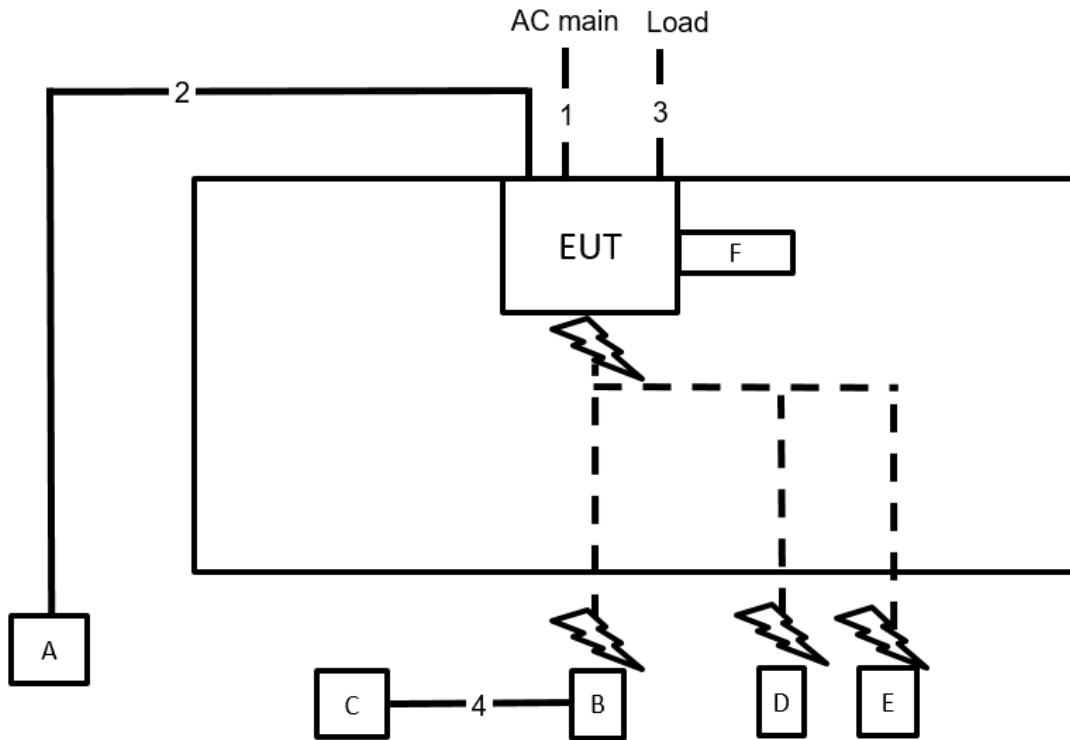

Item	Connection	Shielded	Length
1	Power cable	No	3.6m
2	RJ-45 cable	No	10m
3	Console cable	No	1m
4	RJ-45 cable	No	1.5m

**Test Setup Diagram - Radiated Test > 1GHz for Cabinet**

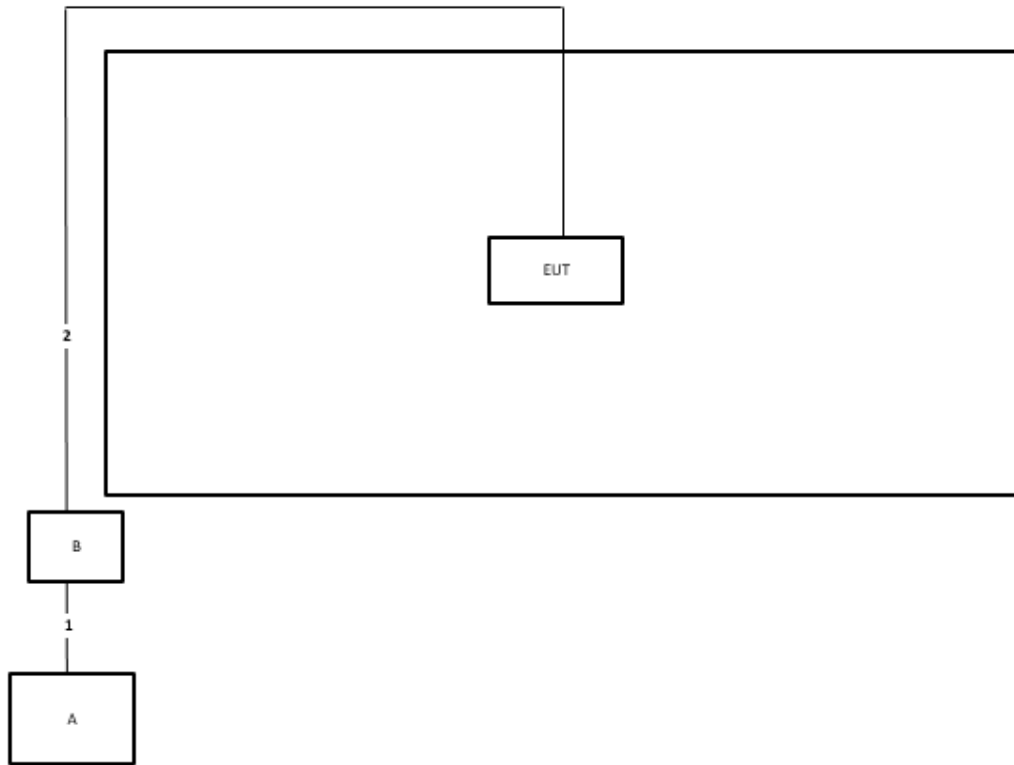

Item	Connection	Shielded	Length
1	RJ-45 cable	No	10m
2	RJ-45 cable	No	1.5m



### 3 Transmitter Test Result

#### 3.1 AC Power-line Conducted Emissions

##### 3.1.1 AC Power-line Conducted Emissions Limit

AC Power-line Conducted Emissions Limit		
Frequency Emission (MHz)	Quasi-Peak	Average
0.15-0.5	66 - 56 *	56 - 46 *
0.5-5	56	46
5-30	60	50

Note 1: \* Decreases with the logarithm of the frequency.

##### 3.1.2 Measuring Instruments

Refer a test equipment and calibration data table in this test report.

##### 3.1.3 Test Procedures

Test Method
<input checked="" type="checkbox"/> Refer as ANSI C63.10-2013, clause 6.2 for AC power-line conducted emissions.

### 3.1.4 Test Setup

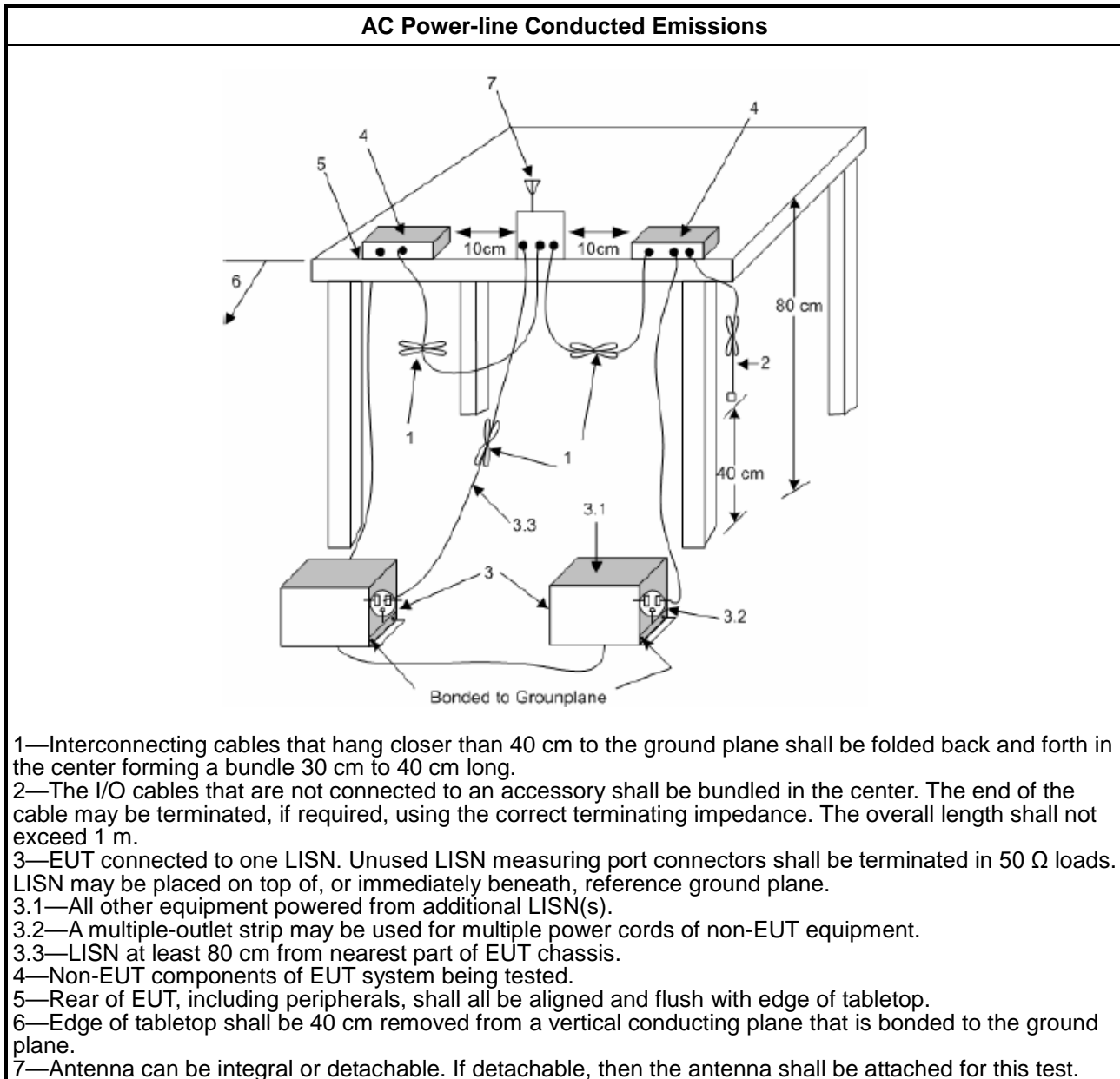

### 3.1.5 Measurement Results Calculation

The measured Level is calculated using:

- a. Corrected Reading: LISN Factor (LISN) + Attenuator (AT/AUX) + Cable Loss (CL) + Read Level (Raw) = Level
- b. Margin = -Limit + Level

### 3.1.6 Test Result of AC Power-line Conducted Emissions

Refer as Appendix A

### 3.2 DTS Bandwidth

#### 3.2.1 6dB Bandwidth Limit

6dB Bandwidth Limit
<b>Systems using digital modulation techniques:</b>
<ul style="list-style-type: none"> <li>▪ 6 dB bandwidth <math>\geq</math> 500 kHz.</li> </ul>

#### 3.2.2 Measuring Instruments

Refer a test equipment and calibration data table in this test report.

#### 3.2.3 Test Procedures

Test Method
<ul style="list-style-type: none"> <li>▪ For the emission bandwidth shall be measured using one of the options below:</li> </ul>
<input checked="" type="checkbox"/> Refer as FCC KDB 558074, clause 8.2 & C63.10 clause 11.8.1 Option 1 for 6 dB bandwidth measurement.
<input type="checkbox"/> Refer as FCC KDB 558074, clause 8.2 & C63.10 clause 11.8.2 Option 2 for 6 dB bandwidth measurement.
<input type="checkbox"/> Refer as ANSI C63.10, clause 6.9.1 for occupied bandwidth testing.

#### 3.2.4 Test Setup

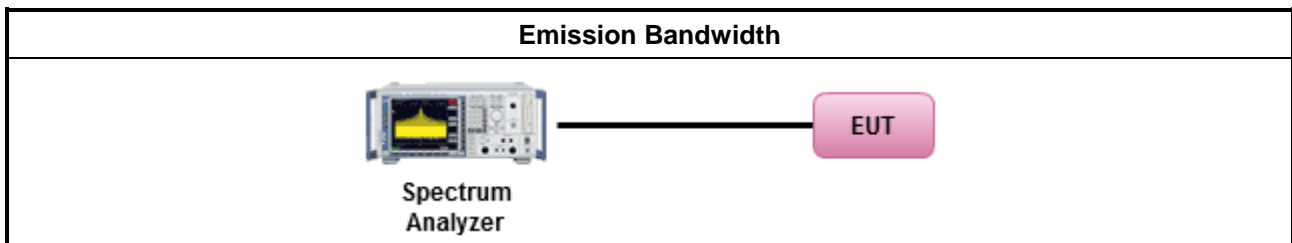

#### 3.2.5 Test Result of Emission Bandwidth

Refer as Appendix B



### 3.3 Maximum Conducted Output Power

#### 3.3.1 Maximum Conducted Output Power Limit

Maximum Conducted Output Power Limit	
	<ul style="list-style-type: none"> <li>▪ If <math>G_{TX} \leq 6</math> dBi, then <math>P_{Out} \leq 30</math> dBm (1 W)</li> </ul>
	<ul style="list-style-type: none"> <li>▪ Point-to-multipoint systems (P2M): If <math>G_{TX} &gt; 6</math> dBi, then <math>P_{Out} = 30 - (G_{TX} - 6)</math> dBm</li> </ul>
	<ul style="list-style-type: none"> <li>▪ Point-to-point systems (P2P): If <math>G_{TX} &gt; 6</math> dBi, then <math>P_{Out} = 30 - (G_{TX} - 6)/3</math> dBm</li> </ul>
	<ul style="list-style-type: none"> <li>▪ Smart antenna system (SAS):</li> </ul>
	<ul style="list-style-type: none"> <li>- Single beam: If <math>G_{TX} &gt; 6</math> dBi, then <math>P_{Out} = 30 - (G_{TX} - 6)/3</math> dBm</li> </ul>
	<ul style="list-style-type: none"> <li>- Overlap beam: If <math>G_{TX} &gt; 6</math> dBi, then <math>P_{Out} = 30 - (G_{TX} - 6)/3</math> dBm</li> </ul>
	<ul style="list-style-type: none"> <li>- Aggregate power on all beams: If <math>G_{TX} &gt; 6</math> dBi, then <math>P_{Out} = 30 - (G_{TX} - 6)/3 + 8</math> dB dBm</li> </ul>
$P_{Out}$ = maximum peak conducted output power or maximum conducted output power in dBm, $G_{TX}$ = the maximum transmitting antenna directional gain in dBi.	

#### 3.3.2 Measuring Instruments

Refer a test equipment and calibration data table in this test report.

#### 3.3.3 Test Procedures

Test Method	
	<ul style="list-style-type: none"> <li>▪ Maximum Peak Conducted Output Power</li> </ul>
	<input type="checkbox"/> Refer as FCC KDB 558074, clause 8.3.1.1 & C63.10 clause 11.9.1.1 (RBW $\geq$ EBW method).
	<input type="checkbox"/> Refer as FCC KDB 558074, clause 8.3.1.3 & C63.10 clause 11.9.1.3 (peak power meter).
	<ul style="list-style-type: none"> <li>▪ Maximum Conducted Output Power</li> </ul>
	[duty cycle $\geq$ 98% or external video / power trigger]
	<input type="checkbox"/> Refer as FCC KDB 558074, clause 8.3.2.2 & C63.10 clause 11.9.2.2.2 Method AVGSA-1.
	<input type="checkbox"/> Refer as FCC KDB 558074, clause 8.3.2.2 & C63.10 clause 11.9.2.2.3 Method AVGSA-1A. (alternative)
	duty cycle < 98% and average over on/off periods with duty factor
	<input type="checkbox"/> Refer as FCC KDB 558074, clause 8.3.2.2 & C63.10 clause 11.9.2.2.4 Method AVGSA-2.
	<input type="checkbox"/> Refer as FCC KDB 558074, clause 8.3.2.2 & C63.10 clause 11.9.2.2.5 Method AVGSA-2A (alternative)
	<input type="checkbox"/> Refer as FCC KDB 558074, clause 8.3.2.2 & C63.10 clause 11.9.2.2.6 Method AVGSA-3
	<input type="checkbox"/> Refer as FCC KDB 558074, clause 8.3.2.2 & C63.10 clause 11.9.2.2.7 Method AVGSA-3A (alternative)
	Measurement using a power meter (PM)
	<input type="checkbox"/> Refer as FCC KDB 558074, clause 8.3.2.3 & C63.10 clause 11.9.2.3.1 Method AVGPM (using an RF average power meter).
	<input checked="" type="checkbox"/> Refer as FCC KDB 558074, clause 8.3.2.3 & C63.10 clause 11.9.2.3.2 Method AVGPM-G (using an gate RF average power meter).



- For conducted measurement.
  - If the EUT supports multiple transmit chains using options given below:  
Refer as FCC KDB 662911, In-band power measurements. Using the measure-and-sum approach, measured all transmit ports individually. Sum the power (in linear power units e.g., mW) of all ports for each individual sample and save them.
  - If multiple transmit chains, EIRP calculation could be following as methods:  

$$P_{total} = P_1 + P_2 + \dots + P_n$$
 (calculated in linear unit [mW] and transfer to log unit [dBm])  

$$EIRP_{total} = P_{total} + DG$$

### 3.3.4 Test Setup

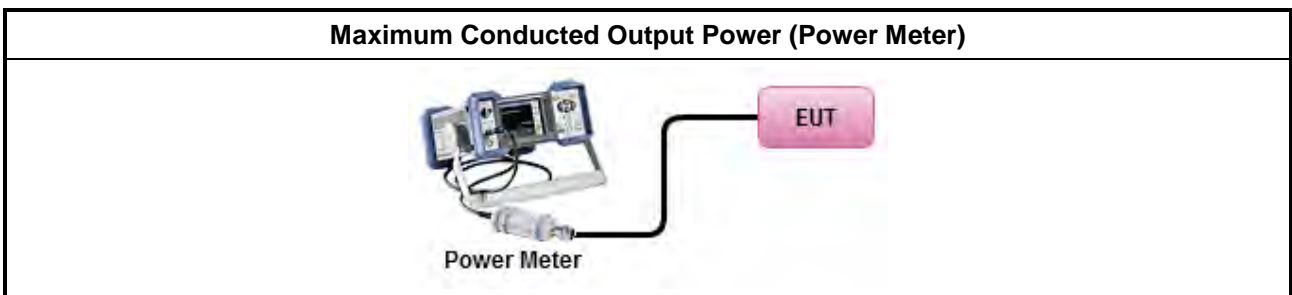

### 3.3.5 Test Result of Maximum Conducted Output Power

Refer as Appendix C



### 3.4 Power Spectral Density

#### 3.4.1 Power Spectral Density Limit

Power Spectral Density Limit
<ul style="list-style-type: none"> <li>Power Spectral Density (PSD) <math>\leq</math> 8 dBm/3kHz</li> </ul>

#### 3.4.2 Measuring Instruments

Refer a test equipment and calibration data table in this test report.

#### 3.4.3 Test Procedures

Test Method
<ul style="list-style-type: none"> <li>Peak power spectral density procedures that the same method as used to determine the conducted output power. If maximum peak conducted output power was measured to demonstrate compliance to the output power limit, then the peak PSD procedure below (Method PKPSD) shall be used. If maximum conducted output power was measured to demonstrate compliance to the output power limit, then one of the average PSD procedures shall be used, as applicable based on the following criteria (the peak PSD procedure is also an acceptable option).</li> </ul>
<input checked="" type="checkbox"/> Refer as FCC KDB 558074, clause 8.4 & C63.10 clause 11.10 Method Max. PSD.
<ul style="list-style-type: none"> <li>For conducted measurement.             <ul style="list-style-type: none"> <li>If The EUT supports multiple transmit chains using options given below:                 <ul style="list-style-type: none"> <li><input type="checkbox"/> Option 1: Measure and sum the spectra across the outputs. Refer as FCC KDB 662911, In-band power spectral density (PSD). Sample all transmit ports simultaneously using a spectrum analyzer for each transmit port. Where the trace bin-by-bin of each transmit port summing can be performed. (i.e., in the first spectral bin of output 1 is summed with that in the first spectral bin of output 2 and that from the first spectral bin of output 3, and so on up to the NTX output to obtain the value for the first frequency bin of the summed spectrum.). Add up the amplitude (power) values for the different transmit chains and use this as the new data trace.</li> <li><input type="checkbox"/> Option 2: Measure and sum spectral maxima across the outputs. With this technique, spectra are measured at each output of the device at the required resolution bandwidth. The maximum value (peak) of each spectrum is determined. These maximum values are then summed mathematically in linear power units across the outputs. These operations shall be performed separately over frequency spans that have different out-of-band or spurious emission limits,</li> <li><input type="checkbox"/> Option 3: Measure and add 10 log(N) dB, where N is the number of transmit chains. Refer as FCC KDB 662911, In-band power spectral density (PSD). Performed at each transmit chains and each transmit chains shall be compared with the limit have been reduced with 10 log(N). Or each transmit chains shall be add 10 log(N) to compared with the limit.</li> </ul> </li> </ul> </li> </ul>

### 3.4.4 Test Setup

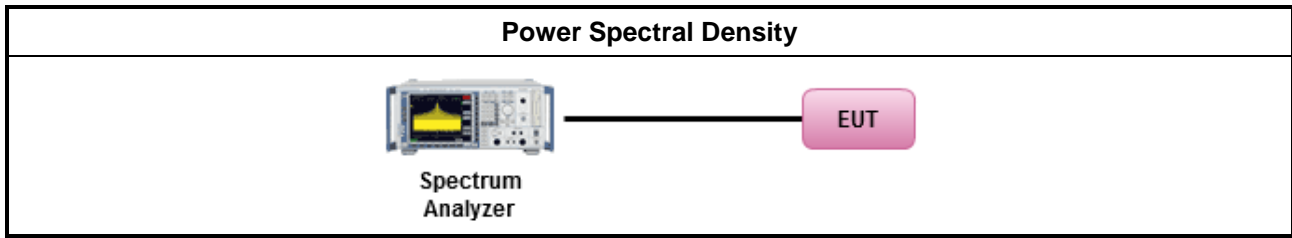

### 3.4.5 Test Result of Power Spectral Density

Refer as Appendix D

### 3.5 Emissions in Non-restricted Frequency Bands

#### 3.5.1 Emissions in Non-restricted Frequency Bands Limit

Un-restricted Band Emissions Limit	
RF output power procedure	Limit (dBc)
Peak output power procedure	20
Average output power procedure	30

Note 1: If the peak output power procedure is used to measure the fundamental emission power to demonstrate compliance to requirements, then the peak conducted output power measured within any 100 kHz outside the authorized frequency band shall be attenuated by at least 20 dB relative to the maximum measured in-band peak PSD level.

Note 2: If the average output power procedure is used to measure the fundamental emission power to demonstrate compliance to requirements, then the power in any 100 kHz outside of the authorized frequency band shall be attenuated by at least 30 dB relative to the maximum measured in-band average PSD level.

#### 3.5.2 Measuring Instruments

Refer a test equipment and calibration data table in this test report.

#### 3.5.3 Test Procedures

Test Method
<ul style="list-style-type: none"> <li>Refer as FCC KDB 558074, clause 8.5 for unwanted emissions into non-restricted bands.</li> </ul>

#### 3.5.4 Test Setup

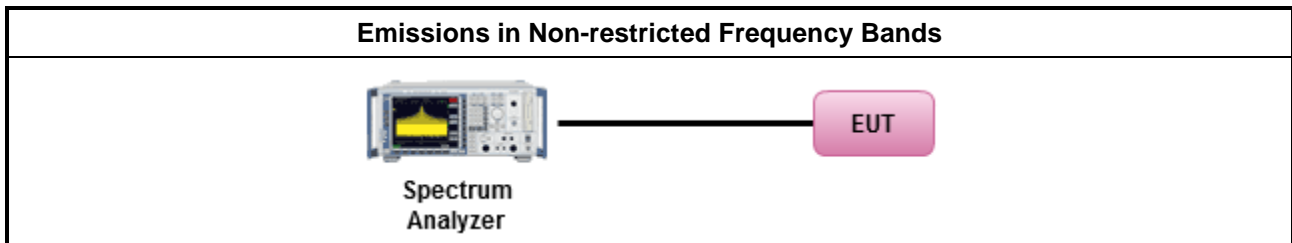

#### 3.5.5 Test Result of Emissions in Non-restricted Frequency Bands

Refer as Appendix E



### 3.6 Emissions in Restricted Frequency Bands

#### 3.6.1 Emissions in Restricted Frequency Bands Limit

Restricted Band Emissions Limit			
Frequency Range (MHz)	Field Strength (uV/m)	Field Strength (dBuV/m)	Measure Distance (m)
0.009~0.490	2400/F(kHz)	48.5 - 13.8	300
0.490~1.705	24000/F(kHz)	33.8 - 23	30
1.705~30.0	30	29	30
30~88	100	40	3
88~216	150	43.5	3
216~960	200	46	3
Above 960	500	54	3

Note 1: Test distance for frequencies at or above 30 MHz, measurements may be performed at a distance other than the limit distance provided they are not performed in the near field and the emissions to be measured can be detected by the measurement equipment. When performing measurements at a distance other than that specified, the results shall be extrapolated to the specified distance using an extrapolation factor of 20 dB/decade (inverse of linear distance for field-strength measurements, inverse of linear distance-squared for power-density measurements).

Note 2: Test distance for frequencies at below 30 MHz, measurements may be performed at a distance closer than the EUT limit distance; however, an attempt should be made to avoid making measurements in the near field. When performing measurements below 30 MHz at a closer distance than the limit distance, the results shall be extrapolated to the specified distance by either making measurements at a minimum of two or more distances on at least one radial to determine the proper extrapolation factor or by using the square of an inverse linear distance extrapolation factor (40 dB/decade). The test report shall specify the extrapolation method used to determine compliance of the EUT.

Note 3: Using the distance of 1m during the test for above 18 GHz, and the test value to correct for the distance factor at 3m.

#### 3.6.2 Measuring Instruments

Refer a test equipment and calibration data table in this test report.



**3.6.3 Test Procedures**

<b>Test Method</b>	
<ul style="list-style-type: none"> <li>▪ The average emission levels shall be measured in [duty cycle <math>\geq</math> 98 or duty factor].</li> </ul>	
<ul style="list-style-type: none"> <li>▪ Refer as ANSI C63.10, clause 6.10.3 band-edge testing shall be performed at the lowest frequency channel and highest frequency channel within the allowed operating band.</li> </ul>	
<ul style="list-style-type: none"> <li>▪ For the transmitter unwanted emissions shall be measured using following options below:</li> </ul>	
	<ul style="list-style-type: none"> <li>▪ Refer as FCC KDB 558074, clause 8.6 for unwanted emissions into restricted bands.</li> </ul>
	<input type="checkbox"/> Refer as FCC KDB 558074, clause 8.6 & C63.10 clause 11.12.2.5.1(trace averaging for duty cycle $\geq$ 98%).
	<input type="checkbox"/> Refer as FCC KDB 558074, clause 8.6 & C63.10 clause 11.12.2.5.2(trace averaging + duty factor).
	<input checked="" type="checkbox"/> Refer as FCC KDB 558074, clause 8.6 & C63.10 clause 11.12.2.5.3(Reduced VBW $\geq$ 1/T).
	<input type="checkbox"/> Refer as ANSI C63.10, clause 11.12.2.5.3 (Reduced VBW). VBW $\geq$ 1/T, where T is pulse time.
	<input type="checkbox"/> Refer as ANSI C63.10, clause 7.5 average value of pulsed emissions.
	<input checked="" type="checkbox"/> Refer as FCC KDB 558074, clause 8.6 & C63.10 clause 11.12.2.4 measurement procedure peak limit.
<ul style="list-style-type: none"> <li>▪ For the transmitter band-edge emissions shall be measured using following options below:</li> </ul>	
	<ul style="list-style-type: none"> <li>▪ Refer as FCC KDB 558074 clause 8.7 &amp; c63.10 clause 11.13.1, When the performing peak or average radiated measurements, emissions within 2 MHz of the authorized band edge may be measured using the marker-delta method described below.</li> </ul>
	<ul style="list-style-type: none"> <li>▪ Refer as FCC KDB 558074, clause 8.7 (ANSI C63.10, clause 6.10.6) for marker-delta method for band-edge measurements.</li> </ul>
	<ul style="list-style-type: none"> <li>▪ Refer as FCC KDB 558074, clause 8.7 for narrower resolution bandwidth (100kHz) using the band power and summing the spectral levels (i.e., 1 MHz).</li> </ul>
	<ul style="list-style-type: none"> <li>▪ For conducted unwanted emissions into restricted bands (absolute emission limits). Devices with multiple transmit chains using options given below:                (1) Measure and sum the spectra across the outputs or                (2) Measure and add 10 log(N) dB             </li> </ul>
	<ul style="list-style-type: none"> <li>▪ For FCC KDB 662911 The methodology described here may overestimate array gain, thereby resulting in apparent failures to satisfy the out-of-band limits even if the device is actually compliant. In such cases, compliance may be demonstrated by performing radiated tests around the frequencies at which the apparent failures occurred.</li> </ul>



<b>Test Method</b>	
<ul style="list-style-type: none"><li>▪ For conducted and cabinet radiation measurement, refer as FCC KDB 558074, clause 8.6 &amp; C63.10 clause 11.12.2.2.</li></ul>	
	<ul style="list-style-type: none"><li>▪ For conducted unwanted emissions into non-restricted bands (relative emission limits). Devices with multiple transmit chains: Refer as FCC KDB 662911, when testing out-of-band and spurious emissions against relative emission limits, tests may be performed on each output individually without summing or adding 10 log(N) if the measurements are made relative to the in-band emissions on the individual outputs.</li></ul>
	<ul style="list-style-type: none"><li>▪ For conducted unwanted emissions into restricted bands (absolute emission limits). Devices with multiple transmit chains using options given below: (1) Measure and sum the spectra across the outputs or (2) Measure and add 10 log(N) dB</li></ul>
	<ul style="list-style-type: none"><li>▪ For FCC KDB 662911 The methodology described here may overestimate array gain, thereby resulting in apparent failures to satisfy the out-of-band limits even if the device is actually compliant. In such cases, compliance may be demonstrated by performing radiated tests around the frequencies at which the apparent failures occurred.</li></ul>

**3.6.4 Test Setup**

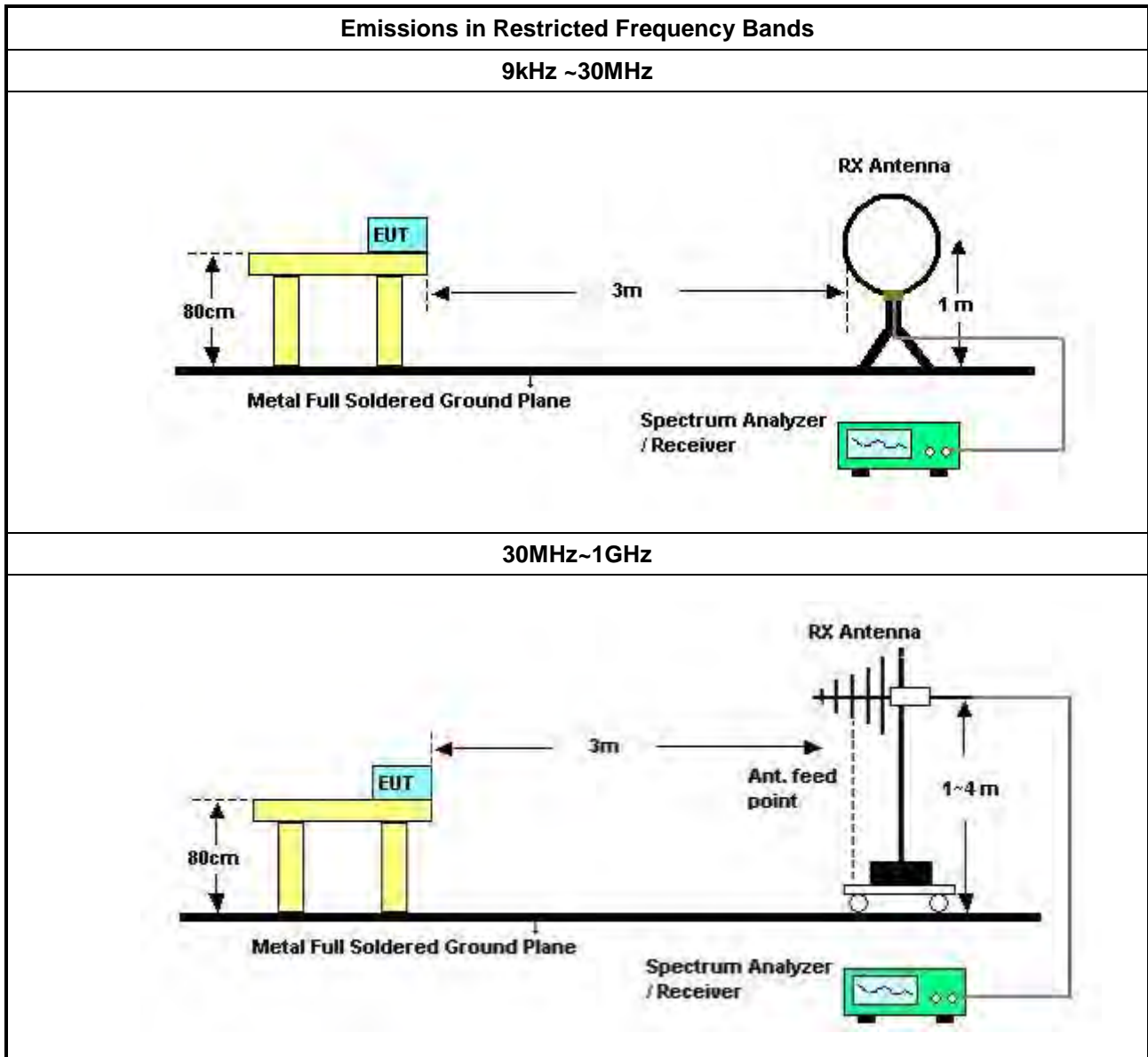



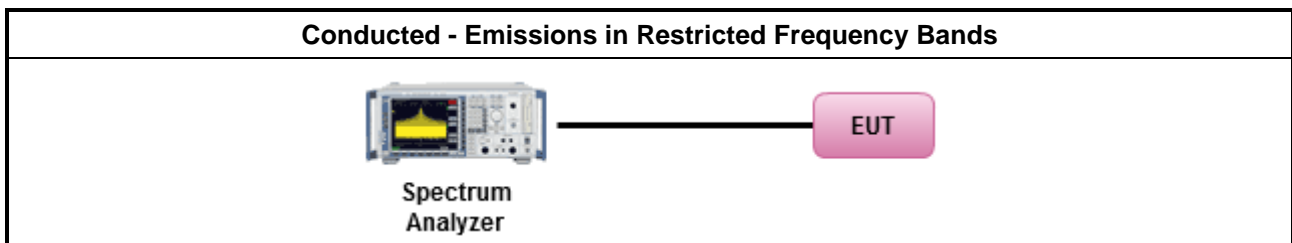
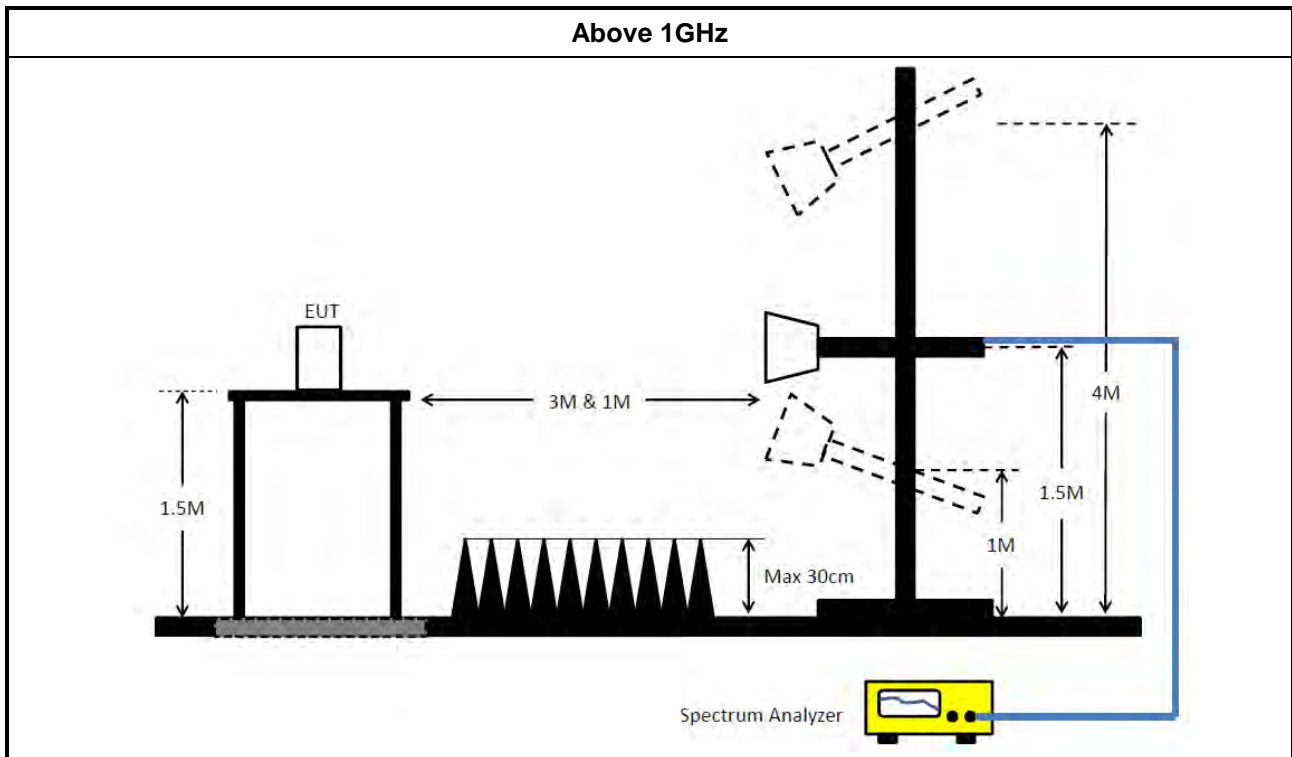

### 3.6.5 Measurement Results Calculation

The measured Level is calculated using:

Corrected Reading:  $\text{Antenna factor (AF)} + \text{Cable loss (CL)} + \text{Read level (Raw)} - \text{Preamp factor (PA)} (\text{if applicable}) = \text{Level}$ .

### 3.6.6 Emissions in Restricted Frequency Bands (Below 30MHz)

There is a comparison data of both open-field test site and alternative test site - semi-Anechoic chamber according to KDB414788 Radiated Test Site, and the result came out very similar.

All amplitude of spurious emissions that are attenuated by more than 20 dB below the permissible value has no need to be reported.

The radiated emissions were investigated from 9 kHz or the lowest frequency generated within the device, up to the 10th harmonic or 40 GHz, whichever is appropriate.

### 3.6.7 Test Result of Emissions in Restricted Frequency Bands

Refer as Appendix F



## 4 Test Equipment and Calibration Data

Instrument	Brand	Model No.	Serial No.	Characteristics	Calibration Date	Calibration Due Date	Remark
EMI Receiver	Agilent	N9038A	My52260123	9kHz ~ 8.4GHz	Feb. 20, 2023	Feb. 19, 2024	Conduction (CO01-CB)
LISN	F.C.C.	FCC-LISN-50-16-2	04083	150kHz ~ 100MHz	Feb. 16, 2023	Feb. 15, 2024	Conduction (CO01-CB)
LISN	Schwarzbeck	NSLK 8127	8127478	9kHz ~ 30MHz	Dec. 20, 2022	Dec. 19, 2023	Conduction (CO01-CB)
Pulse Limiter	Rohde& Schwarz	ESH3-Z2	100430	9kHz ~ 30MHz	Feb. 09, 2023	Feb. 08, 2024	Conduction (CO01-CB)
COND Cable	Woken	Cable	Low cable-CO01	9kHz ~ 30MHz	Oct. 18, 2022	Oct. 17, 2023	Conduction (CO01-CB)
Software	SPORTON	SENSE	V5.10	-	N.C.R.	N.C.R.	Conduction (CO01-CB)
10m Semi Anechoic Chamber NSA	TDK	SAC-10M	10CH01-CB	30MHz~1GHz 10m,3m	Jan. 18, 2023	Jan. 17, 2024	Radiation (10CH01-CB)
Amplifier	Agilent	8447D	2944A10783	9kHz ~ 1.3GHz	Mar. 10, 2023	Mar. 09, 2024	Radiation (10CH01-CB)
Amplifier	Agilent	8447D	2944A10784	9kHz ~ 1.3GHz	Mar. 10, 2023	Mar. 09, 2024	Radiation (10CH01-CB)
Low Cable	Woken	SUCOFLEX 104	low cable-01	25MHz ~ 1GHz	Oct. 18, 2022	Oct. 17, 2023	Radiation (10CH01-CB)
Low Cable	Woken	SUCOFLEX 104	low cable-02	25MHz ~ 1GHz	Oct. 18, 2022	Oct. 17, 2023	Radiation (10CH01-CB)
EMI Test Receiver	Rohde& Schwarz	ESCI	100186	9kHz ~ 3GHz	Jul. 11, 2022	Jul. 10, 2023	Radiation (10CH01-CB)
Spectrum Analyzer	R&S	FSP40	100056	9kHz ~ 40GHz	May 06, 2022	May 05, 2023	Radiation (10CH01-CB)
Bilog Antenna with 6dB Attenuator	Chase & EMCI	CBL6111A &N-6-06	1543 &AT-N0609	30MHz ~ 1GHz	Jun. 25, 2022	Jun. 24, 2023	Radiation (10CH01-CB)
Amplifier	EM	EM101	060703	10MHz ~ 1GHz	Oct. 19, 2022	Oct. 18, 2023	Radiation (10CH01-CB)
Low Cable	TITAN	T318E	low cable-03	30MHz ~ 1GHz	Oct. 18, 2022	Oct. 17, 2023	Radiation (10CH01-CB)
Loop Antenna	Teseq	HLA 6120	24155	9kHz - 30 MHz	May 14, 2022	May 13, 2023	Radiation (10CH01-CB)
Software	SPORTON	SENSE	V5.10	-	N.C.R.	N.C.R.	Radiation (10CH01-CB)
3m Semi Anechoic Chamber VSWR	TDK	SAC-3M	03CH06-CB	1GHz ~18GHz 3m	Sep. 30, 2022	Sep. 29, 2023	Radiation (03CH06-CB)
Horn Antenna	SCHWARZBECK	BBHA9120D	BBHA 9120D-1292	1GHz~18GHz	Aug. 09, 2022	Aug. 08, 2023	Radiation (03CH06-CB)
Horn Antenna	Schwarzbeck	BBHA 9170	BBHA9170252	15GHz ~ 40GHz	Aug. 22, 2022	Aug. 21, 2023	Radiation (03CH06-CB)



Instrument	Brand	Model No.	Serial No.	Characteristics	Calibration Date	Calibration Due Date	Remark
Pre-Amplifier	Agilent	83017A	MY53270064	0.5GHz ~ 26.5GHz	Aug. 02, 2022	Aug. 01, 2023	Radiation (03CH06-CB)
Pre-Amplifier	SGH	SGH184	20221107-3	18GHz ~ 40GHz	Nov. 16, 2022	Nov. 15, 2023	Radiation (03CH06-CB)
Spectrum analyzer	R&S	FSP40	100080	9kHz~40GHz	Dec. 21, 2022	Dec. 20, 2023	Radiation (03CH06-CB)
RF Cable-high	Woken	RG402	High Cable-68	1GHz~18GHz	Oct. 03, 2022	Oct. 02, 2023	Radiation (03CH06-CB)
RF Cable-high	Woken	RG402	High Cable-05+68	1GHz~18GHz	Dec. 21, 2022	Dec. 20, 2023	Radiation (03CH06-CB)
High Cable	Woken	WCA0929M	40G#5+6	1GHz ~ 40 GHz	Dec. 07, 2022	Dec. 06, 2023	Radiation (03CH06-CB)
High Cable	Woken	WCA0929M	40G#5	1GHz ~ 40 GHz	Dec. 07, 2022	Dec. 06, 2023	Radiation (03CH06-CB)
High Cable	Woken	WCA0929M	40G#6	1GHz ~ 40 GHz	Dec. 07, 2022	Dec. 06, 2023	Radiation (03CH06-CB)
Test Software	SPORTON	SENSE	V5.10	-	N.C.R.	N.C.R.	Radiation (03CH06-CB)
Spectrum analyzer	R&S	FSV40	101028	9kHz~40GHz	Dec. 30, 2022	Dec. 29, 2023	Conducted (TH03-CB)
Power Sensor	Anritsu	MA2411B	1726195	300MHz~40GHz	Sep. 04, 2022	Sep. 03, 2023	Conducted (TH03-CB)
Power Meter	Anritsu	ML2495A	1035008	300MHz~40GHz	Sep. 04, 2022	Sep. 03, 2023	Conducted (TH03-CB)
RF Cable-high	Woken	RG402	High Cable-11	1 GHz –18 GHz	Oct. 03, 2022	Oct. 02, 2023	Conducted (TH03-CB)
RF Cable-high	Woken	RG402	High Cable-12	1 GHz –18 GHz	Oct. 03, 2022	Oct. 02, 2023	Conducted (TH03-CB)
RF Cable-high	Woken	RG402	High Cable-13	1 GHz –18 GHz	Oct. 03, 2022	Oct. 02, 2023	Conducted (TH03-CB)
RF Cable-high	Woken	RG402	High Cable-14	1 GHz –18 GHz	Oct. 03, 2022	Oct. 02, 2023	Conducted (TH03-CB)
RF Cable-high	Woken	RG402	High Cable-15	1 GHz –18 GHz	Oct. 03, 2022	Oct. 02, 2023	Conducted (TH03-CB)
Switch	SPTCB	SP-SWI	SWI-03	1 GHz –26.5 GHz	Oct. 04, 2022	Oct. 03, 2023	Conducted (TH03-CB)
Test Software	SPORTON	SENSE	V5.10	-	N.C.R.	N.C.R.	Conducted (TH03-CB)

Note: Calibration Interval of instruments listed above is one year.  
NCR means Non-Calibration required.



**Summary**

Mode	Result	Type	Freq (Hz)	Level (dBuV)	Limit (dBuV)	Margin (dB)	Condition
Mode 13	Pass	QP	168k	60.92	65.06	-4.14	Neutral

## Mode 13

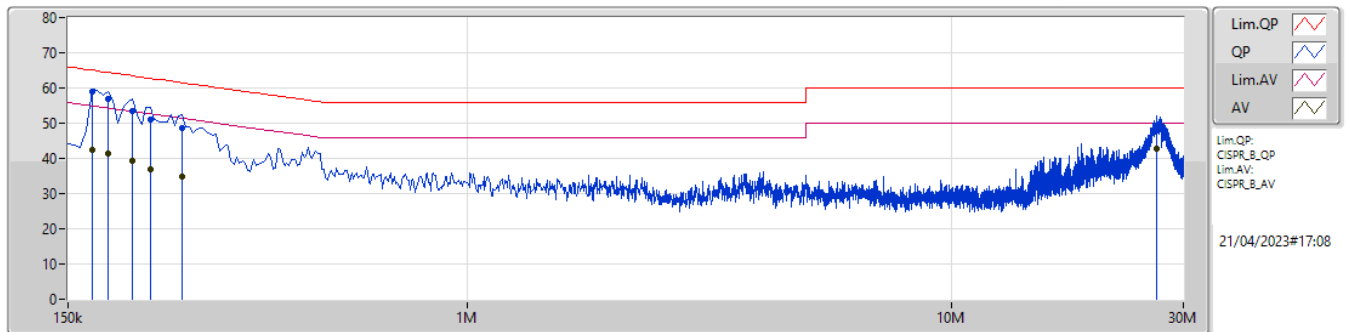

Type	Freq (Hz)	Level (dBuV)	Limit (dBuV)	Margin (dB)	Factor (dB)	Condition	Comment	Raw (dBuV)	LISN (dB)	CL (dB)	AT (dB)
QP	168k	59.03	65.06	-6.03	9.97	Line	"Worst"	49.06	0.06	0.04	9.87
AV	168k	42.42	55.06	-12.64	9.97	Line	-	32.45	0.06	0.04	9.87
QP	181.5k	57.06	64.41	-7.35	9.96	Line	-	47.10	0.06	0.04	9.86
AV	181.5k	41.28	54.41	-13.13	9.96	Line	-	31.32	0.06	0.04	9.86
QP	204k	53.32	63.44	-10.12	9.96	Line	-	43.36	0.06	0.04	9.86
AV	204k	39.26	53.44	-14.18	9.96	Line	-	29.30	0.06	0.04	9.86
QP	222k	51.01	62.75	-11.74	9.97	Line	-	41.04	0.06	0.04	9.87
AV	222k	36.81	52.75	-15.94	9.97	Line	-	26.84	0.06	0.04	9.87
QP	258k	48.54	61.49	-12.95	9.98	Line	-	38.56	0.06	0.05	9.87
AV	258k	34.98	51.49	-16.51	9.98	Line	-	25.00	0.06	0.05	9.87
QP	26.457M	48.74	60.00	-11.26	10.74	Line	-	38.00	0.37	0.30	10.07
AV	26.457M	42.83	50.00	-7.17	10.74	Line	-	32.09	0.37	0.30	10.07

## Mode 13

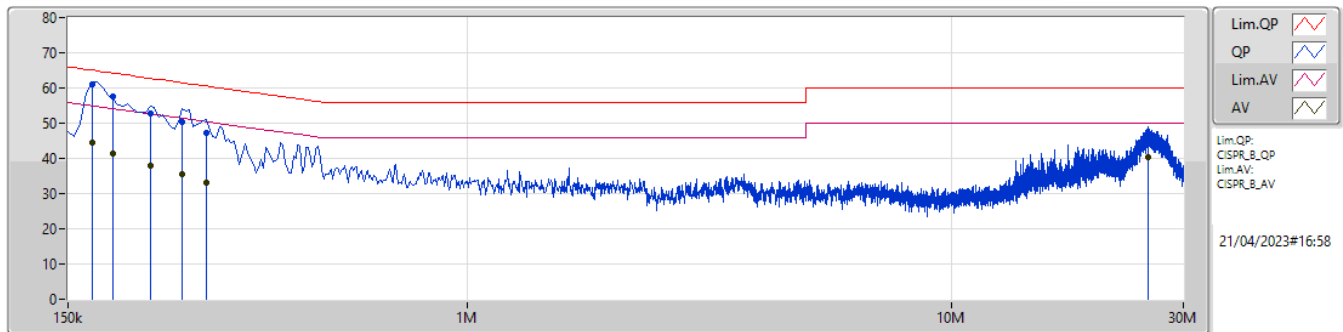

Type	Freq (Hz)	Level (dBuV)	Limit (dBuV)	Margin (dB)	Factor (dB)	Condition	Comment	Raw (dBuV)	LISN (dB)	CL (dB)	AT (dB)
QP	168k	60.92	65.06	-4.14	9.98	Neutral	"Worst"	50.94	0.07	0.04	9.87
AV	168k	44.32	55.06	-10.74	9.98	Neutral	-	34.34	0.07	0.04	9.87
QP	186k	57.49	64.20	-6.71	9.97	Neutral	-	47.52	0.07	0.04	9.86
AV	186k	41.21	54.20	-12.99	9.97	Neutral	-	31.24	0.07	0.04	9.86
QP	222k	52.93	62.75	-9.82	9.98	Neutral	-	42.95	0.07	0.04	9.87
AV	222k	37.82	52.75	-14.93	9.98	Neutral	-	27.84	0.07	0.04	9.87
QP	258k	50.27	61.49	-11.22	9.99	Neutral	-	40.28	0.07	0.05	9.87
AV	258k	35.45	51.49	-16.04	9.99	Neutral	-	25.46	0.07	0.05	9.87
QP	289.5k	47.13	60.53	-13.40	10.00	Neutral	-	37.13	0.07	0.05	9.88
AV	289.5k	33.23	50.53	-17.30	10.00	Neutral	-	23.23	0.07	0.05	9.88
QP	25.427M	46.12	60.00	-13.88	10.65	Neutral	-	35.47	0.31	0.29	10.05
AV	25.427M	40.27	50.00	-9.73	10.65	Neutral	-	29.62	0.31	0.29	10.05



**Summary**

Mode	Max-N dB (Hz)	Max-OBW (Hz)	ITU-Code	Min-N dB (Hz)	Min-OBW (Hz)
2.4-2.4835GHz	-	-	-	-	-
Zigbee	1.631M	2.244M	2M24G1D	1.625M	2.233M

Max-N dB = Maximum 6dB down bandwidth; Max-OBW = Maximum 99% occupied bandwidth;  
Min-N dB = Minimum 6dB down bandwidth; Min-OBW = Minimum 99% occupied bandwidth



Result

Mode	Result	Limit (Hz)	Port 1-N dB (Hz)	Port 1-OBW (Hz)
Zigbee	-	-	-	-
2405MHz	Pass	500k	1.625M	2.233M
2440MHz	Pass	500k	1.625M	2.235M
2480MHz	Pass	500k	1.631M	2.244M

Port X-N dB = Port X 6dB down bandwidth;  
Port X-OBW = Port X 99% occupied bandwidth



2.4-2.4835GHz\_Zigbee

EBW

2405MHz

02/05/2023

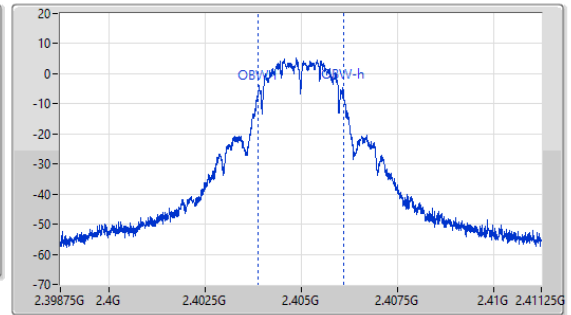
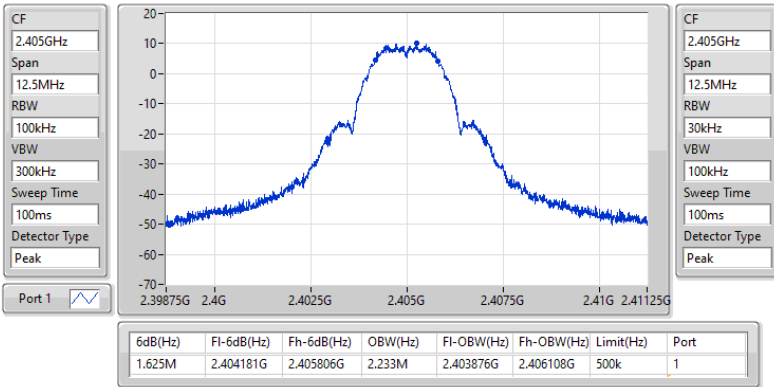

2.4-2.4835GHz\_Zigbee

EBW

2440MHz

02/05/2023

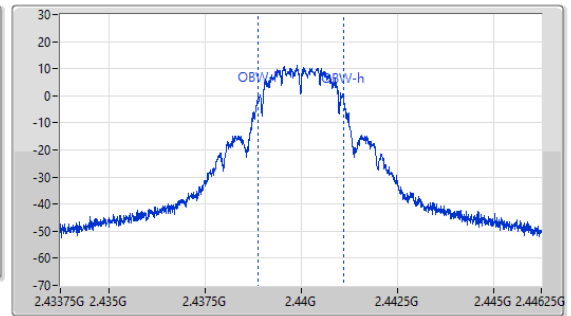
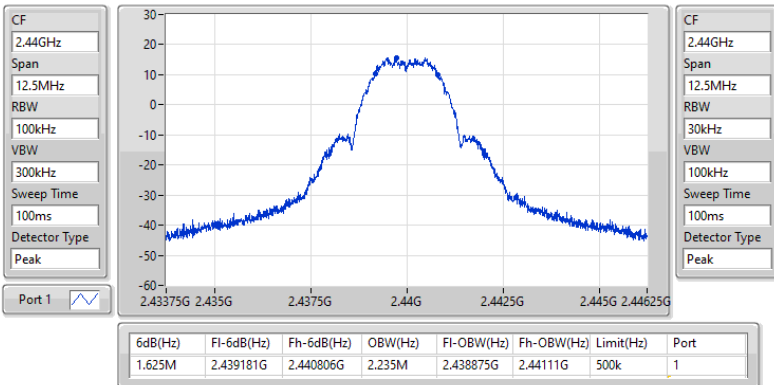

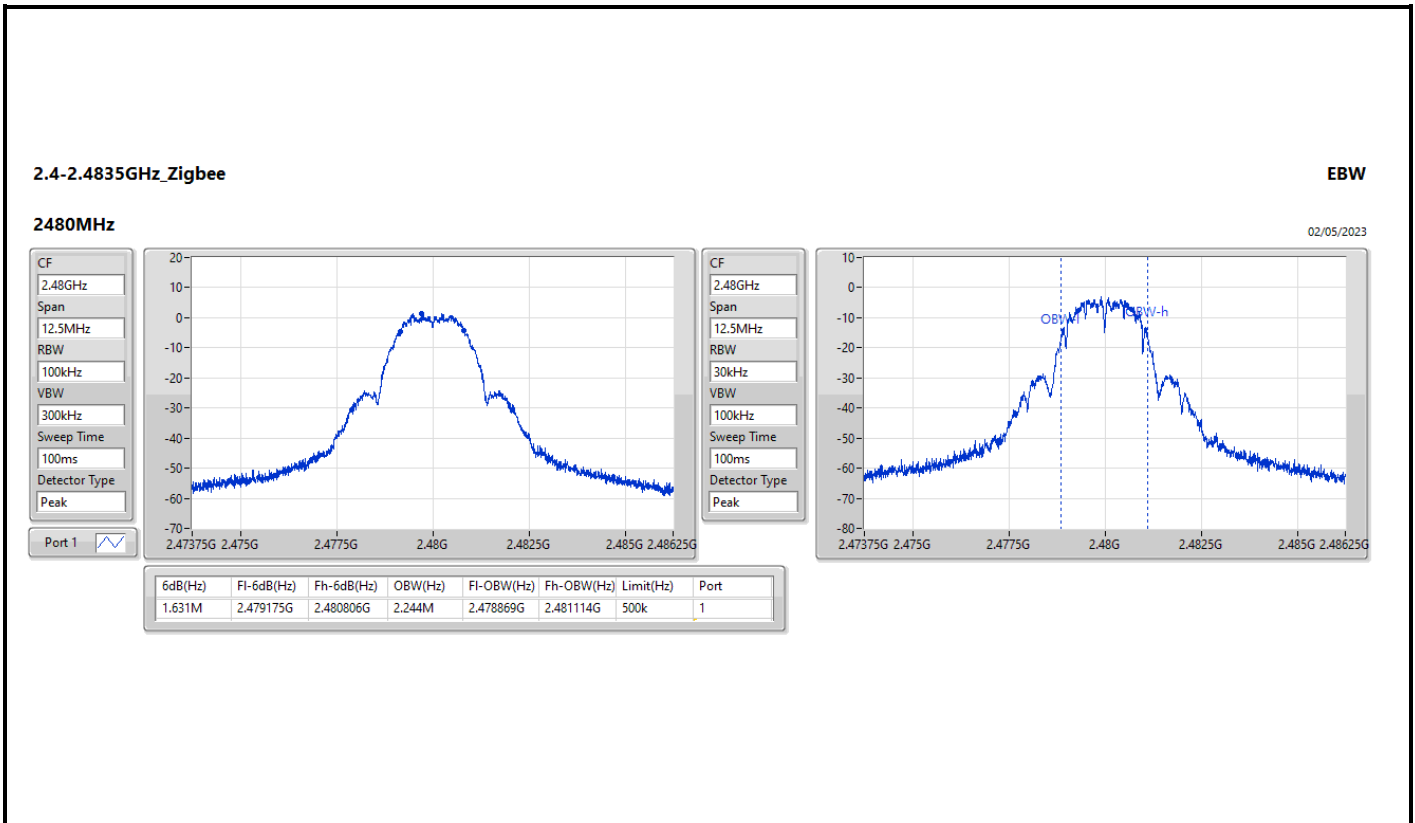



**Summary**

Mode	Total Power (dBm)	Total Power (W)
2.4-2.4835GHz	-	-
Zigbee	20.00	0.10000



**Result**

Mode	Result	DG (dBi)	Port 1 (dBm)	Total Power (dBm)	Power Limit (dBm)
Zigbee	-	-	-	-	-
2405MHz	Pass	8.80	14.16	14.16	27.20
2440MHz	Pass	8.80	20.00	20.00	27.20
2475MHz	Pass	8.80	17.89	17.89	27.20
2480MHz	Pass	8.80	6.04	6.04	27.20

DG = Directional Gain; Port X = Port X output power



**Summary**

Mode	PD (dBm/RBW)
2.4-2.4835GHz	-
Zigbee	4.20

RBW = 3kHz;



Result

Mode	Result	DG (dBi)	Port 1 (dBm/RBW)	PD (dBm/RBW)	PD Limit (dBm/RBW)
Zigbee	-	-	-	-	-
2405MHz	Pass	8.80	-2.59	-2.59	5.20
2440MHz	Pass	8.80	4.20	4.20	5.20
2480MHz	Pass	8.80	-10.80	-10.80	5.20

DG = Directional Gain; RBW = 3kHz;  
PD = trace bin-by-bin of each transmits port summing can be performed maximum power density; Port X = Port X Power Density;

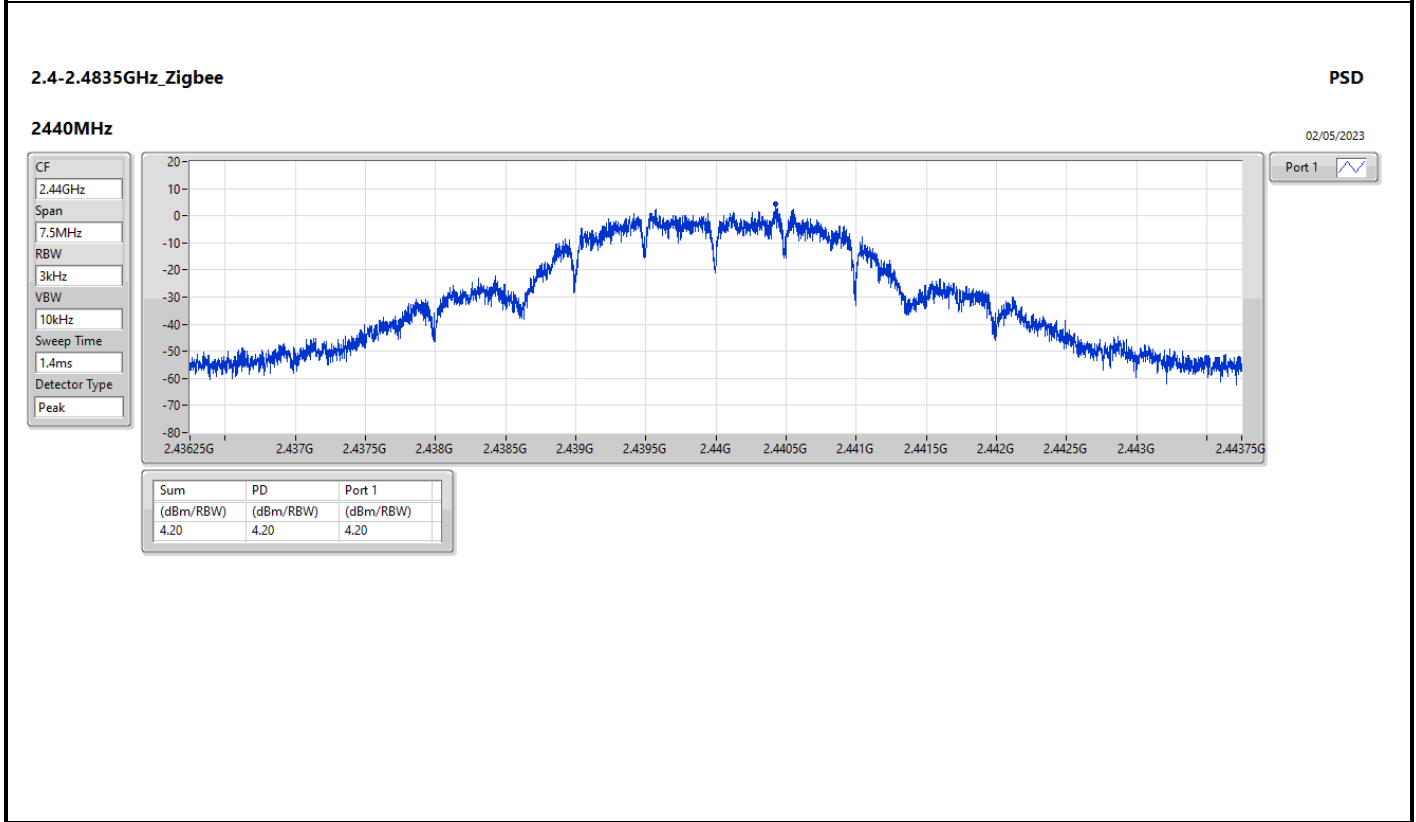
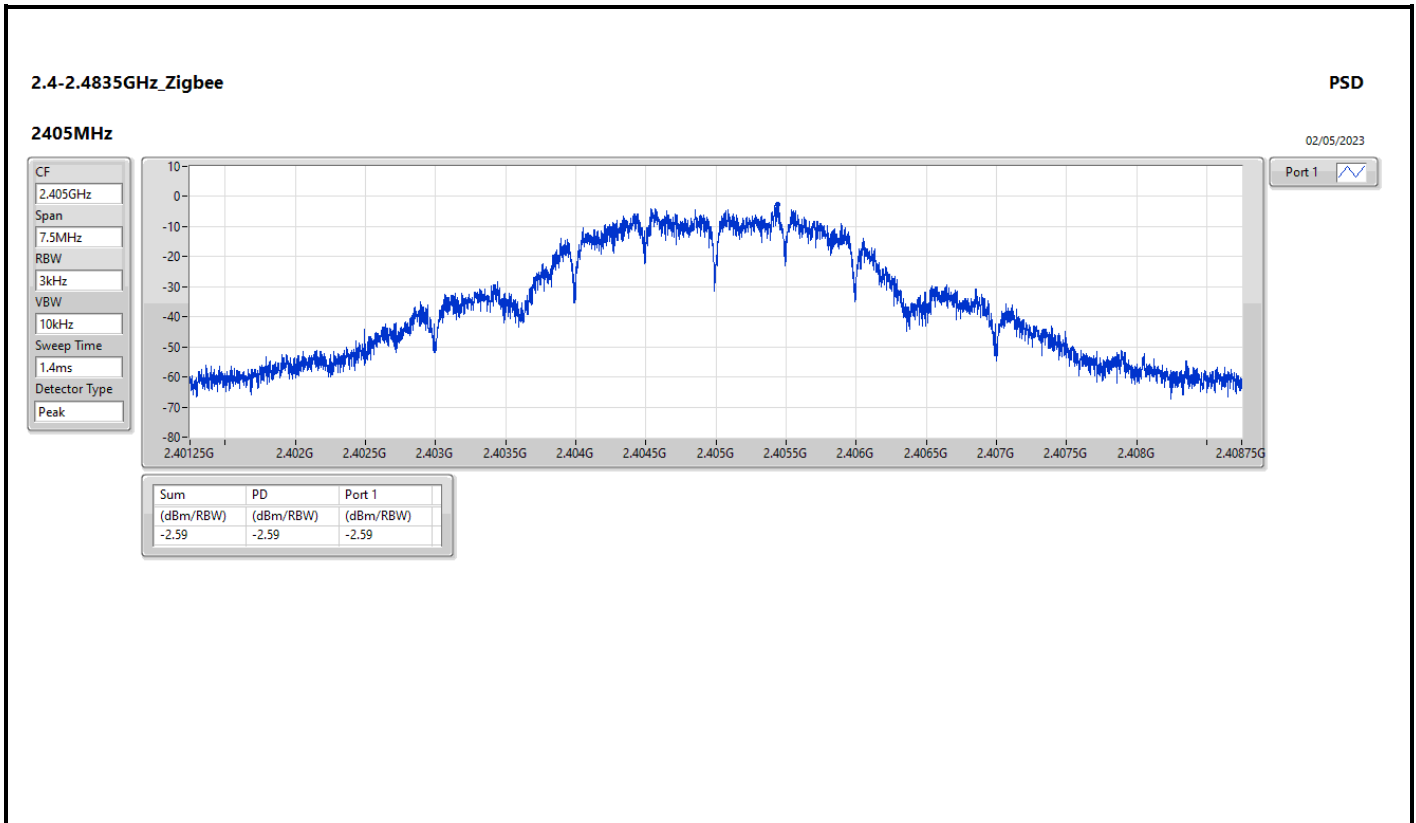

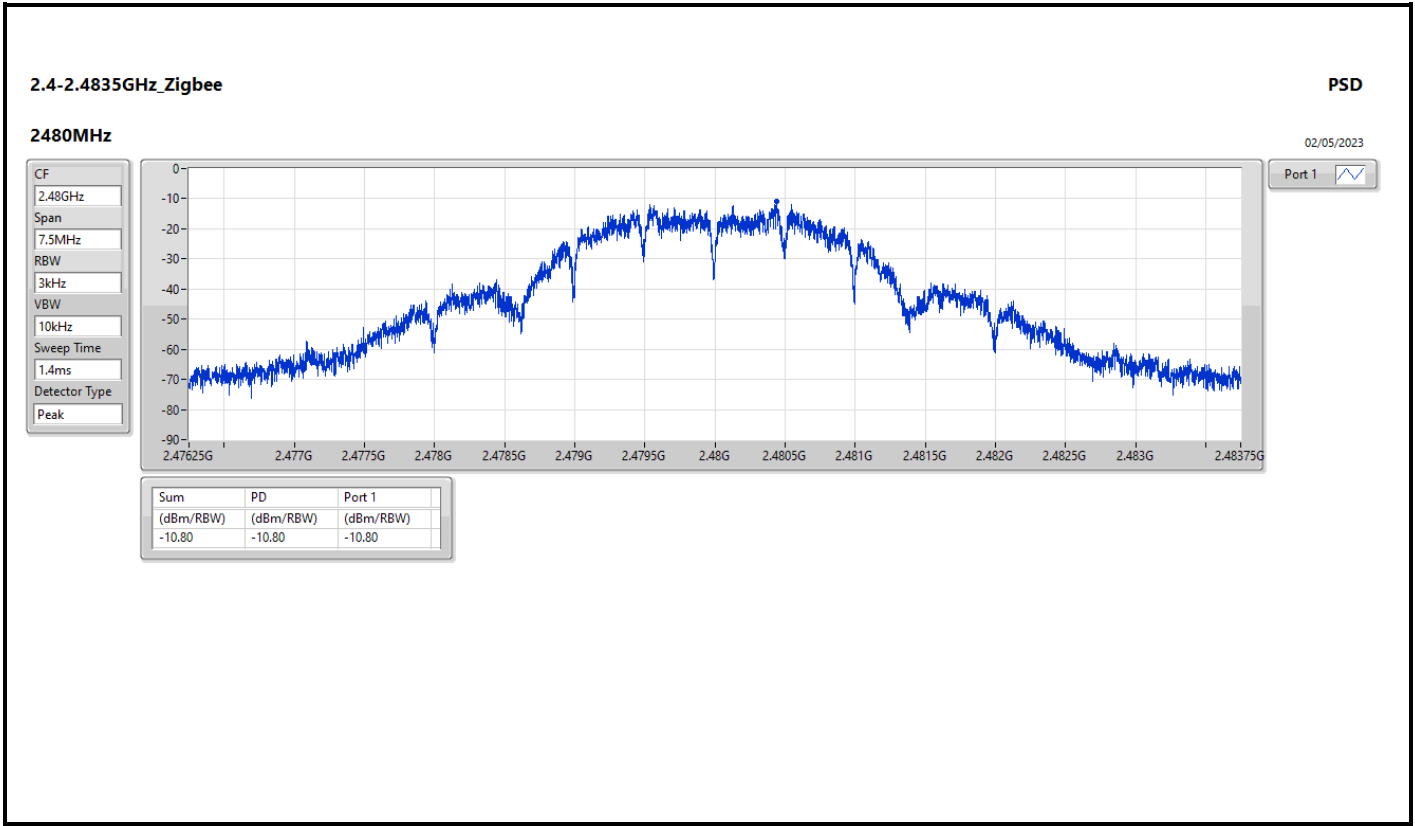





Summary

Mode	Result	Ref (Hz)	Ref (dBm)	Limit (dBm)	Freq (Hz)	Level (dBm)	Freq (Hz)	Level (dBm)	Freq (Hz)	Level (dBm)	Freq (Hz)	Level (dBm)	Port
2.4-2.4835GHz	-	-	-	-	-	-	-	-	-	-	-	-	-
Zigbee	Pass	2.43941G	15.14	-14.86	2.19058G	-53.68	2.39994G	-44.10	2.4G	-45.09	21.53119G	-46.91	1



Result

Mode	Result	Ref (Hz)	Ref (dBm)	Limit (dBm)	Freq (Hz)	Level (dBm)	Freq (Hz)	Level (dBm)	Freq (Hz)	Level (dBm)	Freq (Hz)	Level (dBm)	Port
Zigbee	-	-	-	-	-	-	-	-	-	-	-	-	-
2405MHz	Pass	2.43941G	15.14	-14.86	2.19058G	-53.68	2.39994G	-44.10	2.4G	-45.09	21.53119G	-46.91	1
2440MHz	Pass	2.43941G	15.14	-14.86	2.30386G	-53.53	2.3981G	-51.40	2.4G	-56.17	22.00664G	-46.73	1
2480MHz	Pass	2.43941G	15.14	-14.86	1.63598G	-52.89	2.39116G	-50.95	2.4G	-56.63	21.60996G	-47.05	1

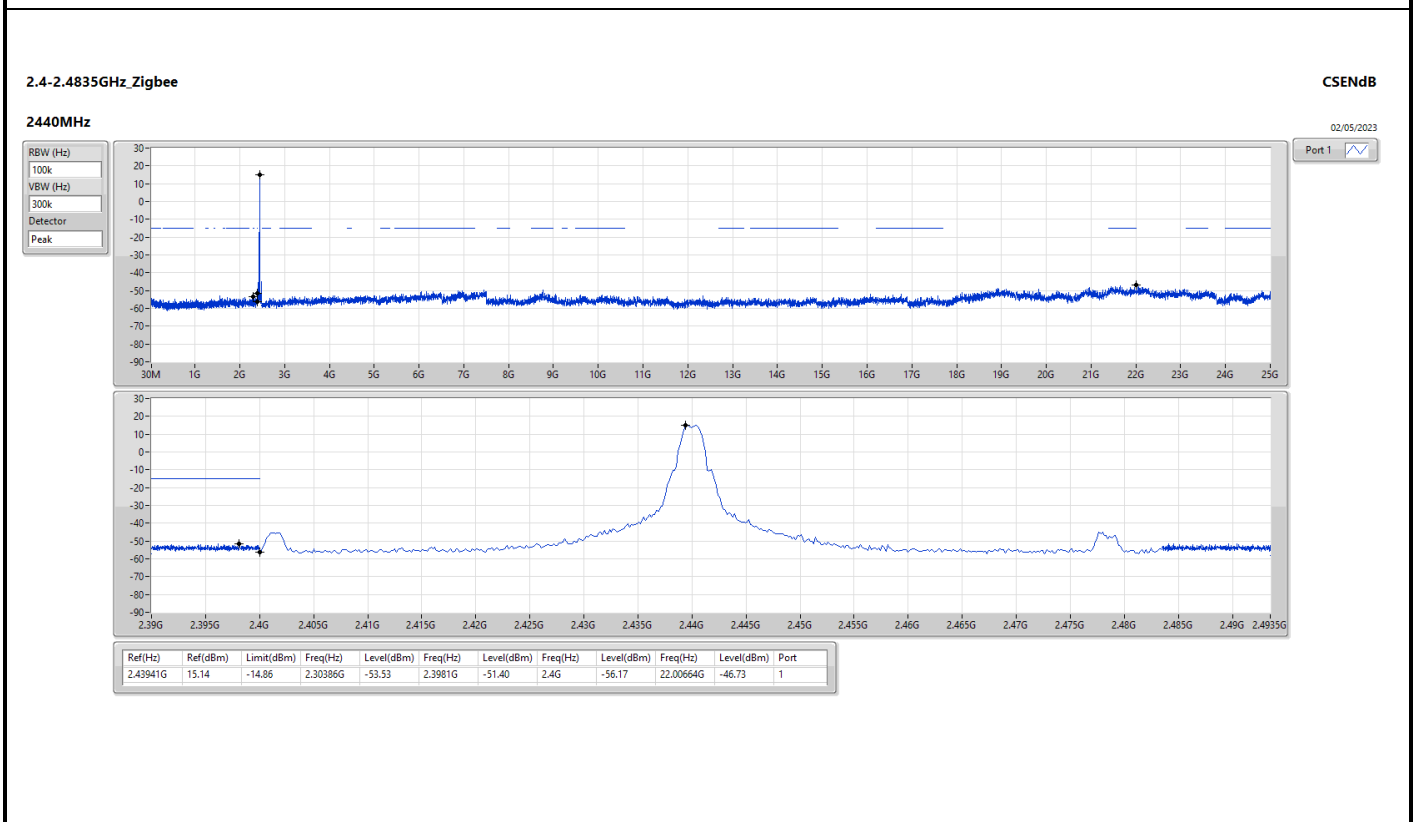
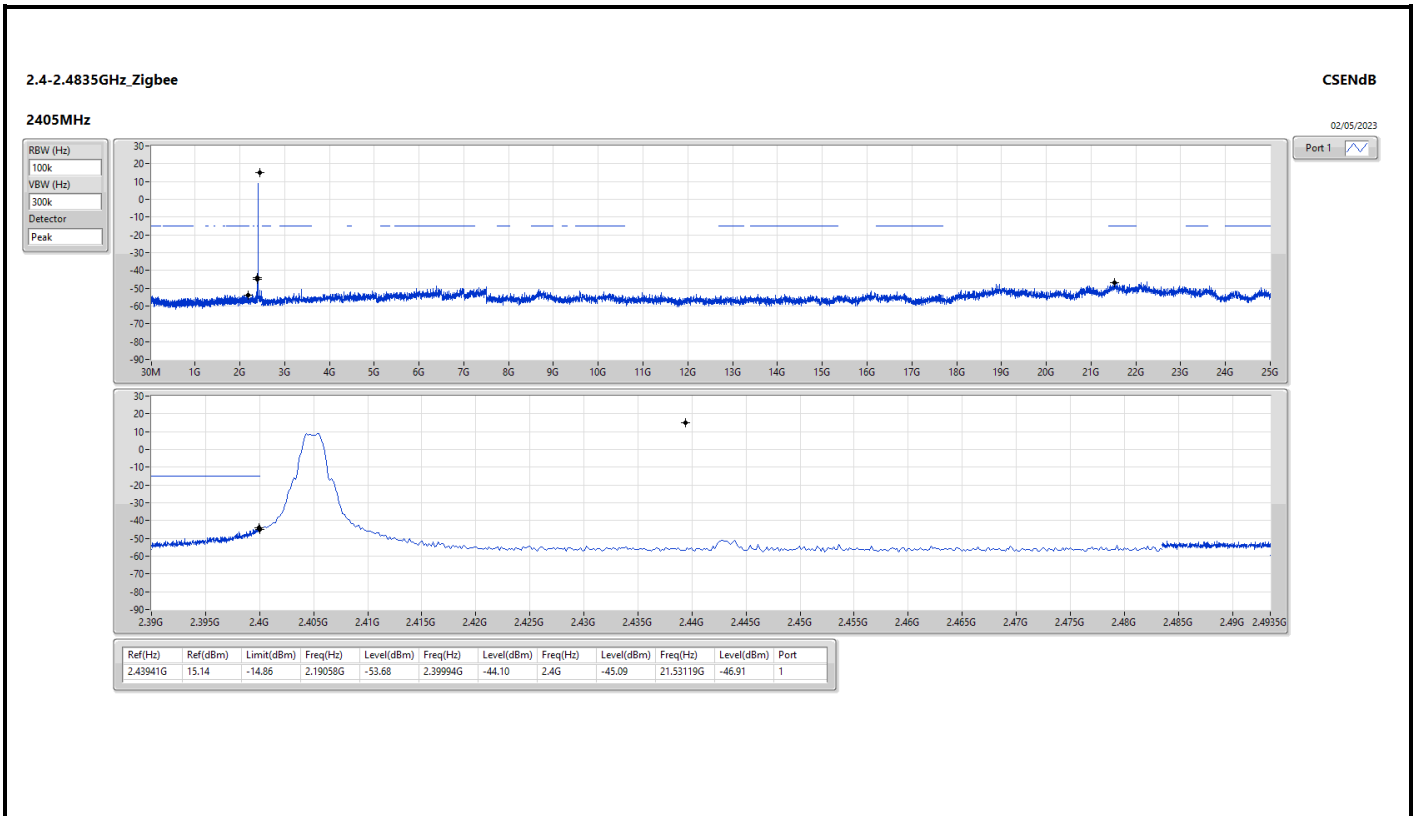

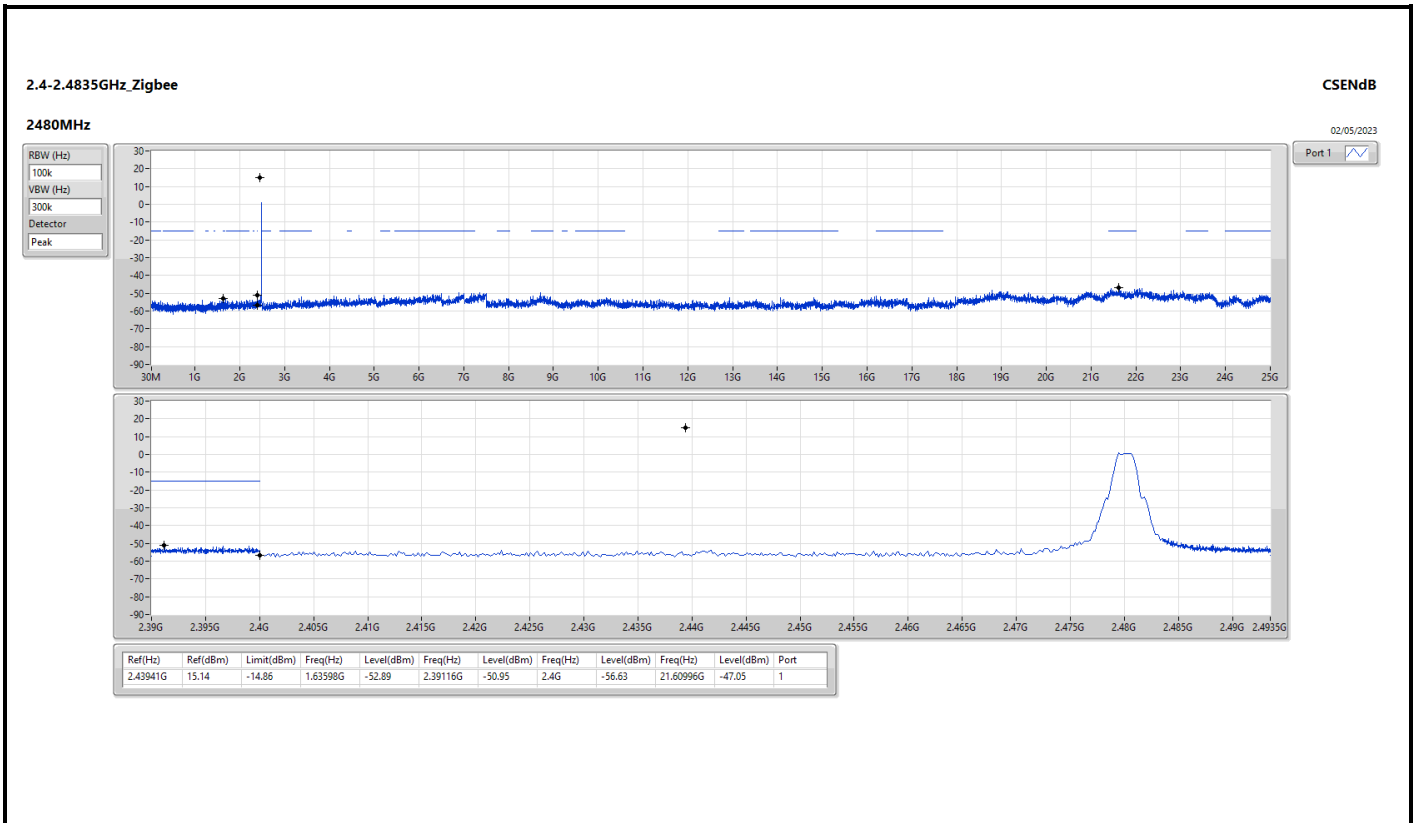



**Summary**

Mode	Result	Type	Freq (Hz)	Level (dBuV/m)	Limit (dBuV/m)	Margin (dB)	Condition
Mode 12	Pass	PK	33.88M	36.33	40.00	-3.67	Vertical

Mode 12

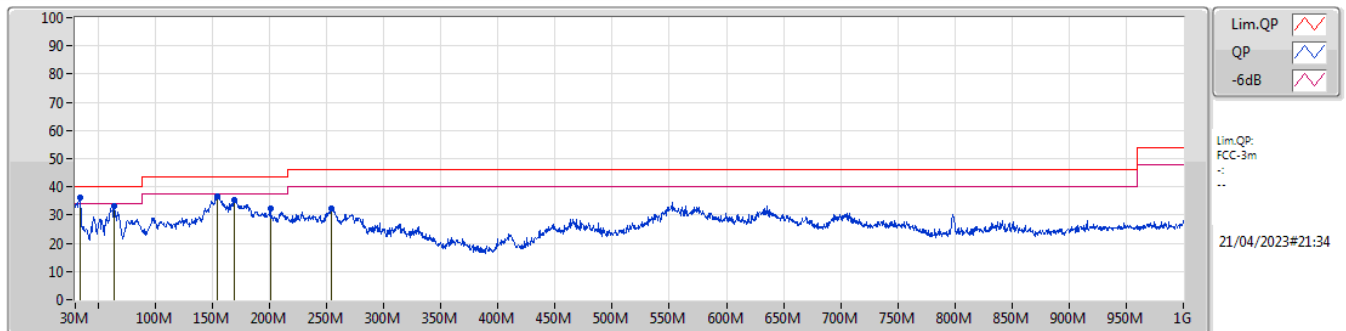

Type	Freq (Hz)	Level (dBuV/m)	Limit (dBuV/m)	Margin (dB)	Factor (dB)	Dist (m)	Condition	Azimuth (°)	Height (m)	Comment	Raw (dBuV)	AF (dB)	CL (dB)	PA (dB)
PK	33.88M	36.33	40.00	-3.67	-30.72	3	Vertical	75	1.00	"Worst"	67.05	22.78	0.74	54.24
PK	63.95M	33.05	40.00	-6.95	-40.88	3	Vertical	60	2.00	-	73.93	12.13	1.06	54.07
PK	154.16M	36.72	43.50	-6.78	-36.18	3	Vertical	90	2.00	-	72.90	16.61	1.55	54.34
PK	168.71M	35.41	43.50	-8.09	-36.95	3	Vertical	124	4.00	-	72.36	15.65	1.64	54.24
PK	200.72M	32.17	43.50	-11.33	-37.27	3	Vertical	68	1.00	-	69.44	14.98	1.77	54.02
PK	254.56M	32.21	46.00	-13.79	-32.89	3	Vertical	45	1.00	-	65.10	19.16	2.01	54.06

Mode 12

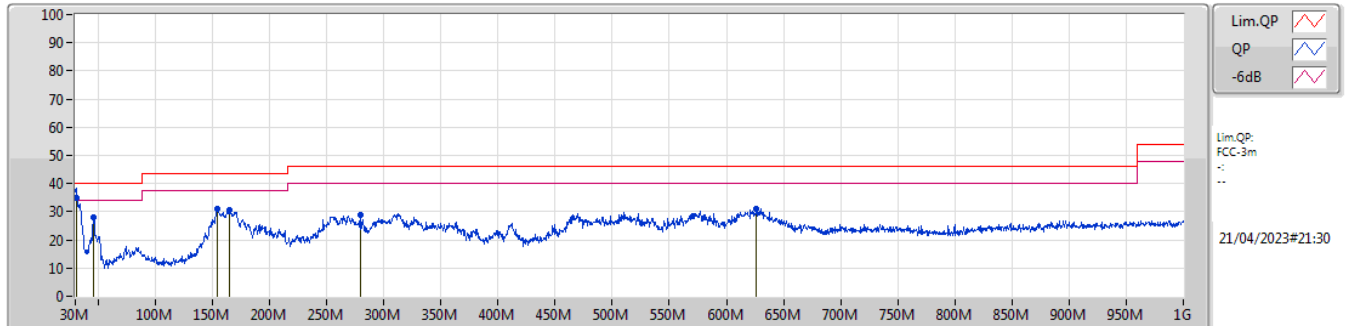

Type	Freq (Hz)	Level (dBuV/m)	Limit (dBuV/m)	Margin (dB)	Factor (dB)	Dist (m)	Condition	Azimuth (°)	Height (m)	Comment	Raw (dBuV)	AF (dB)	CL (dB)	PA (dB)
QP	30.97M	35.07	40.00	-4.93	-29.68	3	Horizontal	68	1.00	"Worst"	64.75	24.04	0.70	54.42
PK	46.01M	28.04	40.00	-11.96	-36.35	3	Horizontal	45	2.00	-	64.39	16.73	0.85	53.93
PK	154.16M	31.02	43.50	-12.48	-36.18	3	Horizontal	28	2.00	-	67.20	16.61	1.55	54.34
PK	165.32M	30.78	43.50	-12.72	-36.78	3	Horizontal	90	2.00	-	67.56	15.87	1.61	54.26
PK	279.29M	28.73	46.00	-17.27	-33.30	3	Horizontal	145	3.00	-	62.03	18.76	2.09	54.15
PK	626.07M	31.09	46.00	-14.91	-23.61	3	Horizontal	65	1.00	-	54.70	26.69	3.18	53.48



**CSE (Band Reject Filter)\_Radio 4-1T1S  
(Harmonic 1GHz ~ 3GHz)**

**Appendix F.2**

**Summary**

Mode	Result	F-Start (Hz)	F-Stop (Hz)	Type	Freq (Hz)	DG (dBi)	P1 (dBm)	Psum (dBm)	EIRP (dBm)	Limit (dBm)	Margin (dB)
2.4-2.4835GHz	-	-	-	-	-	-	-	-	-	-	-
Zigbee	Pass	1G	3G	AV	2.368G	8.80	-51.53	-51.53	-42.73	-41.20	-1.53

DG = Directional Gain ; PX=Port X; Psum=P1+P2+...PX





**CSE (Band Reject Filter)\_Radio 4-1T1S  
(Harmonic 1GHz ~ 3GHz)**

**Appendix F.2**

**Result**

Mode	Result	F-Start (Hz)	F-Stop (Hz)	Type	Freq (Hz)	DG (dBi)	P1 (dBm)	Psum (dBm)	EIRP (dBm)	Limit (dBm)	Margin (dB)
Zigbee	-	-	-	-	-	-	-	-	-	-	-
2405MHz	Pass	1G	3G	AV	2.368G	8.80	-51.53	-51.53	-42.73	-41.20	-1.53
2405MHz	Pass	1G	3G	AV	2.5G	8.80	-76.54	-76.54	-67.74	-41.20	-26.54
2405MHz	Pass	1G	3G	PK	2.366G	8.80	-46.44	-46.44	-37.64	-21.20	-16.44
2405MHz	Pass	1G	3G	PK	2.5G	8.80	-66.98	-66.98	-58.18	-21.20	-36.98
2440MHz	Pass	1G	3G	AV	2.364G	8.80	-65.04	-65.04	-56.24	-41.20	-15.04
2440MHz	Pass	1G	3G	AV	2.5G	8.80	-69.56	-69.56	-60.76	-41.20	-19.56
2440MHz	Pass	1G	3G	PK	1.422G	8.80	-55.36	-55.36	-46.56	-21.20	-25.36
2440MHz	Pass	1G	3G	PK	2.362G	8.80	-56.96	-56.96	-48.16	-21.20	-26.96
2440MHz	Pass	1G	3G	PK	2.5G	8.80	-60.55	-60.55	-51.75	-21.20	-30.55
2475MHz	Pass	1G	3G	AV	2.36G	8.80	-68.20	-68.20	-59.40	-41.20	-18.20
2475MHz	Pass	1G	3G	AV	2.498G	8.80	-65.60	-65.60	-56.80	-41.20	-15.60
2475MHz	Pass	1G	3G	PK	2.36G	8.80	-60.25	-60.25	-51.45	-21.20	-30.25
2475MHz	Pass	1G	3G	PK	2.498G	8.80	-56.39	-56.39	-47.59	-21.20	-26.39
2480MHz	Pass	1G	3G	AV	2.366G	8.80	-80.19	-80.19	-71.39	-41.20	-30.19
2480MHz	Pass	1G	3G	AV	2.496G	8.80	-73.78	-73.78	-64.98	-41.20	-23.78
2480MHz	Pass	1G	3G	PK	2.328G	8.80	-70.04	-70.04	-61.24	-21.20	-40.04
2480MHz	Pass	1G	3G	PK	2.5G	8.80	-64.80	-64.80	-56.00	-21.20	-34.80

DG = Directional Gain ; PX=Port X; Psum=P1+P2+...PX

2.4-2.4835GHz\_Zigbee

CSE Other [PK]

2405MHz

02/05/2023

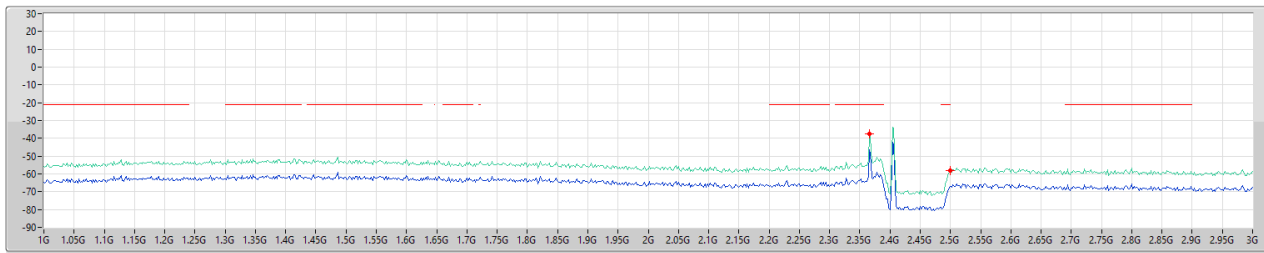

F-Start(Hz)	F-Stop(Hz)	RBW(Hz)	Type	Freq(Hz)	EIRP(dBm)	Limit(dBm)	Margin(dB)	DG(dB)	RefI(dB)	Psum(dBm)	P1(dBm)
1G	3G	1M	PK	2.366G	-37.64	-21.20	-16.44	8.80	0.00	-46.44	-46.44
1G	3G	1M	PK	2.5G	-58.18	-21.20	-36.98	8.80	0.00	-66.98	-66.98

2.4-2.4835GHz\_Zigbee

CSE Other [AV]

2405MHz

02/05/2023

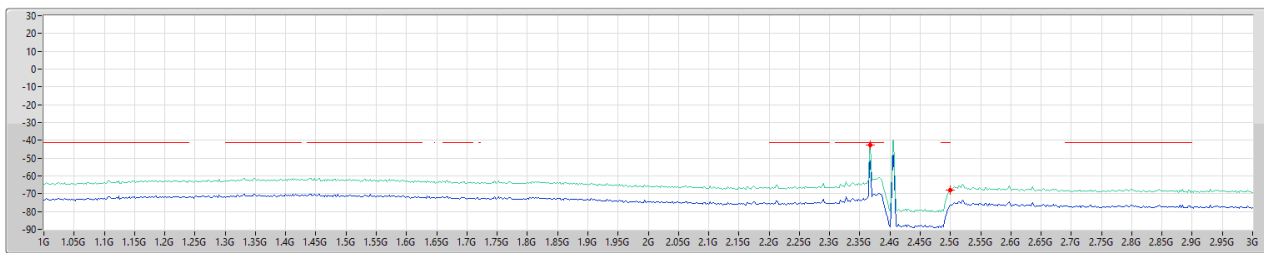

F-Start(Hz)	F-Stop(Hz)	RBW(Hz)	Type	Freq(Hz)	EIRP(dBm)	Limit(dBm)	Margin(dB)	DG(dB)	RefI(dB)	Psum(dBm)	P1(dBm)
1G	3G	1M	AV	2.366G	-42.73	-41.20	-1.53	8.80	0.00	-51.53	-51.53
1G	3G	1M	AV	2.5G	-67.74	-41.20	-26.54	8.80	0.00	-76.54	-76.54

2.4-2.4835GHz\_Zigbee

CSE Other [PK]

2440MHz

02/05/2023

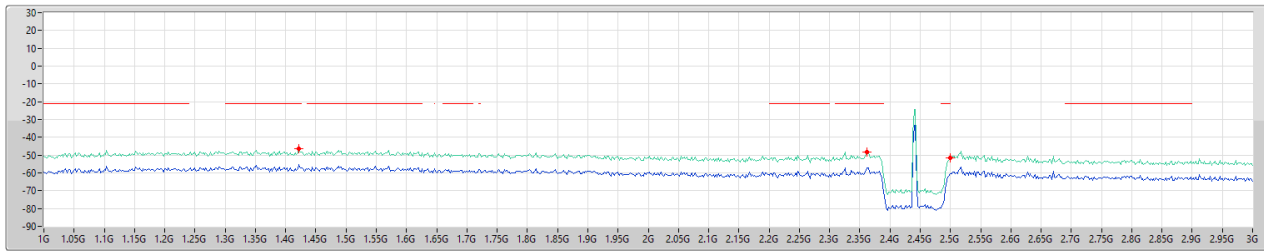

Legend for CSE Other [PK]:  
 Limit.PK (Red line)  
 EIRP.PK (Green line)  
 Port 1 (Blue line)

F-Start(Hz)	F-Stop(Hz)	RBW(Hz)	Type	Freq(Hz)	EIRP(dBm)	Limit(dBm)	Margin(dB)	DG(dB)	RefI(dB)	Psum(dBm)	P1(dBm)
1G	3G	1M	PK	1.422G	-46.56	-21.20	-25.36	8.80	0.00	-55.36	-55.36
1G	3G	1M	PK	2.362G	-48.16	-21.20	-26.96	8.80	0.00	-56.96	-56.96
1G	3G	1M	PK	2.5G	-51.75	-21.20	-30.55	8.80	0.00	-60.55	-60.55

2.4-2.4835GHz\_Zigbee

CSE Other [AV]

2440MHz

02/05/2023

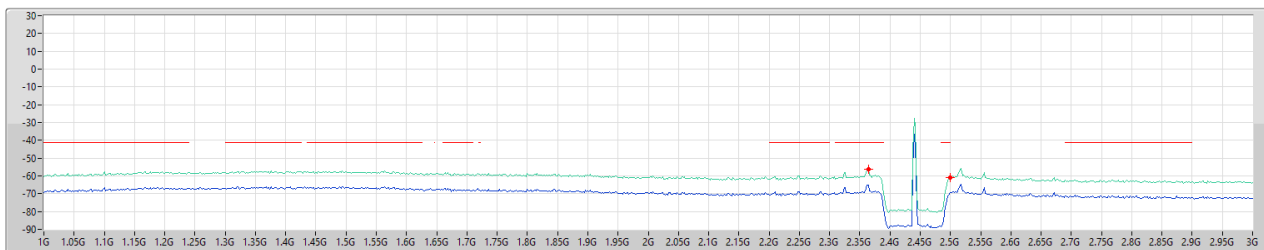

Legend for CSE Other [AV]:  
 Limit.AV (Red line)  
 EIRP.AV (Green line)  
 Port 1 (Blue line)

F-Start(Hz)	F-Stop(Hz)	RBW(Hz)	Type	Freq(Hz)	EIRP(dBm)	Limit(dBm)	Margin(dB)	DG(dB)	RefI(dB)	Psum(dBm)	P1(dBm)
1G	3G	1M	AV	2.364G	-56.24	-41.20	-15.04	8.80	0.00	-65.04	-65.04
1G	3G	1M	AV	2.5G	-60.76	-41.20	-19.56	8.80	0.00	-69.56	-69.56

2.4-2.4835GHz\_Zigbee

CSE Other [PK]

2475MHz

02/05/2023

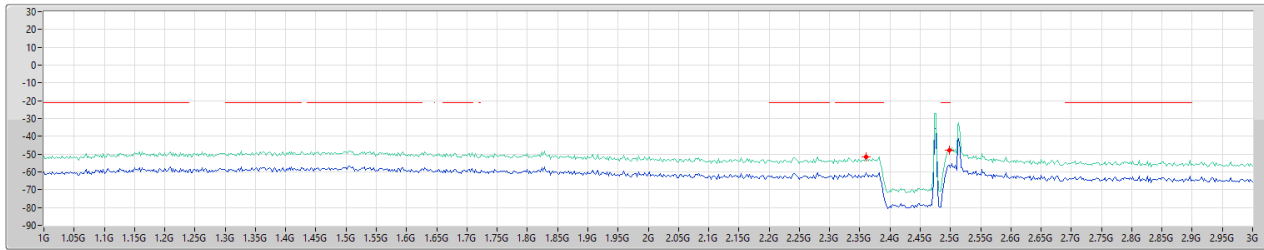

Legend for CSE Other [PK]:  
 Limit:PK (Red dashed line)  
 EIRP:PK (Green line)  
 Port 1 (Blue line)

F-Start(Hz)	F-Stop(Hz)	RBW(Hz)	Type	Freq(Hz)	EIRP(dBm)	Limit(dBm)	Margin(dB)	DG(dB)	RefI(dB)	Psum(dBm)	P1(dBm)
1G	3G	1M	PK	2.36G	-51.45	-21.20	-30.25	8.80	0.00	-60.25	-60.25
1G	3G	1M	PK	2.488G	-47.59	-21.20	-26.39	8.80	0.00	-56.39	-56.39

2.4-2.4835GHz\_Zigbee

CSE Other [AV]

2475MHz

02/05/2023

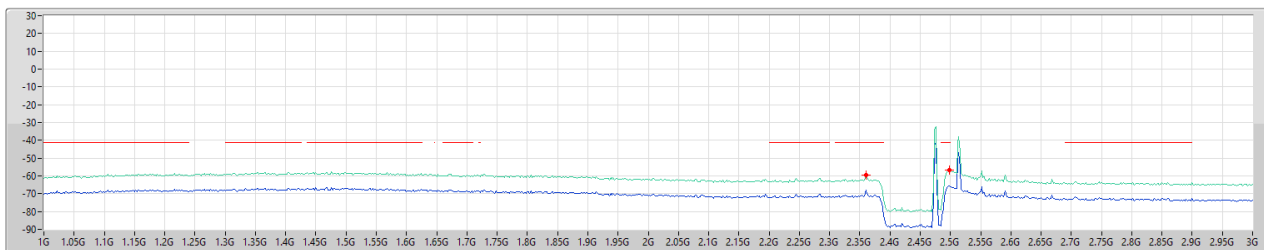

Legend for CSE Other [AV]:  
 Limit:AV (Red dashed line)  
 EIRP:AV (Green line)  
 Port 1 (Blue line)

F-Start(Hz)	F-Stop(Hz)	RBW(Hz)	Type	Freq(Hz)	EIRP(dBm)	Limit(dBm)	Margin(dB)	DG(dB)	RefI(dB)	Psum(dBm)	P1(dBm)
1G	3G	1M	AV	2.36G	-59.40	-41.20	-18.20	8.80	0.00	-68.20	-68.20
1G	3G	1M	AV	2.488G	-56.80	-41.20	-15.60	8.80	0.00	-65.60	-65.60

2.4-2.4835GHz\_Zigbee

CSE Other [PK]

2480MHz

02/05/2023

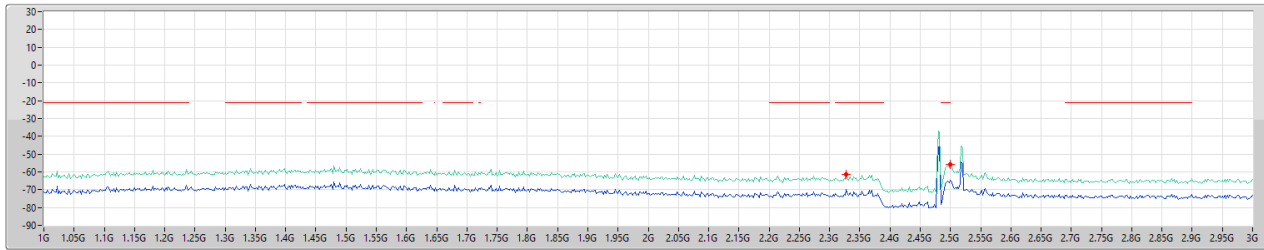

F-Start(Hz)	F-Stop(Hz)	RBW(Hz)	Type	Freq(Hz)	EIRP(dBm)	Limit(dBm)	Margin(dB)	DG(dB)	RefI(dB)	Psum(dBm)	P1(dBm)
1G	3G	1M	PK	2.328G	-61.24	-21.20	-40.04	8.80	0.00	-70.04	-70.04
1G	3G	1M	PK	2.5G	-56.00	-21.20	-34.80	8.80	0.00	-64.80	-64.80

2.4-2.4835GHz\_Zigbee

CSE Other [AV]

2480MHz

02/05/2023

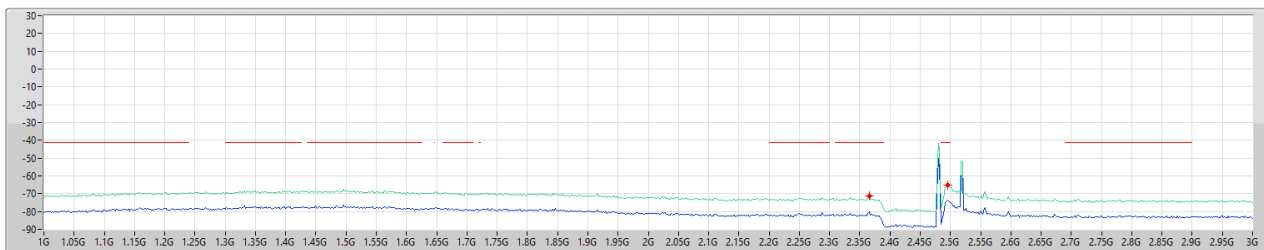

F-Start(Hz)	F-Stop(Hz)	RBW(Hz)	Type	Freq(Hz)	EIRP(dBm)	Limit(dBm)	Margin(dB)	DG(dB)	RefI(dB)	Psum(dBm)	P1(dBm)
1G	3G	1M	AV	2.366G	-71.39	-41.20	-30.19	8.80	0.00	-80.19	-80.19
1G	3G	1M	AV	2.496G	-64.98	-41.20	-23.78	8.80	0.00	-73.78	-73.78



**CSE (High Pass Filter)\_Radio 4-1T1S  
(Harmonic 3GHz ~ 25GHz)**

**Appendix F.3**

**Summary**

Mode	Result	F-Start (Hz)	F-Stop (Hz)	Type	Freq (Hz)	DG (dBi)	P1 (dBm)	Psum (dBm)	EIRP (dBm)	Limit (dBm)	Margin (dB)
2.4-2.4835GHz	-	-	-	-	-	-	-	-	-	-	-
Zigbee	Pass	3G	25G	AV	7.32025G	8.80	-62.08	-62.08	-53.28	-41.20	-12.08

DG = Directional Gain ; PX=Port X; Psum=P1+P2+...PX



**CSE (High Pass Filter)\_Radio 4-1T1S  
(Harmonic 3GHz ~ 25GHz)**

**Appendix F.3**

**Result**

Mode	Result	F-Start (Hz)	F-Stop (Hz)	Type	Freq (Hz)	DG (dBi)	P1 (dBm)	Psum (dBm)	EIRP (dBm)	Limit (dBm)	Margin (dB)
Zigbee	-	-	-	-	-	-	-	-	-	-	-
2405MHz	Pass	3G	25G	AV	3.26125G	8.80	-80.03	-80.03	-71.23	-41.20	-30.03
2405MHz	Pass	3G	25G	AV	4.8095G	8.80	-82.60	-82.60	-73.80	-41.20	-32.60
2405MHz	Pass	3G	25G	PK	3.264G	8.80	-70.52	-70.52	-61.72	-21.20	-40.52
2405MHz	Pass	3G	25G	PK	4.8095G	8.80	-76.05	-76.05	-67.25	-21.20	-46.05
2440MHz	Pass	3G	25G	AV	4.87825G	8.80	-83.94	-83.94	-75.14	-41.20	-33.94
2440MHz	Pass	3G	25G	AV	7.32025G	8.80	-62.08	-62.08	-53.28	-41.20	-12.08
2440MHz	Pass	3G	25G	PK	4.87825G	8.80	-74.56	-74.56	-65.76	-21.20	-44.56
2440MHz	Pass	3G	25G	PK	7.32025G	8.80	-54.66	-54.66	-45.86	-21.20	-24.66
2475MHz	Pass	3G	25G	AV	4.94975G	8.80	-83.40	-83.40	-74.60	-41.20	-33.40
2475MHz	Pass	3G	25G	AV	7.422G	8.80	-65.62	-65.62	-56.82	-41.20	-15.62
2475MHz	Pass	3G	25G	PK	4.94975G	8.80	-75.24	-75.24	-66.44	-21.20	-45.24
2475MHz	Pass	3G	25G	PK	7.42475G	8.80	-58.09	-58.09	-49.29	-21.20	-28.09
2480MHz	Pass	3G	25G	AV	4.958G	8.80	-83.43	-83.43	-74.63	-41.20	-33.43
2480MHz	Pass	3G	25G	AV	7.44125G	8.80	-78.60	-78.60	-69.80	-41.20	-28.60
2480MHz	Pass	3G	25G	PK	4.9635G	8.80	-75.83	-75.83	-67.03	-21.20	-45.83
2480MHz	Pass	3G	25G	PK	7.4385G	8.80	-71.07	-71.07	-62.27	-21.20	-41.07

DG = Directional Gain ; PX=Port X; Psum=P1+P2+...PX

2.4-2.4835GHz\_Zigbee

CSE [PK]

2405MHz

02/05/2023

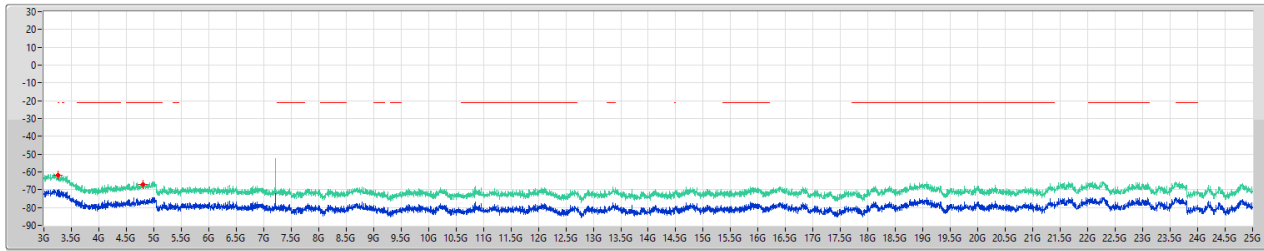

Limit.PK  
ERP.PK  
Port.1

F-Start(Hz)	F-Stop(Hz)	RBW(Hz)	Type	Freq(Hz)	EIRP(dBm)	Limit(dBm)	Margin(dB)	DG(dB)	Ref(dB)	Psum(dBm)	P1(dBm)
3G	25G	1M	PK	3.264G	-61.72	-21.20	-40.52	8.80	0.00	-70.52	-70.52
3G	25G	1M	PK	4.8095G	-67.25	-21.20	-46.05	8.80	0.00	-76.05	-76.05

2.4-2.4835GHz\_Zigbee

CSE [AV]

2405MHz

02/05/2023

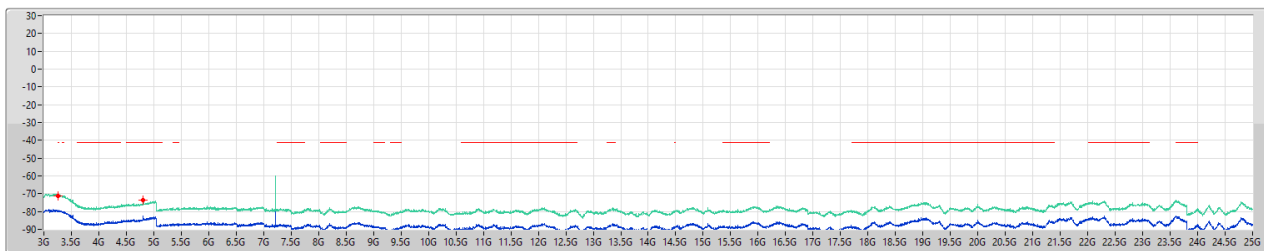

Limit.AV  
ERP.AV  
Port.1

F-Start(Hz)	F-Stop(Hz)	RBW(Hz)	Type	Freq(Hz)	EIRP(dBm)	Limit(dBm)	Margin(dB)	DG(dB)	Ref(dB)	Psum(dBm)	P1(dBm)
3G	25G	1M	AV	3.26125G	-71.23	-41.20	-30.03	8.80	0.00	-80.03	-80.03
3G	25G	1M	AV	4.8095G	-73.80	-41.20	-32.60	8.80	0.00	-82.60	-82.60



2.4-2.4835GHz\_Zigbee

CSE [PK]

2440MHz

02/05/2023

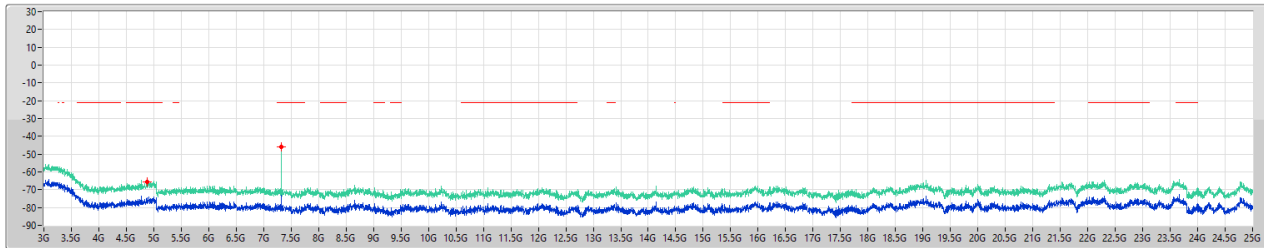

Limit:PK   
 EIRP:PK   
 Port 1 

F-Start(Hz)	F-Stop(Hz)	RBW(Hz)	Type	Freq(Hz)	EIRP(dBm)	Limit(dBm)	Margin(dB)	DG(dB)	Ref1(dB)	Psum(dBm)	P1(dBm)
3G	25G	1M	PK	4.87825G	-65.76	-21.20	-44.56	8.80	0.00	-74.56	-74.56
3G	25G	1M	PK	7.32025G	-45.86	-21.20	-24.66	8.80	0.00	-54.66	-54.66



2.4-2.4835GHz\_Zigbee

CSE [AV]

2440MHz

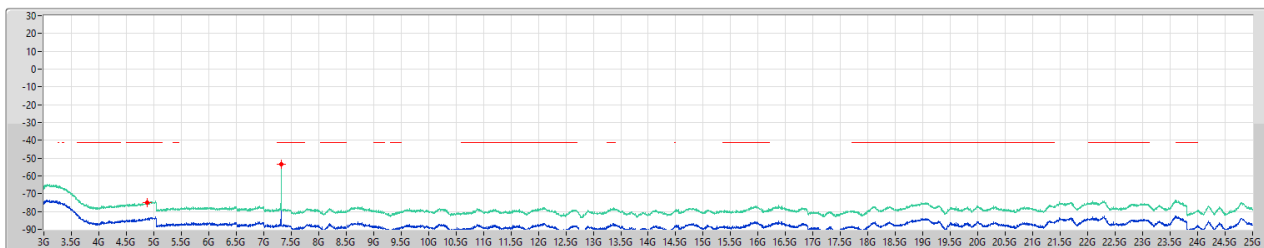
02/05/2023



Limit:AV   
 EIRP:AV   
 Port 1 

F-Start(Hz)	F-Stop(Hz)	RBW(Hz)	Type	Freq(Hz)	EIRP(dBm)	Limit(dBm)	Margin(dB)	DG(dB)	Ref1(dB)	Psum(dBm)	P1(dBm)
3G	25G	1M	AV	4.87825G	-75.14	-41.20	-33.94	8.80	0.00	-83.94	-83.94
3G	25G	1M	AV	7.32025G	-53.28	-41.20	-12.08	8.80	0.00	-62.08	-62.08

2.4-2.4835GHz\_Zigbee

CSE [PK]

2475MHz

02/05/2023

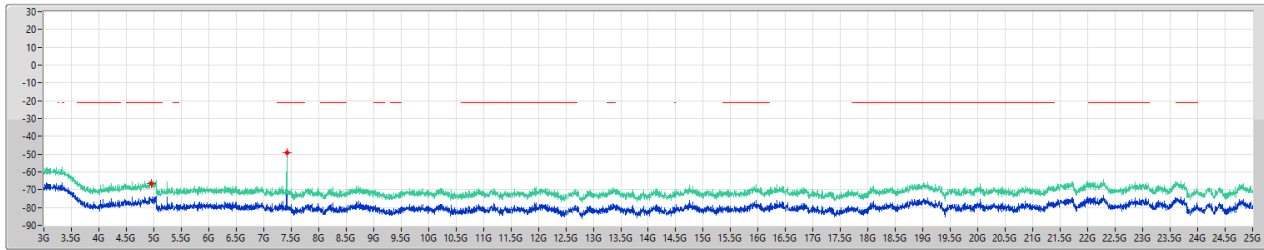

Limit:PK

ERP:PK

Port 1

F-Start(Hz)	F-Stop(Hz)	RBW(Hz)	Type	Freq(Hz)	EIRP(dBm)	Limit(dBm)	Margin(dB)	DG(dB)	RefI(dB)	Psum(dBm)	P1(dBm)
3G	25G	1M	PK	4.94975G	-66.44	-21.20	-45.24	8.80	0.00	-75.24	-75.24
3G	25G	1M	PK	7.42475G	-49.29	-21.20	-28.09	8.80	0.00	-58.09	-58.09

2.4-2.4835GHz\_Zigbee

CSE [AV]

2475MHz

02/05/2023

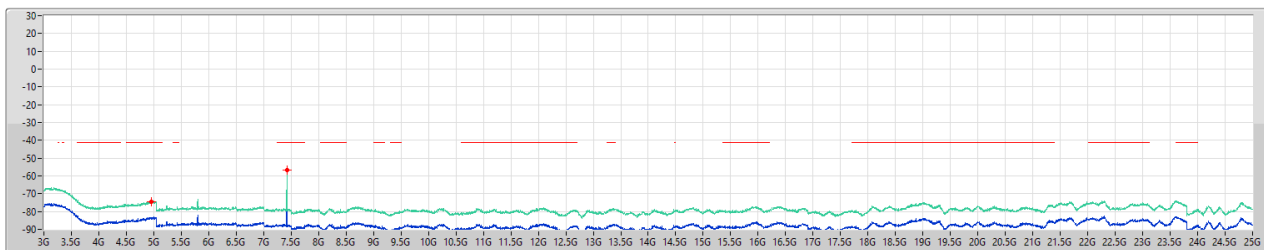

Limit:AV

ERP:AV

Port 1

F-Start(Hz)	F-Stop(Hz)	RBW(Hz)	Type	Freq(Hz)	EIRP(dBm)	Limit(dBm)	Margin(dB)	DG(dB)	RefI(dB)	Psum(dBm)	P1(dBm)
3G	25G	1M	AV	4.94975G	-74.60	-41.20	-33.40	8.80	0.00	-83.40	-83.40
3G	25G	1M	AV	7.4222G	-56.82	-41.20	-15.62	8.80	0.00	-65.62	-65.62

2.4-2.4835GHz\_Zigbee

CSE [PK]

2480MHz

02/05/2023

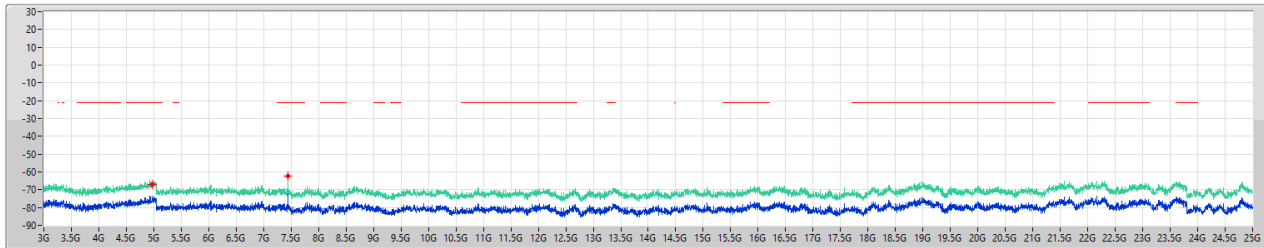

Legend for CSE [PK]:  
 Limit:PK (Red dashed line)  
 ERP:PK (Green line)  
 Port 1 (Blue line)

F-Start(Hz)	F-Stop(Hz)	RBW(Hz)	Type	Freq(Hz)	EIRP(dBm)	Limit(dBm)	Margin(dB)	DG(dB)	RefI(dB)	Psum(dBm)	P1(dBm)
3G	25G	1M	PK	4.9635G	-67.03	-21.20	-45.83	8.80	0.00	-75.83	-75.83
3G	25G	1M	PK	7.4385G	-62.27	-21.20	-41.07	8.80	0.00	-71.07	-71.07

2.4-2.4835GHz\_Zigbee

CSE [AV]

2480MHz

02/05/2023

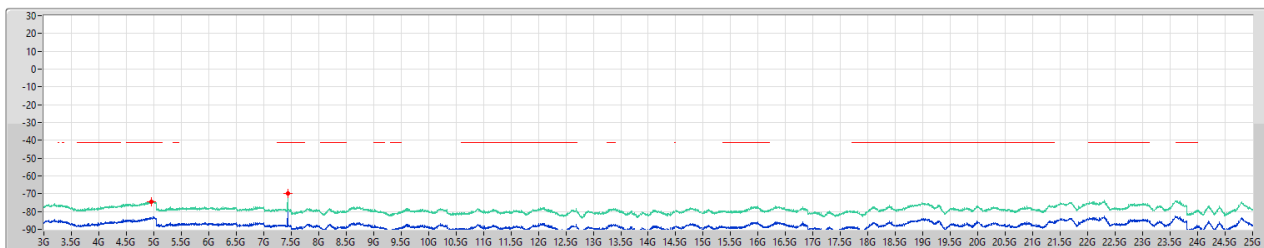

Legend for CSE [AV]:  
 Limit:AV (Red dashed line)  
 ERP:AV (Green line)  
 Port 1 (Blue line)

F-Start(Hz)	F-Stop(Hz)	RBW(Hz)	Type	Freq(Hz)	EIRP(dBm)	Limit(dBm)	Margin(dB)	DG(dB)	RefI(dB)	Psum(dBm)	P1(dBm)
3G	25G	1M	AV	4.958G	-74.63	-41.20	-33.43	8.80	0.00	-83.43	-83.43
3G	25G	1M	AV	7.44125G	-69.80	-41.20	-28.60	8.80	0.00	-78.60	-78.60



Summary

Mode	Result	F-Start (Hz)	F-Stop (Hz)	Type	Freq (Hz)	DG (dBi)	P1 (dBm)	Psum (dBm)	EIRP (dBm)	Limit (dBm)	Margin (dB)
2.4-2.4835GHz	-	-	-	-	-	-	-	-	-	-	-
Zigbee	Pass	2.39G	2.4935G	AV	2.48356G	8.80	-50.21	-50.21	-41.41	-41.20	-0.21

DG = Directional Gain ; PX=Port X; Psum=P1+P2+...PX



Result

Mode	Result	F-Start (Hz)	F-Stop (Hz)	Type	Freq (Hz)	DG (dBi)	P1 (dBm)	Psum (dBm)	EIRP (dBm)	Limit (dBm)	Margin (dB)
Zigbee	-	-	-	-	-	-	-	-	-	-	-
2405MHz	Pass	2.39G	2.4935G	AV	2.39G	8.80	-61.46	-61.46	-52.66	-41.20	-11.46
2405MHz	Pass	2.39G	2.4935G	AV	2.49143G	8.80	-63.28	-63.28	-54.48	-41.20	-13.28
2405MHz	Pass	2.39G	2.4935G	PK	2.39G	8.80	-49.66	-49.66	-40.86	-21.20	-19.66
2405MHz	Pass	2.39G	2.4935G	PK	2.48781G	8.80	-50.36	-50.36	-41.56	-21.20	-20.36
2440MHz	Pass	2.39G	2.4935G	AV	2.39G	8.80	-63.23	-63.23	-54.43	-41.20	-13.23
2440MHz	Pass	2.39G	2.4935G	AV	2.48398G	8.80	-62.81	-62.81	-54.01	-41.20	-12.81
2440MHz	Pass	2.39G	2.4935G	PK	2.39G	8.80	-51.94	-51.94	-43.14	-21.20	-21.94
2440MHz	Pass	2.39G	2.4935G	PK	2.48822G	8.80	-49.00	-49.00	-40.20	-21.20	-19.00
2475MHz	Pass	2.39G	2.4935G	AV	2.39G	8.80	-63.48	-63.48	-54.68	-41.20	-13.48
2475MHz	Pass	2.39G	2.4935G	AV	2.48356G	8.80	-50.64	-50.64	-41.84	-41.20	-0.64
2475MHz	Pass	2.39G	2.4935G	PK	2.39G	8.80	-51.14	-51.14	-42.34	-21.20	-21.14
2475MHz	Pass	2.39G	2.4935G	PK	2.48367G	8.80	-38.78	-38.78	-29.98	-21.20	-8.78
2480MHz	Pass	2.39G	2.4935G	AV	2.39G	8.80	-64.13	-64.13	-55.33	-41.20	-14.13
2480MHz	Pass	2.39G	2.4935G	AV	2.48356G	8.80	-50.21	-50.21	-41.41	-41.20	-0.21
2480MHz	Pass	2.39G	2.4935G	PK	2.39G	8.80	-51.80	-51.80	-43.00	-21.20	-21.80
2480MHz	Pass	2.39G	2.4935G	PK	2.48356G	8.80	-37.52	-37.52	-28.72	-21.20	-7.52

DG = Directional Gain ; PX=Port X; Psum=P1+P2+...PX

2.4-2.4835GHz\_Zigbee

CSE Bandedge [PK]

2405MHz

02/05/2023

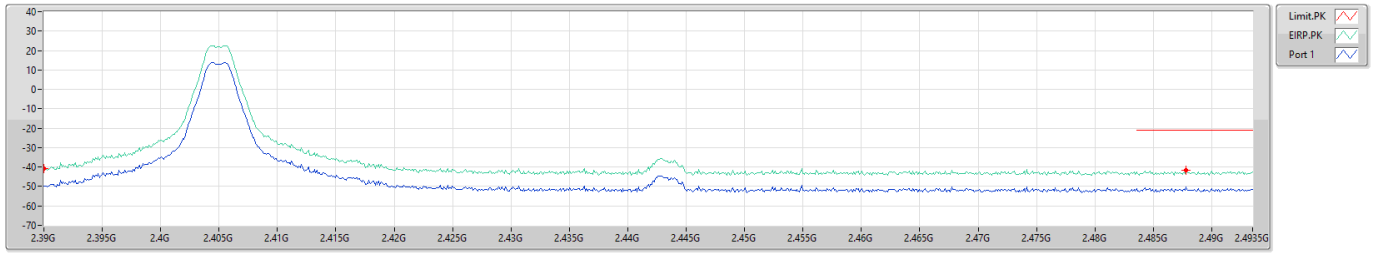

F-Start(Hz)	F-Stop(Hz)	RBW(Hz)	Type	Freq(Hz)	EIRP(dBm)	Limit(dBm)	Margin(dB)	DG(dB)	Ref(dB)	Psum(dBm)	P1(dBm)
2.39G	2.4935G	1M	PK	2.39G	-40.86	-21.20	-19.66	8.80	0.00	-49.66	-49.66
2.39G	2.4935G	1M	PK	2.48781G	-41.56	-21.20	-20.36	8.80	0.00	-50.36	-50.36

2.4-2.4835GHz\_Zigbee

CSE Bandedge [AV]

2405MHz

02/05/2023

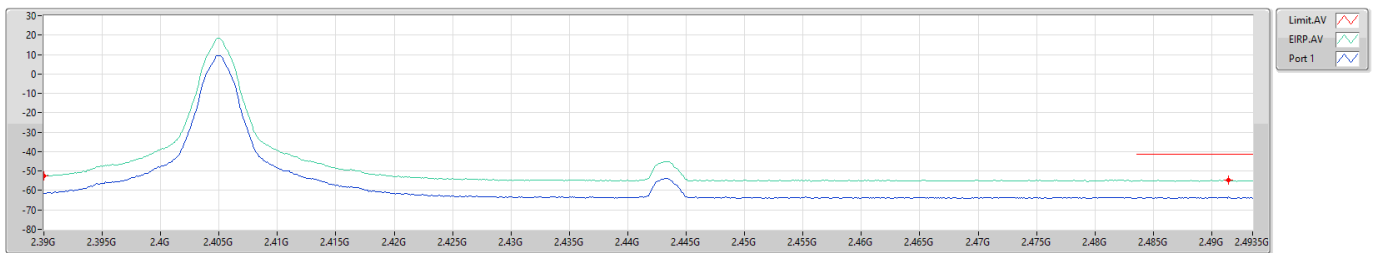

F-Start(Hz)	F-Stop(Hz)	RBW(Hz)	Type	Freq(Hz)	EIRP(dBm)	Limit(dBm)	Margin(dB)	DG(dB)	Ref(dB)	Psum(dBm)	P1(dBm)
2.39G	2.4935G	1M	AV	2.39G	-52.66	-41.20	-11.46	8.80	0.00	-61.46	-61.46
2.39G	2.4935G	1M	AV	2.49143G	-54.48	-41.20	-13.28	8.80	0.00	-63.28	-63.28

2.4-2.4835GHz\_Zigbee

CSE Bandedge [PK]

2440MHz

02/05/2023

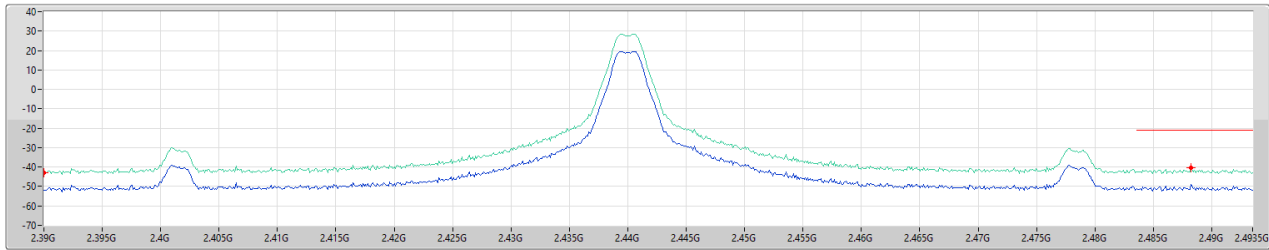

F-Start(Hz)	F-Stop(Hz)	RBW(Hz)	Type	Freq(Hz)	EIRP(dBm)	Limit(dBm)	Margin(dB)	DG(dB)	Ref1(dB)	Psum(dBm)	P1(dBm)
2.39G	2.4935G	1M	PK	2.39G	-43.14	-21.20	-21.94	8.80	0.00	-51.94	-51.94
2.39G	2.4935G	1M	PK	2.48822G	-40.20	-21.20	-19.00	8.80	0.00	-49.00	-49.00

2.4-2.4835GHz\_Zigbee

CSE Bandedge [AV]

2440MHz

02/05/2023

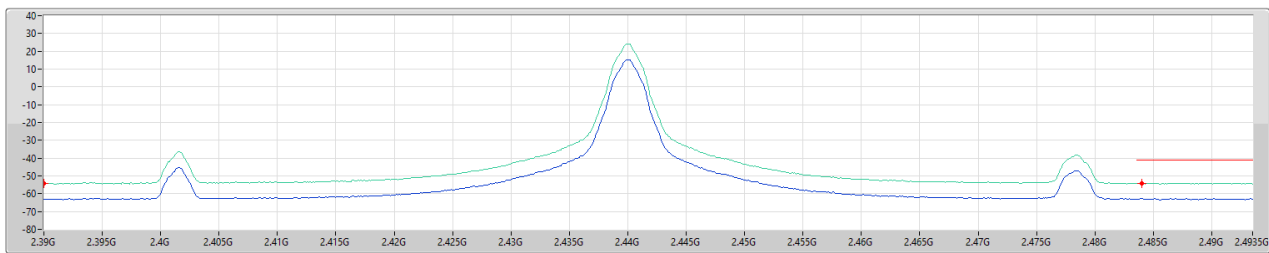

F-Start(Hz)	F-Stop(Hz)	RBW(Hz)	Type	Freq(Hz)	EIRP(dBm)	Limit(dBm)	Margin(dB)	DG(dB)	Ref1(dB)	Psum(dBm)	P1(dBm)
2.39G	2.4935G	1M	AV	2.39G	-54.43	-41.20	-13.23	8.80	0.00	-63.23	-63.23
2.39G	2.4935G	1M	AV	2.48398G	-54.01	-41.20	-12.81	8.80	0.00	-62.81	-62.81

2.4-2.4835GHz\_Zigbee

CSE Bandedge [PK]

2475MHz

02/05/2023

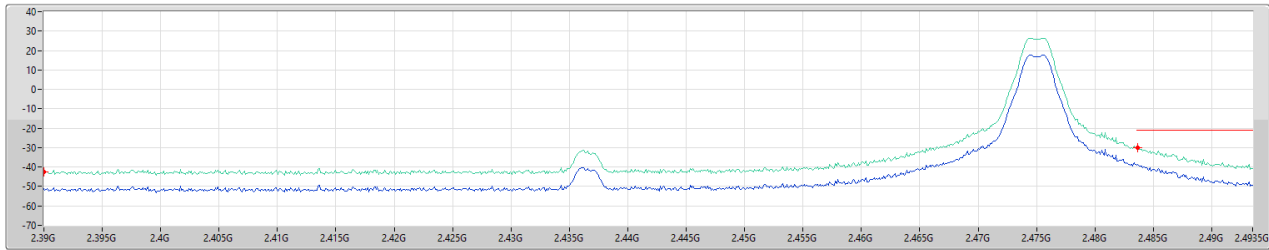

F-Start(Hz)	F-Stop(Hz)	RBW(Hz)	Type	Freq(Hz)	EIRP(dBm)	Limit(dBm)	Margin(dB)	DG(dB)	RefI(dB)	Psum(dBm)	P1(dBm)
2.39G	2.4935G	1M	PK	2.39G	-42.34	-21.20	-21.14	8.80	0.00	-51.14	-51.14
2.39G	2.4935G	1M	PK	2.48367G	-29.98	-21.20	-8.78	8.80	0.00	-38.78	-38.78

2.4-2.4835GHz\_Zigbee

CSE Bandedge [AV]

2475MHz

02/05/2023

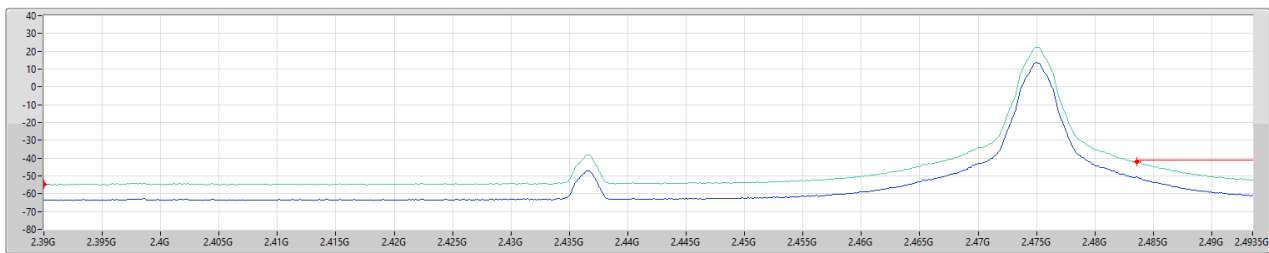

F-Start(Hz)	F-Stop(Hz)	RBW(Hz)	Type	Freq(Hz)	EIRP(dBm)	Limit(dBm)	Margin(dB)	DG(dB)	RefI(dB)	Psum(dBm)	P1(dBm)
2.39G	2.4935G	1M	AV	2.39G	-54.68	-41.20	-13.48	8.80	0.00	-63.48	-63.48
2.39G	2.4935G	1M	AV	2.48356G	-41.84	-41.20	-0.64	8.80	0.00	-50.64	-50.64



2.4-2.4835GHz\_Zigbee

CSE Bandedge [PK]

2480MHz

02/05/2023

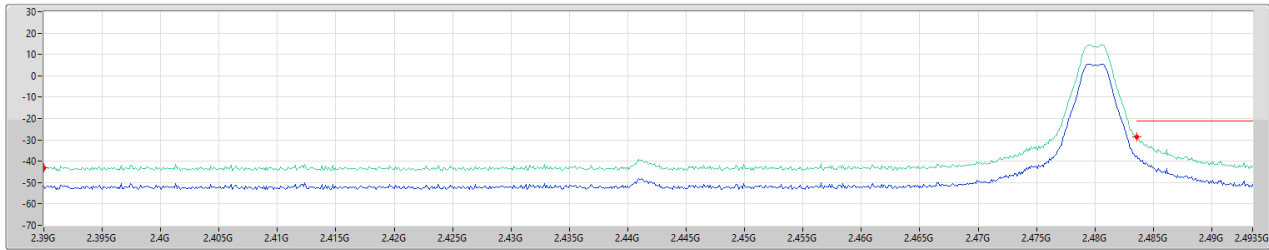

F-Start(Hz)	F-Stop(Hz)	RBW(Hz)	Type	Freq(Hz)	EIRP(dBm)	Limit(dBm)	Margin(dB)	DG(dB)	Ref1(dB)	Psum(dBm)	P1(dBm)
2.39G	2.4935G	1M	PK	2.39G	-43.00	-21.20	-21.80	8.80	0.00	-51.80	-51.80
2.39G	2.4935G	1M	PK	2.48356G	-28.72	-21.20	-7.52	8.80	0.00	-37.52	-37.52

2.4-2.4835GHz\_Zigbee

CSE Bandedge [AV]

2480MHz

02/05/2023

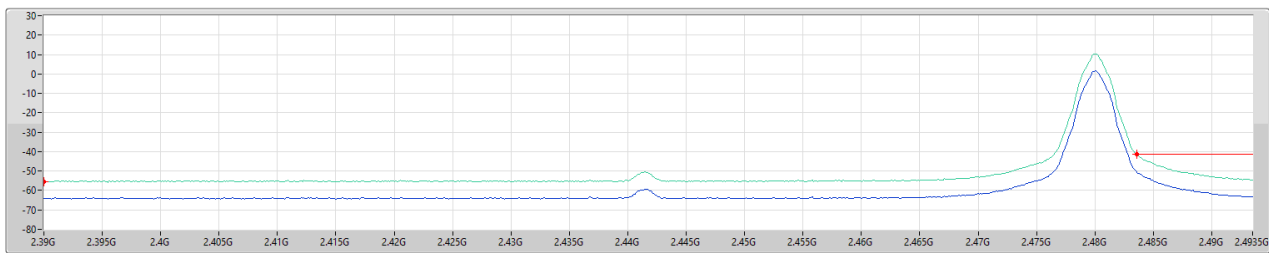

F-Start(Hz)	F-Stop(Hz)	RBW(Hz)	Type	Freq(Hz)	EIRP(dBm)	Limit(dBm)	Margin(dB)	DG(dB)	Ref1(dB)	Psum(dBm)	P1(dBm)
2.39G	2.4935G	1M	AV	2.39G	-55.33	-41.20	-14.13	8.80	0.00	-64.13	-64.13
2.39G	2.4935G	1M	AV	2.48356G	-41.41	-41.20	-0.21	8.80	0.00	-50.21	-50.21



Summary

Mode	Result	Type	Freq (Hz)	Level (dBuV/m)	Limit (dBuV/m)	Margin (dB)	Dist (m)	Condition	Azimuth (°)	Height (m)	Comments
2.4-2.4835GHz	-	-	-	-	-	-	-	-	-	-	-
Zigbee	Pass	AV	12.1946G	43.85	54.00	-10.15	3	Horizontal	228	1.80	-

2.4-2.4835GHz\_Zigbee

2440MHz\_TX

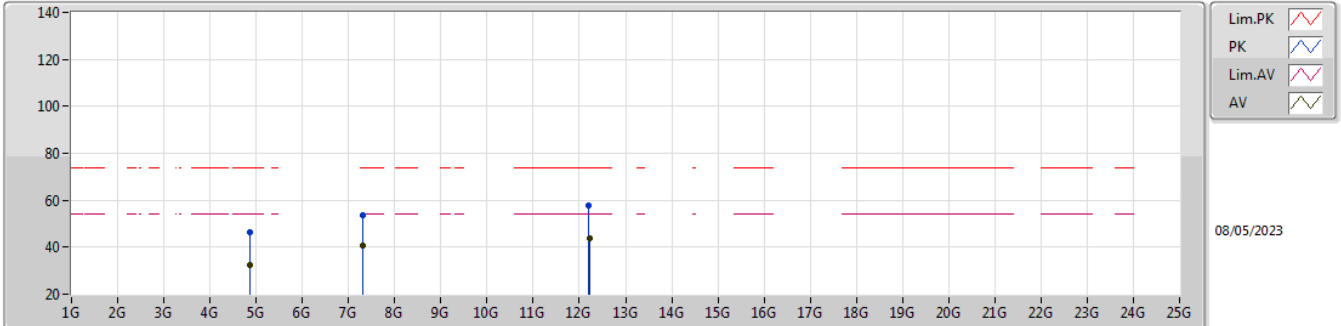

EUT\_Z\_1TX  
Setting 20  
06-D-A-4

Type	Freq (Hz)	Level (dBuV/m)	Limit (dBuV/m)	Margin (dB)	Raw (dBuV)	Dist (m)	Condition	Azimuth (°)	Height (m)	Comment	AF (dB)	CL (dB)	PA (dB)
PK	4.87724G	46.33	74.00	-27.67	40.65	3	Vertical	166	1.80	-	31.40	6.78	32.50
AV	4.87184G	32.51	54.00	-21.49	26.83	3	Vertical	166	1.80	-	31.40	6.78	32.50
PK	7.3218G	53.64	74.00	-20.36	42.32	3	Vertical	353	1.00	-	36.70	8.07	33.45
AV	7.32174G	40.71	54.00	-13.29	29.39	3	Vertical	353	1.00	-	36.70	8.07	33.45
PK	12.18632G	57.75	74.00	-16.25	42.79	3	Vertical	160	1.80	-	39.11	10.54	34.69
AV	12.21446G	43.84	54.00	-10.16	28.92	3	Vertical	160	1.80	-	39.06	10.55	34.69

2.4-2.4835GHz\_Zigbee

2440MHz\_TX

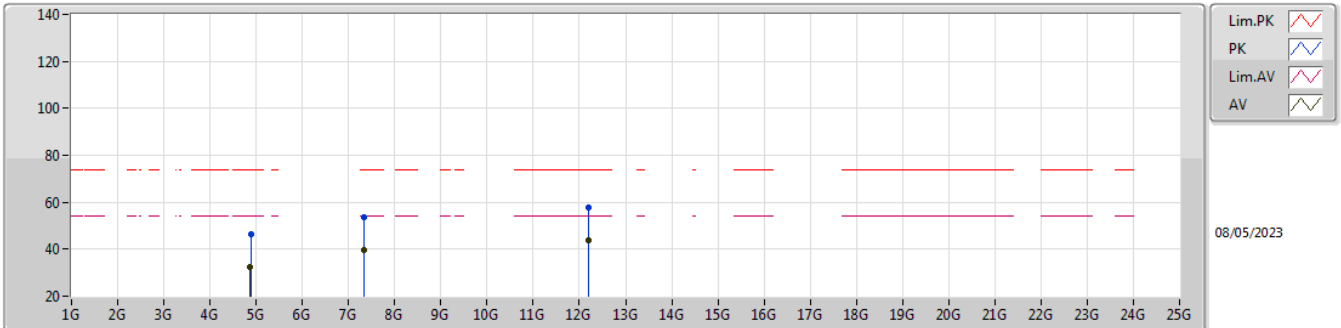

EUT\_Z\_1TX  
 Setting 20  
 06-D-A-4

Type	Freq (Hz)	Level (dBuV/m)	Limit (dBuV/m)	Margin (dB)	Raw (dBuV)	Dist (m)	Condition	Azimuth (°)	Height (m)	Comment	AF (dB)	CL (dB)	PA (dB)
PK	4.88912G	46.39	74.00	-27.61	40.70	3	Horizontal	201	1.80	-	31.40	6.78	32.49
AV	4.87466G	32.51	54.00	-21.49	26.83	3	Horizontal	201	1.80	-	31.40	6.78	32.50
PK	7.33104G	53.40	74.00	-20.60	42.10	3	Horizontal	166	1.80	-	36.70	8.06	33.46
AV	7.33284G	39.47	54.00	-14.53	28.19	3	Horizontal	166	1.80	-	36.70	8.05	33.47
PK	12.18866G	57.69	74.00	-16.31	42.73	3	Horizontal	228	1.80	-	39.11	10.54	34.69
AV	12.1946G	43.85	54.00	-10.15	28.89	3	Horizontal	228	1.80	-	39.11	10.54	34.69