



PHOENIX
TESTLAB

Königswinkel 10
32825 Blomberg, Germany
Phone: +49 (0) 52 35 / 95 00-0
Fax: +49 (0) 52 35 / 95 00-10
office@phoenix-testlab.de
www.phoenix-testlab.de

Test Report

Report Number:

F190629E4

Equipment under Test (EUT):

VU113

BTLE Display (EUT within aluminium housing and pressure sensor)

Applicant:

Endress+Hauser SE+Co. KG

Manufacturer:

Endress+Hauser SE+Co. KG



Deutsche
Akkreditierungsstelle
D-PL-17186-01-01
D-PL-17186-01-02
D-PL-17186-01-03

References

- [1] **ANSI C63.10-2013**, American National Standard of Procedures for Compliance Testing of Unlicensed Wireless Devices
- [2] **FCC CFR 47 Part 15**, Radio Frequency Devices
- [3] **RSS-247 Issue 2 (March 2017)**, Digital Transmission Systems (DTSs), Frequency Hopping Systems (FHSs) and Licence-Exempt Local Area Network (LE-LAN) Devices
- [4] **RSS-Gen Issue 5 (March 2019)**, General Requirements for Compliance of Radio Apparatus

Test Result

The requirements of the tests performed as shown in the overview (clause 0) were fulfilled by the equipment under test.

The complete test results are presented in the following.

Test engineer:	Paul NEUFELD <small>Name</small>	 <small>Signature</small>	13.11.2019 <small>Date</small>
Authorized reviewer:	Bernd Steiner <small>Name</small>	 <small>Signature</small>	13.11.2019 <small>Date</small>

This test report is only valid in its original form.

Any reproduction of its contents in extracts without written permission of the accredited test laboratory PHOENIX TESTLAB GmbH is prohibited.

The test results herein refer only to the tested sample. PHOENIX TESTLAB GmbH is not responsible for any generalisations or conclusions drawn from these test results concerning further samples. Any modification of the tested samples is prohibited and leads to the invalidity of this test report. Each page necessarily contains the PHOENIX TESTLAB Logo and the TEST REPORT NUMBER.

This test report is valid in hardcopy form as well as in electronic form.

Contents

Page

1	Identification	4
1.1	Applicant.....	4
1.2	Manufacturer	4
1.3	Test Laboratory	4
1.4	EUT (Equipment Under Test).....	5
1.5	Technical Data of Equipment	6
1.6	Dates	6
2	Operational States	7
3	Additional Information	8
4	Overview.....	9
5	Results.....	10
5.1	Duty cycle	10
5.1.1	Test results	11
5.2	Maximum conducted output power	12
5.2.1	Method of measurement.....	12
5.2.2	Test results	13
5.3	DTS Bandwidth / 99% Bandwidth	14
5.3.1	Method of measurement.....	14
5.3.2	Test result.....	15
5.4	Average Power Spectral Density	17
5.4.1	Method of measurement.....	17
5.4.2	Test result	18
5.5	Band-edge compliance.....	19
5.5.1	Method of measurement (band edges next to unrestricted bands (radiated))	19
5.5.2	Test result (band edges next to unrestricted bands (radiated))	20
5.5.3	Method of measurement (band edges next to restricted bands (radiated))	21
5.5.4	Test result (band edges next to restricted bands (radiated))	21
5.6	Maximum unwanted emissions	23
5.6.1	Method of measurement (radiated emissions)	23
5.6.2	Test results (radiated emissions) – Emissions with internal antenna from 30 MHz – 26.5 GHz 30	
5.7	Conducted emissions on power supply lines (150 kHz to 30 MHz)	36
6	Test equipment and ancillaries used for tests	37
7	Test site Validation	38
8	Report History.....	38
9	List of Annexes	38

1 Identification

1.1 Applicant

Name:	Endress+Hauser SE+Co. KG
Address:	Hauptstr. 1, 79689 Maulburg
Country:	Germany
Name for contact purposes:	Mr. Ralph STIB
Phone:	+49 7622-28-1943
eMail Address:	ralph.stib@endress.com
Applicant represented during the test by the following person:	None

1.2 Manufacturer

Name:	Endress+Hauser SE+Co. KG
Address:	Hauptstr. 1, 79689 Maulburg
Country:	Germany
Name for contact purposes:	Mr. Ralph STIB
Phone:	+49 7622-28-1943
eMail Address:	ralph.stib@endress.com
Applicant represented during the test by the following person:	None

1.3 Test Laboratory

The tests were carried out by: **PHOENIX TESTLAB GmbH**
Königswinkel 10
32825 Blomberg
Germany

Accredited by Deutsche Akkreditierungsstelle GmbH (DAkkS) in compliance with DIN EN ISO/IEC 17025 under Reg. No. D-PL-17186-01-05 and D-PL-17186-01-06, FCC Test Firm Accreditation designation number DE0004, FCC Test Firm Registration Number 469623, CAB Identifier DE0003 and ISED# 3469A.

1.4 EUT (Equipment Under Test)

Test object: *	VU113 BTLE Display within aluminium housing and pressure sensor: <ul style="list-style-type: none"> - 1-Chamber Aluminium Housing, non ExD („PMP51B_P2_002“) - Aluminium-Cover with plastic inspection glass - Cerabar Sensor - 1 Bar .. 1 Bar - A_MU101A_057 Main Unit with EVO SW 00.00.26, Device Tag: “EVO2”
Type / PMN: *	VU113
FCC ID: *	LCGVU113
IC: *	2519A-VU113
Serial number: *	VU113_A_05 / VU113_A_03
EUT marking: *	EUT with temporary antenna connector: VU113_A_05 EUT with internal antenna: VE113A_A_03
PCB identifier: *	71374885 a
HVIN (Hardware Version Identification Number): *	VU113
FVIN (Firmware Version Identification Number): *	S132 - Ver. 6.1.1
Hardware version: *	VU113_A
Software version: *	Nordic DTM Software

* The IDs only apply to the BTLE display and not to the representative housing, or the combination of BTLE display and the housing.

Note: Phoenix Testlab GmbH does not take samples. The samples used for tests are provided exclusively by the applicant.

Bluetooth Low Energy radio channels:

Channel 0	RX:	2402 MHz	TX:	2402 MHz
Channel 19	RX:	2440 MHz	TX:	2440 MHz
Channel 39	RX:	2480 MHz	TX:	2480 MHz

1.5 Technical Data of Equipment

Fulfills specifications: *	Bluetooth 4.2 low energy only					
Antenna type: *	PCB antenna					
Antenna name: *	-					
Antenna gain: *	< 0 dBi					
Antenna connector: *	None					
Supply voltage EUT: *	U _{nom} =	3.2 V DC	U _{min} =	3.1 V DC	U _{max} =	3.4 V DC
Type of modulation: *	GFSK (1 Mbps only)					
Operating frequency range:*	Both units: 2402 – 2480 MHz					
Number of channels: *	40					
Temperature range: *	-52 °C to +85 °C					
Lowest / highest Internal clock frequency: *	11.0592 MHz (ancillary device), 32 MHz (EUT) / 2480 MHz					

* Declared by the applicant

Ancillary Equipment	
Cables (connected to the EUT): *1	USB cable with serial to USB converter (~ 1.5m)
USB extension: *2	~ 1.5 m
Power adaptor: *1	Type self-designed "MU-VU-Splitter D01726" with ~ 1.5 m cable
USB adaptor: *1	Type FTDI TTL-232R-3V3-WE
Fibre optic converter: *2	Opto USB2.0, MK Messtechnik (PM. No. 482617)
Laptop PC:*2	Fujitsu Lifebook S751 (PM No. 201036)

1.6 Dates

Date of receipt of test sample:	19.08.2019
Start of test:	22.08.2019
End of test:	23.09.2019

2 Operational States

The EUT is a display unit with integrated Bluetooth Low Energy capability, which is intended to be implemented in various sensor devices for process automation. This test contains the test results on the EUT within a representative housing (aluminium housing with pressure sensor). The housing with the corresponding digital part, was supplied with 24 V DC by a laboratory power supply.

A connection to the EUT was established via a Serial to USB cable attached to the EUT. The tests were set using a software called "nRFgo Studio" by Nordic Semiconductor, which was downloaded using a link provided by the applicant. The test was performed using pseudorandom payload data (PRBS9) and a maximum payload of 37 Bytes.

For the tests in the anechoic chamber, the USB signal was transmitted via an USB to fiber-optics converter.

During the tests the EUT was supplied with 3.2 V DC via a laboratory power supply.

Maximum power Settings for all measurements:

Modulation	Power setting ch. 0 - 39
GFSK, 1 Mbps	4 dBm

Operation mode	Description of the operation mode	mode	channel	Modulation	Data rate / Mbps
1	Continuous transmitting on 2402 MHz	BLE	0	GFSK	1 Mbps
2	Continuous transmitting on 2440 MHz	BLE	19	GFSK	1 Mbps
3	Continuous transmitting on 2480 MHz	BLE	39	GFSK	1 Mbps

3 Additional Information

All tests were performed with an unmodified sample.

The in-band and unrestricted band-edge tests were performed using a sample with temporary antenna connector, which was provided by the applicant.

The photograph below shows the EUT with the temporary antenna connector:

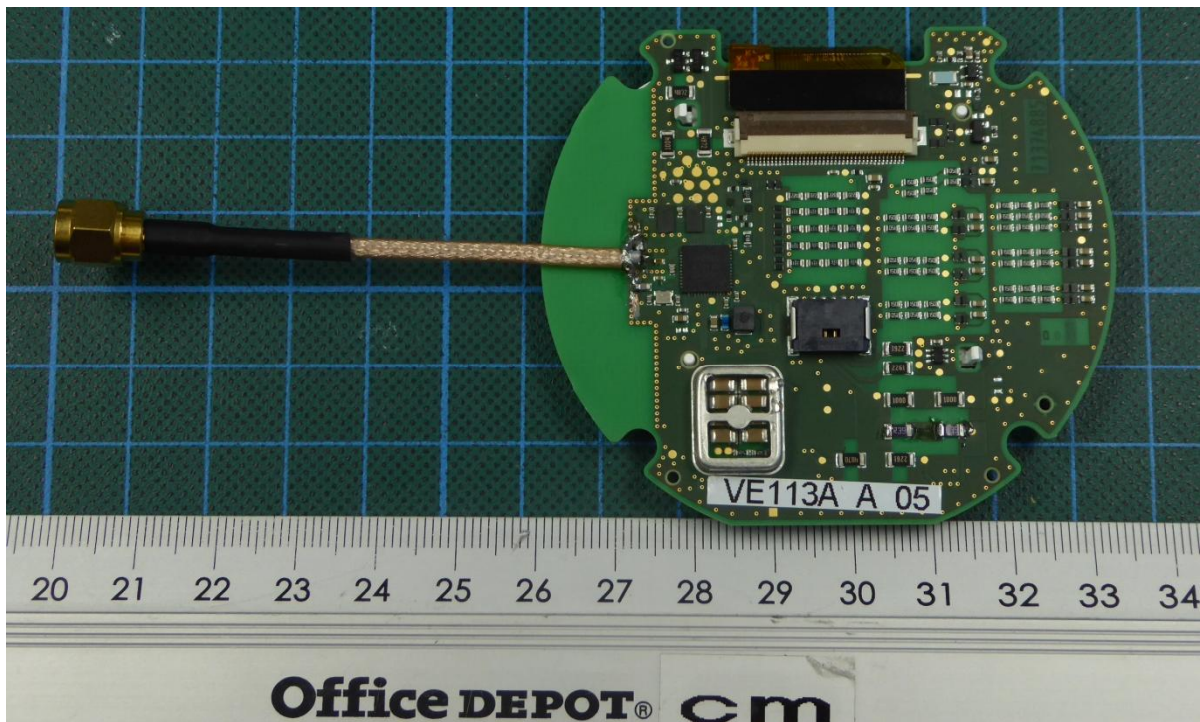

4 Overview

Application	Frequency range [MHz]	FCC 47 CFR Part 15 section [2]	RSS-247 [3] or RSS-Gen [4]	Status	Refer page
Maximum conducted output power	2400.0 - 2483.5	15.247 (b) (3), (4)	5.4 (d) [3]	Passed	12 et seq
DTS Bandwidth / 99% Bandwidth	2400.0 - 2483.5	15.247 (a) (2)	5.2 (a) [3]	Passed	14 et seq
Average Power Spectral Density	2400.0 - 2483.5	15.247 (e)	5.2 (b) [3]	Passed	17 et seq
Band edge compliance	2400.0 - 2483.5	15.247 (d) 15.205 (a) 15.209 (a)	5.5 [3]	Passed	19 et seq.
Maximum unwanted emissions	0.009 – 26,500	15.247 (d) 15.205 (a) 15.209 (a)	5.5 [3] 8.9 [4], 8.10 [4]	Passed	23 et seq.
Conducted emissions on supply line	0.15 - 30	15.207 (a)	8.8 [4]	Passed	36 et seq.

5 Results

5.1 Duty cycle

The EUT was measured conducted on a sample with a temporary antenna connector, which was provided by the applicant.

The method described in chapter 11.6 b) of document [1] was used to perform the following test.

The following measurement technique was used:

The zero-span mode on a spectrum analyzer or EMI receiver if the response time and spacing between two bins on the sweep are sufficient to permit accurate measurements of the on and off times of the transmitted signal.

- Set the center frequency of the instrument to the center frequency of the transmission.
- Set $RBW \geq OBW$ if possible; otherwise, set RBW to the largest available value.
- Set $VBW \geq RBW$.
- Set detector = peak or average.
- The zero-span measurement method shall not be used unless both RBW and VBW are $> 50/T$ and the number of sweep points across duration T exceeds 100. (For example, if VBW and/or RBW are limited to 3 MHz, then the zero-span method of measuring duty cycle shall not be used if $T \leq 16.7$ microseconds.)

5.1.1 Test results

Ambient temperature	22 °C	Relative humidity	40 %
---------------------	-------	-------------------	------

190629_BTLE_DutyCycle.wmf: Duty cycle measurement on channel 0 (operation mode 1):

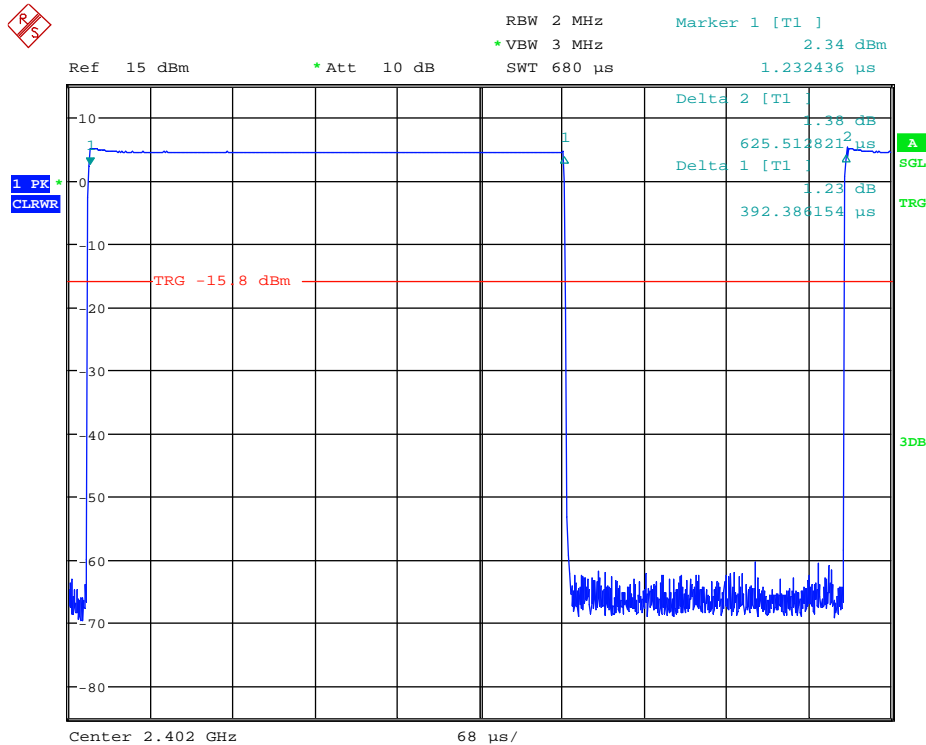

$$T_{TX_{on}} = 392.386 \mu s \quad T_{TX_{cycle}} = 625.513 \mu s \quad (1)$$

$$\frac{50}{T_{TX_{on}}} = \frac{50}{392.386 \mu s} = 127.426 \text{kHz} \leq RBW \leq VBW \quad (2)$$

Measurement Points 4001 for 680 µs à 392.386 µs = 2308 measurement points à Signal has 2308 measurement points (and fulfils the requirement of at least 100 Points resolution for the signal)

If power averaging (RMS) mode was used in step f), then the applicable correction factor is $10 \log(1/x)$, where x is the duty cycle.

$$x = \frac{T_{TX_{on}}}{T_{TX_{cycle}}} = \frac{392.386 \mu s}{625.513 \mu s} = 0.6273 = 62.73\% \quad (3)$$

$$\text{correction factor} = 10 \cdot \log\left(\frac{1}{x}\right) = 10 \cdot \log\left(\frac{1}{0.6273}\right) = 2.03 \text{dB} \quad (4)$$

Therefore, for average measurements a correction factor of 2.03 dB is used.

TEST EQUIPMENT USED FOR THE TEST:

27, 28, 29

5.2 Maximum conducted output power

5.2.1 Method of measurement

The EUT was measured conducted on a sample with a temporary antenna connector, which was provided by the applicant.

Acceptable measurement configurations

Procedure 11.9.2.2.4 in [1] was used for the following test.

Method AVGSA-2 uses trace averaging across ON and OFF times of the EUT transmissions, followed by duty cycle correction. The procedure for this method is as follows:

- a) Measure the duty cycle D of the transmitter output signal as described in 11.6.
- b) Set span to at least 1.5 times the OBW.
- c) Set RBW = 1% to 5% of the OBW, not to exceed 1 MHz.
- d) Set VBW $\geq [3 \times \text{RBW}]$.
- e) Number of points in sweep $\geq [2 \times \text{span} / \text{RBW}]$. (This gives bin-to-bin spacing $\leq \text{RBW} / 2$, so that narrowband signals are not lost between frequency bins.)
- f) Sweep time = auto.
- g) Detector = RMS (i.e., power averaging), if available. Otherwise, use the sample detector mode.
- h) Do not use sweep triggering. Allow the sweep to "free run."
- i) Trace average at least 100 traces in power averaging (rms) mode; however, the number of traces to be averaged shall be increased above 100 as needed such that the average accurately represents the true average over the ON and OFF periods of the transmitter.
- j) Compute power by integrating the spectrum across the OBW of the signal using the instrument's band power measurement function with band limits set equal to the OBW band edges. If the instrument does not have a band power function, then sum the spectrum levels (in power units) at intervals equal to the RBW extending across the entire OBW of the spectrum.
- k) Add $[10 \log (1 / D)]$, where D is the duty cycle, to the measured power to compute the average power during the actual transmission times (because the measurement represents an average over both the ON and OFF times of the transmission). For example, add $[10 \log (1/0.25)] = 6 \text{ dB}$ if the duty cycle is 25%.

The measurement was performed at the upper and lower end and the middle of the assigned frequency band.

5.2.2 Test results

Ambient temperature	22 °C
---------------------	-------

Relative humidity	62 %
-------------------	------

The plot below shows the worst case result. All other results are submitted in the table below

190629_AvOutPwr_BTLE_BT1.wmf: Maximum output power measured on channel 1 (operation mode 1):

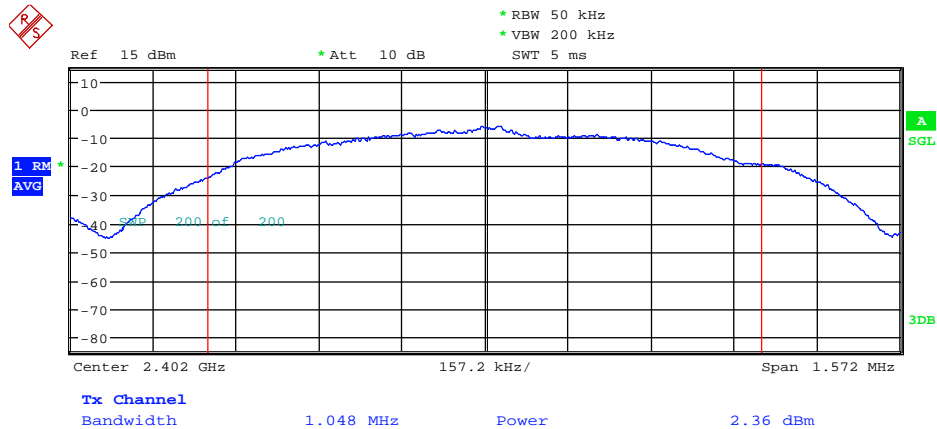

The antenna gain is below 6 dBi, therefore no conducted output limit reduction is necessary.

Operation mode	Frequency [MHz]	Reading [dBm]	DC Corr. [dB]	Corr. Reading [dBm]	Margin [dB]	Limit [dBm]
1	GFSK	2402	2.03	4.39	25.61	30
2	GFSK	2440	2.03	4.36	25.64	30
3	GFSK	2480	2.03	4.18	25.82	30

Test: Passed

TEST EQUIPMENT USED FOR THE TEST:

27, 28, 29

5.3 DTS Bandwidth / 99% Bandwidth

5.3.1 Method of measurement

The EUT was measured conducted on a sample with a temporary antenna connector, which was provided by the applicant.

Acceptable measurement configurations

The measurement for the DTS bandwidth procedure refers to part 11.8.1 of document [1].

- Set RBW = 100 kHz.
- Set the video bandwidth (VBW) $\geq 3 \times$ RBW.
- Detector = Peak.
- Trace mode = max hold.
- Sweep = auto couple.
- Allow the trace to stabilize.
- Measure the maximum width of the emission that is constrained by the frequencies associated with the two outermost amplitude points (upper and lower frequencies) that are attenuated by 6 dB relative to the maximum level measured in the fundamental emission.

The following procedure was used for measuring the 99 % bandwidth:

The occupied bandwidth is the frequency bandwidth such that, below its lower and above its upper frequency limits, the mean powers are each equal to 0.5% of the total mean power of the given emission. The following procedure shall be used for measuring 99% power bandwidth:

- The instrument center frequency is set to the nominal EUT channel center frequency. The frequency span for the spectrum analyzer shall be between 1.5 times and 5.0 times the OBW.
- The nominal IF filter bandwidth (3 dB RBW) shall be in the range of 1% to 5% of the OBW, and VBW shall be approximately three times the RBW, unless otherwise specified by the applicable requirement.
- Set the reference level of the instrument as required, keeping the signal from exceeding the maximum input mixer level for linear operation. In general, the peak of the spectral envelope shall be more than $[10 \log(\text{OBW}/\text{RBW})]$ below the reference level. Specific guidance is given in 4.1.5.2.
- Step a) through step c) might require iteration to adjust within the specified range.
- e) Video averaging is not permitted. Where practical, a sample detection and single sweep mode shall be used. Otherwise, peak detection and max hold mode (until the trace stabilizes) shall be used.
- f) Use the 99% power bandwidth function of the instrument (if available) and report the measured bandwidth.
- g) If the instrument does not have a 99% power bandwidth function, then the trace data points are recovered and directly summed in linear power terms. The recovered amplitude data points, beginning at the lowest frequency, are placed in a running sum until 0.5% of the total is reached; that frequency is recorded as the lower frequency. The process is repeated until 99.5% of the total is reached; that frequency is recorded as the upper frequency. The 99% power bandwidth is the difference between these two frequencies.
- The occupied bandwidth shall be reported by providing plot(s) of the measuring instrument display; the plot axes and the scale units per division shall be clearly labelled. Tabular data maybe reported in addition to the plot(s).

5.3.2 Test result

Ambient temperature	22 °C
---------------------	-------

Relative humidity	59 %
-------------------	------

The plots show an exemplary measurement result for the worst documented case. The other results are listed in the following tables.

190629_6dB-BW_BTLE_BT1.wmf: 6-dB Bandwidth (operation mode 1):

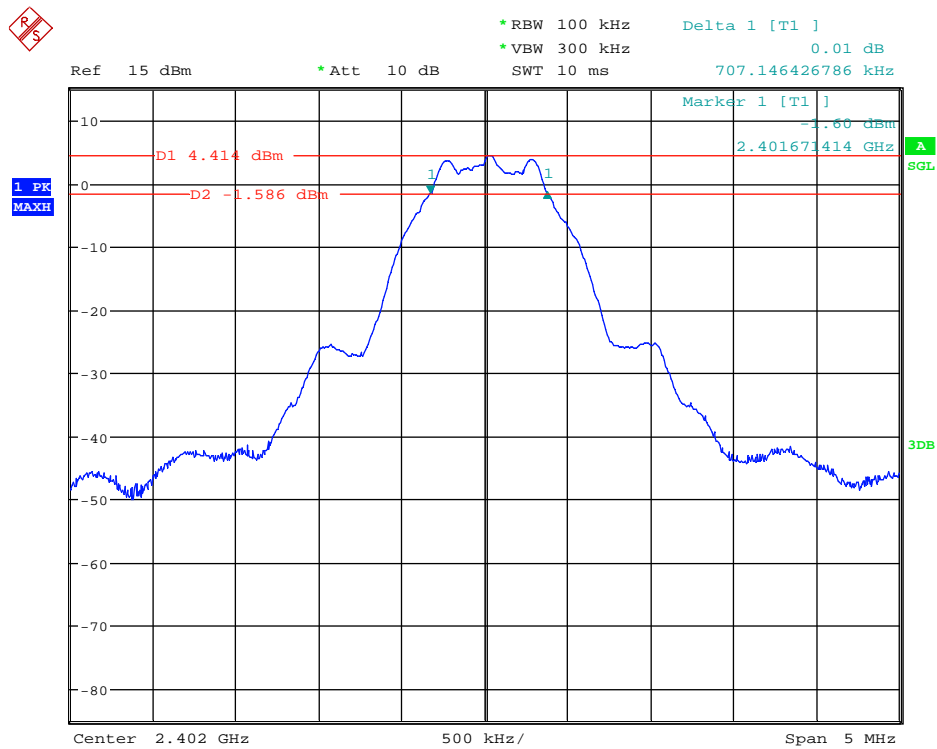

190629 99%BW BTLE BTLE19.wmf: 99% Bandwidth (operation mode 2):

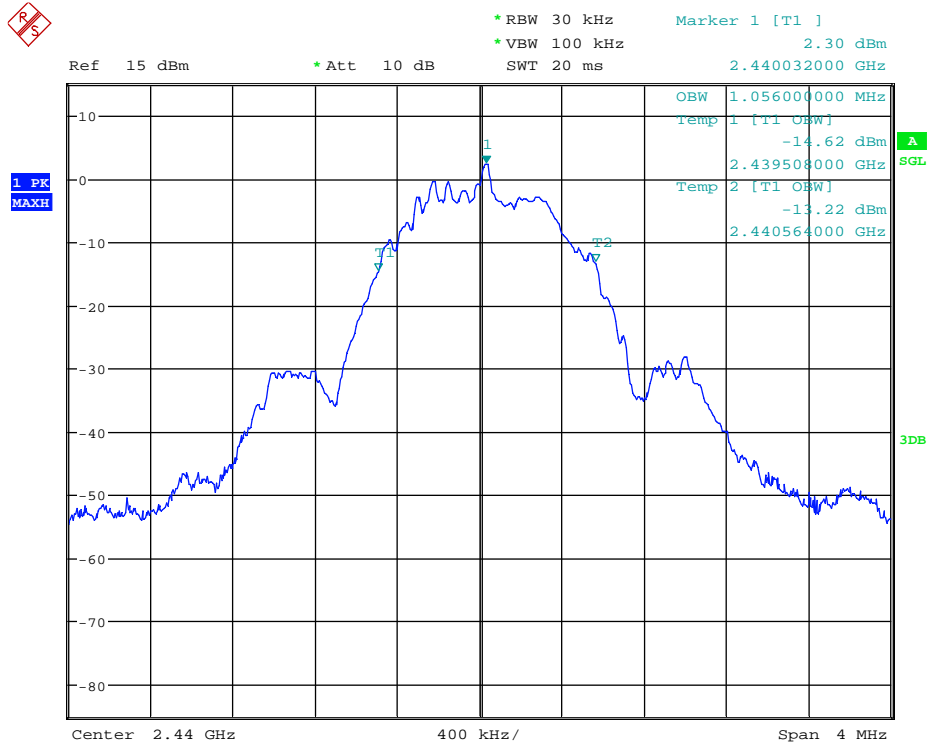

Operation Mode	Center Frequency [MHz]	Minimum 6-dB Bandwidth Limit [MHz]	6 dB Bandwidth [MHz]	99 % Bandwidth [MHz]	Result
1 GFSK	2402	0.5	0.707	1.0480	Passed
2 GFSK	2440	0.5	0.720	1.0560	Passed
3 GFSK	2480	0.5	0.727	1.0560	Passed

Test: Passed

TEST EQUIPMENT USED FOR THE TEST:

27, 28, 29

5.4 Average Power Spectral Density

5.4.1 Method of measurement

The EUT was measured conducted on a sample with a temporary antenna connector, which was provided by the applicant.

Acceptable measurement configurations

The measurement procedure refers to part 11.10.5 of document [1].

Method AVGPS-2 uses trace averaging across ON and OFF times of the EUT transmissions, followed by duty cycle correction.

The following procedure is applicable when the EUT cannot be configured to transmit continuously (i.e., $D < 98\%$), when sweep triggering/signal gating cannot be used to measure only when the EUT is transmitting at its maximum power control level, and when the transmission duty cycle is constant (i.e., duty cycle variations are less than $\pm 2\%$):

- Measure the duty cycle (D) of the transmitter output signal as described in 11.6.
- Set instrument center frequency to DTS channel center frequency.
- Set span to at least 1.5 times the OBW.
- Set RBW to: $3 \text{ kHz} \leq \text{RBW} \leq 100 \text{ kHz}$.
- Set VBW $\geq [3 \times \text{RBW}]$.
- Detector = power averaging (rms) or sample detector (when rms not available).
- Ensure that the number of measurement points in the sweep $\geq [2 \times \text{span} / \text{RBW}]$.
- Sweep time = auto couple.
- Do not use sweep triggering; allow sweep to "free run."
- Employ trace averaging (rms) mode over a minimum of 100 traces.
- Use the peak marker function to determine the maximum amplitude level.
- Add $[10 \log (1 / D)]$, where D is the duty cycle measured in step a), to the measured PSD to compute the average PSD during the actual transmission time.
- If measured value exceeds requirement specified by regulatory agency, then reduce RBW (but no less than 3 kHz) and repeat (note that this may require zooming in on the emission of interest and reducing the span to meet the minimum measurement point requirement as the RBW is reduced).

The measurement was performed at the upper and lower end and the middle of the assigned frequency band.

5.4.2 Test result

Ambient temperature	22 °C
---------------------	-------

Relative humidity	59 %
-------------------	------

The plots show an exemplary measurement result for the worst documented case. The other results are listed in the following tables.

190629_AVPwrSpecDens_BTLE_BTLE19.wmf: Average Power Spectral Density (operation mode 2):

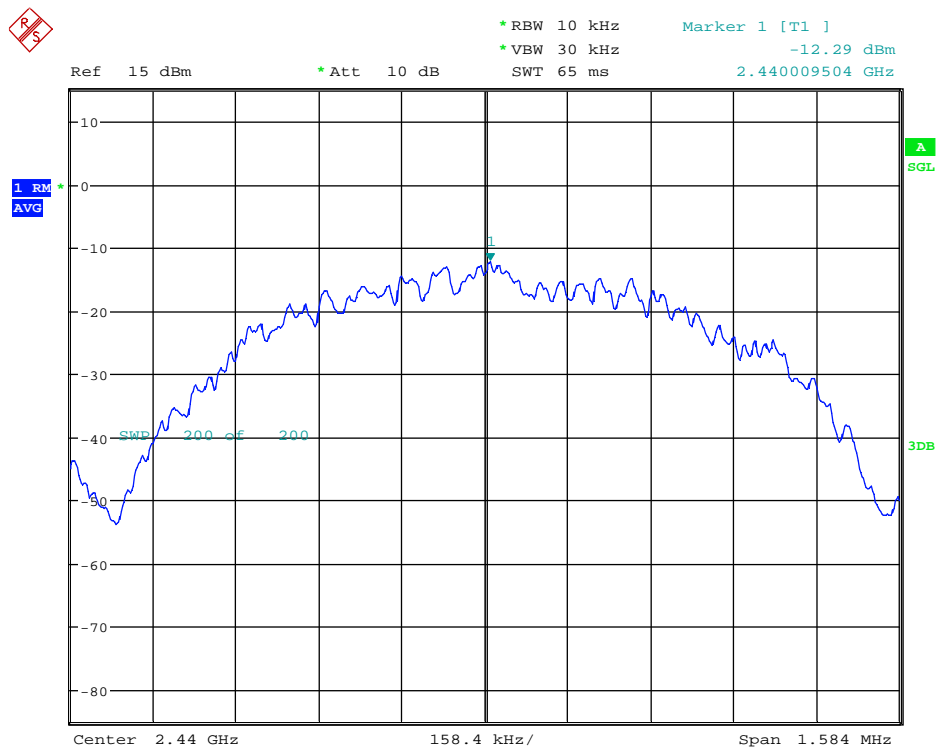

The antenna gain is below 6 dBi, therefore no conducted output limit reduction is necessary.

Operation Mode	Peak Frequency [MHz]	AvPSD Reading [dBm/10 kHz]	Duty Cycle Corr. [dB]	Corr. Reading [dBm /10 kHz]	Margin [dB]	AvPSD Limit [dBm/3kHz]
1 GFSK	2402.009	-12.33	2.03	-10.30	18.30	8
2 GFSK	2440.010	-12.29	2.03	-10.26	18.26	8
3 GFSK	2480.010	-12.50	2.03	-10.47	18.47	8

Test: Passed

TEST EQUIPMENT USED FOR THE TEST:

27, 28, 29

5.5 Band-edge compliance

5.5.1 Method of measurement (band edges next to unrestricted bands (radiated))

The EUT was measured conducted on a sample with a temporary antenna connector, which was provided by the applicant.

Acceptable measurement configurations

The measurement procedure refers to part 11.11.2 and 11.11.3 of document [1].

Measurement Procedure Reference – Reference Level:

- RBW = 100 kHz.
- VBW \geq 300 kHz.
- Set the span to \geq 1.5 times the DTS Bandwidth.
- Detector = Peak.
- Sweep time = auto couple.
- Trace mode = max hold.
- Allow trace to fully stabilise.
- Use the peak marker function to determine the the maximum PSD level.

Measurement Procedure – Unwanted Emissions

- Set the center frequency and span to encompass the frequency range to be measured.
- RBW = 100 kHz.
- VBW \geq 300 kHz.
- Detector = Peak.
- Ensure that the number of measurement points \geq span/RBW.
- Sweep time = auto couple.
- Trace Mode = max hold.
- Allow the trace to stabilise.
- Use the peak marker function to determine the maximum amplitude level.

The measurement procedure at the band edges was simplified by performing the measurement in just one plot. Both, the in-band-emission and the unwanted emission were be encompassed by the span. After trace stabilization, the maximum peak was be determined by a peak detector and the value was marked by an appropriate limit line. The second limit line, which is 20 dB below the first, marks the limit for the emissions in the unrestricted band. A maximum-peak-detector marks the highest emission in the unrestricted band next to the band edge.

The measurement were performed at the lower end of the 2.4 GHz band.

5.5.2 Test result (band edges next to unrestricted bands (radiated))

190625_LowBE.wmf: Radiated band-edge compliance at an unrestricted band-edge (operation mode 1):



Operation Mode	Tx Frequency [MHz]	Emission Frequency [MHz]	Reference Level [dBm]	Limit [dBm]	Emission Level [dBm]	Margin [dB]	Result	
1	GFSK	2402	2399.646	4.6	-15.4	-45.3	29.9	Passed

Test: Passed

TEST EQUIPMENT USED FOR THE TEST:

27, 28, 29

5.5.3 Method of measurement (band edges next to restricted bands (radiated))

The EUT was measured radiated in the anechoic chamber using the procedures described in 5.6.1.

Acceptable measurement configurations

The same measurement configurations as described in 5.6.1. were used for the preview and final measurement.

5.5.4 Test result (band edges next to restricted bands (radiated))

190629_highBE: radiated band-edge compliance at an restricted band-edge (operation mode 3):

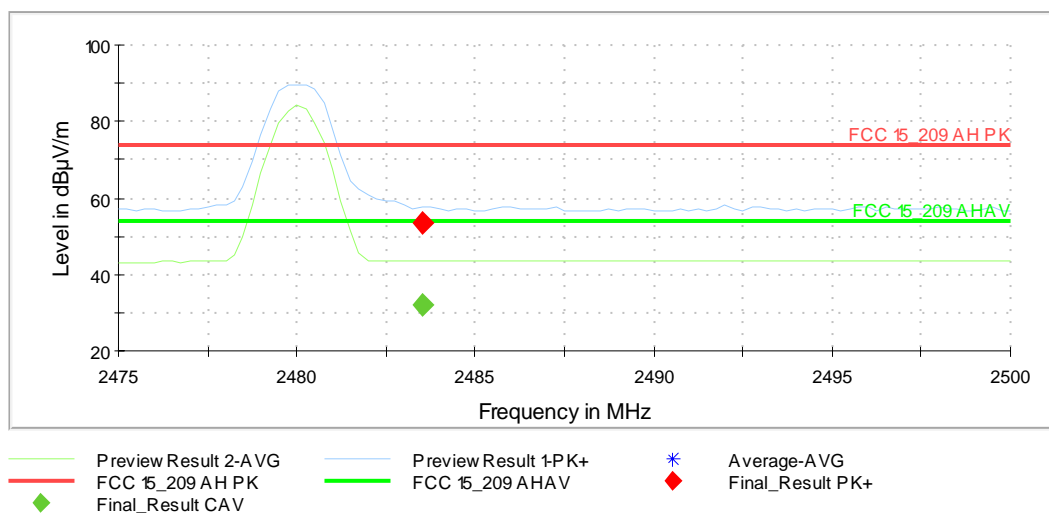

Transmitter operates at the lower end of the assigned frequency band (operation mode 1 GFSK)

Frequency [MHz]	MaxPeak [dB μ V/m]	Coverage [dB μ V/m]	Limit [dB μ V/m]	Margin (dB)	Pol	Azimuth (deg)	Elevation (deg)	Corr. (dB)
2389.250	---	32.77	54	21.23	V	256	120	33.3
2389.250	42.95	---	74	31.05	V	256	120	33.3
Measurement uncertainty				+2.2 dB / -3.6 dB				

Transmitter operates at the upper end of the assigned frequency band (operation mode 3 GFSK)

Frequency [MHz]	MaxPeak [dB μ V/m]	Coverage [dB μ V/m]	Limit [dB μ V/m]	Margin (dB)	Pol	Azimuth (deg)	Elevation (deg)	Corr. (dB)
2483.500	---	34.08	54	19.92	H	32	150	33.5
2483.500	53.61	---	74	20.39	H	32	150	33.5
Measurement uncertainty				+2.2 dB / -3.6 dB				

Test: Passed

TEST EQUIPMENT USED FOR THE TEST:

7 – 14, 17, 18, 28, 29

5.6 Maximum unwanted emissions

5.6.1 Method of measurement (radiated emissions)

The radiated emission measurement is subdivided into five stages.

- A preliminary measurement carried out in a fully anechoic chamber with a fixed antenna height in the frequency range 9 kHz to 1 GHz.
- A final measurement carried out on an outdoor test side without reflecting ground plane and a fixed antenna height in the frequency range 9 kHz to 30 MHz.
- A final measurement carried out on an open area test side with reflecting ground plane and various antenna height in the frequency range 30 MHz to 1 GHz.
- A preliminary measurement carried out in a fully anechoic chamber with a variable antenna distance and height in the frequency range above 1 GHz.
- A final measurement carried out in a fully anechoic chamber with a fixed antenna height in the frequency range above 1 GHz.

Preliminary measurement (9 kHz to 30 MHz):

In the first stage a preliminary measurement will be performed in a shielded room with a measuring distance of 3 meters. Table top devices will set up on a non-conducting turn device on the height of 1.5m. Floor-standing devices will be placed directly on the turntable/ground plane. The set-up of the Equipment under test will be in accordance to [1].

The frequency range 9 kHz to 30 MHz will be monitored with a spectrum analyser while the system and its cables will be manipulated to find out the configuration with the maximum emission levels if applicable. The EMI Receiver will be set to MAX Hold mode. The EUT and the measuring antenna will be rotated around their vertical axis to found the maximum emissions.

The resolution bandwidth of the spectrum analyser will be set to the following values:

Frequency range	Resolution bandwidth
9 kHz to 150 kHz	200 Hz
150 kHz to 30 MHz	9 kHz

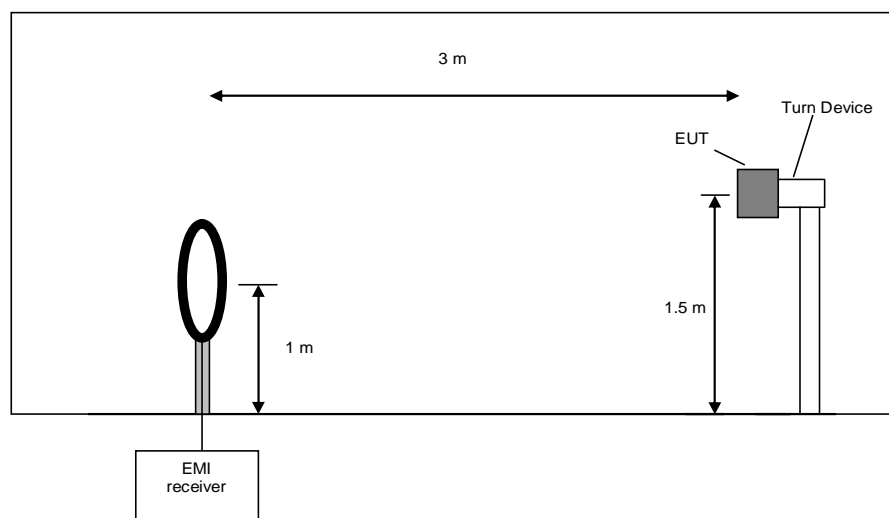

Preliminary measurement procedure:

Prescans were performed in the frequency range 9 kHz to 150 kHz and 150 kHz to 30 MHz.

Prescans were performed in the frequency range 30 MHz to 230 MHz and 230 MHz to 1 GHz.

The following procedure will be used:

1. Monitor the frequency range at horizontal polarisation and a EUT azimuth of 0 °.
2. Manipulate the system cables within the range to produce the maximum level of emission.
3. Rotate the EUT by 360 ° to maximize the detected signals.
4. Repeat 1) to 3) with the vertical polarisation of the measuring antenna.
5. Make a hardcopy of the spectrum.
6. Repeat 1) to 5) with the EUT raised by an angle of 0° (45°, 90°) according to 6.6.5.4 in [1].
7. Measure the frequency of the detected emissions with a lower span and resolution bandwidth to increase the accuracy and note the frequency value.

Final measurement (9 kHz to 30 MHz):

In the second stage a final measurement will be performed on an open area test site with no conducting ground plane in a measuring distances of 3 m, 10 m and 30 m. In the case where larger measuring distances are required the results will be extrapolated based on the values measured on the closer distances according to Section 15.31 (f) (2) [2]. The final measurement will be performed with a EMI Receiver set to Quasi Peak detector except for the frequency bands 9 kHz to 90 kHz and 110 kHz to 490 kHz where an average detector will be used according Section 15.209 (d) [2].

On the frequencies, which were detected during the preliminary measurements, the final measurement will be performed while rotating the EUT and the measuring antenna in the range of 0 ° to 360 ° around their vertical axis until the maximum value is found.

The resolution bandwidth of the EMI Receiver will be set to the following values:

Frequency range	Resolution bandwidth
9 kHz to 150 kHz	200 Hz
150 kHz to 30 MHz	9 kHz

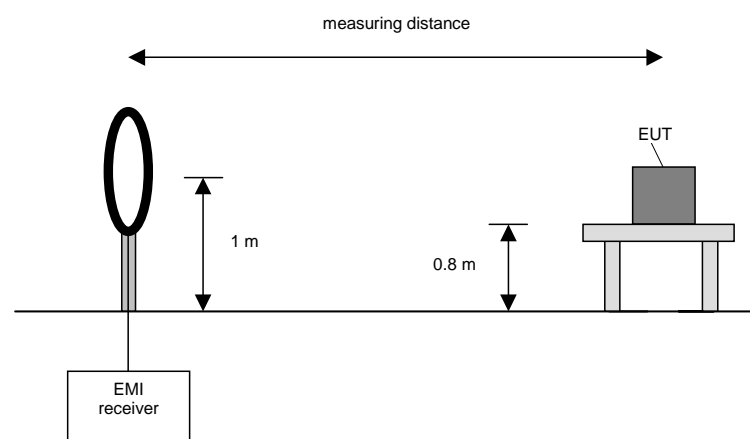

Final measurement procedure:

The following procedure will be used:

- 1) Monitor the frequency range with the measuring antenna at vertical orientation parallel to the EUT at an azimuth of 0 °.
- 2) Rotate the EUT by 360 ° to maximize the detected signals and note the azimuth and orientation.
- 3) Rotate the measuring antenna to find the maximum and note the value.
- 4) Rotate the measuring antenna and repeat steps 1) to 3) until the maximum value is found.
- 5) Repeat steps 1) to 4) with the other orthogonal axes of the EUT (if the EUT is a module and might be used in a handheld equipment application).

Preliminary measurement (30 MHz to 1 GHz)

In the first stage a preliminary measurement will be performed in a fully anechoic chamber with a measuring distance of 3 meter. Table top devices will set up on a non-conducting turn device on the height of 1.5m. Floor-standing devices will be placed directly on the turntable/ground plane. The set up of the Equipment under test will be in accordance to [1].

The frequency range 30 MHz to 1 GHz will be measured with an EMI Receiver set to MAX Hold mode and a resolution bandwidth of 100 kHz. The measurement will be performed in horizontal and vertical polarisation of the measuring antenna and while rotating the EUT in its vertical axis in the range of 0 ° to 360 °. This measurement is repeated after raising the EUT in 30° steps according 6.6.5.4 in [1].

The resolution bandwidth of the EMI Receiver will be set to the following values:

Frequency range	Resolution bandwidth
30 MHz to 1 GHz	100 kHz

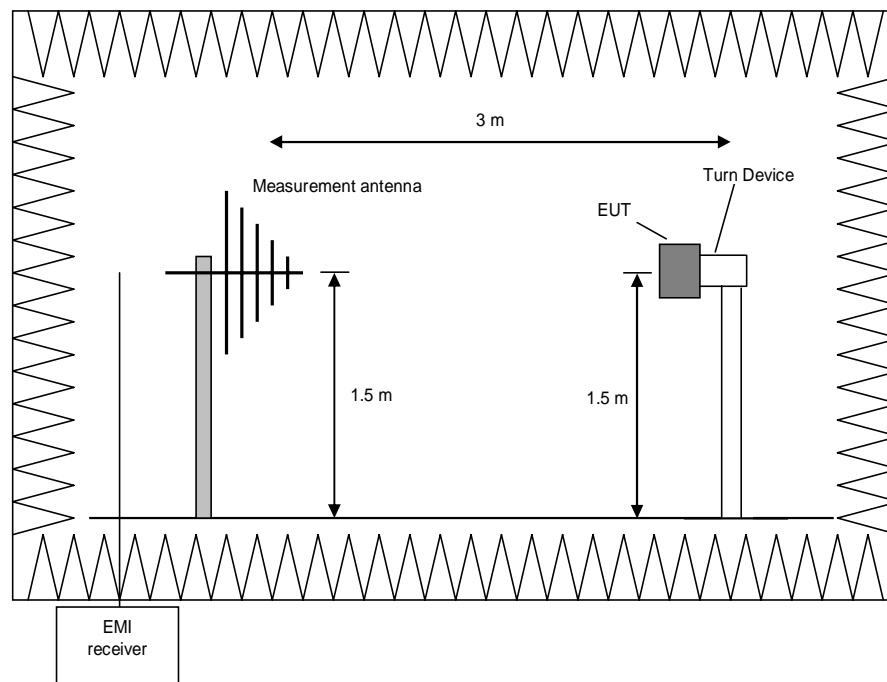

Procedure preliminary measurement:

Prescans were performed in the frequency range 30 MHz to 230 MHz and 230 MHz to 1 GHz.

The following procedure will be used:

8. Monitor the frequency range at horizontal polarisation and a EUT azimuth of 0°.
9. Manipulate the system cables within the range to produce the maximum level of emission.
10. Rotate the EUT by 360° to maximize the detected signals.
11. Repeat 1) to 3) with the vertical polarisation of the measuring antenna.
12. Make a hardcopy of the spectrum.
13. Repeat 1) to 5) with the EUT raised by an angle of 0° (45°, 90°) according to 6.6.5.4 in [1].
14. Measure the frequency of the detected emissions with a lower span and resolution bandwidth to increase the accuracy and note the frequency value.

Final measurement (30 MHz to 1 GHz)

A final measurement on an open area test site will be performed on selected frequencies found in the preliminary measurement. During this test the EUT will be rotated in the range of 0° to 360°, the measuring antenna will be set to horizontal and vertical polarisation and raised and lowered in the range from 1 m to 4 m to find the maximum level of emissions.

The resolution bandwidth of the EMI Receiver will be set to the following values:

Frequency range	Resolution bandwidth
30 MHz to 1 GHz	120 kHz

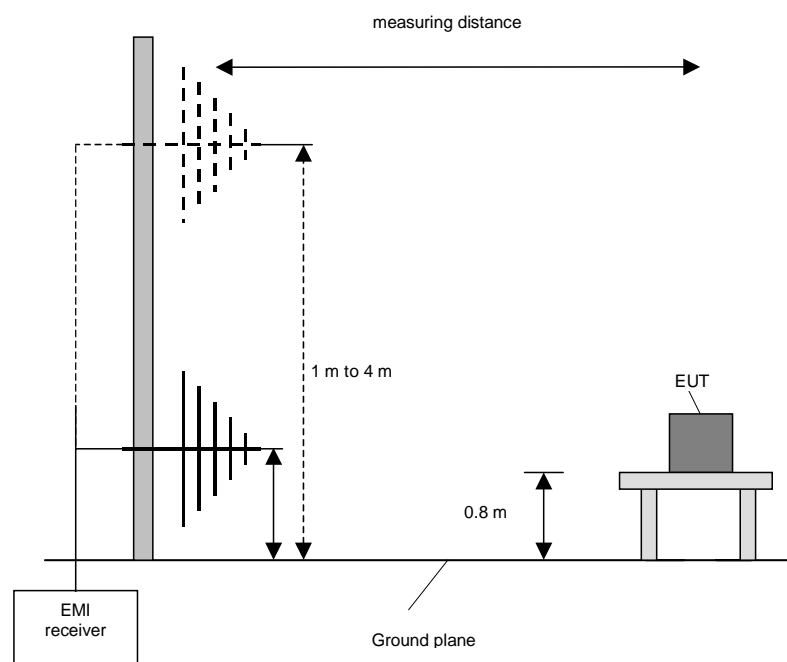

Procedure final measurement:

The following procedure will be used:

- 1) Measure on the selected frequencies at an antenna height of 1 m and a EUT azimuth of 23 °.
- 2) Move the antenna from 1 m to 4 m and note the maximum value at each frequency.
- 3) Rotate the EUT by 45 ° and repeat 2) until an azimuth of 337 ° is reached.
- 4) Repeat 1) to 3) for the other orthogonal antenna polarization.
- 5) Move the antenna and the turntable to the position where the maximum value is detected.
- 6) Measure while moving the antenna slowly +/- 1 m.
- 7) Set the antenna to the position where the maximum value is found.
- 8) Measure while moving the turntable +/- 45 °.
- 9) Set the turntable to the azimuth where the maximum value is found.
- 10) Measure with Final detector (QP and AV) and note the value.
- 11) Repeat 5) to 10) for each frequency.
- 12) Repeat 1) to 11) for each orthogonal axes of the EUT (because of EUT is a module and might be used in a handheld equipment application).

Preliminary and final measurement (1 GHz to 40 GHz)

This measurement will be performed in a fully anechoic chamber. Table top devices will set up on a non-conducting turn device on the height of 1.5m. The set-up of the Equipment under test will be in accordance to [1].

Preliminary measurement (1 GHz to 40 GHz)

The frequency range will be divided into different sub ranges depending of the frequency range of the used horn antenna. The spectrum analyser set to MAX Hold mode and a resolution bandwidth of 100 kHz. The measurement will be performed in horizontal and vertical polarisation of the measuring antenna and while rotating the EUT in its vertical axis in the range of 0 ° to 360 °. This measurement is repeated after raising the EUT in 30° steps according 6.6.5.4 in [1].

The resolution bandwidth of the EMI Receiver will be set to the following values:

Frequency range	Resolution bandwidth
1 GHz to 4 GHz	100 kHz
4 GHz to 12 GHz	100 kHz
12 GHz to 18 GHz	100 kHz
18 GHz to 25 / 26.5 GHz	100 kHz
26.5 GHz to 40 GHz	100 kHz

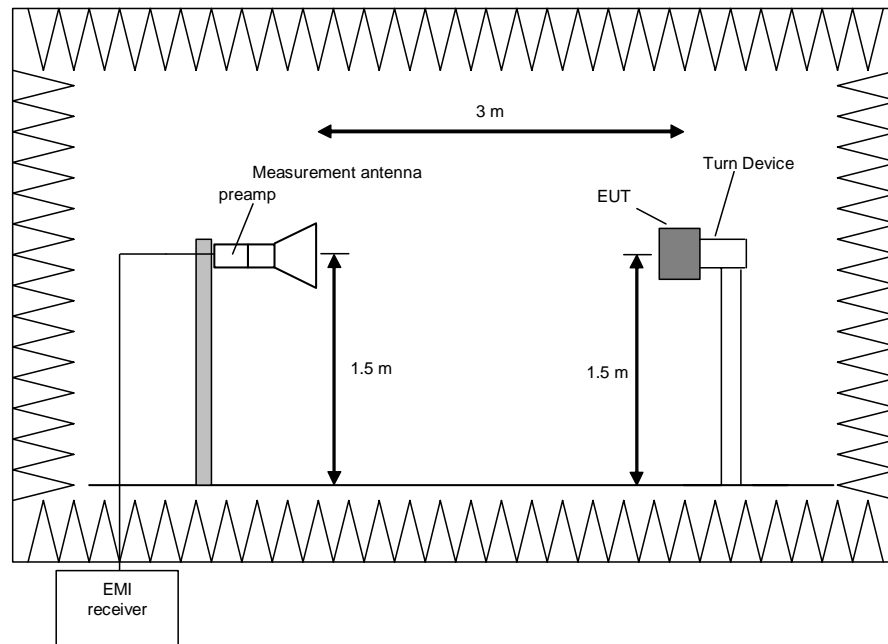

Procedure preliminary measurement:

Prescans were performed in the frequency range 1 to 40 GHz.
The following procedure will be used:

1. Monitor the frequency range at horizontal polarisation and a EUT azimuth of 0 °.
2. Rotate the EUT by 360° to maximize the detected signals.
3. Repeat 1) to 2) with the vertical polarisation of the measuring antenna.
4. Make a hardcopy of the spectrum.
5. Repeat 1) to 4) with the EUT raised by an angle of 30° (60°, 90°, 120° and 150°) according to 6.6.5.4 in [1].
6. Measure the frequency of the detected emissions with a lower span and resolution bandwidth to increase the accuracy and note the frequency value.
7. The measurement antenna polarisation, with the according EUT position (Turntable and Turn device) which produces the highest emission for each frequency will be used for the final measurement. The six closest values to the applicable limit will be used for the final measurement.

Final measurement (1 GHz to 40 GHz)

The frequency range will be divided into different sub ranges depending of the frequency range of the used horn antenna. The EMI Receiver set to peak and average mode and a resolution bandwidth of 1 MHz. The measurement will be performed by rotating the turntable through 0 to 360° in the worst-case EUT orientation which was obtained during the preliminary measurements.

The resolution bandwidth of the EMI Receiver will be set to the following values:

Frequency range	Resolution bandwidth
1 GHz to 4 GHz	1 MHz
4 GHz to 12 GHz	1 MHz
12 GHz to 18 GHz	1 MHz
18 GHz to 25 / 26.5 GHz	1 MHz
26.5 GHz to 40 GHz	1 MHz

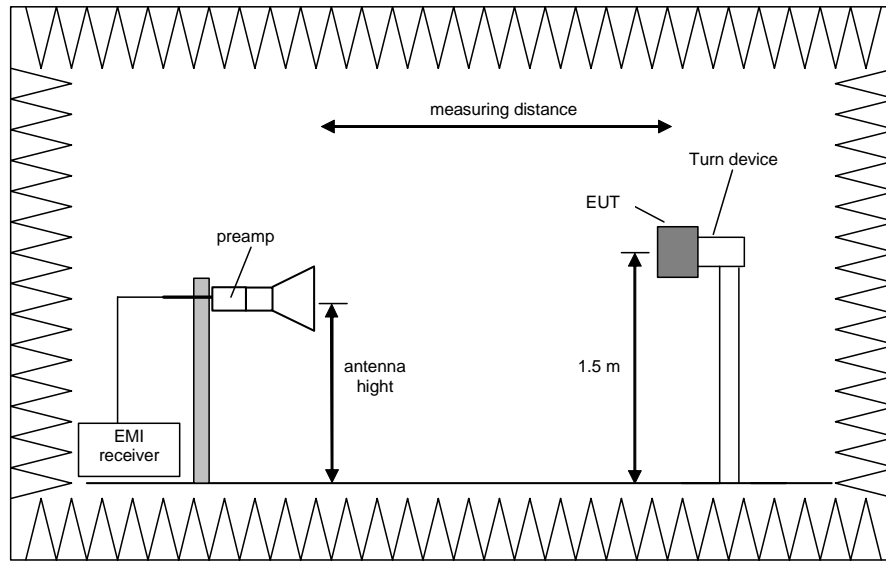

Procedure of measurement:

The measurements were performed in the frequency ranges 1 GHz to 4 GHz, 4 GHz to 12 GHz, 12 GHz to 18 GHz, 18 GHz to 25 /26.5 GHz and 26.5 GHz to 40 GHz.

The following procedure will be used:

- 1) Set the turntable and the turn device to obtain the worst-case emission for the first frequency identified in the preliminary measurements.
- 2) Set the measurement antenna polarisation to the orientation with the highest emission for the first frequency identified in the preliminary measurements.
- 3) Set the spectrum analyser to EMI mode with peak and average detector activated.
- 4) Rotate the turntable from 0° to 360° to find the TT Pos. that produces the highest emissions.
- 5) Note the highest displayed peak and average values
- 6) Repeat the steps 1) to 5) for each frequency detected during the preliminary measurements.

5.6.2 Test results (radiated emissions) – Emissions with internal antenna from 30 MHz – 26.5 GHz

5.6.2.1 Preliminary radiated emission measurement 30 MHz – 26.5 GHz

Ambient temperature	22 °C	Relative humidity	59 %
---------------------	-------	-------------------	------

Position of EUT: The EUT was set-up on an EUT turn device of a height of 1.5 m. The distance between EUT and antenna was 3 m.

For the final test on the open area test site the EUT was placed on a table with the height of 0.8 m. The distance between EUT and antenna was 3 m.

Cable guide: For detail information of test set-up and the cable guide refer to the pictures in the annex A in the test report.

Test record: Only the plot of the worst case emission is submitted below.

Remark: Since there were no differences in the spectrum for $f < 1$ GHz, only one representative plot is submitted below.

Since no emissions were found in the frequency range below 30 MHz, no final test was performed.

Plots of the worst case transmitter spurious emissions

190629_TX_CH19_9k-30M: Spurious emissions from 9 kHz to 30 MHz (operation mode 2):

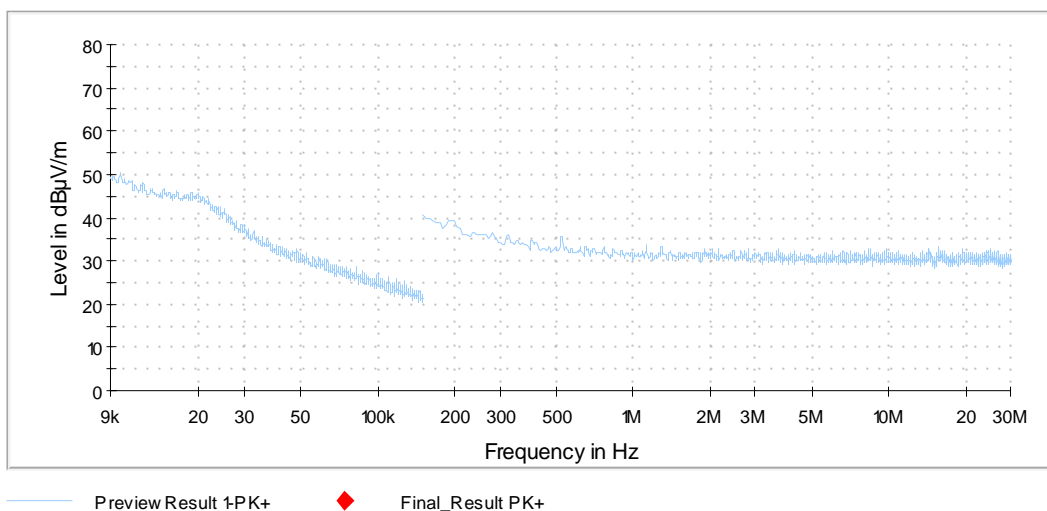

ch19_30M-1G: Spurious emissions from 30 MHz to 1 GHz (operation mode 2):

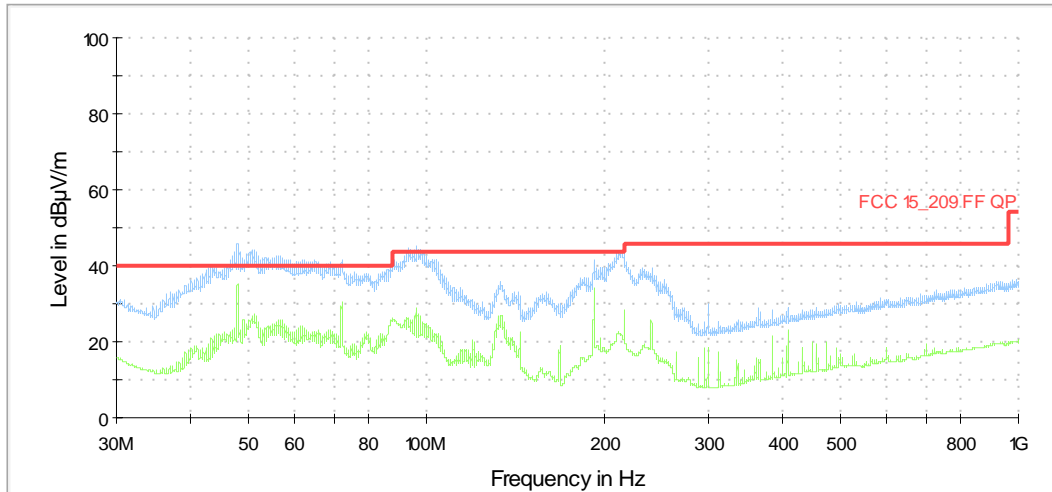

190629_TX_CHO_1-4G: Spurious emissions from 1 GHz to 4 GHz (operation mode 1)

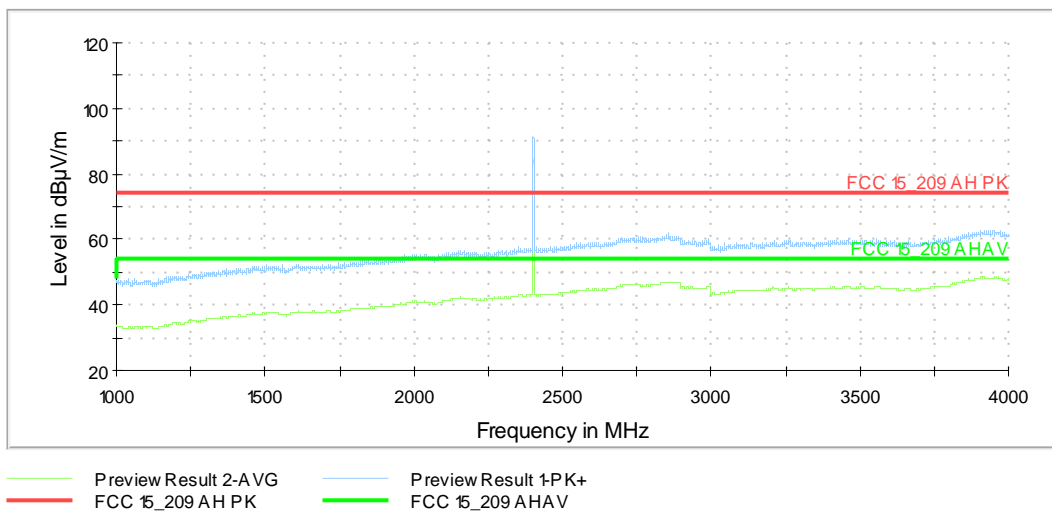

190629_TX_CH0_4-12G: Spurious emissions from 4 GHz to 12 GHz (operation mode 1):

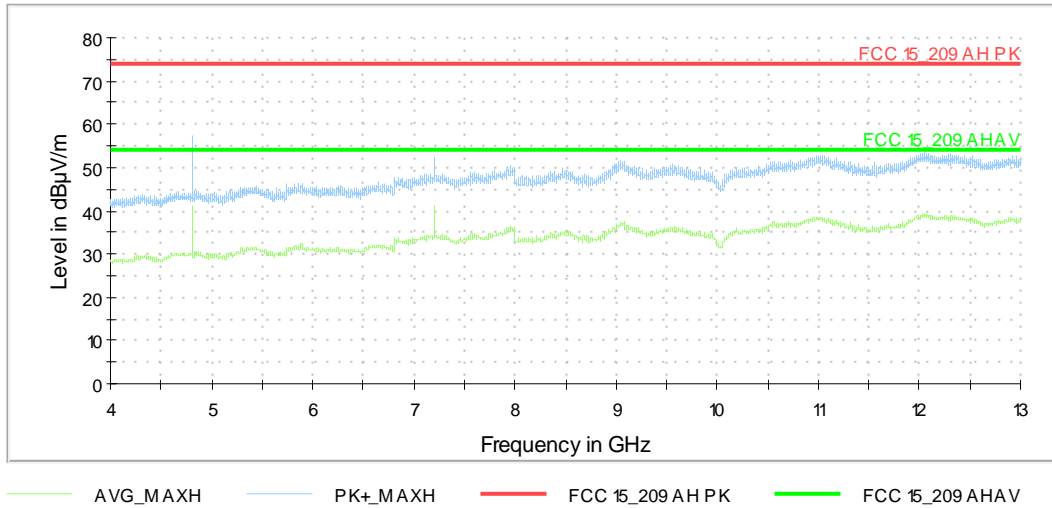

190629_TX_CH39_12-18G: Spurious emissions from 12 GHz to 18 GHz (operation mode 3):

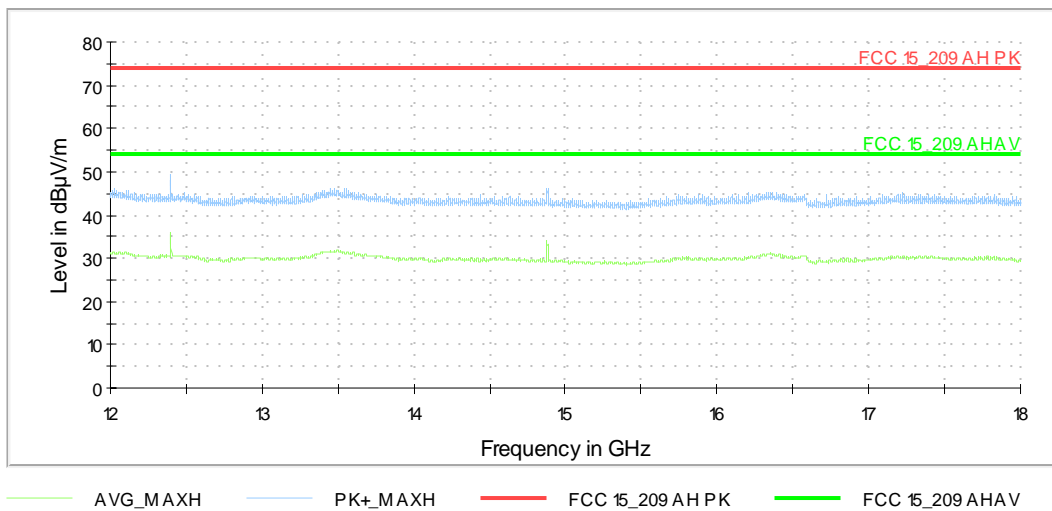

190629 TX CH39 18-26.5G: Spurious emissions from 18 GHz to 26.5 GHz (operation mode 3):

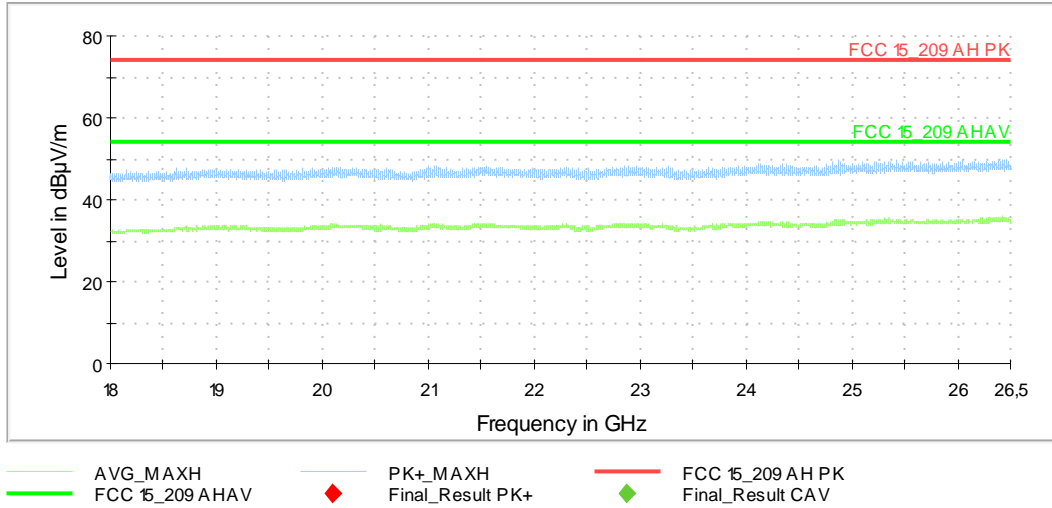

5.6.2.2 Final radiated measurements

All TX modes (no difference detected when comparing channel / modulation)

Frequency [MHz]	QuasiPeak [dB μ V/m]	Limit [dB μ V/m]	Margin [dB]	Meas. Time [ms]	Bandwidth [kHz]	Height [cm]	Pol	Azimuth [deg]	Corr. [dB]
47.520000	37.36	40.00	2.64	1000.0	120.000	100.0	V	288.0	15.1
47.970000	38.08	40.00	1.92	1000.0	120.000	106.0	V	14.0	14.8
50.740000	39.12	40.00	0.88	1000.0	120.000	105.0	V	291.0	13.3
51.210000	39.16	40.00	0.84	1000.0	120.000	100.0	V	257.0	13.1
93.270000	37.55	43.50	5.95	1000.0	120.000	122.0	V	316.0	16.6
96.300000	38.24	43.50	5.26	1000.0	120.000	141.0	V	151.0	16.7
214.040000	37.11	43.50	6.40	1000.0	120.000	104.0	V	236.0	16.3
Measurement uncertainty					+2.2 dB / -3.6 dB				

Transmitter operates at the lower end of the assigned frequency band (operation mode 1, GFSK)

Frequency [MHz]	MaxPeak [dB μ V/m]	Coverage [dB μ V/m]	Limit [dB μ V/m]	Margin (dB)	Pol	Azimuth (deg)	Elevation (deg)	Corr. (dB)
2402.000	---	88.62	Fund.	-	H	197	60	33.4
2402.000	91.57	---	Fund.	-	H	197	60	33.4
4804.000	---	43.15	54	10.85	H	333	0	-2
4804.000	57.18	---	74	16.82	H	333	0	-2
7206.000	---	40.92	54	13.08	H	51	0	4.1
7206.000	51.01	---	74	22.99	H	51	0	4.1
12009.000	---	35.5	54	18.50	V	-4	0	12.1
12009.000	45.79	---	74	28.21	V	-4	0	12.1
14410.750	---	32.93	54	21.07	H	310	30	11.5
14410.750	44.4	---	74	29.60	H	310	30	11.5
Measurement uncertainty				+2.2 dB / -3.6 dB				

Transmitter operates at the middle of the assigned frequency band (operation mode 2, GFSK)

Frequency [MHz]	MaxPeak [dB μ V/m]	Coverage [dB μ V/m]	Limit [dB μ V/m]	Margin (dB)	Pol	Azimuth (deg)	Elevation (deg)	Corr. (dB)
2440.000	---	86.98	Fund.	-	V	336	0	33.6
2440.000	89.93	---	Fund.	-	V	336	0	33.6
4880.000	---	43.03	54	10.97	H	322	0	-1.7
4880.000	56.17	---	74	17.83	H	322	0	-1.7
7319.250	---	41.26	54	12.74	V	25	150	4.8
7319.250	51.45	---	74	22.55	V	25	150	4.8
12199.000	---	35.46	54	18.54	H	14	150	11.9
12199.000	45.67	---	74	28.33	H	14	150	11.9
14638.750	---	35.15	54	18.85	H	305	30	11.4
14638.750	45.77	---	74	28.23	H	305	30	11.4
Measurement uncertainty				+2.2 dB / -3.6 dB				

Transmitter operates at the upper end of the assigned frequency band (operation mode 3, GFSK)

Frequency [MHz]	MaxPeak [dB μ V/m]	Coverage [dB μ V/m]	Limit [dB μ V/m]	Margin (dB)	Pol	Azimuth (deg)	Elevation (deg)	Corr. (dB)
2480.000	---	87.25	Fund.	-	H	29	120	33.5
2480.000	90.21	---	Fund.	-	H	29	120	33.5
4960.000	---	42.18	54	11.82	H	41	0	-1.8
4960.000	53.74	---	74	20.26	H	41	0	-1.8
7439.250	---	42.3	54	11.70	H	328	60	5.1
7439.250	52.3	---	74	21.70	H	328	60	5.1
12399.000	---	37.89	54	16.11	V	339	0	12.1
12399.000	47.27	---	74	26.73	V	339	0	12.1
14878.750	---	35.65	54	18.35	V	332	0	11.2
14878.750	45.74	---	74	28.26	V	332	0	11.2
Measurement uncertainty				+2.2 dB / -3.6 dB				

TEST EQUIPMENT USED FOR THE TEST:

7 – 26, 28 - 36

5.7 Conducted emissions on power supply lines (150 kHz to 30 MHz)

Ambient temperature	20 °C	Relative humidity	52 %
---------------------	-------	-------------------	------

- Position of EUT: For this test, the EUT was operated in normal mode. The EUT was inserted in an representative housing (aluminium housing and pressure sensor:1-Chamber Aluminium Housing, non ExD („PMP51B_P2_002“) Aluminium-Cover with plastic inspection glass).
- Cable guide: For detail information of test set-up and the cable guide refer to the pictures in annex A of this test report.
- Test record: All results are shown in the following.
- Supply voltage: Measurement performed with US 120V/60Hz.
For the test an AC/DC Adaptor from Phoenix Contact Model MINI-PS-100-240AC/24DC/2 was used, which had an output voltage of 24.0 V DC.

The curves in the diagram only represent for each frequency point the maximum measured value of all preliminary measurements which were made for each power supply line. The top measured curve represents the peak measurement and the bottom measured curve the average measurement. The quasi-peak measured points are marked by “◆” and the average measured points by “▼”.

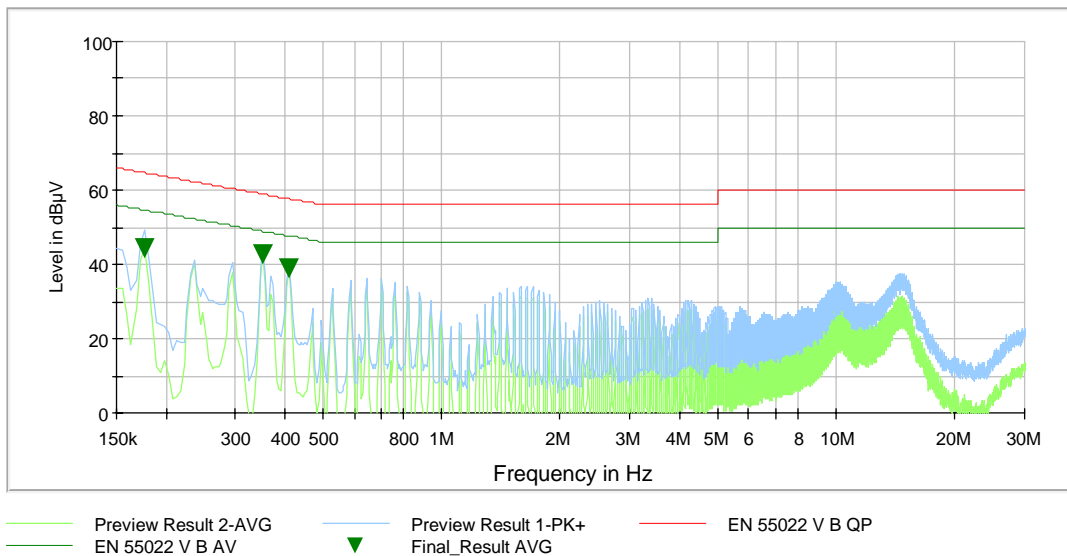

Frequency (MHz)	QuasiPeak (dBµV)	Average (dBµV)	Limit (dBµV)	Margin (dB)	Meas. Time (ms)	Bandwidth (kHz)	Line	PE	Transducer (dB)
0.176	---	44.38	54.67	10.29	5000	9	N	GND	9.8
0.352	---	42.92	48.92	6.01	5000	9	N	GND	9.9
0.410	---	39.02	47.65	8.63	5000	9	N	FLO	9.9
Measurement uncertainty				+2.76 dB / -2.76 dB					

Test: Passed

TEST EQUIPMENT USED FOR THE TEST:
1 – 7, 28, 29

6 Test equipment and ancillaries used for tests

No.	Test equipment	Type	Manufacturer	Serial No.	PM. No.	Cal. Date	Cal. Due
1	Shielded chamber M4	-	Albatross Projects	B83117-C6439-T262	480662	Calibration not necessary	
2	EMI Receiver	ESIB 26	Rohde & Schwarz	1088.7490	481182	28.02.2018	02.2020
3	LISN	NSLK8128	Schwarzbeck	8128155	480058	19.04.2018	02.2020
4	High pass filter	HR 0.13-5ENN	FSY Microwave	DC 0109 SN 002	480340	Calibration not necessary	
5	EMI Software	ES-K1	Rohde & Schwarz	-	480111	Calibration not necessary	
6	AC Power supply AC	AC6803A	Keysight	JPVJ002509	482350	Calibration not necessary	
7	EMI Software	EMC32	Rohde & Schwarz	100061	481022	Calibration not necessary	
8	RF-Cable	Sucoflex 104	Huber+Suhner	517406	482391	Calibration not necessary	
9	Fully anechoic chamber M20	-	Albatross Projects	B83107-E2439-T232	480303	Calibration not necessary	
10	Signal & Spectrum Analyzer	ESW44	Rohde & Schwarz	101635	482467	29.03.2018	03.2020
11	Controller	MCU	Maturo	MCU/043/971107	480832	Calibration not necessary	
12	Turntable	DS420HE	Deisel	420/620/80	480315	Calibration not necessary	
13	Antenna support	AS615P	Deisel	615/310	480187	Calibration not necessary	
14	Antenna (Log.Per.)	HL050	Rohde & Schwarz	100438	481170	09.10.2017	10.2020
15	Standard Gain Horn 11.9 GHz – 18 GHz	18240-20	Flann Microwave	483	480294	Calibration not necessary	
16	Standard Gain Horn 17.9 GHz – 26.7 GHz	20240-20	Flann Microwave	411	480297	Calibration not necessary	
17	RF-cable No. 3	Sucoflex 106B	Huber&Suhner	500234/6B	482644	Calibration not necessary	
18	RF-cable No. 40	Sucoflex 106B	Huber&Suhner	SF106B/11N/11N/1500MM	482125	Calibration not necessary	
19	Loop antenna	HFH2-Z2	Rohde & Schwarz	832609/014	480059	21.02.2018	02.2020
20	Antenna (Bilog)	CBL6112B	Schaffner EMV GmbH (-Chase)	2688	480328	19.06.2017	06.2020
21	RF-cable 2 m	KPS-1533-800-KPS	Insulated Wire	-	480302	Calibration not necessary	
22	RF-cable No. 36	Sucoflex 106B	Suhner	500003/6B / Kabel 36	481680	Calibration not necessary	
23	Preamplifier 100 MHz - 16 GHz	AFS6-00101600-23-10P-6-R	Narda MITEQ	2011215	482333	10.07.2018	07.2020
24	Preamplifier	JS3-12001800-16-5A	Miteq	571667	480343	10.07.2018	07.2020
25	Preamplifier	JS3-18002600-20-5A	Miteq	658697	480342	10.07.2018	07.2020
26	4 GHz High Pass Filter	WHKX4.0/18 G-8SS	Wainwright Instruments	1	480587	Calibration not necessary	
27	Spectrum Analyser	FSU46	Rohde & Schwarz	200125	480956	27.03.2019	03.2020
28	Power Supply	TOE8752-32 (DC)	Toellner Electronic Inst.	31566	480010	Calibration not necessary	

29	Multimeter	971A	Hewlett Packard	JP39009358	480721	19.02.2019	02.2020
30	Semi anechoic chamber	M276	Albatross Projects	C62128-A540-A138-10-0006	483227	Calibration not necessary	
31	Antenna mast	BAM4.5-P-10kg	matturo	222/2612.01	483225	Calibration not necessary	
32	Turntable		Deisel	412/316	480087	Calibration not necessary	
33	Controller	HD100	Deisel	100/349	480139	Calibration not necessary	
34	Software	EMC32	Rohde & Schwarz	ID: 1300.7010.12-100970-Be	482972	Calibration not necessary	
35	Ultralog Antenna	HL562E	Rohde & Schwarz	-	482978	07.08.2019	08.2022
36	EMI Testreceiver	ESW	Rohde & Schwarz	101828	482979	12.04.2019	04.2021

7 Test site Validation

Test equipment	PM. No.	Frequency range	Type of validation	According to	Val. Date	Val Due
Semi anechoic chamber M276	483227	30 – 1000 MHz	NSA	ANSI C63.4a-2017	19.09.2019	18.09.2021
Semi anechoic chamber M276	483227	1 -18 GHz	SVSWR ¹	CISPR 16-1-4 + Cor1:2010 + A1:2012 +A2:2017	19.09.2019	18.09.2021
Fully anechoic chamber M20	480303	30 – 1000 MHz	NSA	ANSI C63.4-2014	13.02.2018	12.02.2020
Fully anechoic chamber M20	480303	1 -18 GHz	SVSWR	CISPR 16-1-4 Amd. 1	13.07.2018	12.07.2020
Shielded chamber M4	480088	9 kHz – 30 MHz	GND-Plane	ANSI C63.4-2014	06.11.2018	05.11.2020

8 Report History

Report Number	Date	Comment
F190629E4	13.11.2019	Initial Test Report

9 List of Annexes

ANNEX A	TEST SETUP PHOTOS	8 pages
ANNEX B	EXTERNAL PHOTOS	2 pages
ANNEX C	INTERNAL PHOTOS	4 pages