



MET Laboratories, Inc. *Safety Certification - EMI - Telecom Environmental Simulation*
914 WEST PATAPSCO AVENUE ! BALTIMORE, MARYLAND 21230-3432 ! PHONE (410) 354-3300 ! FAX (410) 354-3313



April 24, 2003

Northrop Grumman Corporation, Electronic Systems
793 Elkridge Landing Road
Linthicum, MD 21090

Reference: Cordless Communication System Personal Communication Unit (PCU)
FCC ID: LC3810R901G01

Dear Mr. Mark W. Gravel:

Enclosed is the EMC Test Report for the Cordless Communication System Personal Communication Unit (PCU). The Cordless Communication System Personal Communication Unit (PCU) was tested to the requirements of the FCC Rules and Regulations, Section 15.247, of Title 47 of the CFR, for a Part 15 Transmitter.

Thank you for using the testing services of MET Laboratories. If you have any questions regarding these results or if MET can be of further assistance to you, please feel free to contact me. We appreciate your business and look forward to working with you again soon.

Kindest Regards,
MET LABORATORIES, INC.

Marianne T. Bosley
Documentation Department

Enclosures: (\Northrop Grumman Corp.\EMC13035A-PCU15247.rpt)
DOCTEM-23 Jan 02

Certificates and reports shall not be reproduced except in full, without the written permission of MET Laboratories, Inc. While use of the National Voluntary Laboratory Accreditation Program (NVLAP) letters or the NVLAP Logo in this report reflects the MET Accreditation under the NVLAP Program, these letters, logo, or Statements do not claim product endorsement by NVLAP or any Agency of the U.S. Government.



Electro-Magnetic Compatibility

Test Report

for the

**Northrop Grumman Corporation
Cordless Communication System
Personal Communication Unit (PCU)**

Tested Under

FCC Part 15 Subpart C
Section 15.247
Title 47 of the CFR
for Intentional Radiators

MET REPORT: EMC13035A-PCU15247

April 24, 2003

PREPARED FOR:

Northrop Grumman Corporation, Electronic Systems
793 Elkridge Landing Road
Linthicum, MD 21090

PREPARED BY:

MET Laboratories, Inc.
914 West Patapsco Avenue
Baltimore, Maryland 21230-3432

Copyright 2003, MET Laboratories, Inc.

This report shall not be reproduced except in full, without the express written consent of MET Laboratories, Inc., nor shall this report, or any copy thereof be provided to a competitor of MET Laboratories, Inc.



Electro-Magnetic Compatibility

Test Report

for the

**Northrop Grumman Corp.
Cordless Communication System
Personal Communication Unit (PCU)**

Tested Under

FCC Part 15 Subpart C
Section 15.247
Title 47 of the CFR
for Intentional Radiators

MET REPORT: EMC13035A-PCU15247

April 24, 2003

PREPARED FOR:

Northrop Grumman Corporation
793 Elkridge Landing Road
Linthicum, MD 21090

Liming Xu
Project Engineer

Marianne T. Bosley
Report Writer

Engineering Statement: The measurements shown in this report were made in accordance with the procedures indicated, and the emissions from this equipment were found to be within the limits applicable. I assume full responsibility for the accuracy and completeness of these measurements, and for the qualifications of all persons taking them. It is further stated that upon the basis of the measurements made, the equipment tested is capable of operation in accordance with the requirements of Part 15, Section 15.247, of the FCC Rules under normal use and maintenance.

Len Knight
EMC Lab Manager



Table of Contents

- I. Executive Summary 1
 - A. Purpose of Test 2
 - B. Executive Summary 2
- II. General 3
 - A. Test Site 4
 - B. Description of Test Sample 4
 - C. General Test Setup 4
 - D. Mode of Operation 4
 - E. Modifications 7
 - F. Disposition of Test Sample 7
- III. Antenna Requirements 8
- IV. Emissions Requirements 10
 - A. Conducted Emissions 11
 - B. Radiated Emissions - General 12
- V. Bandwidth & Channelization Requirements 15
- VI. Peak Output Power Requirements 19
 - A. Peak Output Power (EIRP) 20
 - B. RF Exposure Requirements 22
- VII. Spurious Emissions - Radiated & RF Conducted - Requirements 23
- VIII. Hopping Capability Requirements 30
- IX. FHSS Non-Coordination Requirements 32
- X. Test Equipment 34
- XI. Certification Label & User's Manual Information 36
 - A. Certification Information 38
 - B. Label and User's Manual Information 41



List of Tables

Table 1.	Summary of Test Results	v
Table 2.	Summary of Test Data	v
Table 3.	EUT Compliance	2
Table 4.	References	2
Table 5.	Limits for Conducted Emissions from Intentional Radiators	11
Table 6.	Limits for Spurious Emissions from Intentional Radiators	12
Table 7.	Radiated Emissions (Spurious) Results - 30MHz - 1GHz	14
Table 8.	Radiated Emissions Results	29
Table 9.	Test Equipment for Intentional Radiators - §15.247	35

List of Figures

Figure 1.	Test Configuration A	5
Figure 2.	Test Configuration B	5
Figure 3.	FCC Intentional Radiators Tests Setup Photo	7



List of Terms and Abbreviations

AC	Alternating Current
Cal	Calibration
<i>d</i>	Measurement Distance
dB	Decibels
dBFA	Decibels above one microamp
dBV	Decibels above one microvolt
dBFA/m	Decibels above one microamp per meter
dBV/m	Decibels above one microvolt per meter
DC	Direct Current
E	Electric Field
DSL	Digital Subscriber Line
ESD	Electrostatic Discharge
EUT	Equipment Under Test
<i>f</i>	Frequency
FCC	Federal Communications Commission
CISPR	Comite International Special des Perturbations Radioelectriques (International Special Committee on Radio Interference)
GRP	Ground Reference Plane
H	Magnetic Field
HCP	Horizontal Coupling Plane
Hz	Hertz
IEC	International Electrotechnical Commission
kHz	kilohertz
kPa	kilopascal
kV	kilovolt
LISN	Line Impedance Stabilization Network
MHz	Megahertz
FH	microhenry
FF	microfarad
Fs	microseconds
NEBS	Network Equipment-Building System
OATS	Open Area Test Site
PRF	Pulse Repetition Frequency
RF	Radio Frequency
RMS	Root-Mean-Square
TWT	Traveling Wave Tube
V/m	Volts per meter
VCP	Vertical Coupling Plane



Summary of Test Results

These tests were conducted on a sample of the equipment for the purpose of demonstrating compliance with Part 15, Subpart C, Section 15.247. All tests were conducted using measurement procedure ANSI C63.4-1992.

Type of Submission/Rule Part:	Original Filing/Part 15	
EUT:	Cordless Communication System Personal Communication Unit (PCU)	
FCC ID:	LC3810R901G01	
Equipment Code:	FHSS	
RF Power output:	0.033W EIRP	0.0186W Conducted
Frequency Range (MHz):	2.402 GHz - 2.480 GHz	

Table 1.

Summary of Test Data

Name of Test	FCC Rule Part/Section	Results
Conducted Emissions	15.207(a)	Complies
Radiated Emissions	15.209(a)	Complies
Bandwidth & Channelization	15.247(a)	Complies
Output Power and RF Exposure	15.247(b)	Complies
Spurious Emissions - Radiated and RF Conducted	15.247(c)	Complies
Hopping Capability	15.247(g)	Complies
Non-coordination Requirements	15.247(h)	Complies

Table 2.



I. Executive Summary



I. Executive Summary

A. Purpose of Test

An EMC evaluation to determine compliance of the Cordless Communication System Personal Communication Unit (PCU) with the requirements of Part 15, Section 15.247, was conducted. (All references are to the most current version of Title 47 of the Code of Federal Regulations in effect). In accordance with §2.1033, the following data is presented in support of the Certification of the PCU. Northrop Grumman Corporation should retain a copy of this document should be kept on file for at least five years after the manufacturing of the PCU has been **permanently** discontinued.

B. Executive Summary

The following tests were performed in accordance with Northrop Grumman Corporation Purchase Order Number 8200046588:

Specifications	Description	Compliance
Title 47 of the CFR, Part 15, Subpart C, §15.207(a)	Electromagnetic Compatibility - Conducted Emissions for an Intentional Radiator	Complies
Title 47 of the CFR, Part 15, Subpart C, §15.209(a)	Electromagnetic Compatibility - Radiated Emissions for an Intentional Radiator	Complies
Title 47 of the CFR, Part 15, Subpart C, §15.247(a)	Electromagnetic Compatibility - Bandwidth & Channelization Requirements	Complies
Title 47 of the CFR, Part 15, Subpart C, 15.247(b)	Electromagnetic Compatibility - Output Power and RF Exposure Requirements	Complies
Title 47 of the CFR, Part 15, Subpart C, §15.247(c)	Electromagnetic Compatibility - Spurious Emissions Requirements - Radiated and RF Conducted	Complies
Title 47 of the CFR, Part 15, Subpart C, §15.247(g)	Electromagnetic Compatibility -Statement of Hopping Capability Requirements	Complies
Title 47 of the CFR, Part 15, Subpart C, §15.247(h)	Electromagnetic Compatibility -Non-Coordination Requirements	Complies

Table 3. EUT Compliance

The EUT, as supplied to MET Laboratories, complied with the requirements stated in this test report.

References	Description
Purchase Order #8200046588	Northrop Grumman Corp. Purchase Order for Mounted Warrior Cordless Communication System (Configuration 1) Testing
ANSI-C63.4:1992	Methods and Measurements of Radio-Noise Emissions from Low-Voltage Electrical And Electronic Equipment in the Range of 9 kHz to 40 GHz
FCC 47CFR, Chapter 1, Part 2	Title 47 Code of Federal Regulations Part 2 - Frequency Allocations and Radio Treaty Matters; General Rules and Regulations
FCC 47CFR, Chapter 1, Part 15	Title 47 Code of Federal Regulations Part 15 - Radio Frequency Devices
FCC DA 00-705	Public Notice - Filing and Measurement Guidelines for FHSS Systems

Table 4. References



II. General



II. General

A. Test Site

All testing was conducted at MET Laboratories, Inc., 914 West Patapsco Avenue, Baltimore, Maryland 21230-3432. Radiated Emissions measurements were performed inside of a Semi Anechoic Chamber. In accordance with §2.948(a)(2), a complete site description is filed with the Commission's Laboratory in Columbia, Maryland. MET Laboratories has been accredited by the National Voluntary Laboratory Accreditation Program (Lab Code: 100273-0)

B. Description of Test Sample

The EUT consisted of electronic circuits for power management, digital/audio processing and an RF transmitter/receiver. The PCU man-machine interface consists of four (4) pushbuttons and a two (2) character, seven(7) segment LED. The PCU housing is constructed of an engineered plastic resin with a conductive spray coating on the internal surfaces for EMC purposes. The EUT is designed for use by crewman in and around military armored vehicles with the intended purpose of providing an independent wireless voice communication capability or adding wireless connectivity to the existing on-board wired intercommunication system via a Universal Adapter Interface (UAI).

C. General Test Setup

The EUT was tested in the configuration shown on the following pages.

D. Mode of Operation

The Northrop Grumman Corporation PCU was configured in accordance with the manufacturer's instructions and was operated as follows for all testing contained in this report unless stated otherwise:

1. An AN/VIC-3 intercom system will be provided for testing of the PCU in a tethered mode. The PCU's AJ-107 will be connected to the A3206020 "bailout" cable on an intercom crew station.
2. When operating in the untethered mode, the PCU will only transmit when audio is present at the microphone of the attached PICVC headset. The PCU can be forced to transmit continuously by switching its mode from "AU" to "dA" using the buttons on the unit as described in the User Instruction document.

II. General

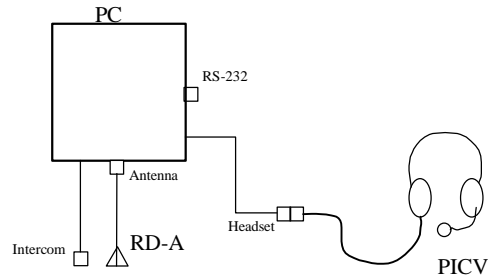

Block Diagram A – Untethered Operation

Figure 1. Test Configuration A

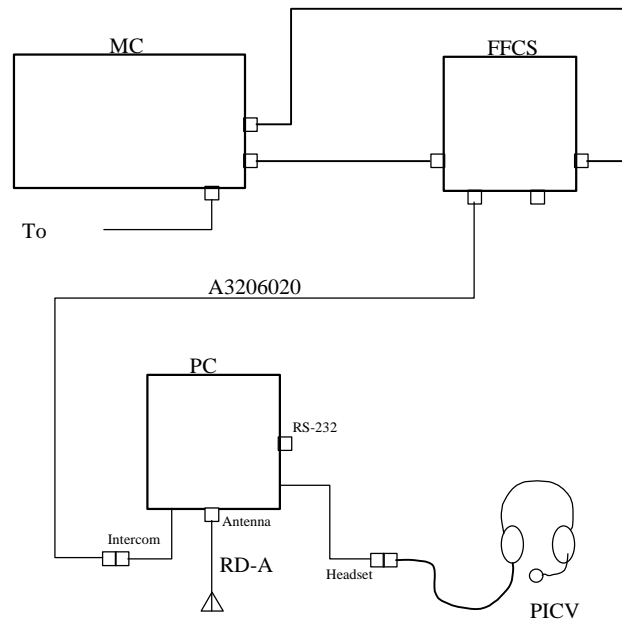

Block Diagram B – Tethered Operation

Figure 2. Test Configuration B



II. General

EUT

Reference to Test Configuration	Description/ Nomenclature	Model #	Serial #	Revision
PCU	Personal Communication Unit (PCU)	810R901G01	2019	N/A
RD-A	2.4 GHz Rubber Duck Antenna	PSTN3-2400RB	N/A	N/A

Support Equipment

Reference to Test Configuration	Description/ Nomenclature	Model #	Manufacturer
MCS	Master Control Station (MCS)	A3205747	NGC
FFCS	Full Function Crew Station (FFCS)	A3205746	NGC
PICVC	Headset	A3206612-X	NGC

Ports and Cabling

Ref ID	Port name on EUT	Type of Cable or reason for no cable	How many by default?	Length (m)	Shielded?	Termination Box ID & Port ID
PCU	Headset	Integrated	1		Y	PICVC
PCU	Intercom	Integrated	1		Y	FFCS (Headset)
PCU	RS-232	Capped				
PCU	Antenna	Direct mount				RD-A
RD-A	Jack	Direct mount				PCU (Antenna)



II. General

E. Modifications

Modifications were not necessary for compliance.

F. Disposition of Test Sample

Returned to:

Northrop Grumman Corporation, Electronic Systems
Post Office Box 1693 - MS1717
Baltimore, MD 21203



Figure 3. FCC Intentional Radiators Test Setup Photo



III. Antenna Requirements



III. Antenna Requirements

Antenna Evaluation Criteria

Requirements: The structure and application of the EUT were analyzed to determine compliance with Section 15.203 of the Rules. Section 15.203 states that the subject device must meet at least one of the following criteria:

- (a) Antenna be permanently attached to the unit.
- (b) Antenna must use a unique type of connector to attach to the EUT.
- (c) Unit must be professionally installed. Installer shall be responsible for verifying that the correct antenna is employed with the unit.

Results: EUT ocmplies with §15.203. The Northrop Grumman Corporation Cordless Communication System Personal Communication Unit (PCU) meets the criteria of this rule in the following manner:

The antenna, a 4 inch long 2.5 dBi gain rubber duck (Mobile Mark Communications P/N PSTN3-2400), is attached directly to a RP-BNC connector on the PCU.



IV. Emissions Requirements

IV. Emissions Requirements

A. Conducted Emissions



Requirements: The EUT shall meet the limits shown below:

Frequency Range (MHz)	Conducted Limit (dBuV)	
	Quasi-Peak	Average
0.15 - 0.5	66 to 56*	56 to 46*
0.5 - 5	56	46
5 - 30	60	50

Table 5. Limits for Intentional Radiators from FCC Part 15 §15.207(a)

*Decreases with the logarithm of the frequency.

Test Equipment: Test equipment utilized in this test is located in Section X of this report.

Test Configuration: The EUT was installed SETUP inside a shielded enclosure. The EUT was situated such that the back of the EUT was 0.4 m from one wall of the shielded enclosure, and the remaining sides of the EUT were no closer than 0.8 m from any other conductive surface. The EUT was powered from a 50 S/50 FH Line Impedance Stabilization Network (LISN).

Procedure: The EMC receiver scanned the frequency range from 150 kHz to 30 MHz. Conducted Emissions measurements were made in accordance with ANSI C63.4-1992 "Methods and Measurements of Radio-Noise Emissions from Low-Voltage Electrical and Electronic Equipment in the Range of 9 kHz to 40 GHz." The measurements were performed over the frequency range of 0.15 MHz to 30 MHz using a 50 S/50 FH LISN as the input transducer to an EMC/Field Intensity Meter. The tests were conducted in a RF shielded enclosure.

Results: Conducted Emissions Limits of 15.207(a) is not applicable to this device.

Test Engineer: N/A

Test Date: N/A



IV. Emissions Requirements

B. Radiated Emissions - General

Requirements: The EUT shall meet the limits shown below:

Frequency (MHz)	Limit (dB μ V/m) @ 3 m
30 - 88	100**
88 - 216	150**
216 - 960	200**
Above 960	500

Table 6. Limits for Spurious Emissions from Intentional Radiators from FCC Part 15 § 15.209(a)

** Except as provided in §15.209(g), fundamental emissions from intentional radiators operating under this Section shall not be located in the frequency bands 54-72 MHz, 76-88MHz, 174-216MHz or 470-806MHz. However, operation within these frequency bands is permitted under other sections of this Part, e.g. Sections 15.231 and 15.241.

Test Equipment: Test equipment for this test is located in Section X of this report.

Test Conditions: The EUT was placed on a 0.8 m high wooden table inside a shielded enclosure. An antenna was placed near the EUT and measurements of frequencies and amplitudes of field strengths were recorded for reference during final measurements. For final radiated testing, measurements were performed in a semi-anechoic chamber or OATS. Measurements were performed with the EUT oriented in 3 orthogonal axis and rotated 360 degrees to determine worst case orientation for maximum emissions.

For frequencies from 30 MHz to 1 GHZ, measurements were made using a quasi-peak detector with a 120 kHz bandwidth. For frequencies above 1 GHZ, peak measurements were made with a resolution bandwidth of 1 MHz and a video bandwidth of 1MHz and average measurements were made with RBW = 1MHz and VBW = 10 Hz.

For intentional radiators with a digital device portion which operates below 10 GHZ, the spectrum was investigated as per §15.33(a)(1) and §15.33(a)(4); i.e., the lowest RF signal generated or used in the device up to the 10th harmonic of the highest fundamental frequency or to 40 GHZ, whichever is lower.

In accordance with §15.35(b) the limit on the radio frequency emissions as measured using instrumentation with a peak detector function shall be 20dB above the maximum permitted average limit for the frequency being investigated unless a different peak emission limit is otherwise specified in the rules.



IV. Emissions Requirements

Procedure: For pre-scanning, the EMI receiver scanned the frequency range from 30 MHz to 10 GHz, per §15.33(a)(4) to obtain an Emission profile of the EUT. For each point of measurement, the turntable was rotated, the positions of the interface cables were varied, and the antenna height was varied between 1 m and 4 m, in order to find the maximum radiated Emissions. Measurements were taken using this technique with the antenna in two polarizations: horizontal and vertical.

Results: The EUT complied with the radiated Emissions limits of Section 15.209(a).

Test Engineer: Liming Xu

Test Date: December 11, 2002



IV. Emissions Requirements

Subject: Radiated Emissions - (Spurious) Electric Field Test Results

Specification: FCC Part 15 Subpart C, §15.209(a)

Frequency (MHz)	EUT Azimuth (Degrees)	Antenna Polarity (H/V)	Antenna HEIGHT (m)	Uncorrected Amplitude (dBuv)	Antenna Correction Factor (dB) (+)	Cable Loss (dB) (+)	Distance Correction Factor (dB) (-)	Corrected Amplitude (dBuv)	Limit (dBuv)	Margin (dB)	Pass/Fail
90.49	86	H	2.4	43.65	6.97	2.19	10.46	42.35	43.5	-1.15	3 dB
90.49	82	V	1	31.54	6.74	2.19	10.46	30.01	43.5	-13.49	pass
118.3	82	H	2.4	35.19	7.17	2.42	10.46	34.32	43.5	-9.18	pass
118.3	82	V	1	21	7.37	2.42	10.46	20.33	43.5	-23.17	pass
151.3	82	H	2.4	35.1	8.00	2.65	10.46	35.29	43.5	-8.21	pass
151.3	82	V	1	25.1	8.03	2.65	10.46	25.32	43.5	-18.18	pass
320	73	H	2.4	21.83	13.40	3.75	10.46	28.52	46.4	-17.88	pass
320	73	V	2	21	13.80	3.75	10.46	28.09	46.4	-18.31	pass
446.4	73	H	2.2	19.59	16.40	4.28	10.46	29.81	46.4	-16.59	pass
446.4	73	V	1	18.95	16.78	4.28	10.46	29.55	46.4	-16.85	pass
512.5	73	H	1.7	24.2	17.85	4.52	10.46	36.11	46.4	-10.29	pass
512.5	73	V	2	17.5	17.40	4.52	10.46	28.96	46.4	-17.44	pass

Table 7. Radiated Emissions (spurious) Results - 30 MHz - 1 GHZ



V. Bandwidth & Channelization Requirements



V. Bandwidth & Channelization Requirements

Bandwidth and Bandedge Requirements - §15.247(a)(c)

Requirements: For systems using digital modulation techniques, the EUT may operate in the 902-928 MHz, 2400-2483.5 MHz and 5725-5850 MHz bands. For DTS, the minimum 6dB bandwidth shall be at least 500 kHz. For frequency hopping systems, the EUT shall have hopping channel carrier frequencies separated by a minimum of 25kHz or the 20 dB bandwidth of the hopping channel, whichever is greater.

Test Equipment: Test equipment for this test is located in Section X of this report

Test Configuration/

Procedure: The transmitter output was connected to the spectrum analyzer through an attenuator. The bandwidth of the fundamental frequency was measured with the spectrum analyzer using a RBW approximately equal to 1% of the total emission bandwidth, $VBW \geq RBW$. The 20 dB bandwidth was measured and recorded.

Results: This device has the following technical specifications:

1. The radio hops through 75 frequencies.
2. The dwell time of each frequency is 0.16 seconds within a 30 second period.
3. The carrier frequency separation is 1 MHz.
4. The transmitter/receiver units hop in synchronization with each other within the system.

Equipment complies with § 15.247 (a). The 20 dB bandwidth was determined from the following plots:



V. Bandwidth & Channelization Requirements

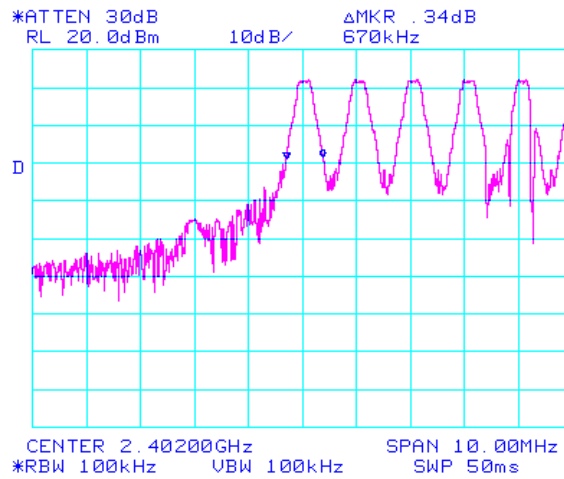
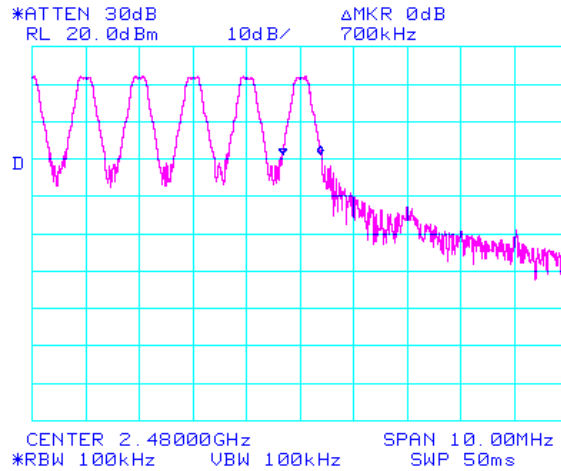



V. Bandwidth & Channelization Requirements

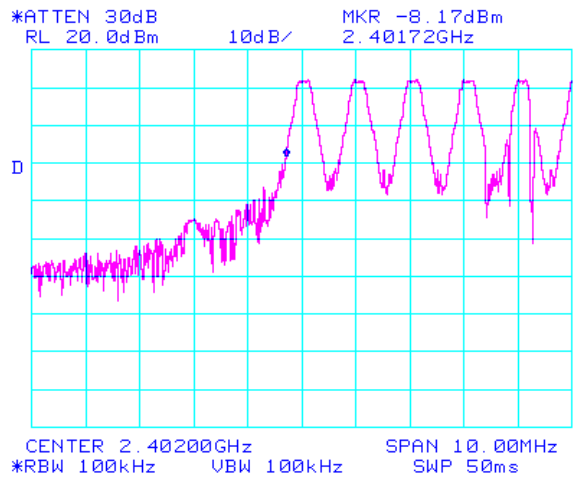
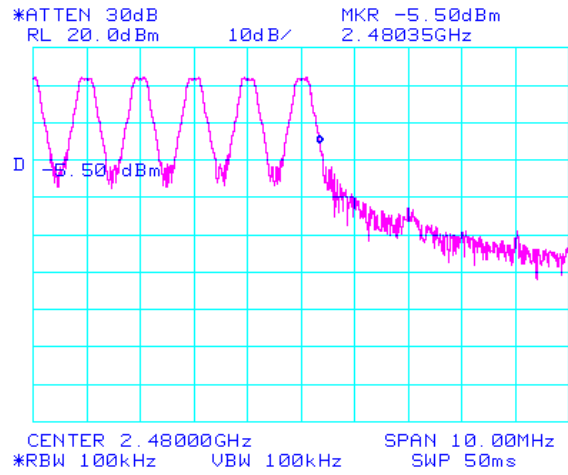

Test Engineer: Liming Xu

Test Date: December 6, 2002



VI. Peak Output Power Requirements



VI. Peak Output Power Requirements

A. Peak Output Power (EIRP) - §15.247(b)

Requirements: The EUT maximum peak output power shall not exceed 1 watt for frequency hopping systems operating in the 2400-2483.5 MHz band employing at least 75 hopping channels, and all frequency hopping systems in the 5725-5850 MHz band. For all other frequency hopping systems in the 2400-2483.5 MHz band the maximum peak output power shall not exceed 0.125 watts.

Test Equipment: Test equipment for this test is located in Section X of this report

Test Configuration/

Procedure: The transmitter output was connected to the spectrum analyzer through an attenuator. The RBW is larger than the bandwidth of the emission, $VBW \geq RBW$.

Results: Equipment complies with § 15.247 (b)

Peak Output Power = 0.0186W

The peak output power was determined from the following plots:

VI. Peak Output Power Requirements

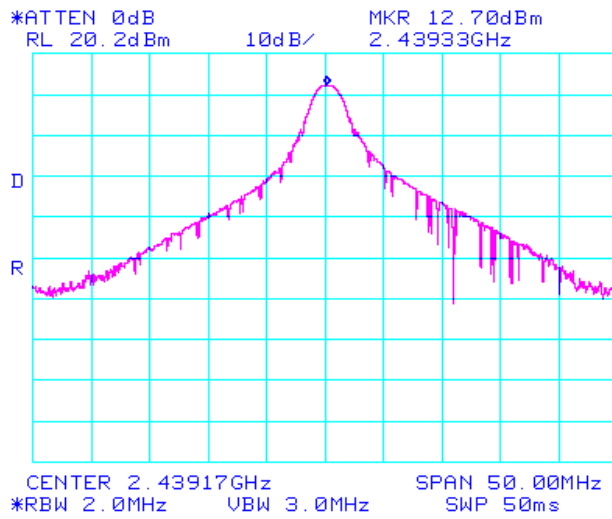

Conducted RF power output = 12.7 dBm.

4 inch antenna gain = 2.5dBi
Total RF power = 12.7 + 2.5 = 15.2 dBm = 0.035 Watts

8 inch external antenna gain = 6 dBm
Total RF power = 12.7 + 6 = 18.7 dBm = 0.072 Watts

Test Engineer: Liming Xu

Test Date: December 6, 2002

VI. Peak Output Power Requirements



B. RF Exposure Requirements - §15.247(b)(5); §1.1307(b)(1)

Specification:

Systems operating under the provisions of this section shall be operated in a manner that ensures that the public is not exposed to radio frequency energy levels in excess of the Commission's guidelines.

See SAR test report



VII. Spurious Emissions - Radiated and RF Conducted - Requirements



VII. Spurious Emissions - Radiated and RF Conducted - Requirements

Spurious Emissions - Radiated and RF Conducted - 1GHz to 10 GHz - Electric Field Test Results

Requirements: FCC Part 15 Subpart C, §15.209(a); 15.247(c); for any emissions in restricted bands, as defined in Section 15.205.

Test Equipment: Test equipment for this test is located in Section X of this report

Test Configuration/

Procedure: The EUT was placed on a 0.8 m high wooden table inside a shielded enclosure. An antenna was placed near the EUT and measurements of frequencies and amplitudes of field strengths were recorded for reference during final measurements. For final radiated testing, measurements were performed in a semi-anechoic chamber or OATS. Measurements were performed with the EUT oriented in 3 orthogonal axis and rotated 360 degrees to determine worst case orientation for maximum emissions.

For frequencies from 30 MHz to 1 GHz, measurements were made using a quasi-peak detector with a 120 kHz bandwidth. For frequencies above 1 GHz, peak measurements were made with a resolution bandwidth of 1 MHz and a video bandwidth of 1MHz and average measurements were made with RBW = 1MHz and VBW = 10 Hz.

For intentional radiators with a digital device portion which operates below 10 GHz, the spectrum was investigated as per §15.33(a)(1) and §15.33(a)(4); i.e., the lowest RF signal generated or used in the device up to the 10th harmonic of the highest fundamental frequency or to 40 GHz, whichever is lower.

In accordance with §15.35(b) the limit on the radio frequency emissions as measured using instrumentation with a peak detector function shall be 20dB above the maximum permitted average limit for the frequency being investigated unless a different peak emission limit is otherwise specified in the rules.

For RF Conducted Emissions, the transmit output connected to the analyzer through the attenuator. RBW = 100kHz, VBW \geq RBW.

VII. Spurious Emissions - Radiated and RF Conducted - Requirements



Results: Equipment complies with § 15.247 (c)

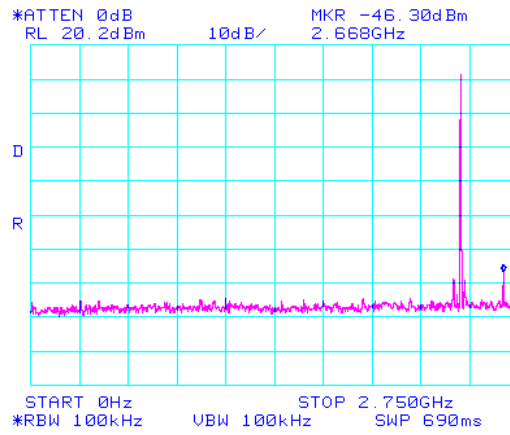

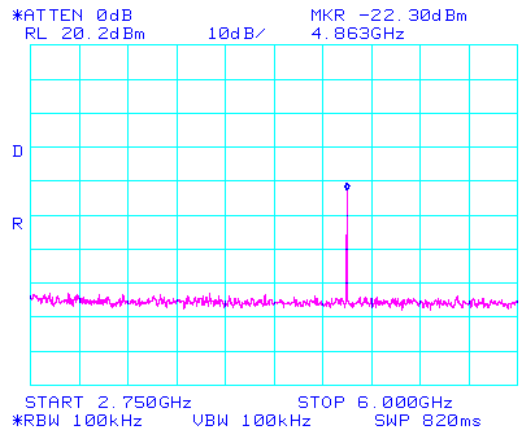

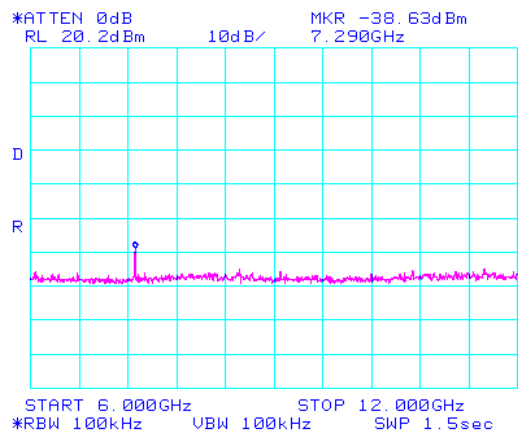

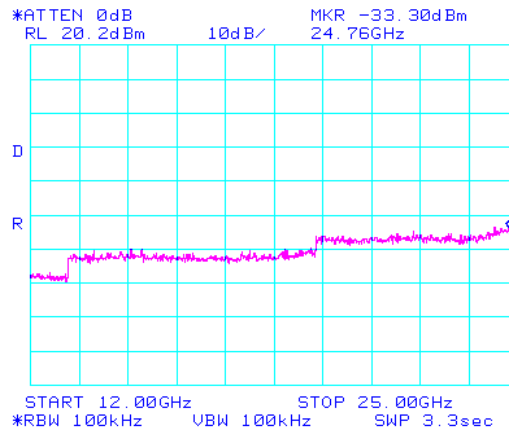



Frequency (GHz)	EUT Azimuth (Degrees)	Antenna Polarity (H/V)	Antenna HEIGHT (m)	Uncorrected Amplitude (dBuv)	Antenna Correction Factor (dB) (+)	System Gain (dB) (-)	Distance Correction Factor (dB) (-)	Corrected Amplitude (dBuv)	Limit (dBuv)	Margin (dB)	Pass/Fail
4.88	0	H	1	54	33.04	27.24	20	39.80	74	-34.2	pass
4.88	0	V	1	72.67	32.73	27.24	20	58.16	74	-15.84	Pass
There is no detectable emissions between 4.88 GHz and 25 GHz											

Table 8. Radiated Emissions Results - Peak measurements

Frequency (GHz)	EUT Azimuth (Degrees)	Antenna Polarity (H/V)	Antenna HEIGHT (m)	Uncorrected Amplitude (dBuv)	Antenna Correction Factor (dB) (+)	System Gain (dB) (-)	Distance Correction Factor (dB) (-)	Corrected Amplitude (dBuv)	Limit (dBuv)	Margin (dB)	Pass/Fail
4.88	0	H	1	43.37	33.04	27.24	20	28.17	54	-25.29	pass
4.88	0	V	1	61.01	32.73	27.24	20	46.63	54	-7.47	Pass
There is no detectable emissions between 4.88 GHz and 25 GHz											

Table 9. Radiated Emissions Results - Average Measurements

Duty Cycle = $1.417/5.417 = 0.262$

20 Log (0.262) = -11.63 dB

54(peak) - 11.63 = 43.37 dBuV (Average)

72.64(peak) - 11.63 = 61.01 dBuV (Average)

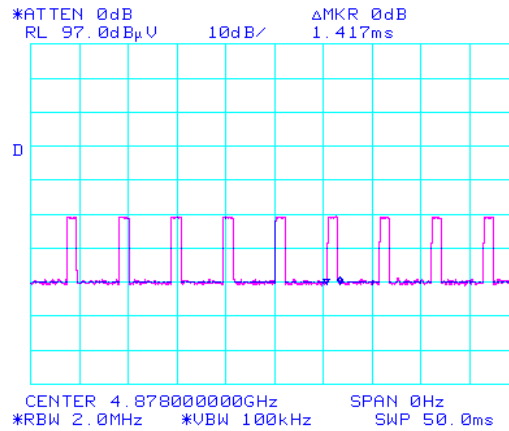
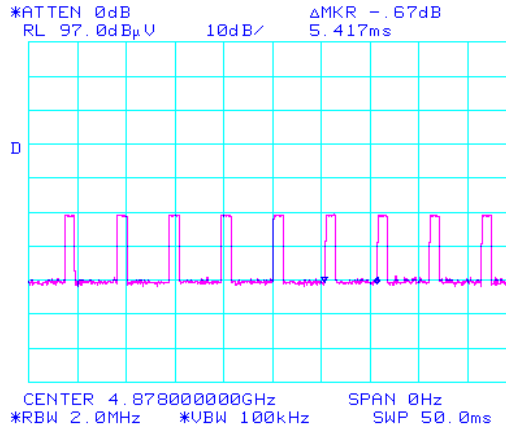

Test Engineer: Liming Xu

Test Date: December 9 and 10, 2002



VIII. Hopping Capability Requirements



VIII. Hopping Capability Requirements

Hopping Capability - §15.247(g)

Requirements: As required by this section, a statement describing the hopping capability of this EUT is submitted as a separate exhibit.

Results: Equipment complies with § 15.247 (g). See separate exhibit for description of hopping capability.



IX. FHSS Non-Coordination Requirements



IX. FHSS Non-coordination Requirements

Non-coordinating Requirement - §15.247(h)

Requirements: As required by this section, a statement describing the hopping capability of this EUT is submitted as a separate exhibit.

Results: Equipment complies with § 15.247 (g). See separate exhibit for description of hopping capability.



X. Test Equipment



X. Test Equipment

Test Equipment	Manufacturer	Model #	Met Asset #	Cal Date	Cal Due
Receiver	HP	8546A	1T4302	9/17/02	9/17/03
Antenna	SCHAFFNER	CBL6140A	1T4303	3/27/02	3/27/03
Antenna	EMCO	3115	1T2665	3/3/02	3/3/03
Test Room	Chamber #1	None	1T4300	8/21/02	8/21/03

Table 9. Test Equipment for Intentional Radiators - §15.247

Note: Functionally verified test equipment is verified at the time of testing.



XI. Certification Label & User's Manual Information



A. Certification Information

The following is extracted from Title 47 of the Code of Federal Regulations, Part 2, Subpart I — Marketing of Radio frequency devices:

§ 2.801 Radio-frequency device defined.

As used in this part, a radio-frequency device is any device which in its operation is capable of Emitting radio-frequency energy by radiation, conduction, or other means. Radio- frequency devices include, but are not limited to:

- (a) The various types of radio communication transmitting devices described throughout this chapter.
- (b) The incidental, unintentional and intentional radiators defined in Part 15 of this chapter.
- (c) The industrial, scientific, and medical equipment described in Part 18 of this chapter.
- (d) Any part or component thereof which in use emits radio-frequency energy by radiation, conduction, or other means.

§ 2.803 Marketing of radio frequency devices prior to equipment authorization.

- (a) Except as provided elsewhere in this chapter, no person shall sell or lease, or offer for sale or lease (including advertising for sale or lease), or import, ship or distribute for the purpose of selling or leasing or offering for sale or lease, any radio frequency device unless:
 - (1) In the case of a device subject to certification, such device has been authorized by the Commission in accordance with the rules in this chapter and is properly identified and labeled as required by §2.925 and other relevant sections in this chapter; or
 - (2) In the case of a device that is not required to have a grant of equipment authorization issued by the Commission, but which must comply with the specified technical standards prior to use, such device also complies with all applicable administrative (including verification of the equipment or authorization under a Declaration of Conformity, where required), technical, labeling and identification requirements specified in this chapter.
- (d) Notwithstanding the provisions of paragraph (a) of this section, the offer for sale solely to business, commercial, industrial, scientific or medical users (but not an offer for sale to other parties or to end users located in a residential environment) of a radio frequency device that is in the conceptual, developmental, design or pre-production stage is permitted prior to equipment authorization or, for devices not subject to the equipment authorization requirements, prior to a determination of compliance with the applicable technical requirements *provided* that the prospective buyer is advised in writing at the time of the offer for sale that the equipment is subject to the FCC rules and that the equipment will comply with the appropriate rules before delivery to the buyer or to centers of distribution.
- (e)(1) Notwithstanding the provisions of paragraph (a) of this section, prior to equipment authorization or determination of compliance with the applicable technical requirements any radio frequency device may be



operated, but not marketed, for the following purposes and under the following conditions:

- (i) Compliance testing;
 - (ii) Demonstrations at a trade show provided the notice contained in paragraph (c) of this section is displayed in a conspicuous location on, or immediately adjacent to, the device;
 - (iii) Demonstrations at an exhibition conducted at a business, commercial, industrial, scientific or medical location, but excluding locations in a residential environment, provided the notice contained in paragraphs (c) or (d) of this section, as appropriate, is displayed in a conspicuous location on, or immediately adjacent to, the device;
 - (iv) Evaluation of product performance and determination of customer acceptability, provided such operation takes place at the manufacturer's facilities during developmental, design or pre-production states; or
 - (v) Evaluation of product performance and determination of customer acceptability where customer acceptability of a radio frequency device cannot be determined at the manufacturer's facilities because of size or unique capability of the device, provided the device is operated at a business, commercial, industrial, scientific or medical user's site, but not at a residential site, during the development, design or pre-production stages.
- (e)(2) For the purpose of paragraphs (e)(1)(iv) and (e)(1)(v) of this section, the term *manufacturer's facilities* includes the facilities of the party responsible for compliance with the regulations and the manufacturer's premises, as well as the facilities of other entities working under the authorization of the responsible party in connection with the development and manufacture, but not the marketing, of the equipment.
- (f) For radio frequency devices subject to verification and sold solely to business, commercial, industrial, scientific and medical users (excluding products sold to other parties or for operation in a residential environment), parties responsible for verification of the devices shall have the option of ensuring compliance with the applicable technical specifications of this chapter at each end user's location after installation, provided that the purchase or lease agreement includes a proviso that such a determination of compliance be made and is the responsibility of the party responsible for verification of the equipment.



The following is extracted from Title 47 of the Code of Federal Regulations, Part 2, Subpart J — Equipment Authorization Procedures:

§ 2.901 Basis and Purpose

- (a) In order to carry out its responsibilities under the Communications Act and the various treaties and international regulations, and in order to promote efficient use of the radio spectrum, the Commission has developed technical standards for radio frequency equipment and parts or components thereof. The technical standards applicable to individual types of equipment are found in that part of the rules governing the service wherein the equipment is to be operated.¹ In addition to the technical standards provided, the rules governing the service may require that such equipment be verified by the manufacturer or importer, be authorized under a Declaration of Conformity, or receive an equipment authorization from the Commission by one of the following procedures: certification or registration.
- (b) The following sections describe the verification procedure, the procedure for a Declaration of Conformity, or the procedures to be followed in obtaining certification from the Commission and the conditions attendant to such a grant, whichever is applicable.

§ 2.907 Certification.

- (a) Certification is an equipment authorization issued by the Commission, based on representation and test data submitted by the applicant.
- (b) Certification attaches to all units subsequently marketed by the grantee which are identical (see Section 2.908) to the sample tested except for permissive changes or other variations authorized by the Commission pursuant to Section 2.1043.

§ 2.948 Description of measurement facilities.

- (a) Each party making measurements of equipment that is subject to an equipment authorization under Part 15 or Part 18 of this chapter, regardless of whether the measurements are filed with the Commission or kept on file by the party responsible for compliance of equipment marketed within the U.S. or its possessions, shall compile a description of the measurement facilities employed.
 - (1) If the measured equipment is subject to the verification procedure, the description of the measurement facilities shall be retained by the party responsible for verification of the equipment.
 - (i) If the equipment is verified through measurements performed by an independent laboratory, it is acceptable for the party responsible for verification of the equipment to rely upon the description of the measurement facilities retained by or placed on file with the Commission by that laboratory. In this situation, the party responsible for the verification of the equipment is not required to retain a duplicate copy of the description of the measurement facilities.

¹In this case, the equipment is subject to the rules of Part 15. More specifically, the equipment falls under Subpart C (of Part 15), which deals with intentional radiators.



-
- (ii) If the equipment is verified based on measurements performed at the installation site of the equipment, no specific site calibration data is required. It is acceptable to retain the description of the measurement facilities at the site at which the measurements were performed.

 - (2) If the equipment is to be authorized by the Commission under the certification procedure, the description of the measurement facilities shall be filed with the Commission's Laboratory in Columbia, Maryland. The data describing the measurement facilities need only be filed once but must be updated as changes are made to the measurement facilities or as otherwise described in this section. At least every three years, the organization responsible for filing the data with the Commission shall certify that the data on file is current.



B. Label and User's Manual Information

The following is extracted from Title 47 of the Code of Federal Regulations, Part 15, Subpart A — General:

§ 15.19 Labeling requirements.

- (a) In addition to the requirements in Part 2 of this chapter, a device subject to certification or verification shall be labeled as follows:
- (1) Receivers associated with the operation of a licensed radio service, e.g., FM broadcast under Part 73 of this chapter, land mobile operation under Part 90, etc., shall bear the following statement in a conspicuous location on the device:

This device complies with Part 15 of the FCC Rules. Operation is subject to the condition that this device does not cause harmful interference.

- (2) A stand-alone cable input selector switch, shall bear the following statement in a conspicuous location on the device:

This device is verified to comply with Part 15 of the FCC Rules for use with cable television service.

- (3) All other devices shall bear the following statement in a conspicuous location on the device:

This device complies with Part 15 of the FCC Rules. Operation is subject to the following two conditions:

(1) This device may not cause harmful interference, and (2) this device must accept any interference received, including interference that may cause undesired operation.

- (4) Where a device is constructed in two or more sections connected by wires and marketed together, the statement specified under paragraph (a) of this section is required to be affixed only to the main control unit.

- (5) When the device is so small or for such use that it is not practicable to place the statement specified under paragraph (a) of this section on it, the information required by this paragraph shall be placed in a prominent location in the instruction manual or pamphlet supplied to the user or, alternatively, shall be placed on the container in which the device is marketed. However, the FCC identifier or the unique identifier, as appropriate, must be displayed on the device.

§ 15.21 Information to user.

The users manual or instruction manual for an intentional or unintentional radiator shall caution the user that changes or modifications not expressly approved by the party responsible for compliance could void the user's authority to operate the equipment



§ 15.27(a) Special Accessories.

Equipment marketed to a consumer must be capable of complying with the necessary regulations in the configuration in which the cables and/or special connectors are required to enable an unintentional or intentional radiator to comply with the emission limits in this part, the equipment must be marketed with, i.e. shipped and sold with, those special accessories. However, in lieu of shipping or packaging the special accessories with the unintentional or intentional radiator, the responsible party may employ other methods of ensuring that the special accessories are provided to the consumer, without additional charge.

Information detailing any alternative method used to supply the special accessories for a grant of equipment authorization or retained in the verification records, as appropriate. The party responsible for the equipment, as detailed in §2.909 of this chapter, shall ensure that these special accessories are provided with the equipment. The instruction manual for such devices shall include appropriate instructions on the first page of text concerned with the installation of the device that these special accessories must be used with the device. It is the responsibility of the user to use the needed special accessories supplied with the equipment.

The following is extracted from Title 47 of the Code of Federal Regulations, Part 15, Subpart B — Unintentional Radiators:

§ 15.105 Information to the user.

- (a) For a Class B digital device or peripheral, the instructions furnished the user shall include the following or similar statement, placed in a prominent location in the text of the manual:

Note: This equipment has been tested and found to comply with the limits for a Class B digital device, pursuant to Part 15 of the FCC Rules. These limits are designed to provide reasonable protection against harmful interference when the equipment is operated in a residential environment. This equipment generates, uses, and can radiate radio frequency energy and, if not installed and used in accordance with the instruction manual, may cause harmful interference to radio communications. However, there is no guarantee that interference will not occur in a particular installation. If this equipment does cause harmful interference to radio or television reception, which can be determined by turning the equipment off and on, the user is encouraged to try to correct the interference by one or more of the following measures:

- Reorient or relocate the receiving antenna.
- Increase the separation between the equipment and receiver.
- Connect the equipment into an outlet on a circuit different from that to which the receiver is connected.
- Consult the dealer or an experienced radio/TV technician for help



END OF REPORT
