

MEASUREMENT REPORT

(FCC : Part 15 Subpart C (15.247) / ANSI C63.4-2003)



Testing Laboratory
1288

Product.....: Multi-DSL Router
Trade Name.....: COMTREND
Model No.....: VR-3031u, VR-3032u
Applicant.....: COMTREND CORPORATION
Applicant Address.....: 3F-1, 10 Lane 609, Chung Hsin Road,
Section 5 San Chung District, New Taipei
City 24159, Taiwan

Report Number	MLT1308P15004
Applicant	COMTREND CORPORATION
Product	Multi-DSL Router
Sample Received Date	2013/8/15
Sample Tested Date	2013/8/15 ~ 2013/9/6

Report Prepared By	Jesse Tien
Signature	
Date Prepared	2013/9/10

Report Authorized By	Roger Chen
Signature	
Date Authorized	2013/9/10

Test By

Max Light Technology Co., Ltd.
 Room 5, 8F, No.125, Section 3 Roosevelt Road,
 Taipei, Taiwan., R.O.C.
 Office : Tel: 886-2-2363-2447 Fax: 886-2-2363-2597
 Lab. : Tel: 886-2-2663-3486 Fax: 886-2-2663-3582

It may be duplicated completely for legal use with the allowance of the applicant.
 It shall not be reproduced except in full, without the written approval of our
 laboratory.

Table of Contents :

History of Test Report -----	4
1. General -----	6
2. Conducted Emissions Requirements-----	10
3. Radiated Emissions Requirement-----	24
4. Maximum Conducted Output Power Requirements -----	39
5. Minimum 6dB RF Bandwidth Requirements-----	51
6. Maximum Power Density Requirements-----	62
7. Out of Band Conducted Spurious Emissions Requirements -----	68
8. Band Edges Requirement-----	88
9. Antenna Requirements-----	93
Appendix I - EUT Test Setup -----	94
Appendix II - Brand / Trade Name & Model No. Multiple Listee-----	95



History of Test Report

Original Report Issue Date: 2013/9/10

No additional attachment

Additional attachments were issued as in the following record:

Attachment No.	Issue Date	Description
MLT1308P15004	2013/9/10	Original report

CERTIFICATION

We here by verify that :

The test data, data evaluation, test procedures and equipment configurations shown in this report were made in accordance with the procedures given in ANSI C63.4-2003. All test were conducted by

MLT(Max Light Technology Co.,Ltd) Room 5, 8F, No.125, Section 3 Roosevelt Road, Taipei, Taiwan, R.O.C Also, we attest to the accuracy of each.

We further submit that the energy emitted by the sample EUT tested as described in the report is in compliance with Class B radiated and conducted emission limit of FCC Rules Part 15 Subpart C (15.247).

Applicant Name	COMTREND CORPORATION
Applicant Address	3F-1, 10 Lane 609, Chung Hsin Road, Section 5 San Chung District, New Taipei City 24159, Taiwan
Manufacturer Name	COMTREND CORPORATION
Manufacturer Address	3F-1, 10 Lane 609, Chung Hsin Road, Section 5 San Chung District, New Taipei City 24159, Taiwan

Equipment	Multi-DSL Router
Model No	VR-3031u, VR-3032u
FCC ID	L9VVR-3031U

Report Prepared By	Jesse Tien
Signature	

Report Authorized By	Roger Chen
Signature	

1. General

1.1 Introduction

The following measurement report is submitted on behalf of COMTREND CORPORATION In support of a Class B Digital Device certification in accordance with Part2 Subpart J and Part 15 Subpart C of the Commission's and Regulations.

1.2 Customer Details

Applicant Name	COMTREND CORPORATION
Applicant Address	3F-1, 10 Lane 609, Chung Hsin Road, Section 5 San Chung District, New Taipei City 24159, Taiwan
Manufacturer Name	COMTREND CORPORATION
Manufacturer Address	3F-1, 10 Lane 609, Chung Hsin Road, Section 5 San Chung District, New Taipei City 24159, Taiwan

1.3 Technical data of EUT

Equipment	Multi-DSL Router
Model No	VR-3031u, VR-3032u
FCC ID	L9VVR-3031U
Power Type	Model : AMS9-1201000FU2 Input : AC100 - 240V , 50 ~ 60Hz , 0.5A Max Output : DC12V , 1A
Type of Modulation	CCK, DQPSK, DBPSK for DSSS 64QAM, 16QAM, QPSK, BPSK for OFDM
Transfer rate	802.11b: 11/ 5.5/ 2/ 1Mbps 802.11g: 54/ 48/ 36/ 24/ 18/ 12/ 9/ 6Mbps 802.11n HT20: 130, 117, 104, 78, 52, 39, 26, 13Mbps 802.11n HT40: 270, 243, 216, 162, 108, 81, 54, 27Mbps
Type of Antenna	Dipole Antenna
Frequency of Channel	See Next page

During testing the EUT was operated at Tx or Rx mode for each emission measured. This was done in order to ensure that maximum emission levels were attained.

802.11b & 802.11g & 802.11n HT20 Frequency of Each Channel (Working Frequency)

Channel No.	Frequency (MHz)
01	2412
02	2417
03	2422
04	2427
05	2432
06	2437
07	2442
08	2447
09	2452
10	2457
11	2462

802.11n HT40 Frequency of Each Channel (Working Frequency)

Channel No.	Frequency (MHz)
03	2422
04	2427
05	2432
06	2437
07	2442
08	2447
09	2452

1.4 Summary Of Tests

47 CFR Part 15 Subpart C			
Reference	Test	Results	Note
15.207	AC Power Conducted Emission	PASS	
15.209	Radiated Emission	PASS	
15.247(c)	Transmitter Radiated Emissions	PASS	
15.247(b)	Max. Output Power	PASS	
15.247(a)(2)	6dB RF Bandwidth	PASS	
15.247(d)	Max. Power Density	PASS	
15.247(c)	Out of Band Conducted Spurious Emission	PASS	
15.247(c)	Band Edge Measurement	PASS	
15.203	Antenna Requirement	PASS	

1.5 Description of Support Equipment

In order to construct the minimum system which required by the ANSI C63.4-2003 / ICES-003: 2004, all the peripheral equipments were located in the far end.

1.6 Configuration of System Under Test

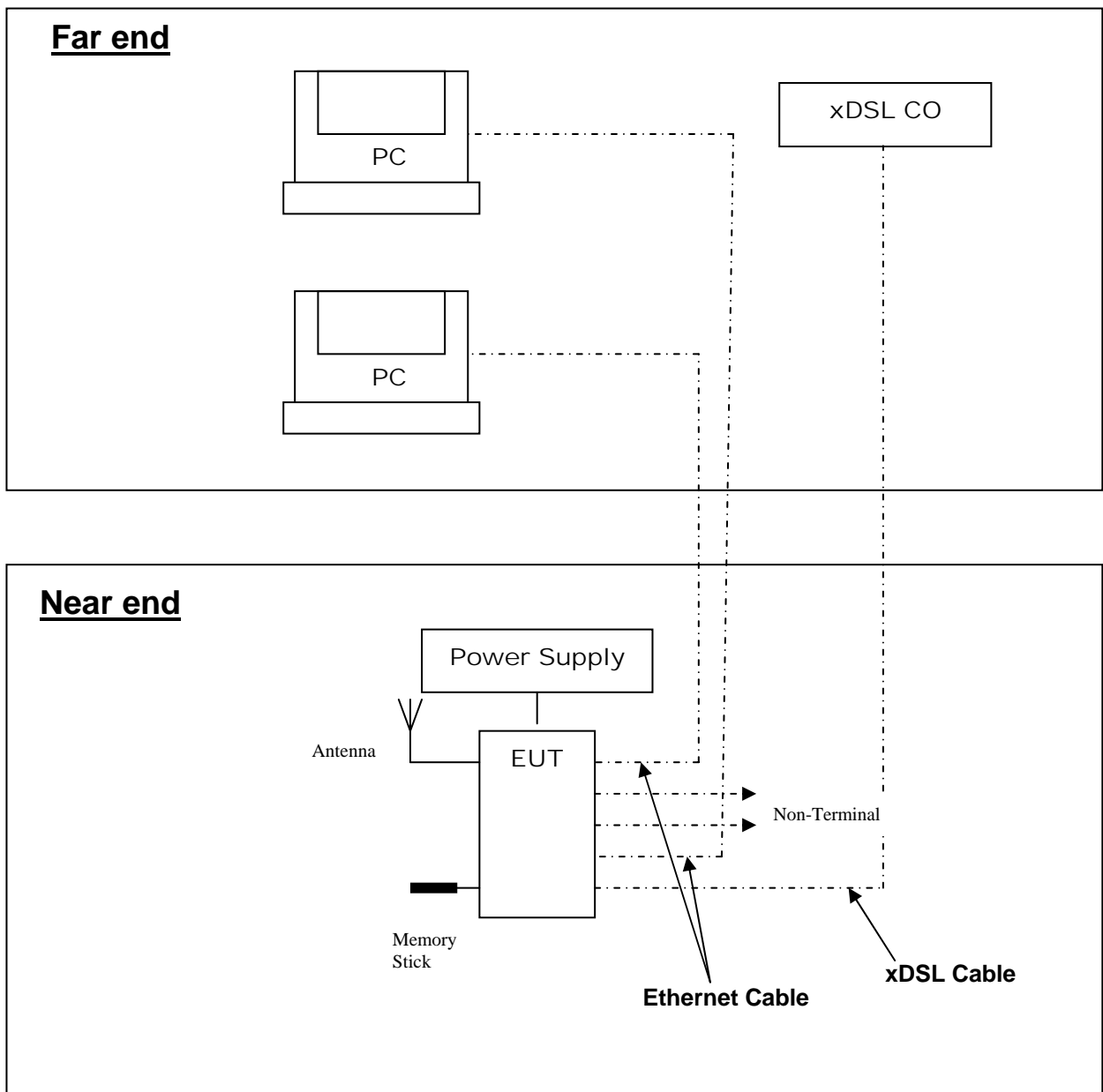

1.7 Test Procedure

All measurements contained in this report were performed according to the techniques described in Measurement procedure ANSI C63.4-2003 followed KDB 558074 v03r01 and KDB 662911 for this testing.

1.8 General Test Condition

The conditions under which the EUT operates were varied to determine their effect on the equipment's emission characteristics. The final configuration of the test system and the mode of operation used during these tests were chosen as that which produced the highest emission levels. However, only those conditions which the EUT was considered likely to encounter in normal use were investigated. The system's radiated and conducted emissions were investigated while the computer alternately transferred data to the EUT as well as to the monitor and printer. Using a test program which sent a continuous data and transferred data to and from the EUT was proven to worst case emissions. The system's physical layout and cabling was randomly arranged to ensure that maximum emission levels were attained.

This assessment of the maximum conducted output power tests is base on the minimum transfer rate will produce a maximum output power.

802.11b data rate: 11M

802.11g data rate: 24M

802.11gn HT20 data rate: 13M

802.11gn HT40 data rate: 27M

Note: All conditions have been evaluated and the test result in this report is the worst case.

2. Conducted Emissions Requirements

2.1 General & Setup :

The power line conducted emission measurements were performed in a shielded enclosure. The EUT was assembled on a wooden table which is 80 centimeters high, was placed 40 centimeters from the back wall and at least 1 meter from the sidewall.

Power was fed to the EUT from the public utility power grid through a line filter and EMCO Model 3825/2 Line Impedance Stabilization Networks (LISN). The LISN housing, measuring instrumentation case, ground plane, etc., were electrically bonded together at the same RF potential. The Spectrum analyzer was connected to the AC line through an isolation transformer. The 50-ohm output of the LISN was connected to the spectrum analyzer directly. Conducted emission levels were in the CISPR quasi-peak detection mode. The analyzer's 6 dB bandwidth was set to 9 KHz. No post-detector video filter was used.

The spectrum was scanned from 150 KHz to 30 MHz. The physical arrangement of the test system and associated cabling was varied (within the scope of arrangements likely to be encountered in actual use) to determine the effect on the unit's emanations in amplitude and frequency. All spurious emission frequencies were observed. The highest emission amplitudes relative to the appropriate limit were measured and have been recorded in paragraph 2.5.

2.2 Test Equipment List :

Item	Mfr/Brand	Instruments	Serial No.	Model/Type No.	Calibrated Date	Next Cal. Date
1.	HP	Spectrum Analyzer	73412A00110	8591EM	2013/03/21	2014/03/21
2.	EMCO	LISN	2658	3825/2	2013/03/01	2014/03/01
3.	TESEQ	ISN	24801	ISN T8	2013/05/22	2014/05/22

2.3 Test Condition :

EUT tested in accordance with the specifications given by the manufacturer, and exercised in the most unfavorable manner.

2.4 Conducted Emissions Limits :

FCC Part 15

Frequency range (MHz)	Limits (dBuV)			
	Class A		Class B	
	QP	Avg.	QP	Avg.
0.15 to 0.50	79	66	66 to 56	56 to 46
0.50 to 5.0	73	60	56	46
5.0 to 30	73	60	60	50

2.5 Measurement Data Of Conducted Emissions :

2.5.1 Conducted Emissions

The following table shows a summary of the highest emissions of power line conducted emissions to the HOT and NEUTRAL conductor of the EUT power.

Test Mode : 802.11b (CH01)

Conducted Emissions								
Conductor	Frequency (MHz)	Read(dBuV)		Factor	Limits (dBuV)		Amplitude (dBuV)	
		QP	AV		QP	AV	QP	AV
L1	0.177	44.99	--	1.12	64.64	54.64	46.11	--
	0.358	38.19	--	1.15	58.78	48.78	39.34	--
	1.249	37.38	--	1.36	56	46	38.74	--
	2.023	39.85	--	1.51	56	46	41.36	--
	3.173	39.69	--	1.93	56	46	41.62	--
	3.528	39.10	--	1.99	56	46	41.09	--
	13.337	40.95	--	2.04	60	50	42.99	--
L2	0.177	41.52	--	1.07	64.64	54.64	42.59	--
	1.544	35.71	--	1.39	56	46	37.10	--
	1.959	37.08	--	1.49	56	46	38.57	--
	2.581	40.26	--	1.79	56	46	42.05	--
	3.364	40.95	--	1.88	56	46	42.83	--
	5.594	36.34	--	2.00	60	50	38.34	--
	12.188	43.87	--	1.97	60	50	45.84	--

- Notes :**
1. L1: One end & Ground L2: The other end & Ground
 2. Height of table on which the EUT was placed : 0.8 m.
 3. The Quasi-Peak Value have already met the Average Value Limit showed on above limits.
 4. The above test results are obtained under the normal condition.
 5. Amplitude = Read + Factor

2.5.2 Conducted Emissions

The following table shows a summary of the highest emissions of power line conducted emissions to the HOT and NEUTRAL conductor of the EUT power.

Test Mode : 802.11b (CH06)

Conducted Emissions								
Conductor	Frequency (MHz)	Read(dBuV)		Factor	Limits (dBuV)		Amplitude (dBuV)	
		QP	AV		QP	AV	QP	AV
L1	0.177	44.87	--	1.12	64.64	54.64	45.99	--
	1.249	35.90	--	1.36	56	46	37.26	--
	1.662	38.28	--	1.44	56	46	39.72	--
	2.077	40.73	--	1.73	56	46	42.46	--
	2.527	39.59	--	1.85	56	46	41.44	--
	3.364	39.38	--	1.97	56	46	41.35	--
	14.288	40.74	--	2.10	60	50	42.84	--
L2	0.177	43.38	--	1.07	64.64	54.64	44.45	--
	1.426	35.77	--	1.32	56	46	37.09	--
	2.033	38.54	--	1.71	56	46	40.25	--
	2.750	40.09	--	1.83	56	46	41.92	--
	3.364	40.65	--	1.88	56	46	42.53	--
	6.557	41.40	--	1.97	60	50	43.37	--
	13.127	42.81	--	2.02	60	50	44.83	--

Notes : 1. L1: One end & Ground L2: The other end & Ground

2. Height of table on which the EUT was placed : 0.8 m.

3. The Quasi-Peak Value have already met the Average Value Limit showed on above limits.

4. The above test results are obtained under the normal condition.

5. Amplitude = Read + Factor

2.5.3 Conducted Emissions

The following table shows a summary of the highest emissions of power line conducted emissions to the HOT and NEUTRAL conductor of the EUT power.

Test Mode : 802.11b (CH11)

Conducted Emissions								
Conductor	Frequency (MHz)	Read(dBuV)		Factor	Limits (dBuV)		Amplitude (dBuV)	
		QP	AV		QP	AV	QP	AV
L1	0.177	44.68	--	1.12	64.64	54.64	45.80	--
	1.106	37.81	--	1.30	56	46	39.11	--
	2.346	40.14	--	1.82	56	46	41.96	--
	3.041	39.19	--	1.91	56	46	41.10	--
	3.642	39.01	--	2.00	56	46	41.01	--
	6.386	42.41	--	2.02	60	50	44.43	--
	14.288	43.44	--	2.10	60	50	45.54	--
L2	1.065	35.04	--	1.23	56	46	36.27	--
	1.324	35.88	--	1.30	56	46	37.18	--
	2.225	39.32	--	1.73	56	46	41.05	--
	2.869	40.22	--	1.86	56	46	42.08	--
	3.241	40.07	--	1.85	56	46	41.92	--
	7.977	38.50	--	1.95	60	50	40.45	--
	14.288	42.17	--	2.06	60	50	44.23	--

Notes : 1. L1: One end & Ground L2: The other end & Ground

2. Height of table on which the EUT was placed : 0.8 m.

3. The Quasi-Peak Value have already met the Average Value Limit showed on above limits.

4. The above test results are obtained under the normal condition.

5. Amplitude = Read + Factor

2.5.4 Conducted Emissions

The following table shows a summary of the highest emissions of power line conducted emissions to the HOT and NEUTRAL conductor of the EUT power.

Test Mode : 802.11g (CH01)

Conducted Emissions								
Conductor	Frequency (MHz)	Read(dBuV)		Factor	Limits (dBuV)		Amplitude (dBuV)	
		QP	AV		QP	AV	QP	AV
L1	0.177	44.84	--	1.12	64.64	54.64	45.96	--
	1.184	37.69	--	1.35	56	46	39.04	--
	2.461	39.55	--	1.83	56	46	41.38	--
	3.173	39.67	--	1.93	56	46	41.60	--
	6.557	41.66	--	2.01	60	50	43.67	--
	12.784	43.58	--	2.04	60	50	45.62	--
	21.715	43.10	--	2.21	60	50	45.31	--
L2	2.033	37.05	--	1.71	56	46	38.76	--
	2.527	38.20	--	1.78	56	46	39.98	--
	3.399	38.98	--	1.89	56	46	40.87	--
	6.488	41.59	--	1.95	60	50	43.54	--
	9.401	38.14	--	1.95	60	50	40.09	--
	14.288	41.29	--	2.06	60	50	43.35	--
	23.263	42.13	--	2.23	60	50	44.36	--

Notes : 1. L1: One end & Ground L2: The other end & Ground

2. Height of table on which the EUT was placed : 0.8 m.

3. The Quasi-Peak Value have already met the Average Value Limit showed on above limits.

4. The above test results are obtained under the normal condition.

5. Amplitude = Read + Factor

2.5.5 Conducted Emissions

The following table shows a summary of the highest emissions of power line conducted emissions to the HOT and NEUTRAL conductor of the EUT power.

Test Mode : 802.11g (CH06)

Conducted Emissions								
Conductor	Frequency (MHz)	Read(dBuV)		Factor	Limits (dBuV)		Amplitude (dBuV)	
		QP	AV		QP	AV	QP	AV
L1	1.338	39.02	--	1.32	56	46	40.34	--
	1.772	38.90	--	1.46	56	46	40.36	--
	3.173	40.06	--	1.93	56	46	41.99	--
	3.700	39.42	--	2.00	56	46	41.42	--
	6.769	41.66	--	2.04	60	50	43.70	--
	14.288	42.11	--	2.10	60	50	44.21	--
	26.699	43.23	--	2.27	60	50	45.50	--
L2	1.426	34.21	--	1.32	56	46	35.53	--
	2.225	39.92	--	1.73	56	46	41.65	--
	2.809	41.00	--	1.84	56	46	42.84	--
	3.364	40.72	--	1.88	56	46	42.60	--
	6.733	42.83	--	1.97	60	50	44.80	--
	12.784	42.81	--	1.99	60	50	44.80	--
	23.263	42.76	--	2.23	60	50	44.99	--

Notes : 1. L1: One end & Ground L2: The other end & Ground

2. Height of table on which the EUT was placed : 0.8 m.

3. The Quasi-Peak Value have already met the Average Value Limit showed on above limits.

4. The above test results are obtained under the normal condition.

5. Amplitude = Read + Factor

2.5.6 Conducted Emissions

The following table shows a summary of the highest emissions of power line conducted emissions to the HOT and NEUTRAL conductor of the EUT power.

Test Mode : 802.11g (CH11)

Conducted Emissions								
Conductor	Frequency (MHz)	Read(dBuV)		Factor	Limits (dBuV)		Amplitude (dBuV)	
		QP	AV		QP	AV	QP	AV
L1	0.476	36.19	--	1.22	56.41	46.41	37.41	--
	1.544	37.92	--	1.44	56	46	39.36	--
	2.435	39.86	--	1.83	56	46	41.69	--
	3.041	39.77	--	1.91	56	46	41.68	--
	3.584	38.75	--	2.00	56	46	40.75	--
	6.557	44.15	--	2.01	60	50	46.16	--
	14.213	42.79	--	2.10	60	50	44.89	--
L2	1.781	36.91	--	1.44	56	46	38.35	--
	2.155	37.39	--	1.74	56	46	39.13	--
	2.435	37.82	--	1.75	56	46	39.57	--
	3.276	40.86	--	1.85	56	46	42.71	--
	6.769	41.94	--	1.97	60	50	43.91	--
	12.188	43.94	--	1.97	60	50	45.91	--
	26.558	43.80	--	2.25	60	50	46.05	--

Notes : 1. L1: One end & Ground L2: The other end & Ground

2. Height of table on which the EUT was placed : 0.8 m.

3. The Quasi-Peak Value have already met the Average Value Limit showed on above limits.

4. The above test results are obtained under the normal condition.

5. Amplitude = Read + Factor

2.5.7 Conducted Emissions

The following table shows a summary of the highest emissions of power line conducted emissions to the HOT and NEUTRAL conductor of the EUT power.

Test Mode : 802.11n HT20 (CH01)

Conducted Emissions								
Conductor	Frequency (MHz)	Read(dBuV)		Factor	Limits (dBuV)		Amplitude (dBuV)	
		QP	AV		QP	AV	QP	AV
L1	1.249	39.00	--	1.36	56	46	40.36	--
	1.839	38.77	--	1.51	56	46	40.28	--
	2.622	41.21	--	1.86	56	46	43.07	--
	3.700	41.01	--	2.00	56	46	43.01	--
	6.662	42.82	--	2.04	60	50	44.86	--
	13.479	43.18	--	2.05	60	50	45.23	--
	23.263	43.93	--	2.22	60	50	46.15	--
L2	1.898	37.20	--	1.49	56	46	38.69	--
	2.750	40.85	--	1.83	56	46	42.68	--
	3.090	41.28	--	1.86	56	46	43.14	--
	3.642	41.50	--	1.90	56	46	43.40	--
	6.488	43.33	--	1.95	60	50	45.28	--
	13.479	43.27	--	2.06	60	50	45.33	--
	23.263	45.16	--	2.23	60	50	47.39	--

Notes : 1. L1: One end & Ground L2: The other end & Ground

2. Height of table on which the EUT was placed : 0.8 m.

3. The Quasi-Peak Value have already met the Average Value Limit showed on above limits.

4. The above test results are obtained under the normal condition.

5. Amplitude = Read + Factor

2.5.8 Conducted Emissions

The following table shows a summary of the highest emissions of power line conducted emissions to the HOT and NEUTRAL conductor of the EUT power.

Test Mode : 802.11n HT20 (CH06)

Conducted Emissions								
Conductor	Frequency (MHz)	Read(dBuV)		Factor	Limits (dBuV)		Amplitude (dBuV)	
		QP	AV		QP	AV	QP	AV
L1	1.005	39.74	--	1.30	56	46	41.04	--
	2.077	41.08	--	1.73	56	46	42.81	--
	2.678	39.66	--	1.90	56	46	41.56	--
	3.642	40.54	--	2.00	56	46	42.54	--
	6.557	42.68	--	2.01	60	50	44.69	--
	12.188	42.58	--	2.00	60	50	44.58	--
	18.328	42.61	--	2.14	60	50	44.75	--
L2	0.471	34.62	--	1.14	56.49	46.49	35.76	--
	1.772	37.27	--	1.44	56	46	38.71	--
	2.435	40.05	--	1.75	56	46	41.80	--
	3.156	42.33	--	1.84	56	46	44.17	--
	6.951	37.60	--	1.95	60	50	39.55	--
	14.288	42.09	--	2.06	60	50	44.15	--
	23.018	42.21	--	2.22	60	50	44.43	--

Notes : 1. L1: One end & Ground L2: The other end & Ground

2. Height of table on which the EUT was placed : 0.8 m.

3. The Quasi-Peak Value have already met the Average Value Limit showed on above limits.

4. The above test results are obtained under the normal condition.

5. Amplitude = Read + Factor

2.5.9 Conducted Emissions

The following table shows a summary of the highest emissions of power line conducted emissions to the HOT and NEUTRAL conductor of the EUT power.

Test Mode : 802.11n HT20 (CH11)

Conducted Emissions								
Conductor	Frequency (MHz)	Read(dBuV)		Factor	Limits (dBuV)		Amplitude (dBuV)	
		QP	AV		QP	AV	QP	AV
L1	1.005	38.67	--	1.30	56	46	39.97	--
	1.480	39.38	--	1.39	56	46	40.77	--
	2.012	40.56	--	1.51	56	46	42.07	--
	3.107	40.41	--	1.90	56	46	42.31	--
	3.528	40.52	--	1.99	56	46	42.51	--
	12.188	44.49	--	2.00	60	50	46.49	--
	14.288	42.81	--	2.10	60	50	44.91	--
L2	1.772	36.56	--	1.44	56	46	38.00	--
	2.500	41.09	--	1.77	56	46	42.86	--
	3.090	41.28	--	1.86	56	46	43.14	--
	3.642	41.06	--	1.90	56	46	42.96	--
	6.878	40.57	--	1.95	60	50	42.52	--
	13.408	44.48	--	2.04	60	50	46.52	--
	23.263	41.75	--	2.23	60	50	43.98	--

- Notes :**
1. L1: One end & Ground L2: The other end & Ground
 2. Height of table on which the EUT was placed : 0.8 m.
 3. The Quasi-Peak Value have already met the Average Value Limit showed on above limits.
 4. The above test results are obtained under the normal condition.
 5. Amplitude = Read + Factor

2.5.10 Conducted Emissions

The following table shows a summary of the highest emissions of power line conducted emissions to the HOT and NEUTRAL conductor of the EUT power.

Test Mode : 802.11n HT40 (CH03)

Conducted Emissions								
Conductor	Frequency (MHz)	Read(dBuV)		Factor	Limits (dBuV)		Amplitude (dBuV)	
		QP	AV		QP	AV	QP	AV
L1	0.739	37.21	--	1.25	56	46	38.46	--
	1.480	39.24	--	1.39	56	46	40.63	--
	2.346	39.45	--	1.82	56	46	41.27	--
	2.962	41.18	--	1.93	56	46	43.11	--
	3.681	39.38	--	2.00	56	46	41.38	--
	6.662	41.75	--	2.04	60	50	43.79	--
	14.440	43.03	--	2.10	60	50	45.13	--
L2	0.177	42.33	--	1.07	64.64	54.64	43.40	--
	1.210	36.04	--	1.28	56	46	37.32	--
	2.678	41.56	--	1.81	56	46	43.37	--
	3.642	42.31	--	1.90	56	46	44.21	--
	6.662	40.72	--	1.97	60	50	42.69	--
	13.623	42.72	--	2.06	60	50	44.78	--
	23.140	42.62	--	2.23	60	50	44.85	--

- Notes :**
1. L1: One end & Ground L2: The other end & Ground
 2. Height of table on which the EUT was placed : 0.8 m.
 3. The Quasi-Peak Value have already met the Average Value Limit showed on above limits.
 4. The above test results are obtained under the normal condition.
 5. Amplitude = Read + Factor

2.5.11 Conducted Emissions

The following table shows a summary of the highest emissions of power line conducted emissions to the HOT and NEUTRAL conductor of the EUT power.

Test Mode : 802.11n HT40 (CH06)

Conducted Emissions								
Conductor	Frequency (MHz)	Read(dBuV)		Factor	Limits (dBuV)		Amplitude (dBuV)	
		QP	AV		QP	AV	QP	AV
L1	1.010	37.49	--	1.30	56	46	38.79	--
	2.077	40.21	--	1.73	56	46	41.94	--
	2.622	39.74	--	1.86	56	46	41.60	--
	3.584	40.54	--	2.00	56	46	42.54	--
	7.329	41.70	--	2.01	60	50	43.71	--
	12.188	44.34	--	2.00	60	50	46.34	--
	23.263	46.44	--	2.22	60	50	48.66	--
L2	1.716	35.43	--	1.44	56	46	36.87	--
	2.273	38.90	--	1.72	56	46	40.62	--
	3.041	40.33	--	1.85	56	46	42.18	--
	3.528	39.49	--	1.89	56	46	41.38	--
	6.698	42.72	--	1.97	60	50	44.69	--
	14.288	44.62	--	2.06	60	50	46.68	--
	23.263	45.79	--	2.23	60	50	48.02	--

Notes : 1. L1: One end & Ground L2: The other end & Ground

2. Height of table on which the EUT was placed : 0.8 m.

3. The Quasi-Peak Value have already met the Average Value Limit showed on above limits.

4. The above test results are obtained under the normal condition.

5. Amplitude = Read + Factor

2.5.12 Conducted Emissions

The following table shows a summary of the highest emissions of power line conducted emissions to the HOT and NEUTRAL conductor of the EUT power.

Test Mode : 802.11n HT40 (CH09)

Conducted Emissions								
Conductor	Frequency (MHz)	Read(dBuV)		Factor	Limits (dBuV)		Amplitude (dBuV)	
		QP	AV		QP	AV	QP	AV
L1	1.184	39.26	--	1.35	56	46	40.61	--
	2.500	39.73	--	1.84	56	46	41.57	--
	3.328	39.82	--	1.97	56	46	41.79	--
	3.759	39.79	--	2.01	56	46	41.80	--
	7.137	42.65	--	2.01	60	50	44.66	--
	12.124	44.17	--	2.03	60	50	46.20	--
	28.908	42.08	--	2.34	60	50	44.42	--
L2	1.367	37.59	--	1.32	56	46	38.91	--
	2.678	41.31	--	1.81	56	46	43.12	--
	3.276	41.98	--	1.85	56	46	43.83	--
	3.700	41.40	--	1.93	56	46	43.33	--
	7.810	40.00	--	1.92	60	50	41.92	--
	12.188	43.40	--	1.97	60	50	45.37	--
	22.896	43.75	--	2.22	60	50	45.97	--

Notes : 1. L1: One end & Ground L2: The other end & Ground

2. Height of table on which the EUT was placed : 0.8 m.

3. The Quasi-Peak Value have already met the Average Value Limit showed on above limits.

4. The above test results are obtained under the normal condition.

5. Amplitude = Read + Factor

3. Radiated Emissions Requirement

3.1 General Configuration:

Prior to open-field testing, the EUT was placed in a shielded enclosure and scanned at a close distance to determine its emission characteristics. The physical arrangement of the EUT was varied (within the scope of arrangements likely to be encountered in actual use) to determine the effect on the unit's emanations in amplitude, directivity, and frequency. The exact system configuration which produced the highest emissions was noted so it could be reproduced later during the open-field tests. This was done to ensure that the final measurements would demonstrate the worst-case interference potential of the EUT.

Final radiation measurements were made on a three-meter, open-field test site. The EUT system was placed on a nonconductive turntable which was 0.8 meters height, top surface 1.0 x 1.5 meter. During the test, EUT was set to transmit continuously & measurements spectrum range from 30 MHz to 26.5 GHz is investigated.

For measurements above 1 GHz the resolution bandwidth is set to 1 MHz, then the video bandwidth is set to 1 MHz for peak measurements and 10 Hz for average measurements.

A nonconductive material surrounded the EUT to supporting the EUT for standing on three orthogonal planes. At each condition, the EUT was rotated 360 degrees, and the antenna was raised and lowered from one to four meters to find the maximum emission levels. Measurements were taken using both horizontal and vertical antenna polarization.

For testing above 1GHz, the emission level of the EUT in peak mode was 20dB lower than average limit (that means the emission level in peak mode also complies with the limit in average mode), then testing will be stopped and peak values of EUT will be reported, otherwise, the emissions will be measured in average mode again and reported.

Appropriate preamplifiers were used for improving sensitivity and precautions were taken to avoid overloading or desensitizing the spectrum analyzer. No post – detector video filters were used in the test.

The spectrum analyzer's 6 dB bandwidth was set to 1 MHz, and the analyzer was operated in the peak detection mode, for frequencies both below and up 1 GHz. The average levels were obtained by subtracting the duty cycle correction factor from the peak readings.

The following procedures were used to convert the emission levels measured in decibels referenced to 1 microvolt (dBuV) into field intensity in microvolts pre meter (uV/m).

The actual field intensity in decibels referenced to 1 microvolt in to field intensity in microvolts per meter (dBuV/m).

The actual field intensity in referenced to 1 microvolt per meter (dBuV/m) is determined by algebraically adding the measured reading in dBuV, the antenna factor (dB), and cable loss (dB) and Subtracting the gain of preamplifier (dB) is auto calculate in spectrum analyzer.

$$\text{Amplitude (dBuV/m)} = \text{FI(dBuV)} + \text{AF(dBm)} + \text{CL(dBuV)} - \text{Gain(dB)}$$

FI= Reading of the field intensity.

AF= Antenna factor.

CL= Cable loss.

P.S Amplitude is auto calculate in spectrum analyzer.

The FCC specified emission limits were calculated according the EUT operating frequency and by following linear interpolation equations:

(1) For fundamental frequency : Transmitter Output < +30dBm

(2) For spurious frequency : Spurious emission limits = fundamental emission limit /10

3.2 Test Equipment List:

Item	Mfr/Brand	Instruments	Serial No.	Model/Type No.	Calibrated Date	Next Cal. Date
1.	Agilent	Spectrum Analyzer	US39240419	E4407B	2013/01/29	2014/01/29
2.	MLT	Pre Amplifier	20110301	PREAMP6G-02	2013/03/01	2014/03/01
3.	Agilent	Spectrum Analyzer	US40240137	E7403A	2013/01/29	2014/01/29
4.	MLT	Pre Amplifier	0.10~19.1GHz 60dBm	RF01	2013/08/23	2014/08/23
5.	MLT	Pre Amplifier	TA010-190-30	RF03	2013/07/16	2014/07/16
6.	MLT	Pre Amplifier	20110209	PREAMP6G-01	2013/03/01	2014/03/01
7.	Herotek	Pre Amplifier	30690	A402-417	2012/11/02	2013/11/02
8.	EMCO	Biconilog Antenna	59739	3142C	2013/09/05	2014/09/05
9.	EMCO	Biconilog Antenna	44568	3142C	2013/09/05	2014/09/05
10.	SCHWARZBECK	Horn Antenna	181	BBHA 9170	2012/11/18	2013/11/18
11.	SCHWARZBECK	Horn Antenna	304	BBHA 9120D	2012/10/15	2013/10/15

3.3 Test condition:

EUT tested in accordance with the specifications given by the manufacturer, and exercised in the most unfavorable manner.

3.4 Radiated Emissions Limits:

Frequency range (MHz)	Peak(dBuV/m)
30 to 88	40
88 to 216	43.5
216 to 960	46
Above 960	54

3.5 Measurement Data Of Radiated Emissions:

3.5.1 Open Field Radiated Emissions (Subpart C)

The highest peak values of radiated emissions from the EUT at various antenna heights, antenna polarization, EUT orientation, etc. are recorded on the following

Test Mode : 802.11b (CH01)

Radiated Emissions (HORIZONTAL)									
Frequency (MHz)	Read (dBuV/m)		Factor	Amplitude (dBuV/m)		Limits (dBuV/m)		Margin (dB)	
	PK	AV		PK	AV	PK	AV	PK	AV
1200.0	47.35	45.97	-4.32	43.03	41.65	74.00	54.00	-30.97	-12.35
20072.5	38.50	30.89	17.08	55.58	47.97	74.00	54.00	-18.42	-6.03

Radiated Emissions (VERTICAL)									
Frequency (MHz)	Read (dBuV/m)		Factor	Amplitude (dBuV/m)		Limits (dBuV/m)		Margin (dB)	
	PK	AV		PK	AV	PK	AV	PK	AV
4815.0	74.06	73.52	-28.11	45.95	45.41	74.00	54.00	-28.05	-8.59
19675.0	37.60	29.57	17.75	55.35	47.32	74.00	54.00	-18.65	-6.68

- Notes :**
1. Margin= Amplitude – Limits
 2. Distance of Measurement : 3 Meter
 3. Height of table for EUT placed: 0.8 Meter.
 4. ANT= Antenna height.
 5. Duty= Duty cycle correction factor.
 6. Amplitude= Reading Amplitude – Amplifier gain + Cable loss + Antenna factor
(Auto calculate in spectrum analyzer)
 7. The other emission levels were very low against the limit.

3.5.2 Open Field Radiated Emissions (Subpart C)

The highest peak values of radiated emissions from the EUT at various antenna heights, antenna polarization, EUT orientation, etc. are recorded on the following

Test Mode : 802.11b (CH06)

Radiated Emissions (HORIZONTAL)									
Frequency (MHz)	Read (dBuV/m)		Factor	Amplitude (dBuV/m)		Limits (dBuV/m)		Margin (dB)	
	PK	AV		PK	AV	PK	AV	PK	AV
4875.0	69.85	69.72	-28.18	41.67	41.54	74.00	54.00	-32.33	-12.46
20095.0	38.35	30.86	16.95	55.30	47.81	74.00	54.00	-18.70	-6.19

Radiated Emissions (VERTICAL)									
Frequency (MHz)	Read (dBuV/m)		Factor	Amplitude (dBuV/m)		Limits (dBuV/m)		Margin (dB)	
	PK	AV		PK	AV	PK	AV	PK	AV
1502.0	49.12	44.55	-3.62	45.50	40.93	74.00	54.00	-28.50	-13.07
20012.5	38.81	29.91	17.04	55.85	46.95	74.00	54.00	-18.15	-7.05

- Notes :**
1. Margin= Amplitude – Limits
 2. Distance of Measurement : 3 Meter
 3. Height of table for EUT placed: 0.8 Meter.
 4. ANT= Antenna height.
 5. Duty= Duty cycle correction factor.
 6. Amplitude= Reading Amplitude – Amplifier gain + Cable loss + Antenna factor (Auto calculate in spectrum analyzer)
 7. The other emission levels were very low against the limit.

3.5.3 Open Field Radiated Emissions (Subpart C)

The highest peak values of radiated emissions from the EUT at various antenna heights, antenna polarization, EUT orientation, etc. are recorded on the following

Test Mode : 802.11b (CH11)

Radiated Emissions (HORIZONTAL)									
Frequency (MHz)	Read (dBuV/m)		Factor	Amplitude (dBuV/m)		Limits (dBuV/m)		Margin (dB)	
	PK	AV		PK	AV	PK	AV	PK	AV
4920.0	69.02	67.66	-28.04	40.98	39.62	74.00	54.00	-33.02	-14.38
19157.5	36.88	30.51	18.69	55.57	49.20	74.00	54.00	-18.43	-4.80

Radiated Emissions (VERTICAL)									
Frequency (MHz)	Read (dBuV/m)		Factor	Amplitude (dBuV/m)		Limits (dBuV/m)		Margin (dB)	
	PK	AV		PK	AV	PK	AV	PK	AV
1200.0	52.84	51.20	-4.32	48.52	46.88	74.00	54.00	-25.48	-7.12
19547.5	37.29	30.10	18.31	55.60	48.41	74.00	54.00	-18.40	-5.59

Notes : 1. Margin= Amplitude – Limits

2. Distance of Measurement : 3 Meter

3. Height of table for EUT placed: 0.8 Meter.

4. ANT= Antenna height.

5. Duty= Duty cycle correction factor.

6. Amplitude= Reading Amplitude – Amplifier gain + Cable loss + Antenna factor
(Auto calculate in spectrum analyzer)

7. The other emission levels were very low against the limit.

3.5.4 Open Field Radiated Emissions (Subpart C)

The highest peak values of radiated emissions from the EUT at various antenna heights, antenna polarization, EUT orientation, etc. are recorded on the following

Test Mode : 802.11g (CH01)

Radiated Emissions (HORIZONTAL)									
Frequency (MHz)	Read (dBuV/m)		Factor	Amplitude (dBuV/m)		Limits (dBuV/m)		Margin (dB)	
	PK	AV		PK	AV	PK	AV	PK	AV
1200.0	47.63	45.95	-4.32	43.31	41.63	74.00	54.00	-30.69	-12.37
20087.5	38.68	30.01	16.95	55.63	46.96	74.00	54.00	-18.37	-7.04

Radiated Emissions (VERTICAL)									
Frequency (MHz)	Read (dBuV/m)		Factor	Amplitude (dBuV/m)		Limits (dBuV/m)		Margin (dB)	
	PK	AV		PK	AV	PK	AV	PK	AV
1200.0	52.95	51.11	-4.32	48.63	46.79	74.00	54.00	-25.37	-7.21
19712.5	37.51	30.70	17.81	55.32	48.51	74.00	54.00	-18.68	-5.49

Notes : 1. Margin= Amplitude – Limits

2. Distance of Measurement : 3 Meter

3. Height of table for EUT placed: 0.8 Meter.

4. ANT= Antenna height.

5. Duty= Duty cycle correction factor.

6. Amplitude= Reading Amplitude – Amplifier gain + Cable loss + Antenna factor
(Auto calculate in spectrum analyzer)

7. The other emission levels were very low against the limit.

3.5.5 Open Field Radiated Emissions (Subpart C)

The highest peak values of radiated emissions from the EUT at various antenna heights, antenna polarization, EUT orientation, etc. are recorded on the following

Test Mode : 802.11g (CH06)

Radiated Emissions (HORIZONTAL)									
Frequency (MHz)	Read (dBuV/m)		Factor	Amplitude (dBuV/m)		Limits (dBuV/m)		Margin (dB)	
	PK	AV		PK	AV	PK	AV	PK	AV
4875.0	72.92	57.63	-28.18	44.74	29.45	74.00	54.00	-29.26	-24.55
20035.0	38.55	29.97	16.99	55.54	46.96	74.00	54.00	-18.46	-7.04

Radiated Emissions (VERTICAL)									
Frequency (MHz)	Read (dBuV/m)		Factor	Amplitude (dBuV/m)		Limits (dBuV/m)		Margin (dB)	
	PK	AV		PK	AV	PK	AV	PK	AV
1200.0	52.63	51.01	-4.32	48.31	46.69	74.00	54.00	-25.69	-7.31
19757.5	37.50	29.37	17.84	55.34	47.21	74.00	54.00	-18.66	-6.79

Notes : 1. Margin= Amplitude – Limits

2. Distance of Measurement : 3 Meter

3. Height of table for EUT placed: 0.8 Meter.

4. ANT= Antenna height.

5. Duty= Duty cycle correction factor.

6. Amplitude= Reading Amplitude – Amplifier gain + Cable loss + Antenna factor
(Auto calculate in spectrum analyzer)

7. The other emission levels were very low against the limit.

3.5.6 Open Field Radiated Emissions (Subpart C)

The highest peak values of radiated emissions from the EUT at various antenna heights, antenna polarization, EUT orientation, etc. are recorded on the following

Test Mode : 802.11g (CH11)

Radiated Emissions (HORIZONTAL)									
Frequency (MHz)	Read (dBuV/m)		Factor	Amplitude (dBuV/m)		Limits (dBuV/m)		Margin (dB)	
	PK	AV		PK	AV	PK	AV	PK	AV
1200.0	47.64	45.98	-4.32	43.32	41.66	74.00	54.00	-30.68	-12.34
19622.5	37.71	29.22	17.79	55.50	47.01	74.00	54.00	-18.50	-6.99

Radiated Emissions (VERTICAL)									
Frequency (MHz)	Read (dBuV/m)		Factor	Amplitude (dBuV/m)		Limits (dBuV/m)		Margin (dB)	
	PK	AV		PK	AV	PK	AV	PK	AV
1502.0	48.12	44.28	-3.62	44.50	40.66	74.00	54.00	-29.50	-13.34
19045.0	36.82	29.46	18.72	55.54	48.18	74.00	54.00	-18.46	-5.82

- Notes :**
1. Margin= Amplitude – Limits
 2. Distance of Measurement : 3 Meter
 3. Height of table for EUT placed: 0.8 Meter.
 4. ANT= Antenna height.
 5. Duty= Duty cycle correction factor.
 6. Amplitude= Reading Amplitude – Amplifier gain + Cable loss + Antenna factor (Auto calculate in spectrum analyzer)
 7. The other emission levels were very low against the limit.

3.5.7 Open Field Radiated Emissions (Subpart C)

The highest peak values of radiated emissions from the EUT at various antenna heights, antenna polarization, EUT orientation, etc. are recorded on the following

Test Mode : 802.11n HT20 (CH01)

Radiated Emissions (HORIZONTAL)									
Frequency (MHz)	Read (dBuV/m)		Factor	Amplitude (dBuV/m)		Limits (dBuV/m)		Margin (dB)	
	PK	AV		PK	AV	PK	AV	PK	AV
1200.0	47.49	46.19	-4.32	43.17	41.87	74.00	54.00	-30.83	-12.13
19960.0	38.62	29.94	17.24	55.86	47.18	74.00	54.00	-18.14	-6.82

Radiated Emissions (VERTICAL)									
Frequency (MHz)	Read (dBuV/m)		Factor	Amplitude (dBuV/m)		Limits (dBuV/m)		Margin (dB)	
	PK	AV		PK	AV	PK	AV	PK	AV
1502.0	49.21	44.71	-3.62	45.59	41.09	74.00	54.00	-28.41	-12.91
19907.5	38.15	29.97	17.35	55.50	47.32	74.00	54.00	-18.50	-6.68

Notes : 1. Margin= Amplitude – Limits

2. Distance of Measurement : 3 Meter

3. Height of table for EUT placed: 0.8 Meter.

4. ANT= Antenna height.

5. Duty= Duty cycle correction factor.

6. Amplitude= Reading Amplitude – Amplifier gain + Cable loss + Antenna factor
(Auto calculate in spectrum analyzer)

7. The other emission levels were very low against the limit.

3.5.8 Open Field Radiated Emissions (Subpart C)

The highest peak values of radiated emissions from the EUT at various antenna heights, antenna polarization, EUT orientation, etc. are recorded on the following

Test Mode : 802.11n HT20 (CH06)

Radiated Emissions (HORIZONTAL)									
Frequency (MHz)	Read (dBuV/m)		Factor	Amplitude (dBuV/m)		Limits (dBuV/m)		Margin (dB)	
	PK	AV		PK	AV	PK	AV	PK	AV
1200.0	47.10	46.14	-4.32	42.78	41.82	74.00	54.00	-31.22	-12.18
19862.5	38.03	29.77	17.64	55.67	47.41	74.00	54.00	-18.33	-6.59

Radiated Emissions (VERTICAL)									
Frequency (MHz)	Read (dBuV/m)		Factor	Amplitude (dBuV/m)		Limits (dBuV/m)		Margin (dB)	
	PK	AV		PK	AV	PK	AV	PK	AV
4875.0	64.36	58.24	-28.18	36.18	30.06	74.00	54.00	-37.82	-23.94
19937.5	38.03	29.92	17.26	55.29	47.18	74.00	54.00	-18.71	-6.82

Notes : 1. Margin= Amplitude – Limits

2. Distance of Measurement : 3 Meter

3. Height of table for EUT placed: 0.8 Meter.

4. ANT= Antenna height.

5. Duty= Duty cycle correction factor.

6. Amplitude= Reading Amplitude – Amplifier gain + Cable loss + Antenna factor
(Auto calculate in spectrum analyzer)

7. The other emission levels were very low against the limit.

3.5.9 Open Field Radiated Emissions (Subpart C)

The highest peak values of radiated emissions from the EUT at various antenna heights, antenna polarization, EUT orientation, etc. are recorded on the following

Test Mode : 802.11n HT20 (CH11)

Radiated Emissions (HORIZONTAL)									
Frequency (MHz)	Read (dBuV/m)		Factor	Amplitude (dBuV/m)		Limits (dBuV/m)		Margin (dB)	
	PK	AV		PK	AV	PK	AV	PK	AV
1200.0	47.77	46.20	-4.32	43.45	41.88	74.00	54.00	-30.55	-12.12
19037.5	37.17	29.37	18.68	55.85	48.05	74.00	54.00	-18.15	-5.95

Radiated Emissions (VERTICAL)									
Frequency (MHz)	Read (dBuV/m)		Factor	Amplitude (dBuV/m)		Limits (dBuV/m)		Margin (dB)	
	PK	AV		PK	AV	PK	AV	PK	AV
1200.0	51.98	50.90	-4.32	47.66	46.58	74.00	54.00	-26.34	-7.42
19037.5	37.19	29.38	18.68	55.87	48.06	74.00	54.00	-18.13	-5.94

Notes : 1. Margin= Amplitude – Limits

2. Distance of Measurement : 3 Meter

3. Height of table for EUT placed: 0.8 Meter.

4. ANT= Antenna height.

5. Duty= Duty cycle correction factor.

6. Amplitude= Reading Amplitude – Amplifier gain + Cable loss + Antenna factor
(Auto calculate in spectrum analyzer)

7. The other emission levels were very low against the limit.

3.5.10 Open Field Radiated Emissions (Subpart C)

The highest peak values of radiated emissions from the EUT at various antenna heights, antenna polarization, EUT orientation, etc. are recorded on the following

Test Mode : 802.11n HT40 (CH03)

Radiated Emissions (HORIZONTAL)									
Frequency (MHz)	Read (dBuV/m)		Factor	Amplitude (dBuV/m)		Limits (dBuV/m)		Margin (dB)	
	PK	AV		PK	AV	PK	AV	PK	AV
1652.0	44.37	39.92	-3.82	40.55	36.10	74.00	54.00	-33.45	-17.90
19712.5	37.75	29.64	17.81	55.56	47.45	74.00	54.00	-18.44	-6.55

Radiated Emissions (VERTICAL)									
Frequency (MHz)	Read (dBuV/m)		Factor	Amplitude (dBuV/m)		Limits (dBuV/m)		Margin (dB)	
	PK	AV		PK	AV	PK	AV	PK	AV
1200.0	52.28	50.74	-4.32	47.96	46.42	74.00	54.00	-26.04	-7.58
19750.0	37.68	29.51	17.79	55.47	47.30	74.00	54.00	-18.53	-6.70

Notes : 1. Margin= Amplitude – Limits

2. Distance of Measurement : 3 Meter

3. Height of table for EUT placed: 0.8 Meter.

4. ANT= Antenna height.

5. Duty= Duty cycle correction factor.

6. Amplitude= Reading Amplitude – Amplifier gain + Cable loss + Antenna factor
(Auto calculate in spectrum analyzer)

7. The other emission levels were very low against the limit.

3.5.11 Open Field Radiated Emissions (Subpart C)

The highest peak values of radiated emissions from the EUT at various antenna heights, antenna polarization, EUT orientation, etc. are recorded on the following

Test Mode : 802.11n HT40 (CH06)

Radiated Emissions (HORIZONTAL)									
Frequency (MHz)	Read (dBuV/m)		Factor	Amplitude (dBuV/m)		Limits (dBuV/m)		Margin (dB)	
	PK	AV		PK	AV	PK	AV	PK	AV
1200.0	47.61	46.28	-4.32	43.29	41.96	74.00	54.00	-30.71	-12.04
19570.0	37.62	29.19	18.33	55.95	47.52	74.00	54.00	-18.05	-6.48

Radiated Emissions (VERTICAL)									
Frequency (MHz)	Read (dBuV/m)		Factor	Amplitude (dBuV/m)		Limits (dBuV/m)		Margin (dB)	
	PK	AV		PK	AV	PK	AV	PK	AV
1200.0	52.34	50.79	-4.32	48.02	46.47	74.00	54.00	-25.98	-7.53
19735.0	38.13	29.86	17.93	56.06	47.79	74.00	54.00	-17.94	-6.21

Notes : 1. Margin= Amplitude – Limits

2. Distance of Measurement : 3 Meter

3. Height of table for EUT placed: 0.8 Meter.

4. ANT= Antenna height.

5. Duty= Duty cycle correction factor.

6. Amplitude= Reading Amplitude – Amplifier gain + Cable loss + Antenna factor
(Auto calculate in spectrum analyzer)

7. The other emission levels were very low against the limit.

3.5.12 Open Field Radiated Emissions (Subpart C)

The highest peak values of radiated emissions from the EUT at various antenna heights, antenna polarization, EUT orientation, etc. are recorded on the following

Test Mode : 802.11n HT40 (CH09)

Radiated Emissions (HORIZONTAL)									
Frequency (MHz)	Read (dBuV/m)		Factor	Amplitude (dBuV/m)		Limits (dBuV/m)		Margin (dB)	
	PK	AV		PK	AV	PK	AV	PK	AV
1652.0	43.90	39.79	-3.82	40.08	35.97	74.00	54.00	-33.92	-18.03
19750.0	37.97	29.51	17.79	55.76	47.30	74.00	54.00	-18.24	-6.70

Radiated Emissions (VERTICAL)									
Frequency (MHz)	Read (dBuV/m)		Factor	Amplitude (dBuV/m)		Limits (dBuV/m)		Margin (dB)	
	PK	AV		PK	AV	PK	AV	PK	AV
1200.0	52.12	50.58	-4.32	47.80	46.26	74.00	54.00	-26.20	-7.74
19945.0	38.54	29.91	17.26	55.80	47.17	74.00	54.00	-18.20	-6.83

Notes : 1. Margin= Amplitude – Limits

2. Distance of Measurement : 3 Meter

3. Height of table for EUT placed: 0.8 Meter.

4. ANT= Antenna height.

5. Duty= Duty cycle correction factor.

6. Amplitude= Reading Amplitude – Amplifier gain + Cable loss + Antenna factor
(Auto calculate in spectrum analyzer)

7. The other emission levels were very low against the limit.

4. Maximum Conducted Output Power Requirements

4.1 Test Condition & Setup :

The tests below are run with the EUT's transmitter set at high power in TDD mode. A RJ-45 port from a computer to the EUT is needed to force selection of output power level and channel number. While testing, EUT was set to transmit continuously. Remove the Subjective device's antenna and connect the RF output port to spectrum analyzer. The maximum peak output power shall not exceed 1 watt.

The antenna port of the EUT was connected to the input of a power meter. Power was read directly and cable loss correction was added to the reading to obtain power at the EUT antenna terminals.

For antennas with gains of 6 dBi or less, maximum allowed transmitter output is 1 watt (+30 dBm). For antennas with gains greater than 6 dBi, transmitter output level must be decreased by an amount equal to $(\text{GAIN} - 6)/3$ dBm.

Measurement procedure is followed KDB 558074 v03r01 (9.1.2 : Integrated band power method)

KDB 662911 D01 Multiple Transmitter Output v02 Method of conducted output power for

E) Guidance for summing emission measurements from multiple outputs of a transmitter or from multiple transmitters.

4.2 Test Instruments Configuration:

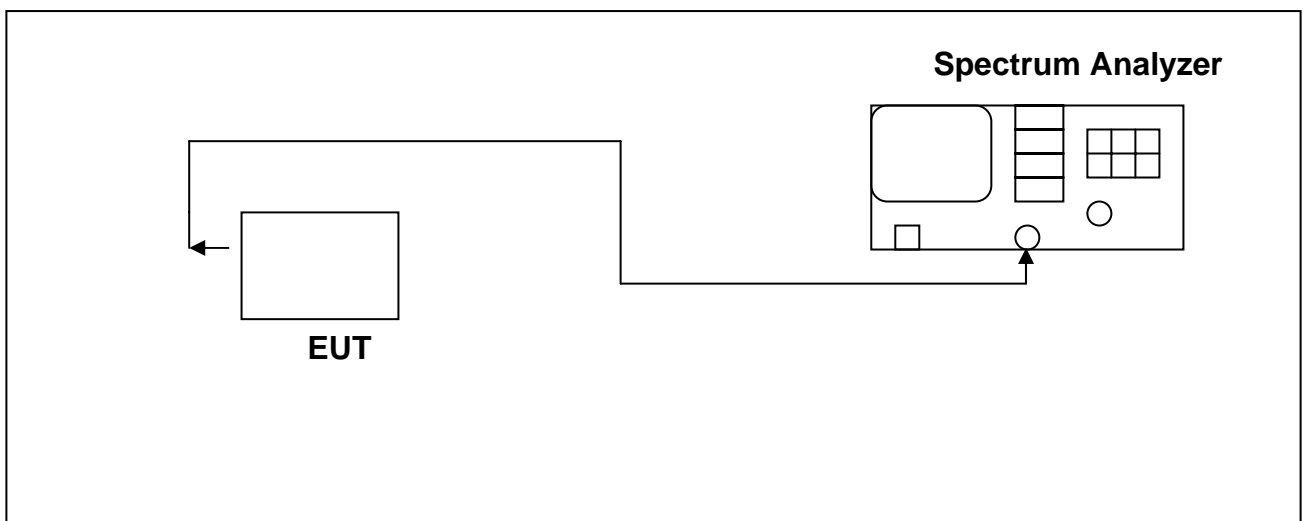

4.3 Test Equipment List:

Item	Mfr/Brand	Instruments	Serial No.	Model/Type No.	Calibrated Date	Next Cal. Date
1.	Agilent	Spectrum Analyzer	US39240419	E4407B	2013/01/29	2014/01/29

4.4 Test Result:

802.11b

Frequency (MHz)	Data Rate(Mbps)	Output(dBm)	Required Limit
2412	11	20.58	<30dBm
2412	5.5	18.25	<30dBm
2412	2	18.19	<30dBm
2412	1	18.35	<30dBm

Frequency (MHz)	Data Rate(Mbps)	Output(dBm)	Required Limit
2412	11	20.58	<30dBm
2437	11	20.78	<30dBm
2462	11	21.12	<30dBm

802.11g

Frequency (MHz)	Data Rate(Mbps)	Output(dBm)	Required Limit
2412	54	18.38	<30dBm
2412	48	18.37	<30dBm
2412	36	18.42	<30dBm
2412	24	18.42	<30dBm
2412	18	18.01	<30dBm
2412	12	18.05	<30dBm
2412	9	18.47	<30dBm
2412	6	18.43	<30dBm

Frequency (MHz)	Data Rate(Mbps)	Output(dBm)	Required Limit
2412	9	18.47	<30dBm
2437	24	18.61	<30dBm
2462	24	19.00	<30dBm

802.11n HT20

Frequency (MHz)	Data Rate(Mbps)		Output Power(dBm)		Required Limit
	Ant 1	Ant 2	Ant 1	Ant 2	
2412	130	130	16.73	16.55	<30dBm
2412	117	117	16.75	16.57	<30dBm
2412	104	104	16.73	16.70	<30dBm
2412	78	78	16.73	16.72	<30dBm
2412	52	52	16.87	16.92	<30dBm
2412	39	39	16.39	16.88	<30dBm
2412	26	26	16.47	16.82	<30dBm
2412	13	13	16.72	17.63	<30dBm

Frequency (MHz)	Data Rate(Mbps)		Output Power(dBm)		Total Output Power(dBm)	Required Limit
	Ant 1	Ant 2	Ant 1	Ant 2		
2412	52	13	16.87	17.63	20.28	<30dBm
2437	13	13	16.87	18.26	20.63	<30dBm
2462	52	52	17.10	18.26	20.73	<30dBm

802.11n HT40

Frequency (MHz)	Data Rate(Mbps)		Output Power(dBm)		Required Limit
	Ant 1	Ant 2	Ant 1	Ant 2	
2422	270	270	16.58	17.00	<30dBm
2422	243	243	16.58	17.53	<30dBm
2422	216	216	16.65	17.12	<30dBm
2422	162	162	16.64	17.20	<30dBm
2422	108	108	16.93	18.08	<30dBm
2422	81	81	16.72	17.09	<30dBm
2422	54	54	16.68	17.72	<30dBm
2422	27	27	17.11	18.29	<30dBm

Frequency (MHz)	Data Rate(Mbps)		Output Power(dBm)		Total Output Power(dBm)	Required Limit
	Ant 1	Ant 2	Ant 1	Ant 2		
2422	27	27	17.11	18.29	20.75	<30dBm
2437	27	27	17.15	18.68	23.60	<30dBm
2452	27	27	17.48	18.81	21.21	<30dBm

802.11b (2412MHz)

Agilent 11:53:56 Sep 2, 2013

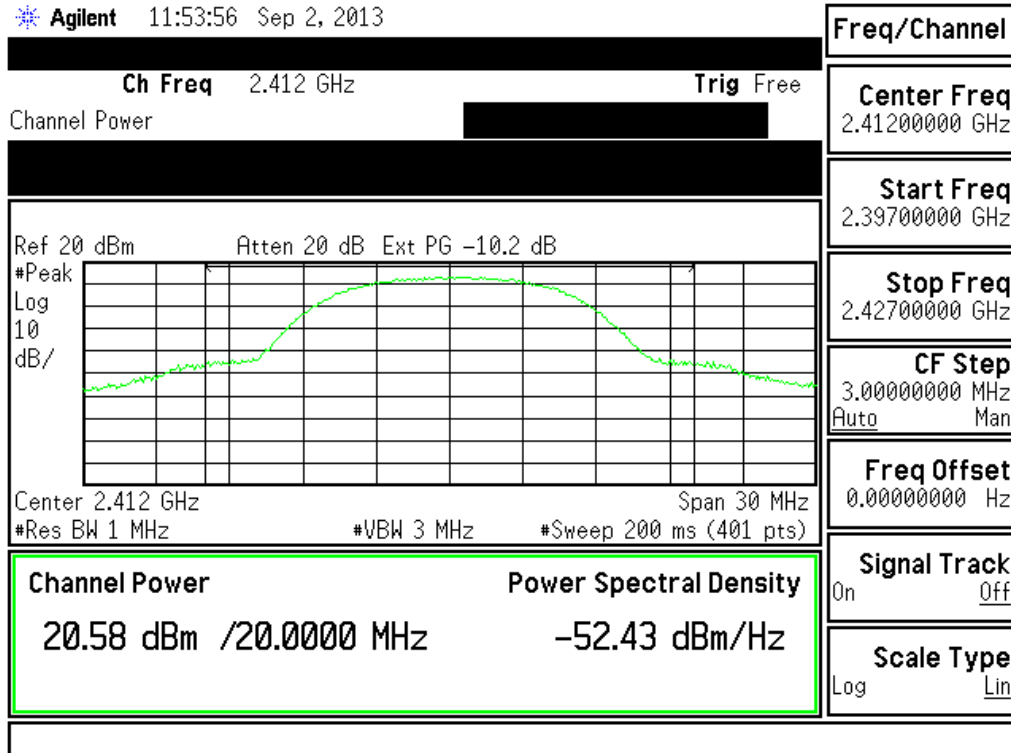

Note: Ext PG = Attenuator + Cable loss.

802.11b (2437MHz)

Agilent 11:55:40 Sep 2, 2013

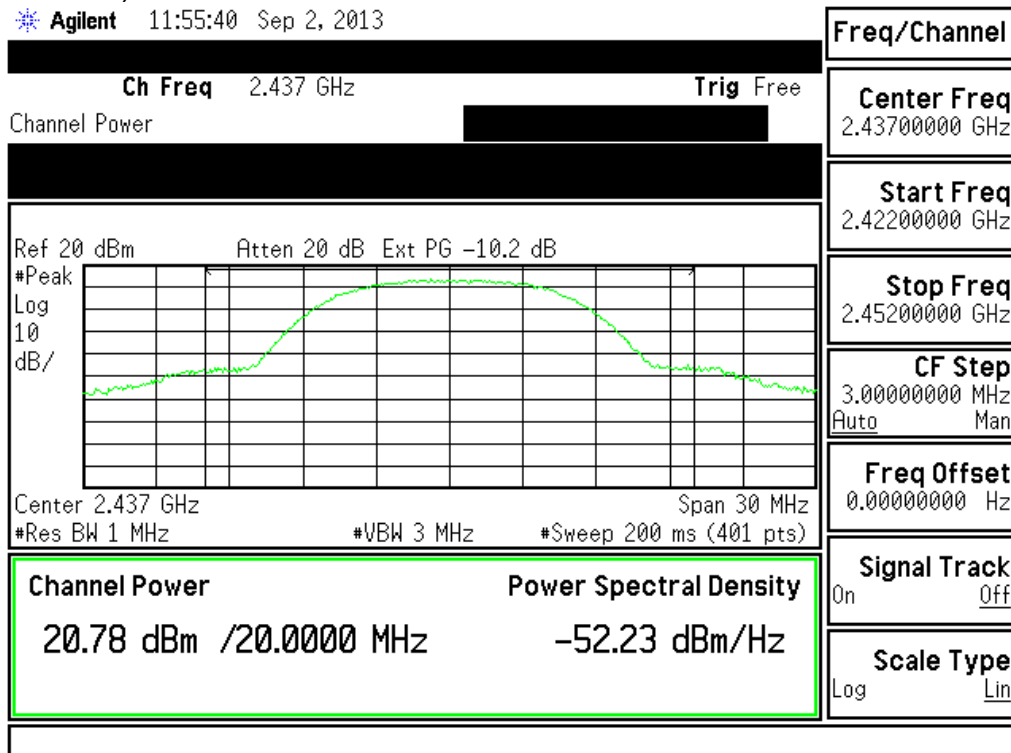

802.11b (2462MHz)

Agilent 11:57:41 Sep 2, 2013

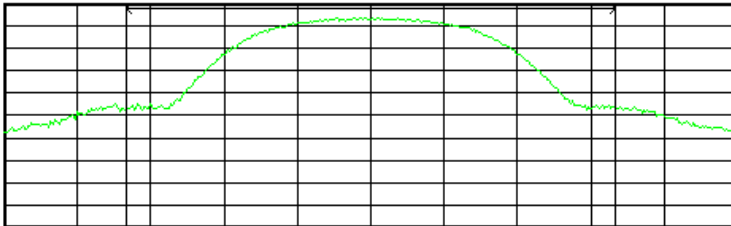
Ch Freq 2.462 GHz		Trig Free	Freq/Channel
Channel Power			Center Freq 2.46200000 GHz
Ref 20 dBm Atten 20 dB Ext PG -10.2 dB			Start Freq 2.44700000 GHz
			Stop Freq 2.47700000 GHz
Center 2.462 GHz Span 30 MHz			CF Step 3.00000000 MHz Auto Man
#Res BW 1 MHz #VBW 3 MHz #Sweep 200 ms (401 pts)			Freq Offset 0.00000000 Hz
Channel Power	Power Spectral Density		Signal Track On Off
21.12 dBm /20.0000 MHz	-51.89 dBm/Hz		Scale Type Log Lin

802.11g (2412MHz)

Agilent 09:39:22 Sep 2, 2013

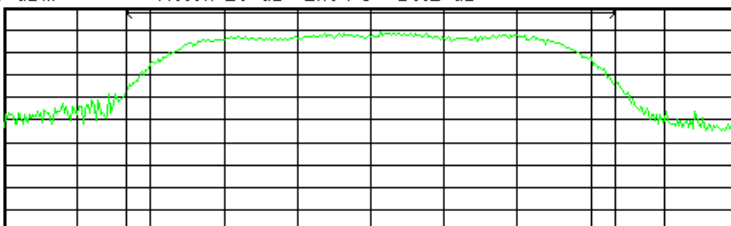
Ch Freq 2.412 GHz		Trig Free	Sweep
Channel Power			Sweep Time 200.0 ms Auto Man
Ref 20 dBm Atten 20 dB Ext PG -10.2 dB			Sweep Single Cont
			Auto Sweep Coupling SR SA
Center 2.412 GHz Span 30 MHz			Gate [Off]
#Res BW 1 MHz #VBW 3 MHz #Sweep 200 ms (401 pts)			Points 401
Channel Power	Power Spectral Density		Segmented
18.47 dBm /20.0000 MHz	-54.54 dBm/Hz		

802.11g (2437MHz)

Agilent 09:46:29 Sep 2, 2013

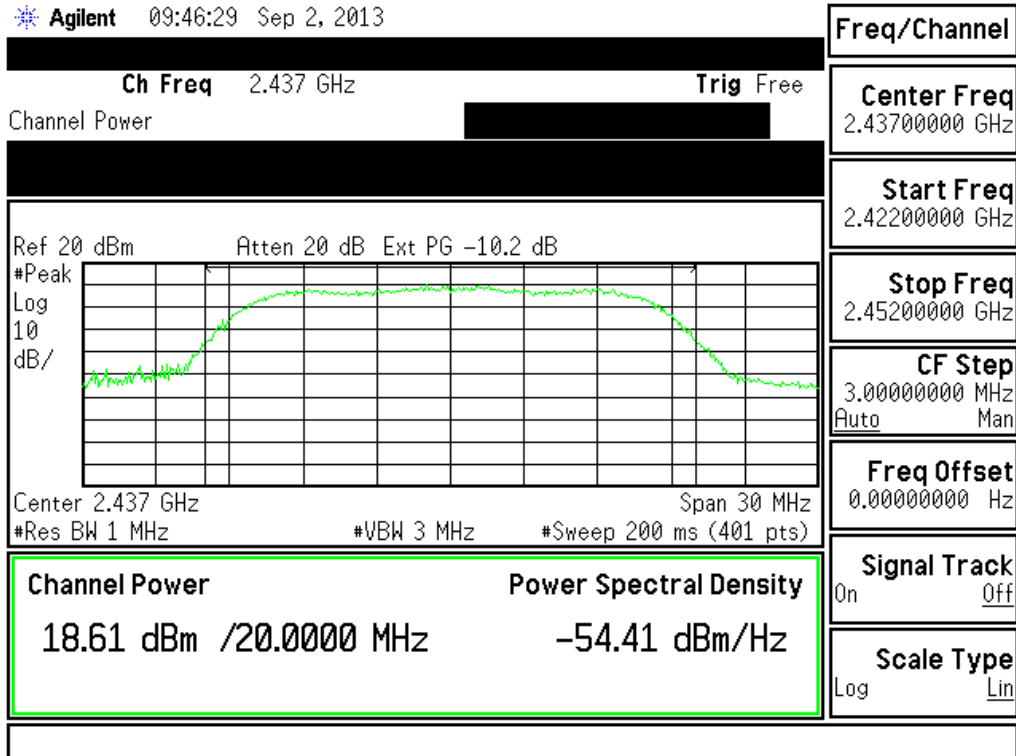

802.11g (2462MHz)

Agilent 09:52:26 Sep 2, 2013

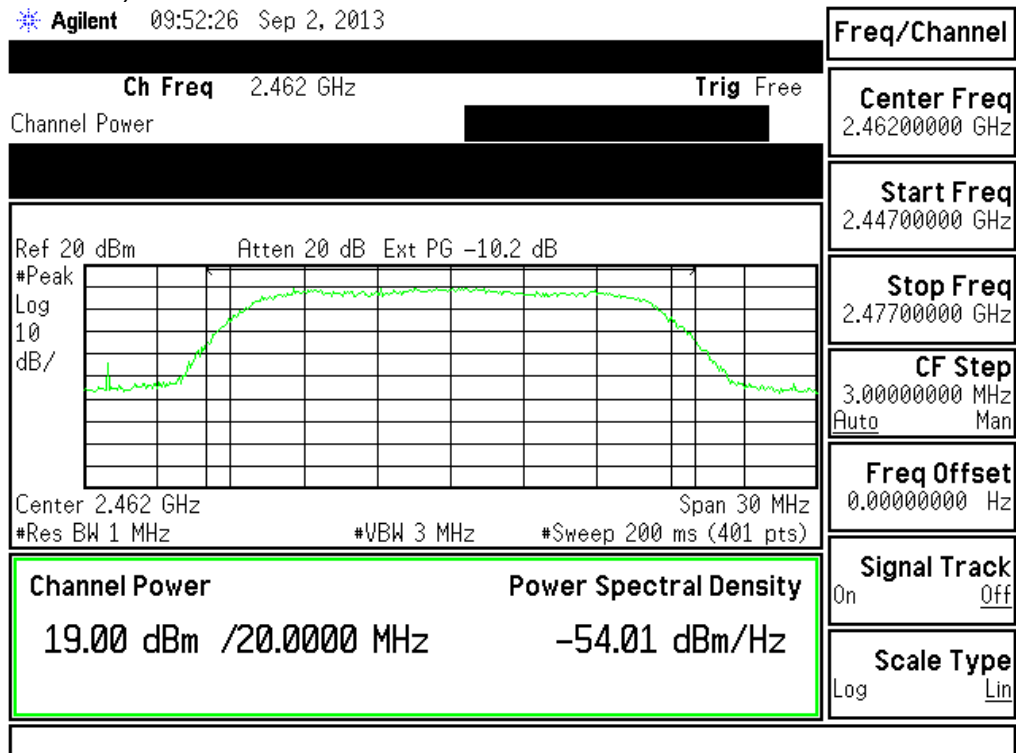

802.11HT20 ANT1 (2412MHz)

Agilent 10:03:04 Sep 2, 2013

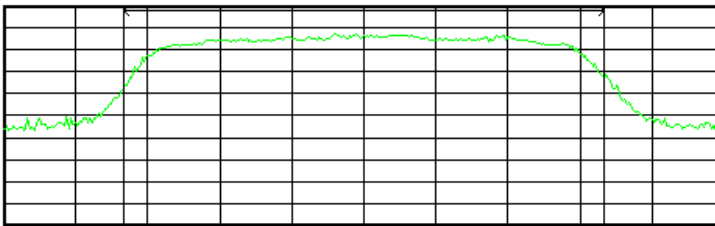
Ch Freq 2.412 GHz		Trig Free	Trace/View
Channel Power			Trace 1 2 3
Ref 20 dBm Atten 20 dB Ext PG -10.2 dB #Peak Log 10 dB/			Clear Write
			Max Hold
Center 2.412 GHz Span 30 MHz #Res BW 1 MHz #VBW 3 MHz #Sweep 200 ms (401 pts)			Min Hold
Channel Power Power Spectral Density 16.87 dBm /20.0000 MHz -56.14 dBm/Hz			View
			Blank
			More 1 of 2

802.11HT20 ANT1 (2437MHz)

Agilent 10:07:03 Sep 2, 2013

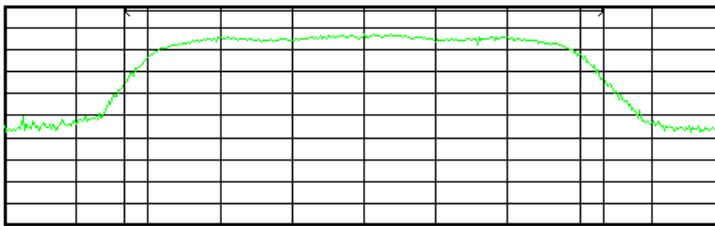
Ch Freq 2.437 GHz		Trig Free	Freq/Channel
Channel Power			Center Freq 2.43700000 GHz
Ref 20 dBm Atten 20 dB Ext PG -10.2 dB #Peak Log 10 dB/			Start Freq 2.42200000 GHz
			Stop Freq 2.45200000 GHz
Center 2.437 GHz Span 30 MHz #Res BW 1 MHz #VBW 3 MHz #Sweep 200 ms (401 pts)			CF Step 3.00000000 MHz Auto Man
Channel Power Power Spectral Density 16.87 dBm /20.0000 MHz -56.14 dBm/Hz			Freq Offset 0.00000000 Hz
			Signal Track On Off
			Scale Type Log Lin

802.11HT20 ANT1 (2462MHz)

Agilent 10:14:39 Sep 2, 2013

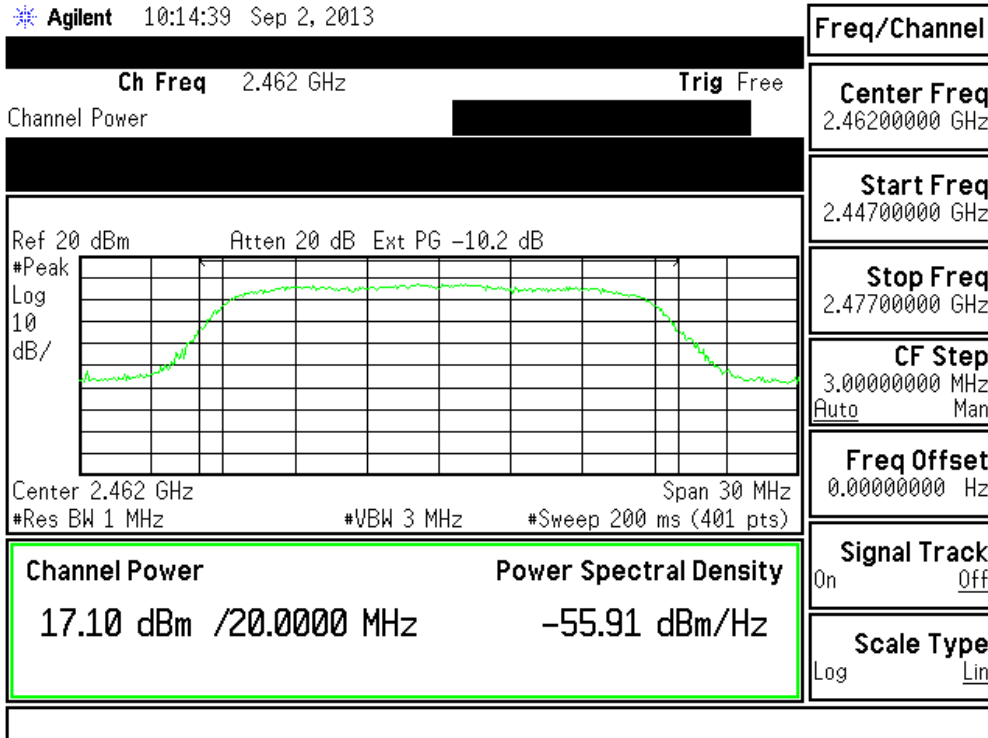

802.11HT20 ANT2 (2412MHz)

Agilent 10:00:05 Sep 2, 2013

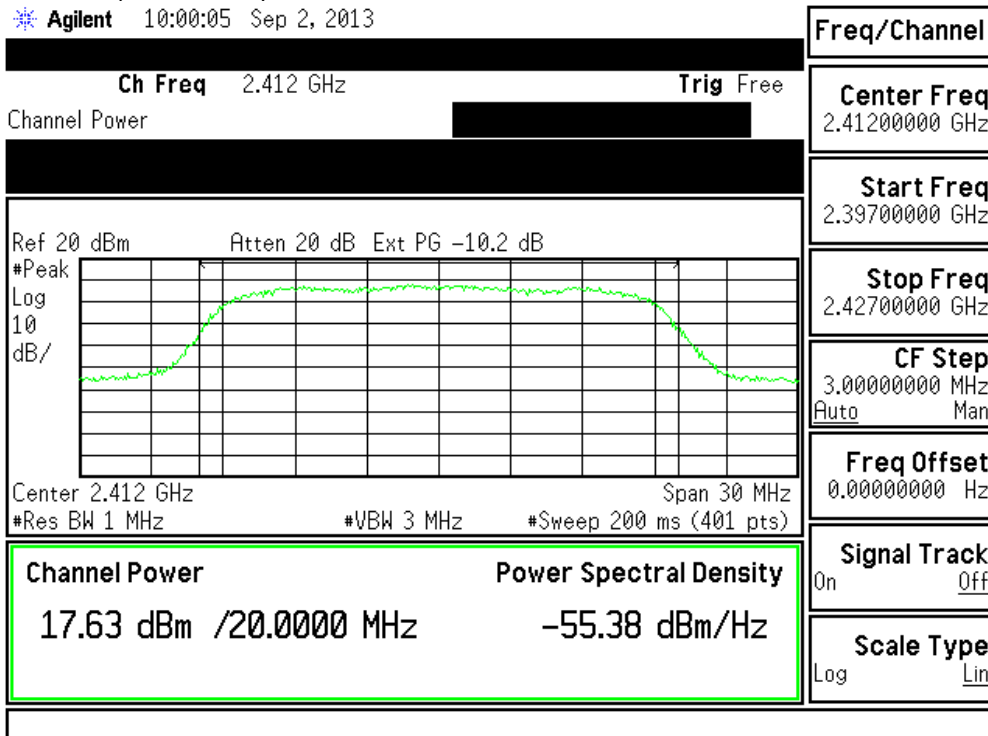

802.11HT20 ANT2 (2437MHz)

Agilent 10:07:25 Sep 2, 2013

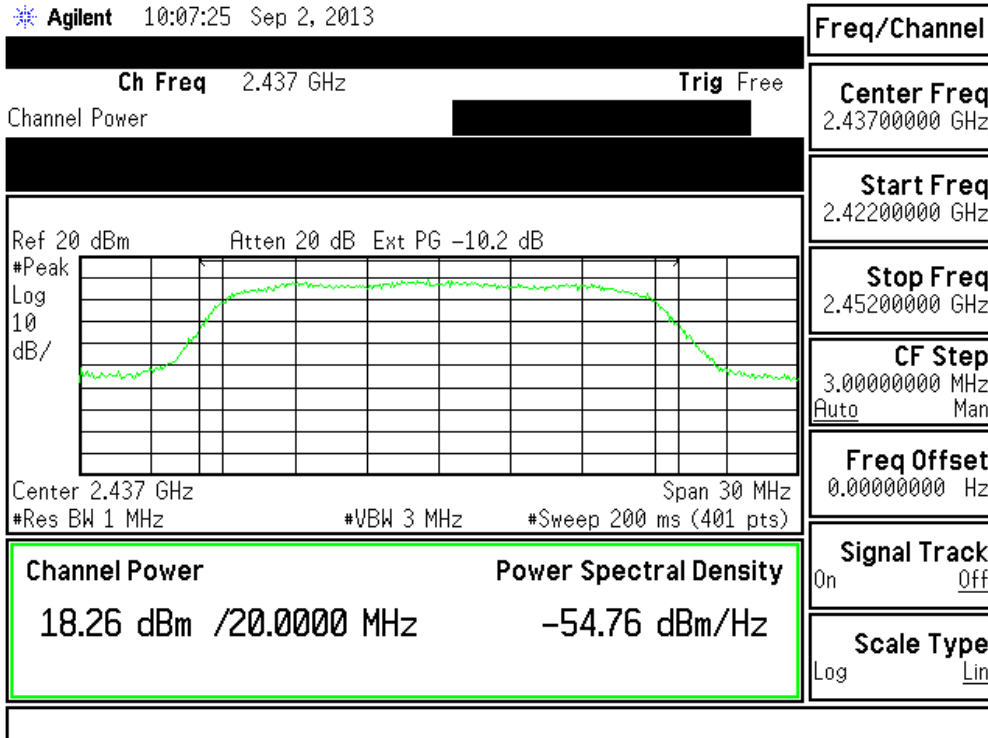

802.11HT20 ANT2 (2462MHz)

Agilent 10:15:00 Sep 2, 2013

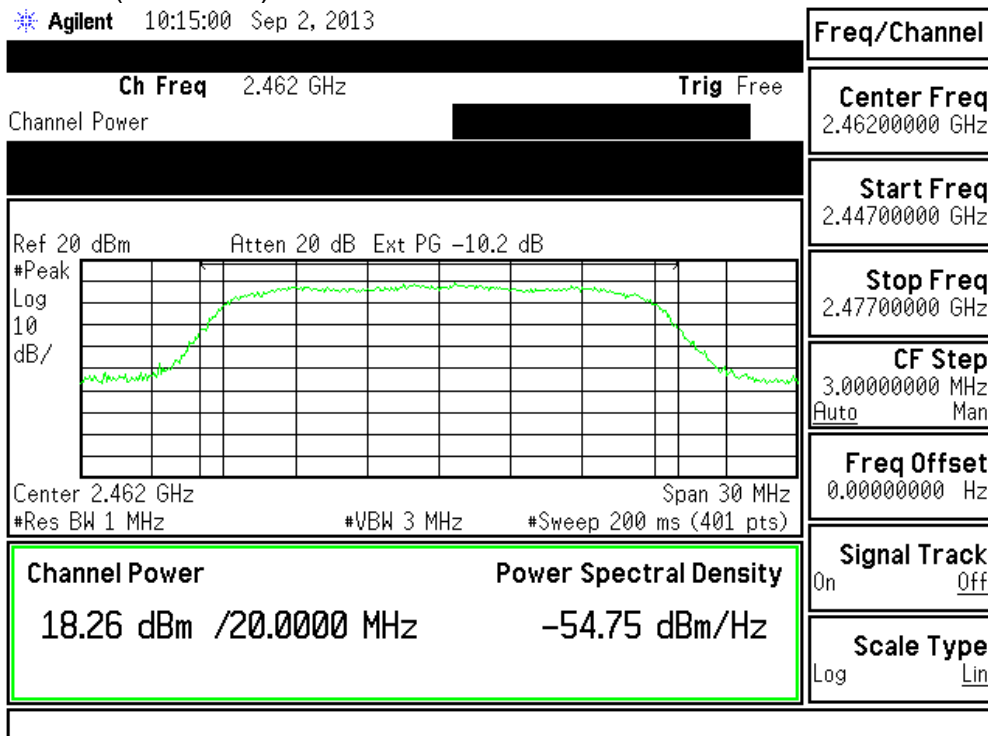

802.11HT40 ANT1 (2422MHz)

Agilent 11:02:12 Sep 2, 2013

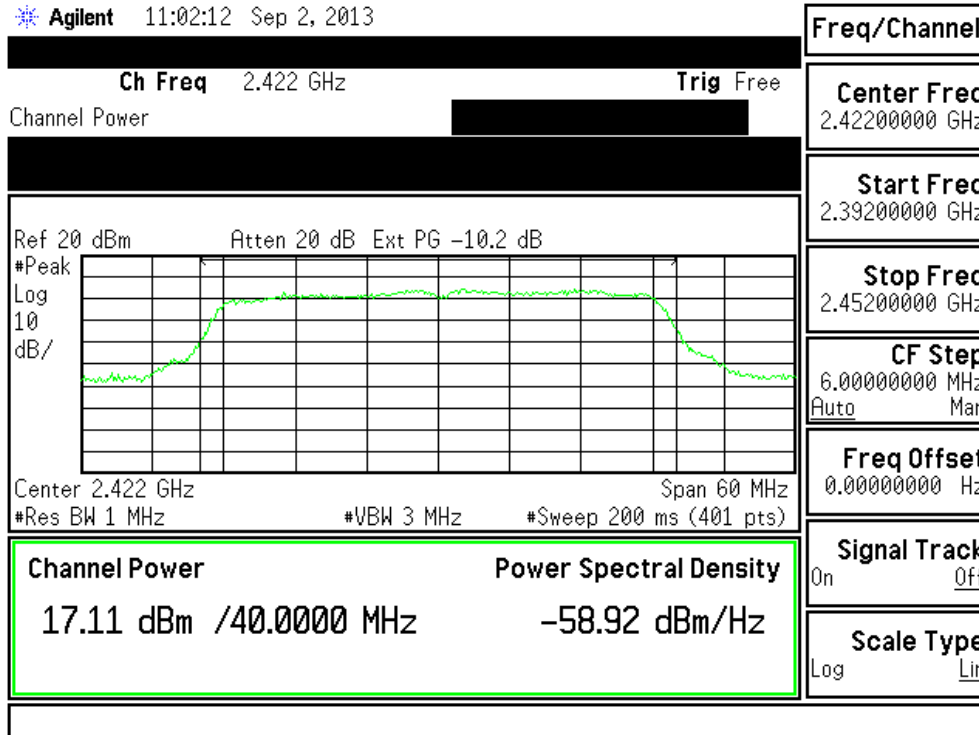

802.11HT40 ANT1 (2437MHz)

Agilent 11:09:41 Sep 2, 2013

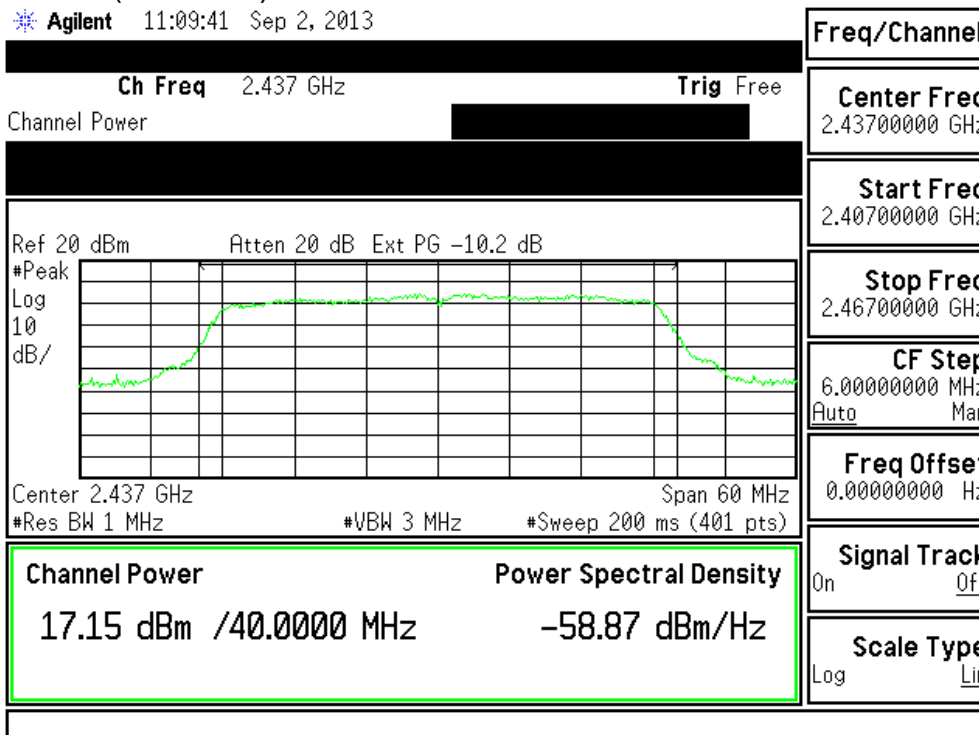

802.11HT40 ANT1 (2452MHz)

Agilent 11:16:41 Sep 2, 2013

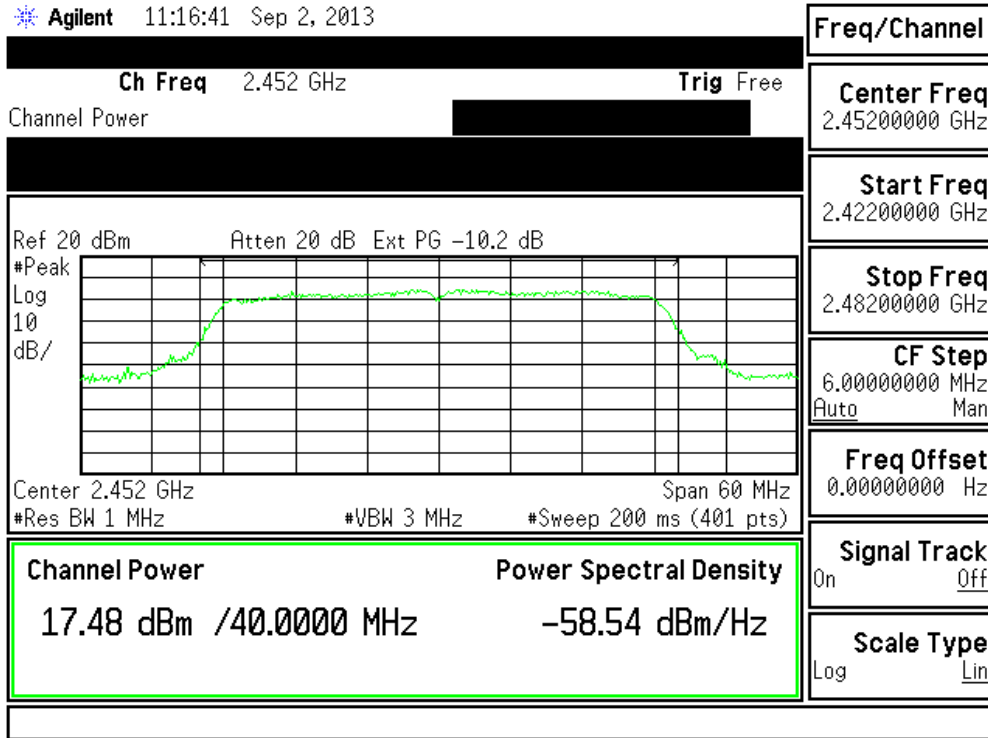

802.11HT40 ANT2 (2422MHz)

Agilent 11:02:39 Sep 2, 2013

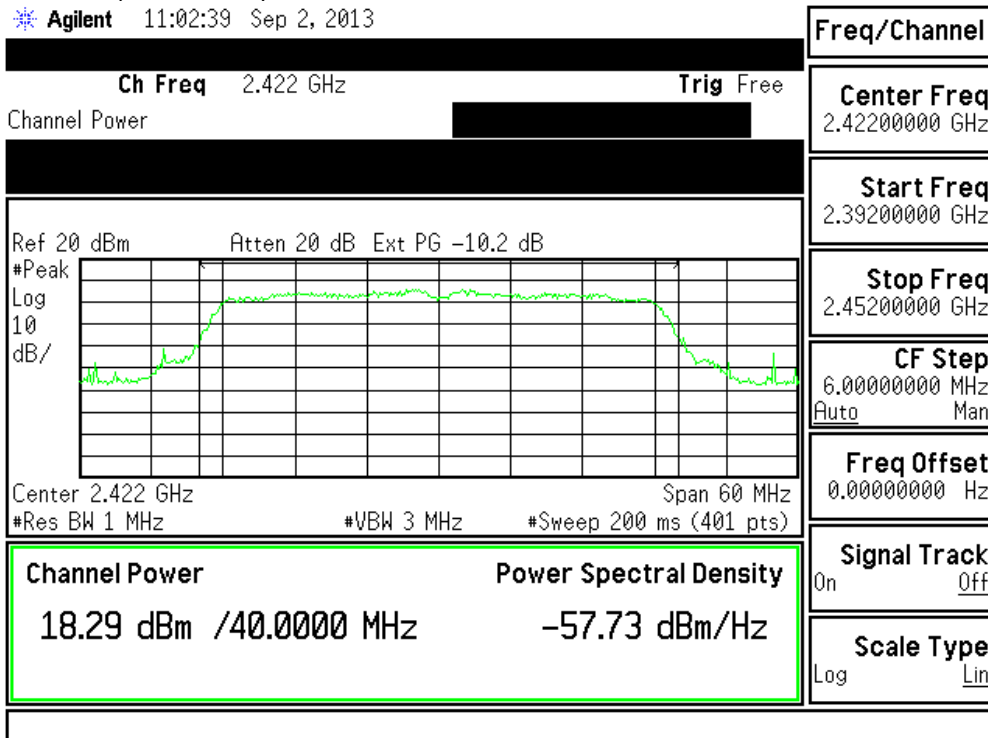

802.11HT40 ANT2 (2437MHz)

Agilent 11:10:07 Sep 2, 2013

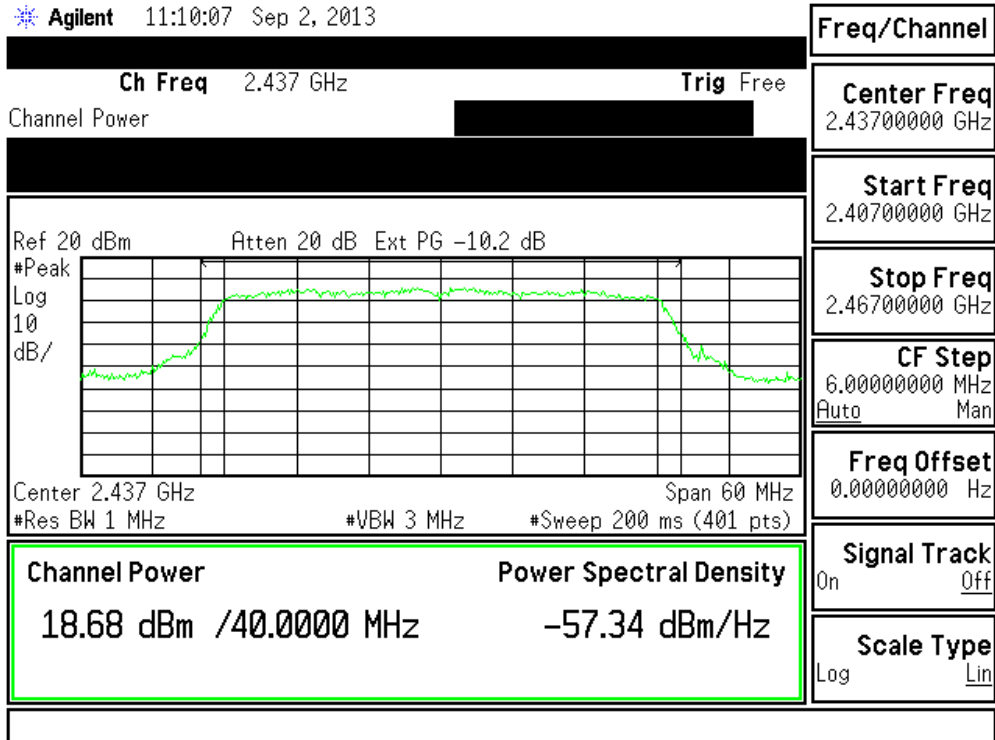

802.11HT40 ANT2 (2452MHz)

Agilent 11:17:03 Sep 2, 2013

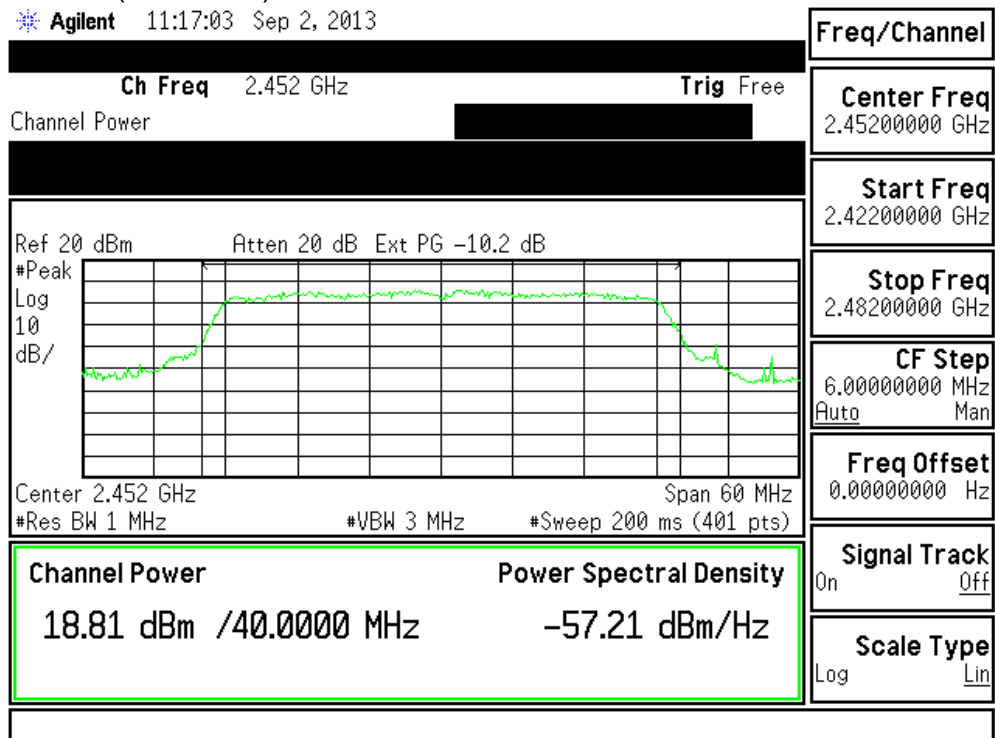

5. Minimum 6dB RF Bandwidth Requirements

5.1 Test Condition & Setup :

The antenna port of the EUT was connected to the input of a spectrum analyzer. Analyzer RES BW was set to 100 kHz. For each RF output channel investigated, the spectrum analyzer center frequency was set to the channel carrier. A PEAK output reading was taken, a DISPLAY line was drawn 6 dB lower than PEAK level. The 6 dB bandwidth was determined from where the channel output spectrum intersected the display line.

The test was performed at 3 channels (Channel 1, 6, 11)

Measurement procedure is followed KDB 558074 v03r01 (8.1 option 1: DTS bandwidth)

5.2 Test Instruments Configuration:

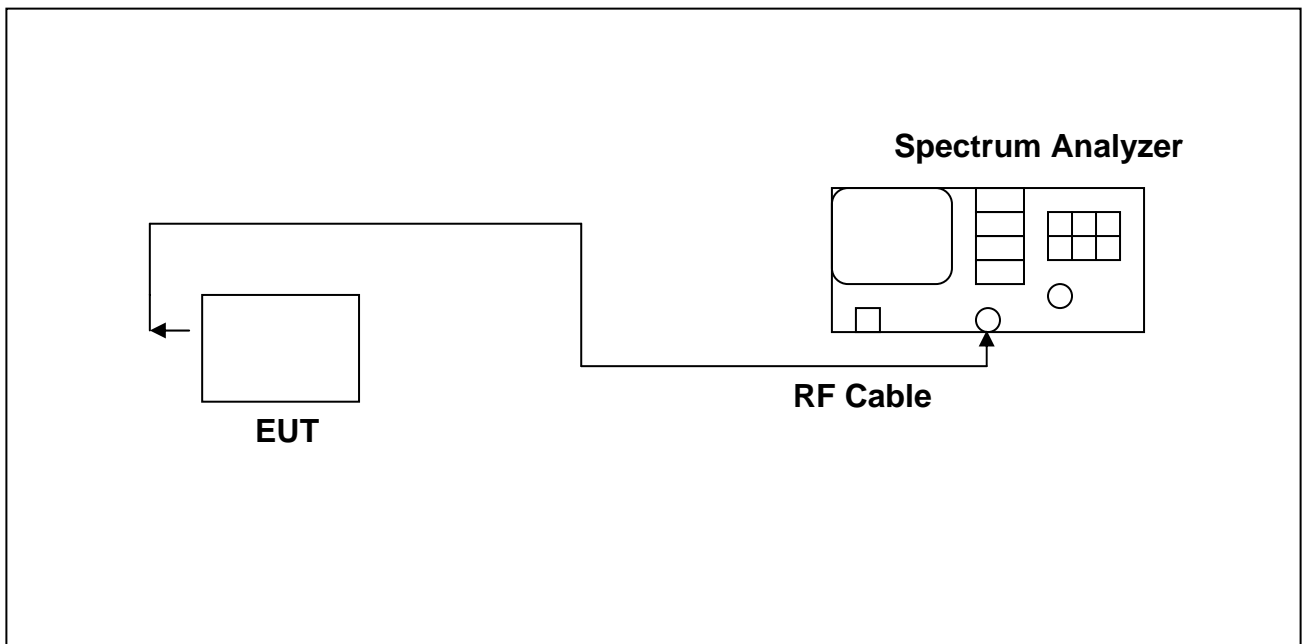

5.3 Test Equipment List:

Item	Mfr/Brand	Instruments	Serial No.	Model/Type No.	Calibrated Date	Next Cal. Date
1.	Agilent	Spectrum Analyzer	US39240419	E4407B	2013/01/29	2014/01/29

5.4 Test Result:

802.11b

Frequency (MHz)	Min. 6dB Bandwidth (MHz)	Required Limit
2412	8.600	>500KHz
2437	9.050	>500KHz
2462	9.100	>500KHz

802.11g

Frequency (MHz)	Min. 6dB Bandwidth (MHz)	Required Limit
2412	15.450	>500KHz
2437	15.225	>500KHz
2462	15.300	>500KHz

802.11n HT20(Ant 1)

Frequency (MHz)	Min. 6dB Bandwidth (MHz)	Required Limit
2412	17.400	>500KHz
2437	15.300	>500KHz
2462	16.875	>500KHz

802.11n HT40(Ant 1)

Frequency (MHz)	Min. 6dB Bandwidth (MHz)	Required Limit
2422	36.125	>500KHz
2437	35.875	>500KHz
2452	35.875	>500KHz

802.11n HT20(Ant 2)

Frequency (MHz)	Min. 6dB Bandwidth (MHz)	Required Limit
2412	17.475	>500KHz
2437	16.875	>500KHz
2462	16.650	>500KHz

802.11n HT40(Ant 2)

Frequency (MHz)	Min. 6dB Bandwidth (MHz)	Required Limit
2422	36.500	>500KHz
2437	36.500	>500KHz
2452	36.500	>500KHz

Note: Test Graphs See next page.

802.11b (2412MHz)

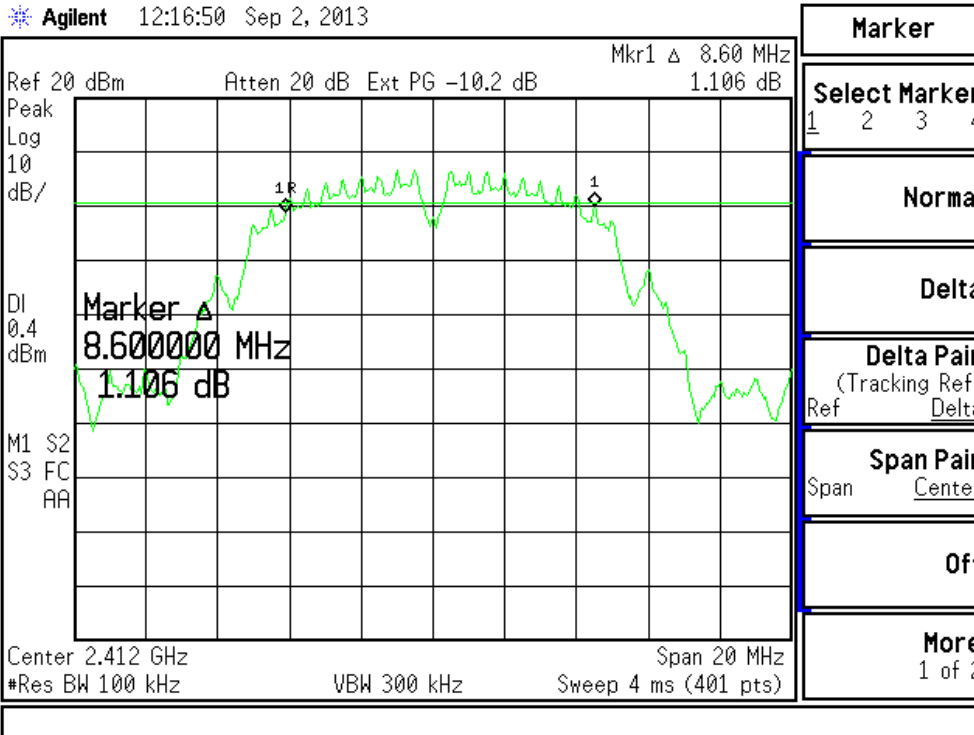

Note: Ext PG = Attenuator + Cable loss.

802.11b (2437MHz)

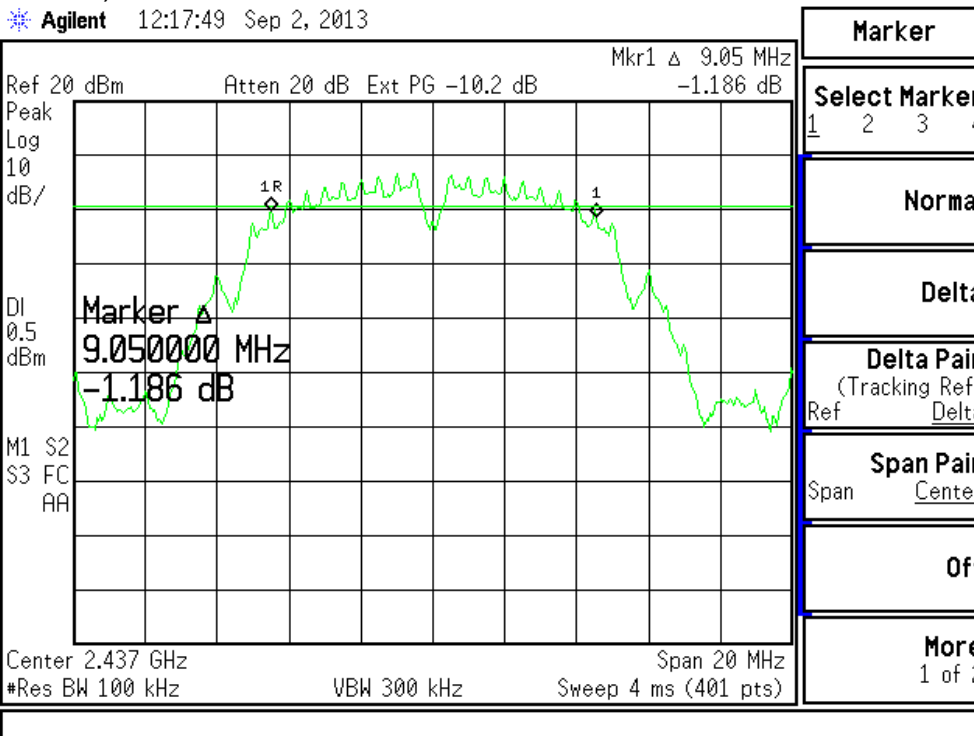

802.11b (2462MHz)

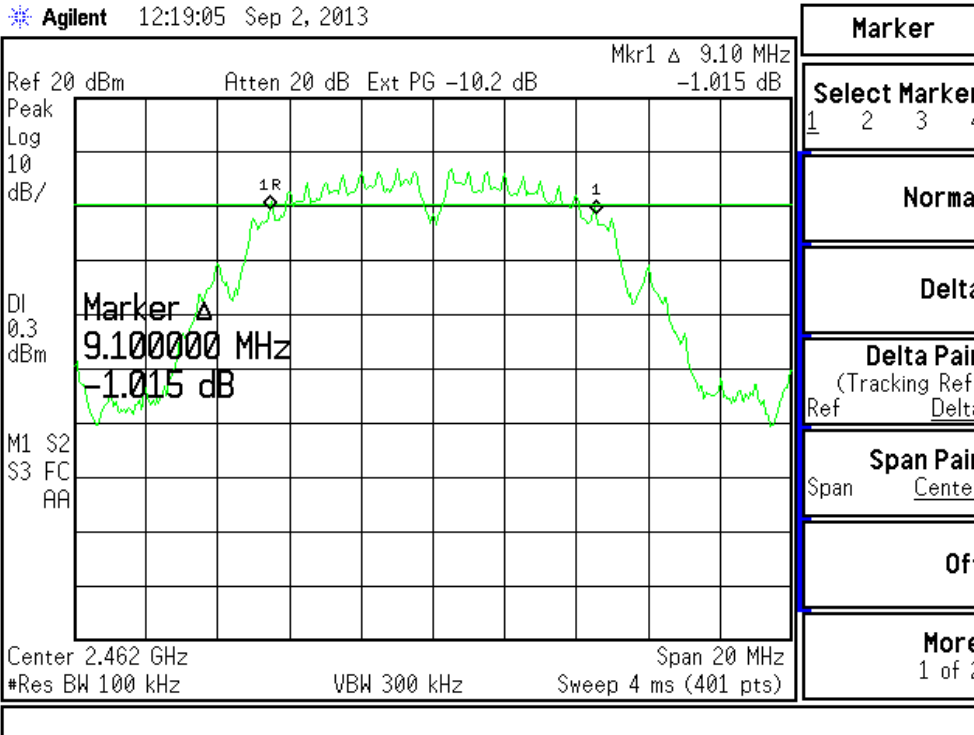

802.11g (2412MHz)

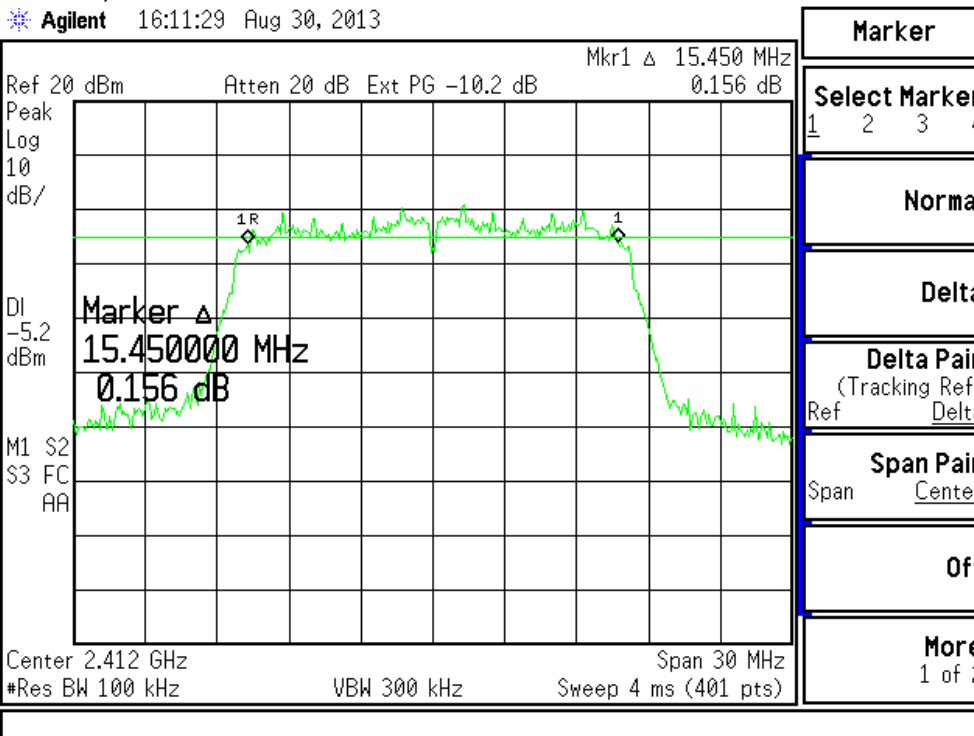

802.11g (2437MHz)

Agilent 16:12:50 Aug 30, 2013

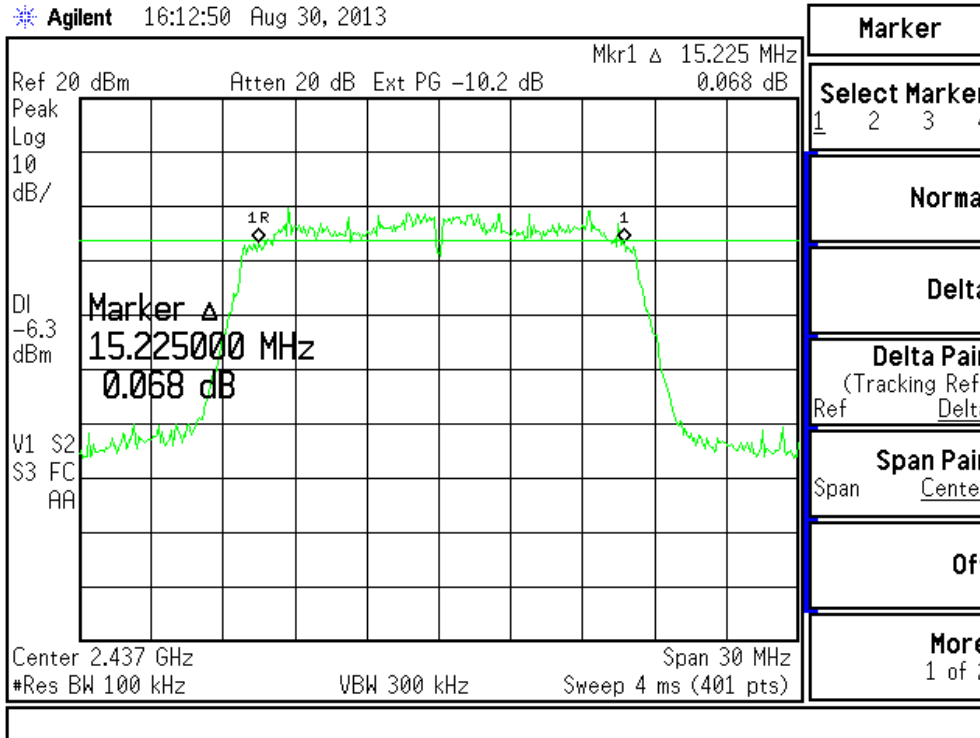

802.11g (2462MHz)

Agilent 16:14:49 Aug 30, 2013

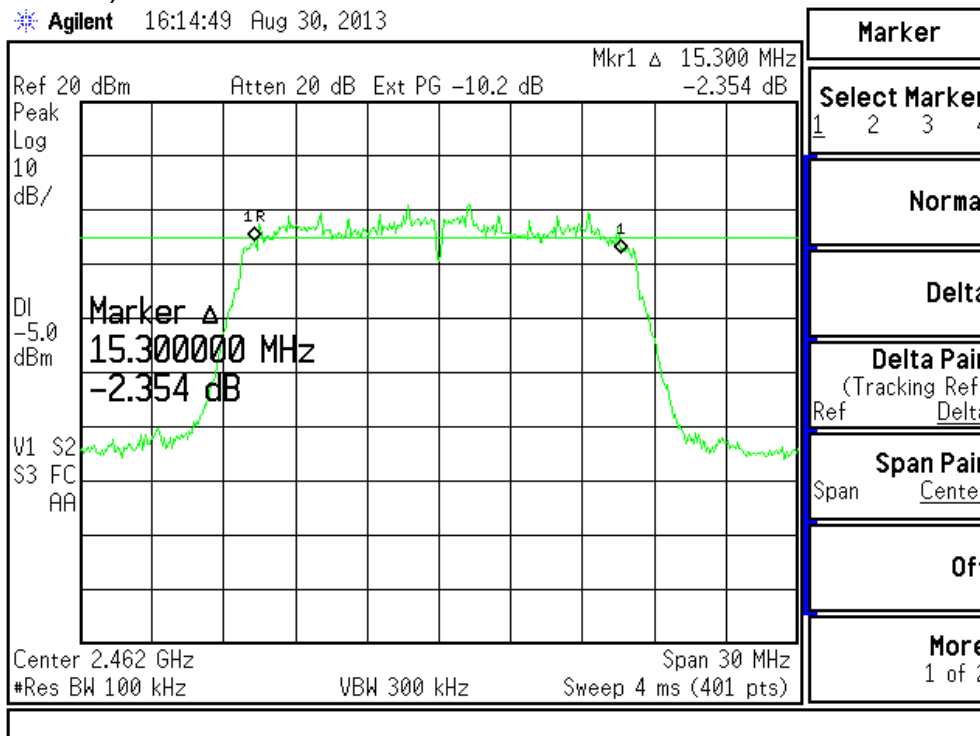

802.11n HT20(Ant 1)(2412MHz)

Agilent 16:16:02 Aug 30, 2013

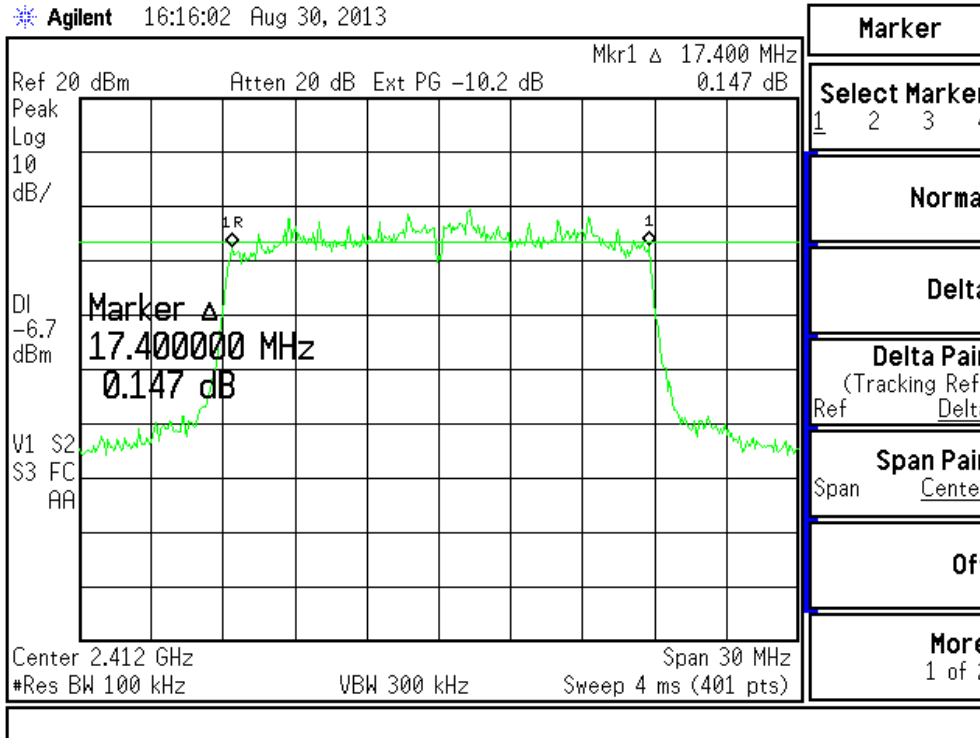

802.11n HT20(Ant 1)(2437MHz)

Agilent 16:22:17 Aug 30, 2013

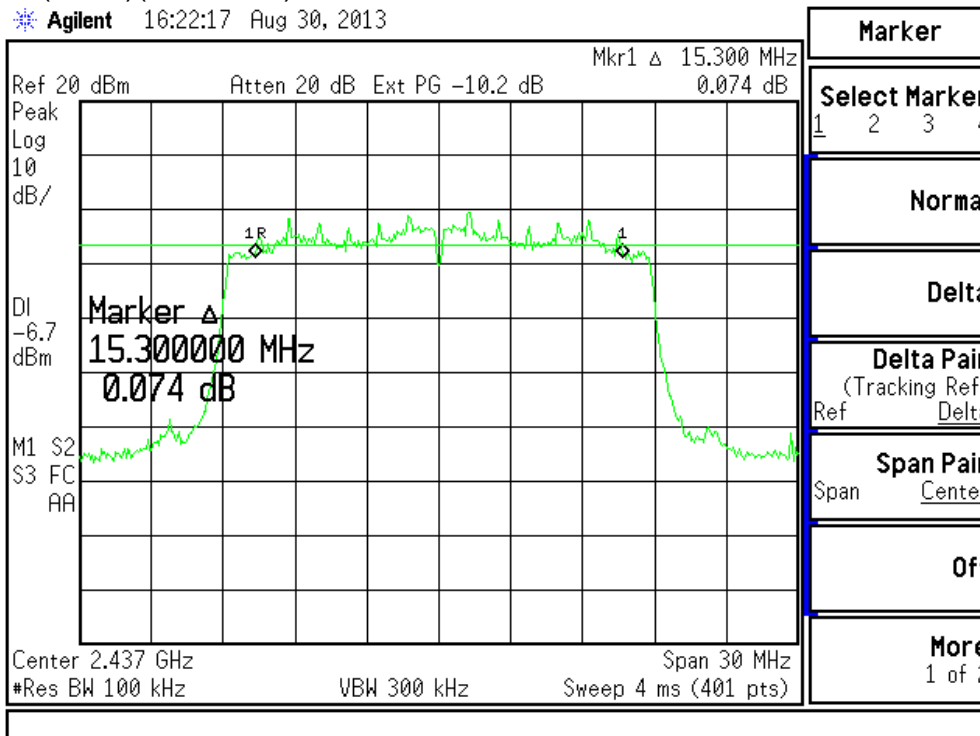

802.11n HT20(Ant 1)(2462MHz)

Agilent 16:24:13 Aug 30, 2013

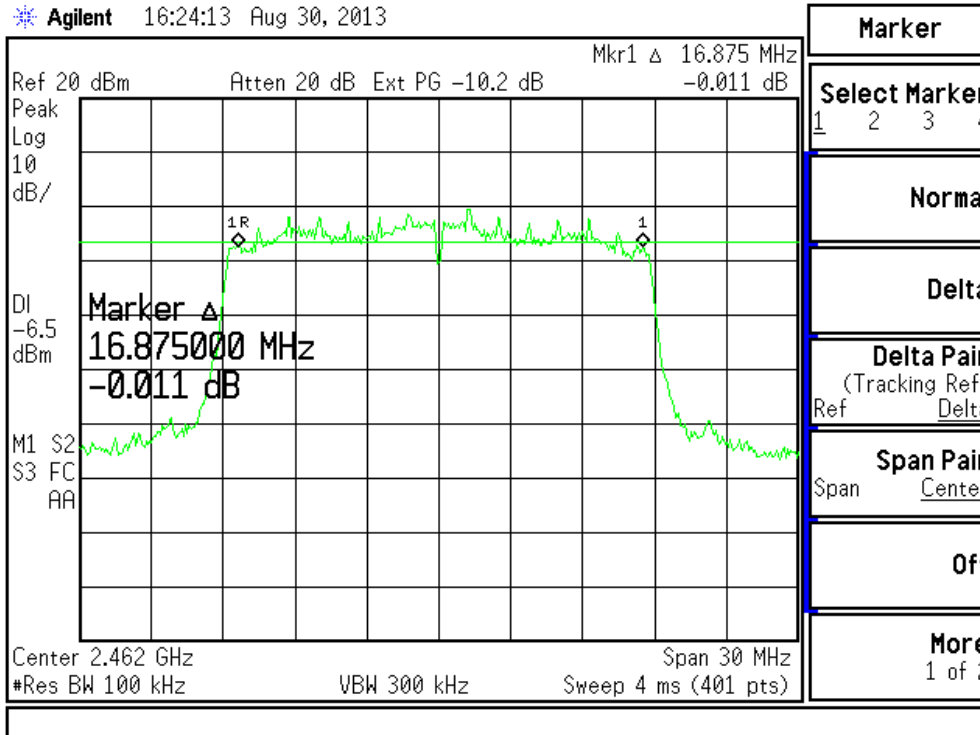

802.11n HT40(Ant 1)(2422MHz)

Agilent 16:28:17 Aug 30, 2013

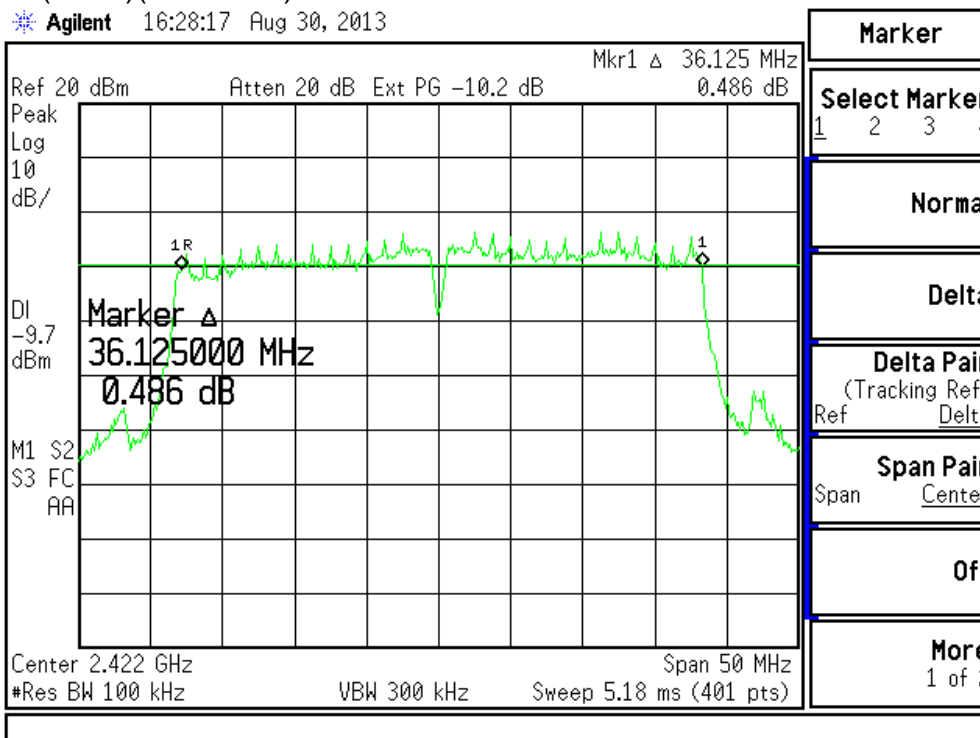

802.11n HT40(Ant 1) (2437MHz)

Agilent 16:29:48 Aug 30, 2013

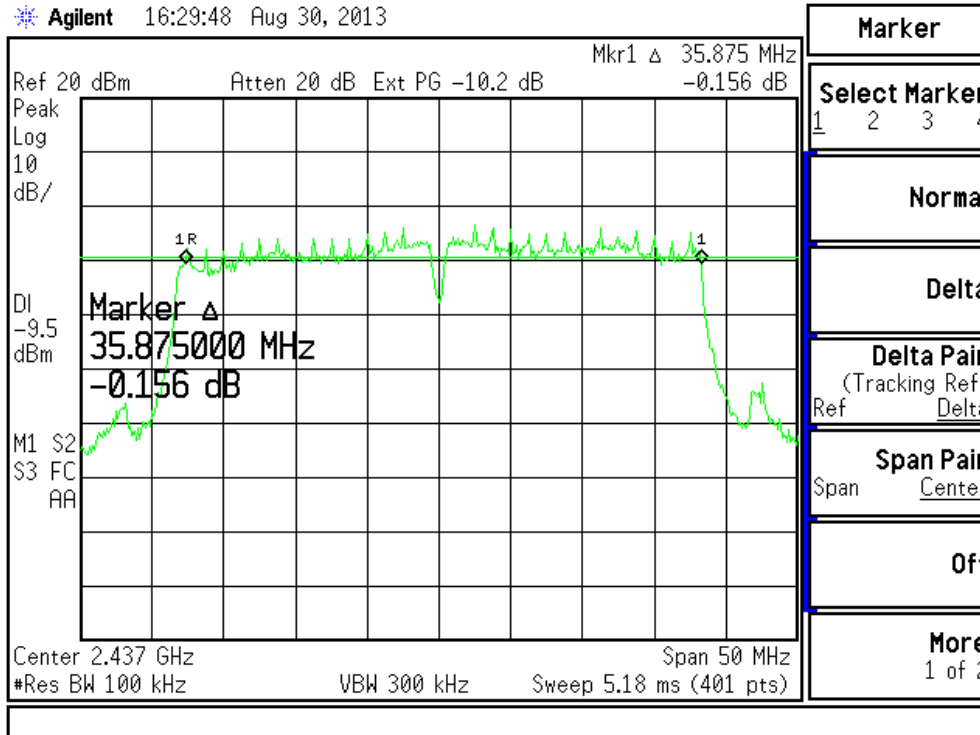

802.11n HT40(Ant 1) (2452MHz)

Agilent 16:33:20 Aug 30, 2013

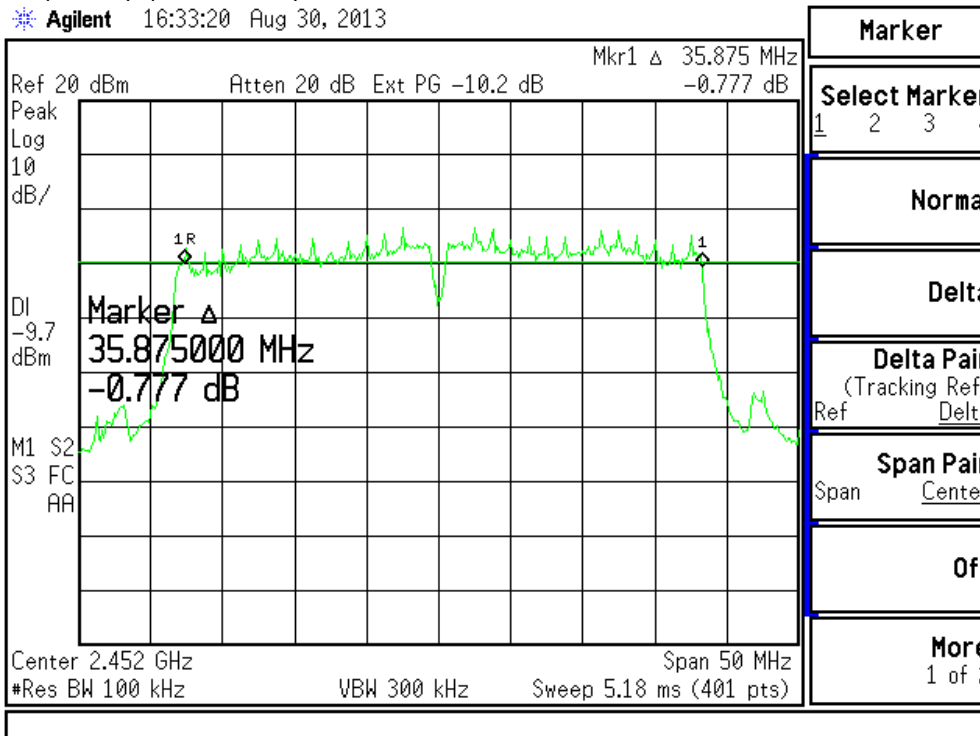

802.11n HT20(Ant 2)(2412MHz)

Agilent 16:17:55 Aug 30, 2013

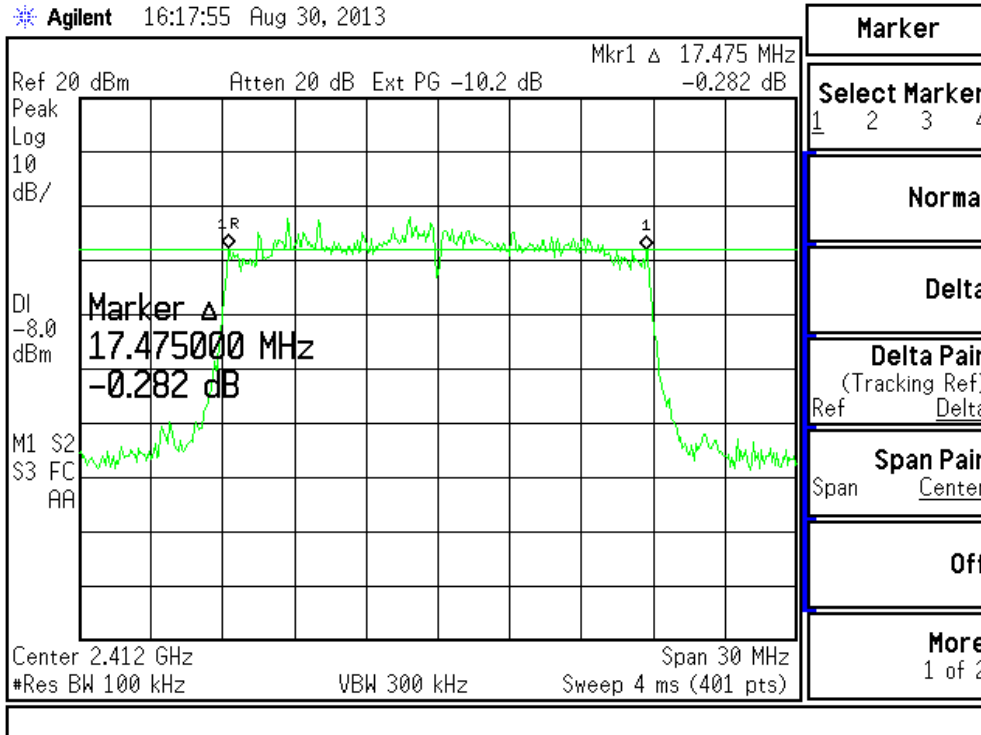

802.11n HT20(Ant 2)(2437MHz)

Agilent 16:19:33 Aug 30, 2013

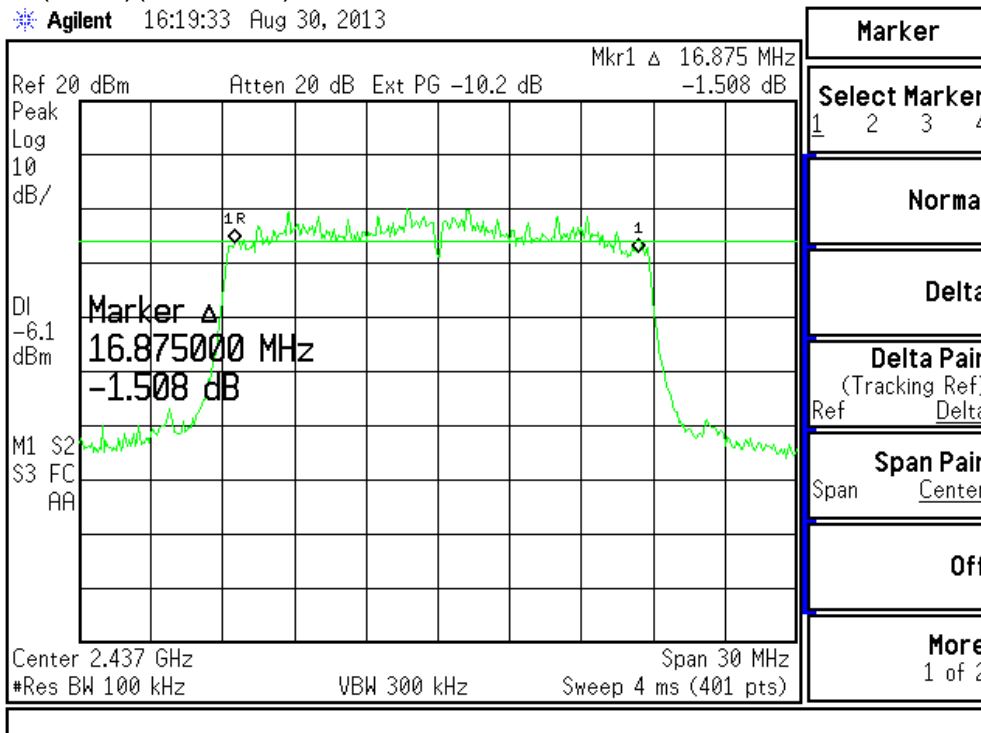

802.11n HT20(Ant 2)(2462MHz)

Agilent 16:25:10 Aug 30, 2013

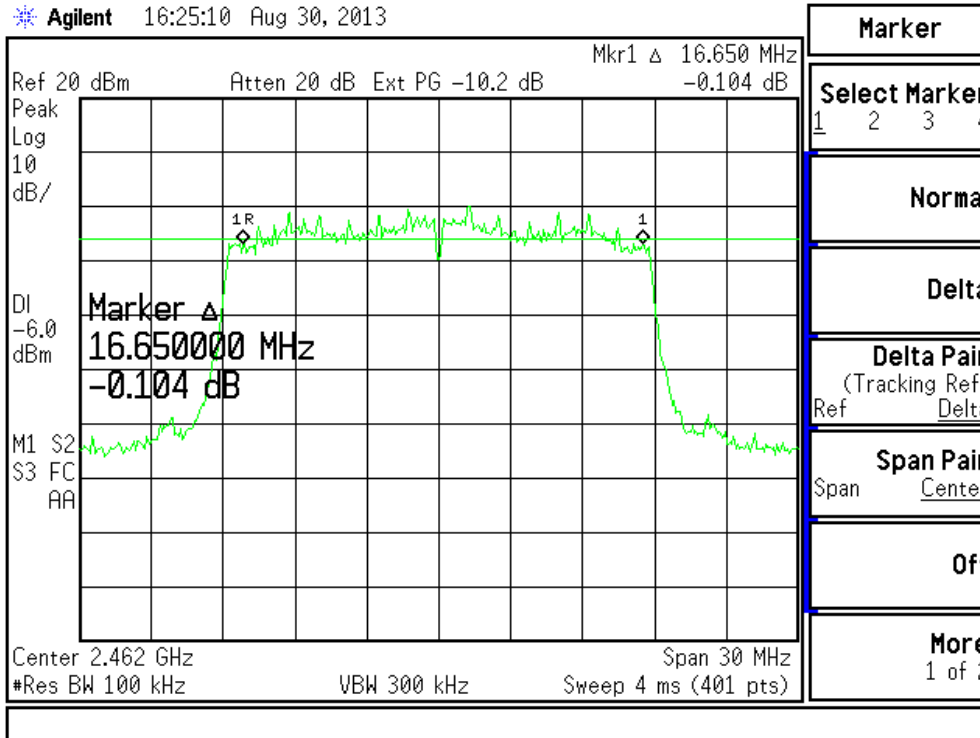

802.11n HT40(Ant 2)(2422MHz)

Agilent 16:27:15 Aug 30, 2013

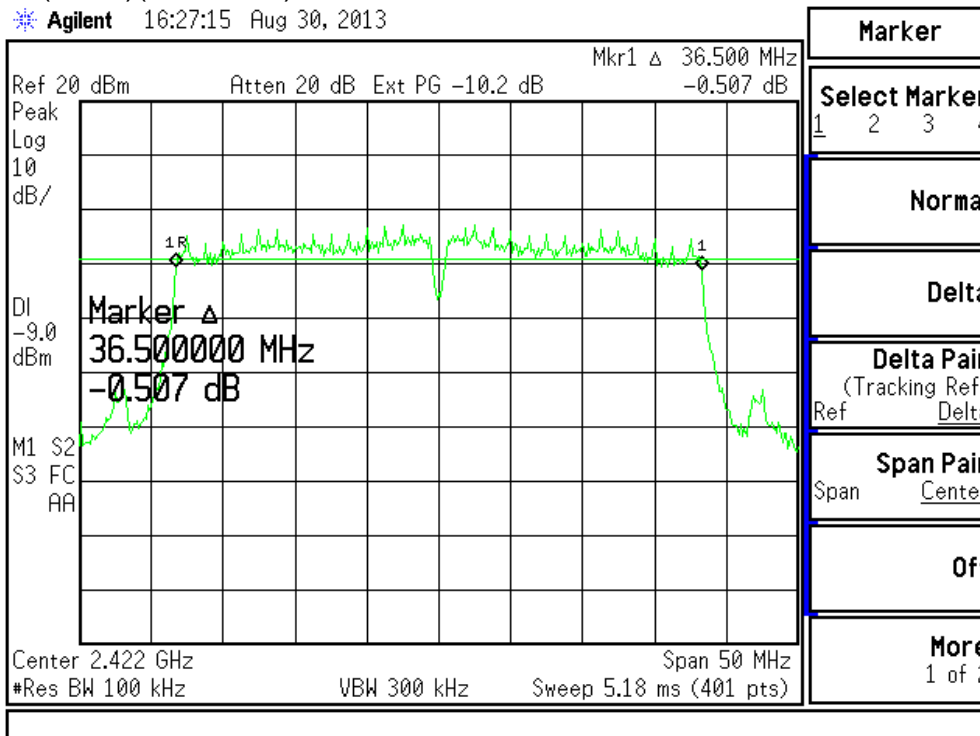

802.11n HT40(Ant 2)(2437MHz)

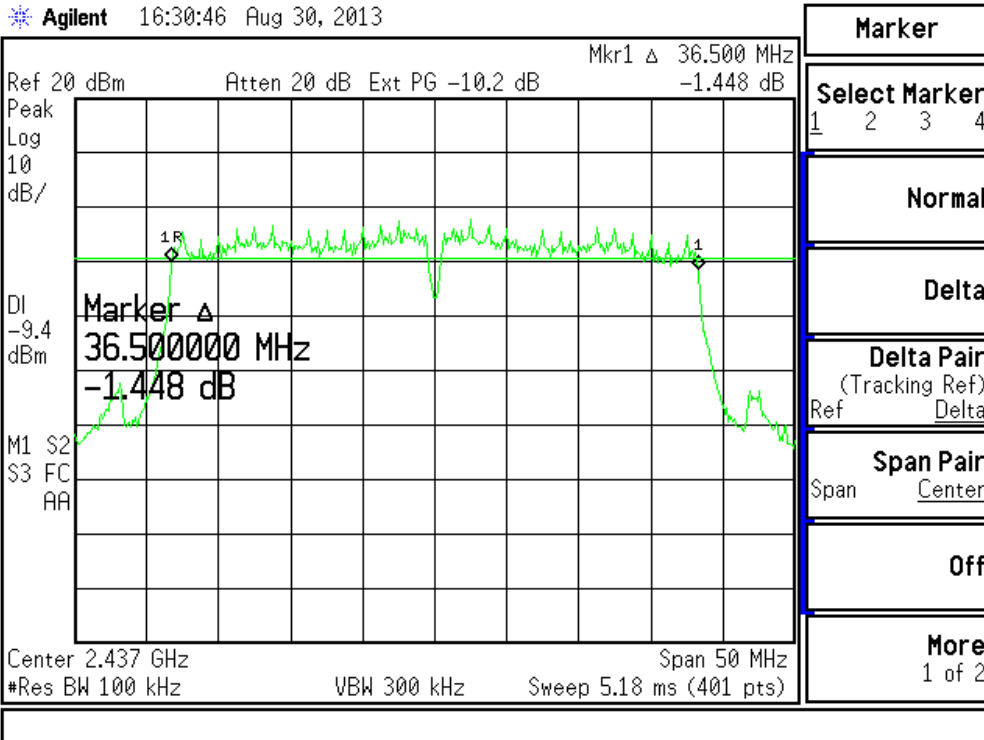

802.11n HT40(Ant 2)(2452MHz)

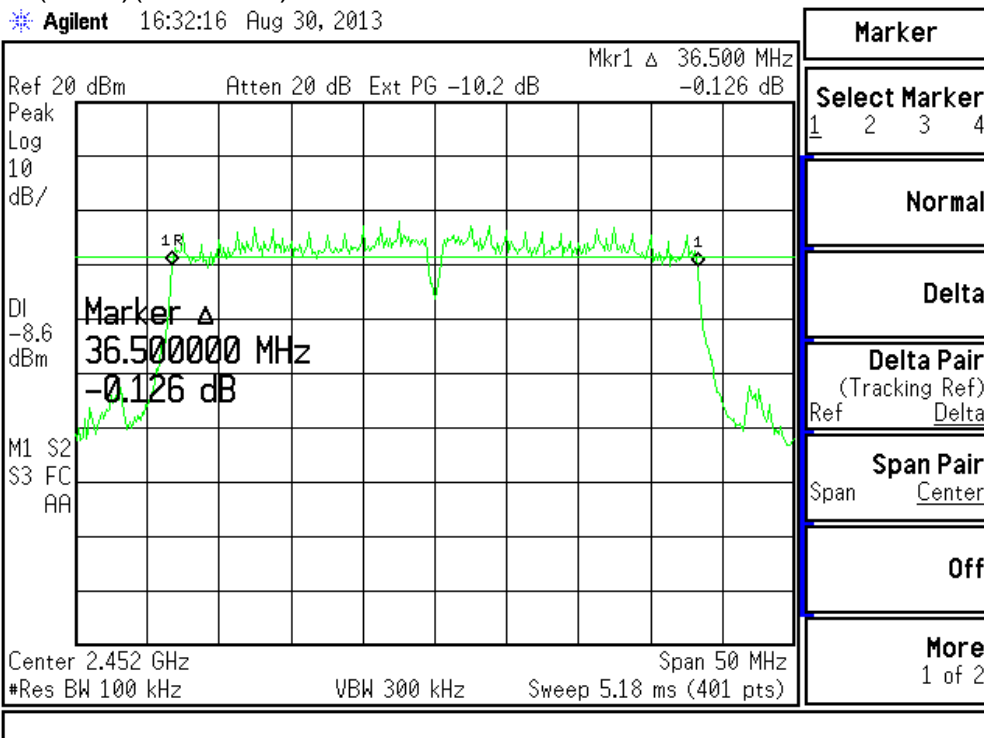

6. Maximum Power Density Requirements

6.1 Test Condition & Setup :

For digitally modulated systems, the power spectral density conducted from the intentional radiator to the antenna shall not be greater than 8 dBm in any 3 kHz band during any time interval of continuous transmission.

RBW =3kHz , VBW=100kHz ,

Detector = peak , Sweep time = auto couple , Trace Mode = max hold , Allow trace to fully stabilize. Use the peak marker function to determine the maximum amplitude level in any 3kHz band segment within the fundamental EBW.

Measurement procedure is followed KDB 558074 v03r01 (10.2 Method PKPSD (peak PSD)

Measurement procedure is followed KDB 662911 D01 Multiple Transmitter Output v02 Paragraph E) Guidance for summing emission measurements from multiple outputs of a transmitter or from multiple transmitters.

2) In-Band Power Spectral Density (PSD) Measurements

- a) Measure and sum the spectra across the outputs.
- c) add 10 log(Nant) dB .

6.2 Test Instruments Configuration:

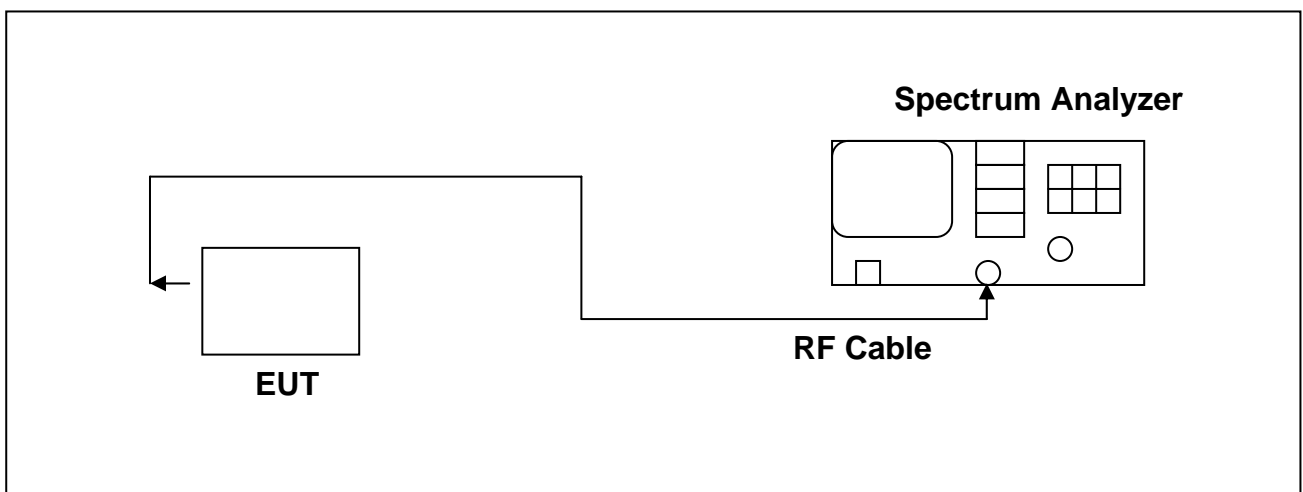

6.3 Test Equipment List:

Item	Mfr/Brand	Instruments	Serial No.	Model/Type No.	Calibrated Date	Next Cal. Date
1.	Agilent	Spectrum Analyzer	US39240419	E4407B	2013/01/29	2014/01/29

6.4 Test Result:

802.11b

Frequency (MHz)	Power Density (dBm)	Power Density (mW)
2412	-8.036	<8dBm
2437	-6.321	<8dBm
2462	-7.427	<8dBm

802.11g

Frequency (MHz)	Power Density (dBm)	Power Density (mW)
2412	-13.550	<8dBm
2437	-13.740	<8dBm
2462	-13.220	<8dBm

802.11n HT20(Ant 1)

Frequency (MHz)	Power Density (dBm)	Power Density (mW)	Required Limit
2412	-13.040	0.02483	<8dBm
2437	-11.350	0.03664	<8dBm
2462	-12.980	0.02518	<8dBm

Note : Power Density = spectrum measurements value + 10log(Nant)
Number of antenna: 2 → 10log(2)=3.01dB

802.11n HT40(Ant 1)

Frequency (MHz)	Power Density (dBm)	Power Density (mW)	Required Limit
2422	-14.390	0.01820	<8dBm
2437	-15.040	0.01567	<8dBm
2452	-15.470	0.01419	<8dBm

Note : Power Density = spectrum measurements value + 10log(Nant)
Number of antenna: 2 → 10log(2)=3.01dB

802.11n HT20(Ant 2)

Frequency (MHz)	Power Density (dBm)	Power Density (mW)	Required Limit
2412	-12.670	0.02704	<8dBm
2437	-11.500	0.03540	<8dBm
2462	-10.920	0.04046	<8dBm

Note : Power Density = spectrum measurements value + 10log(Nant)
 Number of antenna: 2 → 10log(2)=3.01dB

802.11n HT40(Ant 2)

Frequency (MHz)	Power Density (dBm)	Power Density (mW)	Required Limit
2422	-15.670	0.01355	<8dBm
2437	-14.250	0.01879	<8dBm
2452	-13.760	0.02104	<8dBm

Note : Power Density = spectrum measurements value + 10log(Nant)
 Number of antenna: 2 → 10log(2)=3.01dB

Note : The graph shown below is the highest output power of all different frequency listed in the table above..

802.11b (2437MHz)

Agilent 12:22:37 Sep 2, 2013

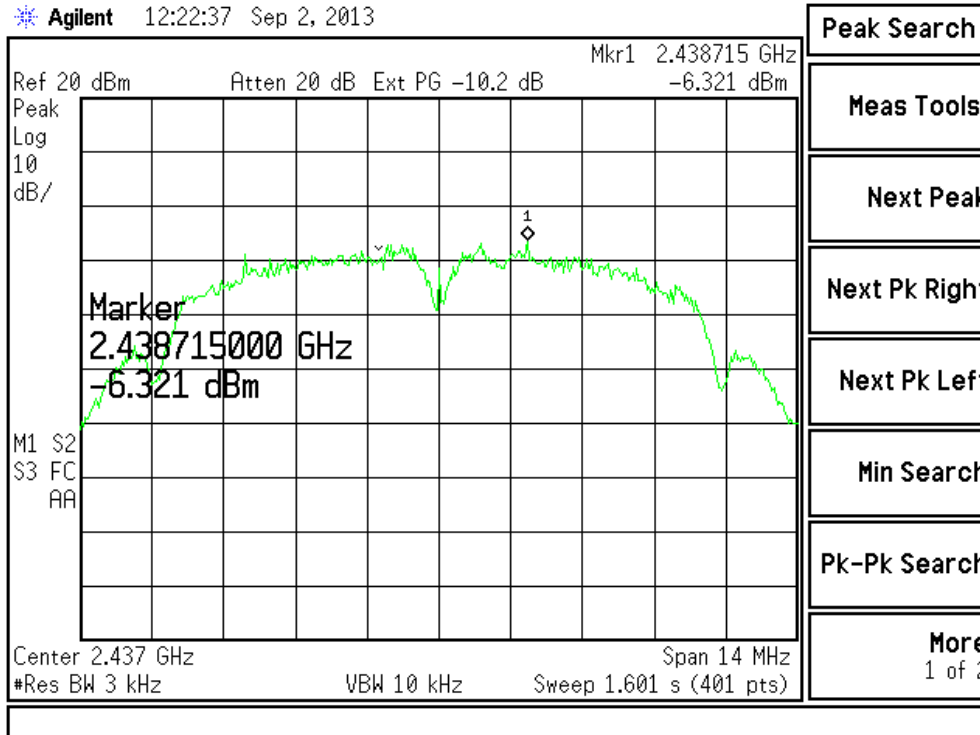

Note: Ext PG = Attenuator + Cable loss.

802.11g (2462MHz)

Agilent 16:42:44 Aug 30, 2013

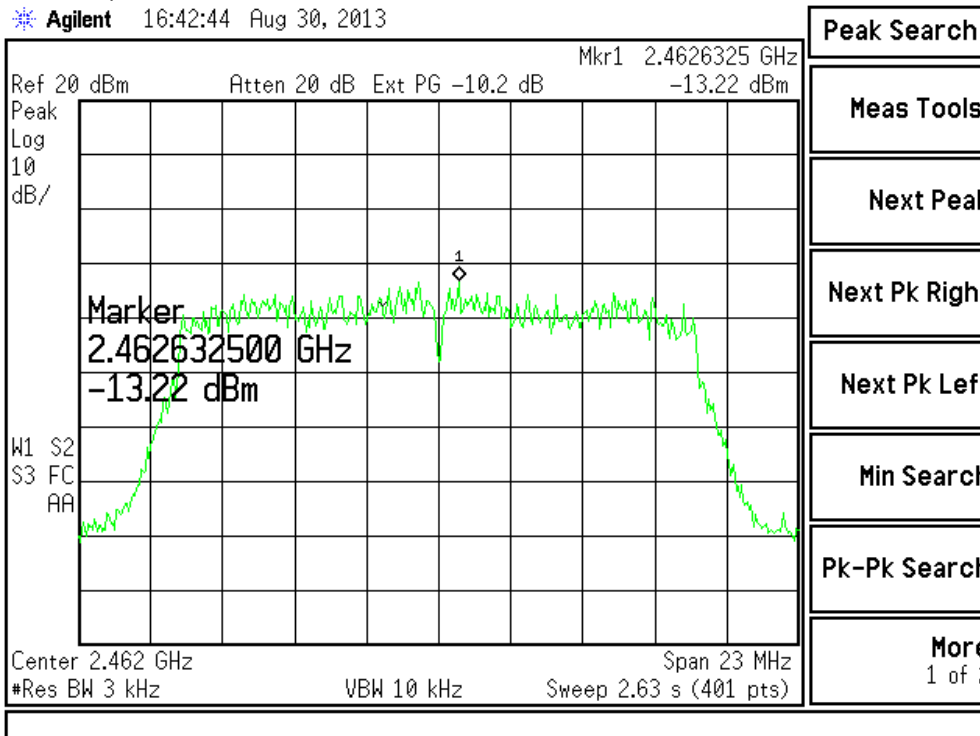

802.11n HT20(Ant 1)(2437MHz)

Agilent 16:45:11 Aug 30, 2013

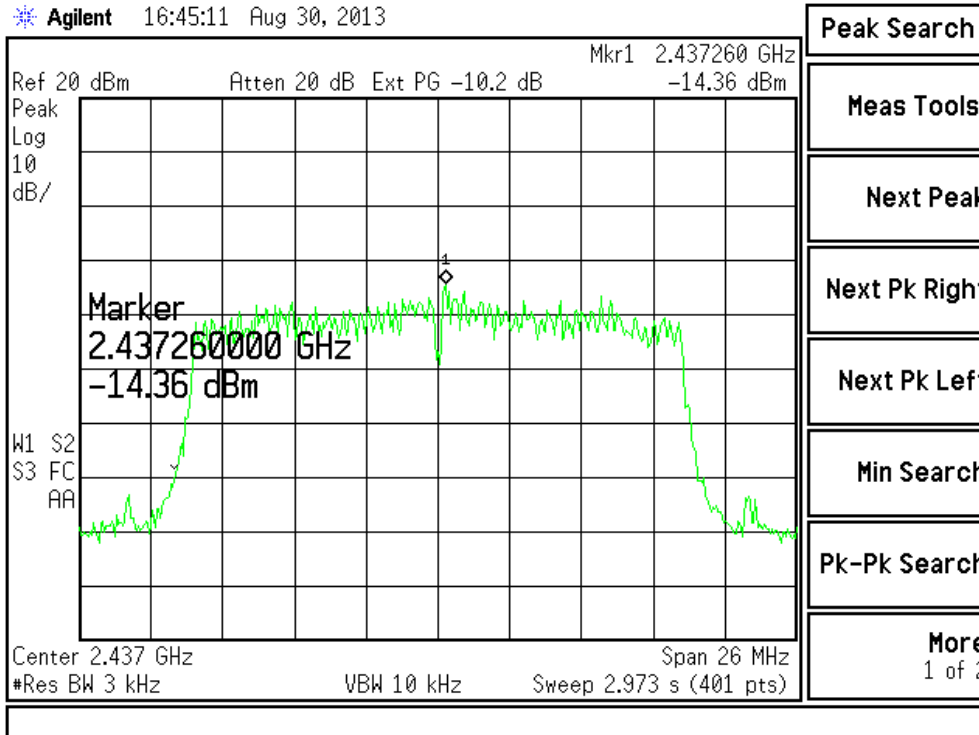

802.11n HT40(Ant 1)(2422MHz)

Agilent 16:48:10 Aug 30, 2013

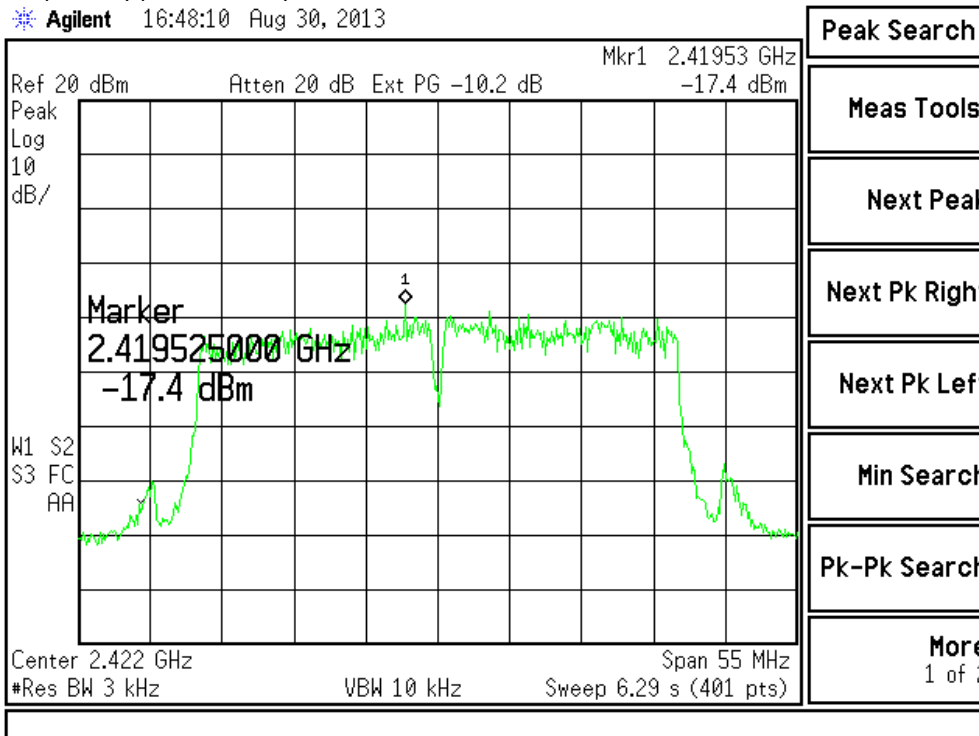

802.11n HT20(Ant 2)(2462MHz)

Agilent 16:46:24 Aug 30, 2013

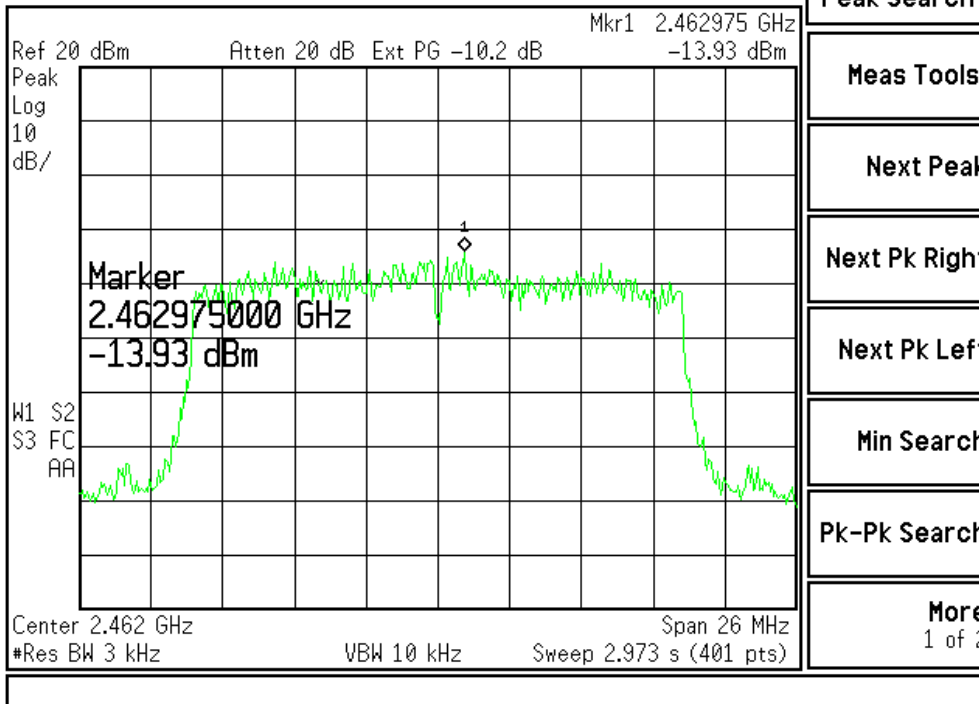

802.11n HT40(Ant 2)(2452MHz)

Agilent 16:50:34 Aug 30, 2013

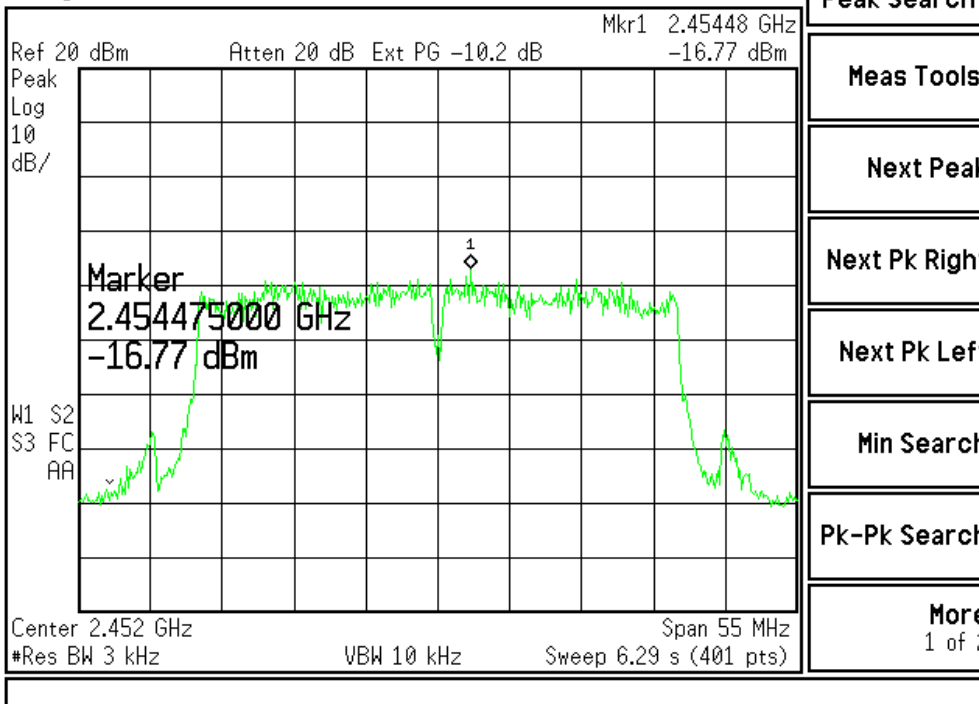

7. Out of Band Conducted Spurious Emissions Requirements

7.1 Test Condition & Setup :

In any 100 kHz bandwidth outside the EUT pass band, the RF power produced by the modulation products of the spreading sequence, the information sequence, and the carrier frequency shall be at least 20 dB below that of the maximum in-band 100 kHz emission, antenna output of the EUT was coupled directly to spectrum analyzer; if an external attenuator and/or cable was used, these losses are compensated for with the analyzer OFFSET function.

All other types of emissions from the EUT shall meet the general limits for radiated frequencies outside the pass band. The test was performed at 3 channels.

Measurement procedure is followed KDB 558074 v03r01 (11.3 Emission level measurement)

7.2 Test Instruments Configuration:

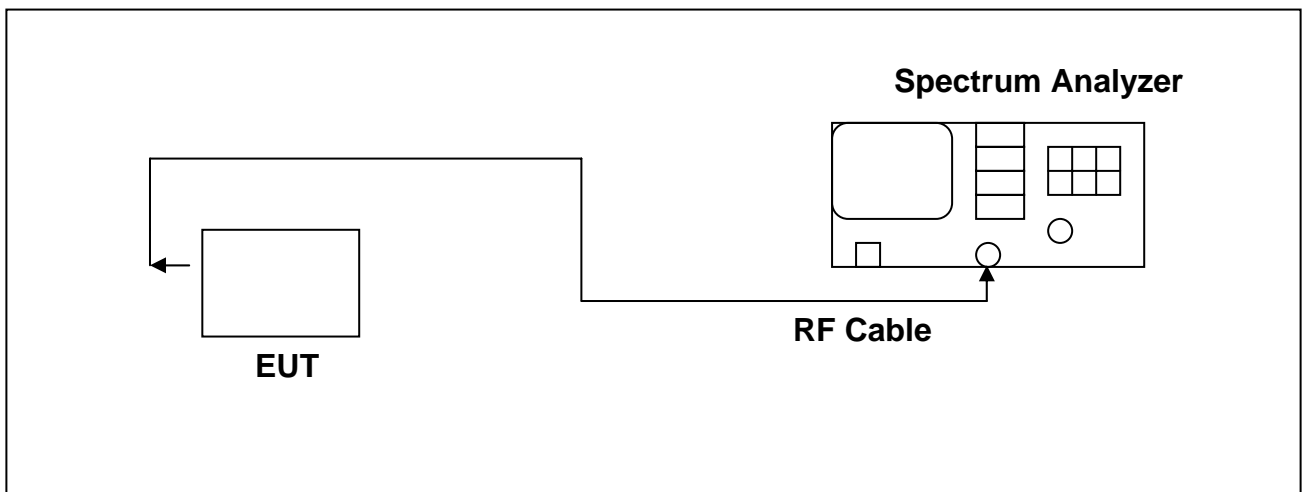

7.3 Test Equipment List:

Item	Mfr/Brand	Instruments	Serial No.	Model/Type No.	Calibrated Date	Next Cal. Date
1.	Agilent	Spectrum Analyzer	US39240419	E4407B	2013/01/29	2014/01/29

7.4 Test Result:

Refer to attached data sheets. Data shows out of band emissions are suppressed well below the -20 dBc minimum required by the Rules.

For the MIMO result, if the spurious emission of two antennas have the same frequency, we choose the worst one and add 3dB to be the final result, otherwise, use the graph to represent it.

Note : Test Graphs See next page.

802.11b (CH01) (1 of 2)

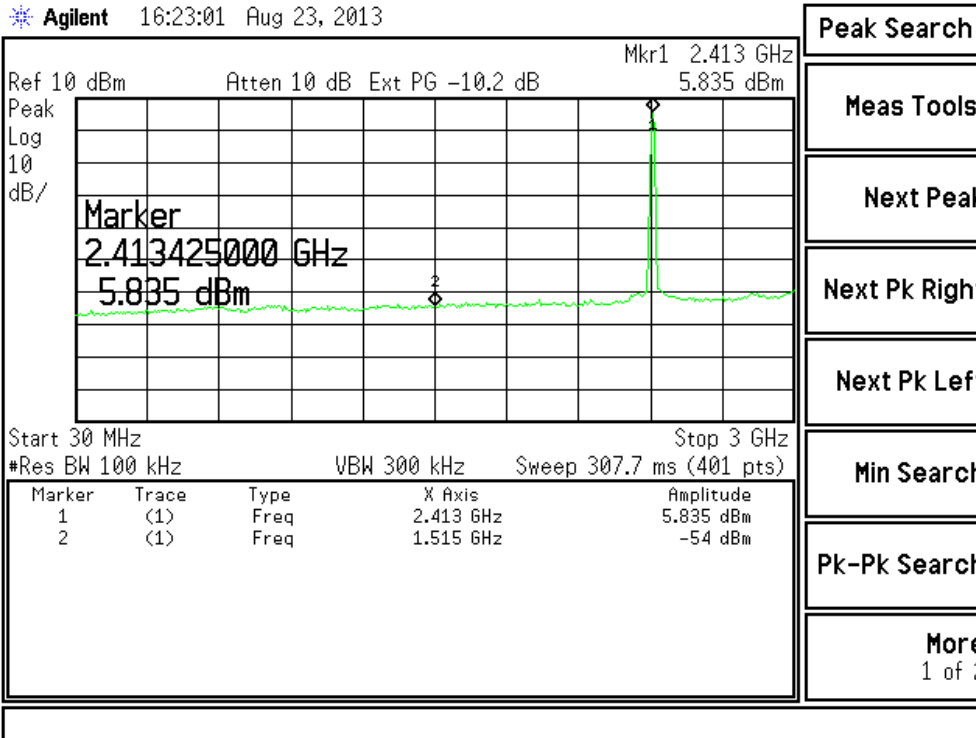

Note: Ext PG = Attenuator + Cable loss.

802.11b (CH01) (2 of 2)

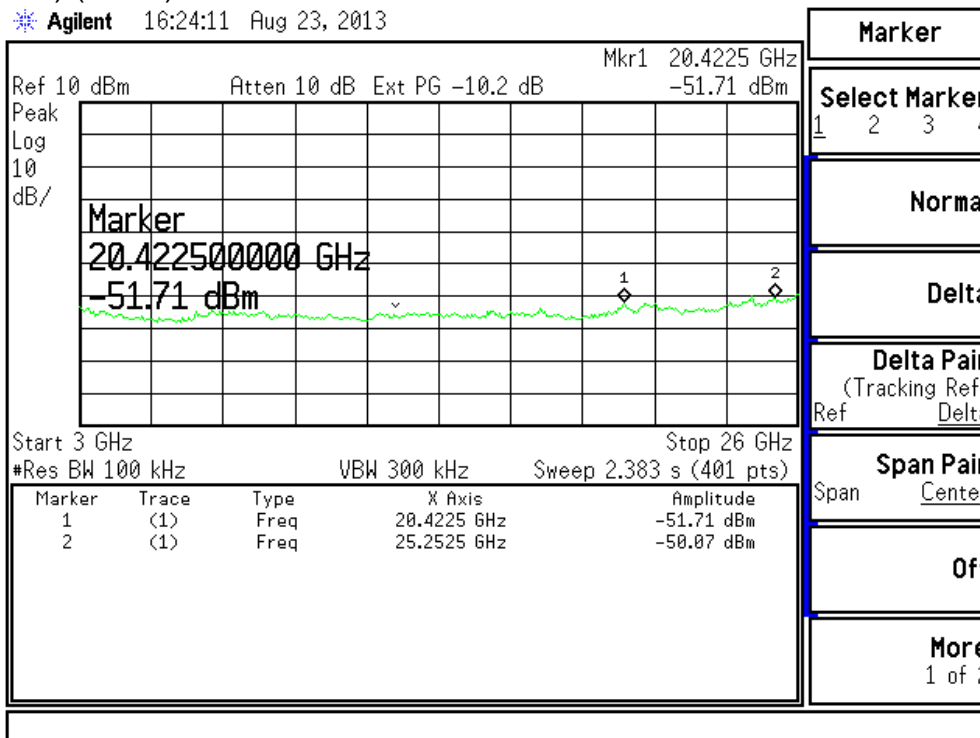

802.11b (CH06) (1 of 2)

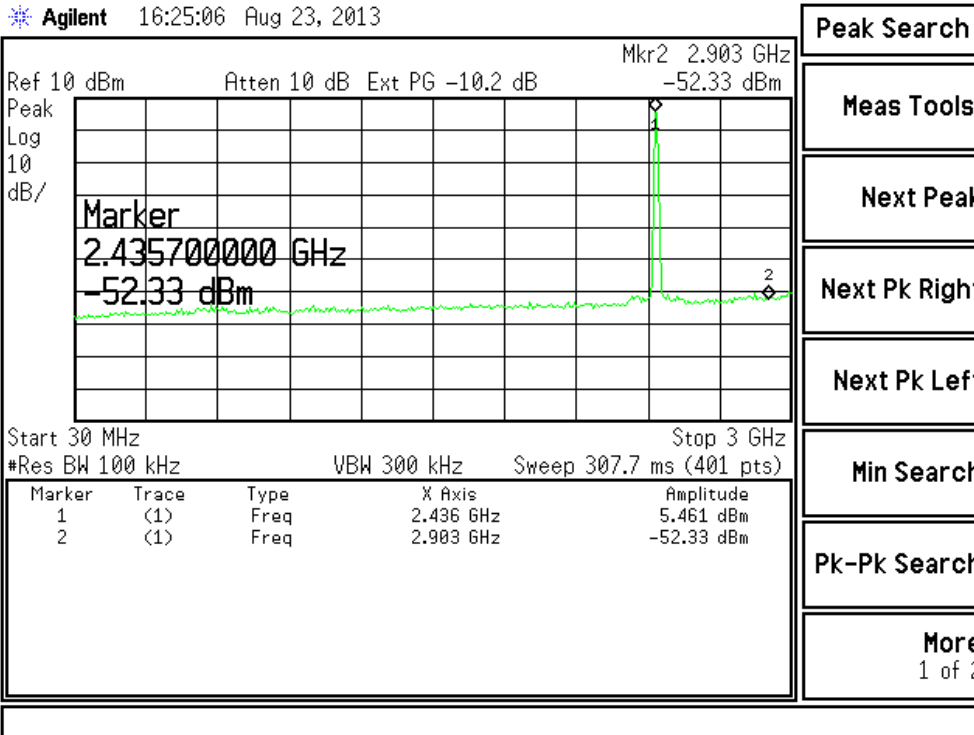

802.11b (CH06) (2 of 2)

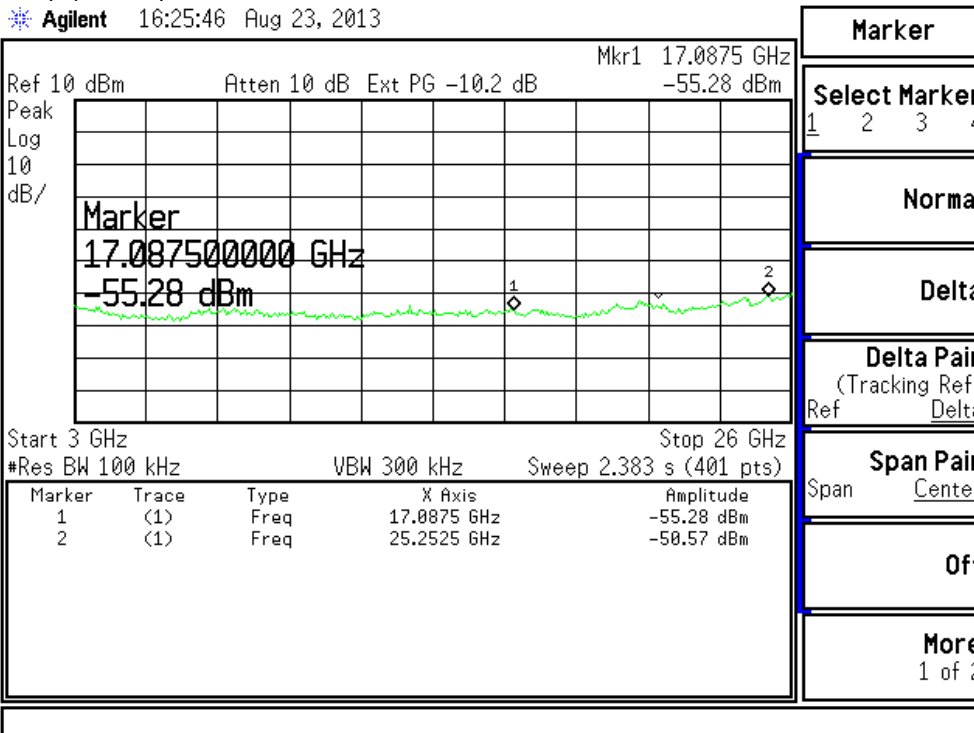

802.11b (CH11) (1 of 2)

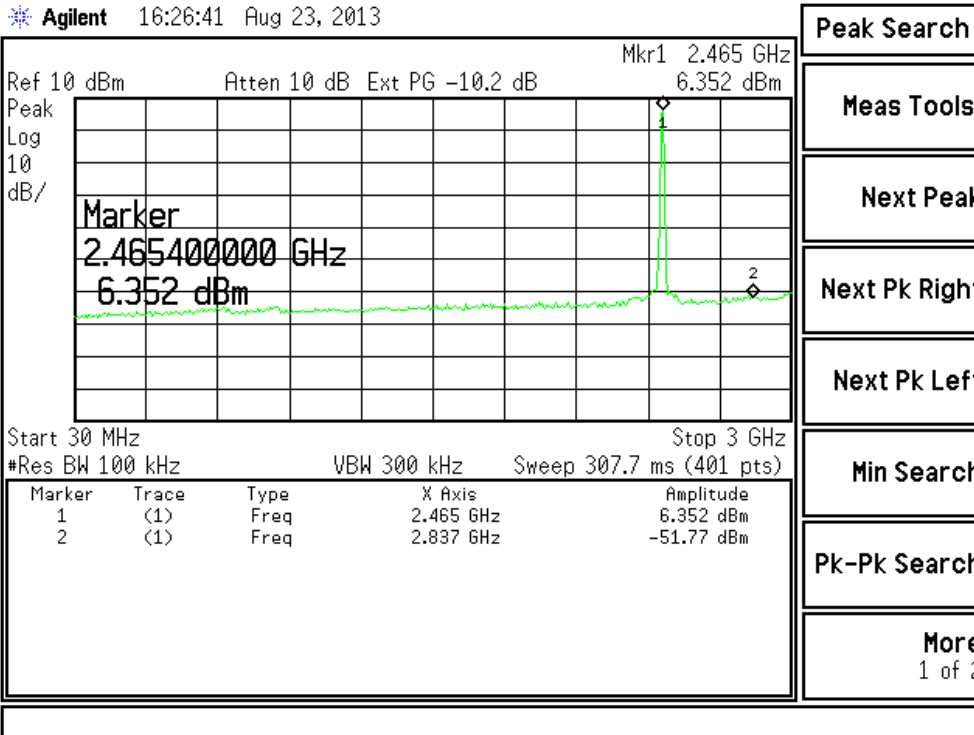

802.11b (CH11) (2 of 2)

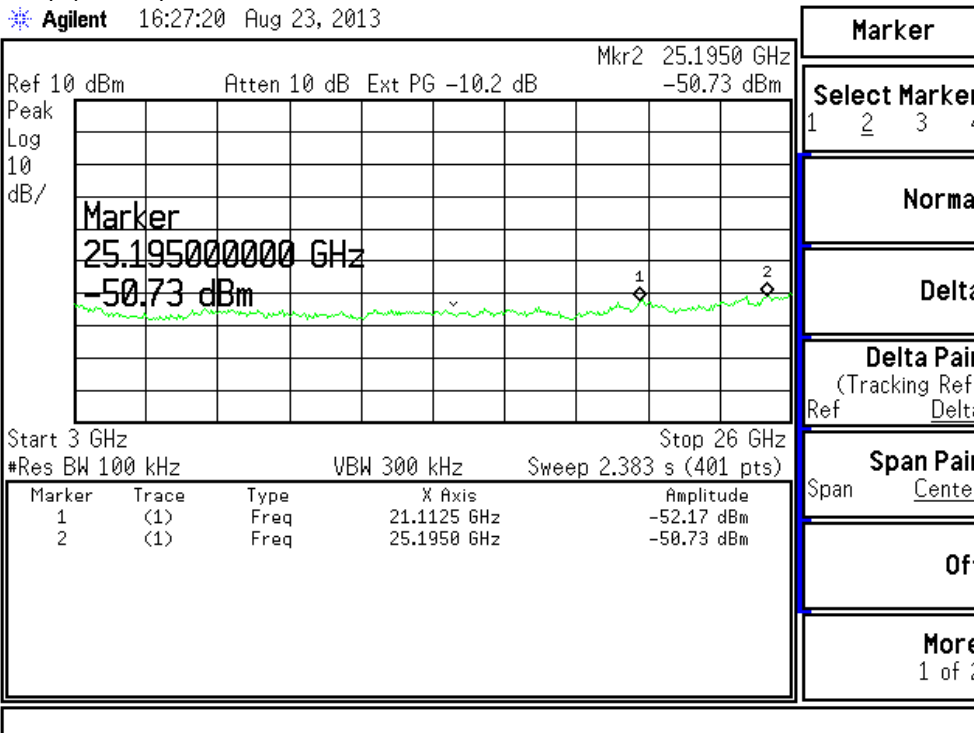

802.11g (CH01) (1 of 2)

Agilent 16:28:19 Aug 23, 2013

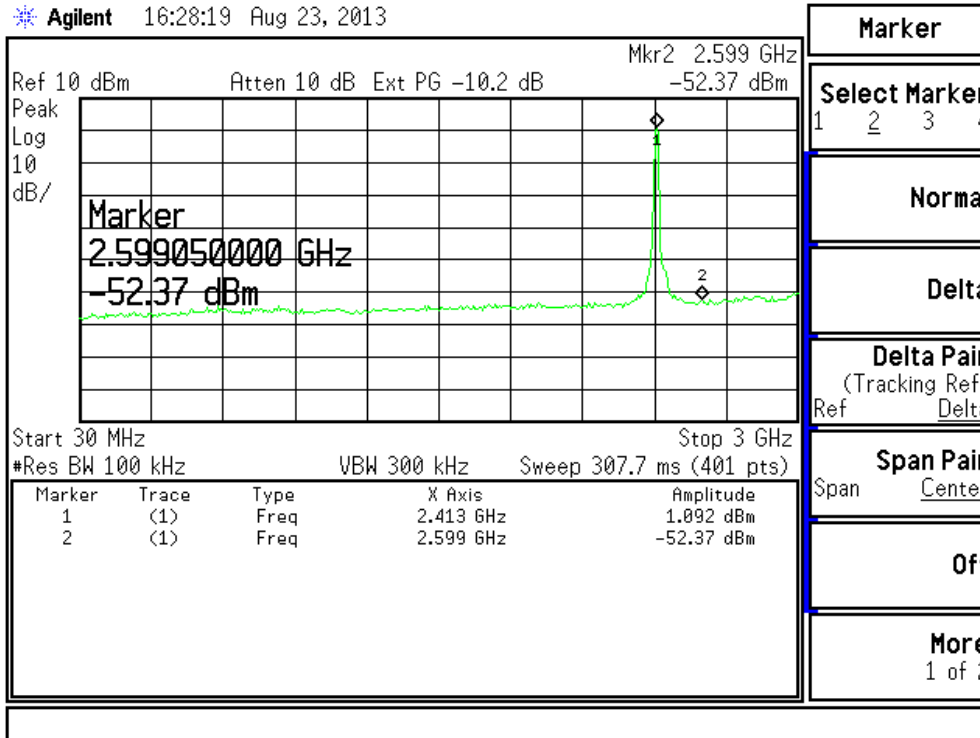

802.11g (CH01) (2 of 2)

Agilent 16:29:10 Aug 23, 2013

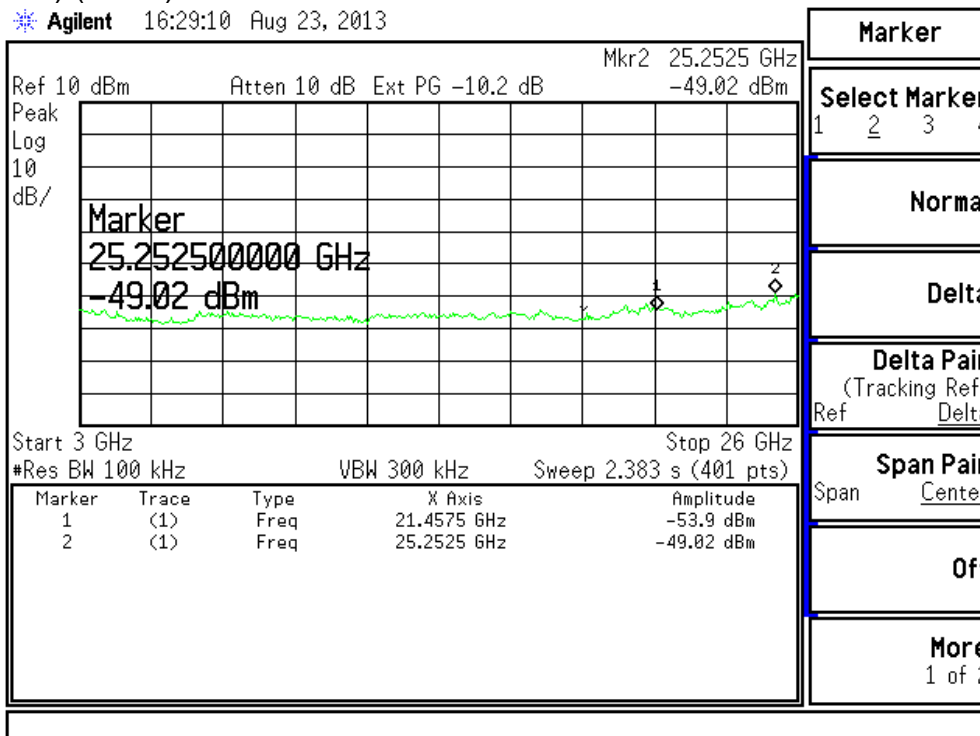

802.11g (CH06) (1 of 2)

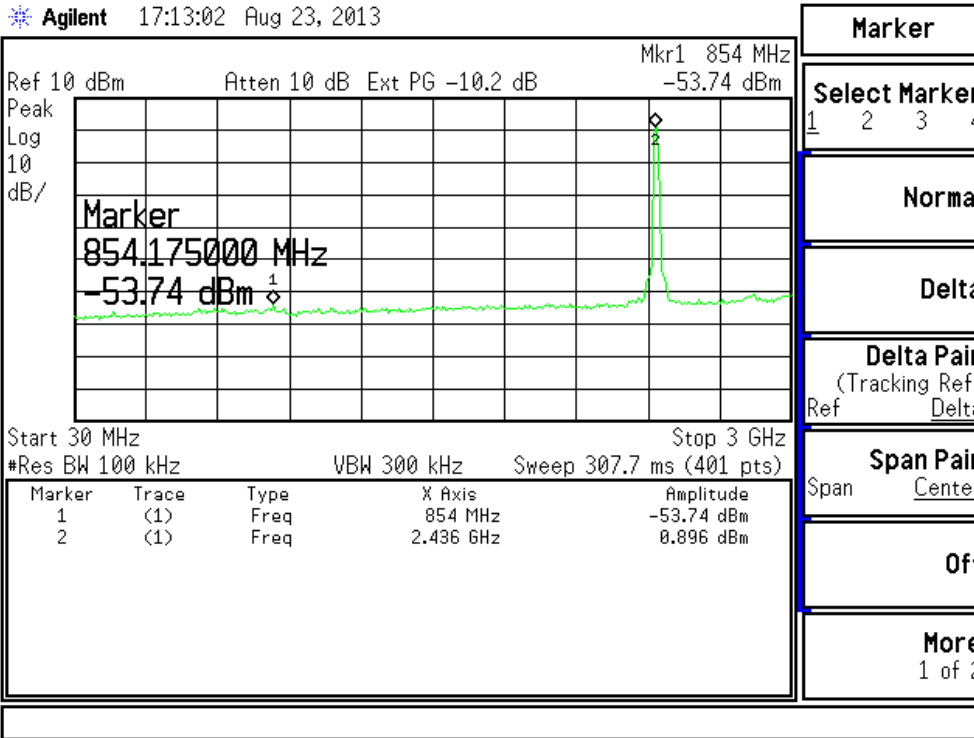

802.11g (CH06) (2 of 2)

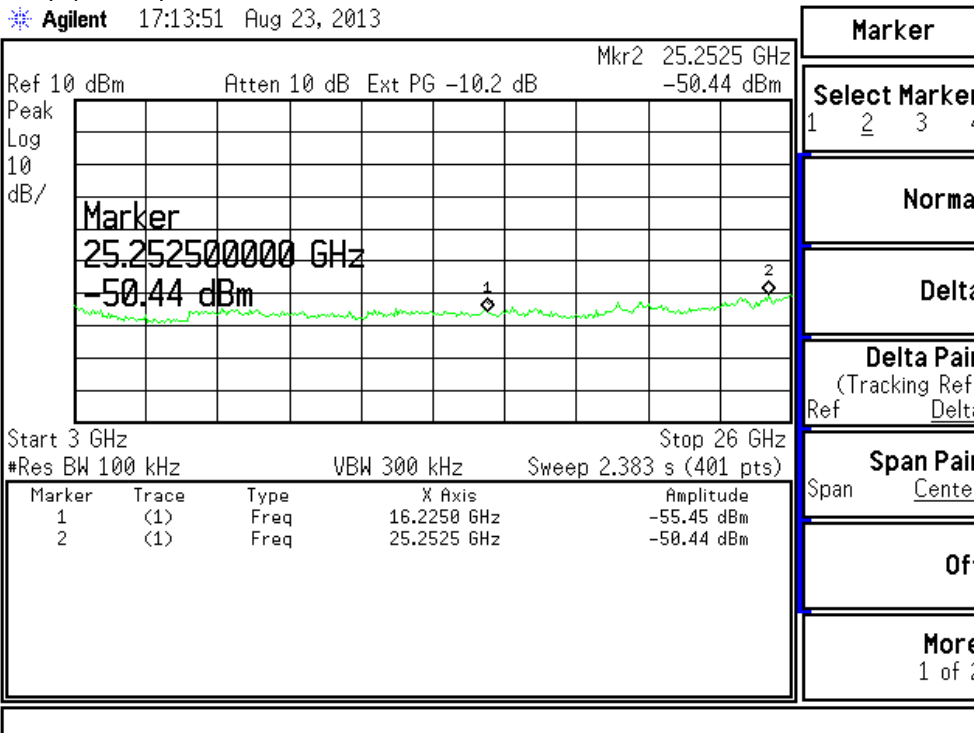

802.11g (CH11) (1 of 2)

Agilent 17:15:05 Aug 23, 2013

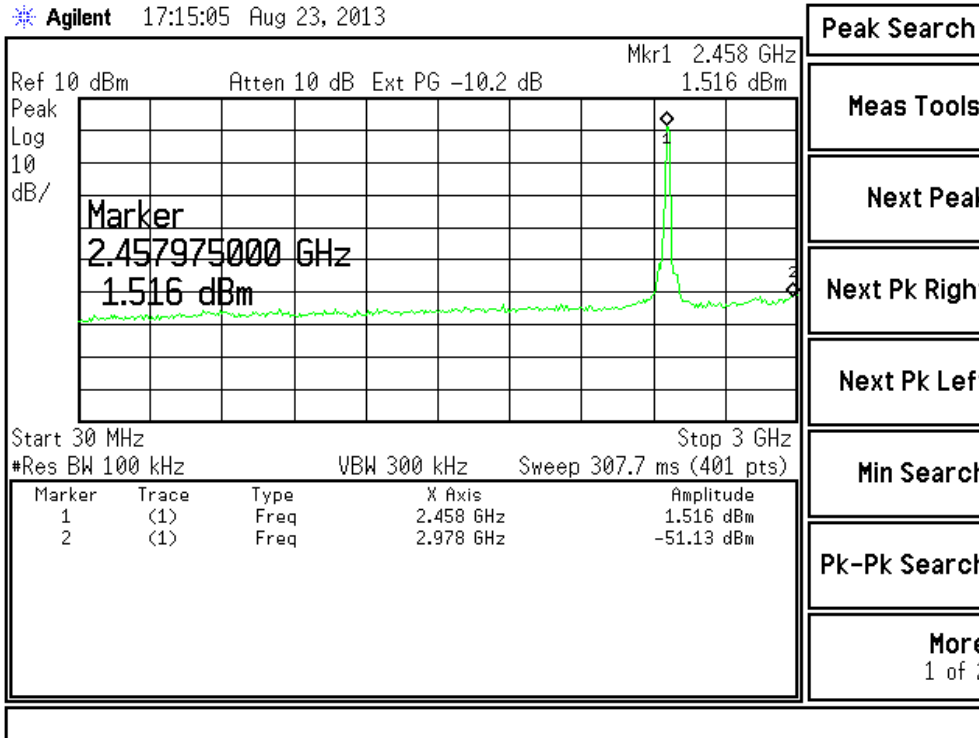

802.11g (CH11) (2 of 2)

Agilent 17:15:50 Aug 23, 2013

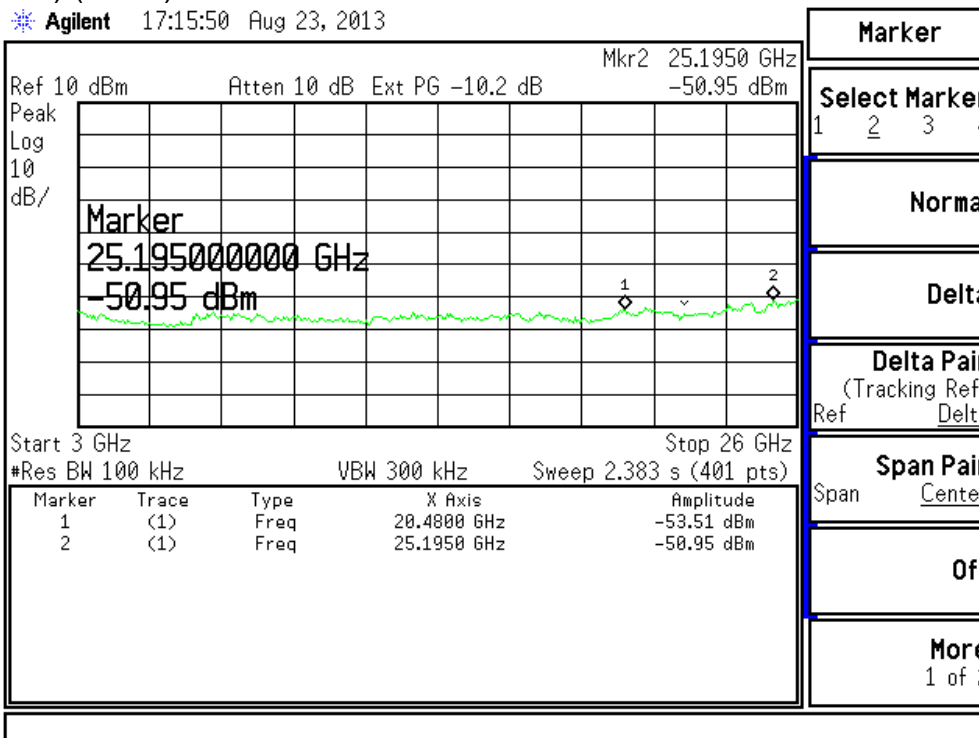

802.11n HT20 (Ant 1)(CH01) (1 of 2)

Agilent 17:16:58 Aug 23, 2013

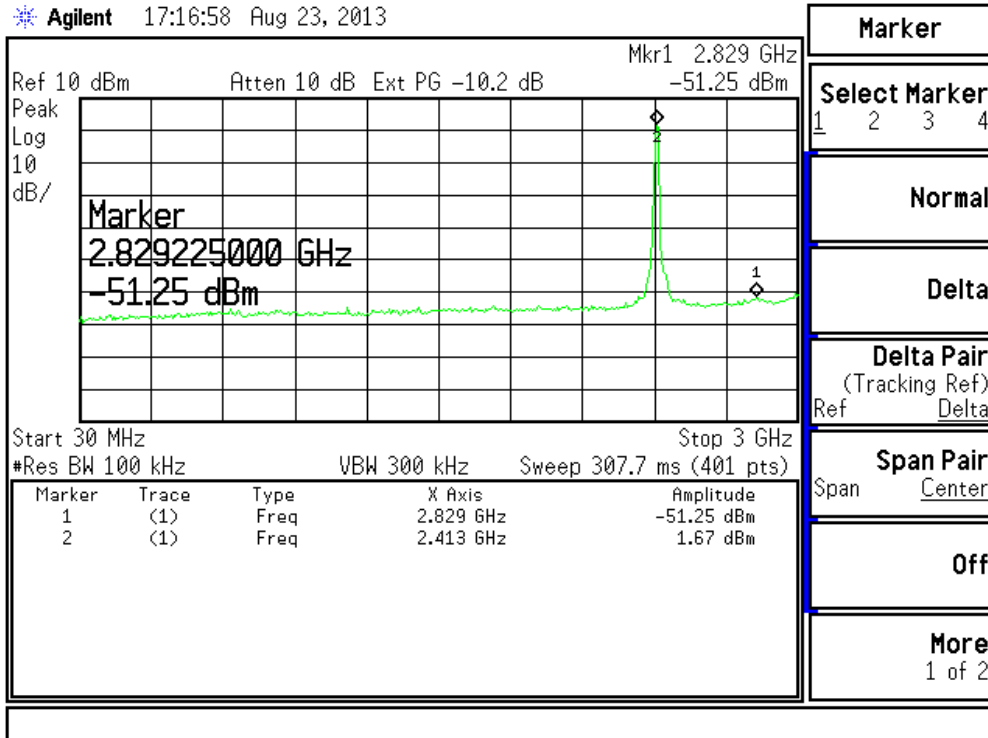

802.11n HT20 (Ant 1)(CH01) (2 of 2)

Agilent 17:17:40 Aug 23, 2013

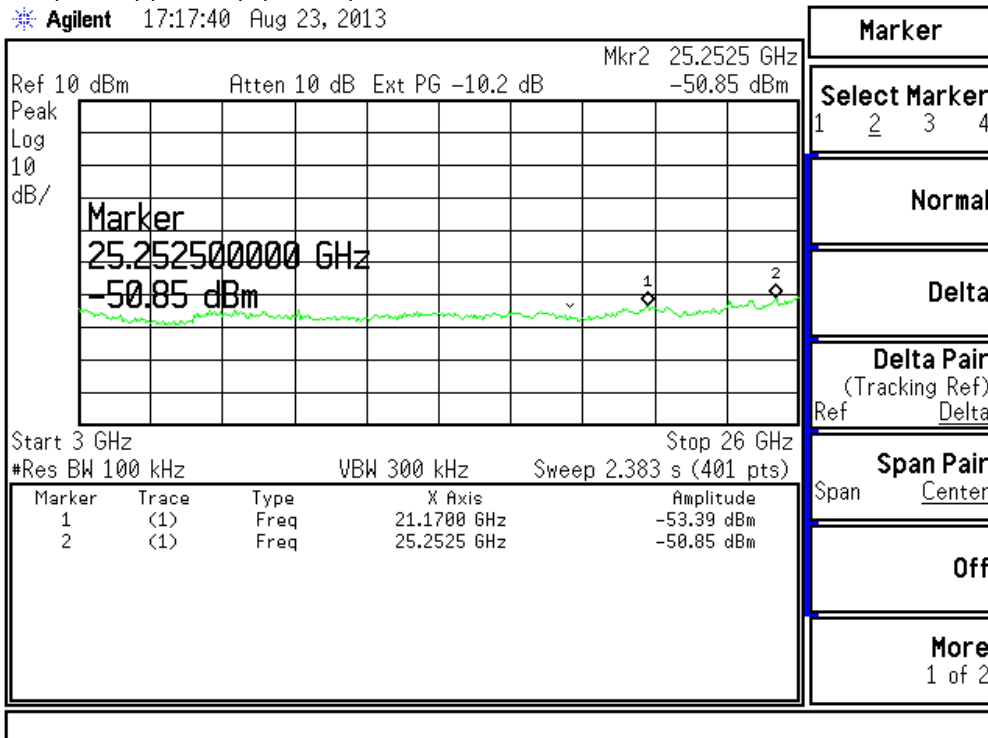

802.11n HT20 (Ant 1)(CH06) (1 of 2)

Agilent 17:21:46 Aug 23, 2013

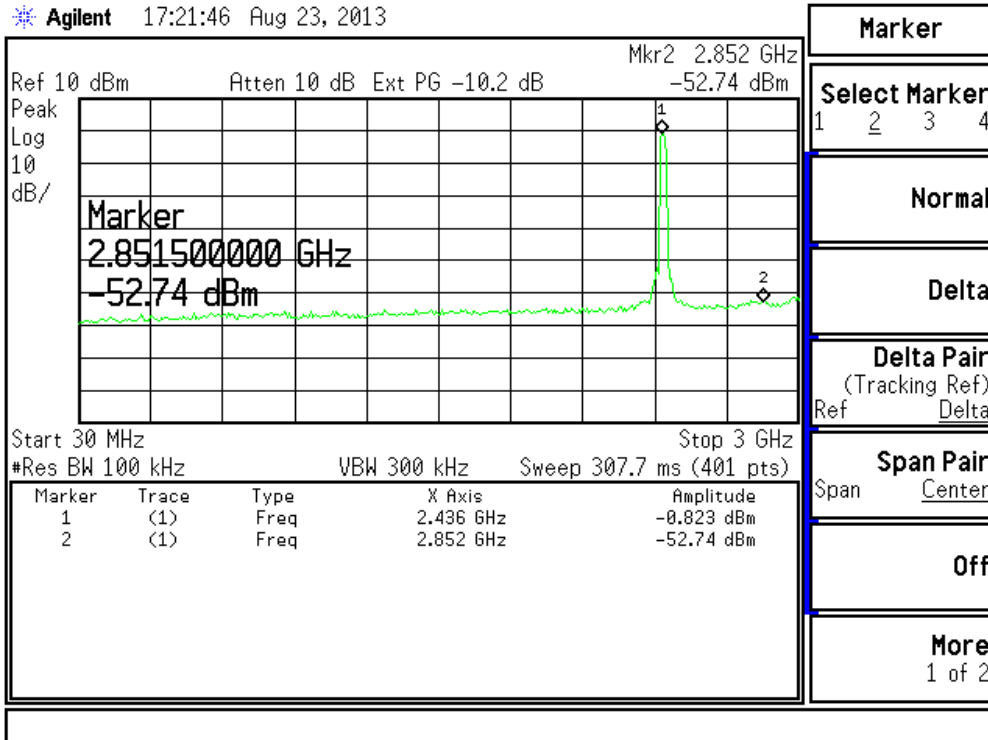

802.11n HT20 (Ant 1)(CH06) (2 of 2)

Agilent 17:21:13 Aug 23, 2013

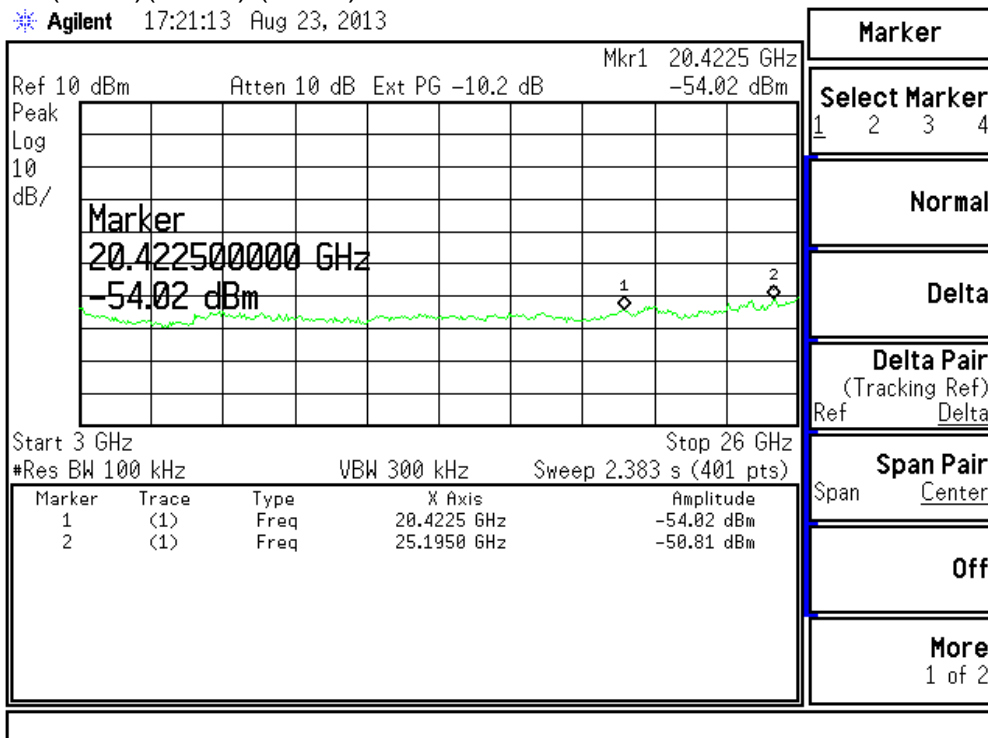

802.11n HT20 (Ant 1)(CH11) (1 of 2)

Agilent 17:22:42 Aug 23, 2013

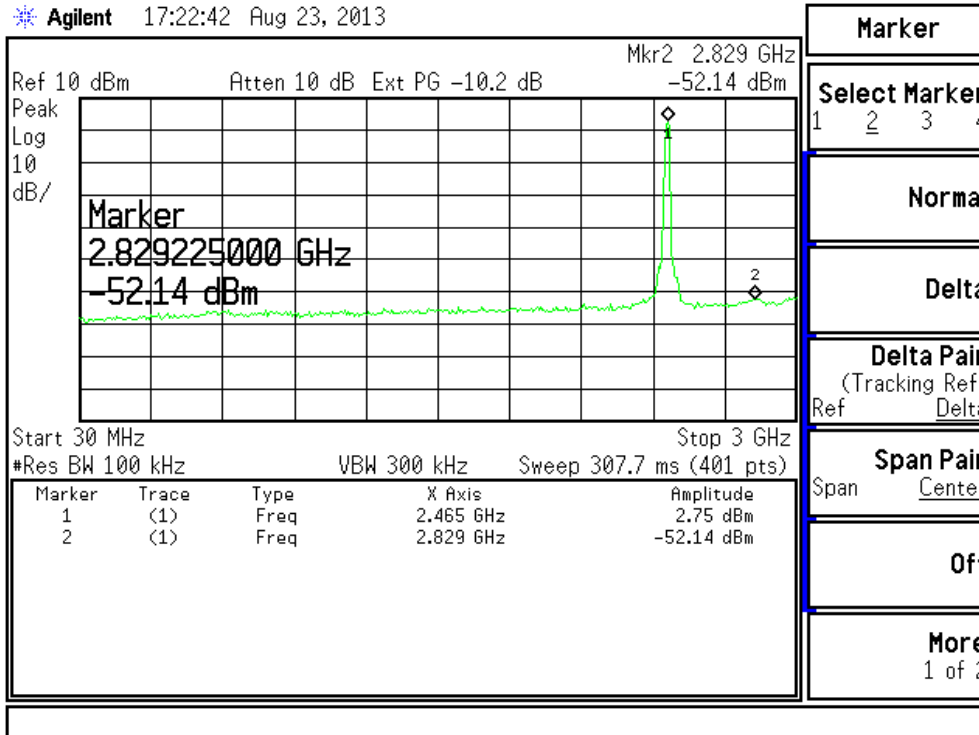

802.11n HT20 (Ant 1)(CH11) (2 of 2)

Agilent 17:23:25 Aug 23, 2013

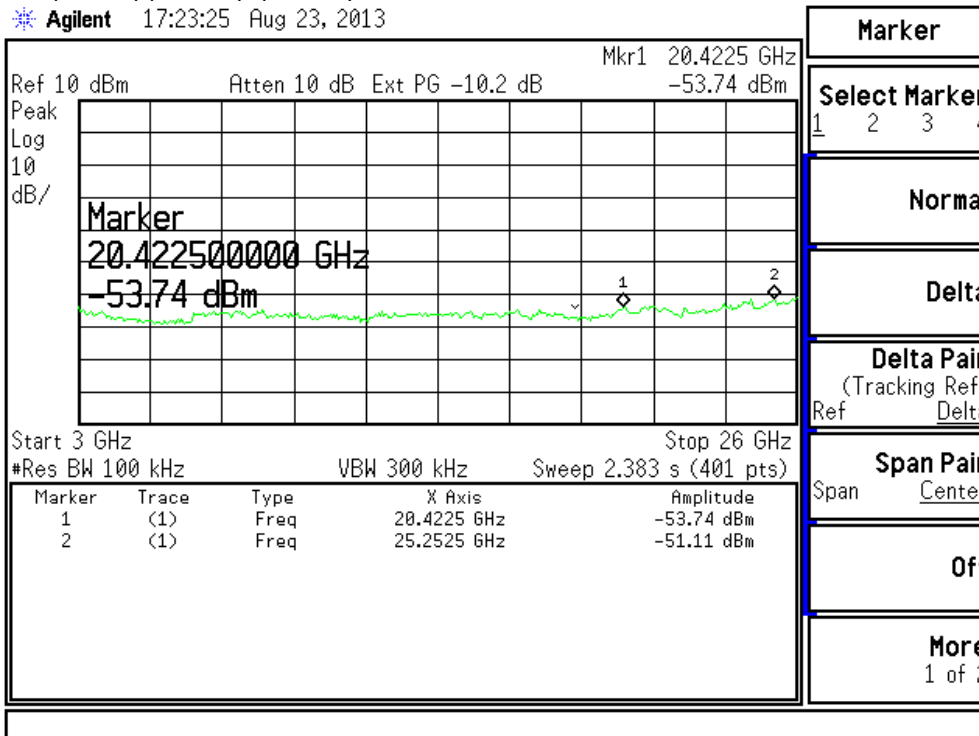

802.11n HT40 (Ant 1)(CH03) (1 of 2)

Agilent 17:31:48 Aug 23, 2013

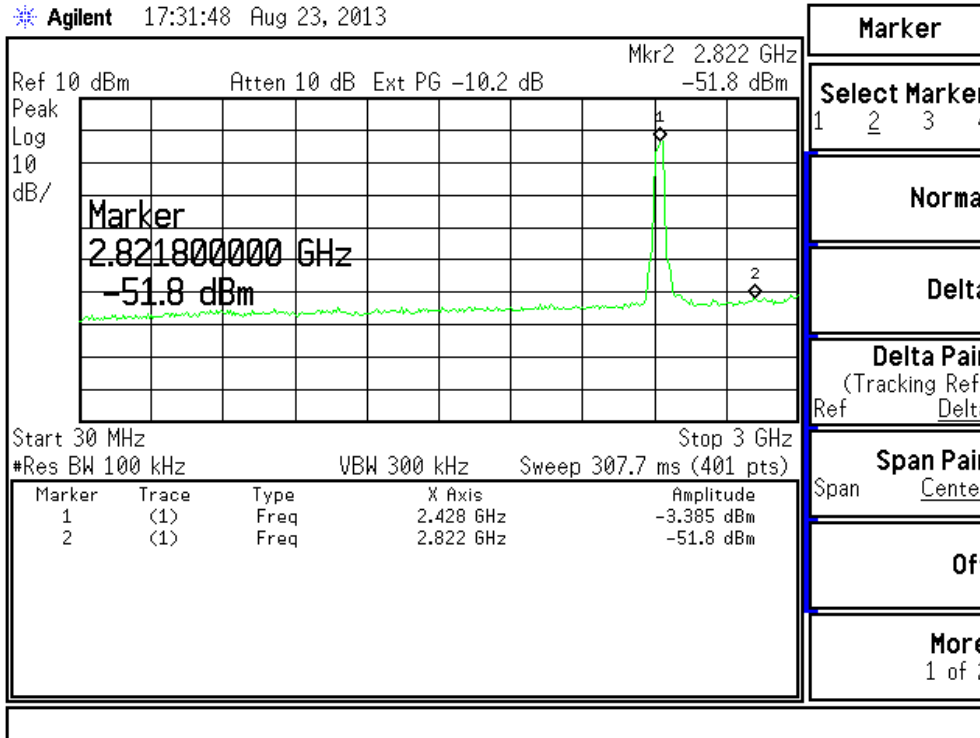

802.11n HT40 (Ant 1)(CH03) (2 of 2)

Agilent 17:30:42 Aug 23, 2013

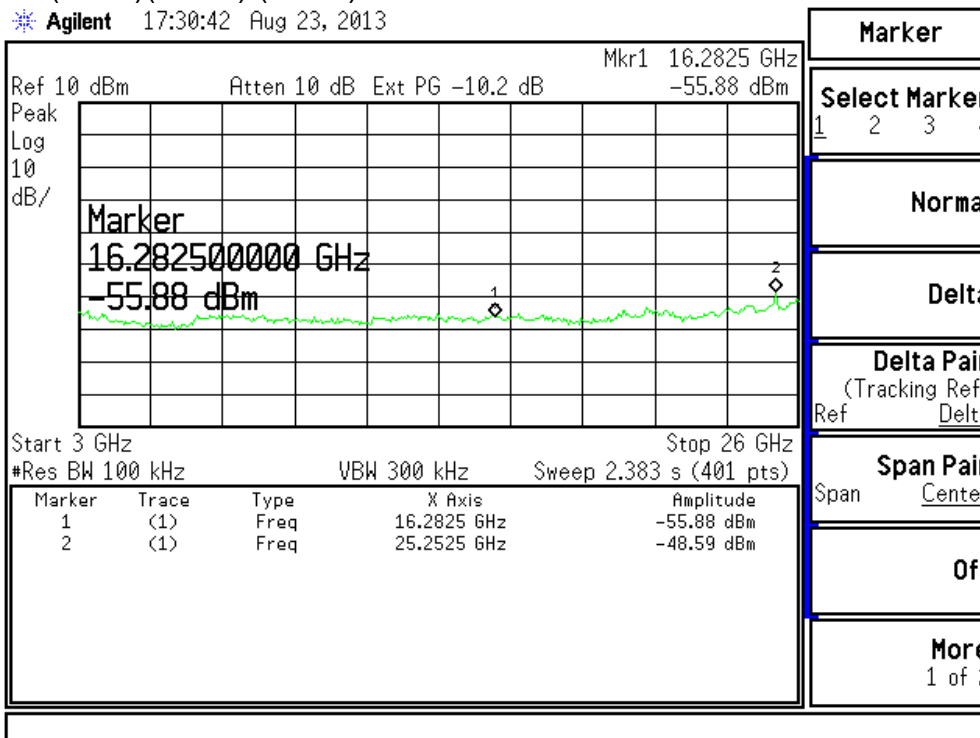

802.11n HT40 (Ant 1)(CH06) (1 of 2)

Agilent 17:32:51 Aug 23, 2013

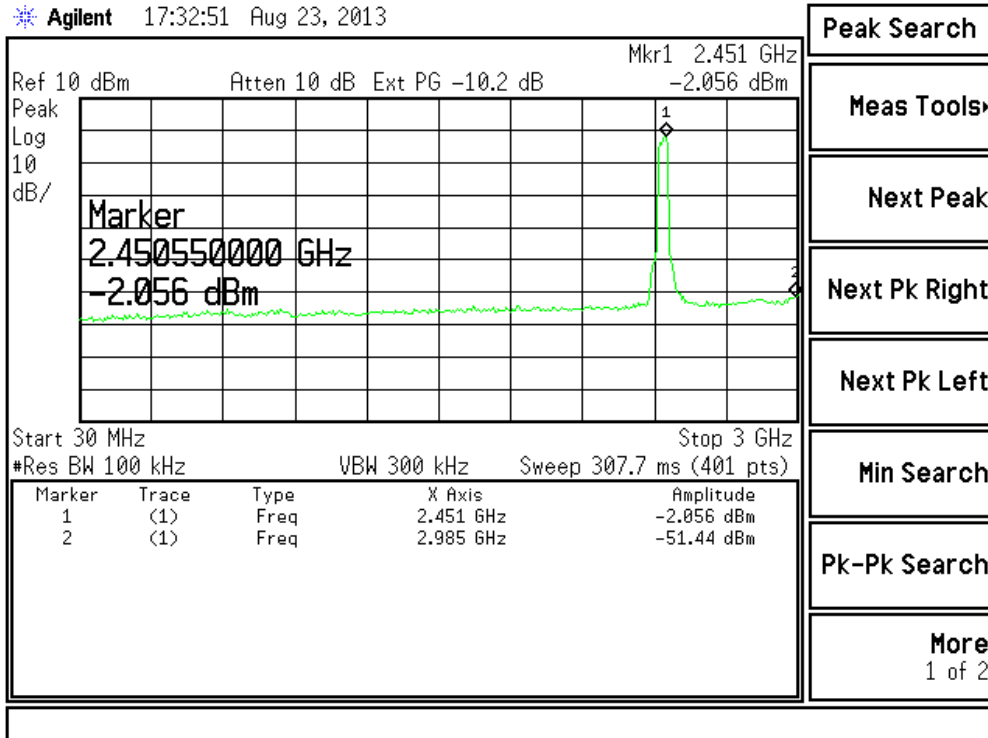

- Peak Search
- Meas Tools
- Next Peak
- Next Pk Right
- Next Pk Left
- Min Search
- Pk-Pk Search
- More
1 of 2

802.11n HT40 (Ant 1)(CH06) (2 of 2)

Agilent 17:33:31 Aug 23, 2013

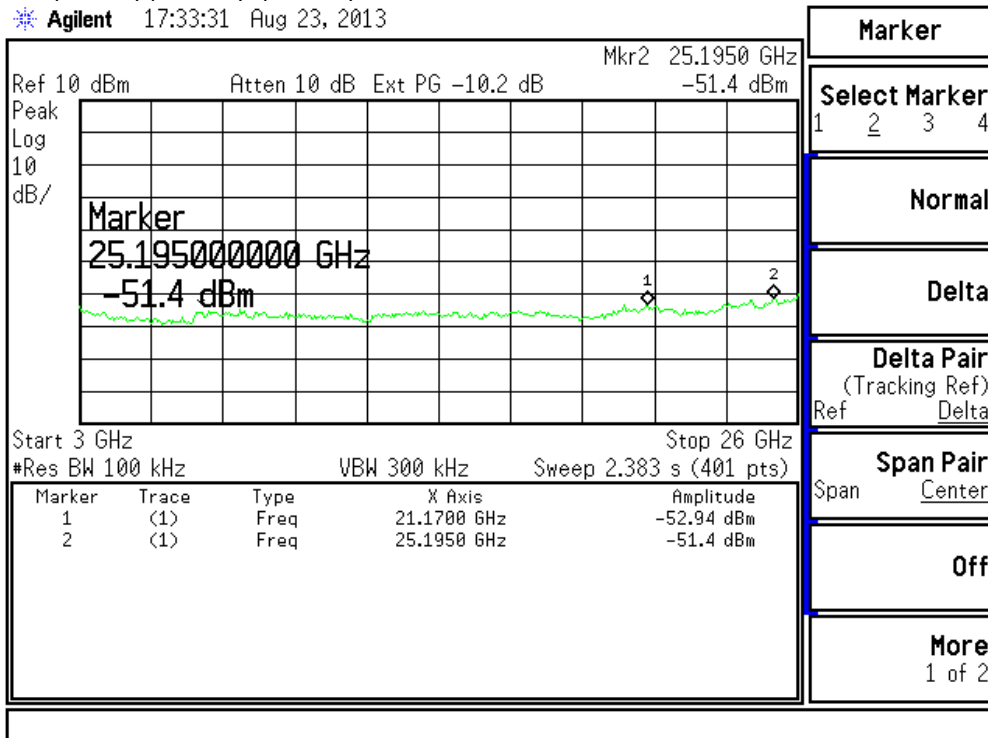

- Marker
- Select Marker
1 2 3 4
- Normal
- Delta
- Delta Pair
(Tracking Ref)
Ref Delta
- Span Pair
Span Center
- Off
- More
1 of 2

802.11n HT40 (Ant 1)(CH09) (1 of 2)

Agilent 17:37:57 Aug 23, 2013

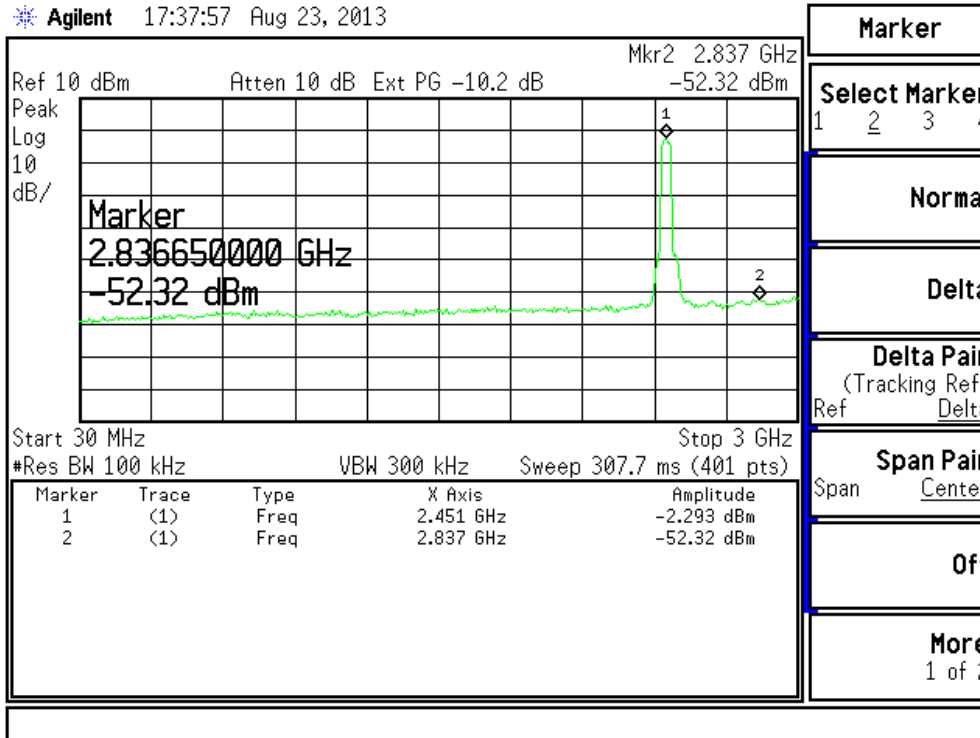

802.11n HT40 (Ant 1)(CH09) (2 of 2)

Agilent 17:37:20 Aug 23, 2013

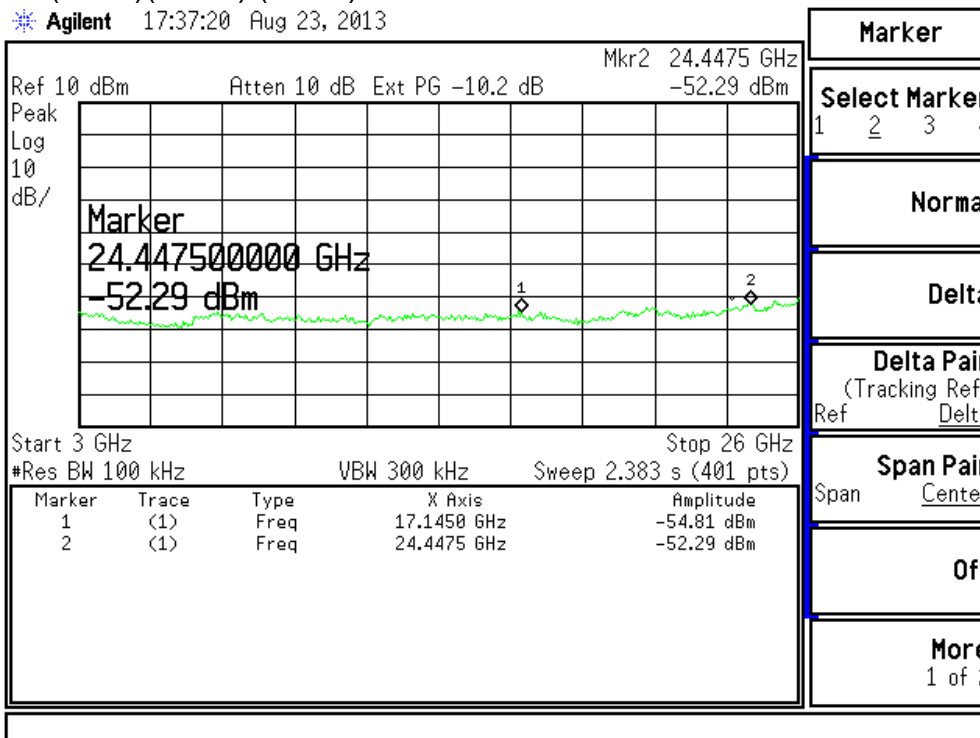

802.11n HT20 (Ant 2)(CH01) (1 of 2)

Agilent 17:18:48 Aug 23, 2013

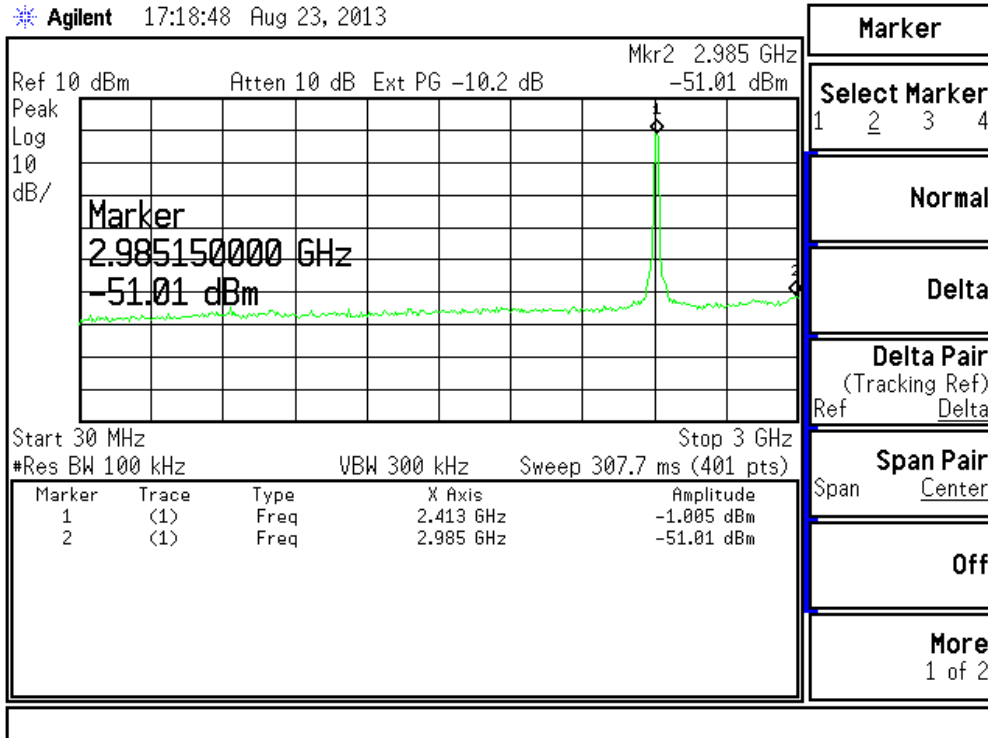

802.11n HT20 (Ant 2)(CH01) (2 of 2)

Agilent 17:18:13 Aug 23, 2013

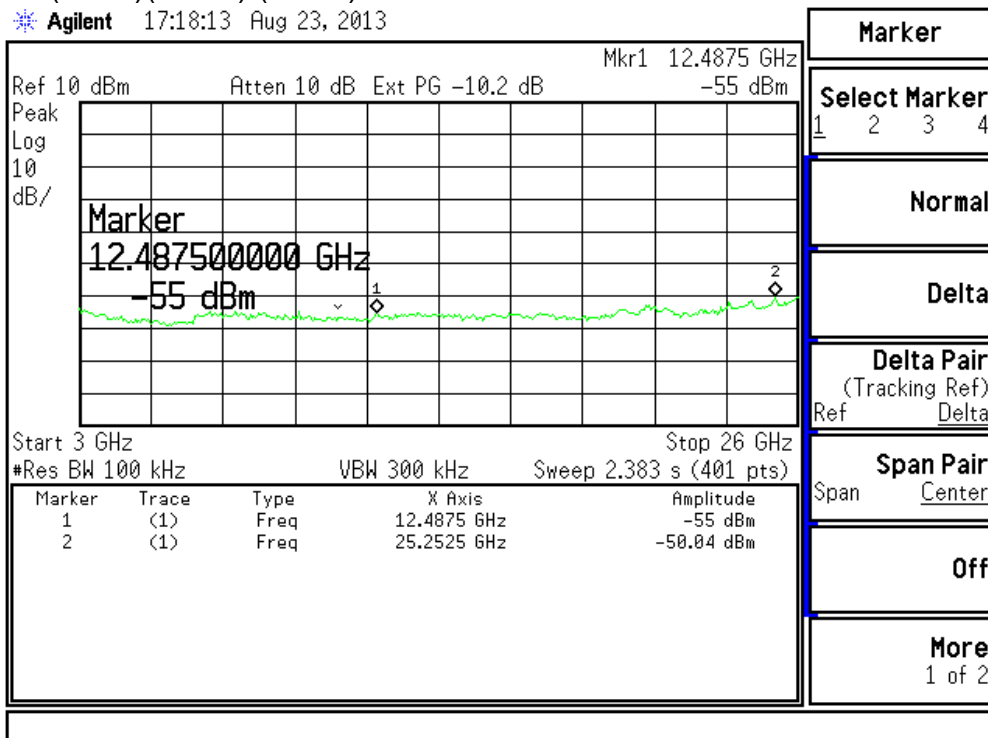

802.11n HT20 (Ant 2)(CH06) (1 of 2)

Agilent 17:19:59 Aug 23, 2013

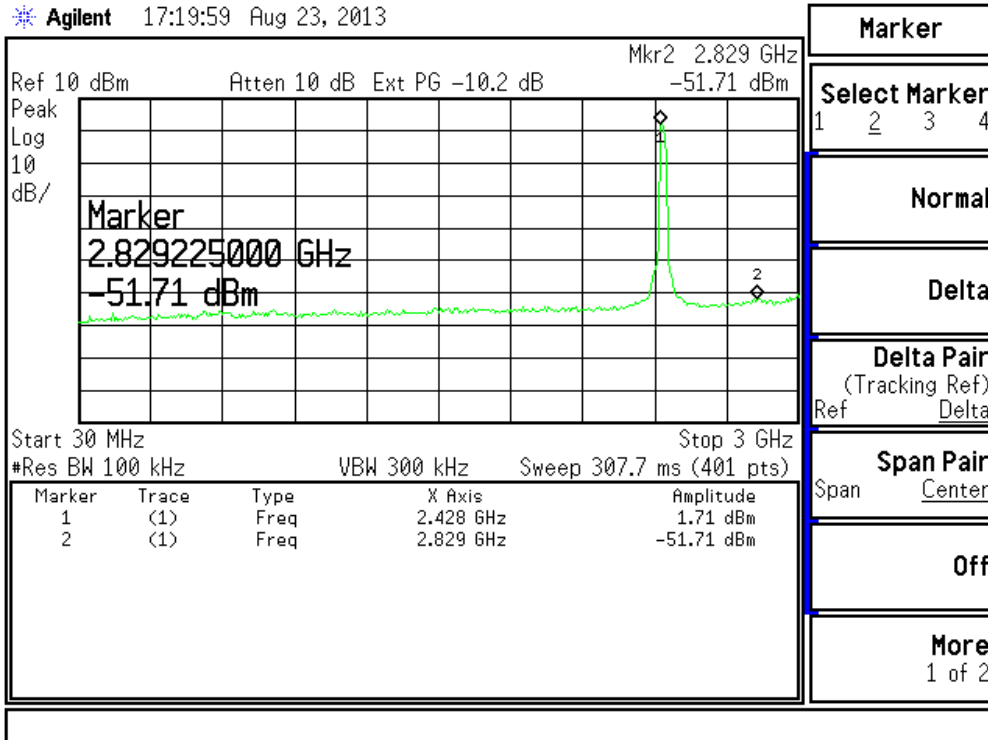

802.11n HT20 (Ant 2)(CH06) (2 of 2)

Agilent 17:20:37 Aug 23, 2013

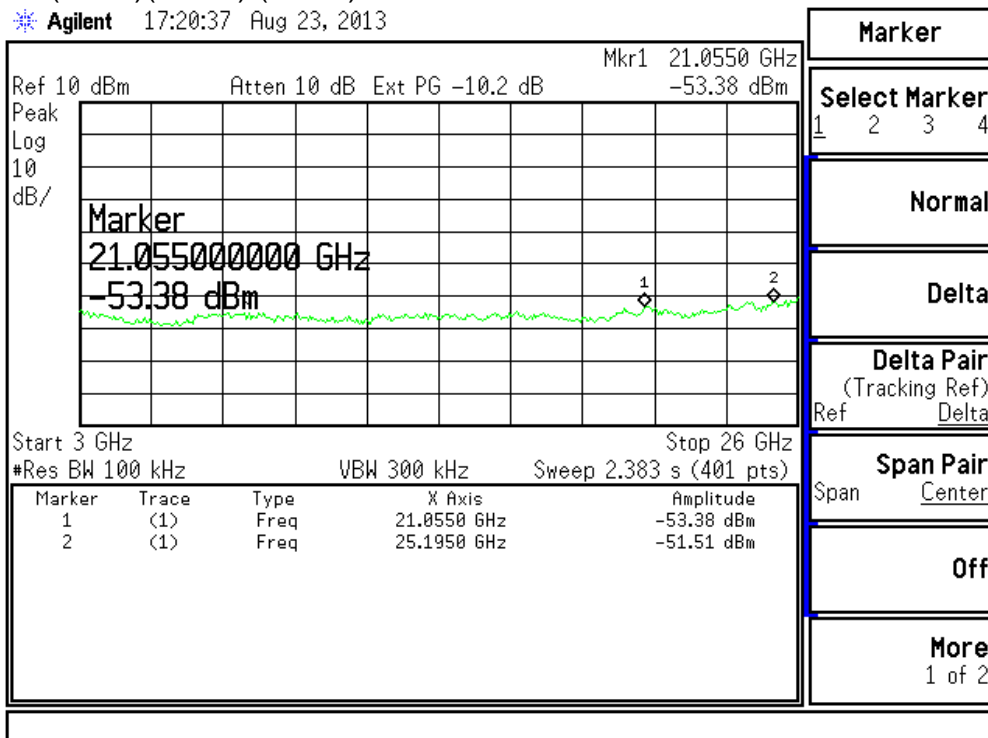

802.11n HT20 (Ant 2)(CH11) (1 of 2)

Agilent 17:24:53 Aug 23, 2013

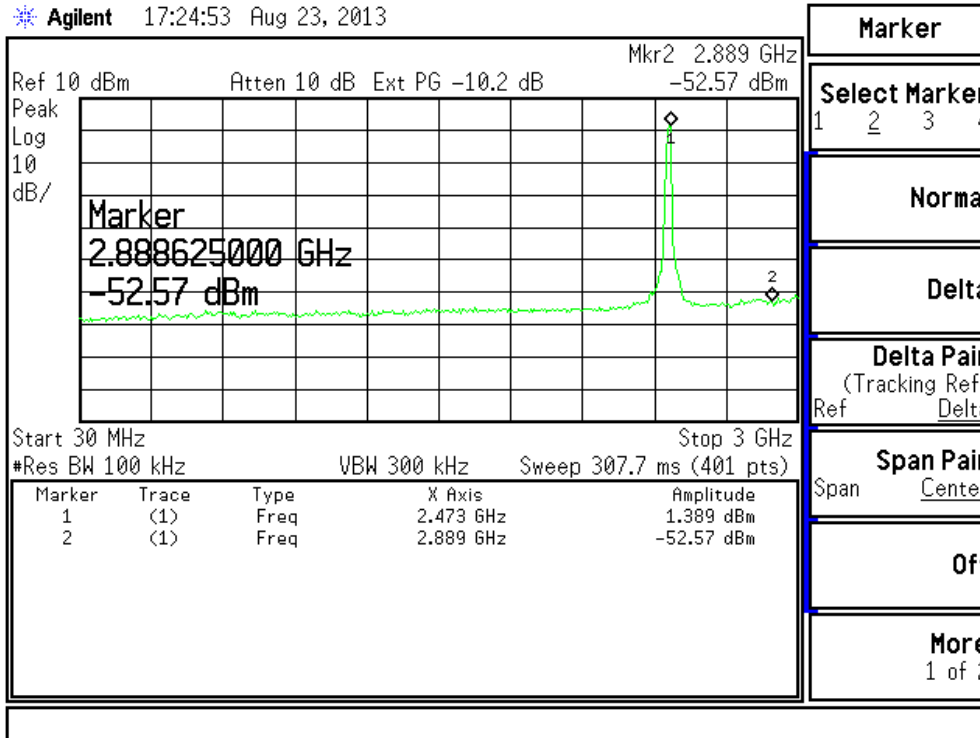

802.11n HT20 (Ant 2)(CH11) (2 of 2)

Agilent 17:24:02 Aug 23, 2013

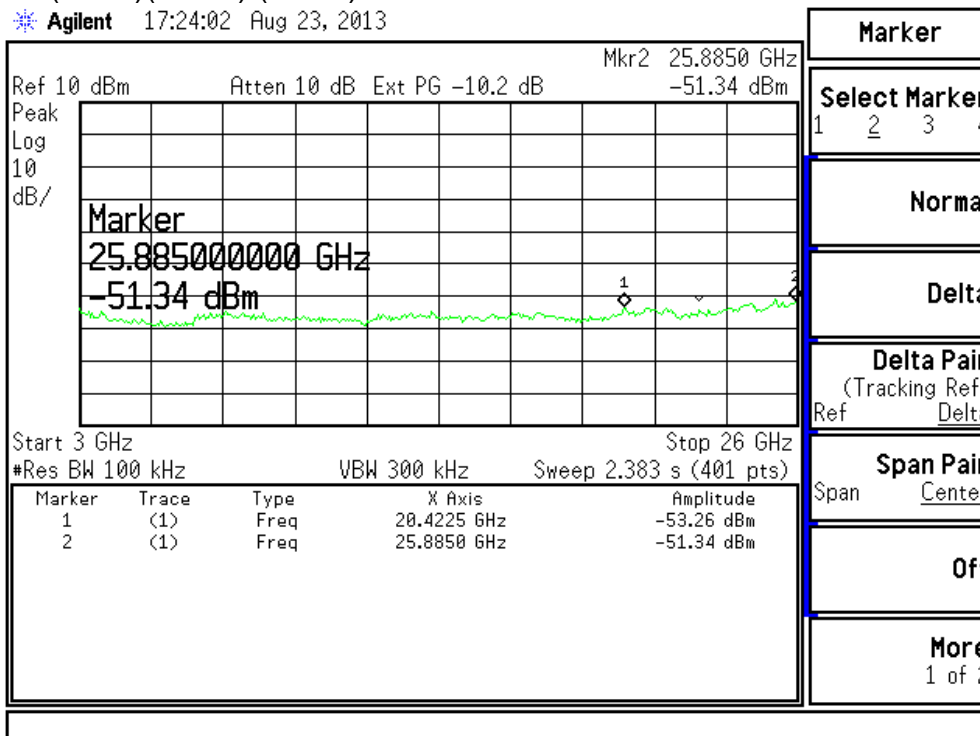

802.11n HT40 (Ant 2)(CH03) (1 of 2)

Agilent 17:29:25 Aug 23, 2013

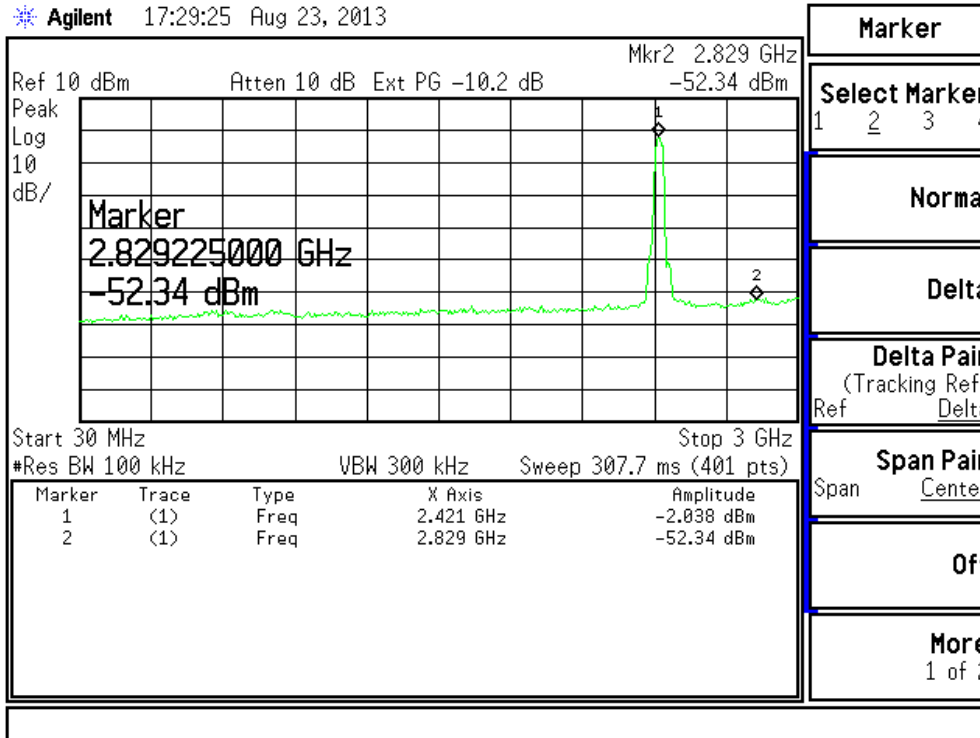

802.11n HT40 (Ant 2)(CH03) (2 of 2)

Agilent 17:30:12 Aug 23, 2013

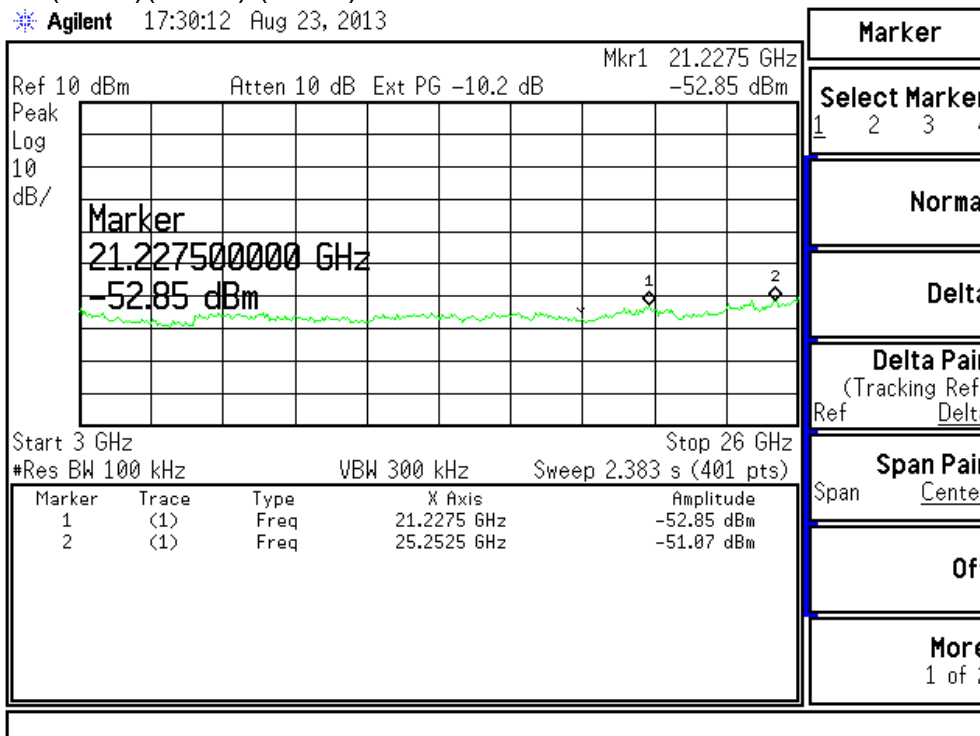

802.11n HT40 (Ant 2)(CH06) (1 of 2)

Agilent 17:35:08 Aug 23, 2013

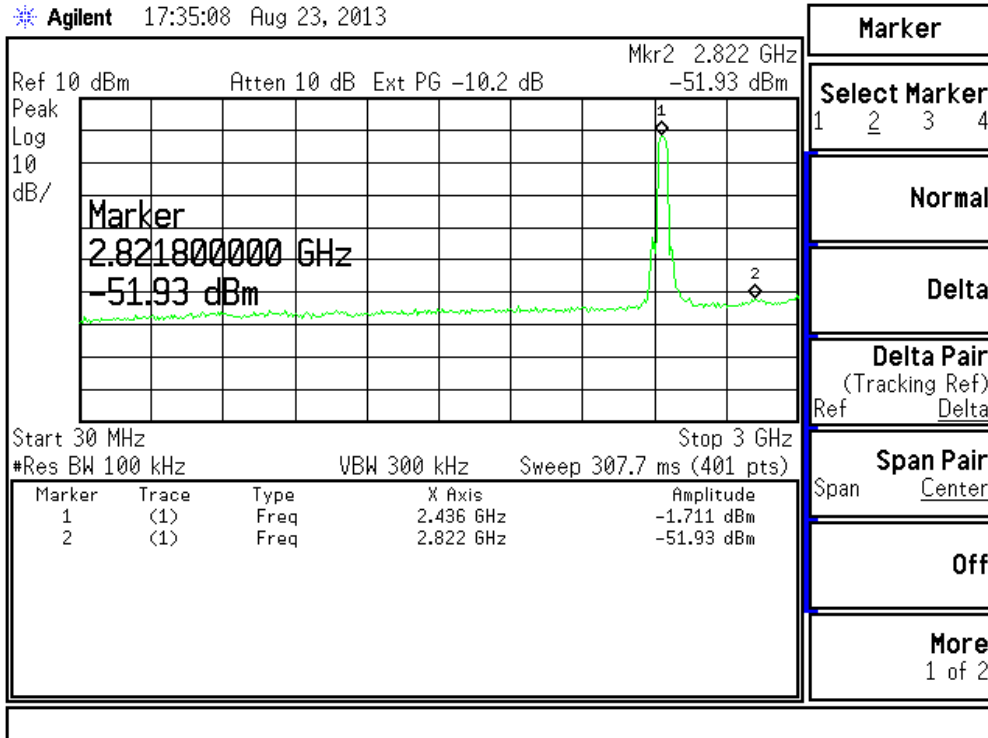

802.11n HT40 (Ant 2)(CH06) (2 of 2)

Agilent 17:34:19 Aug 23, 2013

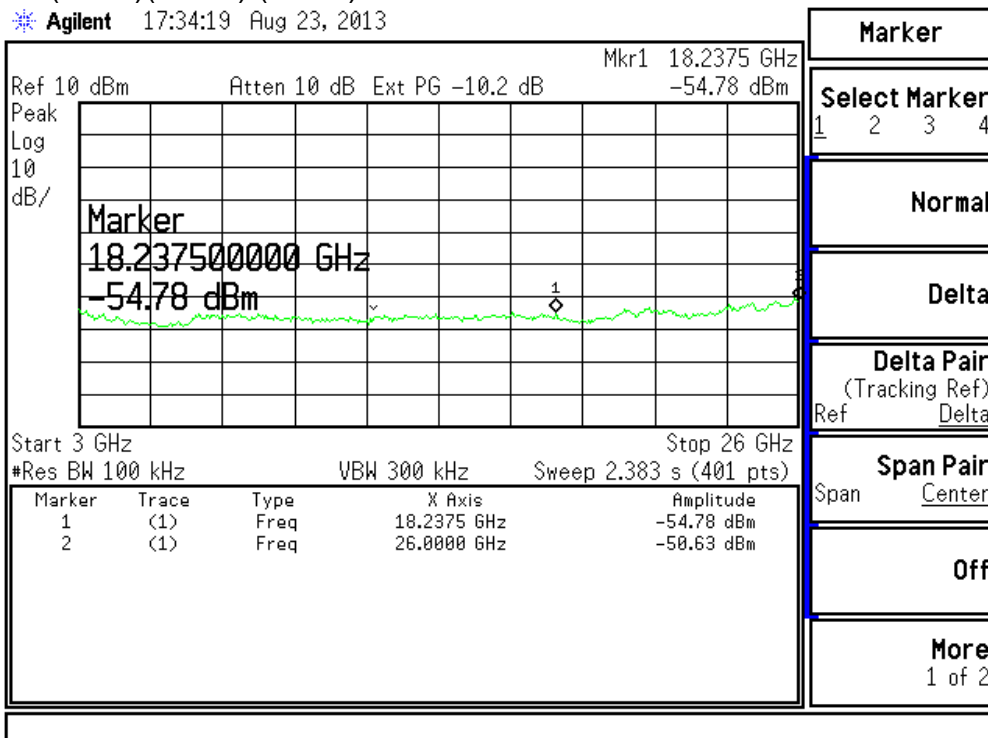

802.11n HT40 (Ant 2)(CH09) (1 of 2)

Agilent 17:35:56 Aug 23, 2013

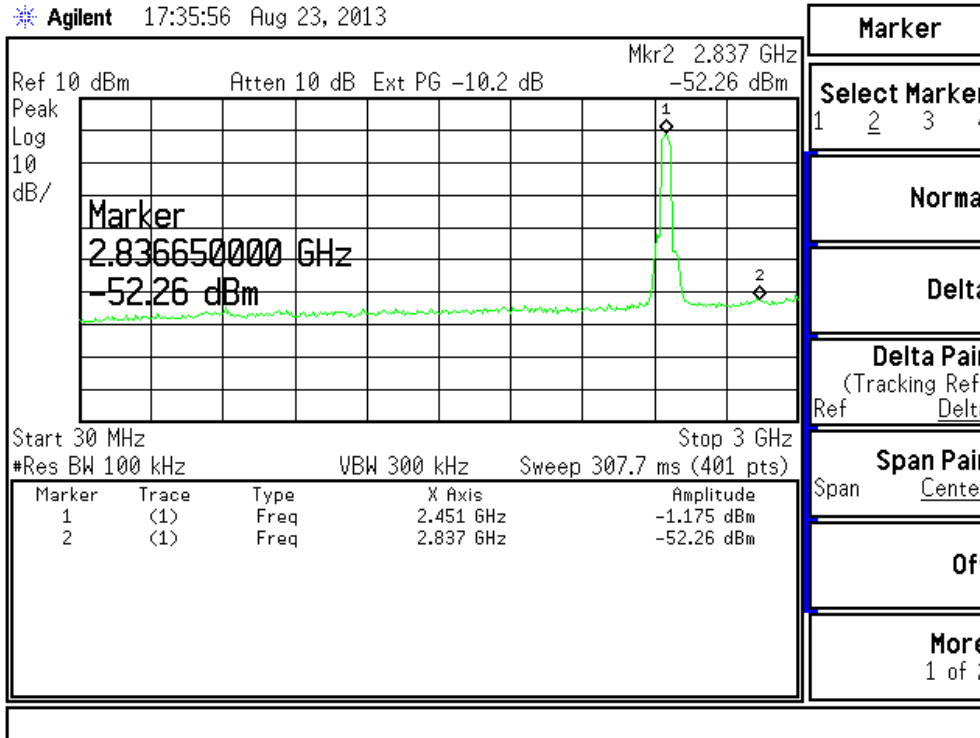

802.11n HT40 (Ant 2)(CH09) (2 of 2)

Agilent 17:36:37 Aug 23, 2013

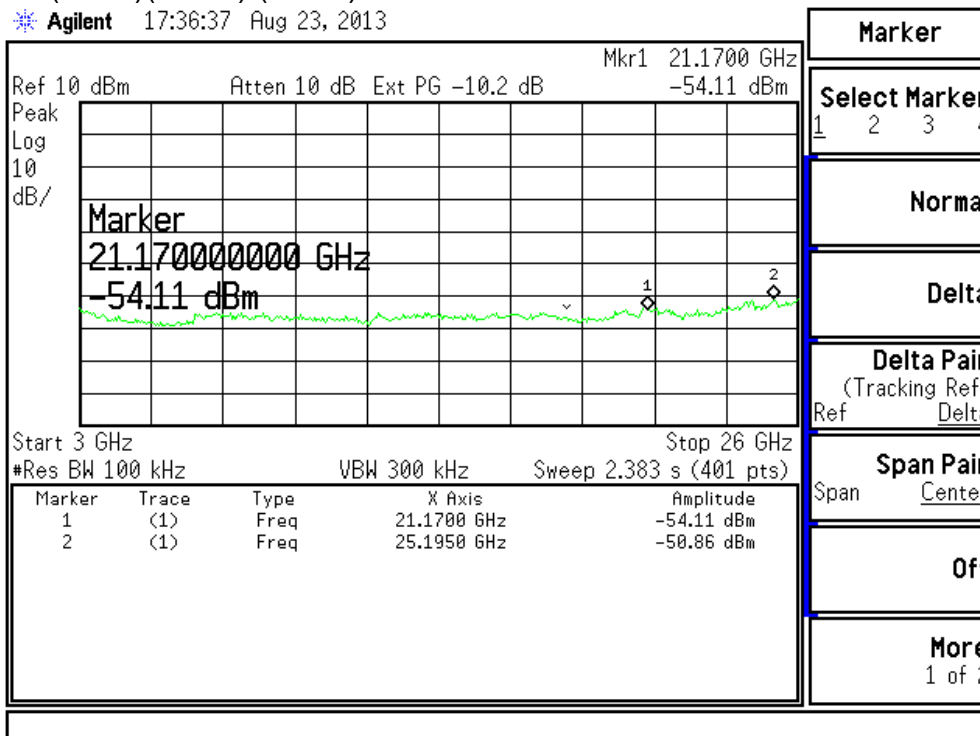

8. Band Edges Requirement

8.1 Test Condition & Setup :

According to 15.247(d), In any 100 kHz bandwidth outside the frequency band in which the spread spectrum or digitally modulated intentional radiator is operating, the radio frequency power that is produced by the intentional radiator shall be at least 20 dB below that in the 100 kHz bandwidth within the band that contains the highest level of the desired power, based on either an RF con-ducted or a radiated measurement, provided the transmitter demonstrates compliance with the peak conducted power limits.

Measurement procedure is followed KDB 558074 v03r01 (13.3.1 Peak Detection)

8.2 Test Instruments Configuration:

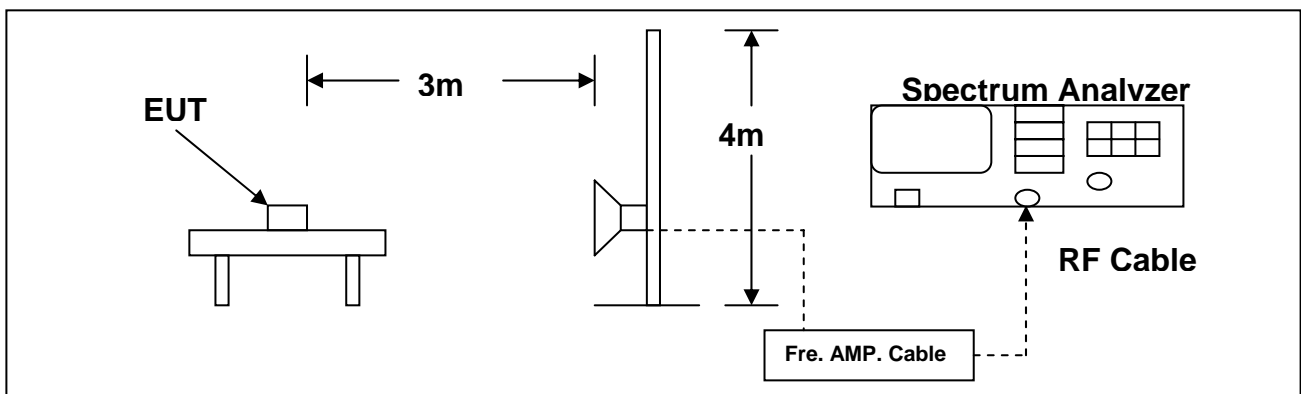

8.3 Test Equipment List:

Item	Mfr/Brand	Instruments	Serial No.	Model/Type No.	Calibrated Date	Next Cal. Date
1.	Agilent	Spectrum Analyzer	US39240419	E4407B	2013/01/29	2014/01/29
2.	MLT	Pre Amplifier	0.10~19.1GHz 60dBm	RF01	2013/08/23	2014/08/23
3.	MLT	Pre Amplifier	TA010-190-30	RF03	2013/07/16	2014/07/16
4.	MLT	Pre Amplifier	20110209	PREAMP6G-01	2013/03/01	2014/03/01
5.	SCHWARZBECK	Horn Antenna	181	BBHA 9170	2012/11/18	2013/11/18
6.	SCHWARZBECK	Horn Antenna	304	BBHA 9120D	2012/10/15	2013/10/15

8.4 Test Result : Worst case

(802.11b)

Radiated Emissions (HORIZONTAL) CH01						
Frequency (MHz)	Amplitude (dBuV/m)	Ant. (m)	Table (Degree)	Duty (dB)	Limit (dBuV/m)	Margin (dB)
2399.9	48.4 (PK)	1	127	0	74.0(PK)	-25.6
2399.9	37.4 (AV)	1	127	0	54.0(AV)	-16.6

Radiated Emissions (VERTICAL) CH01						
Frequency (MHz)	Amplitude (dBuV/m)	Ant. (m)	Table (Degree)	Duty (dB)	Limit (dBuV/m)	Margin (dB)
2399.8	55.5 (PK)	1	295	0	74.0(PK)	-18.5
2399.8	45.2 (AV)	1	295	0	54.0(AV)	-8.8

Radiated Emissions (HORIZONTAL) CH11						
Frequency (MHz)	Amplitude (dBuV/m)	Ant. (m)	Table (Degree)	Duty (dB)	Limit (dBuV/m)	Margin (dB)
2483.7	46.0 (PK)	1	162	0	74.0(PK)	-28.0
2483.7	38.8 (AV)	1	162	0	54.0(AV)	-15.2

Radiated Emissions (VERTICAL) CH11						
Frequency (MHz)	Amplitude (dBuV/m)	Ant. (m)	Table (Degree)	Duty (dB)	Limit (dBuV/m)	Margin (dB)
2484.1	48.8 (PK)	1	283	0	74.0(PK)	-25.2
2484.1	38.3 (AV)	1	283	0	54.0(AV)	-15.7

- Notes :**
1. Margin= Amplitude - Limits
 2. Height of table for EUT placed: 0.8 Meter.
 3. ANT= Antenna height.
 4. Duty= Duty cycle correction factor.
 5. Amplitude= Reading Amplitude – Amplifier gain+ Cable loss+ Antenna factor
(Auto calculate in spectrum analyzer)

(802.11g)

Radiated Emissions (HORIZONTAL) CH01						
Frequency (MHz)	Amplitude (dBuV/m)	Ant. (m)	Table (Degree)	Duty (dB)	Limit (dBuV/m)	Margin (dB)
2398.6	63.2 (PK)	1	23	0	74.0(PK)	-10.8
2398.6	39.6 (AV)	1	23	0	54.0(AV)	-14.4

Radiated Emissions (VERTICAL) CH01						
Frequency (MHz)	Amplitude (dBuV/m)	Ant. (m)	Table (Degree)	Duty (dB)	Limit (dBuV/m)	Margin (dB)
2399.7	72.6 (PK)	1	305	0	74.0(PK)	-1.4
2399.7	49.1 (AV)	1	305	0	54.0(AV)	-5.0

Radiated Emissions (HORIZONTAL) CH11						
Frequency (MHz)	Amplitude (dBuV/m)	Ant. (m)	Table (Degree)	Duty (dB)	Limit (dBuV/m)	Margin (dB)
2484.1	50.0 (PK)	1	155	0	74.0(PK)	-24.0
2484.1	37.6 (AV)	1	155	0	54.0(AV)	-16.4

Radiated Emissions (VERTICAL) CH11						
Frequency (MHz)	Amplitude (dBuV/m)	Ant. (m)	Table (Degree)	Duty (dB)	Limit (dBuV/m)	Margin (dB)
2483.7	65.7 (PK)	1	285	0	74.0(PK)	-8.3
2483.7	45.4 (AV)	1	285	0	54.0(AV)	-8.6

- Notes :**
1. Margin= Amplitude - Limits
 2. Height of table for EUT placed: 0.8 Meter.
 3. ANT= Antenna height.
 4. Duty= Duty cycle correction factor.
 5. Amplitude= Reading Amplitude – Amplifier gain+ Cable loss+ Antenna factor
(Auto calculate in spectrum analyzer)

(802.11n HT20)

Radiated Emissions (HORIZONTAL) CH01						
Frequency (MHz)	Amplitude (dBuV/m)	Ant. (m)	Table (Degree)	Duty (dB)	Limit (dBuV/m)	Margin (dB)
2399.9	61.1 (PK)	1	351	0	74.0(PK)	-12.9
2399.9	40.5 (AV)	1	351	0	54.0(AV)	-13.5

Radiated Emissions (VERTICAL) CH01						
Frequency (MHz)	Amplitude (dBuV/m)	Ant. (m)	Table (Degree)	Duty (dB)	Limit (dBuV/m)	Margin (dB)
2399.6	72.7 (PK)	1	290	0	74.0(PK)	-1.3
2399.6	48.2 (AV)	1	290	0	54.0(AV)	-5.8

Radiated Emissions (HORIZONTAL) CH11						
Frequency (MHz)	Amplitude (dBuV/m)	Ant. (m)	Table (Degree)	Duty (dB)	Limit (dBuV/m)	Margin (dB)
2485.1	54.6 (PK)	1	355	0	74.0(PK)	-19.4
2485.1	37.9 (AV)	1	355	0	54.0(AV)	-16.1

Radiated Emissions (VERTICAL) CH11						
Frequency (MHz)	Amplitude (dBuV/m)	Ant. (m)	Table (Degree)	Duty (dB)	Limit (dBuV/m)	Margin (dB)
2484.9	63.3 (PK)	1	281	0	74.0(PK)	-10.8
2484.9	46.1 (AV)	1	281	0	54.0(AV)	-7.9

- Notes :**
1. Margin= Amplitude - Limits
 2. Height of table for EUT placed: 0.8 Meter.
 3. ANT= Antenna height.
 4. Duty= Duty cycle correction factor.
 5. Amplitude= Reading Amplitude – Amplifier gain+ Cable loss+ Antenna factor
(Auto calculate in spectrum analyzer)

(802.11n HT40)

Radiated Emissions (HORIZONTAL) CH01						
Frequency (MHz)	Amplitude (dBuV/m)	Ant. (m)	Table (Degree)	Duty (dB)	Limit (dBuV/m)	Margin (dB)
2399.7	61.5 (PK)	1	125	0	74.0(PK)	-12.5
2399.7	42.0 (AV)	1	125	0	54.0(AV)	-12.0

Radiated Emissions (VERTICAL) CH01						
Frequency (MHz)	Amplitude (dBuV/m)	Ant. (m)	Table (Degree)	Duty (dB)	Limit (dBuV/m)	Margin (dB)
2399.2	72.4 (PK)	1	301	0	74.0(PK)	-1.6
2399.2	50.2 (AV)	1	301	0	54.0(AV)	-3.8

Radiated Emissions (HORIZONTAL) CH11						
Frequency (MHz)	Amplitude (dBuV/m)	Ant. (m)	Table (Degree)	Duty (dB)	Limit (dBuV/m)	Margin (dB)
2484.1	55.5 (PK)	1	158	0	74.0(PK)	-18.5
2484.1	38.4 (AV)	1	158	0	54.0(AV)	-15.6

Radiated Emissions (VERTICAL) CH11						
Frequency (MHz)	Amplitude (dBuV/m)	Ant. (m)	Table (Degree)	Duty (dB)	Limit (dBuV/m)	Margin (dB)
2484.1	67.4 (PK)	1	272	0	74.0(PK)	-6.6
2484.1	45.1 (AV)	1	272	0	54.0(AV)	-8.9

- Notes :**
1. Margin= Amplitude - Limits
 2. Height of table for EUT placed: 0.8 Meter.
 3. ANT= Antenna height.
 4. Duty= Duty cycle correction factor.
 5. Amplitude= Reading Amplitude – Amplifier gain+ Cable loss+ Antenna factor
(Auto calculate in spectrum analyzer)

9. Antenna Requirements

9.1 Standard Applicable :

For intentional device, according to 15.203, an intentional radiator shall be designed to ensure that no antenna other than that furnished by the responsible party shall be used with the device.

According to 15.247 (b), if transmitting antennas of directional gain greater than 6 dBi are used, the power shall be reduced by the amount in dB that the directional gain of the antenna exceeds 6dBi.

9.2 Antenna Construction

	Model No	ANT TYPE	GAIN	type of connector
1	G087-310012-A	Dipole	2.0dBi	N/A

Appendix I - EUT Test Setup

MEASUREMENT OF RADIATED EMISSION

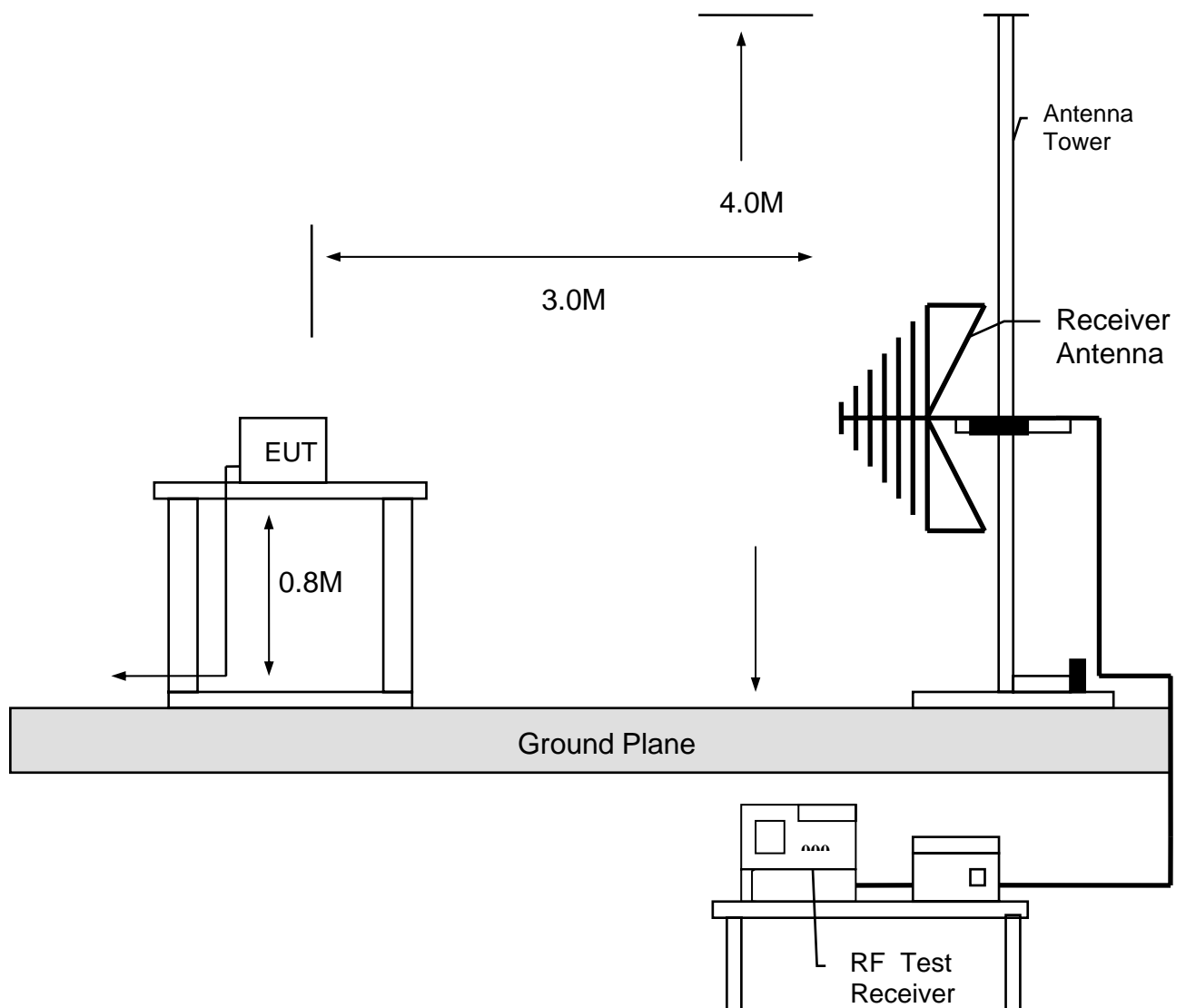

Appendix II - Brand / Trade Name & Model No. Multiple Listee

Trade Name	Model No.
COMTREND	VR-3031u VR-3032u

The both models are identical and the different model No. is for the market segmentation.