

Test Report

FCC ID:L76-TWS150I

Date of issue: Aug. 11, 2020

Report number: MTi20033010-7E1

Sample description: Bluetooth Earbuds

Model(s): KOSS TWS150i, A801-40

Applicant: Koss Corporation

Address: 4129 N Port Washington Ave Milwaukee, WI 53212 USA

Date of test: Mar. 31, 2020 to Apr. 10, 2020

Shenzhen Microtest Co., Ltd.
<http://www.mtitest.com>



This test report is valid for the tested samples only. It cannot be reproduced except in full without prior written consent of Shenzhen Microtest Co., Ltd.

Tel:(86-755)88850135

Fax: (86-755) 88850136

Web: <http://www.mtitest.com>

E-mail: mti@51mti.com

Address: No.102A & 302A, East Block, Hengfang Industrial Park, Xingye Road, Xixiang, Bao'an District, Shenzhen, Guangdong, China

Table of Contents

1	GENERAL INFORMATION.....	5
1.1	DESCRIPTION OF EUT	5
1.2	OPERATION CHANNEL LIST	5
1.3	TEST CHANNEL LIST	6
1.4	ANCILLARY EQUIPMENT LIST	6
1.5	DESCRIPTION OF SUPPORT UNITS	6
2	SUMMARY OF TEST RESULTS.....	7
3	TEST FACILITIES AND ACCREDITATIONS.....	8
3.1	TEST LABORATORY	8
3.2	ENVIRONMENTAL CONDITIONS	8
3.3	MEASUREMENT UNCERTAINTY	8
3.4	TEST SOFTWARE	8
4	EQUIPMENT LIST	9
5	TEST RESULT	10
5.1	ANTENNA REQUIREMENT	10
5.1.1	<i>Standard requirement.....</i>	<i>10</i>
5.1.2	<i>EUT antenna</i>	<i>10</i>
5.2	PEAK OUTPUT POWER	11
5.2.1	<i>Limit</i>	<i>11</i>
5.2.2	<i>Test setup</i>	<i>11</i>
5.2.3	<i>Test procedure.....</i>	<i>11</i>
5.2.4	<i>Test results</i>	<i>11</i>
5.3	CONDUCTED EMISSION	18
5.3.1	<i>Limits.....</i>	<i>18</i>
5.3.2	<i>Test setup</i>	<i>18</i>
5.3.3	<i>Test procedure.....</i>	<i>19</i>
5.3.4	<i>Test results</i>	<i>19</i>
5.4	RADIATED SPURIOUS EMISSION.....	20
5.4.1	<i>Limits.....</i>	<i>20</i>
5.4.2	<i>Test setup</i>	<i>21</i>
5.4.3	<i>Test procedure.....</i>	<i>22</i>
5.4.4	<i>Test results</i>	<i>23</i>
5.4.5	<i>Band edge – radiated</i>	<i>27</i>
5.4.6	<i>Spurious Emission in Restricted Band 3260MHz-18000MHz.....</i>	<i>28</i>
5.5	20dB OCCUPIED CHANNEL BANDWIDTH	29
5.5.1	<i>Limit</i>	<i>29</i>
5.5.2	<i>Test setup</i>	<i>29</i>
5.5.3	<i>Test procedure.....</i>	<i>29</i>
5.5.4	<i>Test results</i>	<i>29</i>
5.6	CARRIER FREQUENCY SEPARATION	36
5.6.1	<i>Limit</i>	<i>36</i>
5.6.2	<i>Test setup</i>	<i>36</i>
5.6.3	<i>Test procedure.....</i>	<i>36</i>
5.6.4	<i>Test results</i>	<i>36</i>
5.7	HOPPING CHANNEL	42
5.7.1	<i>Limit</i>	<i>42</i>
5.7.2	<i>Test setup</i>	<i>42</i>
5.7.3	<i>Test procedure.....</i>	<i>42</i>
5.7.4	<i>Test results</i>	<i>42</i>
5.8	DWELL TIME.....	45
5.8.1	<i>Limit</i>	<i>45</i>



5.8.2	Test setup	45
5.8.3	Test procedure.....	45
5.8.4	Test results	45
5.9	CONDUCTED BAND EDGE.....	52
5.9.1	Limit	52
5.9.2	Test setup	52
5.9.3	Test procedure.....	52
5.9.4	Test results	52
5.10	SPURIOUS RF CONDUCTED EMISSIONS	59
5.10.1	Limit.....	59
5.10.2	Measuring instruments.....	59
5.10.3	Test setup.....	59
5.10.4	Test procedure	59
5.10.5	Test results	59
PHOTOGRAPHS OF THE TEST SETUP		62
PHOTOGRAPHS OF THE EUT		63

Test Result Certification

Applicant's name: Koss Corporation

Address: 4129 N Port Washington Ave Milwaukee, WI 53212 USA

Manufacture's name: ShenZhen Cannice Technology Co., Ltd.

Address: 20/F, Tower A, Building 7, Baoneng Science and Technology Park, Qingxiang Road #1, Longhua New District, Shenzhen, China

Factory's name: Shenzhen Cannice Technology Co., Ltd. Dongguan Branch

Address: 4F, Office Building, No. 70 Puxinhu Pulong Village, Tangxia Town, Dongguan City, Guangdong Province, P.R. China

Product name: Bluetooth Earbuds

Trademark: N/A

Model name: KOSS TWS150i, A801-40

Standards: FCC Part 15.247

Test procedure: ANSI C63.10-2013

This device described above has been tested by Shenzhen Microtest Co., Ltd. and the test results show that the equipment under test (EUT) is in compliance with the FCC requirements. And it is applicable only to the tested sample identified in the report.

Tested by:



Danny Xu

Apr. 10, 2020

Reviewed by:

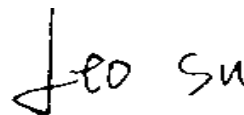

Leo Su

Aug. 11, 2020

Approved by:



Tom Xue

Aug. 11, 2020

1 General Information

1.1 Description of EUT

Product name:	Bluetooth Earbuds
Model name:	KOSS TWS150i
Serial model:	A801-40
Difference in series models:	All the models are of the same circuit and RF module, except the model No..
Operation frequency:	2402-2480MHz
Modulation type:	GFSK, $\pi/4$ -DQPSK, 8DPSK
Bit Rate of transmitter:	1 Mbps, 2Mbps, 3Mbps
Antenna type:	FPC Antenna
Antenna gain:	-1.46dBi
Max. output power:	7.642dBm
Hardware version:	V0A
Software version:	V0E
Power source:	DC 3.7V from battery
Adapter information:	N/A
Battery:	The Charging box: DC 3.7V 500mAh The Bluetooth earphone: DC 3.7V 60mAh

1.2 Operation channel list

Channel	Frequency (MHz)	Channel	Frequency (MHz)	Channel	Frequency (MHz)
00	2402	27	2429	54	2456
01	2403	28	2430	55	2457
02	2404	29	2431	56	2458
03	2405	30	2432	57	2459
04	2406	31	2433	58	2460
05	2407	32	2434	59	2461
06	2408	33	2435	60	2462
07	2409	34	2436	61	2463
08	2410	35	2437	62	2464
09	2411	36	2438	63	2465
10	2412	37	2439	64	2466
11	2413	38	2440	65	2467
12	2414	39	2441	66	2468



13	2415	40	2442	67	2469
14	2416	41	2443	68	2470
15	2417	42	2444	69	2471
16	2418	43	2445	70	2472
17	2419	44	2446	71	2473
18	2420	45	2447	72	2474
19	2421	46	2448	73	2475
20	2422	47	2449	74	2476
21	2423	48	2450	75	2477
22	2424	49	2451	76	2478
23	2425	50	2452	77	2479
24	2426	51	2453	78	2480
25	2427	52	2454	--	--
26	2428	53	2455	--	--

1.3 Test channel list

Channel	Channel	Frequency (MHz)
Low	00	2402
Middle	39	2441
High	78	2480

1.4 Ancillary equipment list

Equipment	Model	S/N	Manufacturer	Certificate type
Adapter	EQ-24BCN	/	Huizhou Dongyang Yienbi Electronics Co., Ltd.	/

1.5 Description of Support Units

The EUT has been tested as an independent unit together with other necessary accessories or support units. The following support units or accessories were used to form a representative test configuration during the tests.

Item	Equipment	Brand	Model/Type No.	Series No.	Note
/	/	/	/	/	/

Note:

- (1)The support equipment was authorized by Declaration of Confirmation.
- (2)For detachable type I/O cable should be specified the length in cm in 『Length』 column.

2 Summary of Test Results

Test procedures according to the technical standards:

No.	Standard Section	Test Item	Result	Remark
1	15.203	Antenna requirement	Pass	
2	15.247(b)(1)	Peak output power	Pass	
3	15.207	Conducted emission	N/A	
4	15.247(d)	Band edge	Pass	
5	15.205/15.209	Spurious emission	Pass	
6	15.247(a)(1)	20dB occupied bandwidth	Pass	
7	15.247(a)(1)	Carrier Frequencies Separation	Pass	
8	15.247(a)(1)	Hopping channel number	Pass	
9	15.247(a)(1)	Dwell time	Pass	
10	15.247(d)	Spurious RF Conducted Emissions	Pass	

3 Test Facilities and Accreditations

3.1 Test laboratory

Test Laboratory	Shenzhen Microtest Co., Ltd.
Location	No.102A & 302A, East Block, Hengfang Industrial Park, Xingye Road, Xixiang, Bao'an District, Shenzhen, Guangdong, China
FCC Registration No.:	448573

3.2 Environmental conditions

Temperature:	15°C~35°C
Humidity	20%~75%
Atmospheric pressure	98kPa~101kPa

3.3 Measurement uncertainty

The reported uncertainty of measurement $y \pm U$ where expanded uncertainty U is based on a standard uncertainty multiplied by a coverage factor of $k=2$ providing a level of confidence of approximately 95 %

No.	Item	Uncertainty
1	Conducted Emission Test	$\pm 1.38\text{dB}$
2	RF power, conducted	$\pm 0.16\text{dB}$
3	Spurious emissions, conducted	$\pm 0.21\text{dB}$
4	All emissions, radiated(<1G)	$\pm 4.68\text{dB}$
5	All emissions, radiated(>1G)	$\pm 4.89\text{dB}$
6	Temperature	$\pm 0.5^\circ\text{C}$
7	Humidity	$\pm 2\%$

3.4 Test software

Software Name	Manufacturer	Model	Version
Bluetooth and WiFi Test System	Shenzhen JS tonskend co., ltd	JS1120-3	2.5.77.0418

4 Equipment List

Equipment No.	Equipment Name	Manufacturer	Model	Serial No.	Calibration date	Due date
MTI-E004	EMI Test Receiver	Rohde&schwarz	ESPI7	100314	2019/10/09	2020/10/08
MTI-E006	TRILOG Broadband Antenna	Schwarabeck	VULB 9163	9163-872	2019/10/15	2020/10/14
MTI-E007	Double Ridged Broadband Horn Antenna	schwarabeck	BBHA 9120 D	9120D-1145	2019/10/13	2020/10/12
MTI-E014	Amplifier	Hewlett-Packard	8447D	3113A06150	2019/10/09	2020/10/08
MTI-E036	Single path vehicle AMN(LISN)	Schwarzbeck	NNBM 8124	01175	2019/10/09	2020/10/08
MTI-E038	Low noise active vertical monopole antenna	Schwarzbeck	VAMP 9243	#565	2019/10/16	2020/10/15
MTI-E039	Biconical antenna	Schwarzbeck	BBA 9106	#164	2019/10/15	2020/10/14
MTI-E041	MXG Vector Signal Generator	Agilent	N5182A	MY49060455	2019/04/16	2020/04/15
MTI-E042	ESG Series Analog signal generator	Agilent	E4421B	GB40051240	2019/05/21	2020/05/20
MTI-E044	Thermometer clock humidity monitor	-	HTC-1	/	2019/04/17	2020/04/16
MTI-E065	Amplifier	EMtrace	RP06A	00117	2019/04/29	2020/04/28
MTI-E071	PXA Signal Analyzer	Agilent	N9030A	MY51350296	2019/10/25	2020/10/24
MTI-E076	EMI Test Receiver	Rohde&schwarz	ESIB26	100273	2019/04/16	2020/04/15
MTI-E078	Synthesized Sweeper	Agilent	83752A	3610A01957	2019/04/16	2020/04/15
MTI-E079	DC Power Supply	Agilent	E3632A	MY40027695	2019/04/16	2020/04/15
MTI-E093	Artificial mains network	3ctest	LISN J50	ES3911805	2019/04/16	2020/04/15
MTI-E096	Power amplifier	Space-Dtronics	EWLNA0118 G-P40	1852001	2019/04/29	2020/04/28
MTI-E097	Current Probe	SOLAR ELECTRONICS CO.	9207-1	220095-1	2019/04/17	2020/04/16
MTI-E098	Loop Sensor	SOLAR ELECTRONICS CO.	7334-1	220095-2	2019/04/21	2020/04/20
MTI-E081	EPM Series Power Meter	Agilent	E4419B	MY50000438	2019/04/16	2021/04/15

Note: the calibration interval of the above test instruments is 12 or 24 months and the calibrations are traceable to international system unit (SI).

5 Test Result

5.1 Antenna requirement

5.1.1 Standard requirement

15.203 requirement: For intentional device, according to 15.203: an intentional radiator shall be designed to ensure that no antenna other than that furnished by the responsible party shall be used with the device

5.1.2 EUT antenna

The EUT antenna is FPC antenna (-1.46dBi). It comply with the standard requirement. In case of replacement of broken antenna the same antenna type must be used.

5.2 Peak output power

5.2.1 Limit

FCC Part15 Subpart C			
Section	Test Item	Limit	Frequency Range (MHz)
15.247(b)(1)	Peak output power	Power<1W(30dBm)	2400-2483.5

5.2.2 Test setup

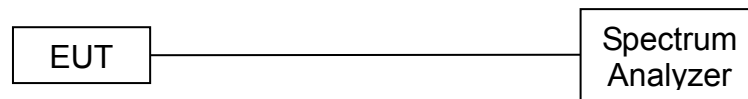

5.2.3 Test procedure

- (1) The EUT was directly connected to the spectrum analyzer and antenna output port as show in the block diagram above.
- (2) Spectrum Setting:
 RBW=1MHz, VBW=3MHz, Detector=Peak (If 20dB BW ≤1 MHz)
 RBW=3MHz, VBW=8MHz, Detector=Peak (If 20dB BW > 1 MHz)
- (3) The EUT was set to continuously transmitting in the max power during the test.

5.2.4 Test results

Test data

EUT:	Bluetooth Earbuds	Model Name:	KOSS TWS150i
Pressure:	1012 hPa	Test Voltage:	DC 3.7V from battery

GFSK

Test Channel	Frequency (MHz)	Maximum Peak Output Power(dBm)	Limit (dBm)
CH00	2402	6.179	30
CH39	2441	6.424	30
CH78	2480	6.432	30

 $\pi/4$ -DQPSK

Test Channel	Frequency (MHz)	Maximum Peak Output Power(dBm)	Limit (dBm)
CH00	2402	7.253	20.97
CH39	2441	7.301	20.97
CH78	2480	7.298	20.97

8DPSK

Test Channel	Frequency (MHz)	Maximum Peak Output Power(dBm)	Limit (dBm)
CH00	2402	7.544	20.97
CH39	2441	7.642	20.97
CH78	2480	7.583	20.97



Test plots

GFSK mode-CH00

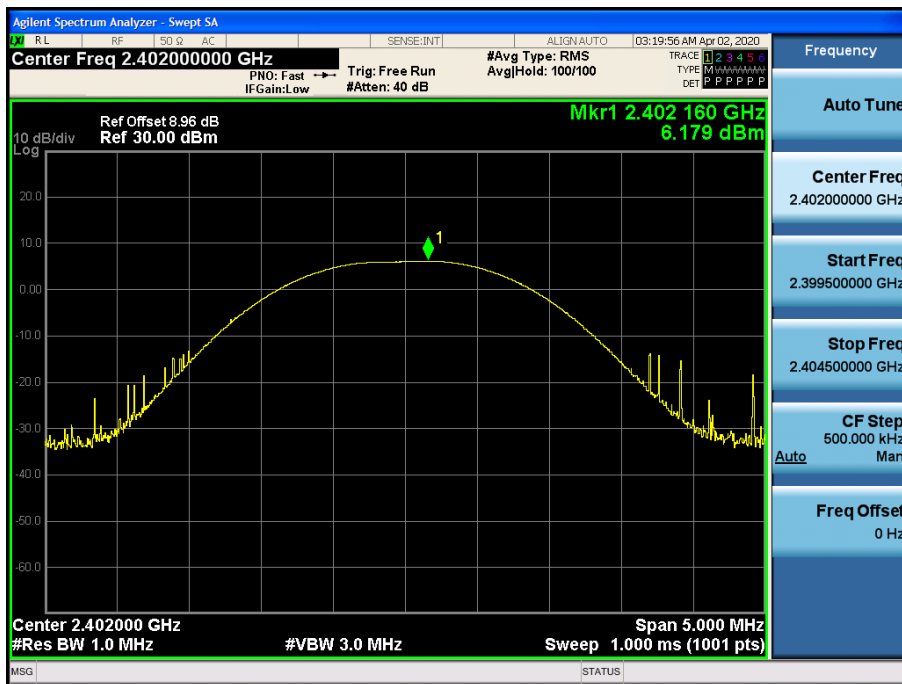

GFSK mode-CH39

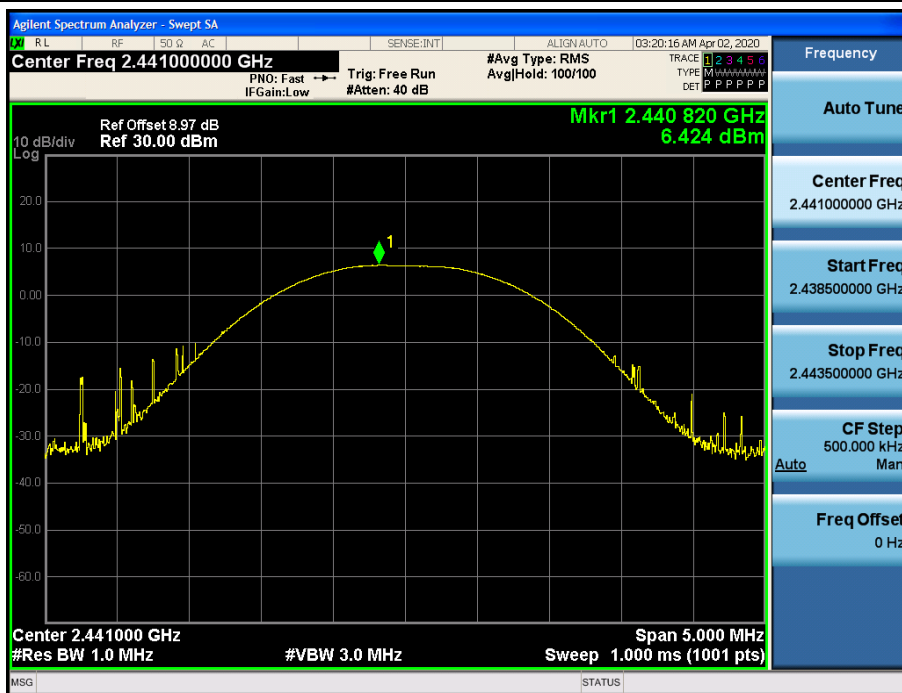



GFSK mode-CH78

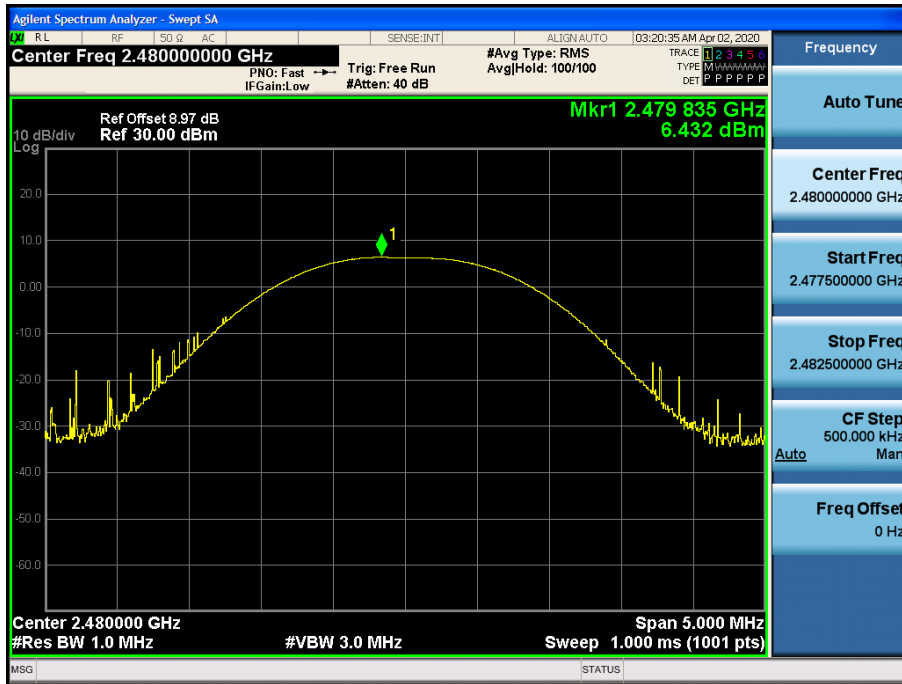

$\pi/4$ -DQPSK mode-CH00





$\pi/4$ -DQPSK mode-CH39



$\pi/4$ -DQPSK mode-CH78

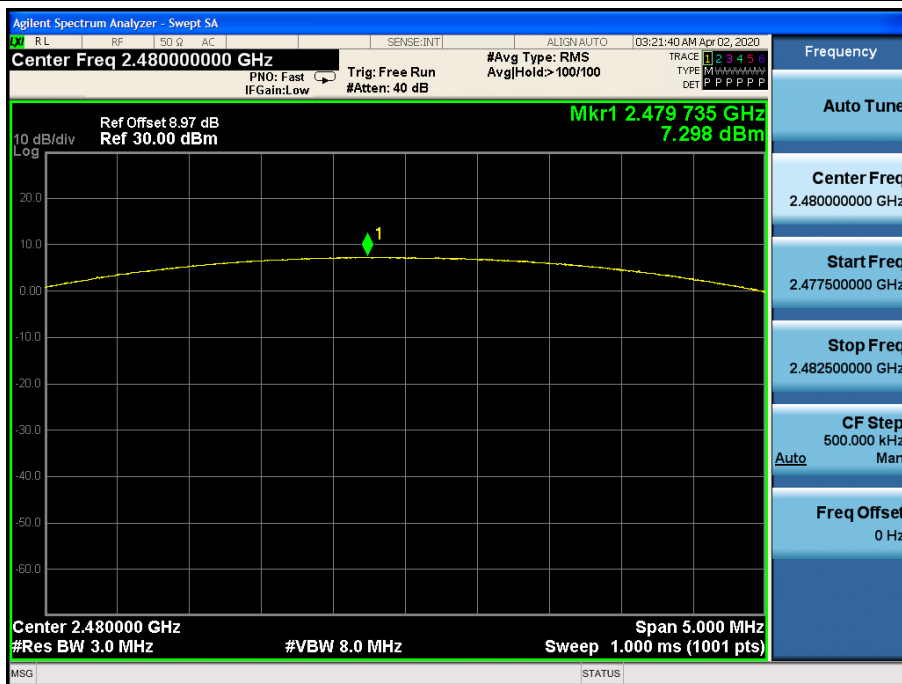



8DPSK mode-CH00



8DPSK mode-CH39



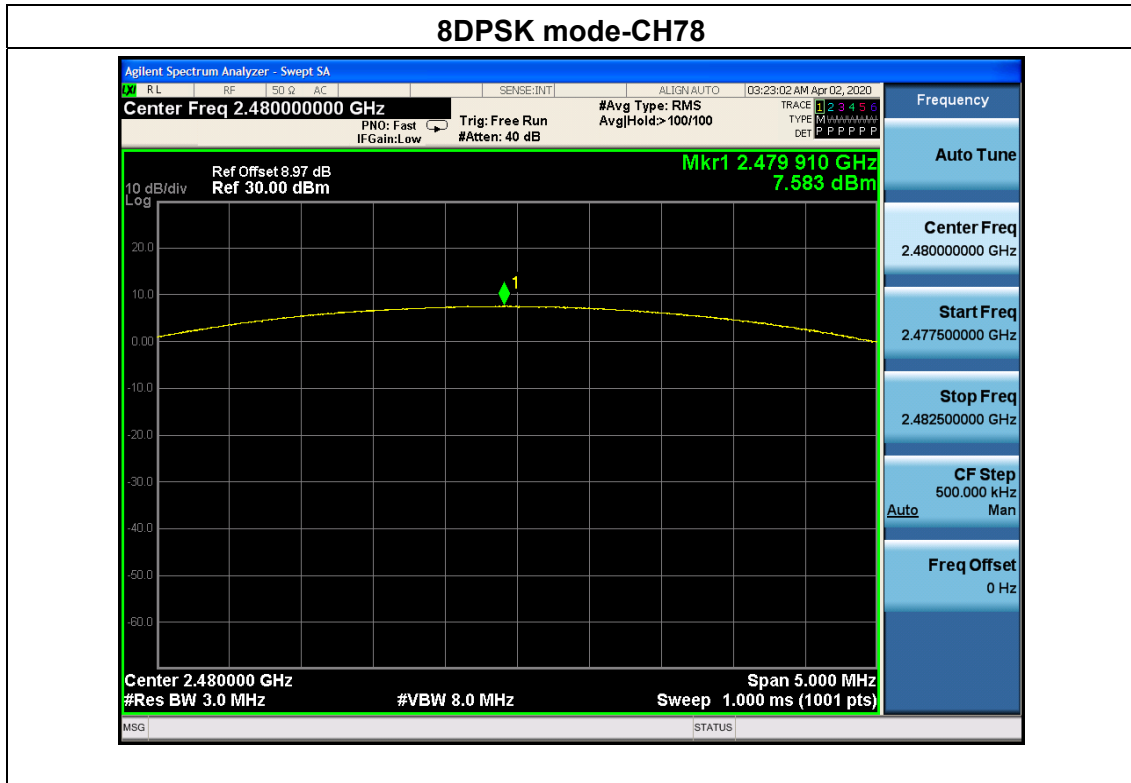

5.3 Conducted emission

5.3.1 Limits

FREQUENCY (MHz)	Class B (dBuV)	
	Quasi-peak	Average
0.15 -0.5	66 - 56 *	56 - 46 *
0.50 -5.0	56.00	46.00
5.0 -30.0	60.00	50.00

Note

(1)The tighter limit applies at the band edges.

(2)The limit of " * " marked band means the limitation decreases linearly with the logarithm of the frequency in the range.

5.3.2 Test setup

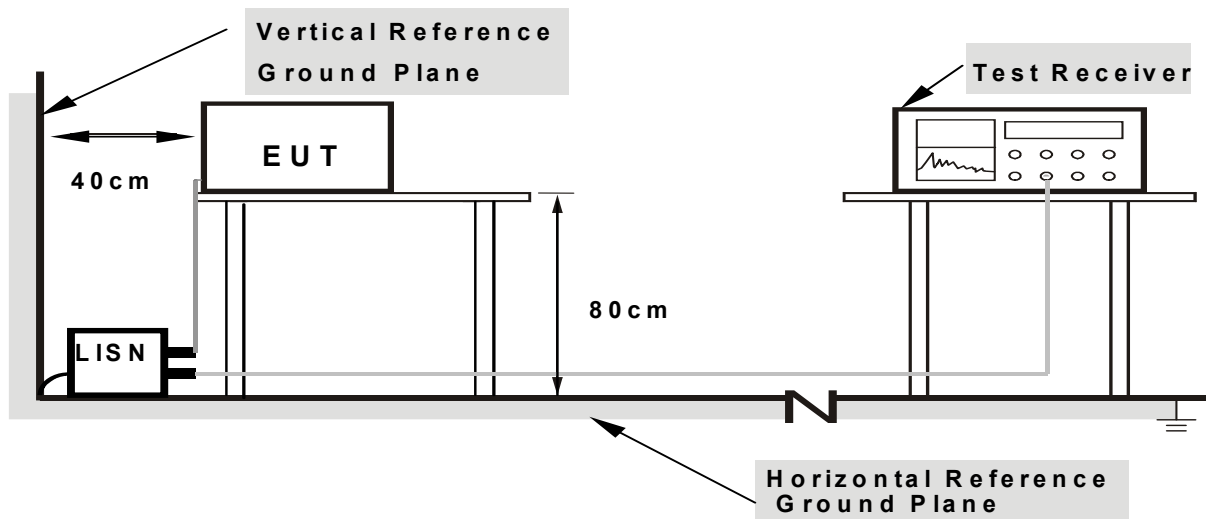

Note: 1.Support units were connected to second LISN.

2.Both of LISNs (AMN) are 80 cm from EUT and at least 80 from other units and other metal planes

5.3.3 Test procedure

a. EUT Operating Conditions

The EUT was configured for testing in a typical fashion (as a customer would normally use it). The EUT has been programmed to continuously transmit during test. This operating condition was tested and used to collect the included data.

b. The following table is the setting of the receiver

Receiver Parameters	Setting
Attenuation	10 dB
Start Frequency	0.15 MHz
Stop Frequency	30 MHz
IF Bandwidth	9 kHz

- c. The EUT was placed 0.8 meters from the horizontal ground plane with EUT being connected to the power mains through a line impedance stabilization network (LISN). All other support equipments powered from additional LISN(s). The LISN provide 50 Ohm/ 50uH of coupling impedance for the measuring instrument.
- d. Interconnecting cables that hang closer than 40 cm to the ground plane shall be folded back and forth in the center forming a bundle 30 to 40 cm long.
- e. I/O cables that are not connected to a peripheral shall be bundled in the center. The end of the cable may be terminated, if required, using the correct terminating impedance. The overall length shall not exceed 1 m.
- f. LISN at least 80 cm from nearest part of EUT chassis.

For the actual test configuration, please refer to the related Item –EUT Test Photos.

5.3.4 Test results

Note: Because the product does not TX when it is charged, so this item not applicate.

5.4 Radiated spurious emission

5.4.1 Limits

20dBc in any 100 kHz bandwidth outside the operating frequency band. In case the emission fall within the restricted band specified on 15.205(a), then the 15.209(a) limit in the table below has to be followed.

Frequency (MHz)	Field Strength (microvolts/meter)	Measurement Distance (meters)
0.009~0.490	2400/F(kHz)	300
0.490~1.705	24000/F(kHz)	30
1.705~30.0	30	30
30~88	100	3
88~216	150	3
216~960	200	3
Above 960	500	3

Spectrum Parameter	Setting
Attenuation	Auto
Start Frequency	1000 MHz
Stop Frequency	10th carrier harmonic
RB / VB (emission in restricted band)	1 MHz / 1 MHz for Peak, 1 MHz / 10Hz for Average

Receiver Parameter	Setting
Attenuation	Auto
Start ~ Stop Frequency	9kHz~150kHz / RB 200Hz for QP
Start ~ Stop Frequency	150kHz~30MHz / RB 9kHz for QP
Start ~ Stop Frequency	30MHz~1000MHz / RB 120kHz for QP

5.4.2 Test setup

Radiated emission test-up frequency below 30MHz

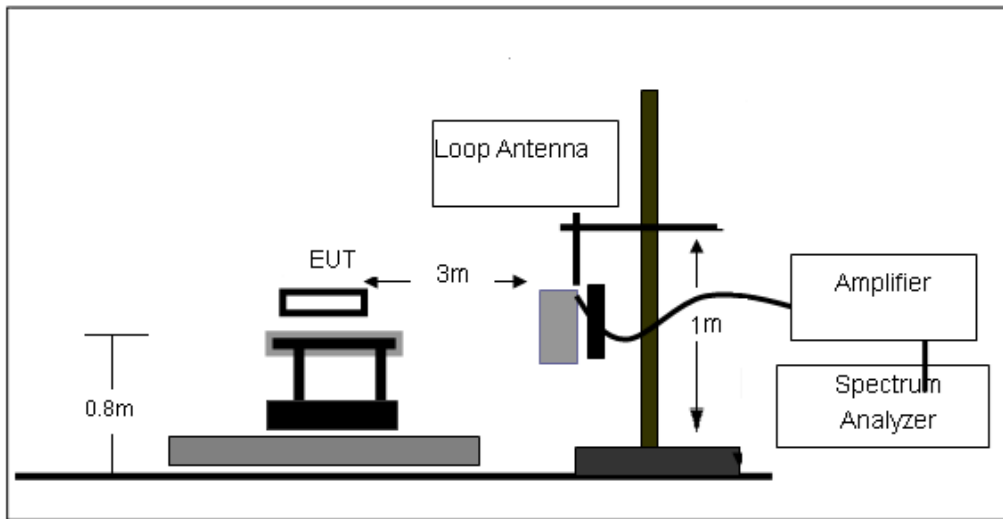

Radiated emission test-up frequency 30MHz~1GHz

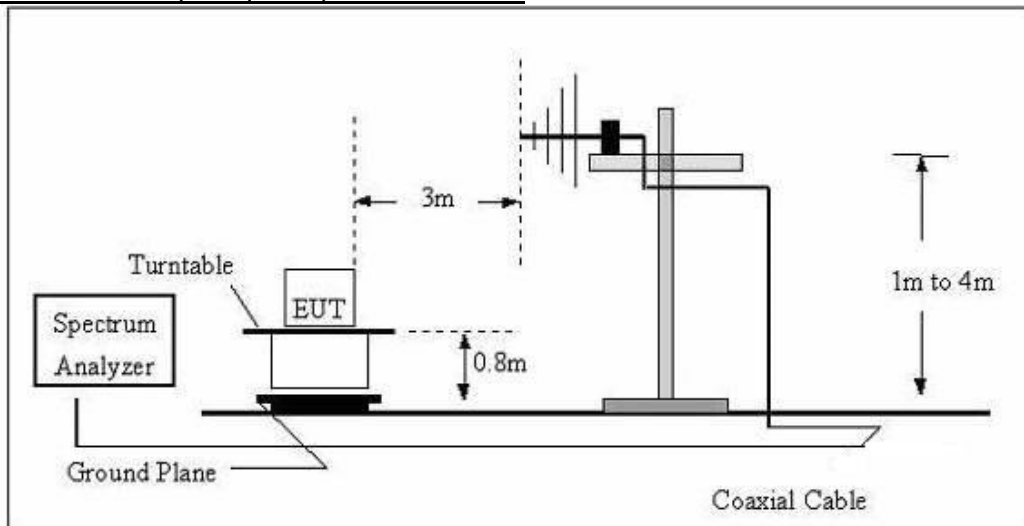

Radiated emission test-up frequency above 1GHz

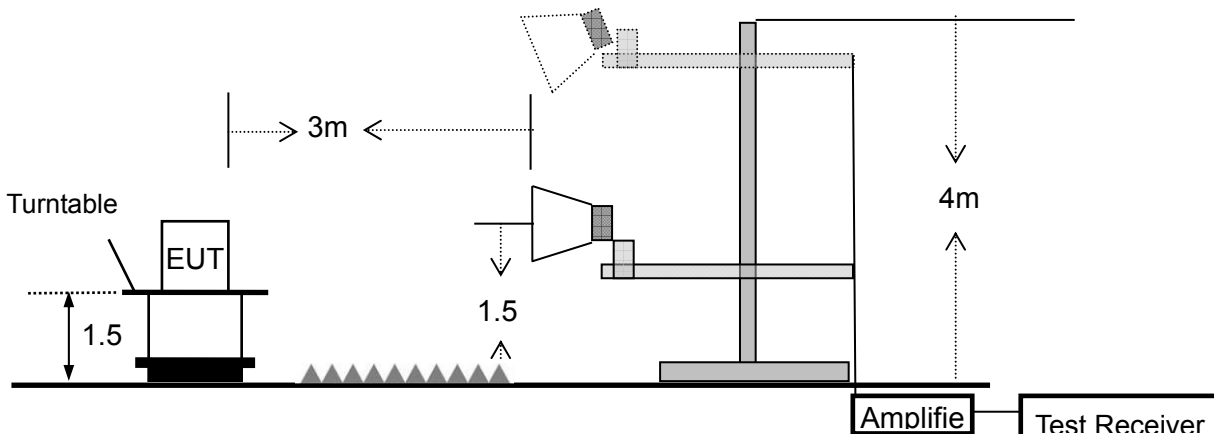

5.4.3 Test procedure

- a. EUT operating conditions. The EUT tested system was configured as the statements of 2.4 Unless otherwise a special operating condition is specified in the follows during the testing.
- b. The measuring distance of at 3 m shall be used for measurements at frequency up to 1GHz. For frequencies above 1GHz, any suitable measuring distance may be used.
- c. The EUT was placed on the top of a rotating table 0.8 meters above the ground at a 3 meter open area test site. The table was rotated 360 degrees to determine the position of the highest radiation.
- d. The height of the equipment or of the substitution antenna shall be 0.8 m; the height of the test antenna shall vary between 1 m to 4 m. Both horizontal and vertical polarizations of the antenna are set to make the measurement.
- e. For emission measurements above 1 GHz, the EUT shall be placed at a height of 1.5 m above the floor on a support that is RF transparent for the frequencies of interest. Final measurements for the EUT require a measurement antenna height scan of 1 m to 4 m.
- f. The initial step in collecting conducted emission data is a spectrum analyzer peak detector mode pre-scanning the measurement frequency range. Significant peaks are then marked and then Quasi Peak detector mode re-measured.
- g. If the Peak Mode measured value compliance with and lower than Quasi Peak Mode Limit, the EUT shall be deemed to meet QP Limits and then no additional QP Mode measurement performed.
- h. For the actual test configuration, please refer to the related Item –EUT Test photos.

Note: Both horizontal and vertical antenna polarities were tested. The worst case emissions were reported.

During the radiated emission test, the Spectrum Analyzer was set with the following configurations:

Frequency Band (MHz)	Function	Resolution bandwidth	Video Bandwidth
30 to 1000	QP	120 kHz	300 kHz
Above 1000	Peak	1 MHz	1 MHz
	Average	1 MHz	10 Hz

Note: for the frequency ranges below 30 MHz, a narrower RBW is used for these ranges but the measured value should add a RBW correction factor (RBWCF) where $RBWCF [dB] = 10 \cdot \lg(100 [kHz] / \text{narrower RBW [kHz]})$. , the narrower RBW is 1 kHz and RBWCF is 20 dB for the frequency 9 kHz to 150 kHz, and the narrower RBW is 10 kHz and RBWCF is 10 dB for the frequency 150 kHz to 30 MHz.

5.4.4 Test results

Below 30MHz

EUT:	Bluetooth Earbuds	Model Name:	KOSS TWS150i
Pressure:	1010 hPa	Test Voltage:	DC 3.7V from battery
Test Mode:	TX	Polarization:	--

Freq.	Reading	Limit	Margin	State
(MHz)	(dBuV/m)	(dBuV/m)	(dB)	P/F
--	--	--	--	Pass
--	--	--	--	Pass

Note:

For 9kHz-30MHz, the amplitude of spurious emissions which are attenuated by more than 20dB below the permissible value has no need to be reported.

Distance extrapolation factor = $40 \log(\text{specific distance}/\text{test distance})$ (dB);

Limit line = specific limits (dBuV) + distance extrapolation factor.

Between 30MHz – 1GHz

Note 1: Emission Level = Meter Reading + Factor, Margin= Emission Level- Limit, Factor = Antenna Factor + Cable Loss – Pre-amplifier.

Note2: The three modulated high, medium and low channels have been tested. The report only shows the worst mode. The worst mode is 8DPSK CH39.

EUT:	Bluetooth Earbuds	Model Name:	KOSS TWS150i
Pressure:	1010 hPa	Phase:	H
Test Mode:	TX	Test Voltage:	DC 3.7V from battery

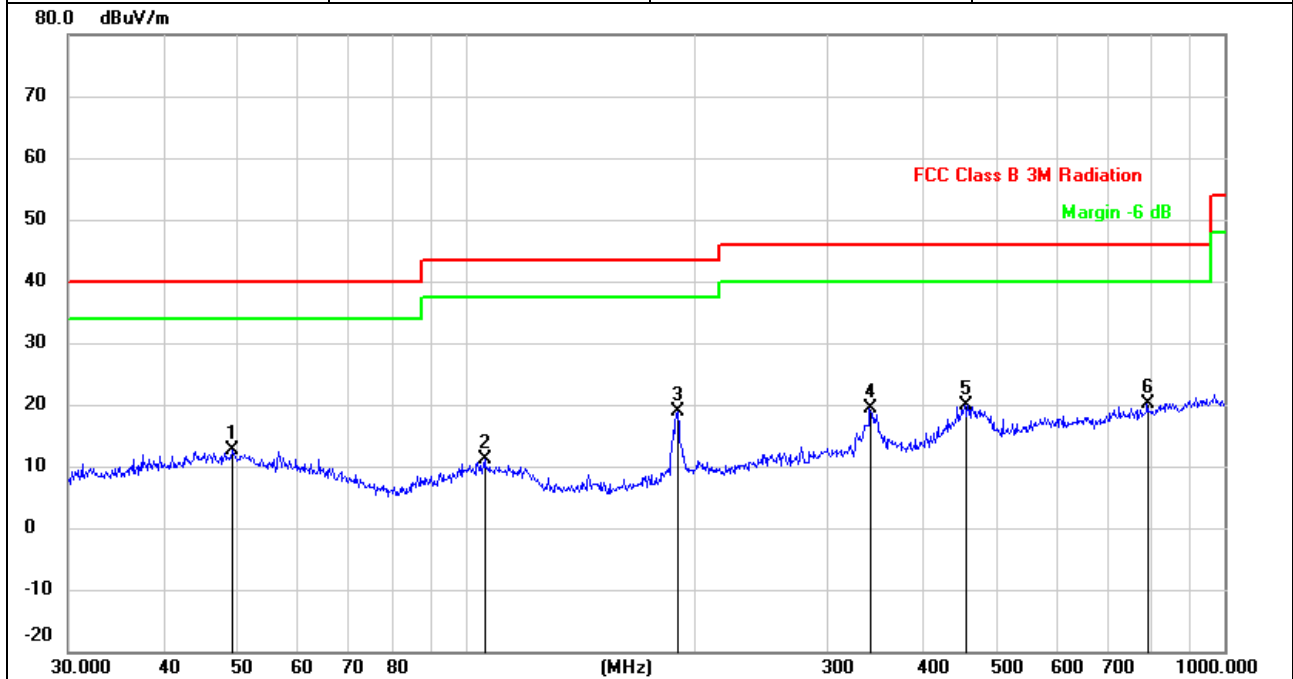

No.	Mk.	Freq. MHz	Reading Level dBuV	Correct Factor dBuV/m	Measure- ment dBuV/m	Limit dBuV/m	Over dB	Detector
1		49.3594	25.68	-12.98	12.70	40.00	-27.30	QP
2		106.0126	25.84	-14.74	11.10	43.50	-32.40	QP
3	*	190.4050	33.86	-15.02	18.84	43.50	-24.66	QP
4		340.7817	30.62	-11.33	19.29	46.00	-26.71	QP
5		454.3100	30.56	-10.65	19.91	46.00	-26.09	QP
6		790.6188	27.42	-7.36	20.06	46.00	-25.94	QP

EUT:	Bluetooth Earbuds	Model Name:	KOSS TWS150i
Pressure:	1010 hPa	Phase:	V
Test Mode:	TX	Test Voltage:	DC 3.7V from battery

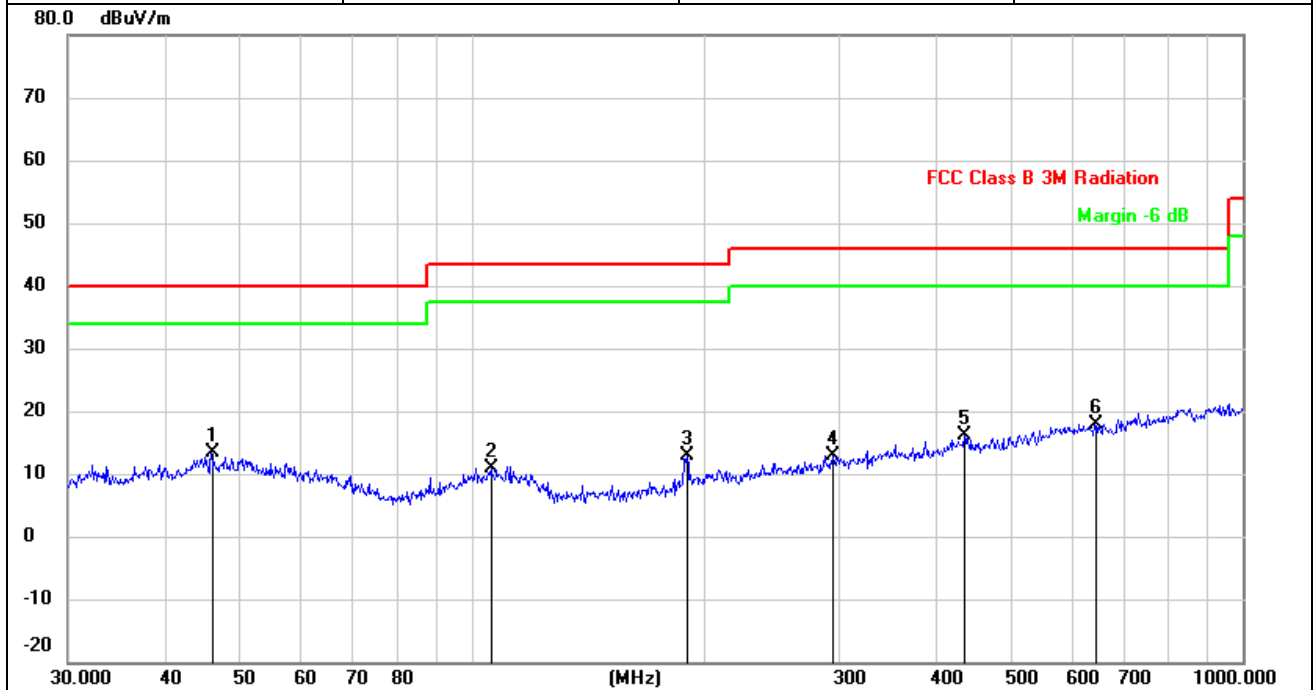

No.	Mk.	Freq.	Reading Level	Correct Factor	Measurement	Limit	Over	Detector
		MHz	dBuV	dBuV/m	dBuV/m	dBuV/m	dB	
1	*	46.0164	26.51	-13.06	13.45	40.00	-26.55	QP
2		106.0126	25.69	-14.74	10.95	43.50	-32.55	QP
3		190.4050	27.95	-15.02	12.93	43.50	-30.57	QP
4		294.1137	25.15	-12.16	12.99	46.00	-33.01	QP
5		435.5898	26.52	-10.40	16.12	46.00	-29.88	QP
6		642.8613	26.46	-8.52	17.94	46.00	-28.06	QP

1G-25GHz

Note: (1) All Readings are Peak Value (VBW=3MHz) and AV Value (VBW=10Hz).

(2) Emission Level= Antenna Factor + Cable Loss + Read Level - Preamp Factor

(3) All other emissions more than 20dB below the limit.

All the modulation modes have been tested, and the worst result was report as below:

Frequency	Read Level	Cable loss	Antenna Factor	Preamp Factor	Emission Level	Limits	Margin	Remark	Comment
(MHz)	(dBμV)	(dB)	dB/m	(dB)	(dBμV/m)	(dBμV/m)	(dB)		
Low Channel (2402 MHz)(8DPSK)--Above 1G									
4804.629	62.57	4.36	32.92	45.53	54.32	74.00	-19.68	Pk	Vertical
4804.629	43.38	4.36	32.92	45.53	35.13	54.00	-18.87	AV	Vertical
7206.567	60.73	5.02	37.63	45.56	57.82	74.00	-16.18	Pk	Vertical
7206.567	42.06	5.02	37.63	45.56	39.15	54.00	-14.85	AV	Vertical
4804.396	60.50	4.36	32.92	45.53	52.25	74.00	-21.75	Pk	Horizontal
4804.396	43.07	4.36	32.92	45.53	34.82	54.00	-19.18	AV	Horizontal
7206.424	60.20	5.02	37.63	45.56	57.29	74.00	-16.71	Pk	Horizontal
7206.424	49.10	5.02	37.63	45.56	46.19	54.00	-7.81	AV	Horizontal
Mid Channel (2441 MHz)(8DPSK)--Above 1G									
4881.539	61.89	4.43	33.04	45.81	53.55	74.00	-20.45	Pk	Vertical
4881.539	41.33	4.43	33.04	45.81	32.99	54.00	-21.01	AV	Vertical
7322.142	59.03	5.02	37.71	45.62	56.14	74.00	-17.86	Pk	Vertical
7322.142	43.13	5.02	37.71	45.62	40.24	54.00	-13.76	AV	Vertical
4881.285	58.86	4.43	33.04	45.81	50.52	74.00	-23.48	Pk	Horizontal
4881.285	47.65	4.43	33.04	45.81	39.31	54.00	-14.69	AV	Horizontal
7322.199	57.94	5.02	37.71	45.62	55.05	74.00	-18.95	Pk	Horizontal
7322.199	48.16	5.02	37.71	45.62	45.27	54.00	-8.73	AV	Horizontal
High Channel (2480 MHz)(8DPSK)-- Above 1G									
4959.223	60.58	4.50	33.26	46.07	52.27	74.00	-21.73	Pk	Vertical
4959.223	41.04	4.50	33.26	46.07	32.73	54.00	-21.27	AV	Vertical
7439.201	62.16	5.02	37.78	45.77	59.19	74.00	-14.81	Pk	Vertical
7439.201	46.24	5.02	37.78	45.77	43.27	54.00	-10.73	AV	Vertical
4959.165	62.16	4.50	33.26	46.07	53.85	74.00	-20.15	Pk	Horizontal
4959.165	48.34	4.50	33.26	46.07	40.03	54.00	-13.97	AV	Horizontal
7439.264	59.49	5.02	37.78	45.77	56.52	74.00	-17.48	Pk	Horizontal
7439.264	46.91	5.02	37.78	45.77	43.94	54.00	-10.06	AV	Horizontal

5.4.5 Band edge – radiated

All the modulation modes have been tested, and the worst result was report as below:

Frequency	Meter Reading	Cable Loss	Antenna Factor	Preamplifier Factor	Emission Level	Limits	Margin	Detector	Comment
(MHz)	(dBμV)	(dB)	dB/m	(dB)	(dBμV/m)	(dBμV/m)	(dB)	Type	
3Mbps(8DPSK)- Non-hopping									
2310.00	60.73	2.40	27.70	40.40	50.43	74	-23.57	Pk	Horizontal
2310.00	42.76	2.40	27.70	40.40	32.46	54	-21.54	AV	Horizontal
2310.00	63.51	2.40	27.70	40.40	53.21	74	-20.79	Pk	Vertical
2310.00	42.88	2.40	27.70	40.40	32.58	54	-21.42	AV	Vertical
2390.00	60.12	2.44	28.30	40.10	50.76	74	-23.24	Pk	Vertical
2390.00	41.12	2.44	28.30	40.10	31.76	54	-22.24	AV	Vertical
2390.00	60.40	2.44	28.30	40.10	51.04	74	-22.96	Pk	Horizontal
2390.00	42.54	2.44	28.30	40.10	33.18	54	-20.82	AV	Horizontal
2400.00	64.23	2.46	28.30	40.10	54.89	74	-19.11	Pk	Vertical
2400.00	44.73	2.46	28.30	40.10	35.39	54	-18.61	AV	Vertical
2400.00	64.22	2.46	28.30	40.10	54.88	74	-19.12	Pk	Horizontal
2400.00	43.87	2.46	28.30	40.10	34.53	54	-19.47	AV	Horizontal
2483.50	62.05	2.48	28.70	39.80	53.43	74	-20.57	Pk	Vertical
2483.50	39.95	2.48	28.70	39.80	31.33	54	-22.67	AV	Vertical
2483.50	60.60	2.48	28.70	39.80	51.98	74	-22.02	Pk	Horizontal
2483.50	42.88	2.48	28.70	39.80	34.26	54	-19.74	AV	Horizontal
2500.00	60.36	2.48	28.70	39.80	51.74	74	-22.26	Pk	Vertical
2500.00	42.01	2.48	28.70	39.80	33.39	54	-20.61	AV	Vertical
2500.00	60.29	2.48	28.70	39.80	51.67	74	-22.33	Pk	Horizontal
2500.00	42.96	2.48	28.70	39.80	34.34	54	-19.66	AV	Horizontal
3Mbps (8DPSK)- hopping									
2400.00	59.61	2.46	28.30	40.10	50.27	74	-23.73	Pk	Vertical
2400.00	42.63	2.46	28.30	40.10	33.29	54	-20.71	AV	Vertical
2400.00	60.34	2.46	28.30	40.10	51.00	74	-23.00	Pk	Horizontal
2400.00	43.23	2.46	28.30	40.10	33.89	54	-20.11	AV	Horizontal
2483.50	63.03	2.48	28.70	39.80	54.41	74	-19.59	Pk	Vertical
2483.50	43.50	2.48	28.70	39.80	34.88	54	-19.12	AV	Vertical
2483.50	59.91	2.48	28.70	39.80	51.29	74	-22.71	Pk	Horizontal
2483.50	42.85	2.48	28.70	39.80	34.23	54	-19.77	AV	Horizontal

5.4.6 Spurious Emission in Restricted Band 3260MHz-18000MHz

All the modulation modes have been tested, and the worst result was report as below:

Frequency	Reading Level	Cable Loss	Antenna Factor	Preamp Factor	Emission Level	Limits	Margin	Detector	Comment
(MHz)	(dB μ V)	(dB)	dB/m	(dB)	(dB μ V/m)	(dB μ V/m)	(dB)	Type	
3260	59.61	3.27	30.02	38.05	54.85	74	-19.15	Pk	Vertical
3260	41.78	3.27	30.02	38.05	37.02	54	-16.98	AV	Vertical
3260	60.84	3.27	30.02	38.05	56.08	74	-17.92	Pk	Horizontal
3260	39.48	3.27	30.02	38.05	34.72	54	-19.28	AV	Horizontal
3332	60.81	3.31	30.00	37.91	56.21	74	-17.79	Pk	Vertical
3332	41.07	3.31	30.00	37.91	36.47	54	-17.53	AV	Vertical
3332	60.34	3.31	30.00	37.91	55.74	74	-18.26	Pk	Horizontal
3332	41.82	3.31	30.00	37.91	37.22	54	-16.78	AV	Horizontal
17797	50.24	8.63	44.23	39.60	63.50	74	-10.50	Pk	Vertical
17797	30.66	8.63	44.23	39.60	43.92	54	-10.08	AV	Vertical
17788	49.21	8.63	44.23	39.60	62.47	74	-11.53	Pk	Horizontal
17788	31.55	8.63	44.23	39.60	44.81	54	-9.19	AV	Horizontal

5.5 20dB occupied channel bandwidth

5.5.1 Limit

FCC Part15 (15.247) , Subpart C			
Section	Test Item	Limit	Frequency Range (MHz)
15.247a(1)	20dB bandwidth	N/A	2400-2483.5

5.5.2 Test setup

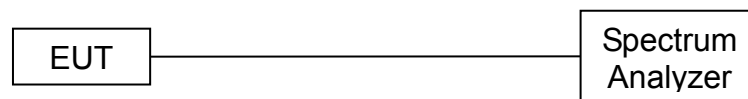

5.5.3 Test procedure

- (1) The EUT was directly connected to the spectrum analyzer and antenna output port as show in the block diagram above.
- (2) Spectrum Setting:
 Bandwidth: RBW=30 kHz, VBW=100 kHz, detector= Peak

5.5.4 Test results

Test data

EUT:	Bluetooth Earbuds	Model Name:	KOSS TWS150i
Pressure:	1012 hPa	Test Voltage:	DC 3.7V from battery

Mode	Frequency (MHz)	20dB Bandwidth (MHz)	Limit (kHz)	Result
GFSK	2402	0.9295	N/A	Pass
	2441	0.9262	N/A	Pass
	2480	0.8692	N/A	Pass
$\pi/4$ -DQPSK	2402	1.2500	N/A	Pass
	2441	1.2300	N/A	Pass
	2480	1.2390	N/A	Pass
8DPSK	2402	1.3030	N/A	Pass
	2441	1.2590	N/A	Pass
	2480	1.2630	N/A	Pass



Test plots

GFSK mode

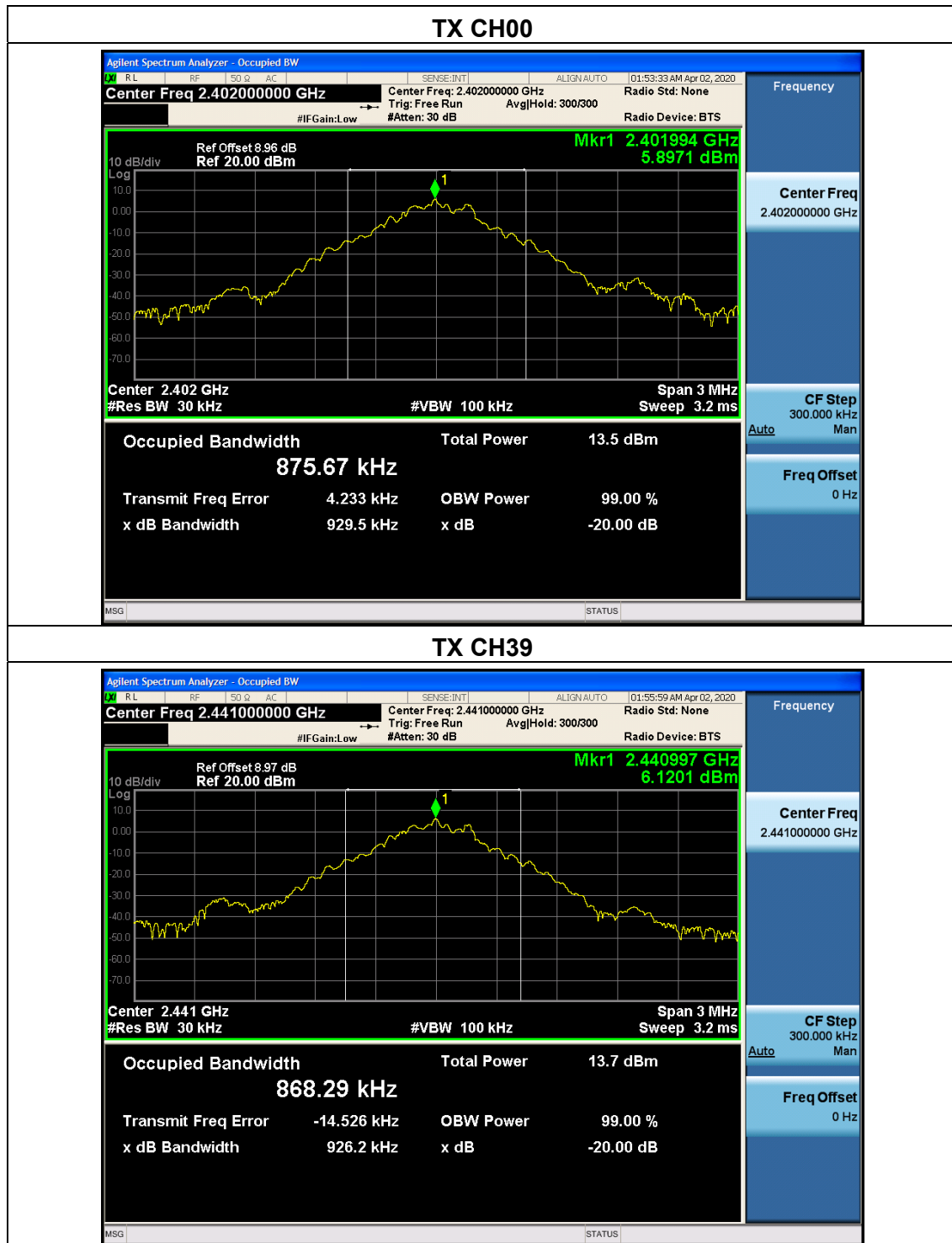

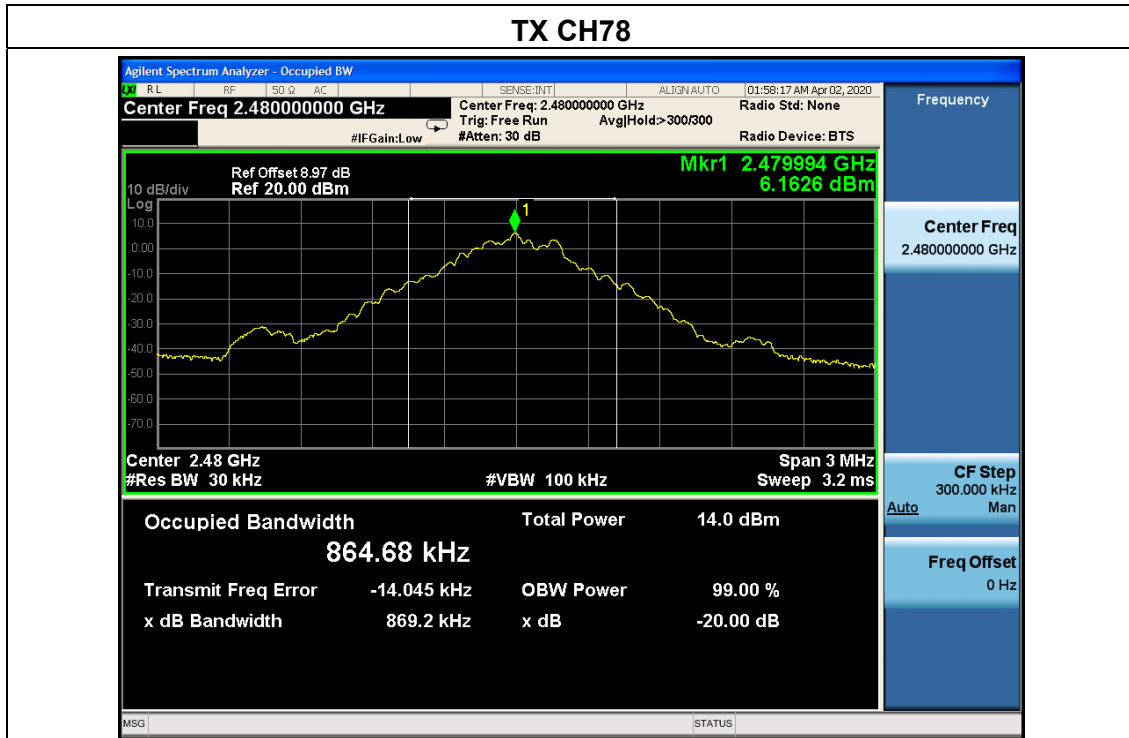

$\pi/4$ -DQPSK

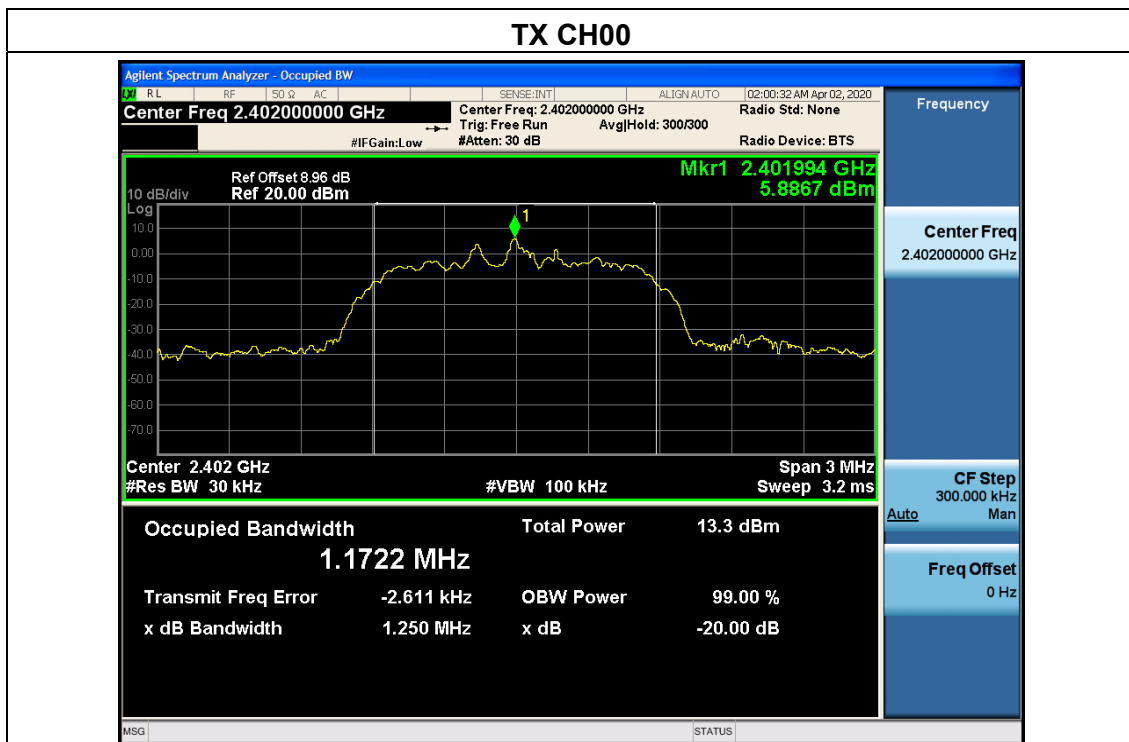

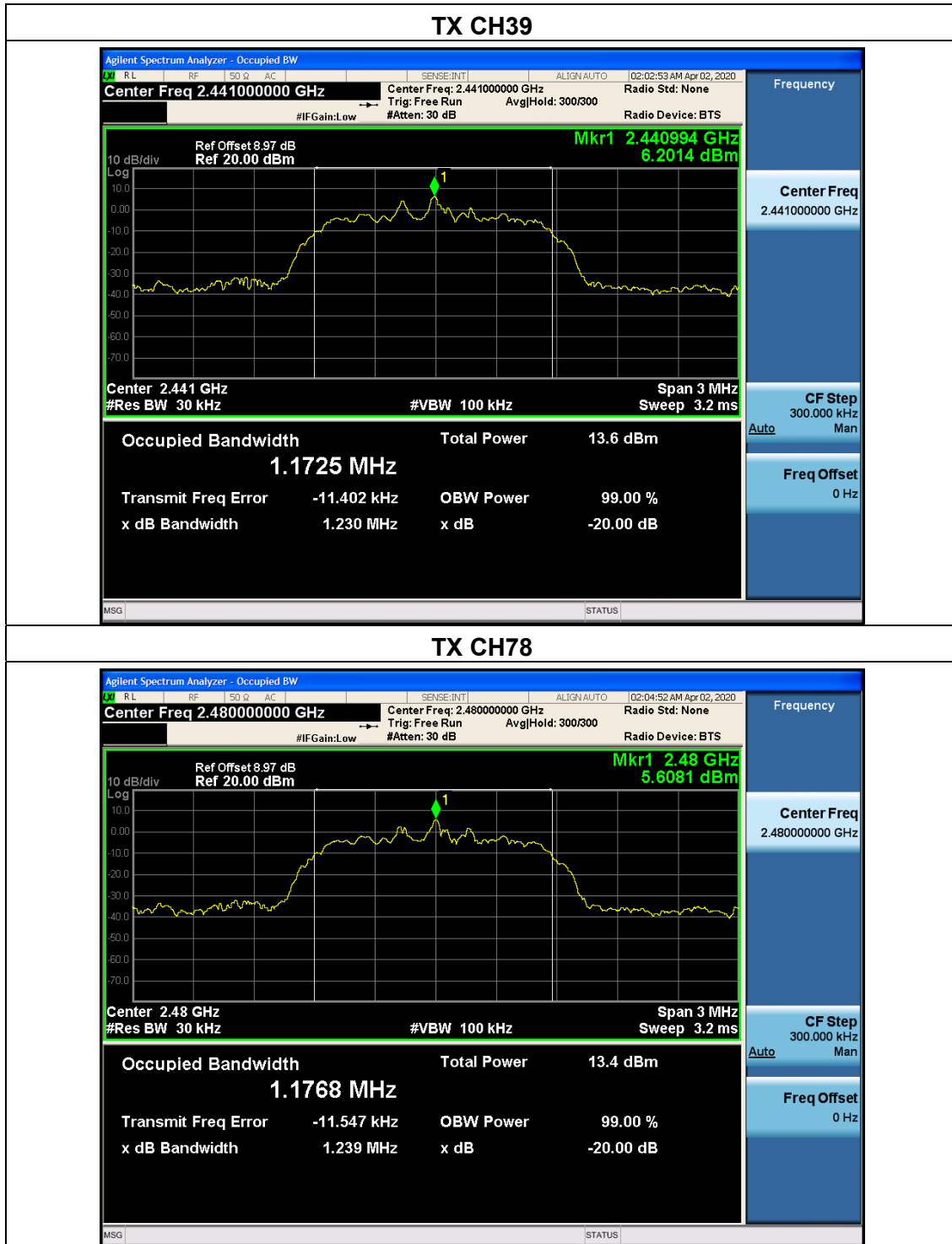



8DPSK mode

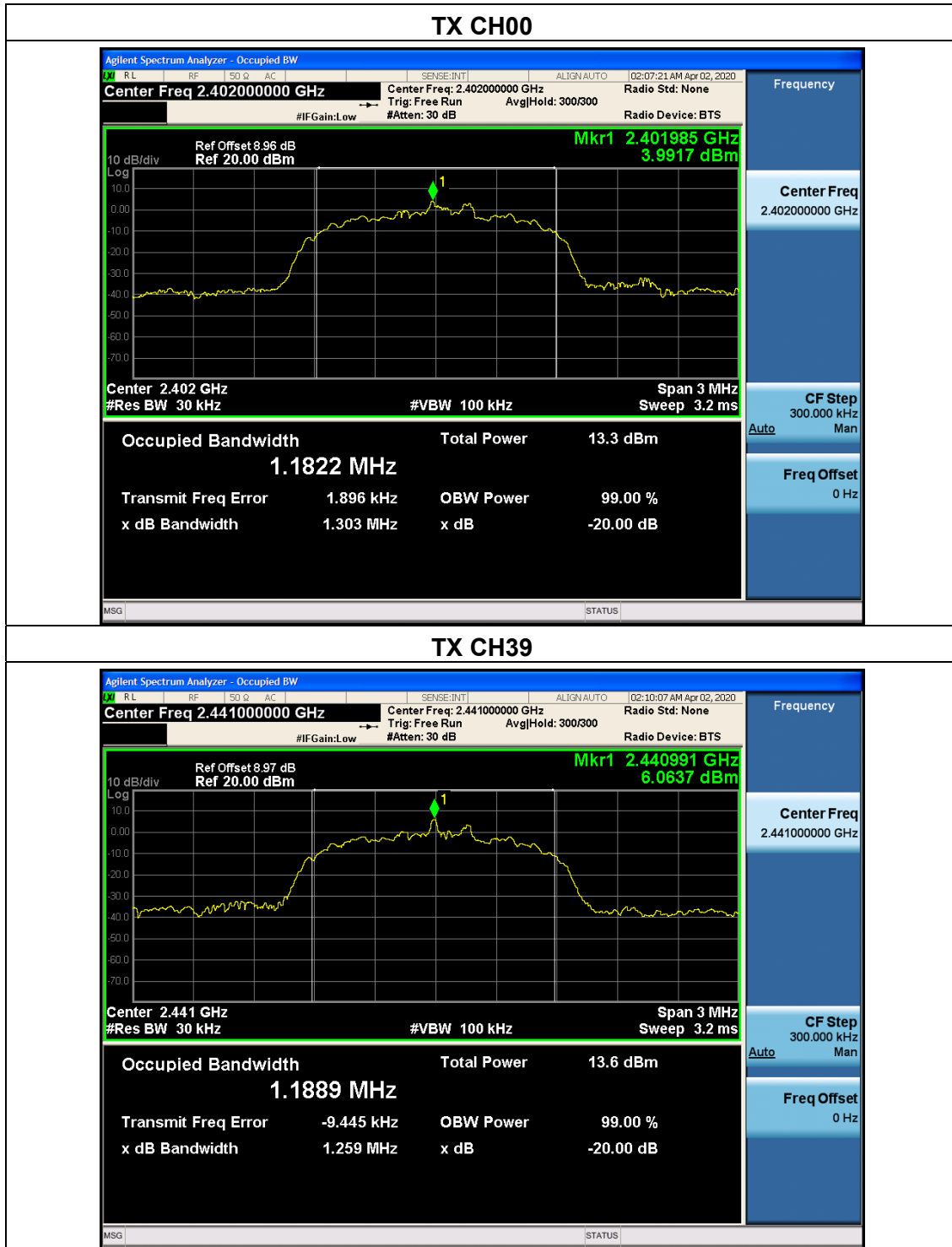

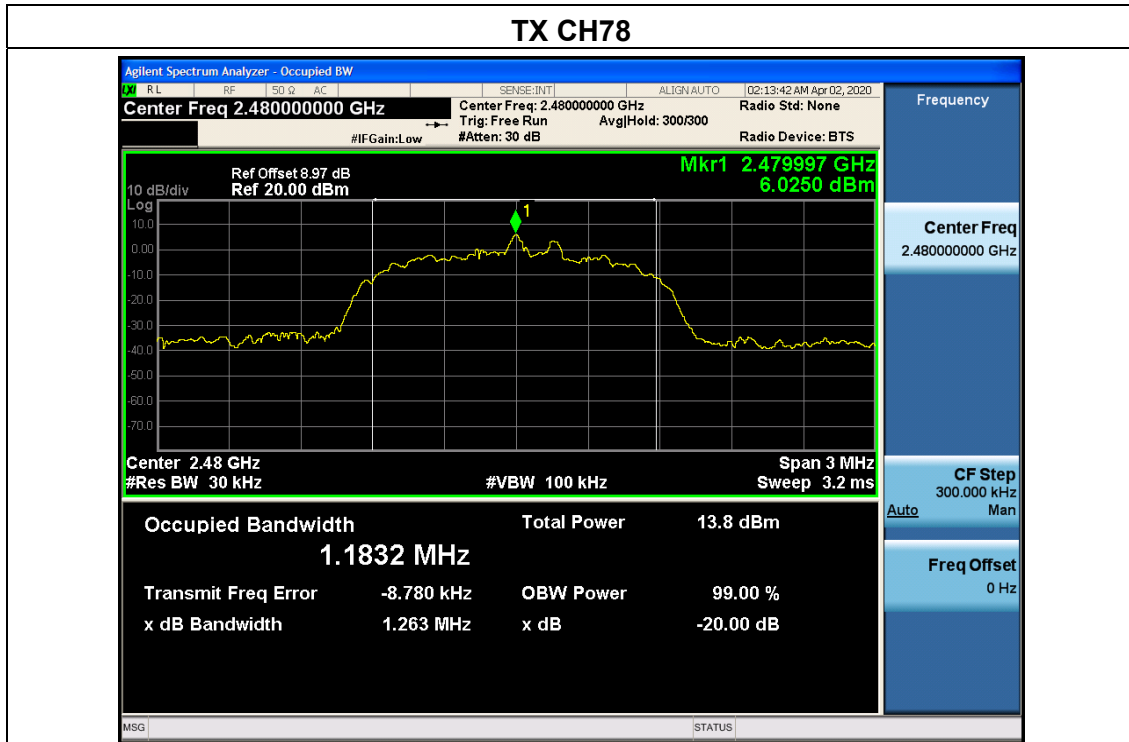

5.6 Carrier frequency separation

5.6.1 Limit

FCC Part15 (15.247) , Subpart C			
Section	Test Item	Limit	Frequency Range (MHz)
15.247(a)(1)	Channel Separation	>25kHz or >two-thirds of the 20 dB bandwidth (Which is greater)	2400-2483.5

5.6.2 Test setup

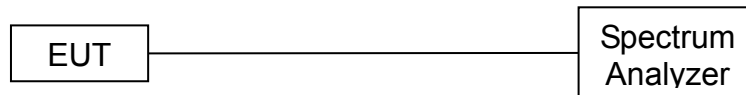

5.6.3 Test procedure

- (1) The EUT was directly connected to the spectrum analyzer and antenna output port as show in the block diagram above.
- (2) Spectrum Setting:
RBW=30 kHz, VBW=100 kHz, detector= Peak, Sweep Time =auto.
- (3) The EUT was set to the Hopping Mode for Channel Separation Test and continuously transmitting for the Test.

5.6.4 Test results

Test data

EUT:	Bluetooth Earbuds	Model Name:	KOSS TWS150i
Pressure:	1012 hPa	Test Voltage:	DC 3.7V from battery
Test Mode:	GFSK, $\pi/4$ -DQPSK, 8DPSK /CH00, CH39, CH78		

Mode	Channel	Frequency	Test Result	Limit		Result
		(MHz)	(kHz)	(kHz)		
GFSK	Low	2402	1000	620	2/3 of 20dB BW	Pass
	Middle	2441	1000	617	2/3 of 20dB BW	Pass
	High	2480	1000	579	2/3 of 20dB BW	Pass
$\pi/4$ -DQPSK	Low	2402	1000	833	2/3 of 20dB BW	Pass
	Middle	2441	998	820	2/3 of 20dB BW	Pass
	High	2480	998	826	2/3 of 20dB BW	Pass
8DPSK	Low	2402	1002	869	2/3 of 20dB BW	Pass
	Middle	2441	1000	839	2/3 of 20dB BW	Pass
	High	2480	1000	842	2/3 of 20dB BW	Pass

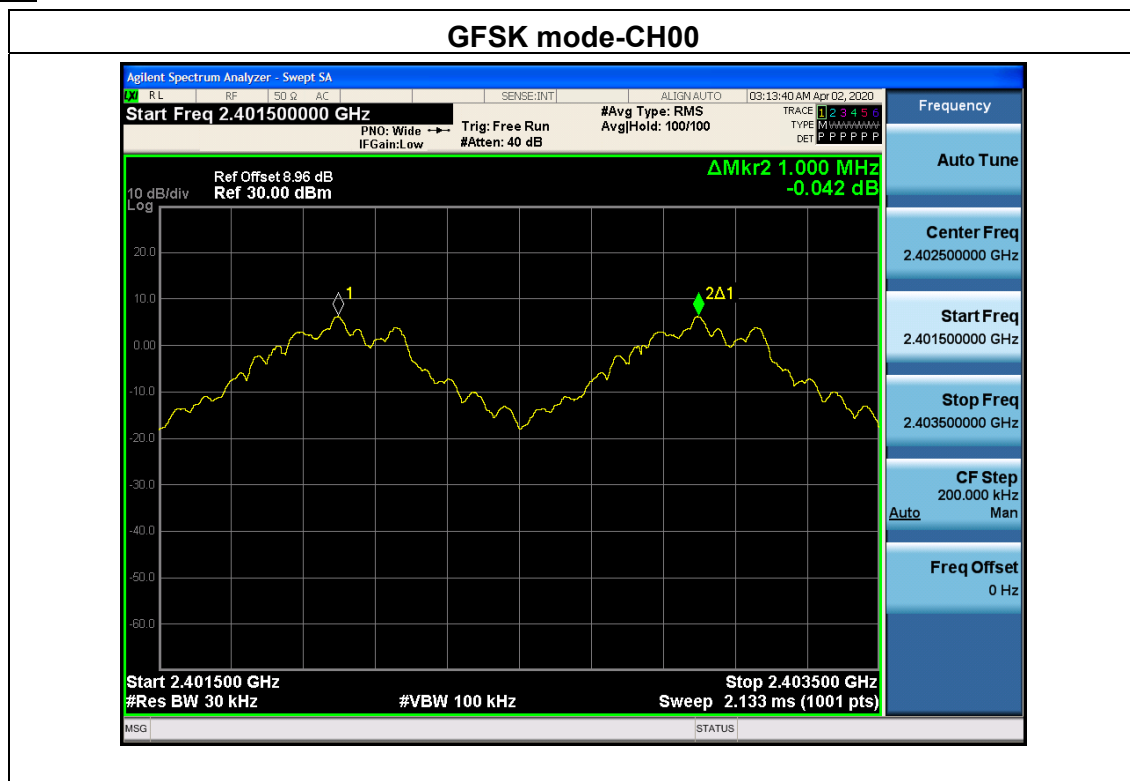
Test plots



GFSK mode-CH39



GFSK mode-CH78





$\pi/4$ -DQPSK mode-CH00

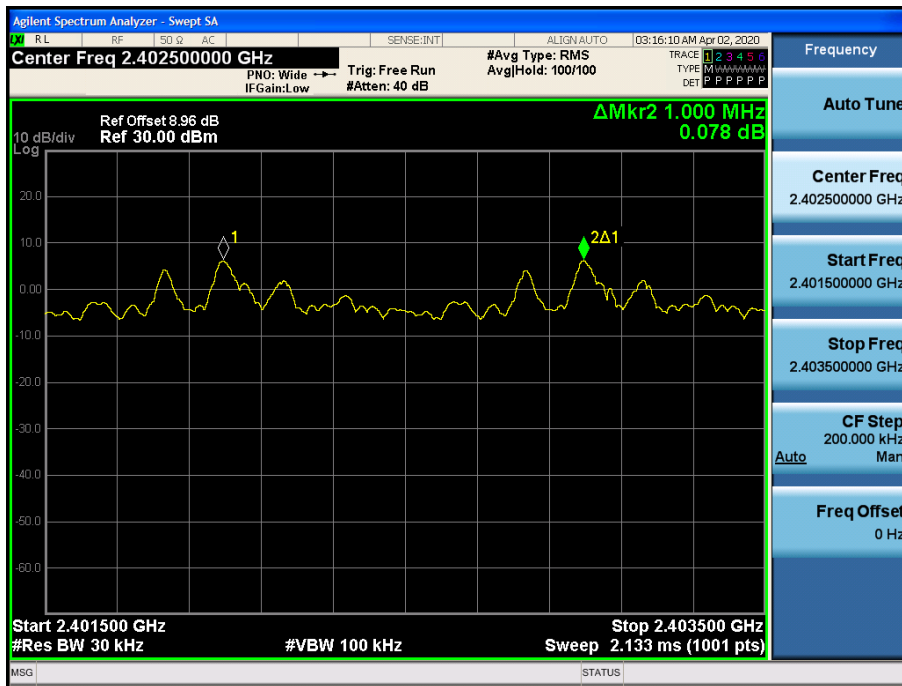

$\pi/4$ -DQPSK mode-CH39





$\pi/4$ -DQPSK mode-CH78

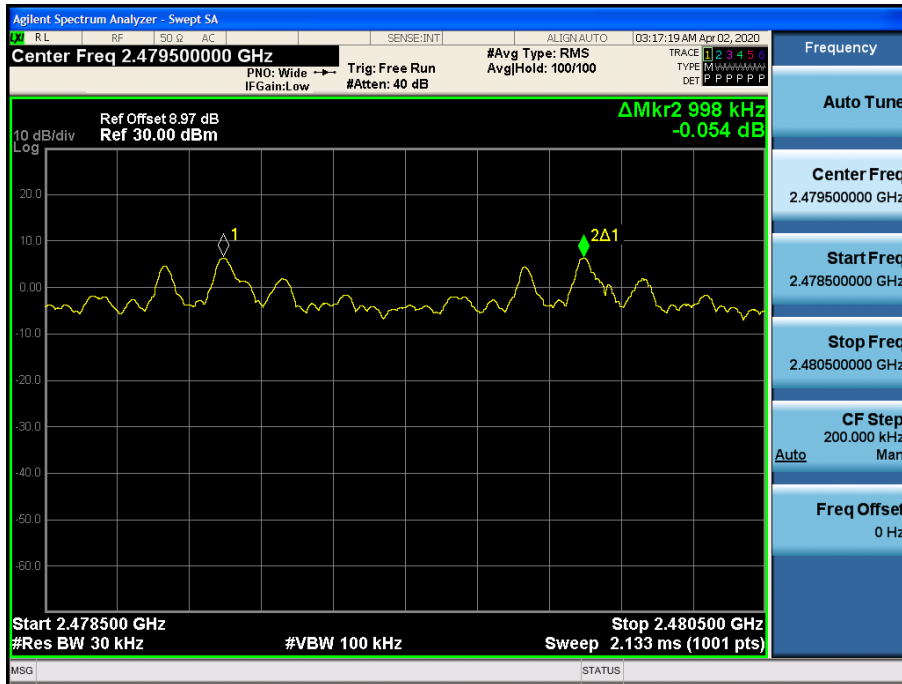

8DPSK mode-CH00





8DPSK mode-CH39



8DPSK mode-CH78



5.7 Hopping Channel

5.7.1 Limit

Frequency hopping systems in the 2400-2483.5MHz band shall use at least 15 channels.

5.7.2 Test setup

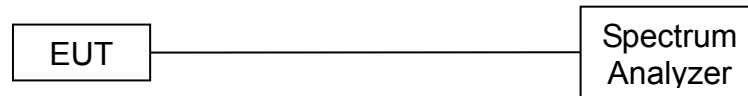

5.7.3 Test procedure

The testing follows ANSI C63.10-2013 clause 7.8.3

The RF output of EUT was connected to the spectrum analyzer by RF cable and attenuator.

The path loss was compensated to the results for each measurement.

Set to the maximum power setting and enable the EUT transmit continuously.

The EUT must have its hopping function enabled.

Use the following spectrum analyzer settings:

Span = the frequency band of operation

RBW: To identify clearly the individual channels, set the RBW to less than 30% of the channel spacing or the 20 dB bandwidth, whichever is smaller.

VBW \geq RBW

Sweep = auto

Detector function = peak

Trace = max hold

5.7.4 Test results



Mode	Quantity of Hopping Channel	Limit	Results
GFSK, $\pi/4$ -DQPSK, 8DPSK	79	>15	Pass

Test plots

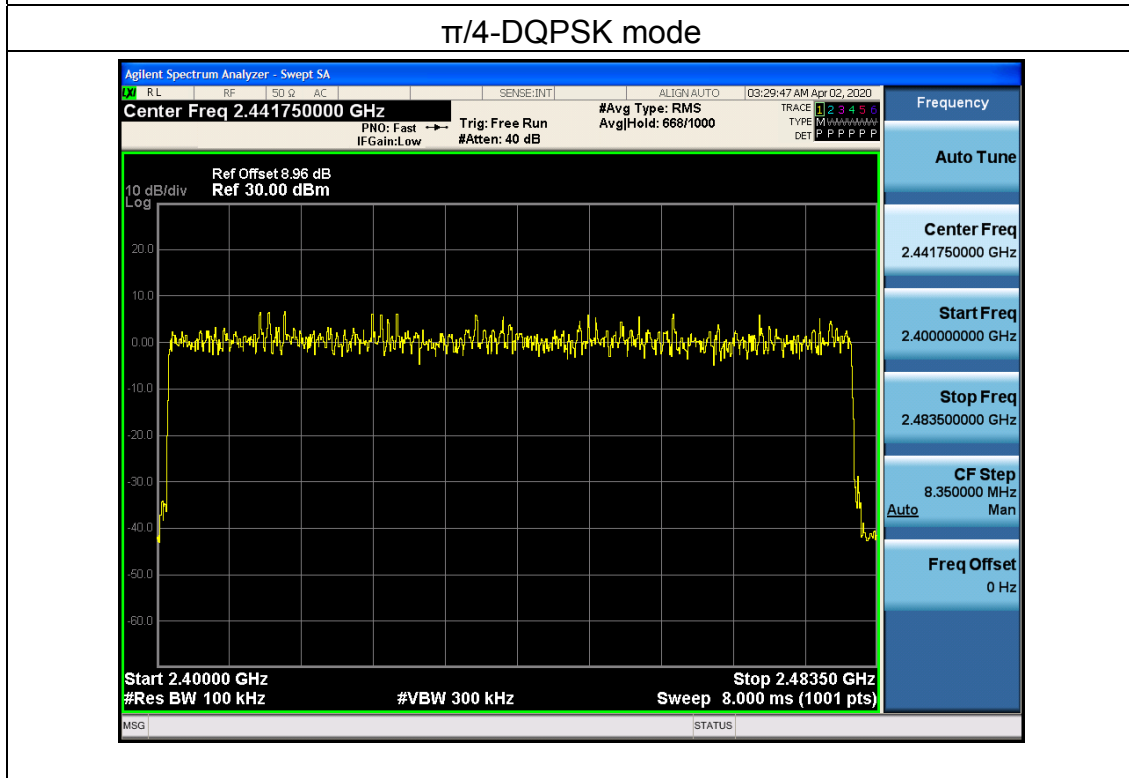
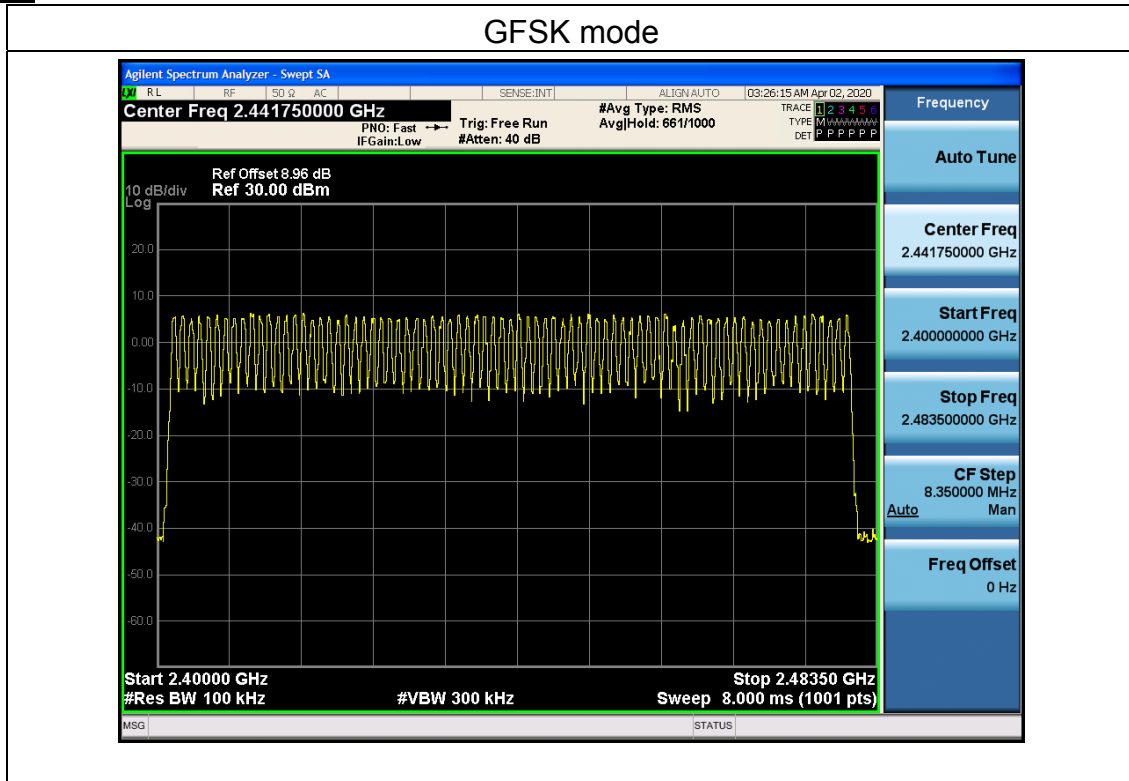

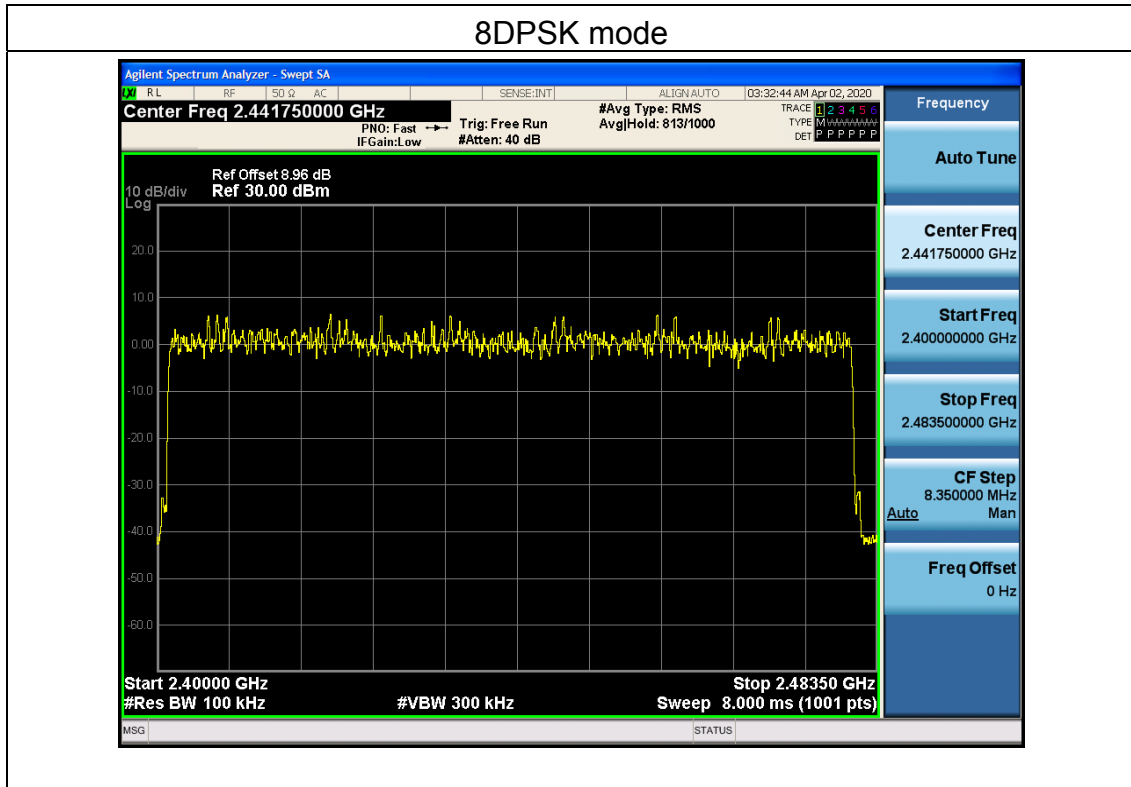

5.8 Dwell time

5.8.1 Limit

FCC Part15 (15.247) , Subpart C			
Section	Test Item	Limit	Frequency Range (MHz)
15.247(a)(1)	Dwell time	0.4 sec	2400-2483.5

5.8.2 Test setup

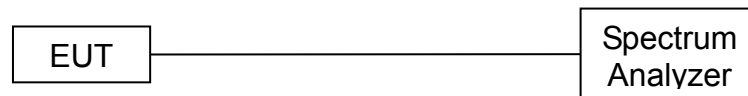

5.8.3 Test procedure

- (1) The EUT was directly connected to the spectrum analyzer and antenna output port as show in the block diagram above.
- (2) Spectrum Setting: RBW=1MHz, VBW=3MHz, Span=0Hz, Detector=Peak
- (3) Use video trigger with the trigger level set to enable triggering only on full pulses.
- (4) Sweep Time is more than once pulse time.
- (5) Set the center frequency on any frequency would be measure and set the frequency span to zero span.
- (6) Measure the maximum time duration of one single pulse.
- (7) Set the EUT for packet transmitting.
- (8) Measure the maximum time duration of one single pulse.
- (9) The EUT was set to the Hopping Mode for Dwell Time Test.

5.8.4 Test results

Test data

EUT:	Bluetooth Earbuds	Model Name:	KOSS TWS150i
Pressure:	1012 hPa	Test Voltage:	DC 3.7V from battery
Test Mode:	GFSK, $\pi/4$ -DQPSK, 8DPSK /CH39		

Mode	Data Packet	Frequency (MHz)	Pulse Duration (ms)	Dwell Time (ms)	Limit(s)	Conclusion
GFSK	DH1	2441	0.4015	128.48	<0.4	Pass
	DH3	2441	1.6560	264.96	<0.4	Pass
	DH5	2441	2.9020	309.55	<0.4	Pass
$\pi/4$ DQPSK	2DH1	2441	0.4079	130.53	<0.4	Pass
	2DH3	2441	1.6590	265.44	<0.4	Pass
	2DH5	2441	2.9030	309.65	<0.4	Pass
8DPSK	3DH1	2441	0.4079	130.53	<0.4	Pass
	3DH3	2441	1.6580	265.28	<0.4	Pass
	3DH5	2441	2.9110	310.51	<0.4	Pass

Note1: A period time = 0.4 (s) * 79 = 31.6(s)

Note2:

DH1 time slot = Pulse Duration * (1600/(2*79)) * A period time

DH3 time slot = Pulse Duration * (1600/(4*79)) * A period time

DH5 time slot = Pulse Duration * (1600/(6*79)) * A period time

Note3: For GFSK, $\pi/4$ -DQPSK and 8DPSK: The test period: T= 0.4 Second/Channel x 79 Channel = 31.6 s

Test plots

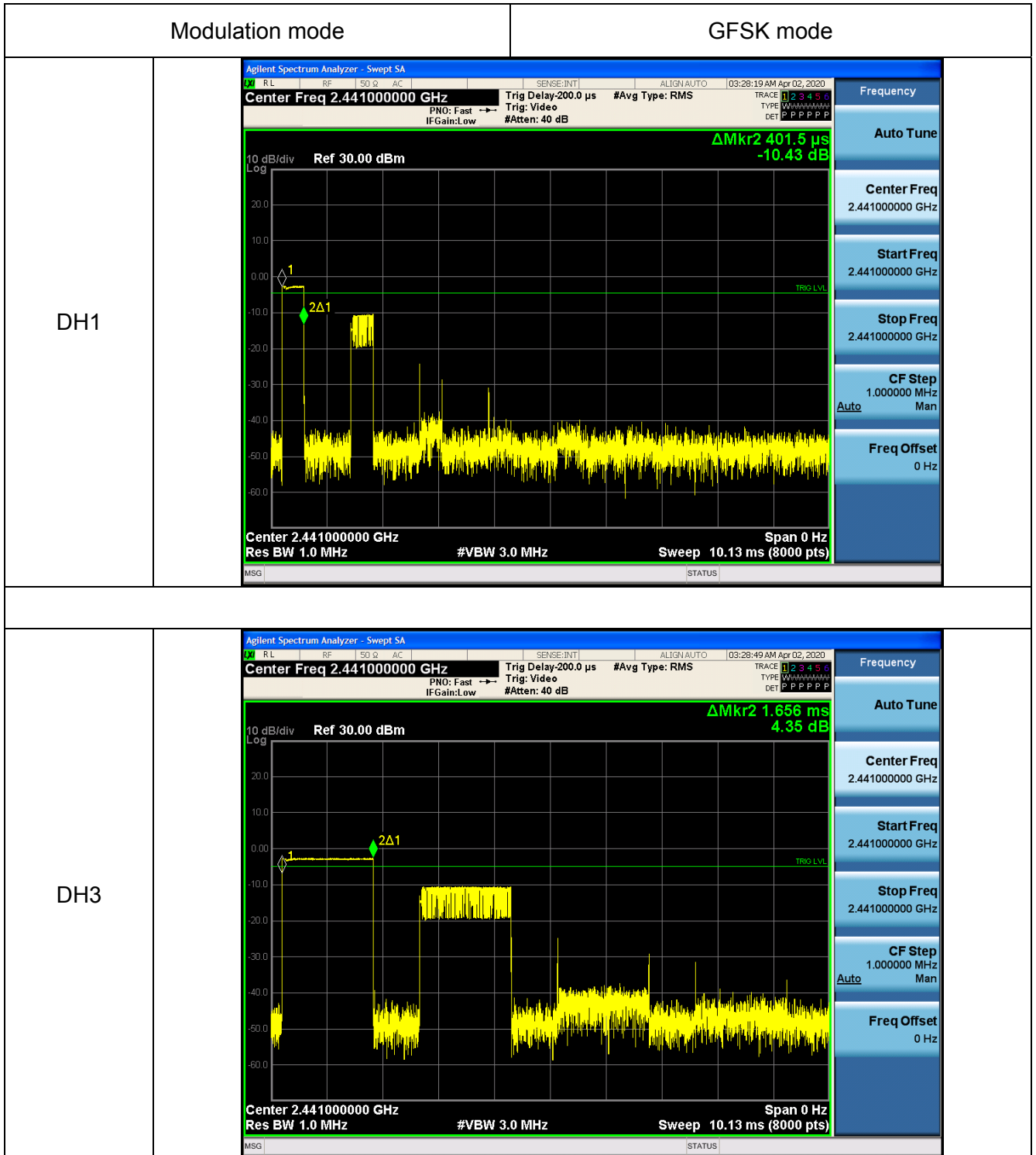

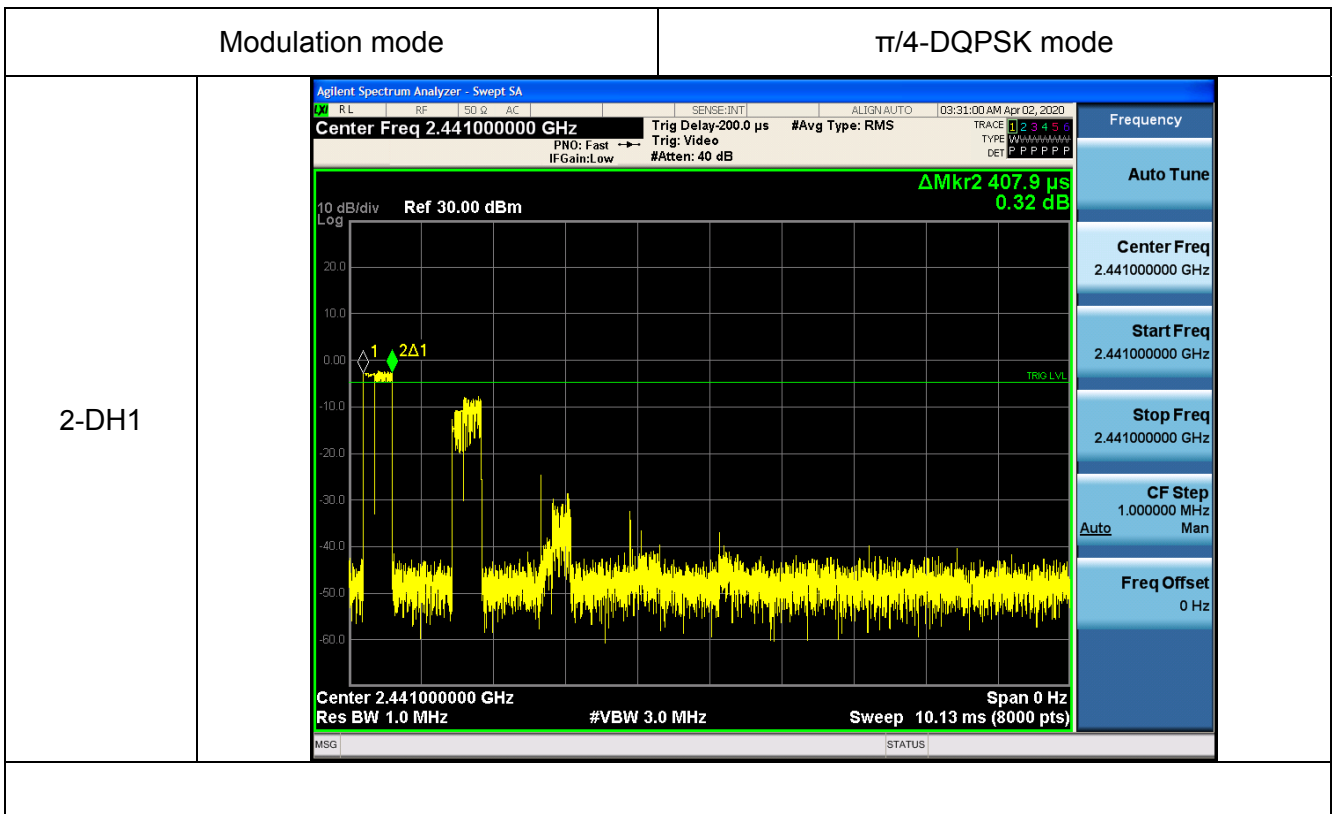
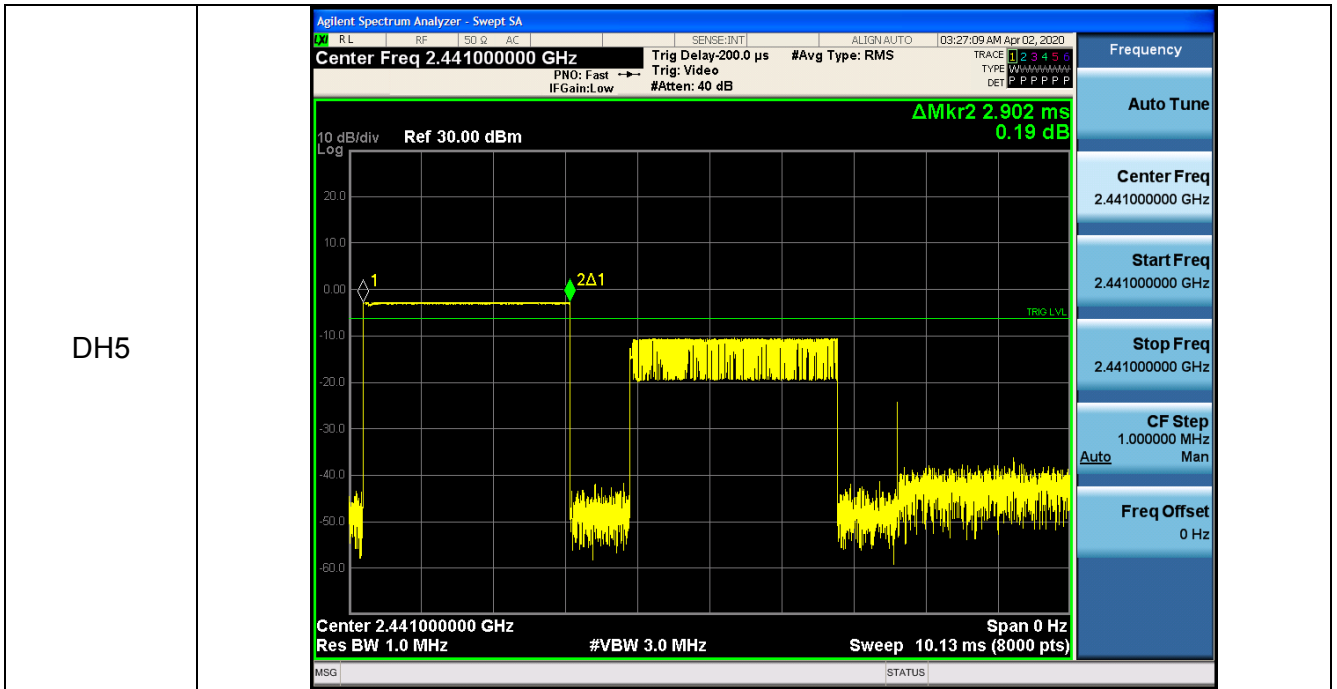

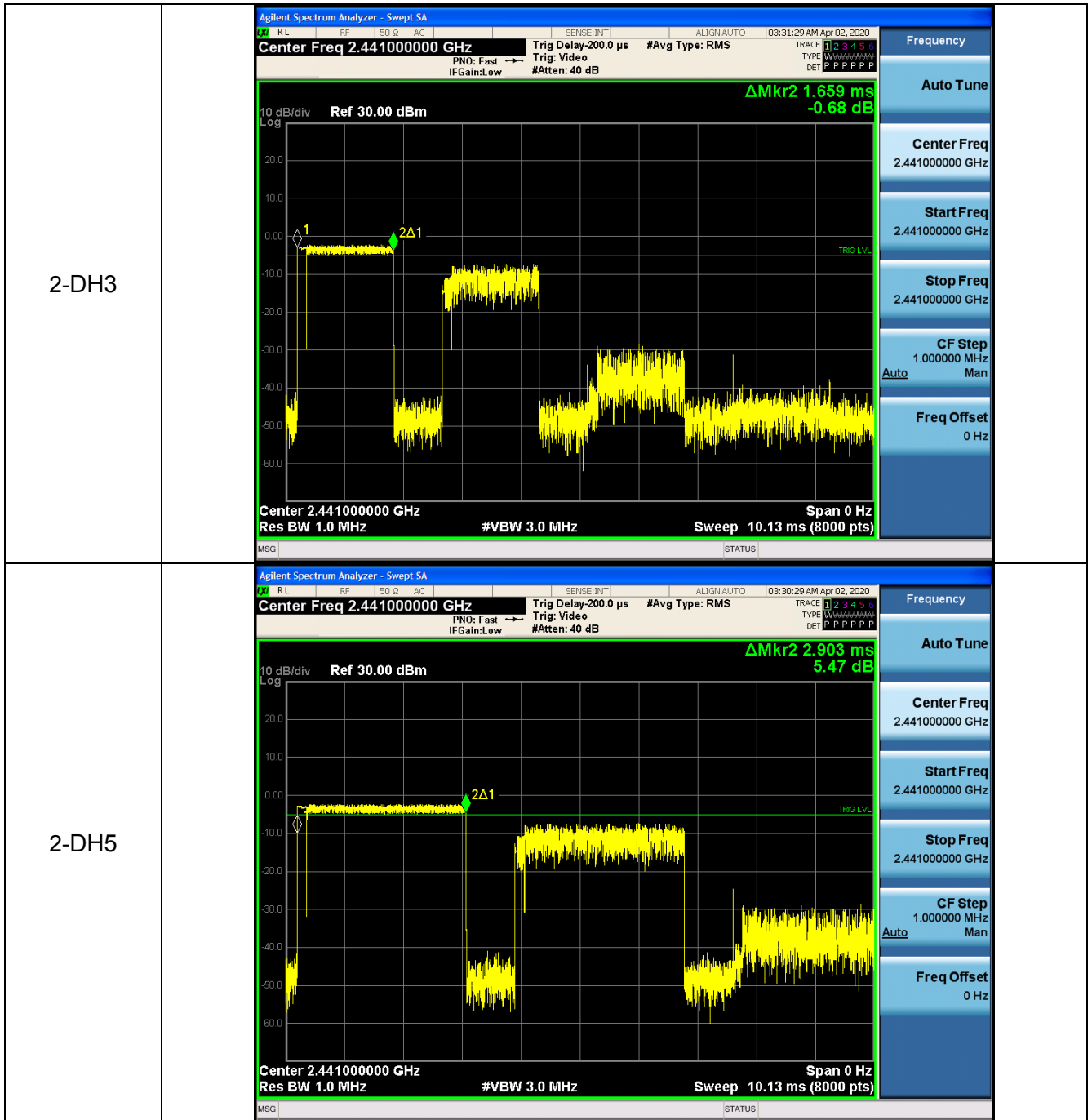

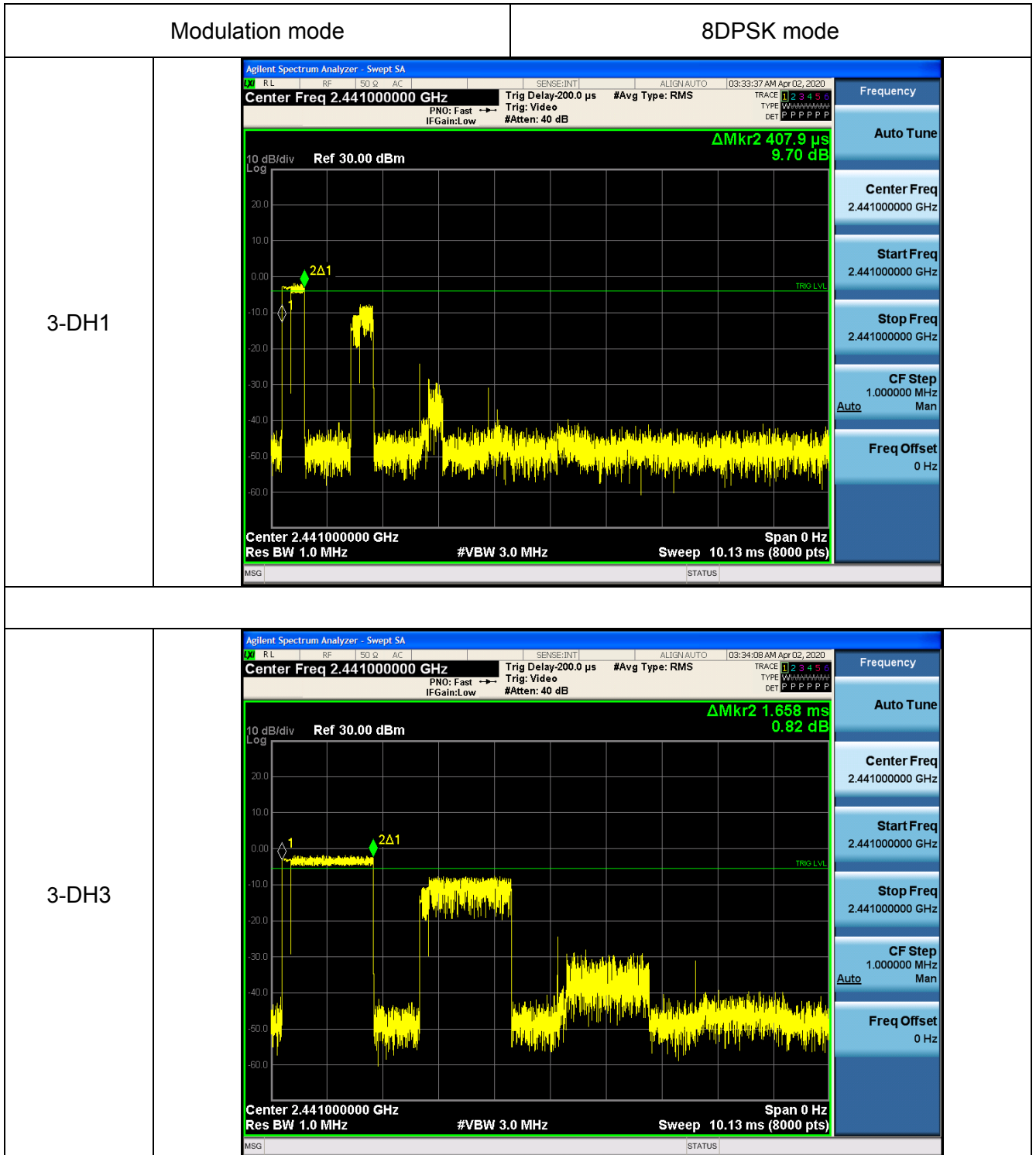

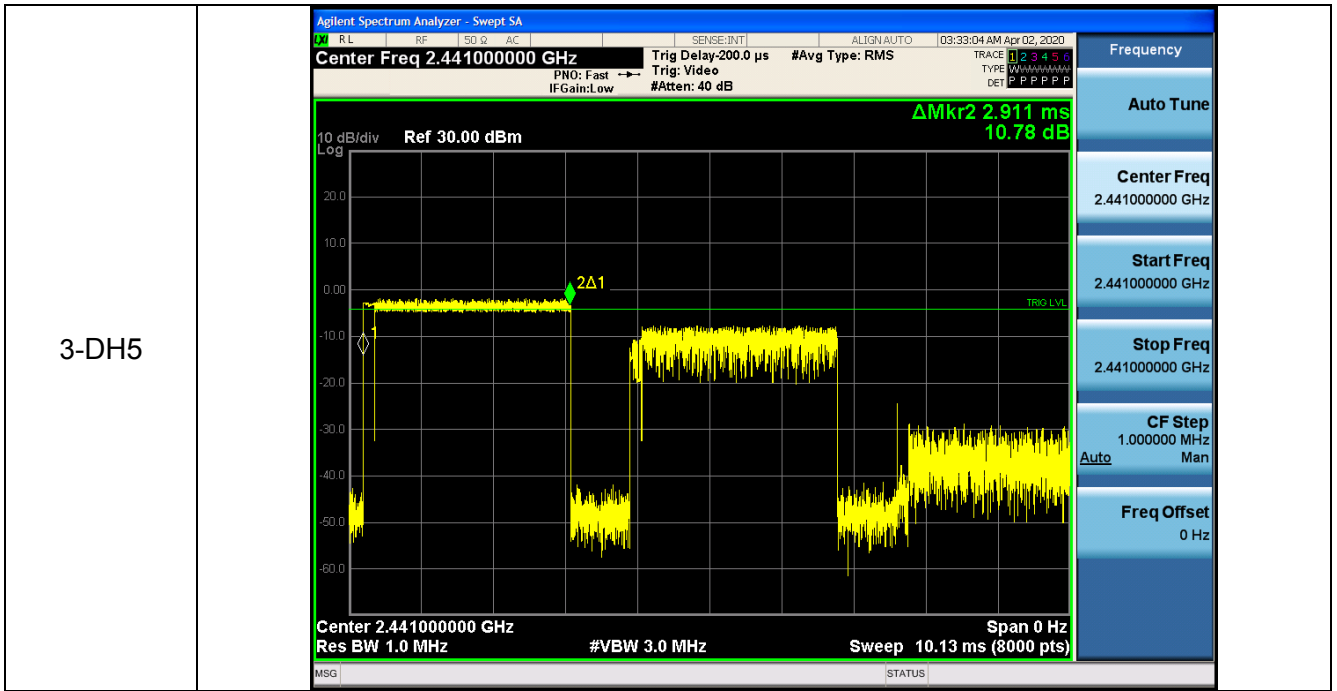

5.9 Conducted band edge

5.9.1 Limit

In any 100 kHz bandwidth outside the frequency band in which the spread spectrum or digitally modulated intentional radiator is operating, the radio frequency power that is produced by the intentional radiator shall be at least 20 dB below that in the 100 kHz bandwidth within the band that contains the highest level of the desired power, based on either an RF conducted or a radiated measurement, provided the transmitter demonstrates compliance with the peak conducted power limits. If the transmitter complies with the conducted power limits based on the use of RMS averaging over a time interval, as permitted under paragraph (b)(3) of this section, the attenuation required under this paragraph shall be 30 dB instead of 20 dB. Attenuation below the general limits specified in §15.209(a) is not required. In addition, radiated emissions which fall in the restricted bands, as defined in §15.205(a), must also comply with the radiated emission limits specified in §15.209(a) (see §15.205(c)).

5.9.2 Test setup

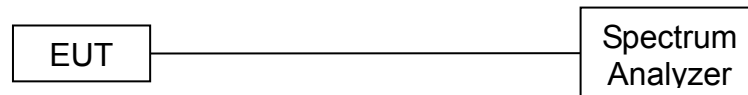

5.9.3 Test procedure

- a) Check the calibration of the measuring instrument using either an internal calibrator or a known signal from an external generator.
- b) Position the EUT without connection to measurement instrument. Turn on the EUT and connect its antenna terminal to measurement instrument via a low loss cable. Then set it to any one measured frequency within its operating range, and make sure the instrument is operated in its linear range.
- c) Set RBW to 100 kHz and VBW of spectrum analyzer to 300 kHz with a convenient frequency span including 100 kHz bandwidth from band edge.
- d) Measure the highest amplitude appearing on spectral display and set it as a reference level. Plot the graph with marking the highest point and edge frequency.
- e) Repeat above procedures until all measured frequencies were complete.

5.9.4 Test results

Test data

EUT:	Bluetooth Earbuds	Model Name:	KOSS TWS150i
Pressure:	1012 hPa	Test Voltage:	DC 3.7V from battery

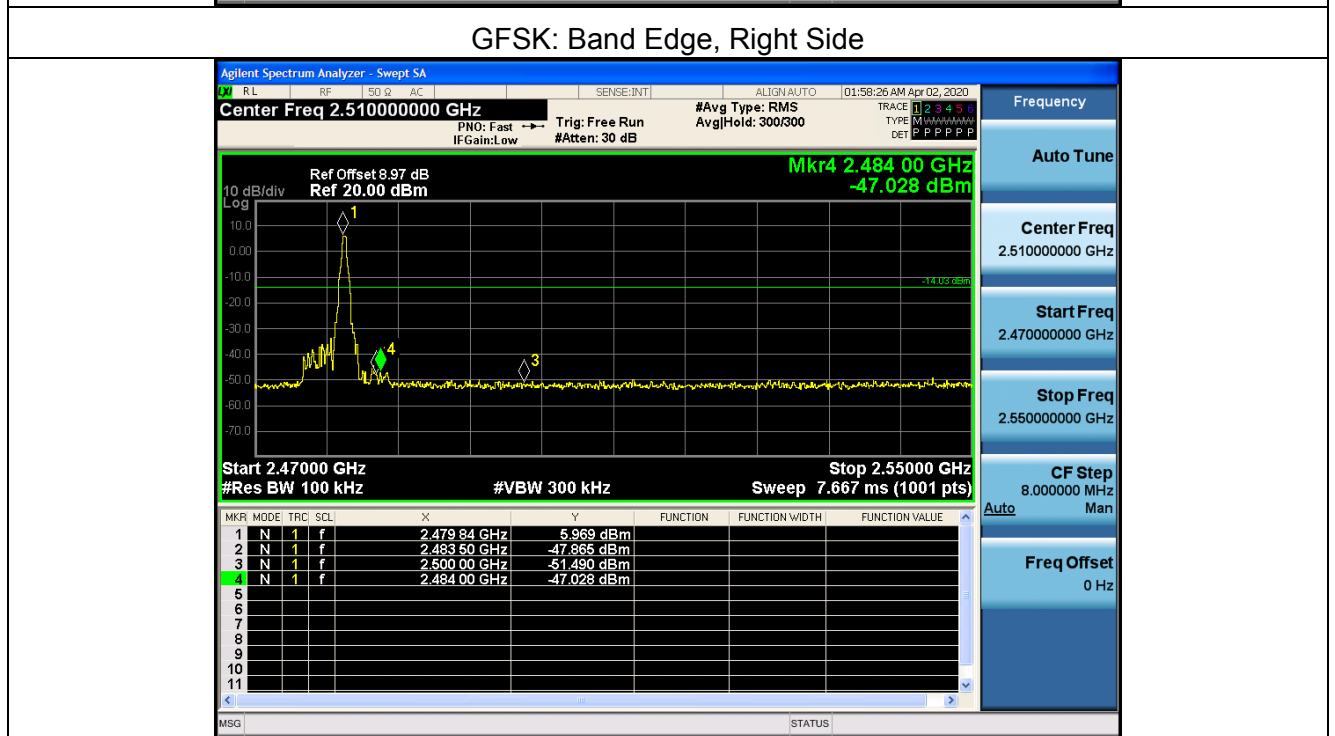
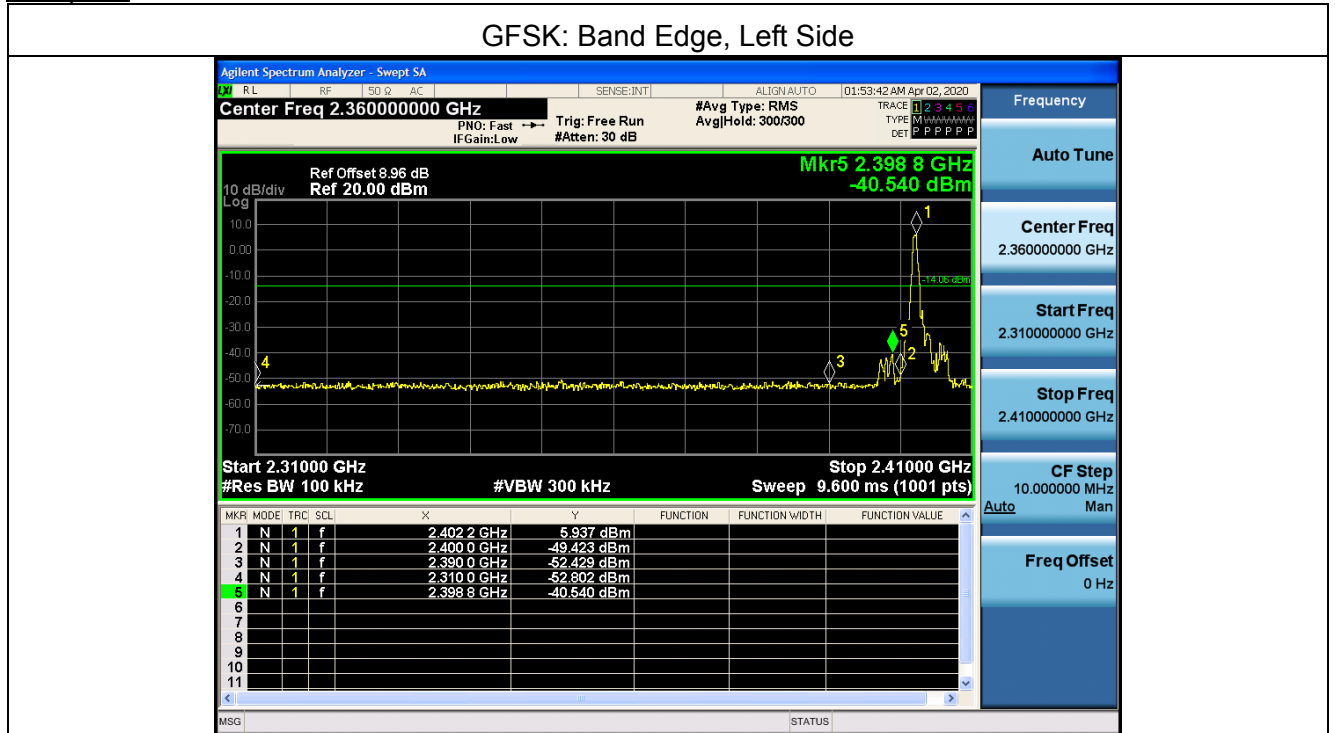
Test plots



$\pi/4$ -DQPSK: Band Edge, Left Side

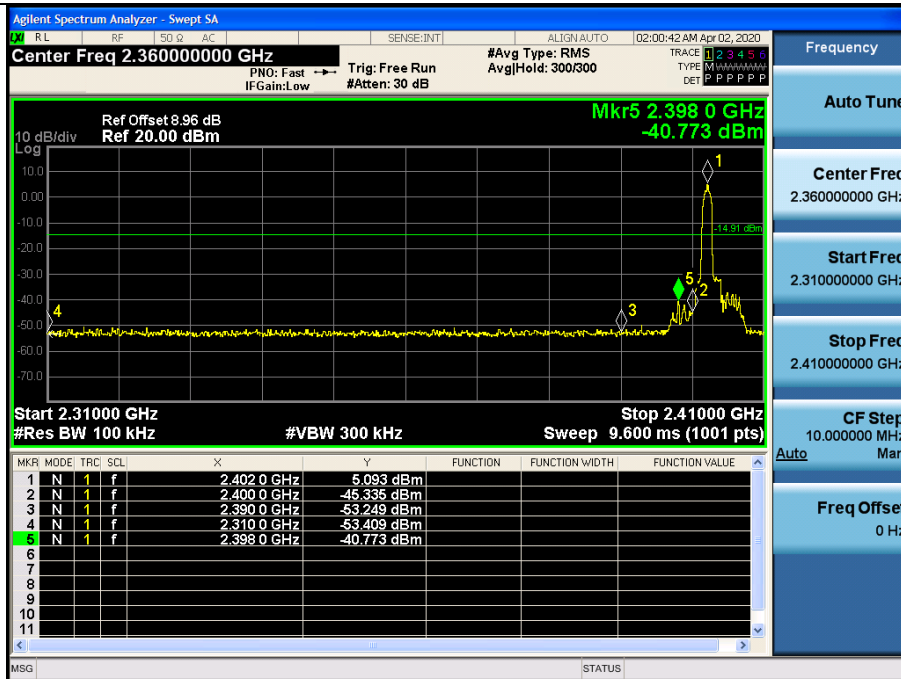

$\pi/4$ -DQPSK: Band Edge, Right Side





8DPSK: Band Edge, Left Side

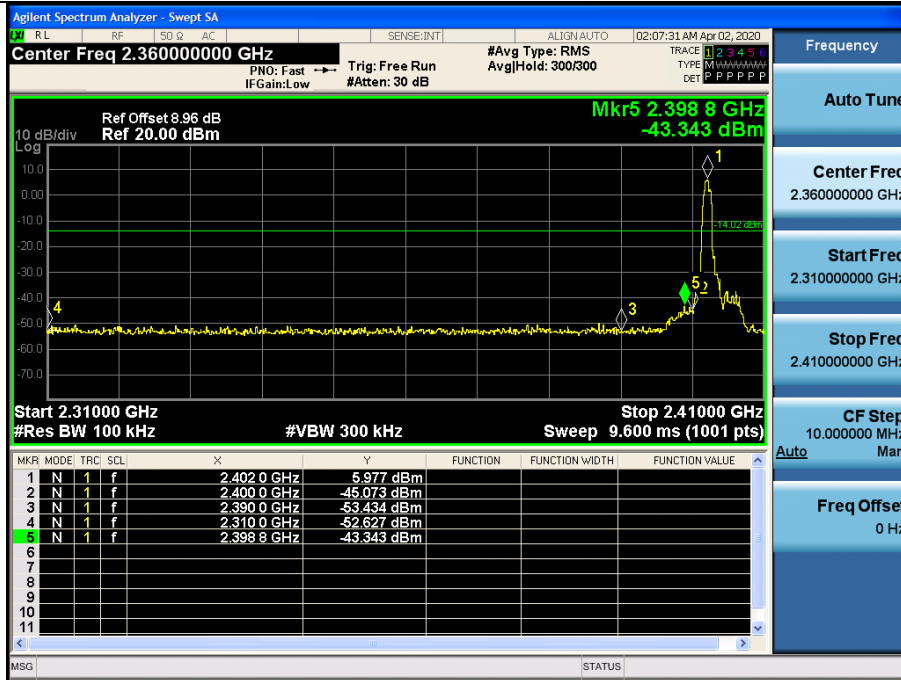

8DPSK: Band Edge, Right Side

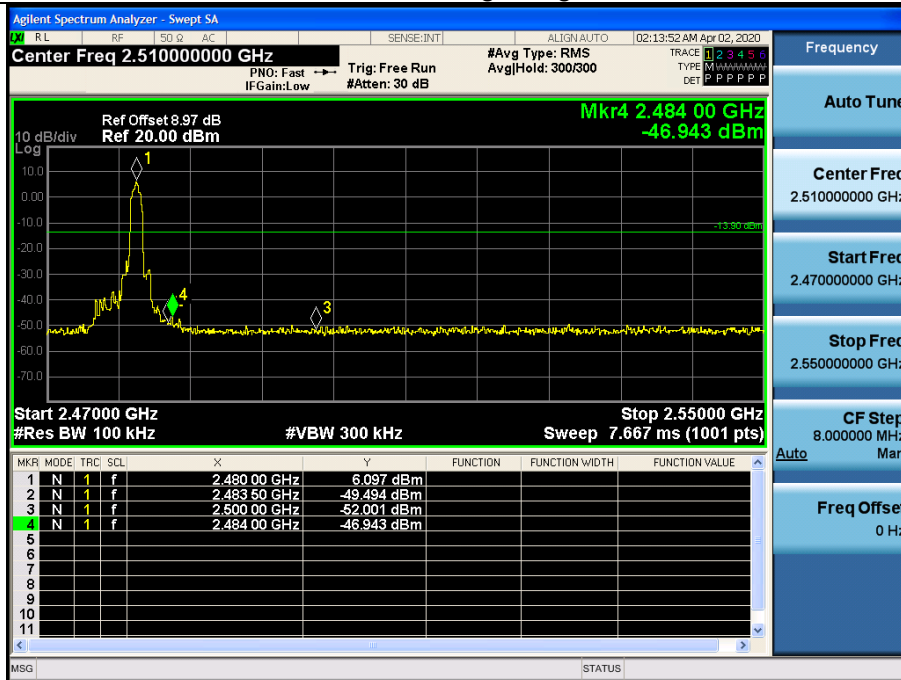

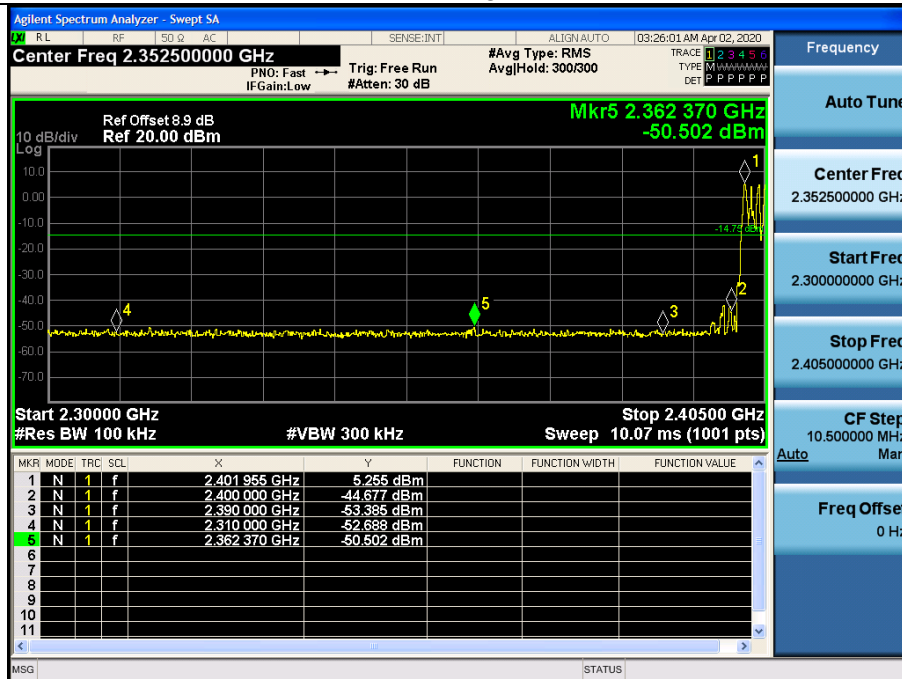
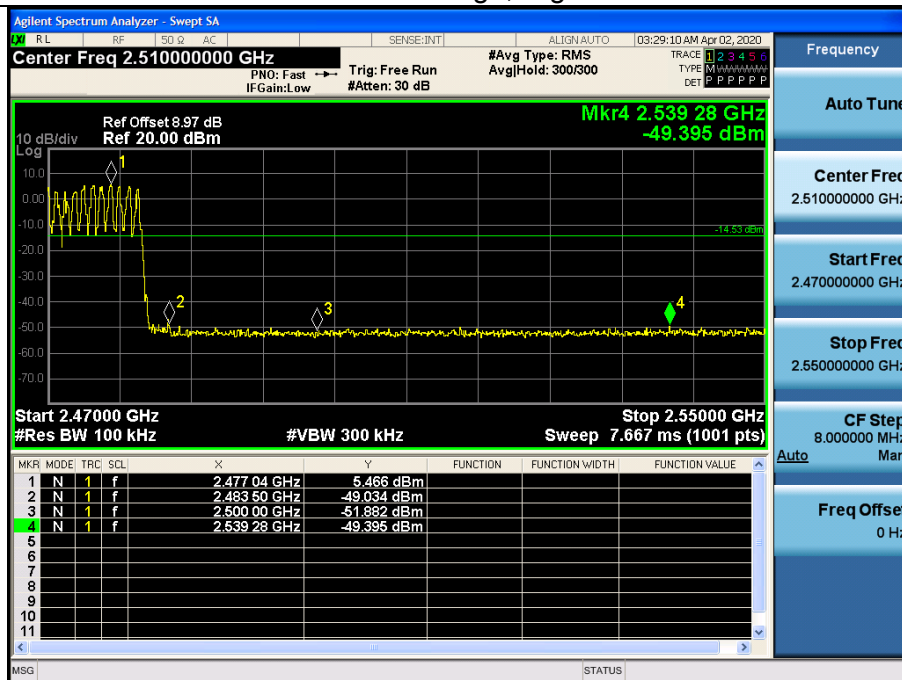
Hopping Mode
Test plots
GFSK: Band Edge, Left Side

GFSK: Band Edge, Right Side

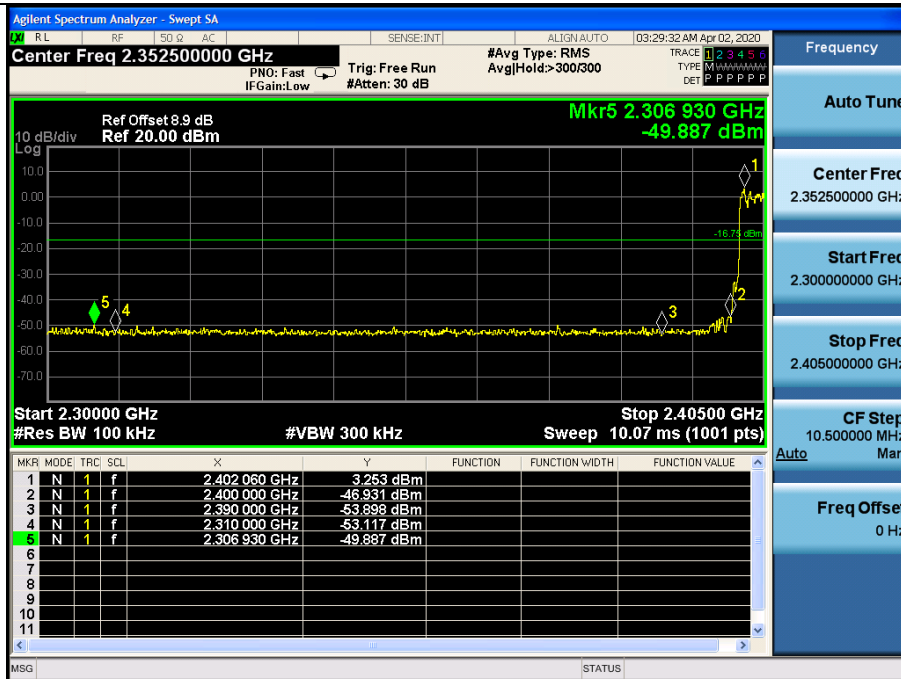

$\pi/4$ -DQPSK: Band Edge, Left Side

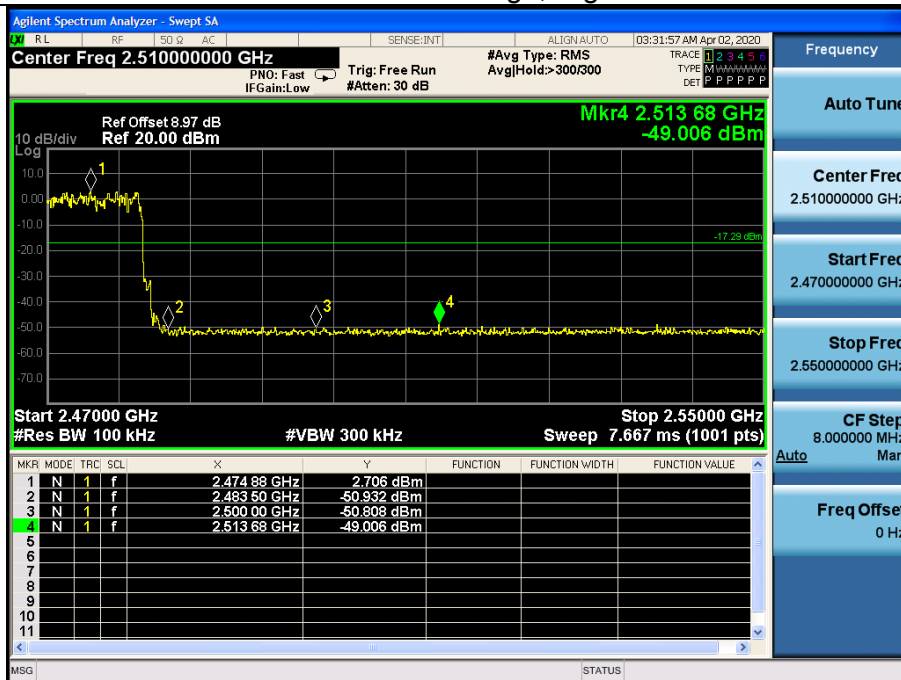

$\pi/4$ -DQPSK Band Edge, Right Side





8DPSK: Band Edge, Left Side

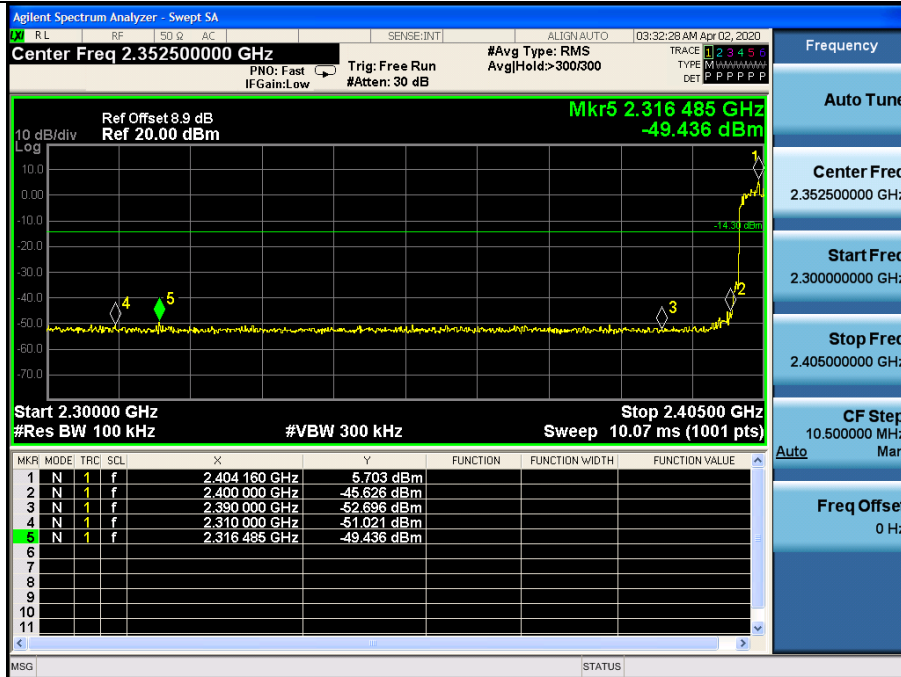

8DPSK Band Edge, Right Side

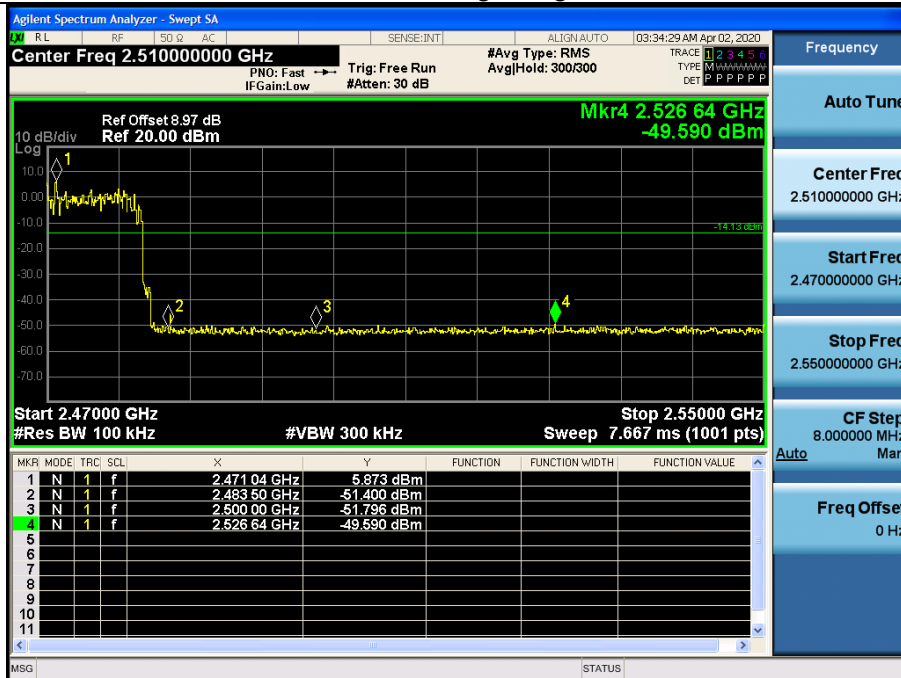

5.10 Spurious RF Conducted Emissions

5.10.1 Limit

Below -20dB of the highest emission level in operating band.

5.10.2 Measuring instruments

The Measuring equipment is listed in the section 4 of this test report.

5.10.3 Test setup

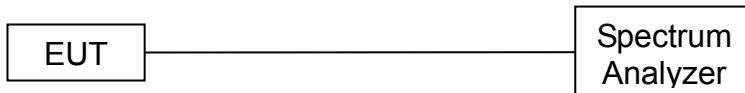

5.10.4 Test procedure

The Spurious RF conducted emissions compliance of RF radiated emission should be measured by following the guidance in ANSI C63.10-2013 with respect to maximizing the emission by rotating the EUT, measuring the emission while the EUT is situated in three orthogonal planes (if appropriate), adjusting the measurement antenna height and polarization etc. Set RBW=100kHz and VBW= 300kHz to measure the peak field strength, and measure frequency range from 9kHz to 26.5GHz.

5.10.5 Test results

Remark: The measurement frequency range is from 9kHz to the 10th harmonic of the fundamental frequency. The lowest, middle and highest channels are tested to verify the spurious emissions and band edge measurement data.

The worst mode is 8DPSK mode, and the report only show the worst mode data.

8DPSK on Channel 00

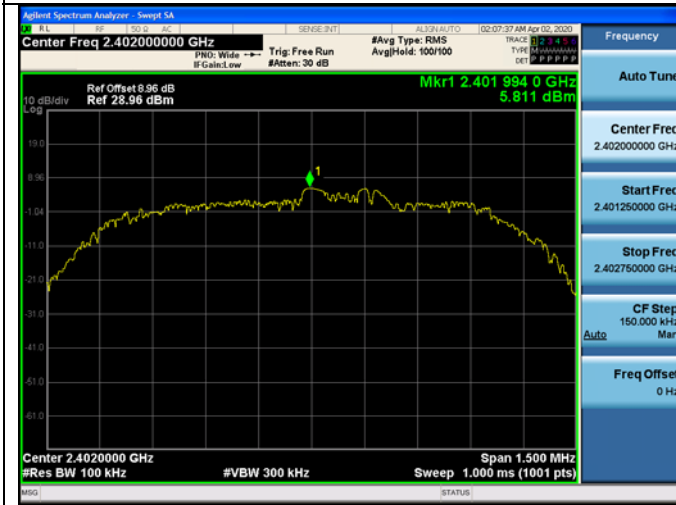

8DPSK on Channel 00

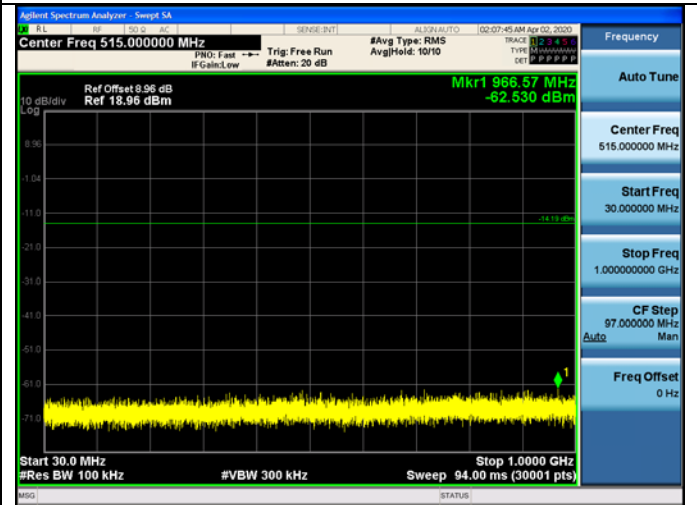

8DPSK on Channel 00

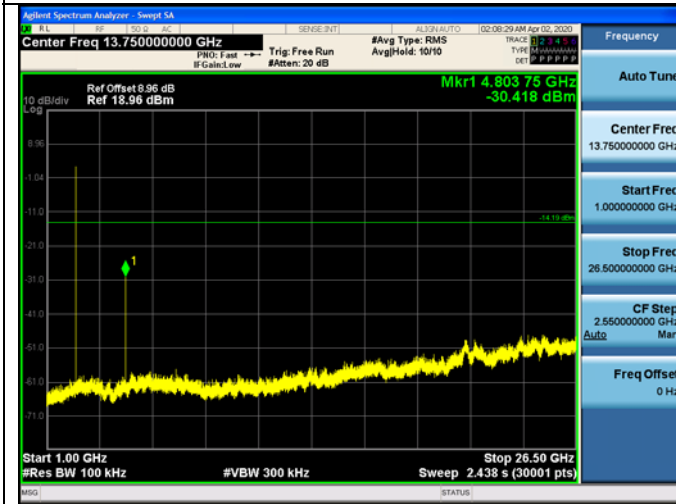

8DPSK on Channel 39



8DPSK on Channel 39

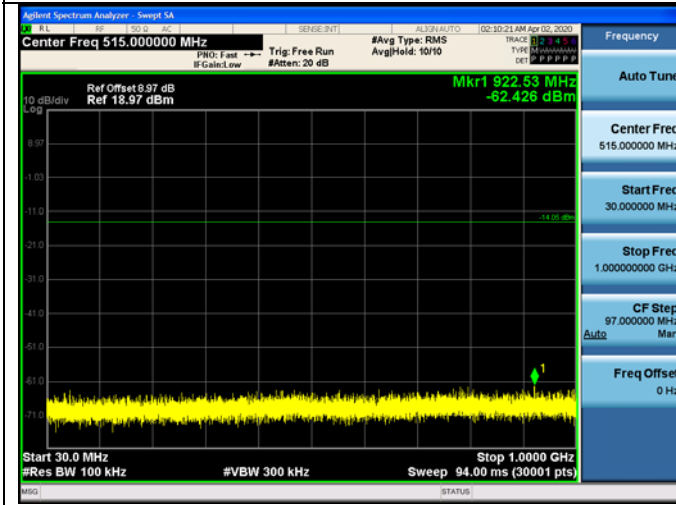

8DPSK on Channel 39

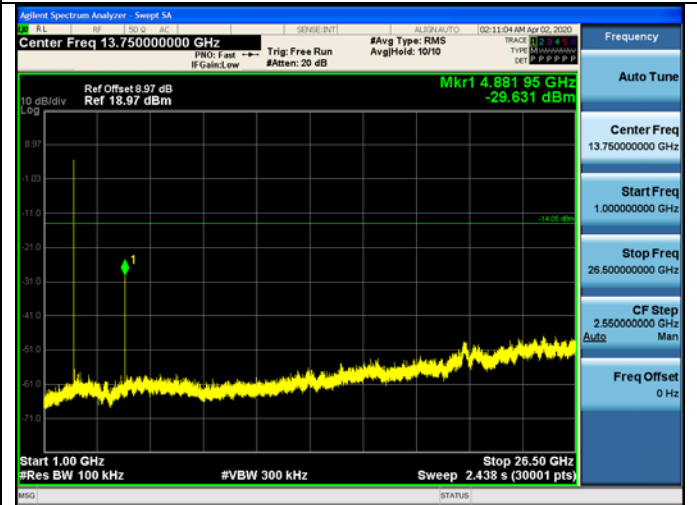



8DPSK on Channel 78

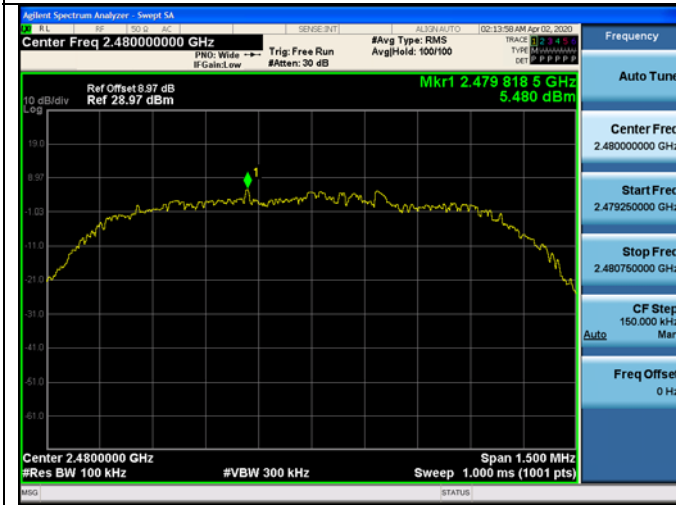

8DPSK on Channel 78

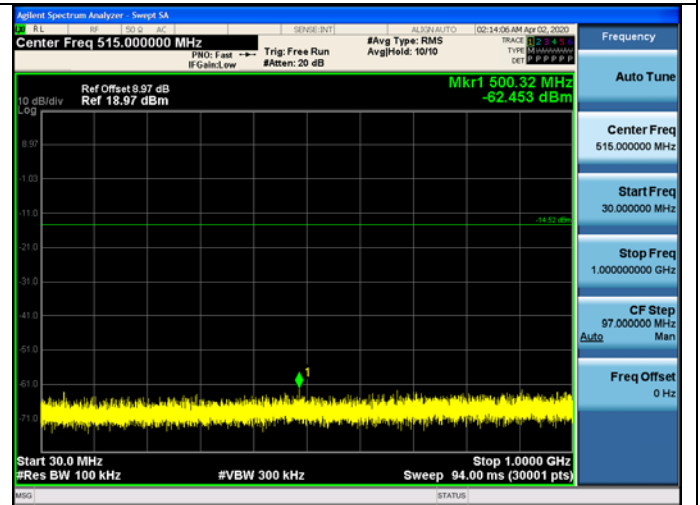

8DPSK on Channel 78

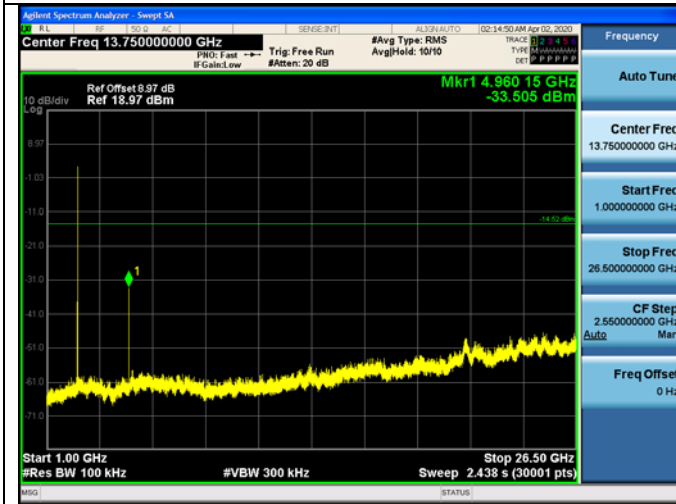

Photographs of the Test Setup

Radiated emission



Photographs of the EUT

See the APPENDIX 1: EUT PHOTO in the report No.: MTi20033010-7E1-1.

----END OF REPORT----