



# Instruction Manual on

# **EDFC ACTIVE** Electronic Damping Force Controller

## Contents

Preface Pg. 38~	Be Sure to Read Before Continuing .....38 List of Contents .....39 Precautions .....40~41 Name and Function of Each Part .....42~43
Installation Pg. 44~	Motor .....44~45 Controller Unit / Driver Unit / GPS Kit (optional) .....46 Wiring .....47 Strut Kit (optional) .....48~49
Operation Pg. 50~	Initial Setup and Basic Operations .....50~53 Control Mode .....54 Manual Mode .....55~56 Automatic Control Modes .....57~61
LCD Pg. 62~	Switching Display .....62 Optional Displays .....62~63
Change Pg. 64~	Changing Control Parameter .....64 Changing Basic Settings .....64~68
Others Pg. 69~	Reference / Troubleshooting .....69~70 Limited Warranty .....71 Specifications .....72 Quick Installation / Reference Guide .....75~76

**Quick Installation / Reference Guide at the end of this manual explains the least required procedures/tips to get you started right away.**

**Controller Unit, Driver Unit, Power Supply Filter and GPS Kit (optional) have labels with serial numbers.**

**Please refer to the cover (Pg.1) of this manual.**

### FCC COMPLIANCE STATEMENT

This device complies with Part 15 of the FCC Rules-Operation is subject to the following two conditions:

- 1) This device may not cause harmful interference, and....
- 2) This device must accept any interference received, including interference that may cause undesired operation.

 Changes or modifications made to this equipment not expressly approved by TEINI may void the FCC authorization to operate this equipment.

## Preface IMPORTANT – Read before continuing

In order to install and use the EDC ACTIVE in good condition, be sure to read this manual in its entirety to obtain a complete understanding of the constructions and functions. Please keep this manual for future reference and transfer it when the product or the vehicle is transferred to a new owner.

TEIN is NOT liable for fatal accidents, injuries, material damages, etc. caused by disregarding the contents in the manual. Please note that TEIN shall not assume ANY costs for removal, installation, relative labor, transportation, repair and loss of time.

Be sure to follow all the instructions, especially the steps with the following symbols as these involve substantial risks.

### « Meaning of Most Important Abbreviations and Symbols in this Manual »

 **WARNING** : Should a step with this indication be ignored or improperly completed, there is a risk of causing serious material damage, physical injury, an accident or even death.

 **CAUTION** : Should a step with this indication be ignored or improperly completed, there is a possibility, of physical injury or material damage.

### « Meaning of Abbreviations and Symbols in this Manual »

**CONFIRMATION** : Matter to be confirmed      **REF** : Reference       : Recommended tightening torque

**GPS** : Operations, functions etc., only enabled when optional GPS Kit is installed/used.

EDFC ACTIVE comes with the manufacturer's limited warranty. Refer to pg. 71 [Limited Warranty] for details.

- Before installation, verify that all parts are present, in accordance with the contents list.
- The shape shown in illustration may differ from the actual product.
- Republication, redistribution or reproduction of the contents of this manual, in whole or in any part, without TEIN's prior written consent is prohibited by copyright law.

Driver units have been paired (identified) with the controller at the time of shipment.

Take a note of serial numbers of driver units and how the units are installed. You will need these information for setup and troubleshooting.

Six digits following "DRI-" of serial no. are Driver ID. (Combination of numbers and letters A to F)

### MEMO

	Serial Numbers						Ft or Rr Damper	Ch1	Ch2
	ID				--				
Driver1									
Driver2									
Driver3									
Driver4									

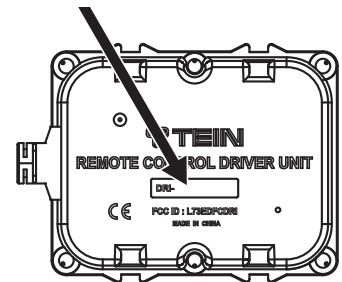

\* Write "Ft" or "Rr" damper for which damper each driver unit is used.

\* "Ch1" or "Ch2" is marked on cable tag of driver units connected to motors. Write which motor the channel is connected to.

e.g.1: For dampers with simultaneous compression/rebound adjustment (1 motor for 1 shock absorber)  
→ Write "right (R)" or "left (L)"

e.g.2: For dampers with separate comp./rebound adjustment (2 motors for 1 shock absorber)  
→ Write "R-Comp.", "R-Rebound", "L-Comp." or "L-Rebound"

\* For individual comp./rebound adjustment, 1 driver unit can control 2 motors (comp & rebound) on 1 shock absorber. (Refer to pg. 53 Table 1)

- Republication, redistribution or reproduction of the contents of this manual, in whole or in any part, without TEIN's prior written consent is prohibited by copyright law.

## List of Contents

### ● Controller Kit

Description	Qty/Kit	Part Number
Controller Unit	1	—
Driver Unit	2	EDC01-P7370
Motor Cable	4	EDC01-P8026
Power Supply Filter	1	EDC01-P8061
Ft Driver Power Cable	1	EDC01-P8024
Rr Driver Power Cable	1	EDC01-P8025
Double-Stick Tape	1	EDC02-P8023
Cable Tie	10	
Plug	2	
Plug Receptacle	2	
Spade Terminal	2	
Branch Connector	3	
Hex Screw (M6)	4	
Instruction Manual	1	—
Container Box	1	—

Note: EDFC ACTIVE hex screw (M6) replaces the one on a shock absorber, of which the motor is directly installed to the piston rod top. (Refer to pg.44)

### ● Motor Kit (sold separately)

Description Part Number	Motor Kit Part No.					
	EDK05-10100	EDK05-10120	EDK05-10140	EDK05-12120	EDK05-12140	EDK05-14140
Motor with rubber cover (M10) EDC01-K1466-1	4	2	2	-	-	-
Motor with rubber cover (M12) EDC01-K1466-2	-	2	-	4	2	-
Motor with rubber cover (M14) EDC01-K1466-3	-	-	2	-	2	4
8mm Spanner SST01-F1126	1	1	1	1	1	1
Cable Tie	4	4	4	4	4	4
Threadlocker	1	1	1	1	1	1
Grease	1	1	1	1	1	1

\* Number indicates the quantity of each content in the kit.

### <IMPORTANT>The followings should always be followed.

#### WARNING

- Install EDFC ACTIVE properly to comply with road traffic act and other related regulations.
- Never operate the product or stare at LCD while driving as it may violate the law. There is also a possibility of causing an unpredicted accident resulting in an injury or even death.
- Vehicle speeds displayed in EDFC ACTIVE are for reference only. Always drive in accordance with vehicle's speedometer.
- User takes full responsibility for the installation. Ensure that you have carefully read and fully understood this Instruction Manual before attempting installation. TEIN recommends that an inexperienced user should only install EDFC ACTIVE under qualified supervision.
- Install EDFC ACTIVE after the engine, brakes and surrounding parts completely cooled down. Immediately after driving, the engine or the surrounding parts such as piping, brakes, etc. are extremely hot and there are possibilities of serious injuries such as burns.
- Prior to installation, carefully study where and how to install EDFC ACTIVE to prevent it from coming off or interfering with normal driving operations. Improper installation may cause damages, interference with driving or accidents.
- When lifting or jacking up the vehicle for installation, always use a stopper or mount axle stands (jack stands) to secure the vehicle.
- Please ensure that there are no loose items in the driver's compartment. If any item should get caught under the brake pedal, it may dangerously cause prevention of brake operation when required.

#### CAUTION

- Never insert a flathead screwdriver or other products into the connectors to prevent damages and/or malfunctions.
- Never disassemble any EDFC ACTIVE components. If disassembled, it may be damaged/broken, may not work properly and will NOT be covered under warranty.
- As EDFC ACTIVE is precisely made, never drop or cause shock (blow) to it. If a strong shock (blow) is given, immediately stop using it and inspect it.
- Before installation, confirm that there is no excessive or sharp material on each component.
- To install EDFC ACTIVE, it is necessary to modify and/or remove parts or electronic apparatus from the vehicle. TEIN takes no responsibility for the damage of such products.
- EDFC ACTIVE runs only on 12V power supply and cannot be used on vehicles that use different voltage such as 24V.
- EDFC ACTIVE, in rare cases, might interfere with vehicle's other electronic components.
- Never connect the wire conversely or mistake the connection of the wire in order to prevent short-circuiting. If it gets short-circuit, other electronic apparatus may also be damaged.
- Before wiring, be sure to remove the key from the ignition, and disconnect the negative terminal from the battery in order to prevent short-circuiting during installation.
- If the cable is disconnected from the negative terminal of the battery, the memory contents of other electronic devices, such as the clock, car audio, etc. might be deleted. Before installation, confirm the operation of each of these functions and if necessary, please re-set after installation is completed.
- Do NOT damage, press or pull EDFC ACTIVE cable to prevent disconnection or electric leakage. Avoid giving cable a strong pull when connecting and/or disconnecting.
- When using double-stick tape, please use a neutral detergent to wipe off dust and oil from the surface prior to installation.
- Never install the control unit, the driver unit and/or the power supply filter in the following areas to prevent deformation of the case and/or malfunction.
  - Humid or dusty area
  - Any area with high temperature due to being exposed to direct sunlight or warm air from the heater
- To avoid static damage to the product, be sure to discharge static electricity through other metallic parts etc. before handling the product. Clean the product periodically to prevent dust accumulation.
- Sudden change in temperature might cause dew condensation. Let the product dry out completely before turning it on, as not doing so might cause internal damages.
- If the motor and/or driver unit are installed in a vehicle trunk, make sure these are not damaged by the baggage while driving.
- Motor and/or driver unit may become hot through operation. If these are installed near the rear seats on minivans etc., watch passengers (especially babies and small children) not to touch them. Allow the motor and driver unit to completely cool off before handling.
- Keep magnetic cards (credit cards, etc.) away from EDFC ACTIVE motor as the motor uses a strong magnet which may damage the card.

- Republication, redistribution or reproduction of the contents of this manual, in whole or in any part, without TEIN's prior written consent is prohibited by copyright law.

## Precautions

### WARNING

- NEVER use communication devices and/or electronics, such as cellular phones and PCs, near the controller unit and/or the driver unit. It may cause faulty operation because the product emits weak electromagnetic wave.

### CAUTION

- Be sure to tighten each part according to the specified torque listed in this manual.
- Disconnect the motor from the intermediate cables, when you adjust the ride height of the vehicle. It can cause the cable to break from the motor if height is adjusted while still connected.
- Never use an impact wrench for installing the parts of the shock absorber to prevent the inside nut from loosening. If the nut comes off, the piston rod may shoot out because of the high pressure of the internal gas, which is very dangerous.
- Do NOT damage the thread of the shock absorber piston rod or oscillation parts by directly handling with a tool, giving a shock (blow), dropping or hitting. If the piston rod is damaged, the oil seal may also be damaged, and it could lead to the oil leakage and/or malfunction.
- Daily inspection is driver's responsibility. After installing EDFC ACTIVE, inspect it periodically to confirm if every part is firmly connected and cleaned. If it is not used for a long period (about one month), confirm if it operates normally before using it.
- When washing the engine room (bay) with steam, be sure not to get EDFC ACTIVE motor and/or driver unit wet. If water or oil enters motor and/or driver unit, it may cause damage and user should cease use until it is inspected.
- Clean EDFC ACTIVE with a dry cloth. If it is dirty, wipe with a well-wrung cloth. Never use benzene or thinner, which may deteriorate the paint on the case.
- When disposing the product, consult your local government or waste disposers.
- Do NOT modify EDFC ACTIVE components, except as instructed in this manual or by TEIN, as it may cause performance decrement and/or breakage.
- NEVER drive radically right after installing EDFC ACTIVE.

### 【Threadlocker and Grease】

#### WARNING

- Should eye contact occur, flush eyes with plenty of water. NEVER wipe or rub eyes. Seek medical attention.
- Keep out of reach of children.
- Avoid ingestion.

#### CAUTION

- Avoid contact with skin, as it may cause skin irritation.
- In case of skin contact, wipe off immediately and wash away with soap and water.
- Never use for purposes other than what's mentioned in this manual.
- Never use near open flames or other source of ignition.
- Keep away from direct sunlight.

#### REF

- When threadlocker or grease soaks into clothing, they cannot be removed.

Description of Threadlocker Name of Article: Anaerobic adhesive agent Application: Screw slack prevention Component: Synthetic resin (100%) Net Volume: 3ml
---

- EDFC ACTIVE and this manual are subject to change for improvement without notice.
- For further details and any questions, contact TEIN customer service representative.

- Republication, redistribution or reproduction of the contents of this manual, in whole or in any part, without TEIN's prior written consent is prohibited by copyright law.

# Name and Function of Each Part

## 【Controller】

Front Face

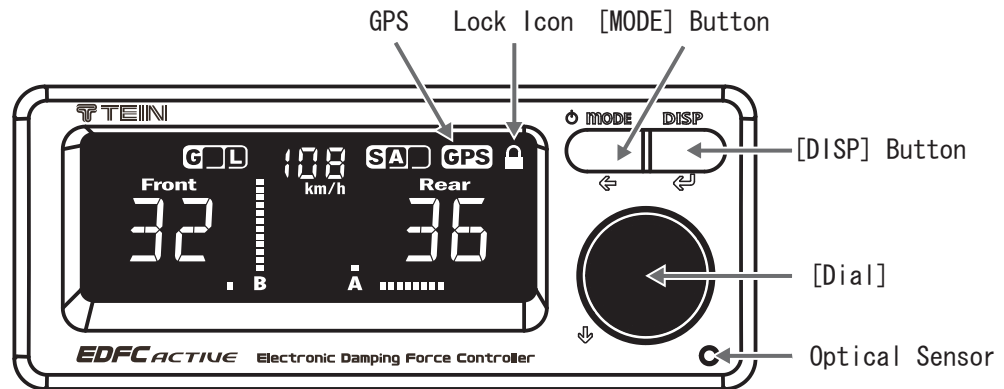

- [MODE] Button : For switching control modes and returning to the previous menu
- [DISP] Button : For switching displays and for completing the setting operation
- [Dial] : Turn to select setting items and press to confirm.
- Optical Sensor: For Automatic Dimmer Function (For settings, refer to pg.64 "1-6".)

[Examples for Operational Figures in This Manual]

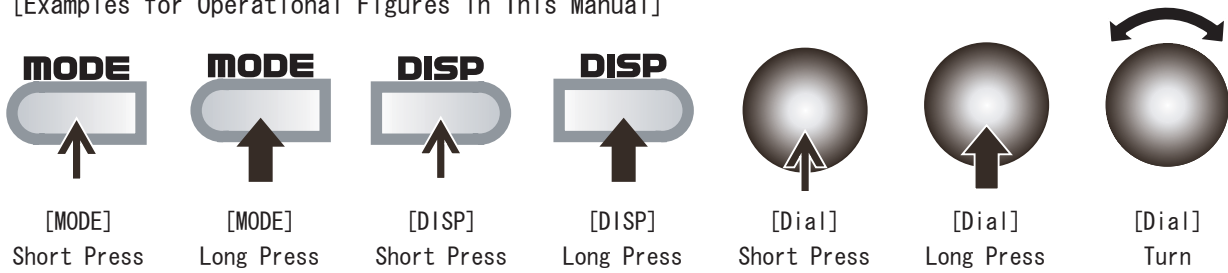

- LCD Screen

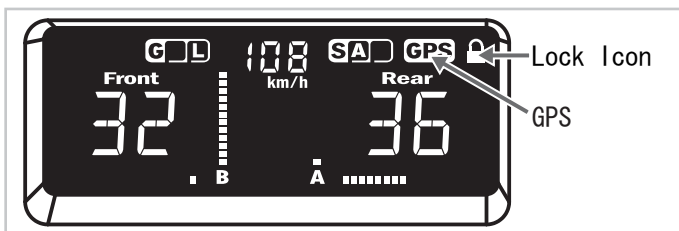

Common Display

- Lock : When this symbol illuminates, operation is locked. (See pg.50 to cancel.)
  - GPS : "GPS" icon comes ON when GPS unit is connected/detected and blinks if not connected/detected.
- \*For other displays, refer to explanations of each mode (pg.55~).

## 【Controller Wiring】

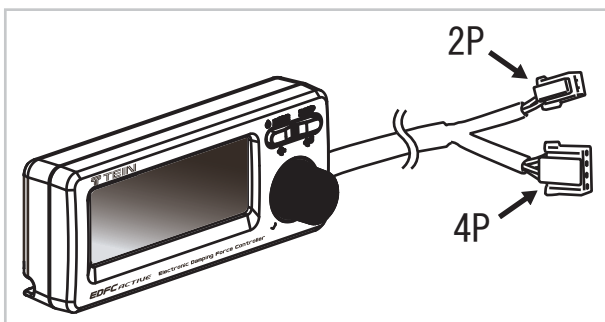

- 4P Connector : For connecting to optional **GPS** Kit
- 2P Connector : For connecting to the power supply filter

- Reproduction, redistribution or reproduction of the contents of this manual, in whole or in any part, without TEIN's prior written consent is prohibited by copyright law.

## 【Driver Unit】

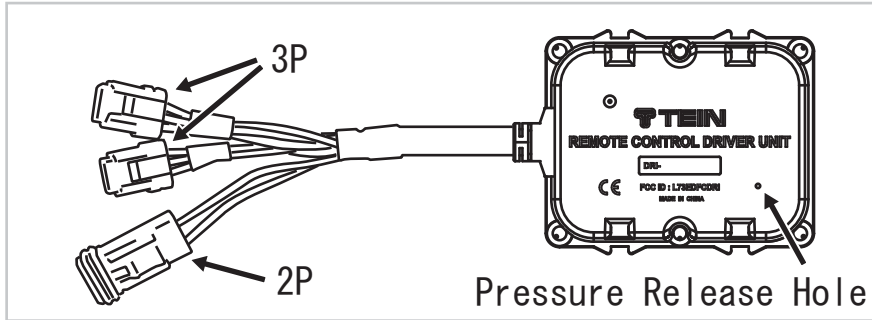

Driver unit receives signals from the controller and sends commands to each motor.

- 3P Connector x2  
For connecting to the right and left EDFC ACTIVE motors
- 2P Connector  
For connecting to the power cable included in the kit

⚠ **CAUTION** Do NOT put double-stick tape on the outer metal surface. The tape may come off because of high temperature.

⚠ **CAUTION** The small hole on the surface with "TEIN" logo is to release pressure. Do NOT cover the hole when installing.

REF Take a note of driver IDs in pg. 38. You will need these for setup.

REF "Ch1" or "Ch2" is written on each motor cable. Connect cables following directions in pg. 47 and take a note in pg. 38

## 【Power Supply Filter】

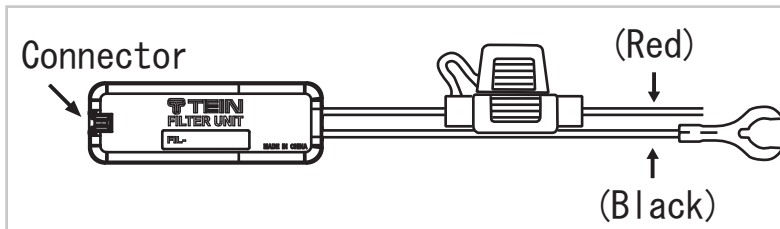

- Connector ... For connecting to the controller
- Wire (red) ... For connecting to the accessory power supply
- Wire (black) ... For grounding

## 【GPS Kit】 Optional

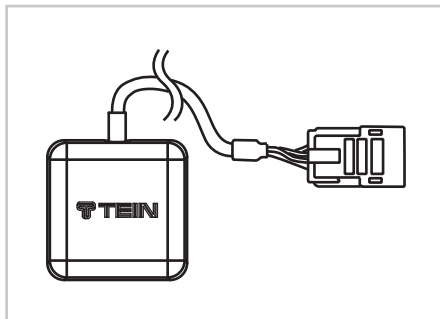

GPS unit determines its position and calculates vehicle speed based on the information received from the satellites.

- Connector : For connecting to controller

⚠ **CAUTION** GPS unit needs to recognize at least four valid signals from the satellites to start working and this usually takes 30 seconds to 1 minute after the power is turned on. If the vehicle moves before receiving enough satellite signals, it may take longer to recognize.

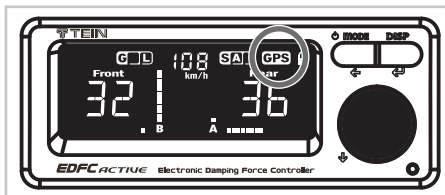

After turning on the power, wait until GPS unit receives valid signals to move the vehicle (GPS lamp will change from blinking to ON).

**CONFIRMATION** Affix a serial number label included in the kit to GPS section of the chart on the cover of this manual.

REF Depending on locations/circumstances, GPS signals may be weak or unavailable.

- Republication, redistribution or reproduction of the contents of this manual, in whole or in any part, without TEIN's prior written consent is prohibited by copyright law.

# Installation

Below explains the installation of **motor** , **controller** and **wiring** .

## Motor

Install the motor after assembling the shock absorber, spring and upper mount. Then, screw the top nut firmly to the designated torque because it is difficult to tighten it after installing the motor. If it is difficult to install the motor to the vehicle on which the shock absorbers are already installed, we recommend installing the motor after detaching the shock absorber. In this case be careful not to give a shock (blow) to the motor.

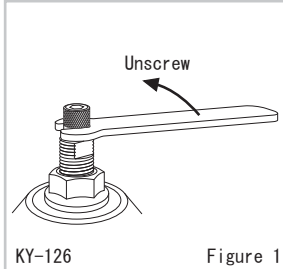

Figure 1

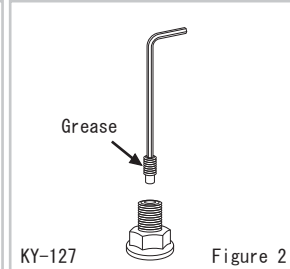

Figure 2

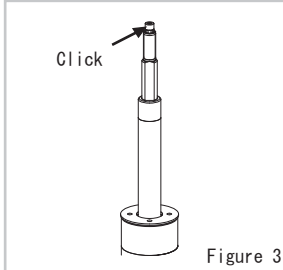

Figure 3

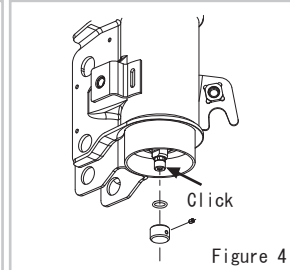

Figure 4

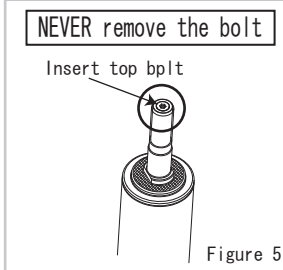

Figure 5

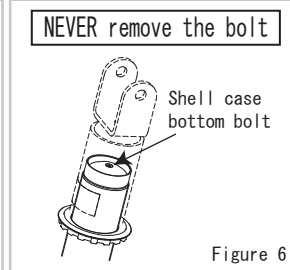

Figure 6

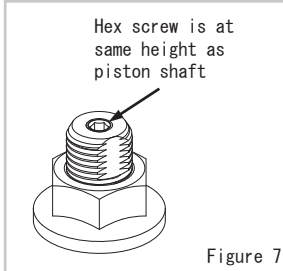

Figure 7

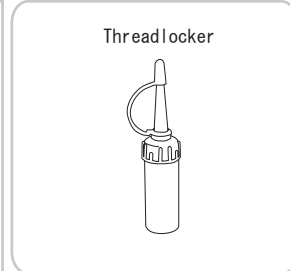

Figure 8

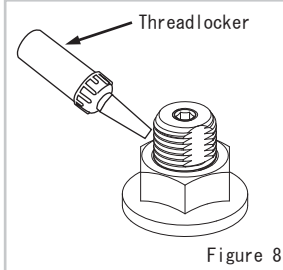

Figure 8

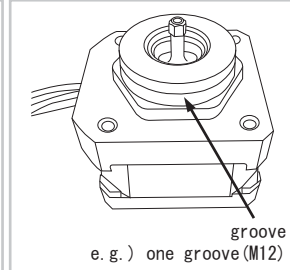

Figure 8



- 1) Remove the silver click and exchange hex bolt.
  - Remove the click by turning counter-clockwise with the black 8mm spanner wrench included in the motor kit. (Figure 1)
  - Remove the black hex bolt inside with the 3mm hex wrench.
  - Apply the grease (red, included in the motor kit) to the inner thread and gold hex bolt's threaded part and inside of the hex hole. Then, put the gold hex bolt until its top becomes flush with the top surface of the shaft (Figure 7).

**REF** You can use general Molybdenum grease instead.

- CAUTION** Keep the removed click for re-installation.
- CAUTION** Do NOT turn the shock absorber upside down while its hex bolt is removed. Inner parts may come off.
- CAUTION** Remove anti-loosening agent residue on threaded part of piston shaft, as such residue may cause motor to malfunction.

The click is located at the top of the piston rod (upright type shock absorber, Figure 3) or at the bottom of the shell case (inverted type shock absorber, Figure 4).

- CAUTION** NEVER remove bolts at the top of the piston rod (Figure 5) and/or at the bottom of the shell case (Figure 6) if any. Removing such bolt might cause enclosed gas to leak and/or inner parts to pop out.

- 2) Check thread size on piston shaft and match to motor with the same size thread. (Some motor kits have different size motors for front and rear.)

**REF** The size of the motor can be distinguished by the distinction groove outside the shaft attachment part. (M10: without groove, M12: One groove, M14: Two grooves)

- 3) Shake the threadlocker bottle (green liquid, included in the motor kit) well (about ten times) before each use, as its ingredients might be separate.
  - 4) Apply the appropriate amount of threadlocker to the male thread on the piston shaft. (Figure 8)
- CAUTION** NEVER apply the threadlocker to the female thread of the hexagon socket set screw as it will prevent the screw from turning.



# Installation

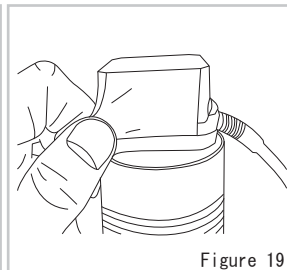
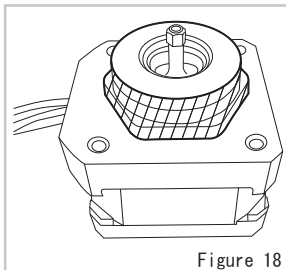
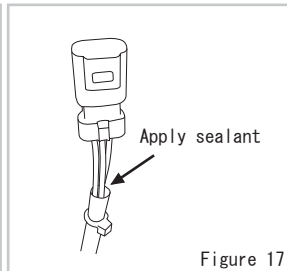
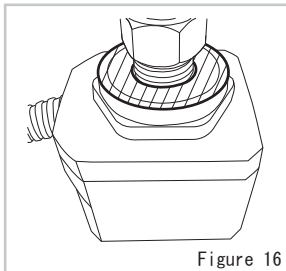
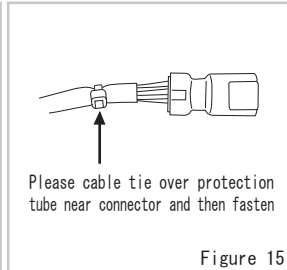
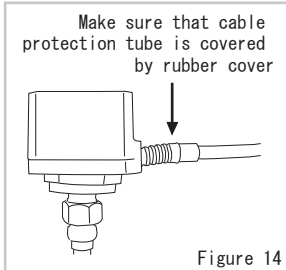
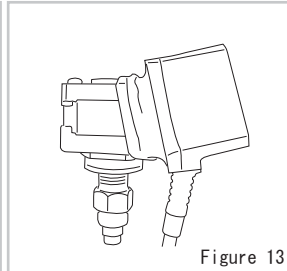
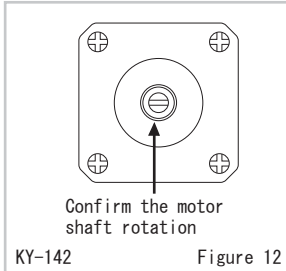
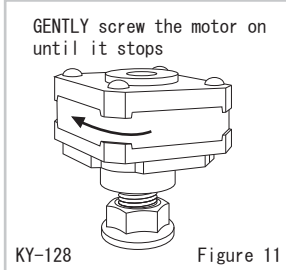
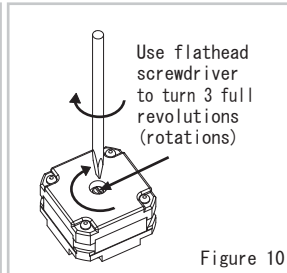
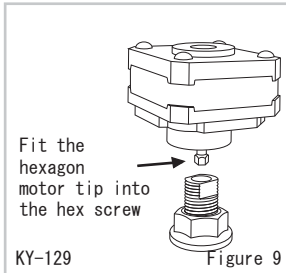

- 5) Fit the hexagon tip of the motor of the EDFC ACTIVE into the hex screw included in the motor kit. (Figure 9)
  - ⚠ CAUTION Screw them only by hand during installation, as the motor and other parts are precisely made. Be sure not to impose stress to them.
- 6) Hold the motor by hand and use a flathead screwdriver to turn the slotted screw located on the top center section of the motor 3 full revolutions in the clockwise direction. (Figure 10)
- 7) Gently screw the motor in the clockwise direction onto the piston shaft until it stops. (Figure 11)
- 8) Use a flathead screwdriver to screw the slot 2 full revolutions in the clockwise direction.
- 9) Now fully screw the motor with the designated torque.
  - 🔩 3 N·m (0.3kgf·m, or the same as the torque for M5 screw)
  - ⚠ CAUTION Be careful not to impose stress to the black-colored part (core part) on the side of the motor with tools, etc. If stress is imposed, the motor may be broken. Also, NEVER screw the motor with the torque of over 12Nm or turn it further than 45 degrees from the hand-tightened position. Otherwise, the motor may be damaged.
- 10) Confirm that the motor shaft turns by using the flathead screwdriver to turn the slot counter-clockwise 1 revolution and then back clockwise 1 revolution. (Figure 12)
  - ⚠ CAUTION Confirm if the motor shaft rotates smoothly after the motor is screwed on. If not, some parts may be broken or incorrectly installed. In this case, remove the motor and check that no parts are broken.
- 11) Attach rubber cover on motor. (Figure 13, 14)
  - ⚠ CAUTION Handle rubber cover with extra care. Pulling by great force may cause damage. Avoid leaving any gap between rubber cover and motor. Make sure that cable protection tube is covered by rubber cover. Be sure to attach rubber cover properly. Failure to do so might cause dust or water to enter and as a result damage or shorten the life of motor.
  - REF Apply a small amount of rust proof or grease to rubber cover opening for easier installation.
- 12) Place cable tie over the protection tube near connector and then fasten. (Figure 15)
  - ⚠ CAUTION Be sure to fasten tube with cable tie. Failure to do so might cause dust or water to enter and as a result damage or shorten the life of motor.
- 13) Apply sealant to the shaded area in Figure 16. The motor might get wet depending on where it's installed. Opening of cable protection tube needs to be sealed up with silicon sealant as well. (Figure 16, 17)
  - For installation on inverted type damper
    - When installing motor onto inverted type damper, apply sealant to the shaded are in Figure 18, attach motor to damper, and then put rubber cover on.
    - REF If rubber cover is uneven or its opening end is rolled up, fix by pulling and releasing corners several times. (Figure 19)

● Republication, redistribution or reproduction of the contents of this manual, in whole or in any part, without TEIN's prior written consent is prohibited by copyright law.

# Installation

## Controller

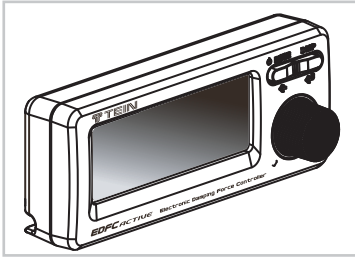

Controller unit can be installed using a hook and loop fastener or a double-stick tape, depending on the location and/or the preference. Fix it securely so that the controller does not vibrate during driving.

**WARNING**

Before installation, carefully examine where and how to install it as it should never fall off or interfere with driving.

Incorrect installation and/or inadequate positioning is dangerous, as it might cause vehicle damage and interfere with driving.

**CAUTION**

NEVER install the controller unit in the following areas to avoid malfunctions:

- Humid or dusty
- Any area which becomes high temperature, i.e. places exposed to direct sunlight, near heater outlets

**CAUTION**

If not securely installed, the controller might not be able to detect G-force stably. This may shorten the life of the apparatus and/or suspension.

**CAUTION**

NEVER install the controller unit near communication devices, such as cellular phones, Bluetooth and wireless LAN. It may cause miss operation.

**REF**

When using double-stick tape, please use a neutral detergent to wipe off dust and oil from the surface prior to installation.

**REF**

G-force might not be detected properly, if the controller unit is installed at a greater angle. Adjust the controller unit so the screen is facing within 45 degrees to the opposite direction of travel, both horizontally and vertically.

## Driver Unit

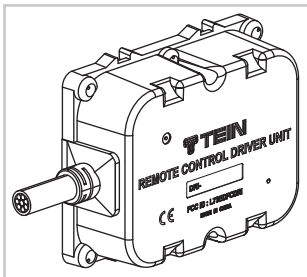

Anchor the driver unit using a cable tie or double-stick tapes.

**CAUTION**

Allow the driver unit to completely cool off before handling. It may become hot while operating.

**CAUTION**

Do NOT install the driver unit in the following areas to avoid malfunctions:

- Humid or dusty area
- Any area which becomes high temperature, i.e. places exposed to direct sunlight, near heater outlets

**CAUTION**

Do NOT place any objects around the driver unit.

**CAUTION**

Do NOT put double-stick tape on the metal surface of the case.

**CONFIRMATION**

Do NOT cover the driver unit with metal.

**CONFIRMATION**

Take a note of driver ID in pg. 38.

**REF**

When using double-stick tape, please use a neutral detergent to wipe off dust and oil from the surface prior to installation.

## Power Supply Filter

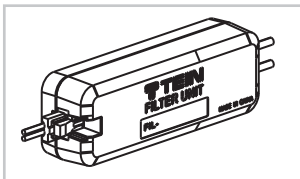

Install the power supply filter securely using double-stick tapes, etc.

**CAUTION**

Do NOT install the power supply filter in the following areas to avoid malfunctions:

- Humid or dusty area
- Any area which becomes high temperature, i.e. places exposed to direct sunlight, near heater outlets

**REF**

When using double-stick tape, please use a neutral detergent to wipe off dust and oil from the surface prior to installation.

## GPS Kit (Optional)

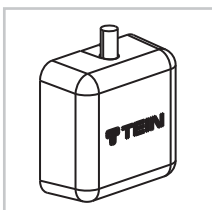

**CAUTION**

Do NOT install GPS unit in the following areas to avoid malfunctions:

- Humid or dusty area
- Any area which becomes high temperature, i.e., near heater outlets

**CAUTION**

GPS unit is NOT waterproof. Install the unit in the area which does not get wet.

**REF**

When using double-stick tape, please use a neutral detergent to wipe off dust and oil from the surface prior to installation.

**REF**

Depending on locations/circumstances, GPS signals may be weak or unavailable.

- Republication, redistribution or reproduction of the contents of this manual, in whole or in any part, without TEIN's prior written consent is prohibited by copyright law.

# Installation

## Wiring

The wiring diagrams are shown below. In order to prevent unexpected short-circuit, always disconnect the negative battery terminal before commencing any wiring work. Remember to reconnect after completion.

- ⚠ **CAUTION** Connect each unit to power sources such as a cigarette lighter which does not influence on driving in case of unit's trouble.
- ⚠ **CAUTION** Power supply filter (for controller and GPS units) should be connected to accessory power supply. If it uses the constant power supply, the battery will be dead in a short period.

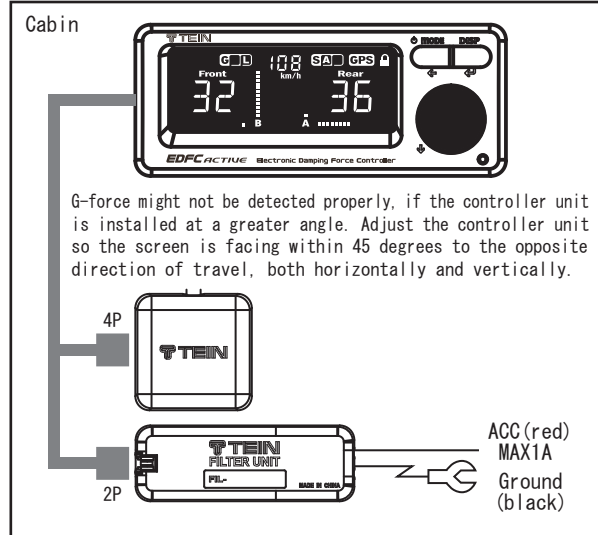
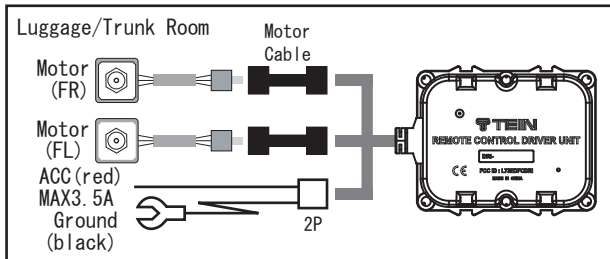
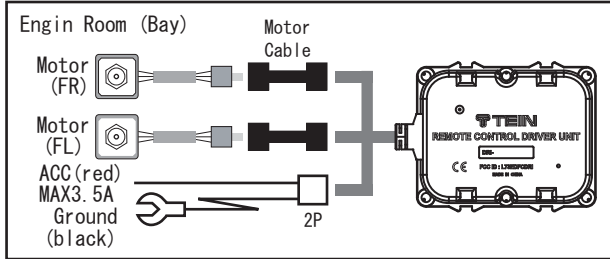

G-force might not be detected properly, if the controller unit is installed at a greater angle. Adjust the controller unit so the screen is facing within 45 degrees to the opposite direction of travel, both horizontally and vertically.

### 1) Power Supply Filter

Connect to 2P connector on controller unit.

- Accessory power supply (Red cable): Connect using the branch connector from accessory power supply of sufficient capacity such as a cigarette lighter.
- Ground cable (Black cable): Firmly connect to a bare metal part of the vehicle (avoid connecting to a painted area).

### 2) Front/Rear Driver Units

Above diagrams are for reference only. As the motor positions vary by vehicle structure, place/arrange the driver units and cables to the most appropriate positions for each vehicle model.

The kit includes long and short cables. Use them depending on connecting places. (The short one is designed suitable for the front.)

- 12V power supply wire (Red cable): The wires can be connected either directly to the battery (constant power supply) or with accessory power supply (comes on when the key is in accessory position). Take power from either supply suitable for unit's position. (Standby current if connected to constant power supply: 1.5mA per 1 driver unit)
- Ground cable (Black cable): Firmly connect to a bare metal part of the vehicle (avoid connecting to a painted area).

- ⚠ **CAUTION** When connecting to accessory power supply, choose the one with enough current capacity. If the capacity is not enough, it will not power the motor. This will not only diminish the product's effects but also might cause negative effect on vehicle's other electronic components.

**CONFIRMATION** Take a note of front/rear driver IDs on pg. 38.

As the controller and the drivers have been paired prior to shipment, match the IDs in the setting with the actual IDs.

**REF** Connection to the accessory power supply is recommended.

### 3) Connecting Motors

- Firmly connect the motor and the driver unit.
- Fix the connector with cable tie after allowing sufficient slack on the motor side.
- Driver unit can be connected directly to motors, without using motor cables.

- ⚠ **CAUTION** Please allow enough cable slack for the motor to turn with the rotating motion of the damper. Sufficient slack is especially important for Ft strut type vehicles in order to prevent the cable from braking during steering and possibly causing short-circuits. Check wiring regularly and rewire if cables are twisted and/or tangled to the motor. Disconnect the motor when you adjust the ride height of the vehicle. If not, it can cause the cable to break or short-circuit.

Do NOT allow a spring to have play. It may cause piston rod to rotate and the cable to tangled up.

**CONFIRMATION** Each motor has Ch1 and Ch2. Be sure to record which motor (Ft or Rr) each channel is connected to. (pg.38)

**CONFIRMATION** Connect Ch1 to rebound and Ch2 to comp. when 1 driver controls 1 separately adjustable shock absorber. (Refer to pg.53 Table 1.) Record every connection in pg.38 to identify each driver, as such information is required for troubleshooting.

- Republication, redistribution or reproduction of the contents of this manual, in whole or in any part, without TEIN's prior written consent is prohibited by copyright law.

# EDFC STRUT KIT

● To customers who purchased strut kit (EDK06-K4474)

## Usage Conditions

Installation of this product is optional.

This product prevents the wiring from coiling around when adjusting the ride height upon set-up without the need to disconnect the motor.

Depending upon driving conditions and/or settings, the EDFC motor may rotate in one direction. If let alone, the wiring might get tangled up with piston rod and, consequently, might be broken or disconnected.

It usually does not create any problem if the wiring is unwound whenever the tangling is found or upon periodic inspections, however in rare cases the incidence is quite high enough to cause breakage or disconnection in between routine maintenance.

If tangling of the wiring occurs within a few days of EDFC installation, install this product to prevent future occurrence.

If the height of the pillow ball case (picture to the right with star mark) is less than 24.0mm

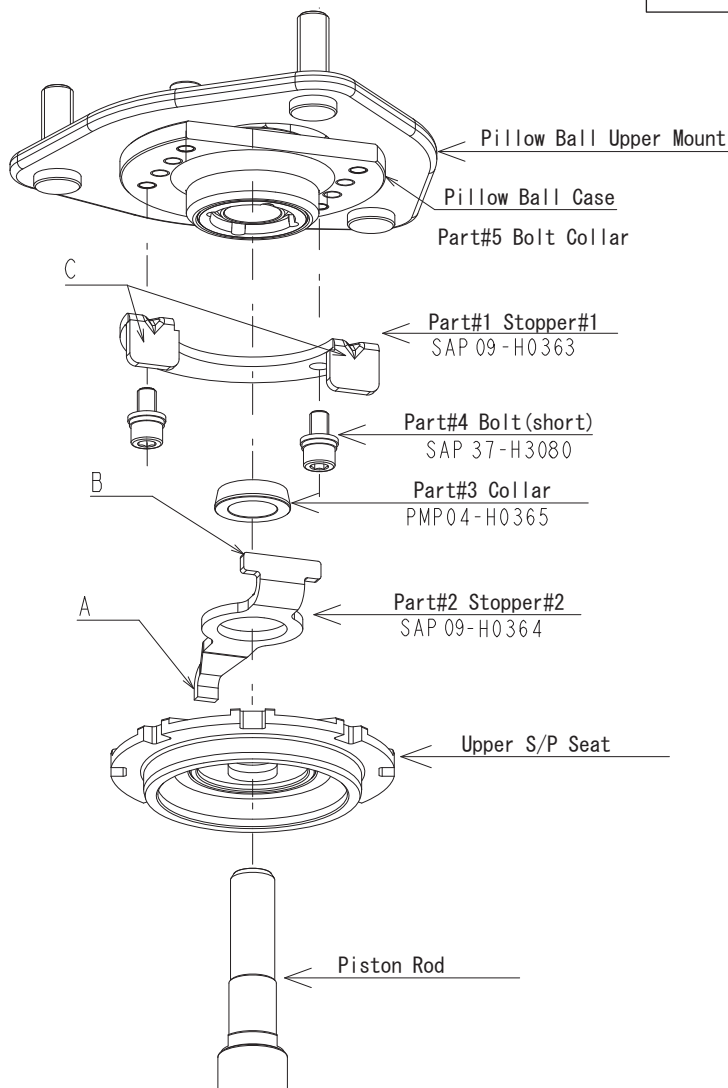
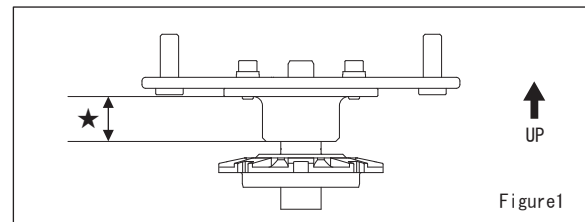

### 【Components】

- 1) Part#1 Stopper#1
- 2) Part#2 Stopper#2
- 3) Part#3 Collar
- 4) Part#4 Bolt (short)

### 【Installation Procedure】

- 1) Install 'Part #1 (Stopper #1)' using bolts included in the kit.
  - \*There are two rows of four screw holes on the reverse side of Pillow Ball Upper Mount. Use two holes at the end of each row.
  - \*If the above is not available, move the camber adjusting bolts to the ones inside.
- 2) Mount 'Part #2 (Stopper #2)' to Upper Spring Seat.
  - \*Fit protruding part 'A' to one of the vertical slots on the side of Upper Spring Seat.
  - \*Insert upper protruding part of Upper Spring Seat through the hole in the stopper.
- 3) Mount Upper Spring Seat, assembled in step 2) above, to Piston Rod.
  - \*Align the slot on Piston Rod with the one on Upper Spring Seat.
- 4) Insert 'Part #3 (Collar)'.
  - \*Place the side with smaller outer diameter top.
- 5) Mount Pillow Ball Upper Mount.
  - \*Fit the protruding part 'B' of 'Part #2 (Stopper #2)' in between parts 'C' (not facing the bolts) of 'Part #1 (Stopper #1)'.
- 6) Tighten Pillow Nut.

● Reproduction, redistribution or reproduction of the contents of this manual, in whole or in any part, without TEIN's prior written consent is prohibited by copyright law.

# EDFC STRUT KIT

If the height of the pillow ball case (picture to the right with star mark) is 24.0mm or higher.

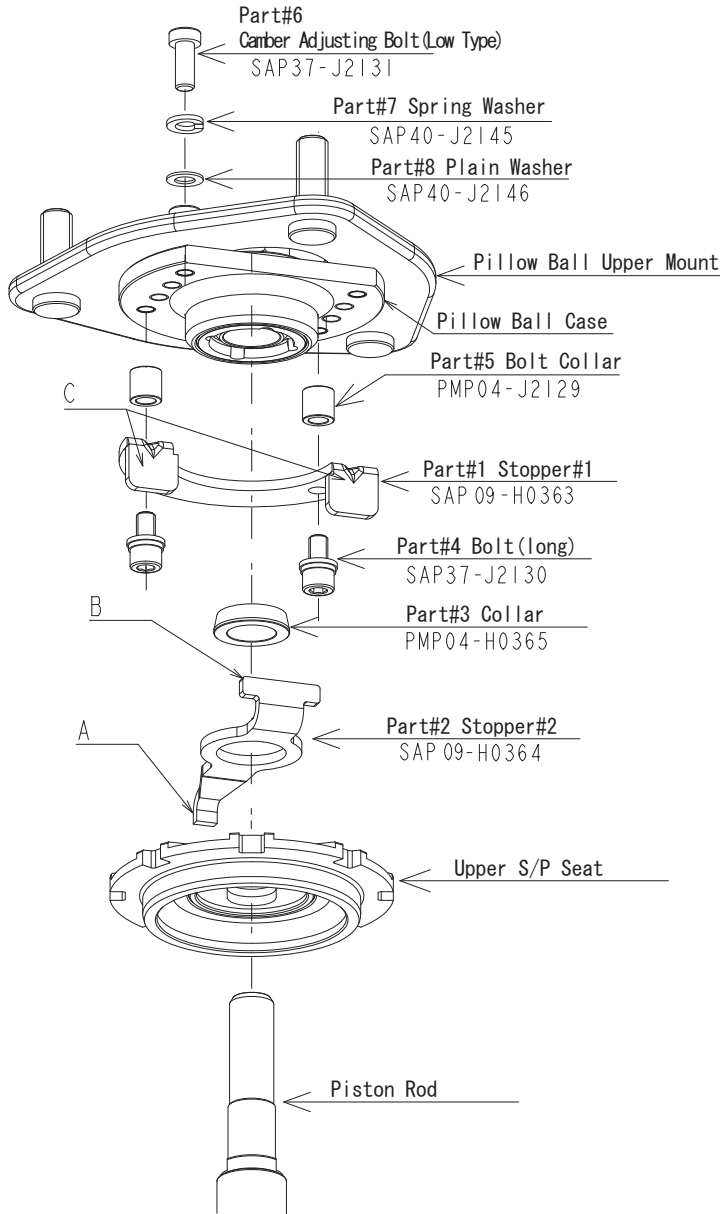
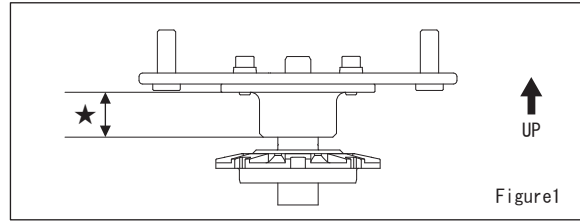

## 【Components】

- |  |        |
|--|--------|
| 1) Part#1 Stopper#1                        | × 2pc. |
| 2) Part#2 Stopper#2                        | × 2pc. |
| 3) Part#3 Collar                           | × 2pc. |
| 4) Part#4 Bolt (long)                      | × 4pc. |
| 5) Part#5 Bolt Collar                      | × 4pc. |
| 6) Part#6 Camber Adjusting Bolt (Low Type) | × 8pc. |
| 7) Part#7 Spring Washer                    | × 8pc. |
| 8) Part#8 Plain Washer                     | × 8pc. |

## 【Installation Procedure】

- 1) Install 'Part #1 (Stopper #1)' using bolts included in the kit

\*There are two rows of four screw holes on the reverse side of Pillow Ball Upper Mount. Use two holes at the end of each row.

\*If the above is not available, move the camber adjusting bolts to the ones inside.

\*Use 'Part #4 (Bolt <long>)' and 'Part #5 (Bolt Collar)' for the kit with the pillow ball case 24.0mm high (refer to the figure 1 shown below).

\*Also, for the kit with the pillow ball case 24.0mm high, EDFC motor might interfere with the camber adjusting bolt, depending on the camber angle setting. In that case, use 'Part #7 (Camber Adjusting Bolt <low type>)', 'Part #8 (Spring Washer)' and 'Part #9 (Plain Washer)' to avoid interference.

- 2) Mount 'Part #2 (Stopper #2)' to Upper Spring Seat.

\*Fit protruding part 'A' to one of the vertical slots on the side of Upper Spring Seat.

\*Insert upper protruding part of Upper Spring Seat through the hole in the stopper.

- 3) Mount Upper Spring Seat, assembled in step 2) above, to Piston Rod.

\*Align the slot on Piston Rod with the one on Upper Spring Seat.

- 4) Insert 'Part #2 (Collar)'.

\*Place the side with smaller outer diameter top.

- 5) Mount Pillow Ball Upper Mount.

\*Fit the protruding part 'B' of 'Part #2 (Stopper #2)' in between parts 'C' (not facing the bolts) of 'Part #1 (Stopper #1)'.

- 6) Tighten Pillow Nut.

# Initial Setup Procedures and Basic Operations

## Turning the Power ON/OFF

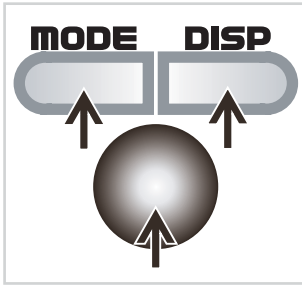

To turn ON:  
Short press of  
[MODE], [DISP] or [Dial]

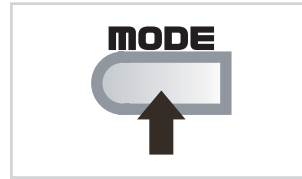

To turn OFF:  
[MODE] Long press

## To Lock Operation

To lock and unlock operation:

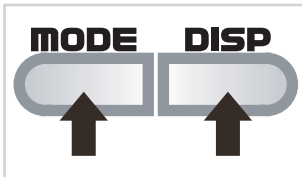

[MODE] + [DISP]  
Long press simultaneously  
When the operation is locked,  
🔒 icon on the upper right  
corner on the display will  
illuminate.

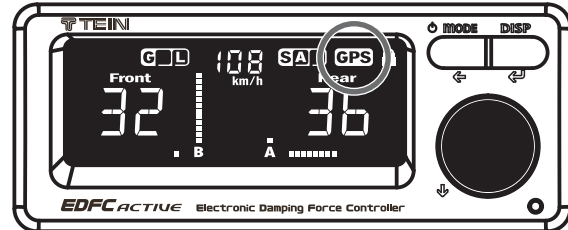

## Initial Setup

Select "EASY" or "CUSTOM" setup.

**REF** 2 driver units have been paired (identified) with the controller at the time of shipment. If using as-is, initial pairing setup is not required. Reconfigure whenever the settings are initialized.

Pairing is to make the controller recognize/identify the specific driver unit(s).

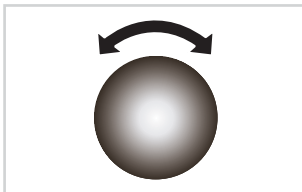

- Select "EASY SET UP" if 2 driver units are used and also you want to set up easily. (Refer to pg.51.)

EASY SET UP

- Select "CUSTOM" if 1, 3 or 4 driver unit(s) is(are) used and/or you want to customize settings. (Refer to pg.51~)

CUSTOM

## Recognizing Controller Installation Angle (Correction of G-Force Direction)

This product enables G-actuated adjustment and G-force display, using G-sensor built inside the controller unit. Once the controller is installed, vehicle's driving direction needs to be configured.

Be sure to correct G-force direction following the procedures described on pg. 64 "1-8".

**CAUTION** Correct G-force direction whenever the position and/or the angle of the controller is changed.

**REF** G-force might not be detected properly, if the controller unit is installed at a greater angle. Adjust the controller unit so the screen is facing within 45 degrees to the opposite direction of travel, both horizontally and vertically.

## Initialization

You can initialize settings to restore the default settings at the time of shipment.

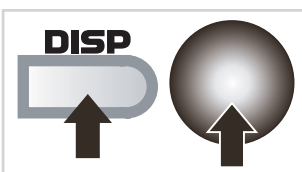
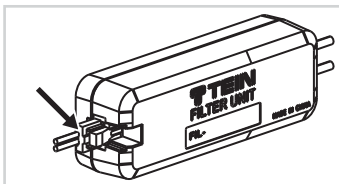

1. Disconnect the power connector.
2. Press and hold [DISP] and [Dial] simultaneously.
3. Reconnect the power connector while holding the above two buttons
4. "ALL CLEAR" flashes on screen.  
(If left with no operation for 5 seconds, the system will return to normal operation without initializing.)
5. While "ALL CLEAR" flashes, press and hold [DISP] and [Dial] simultaneously for about 1 second.
6. "CLEAR OK" flashes on screen and the system enters "EASY SET UP" mode. (Initialization completed.)

- Republication, redistribution or reproduction of the contents of this manual, in whole or in any part, without TEIN's prior written consent is prohibited by copyright law.

## "EASY SET UP"

Initial setup when 2 driver units are used (1 driver for front and 1 for rear).

- In "EASY" mode, damping force adjustment is set to 16-level mode and vehicle speed is displayed in km/h. If you want to change, refer to "CUSTOM" setup.
- Short-press of [MODE] returns to the previous operation.
- Before starting setup, have your note of driver ID (pg.38) available.

	Setting	Display	Operation	Instruction	Selected Item
1		EASY SET UP		[Dial] Short press	
2		SEARCHING			
3	Front Driver Pairing	DR 1:00 00 0F		[Dial] Turn + Short press	Front Driver ID *1
4	Rear Driver Pairing	DR 2:00 00 10		[Dial] Turn + Short press	Rear Driver ID *1

- \*1 The above samples show that driver ID for front is 00 00 0F and for rear is 00 00 10. Select one of "00 00 0F", "00 00 10" or "++ ++ ++" for pairing front driver. If "00 00 0F" is selected, select either "00 00 10" or "++ ++ ++" for rear. (Select "++ ++ ++" to input ID directly.) If the appropriate driver ID is not displayed, input ID directly. (Refer to pg.53)

## "CUSTOM" Setup







Selecting damping force (D/F) adjustment mode and speed unit and for nitial setup for using 1, 3 or 4 driver units.

- Short-press of [MODE] returns to the previous operation.
- Before starting setup, have your note of driver ID (pg.38) available.

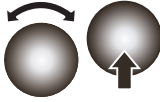
	Setting	Display	Operation	Instruction	Available Options	Default
1		CUSTOM		[Dial] Short press		
2	Speed Unit	SPEED 0 <sup>km/h</sup>		[Dial] Short press		
3		SPEED 0 <sup>km/h</sup>		[Dial] Turn + Long press	Left : MPH Right : km/h	km/h
4	Menu Selection	SPEED 0 <sup>km/h</sup>		[Dial] Turn	SPEED STEP DR MODE DR ASSIGN	
5	D/F Steps	STEP 16		[Dial] Short press		

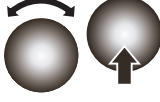
- Republication, redistribution or reproduction of the contents of this manual, in whole or in any part, without TEIN's prior written consent is prohibited by copyright law.

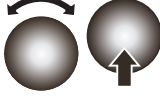
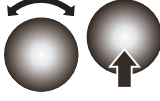
## "CUSTOM" Setup

Setting	Display	Operation	Instruction	Available Options	Default
6	STEP 16		[Dial] Turn + Long press	Left : 16 Center : 32 Right : 64	16-level *1
7	Menu Selection STEP 32		[Dial] Turn	SPEED STEP DR MODE DR ASSIGN	
8	Driver Selection DR MODE 1		[Dial] Short press		
9	DR MODE 1		[Dial] Turn + Long press	1 to 16 (Refer to Table 1 for details)	DR MODE 1 at the shipment
10	Driver Assignment DR ASSIGN		[Dial] Short press		
11	SEARCHING				
12	Driver Pairing DR 1-----		[Dial] Turn + Long press	DR1 to DR4, CLEAR *2 *3 *4	
13	DR 1:00 00 0F		[Dial] Turn + Long press	Driver ID	
14	DR 1:00 00 0F		[Dial] Turn + Long press	DR1 to DR4, CLEAR *2 *3 *4	
15	DR 2-----		Repeat the procedures 14-16		
16	Return to Initial Display		[MODE] Short press 2 times		

\*1: Damping force adjustment range can be divided into 16, 32 or 64 steps (the hardest: 0, the softest: 16, 32 or 64).

When the number of adjustment steps is changed, values in a memory will be canceled and returned to default.

\*2: For manual input of driver ID, refer to pg.53.

\*3: Select and input DR1 when one driver is used, DR1-2 when 2 used, DR1-3 when 3 used, and DR1-4 when 4 used.

\*4: Selecting "CLEAR" will cancel ALL driver pairing settings.

\*5: The above samples show that driver ID for front is 00 00 0F and for rear is 00 00 10.

Select one of "00 00 0F", "00 00 10" or "++ ++ ++" for pairing front driver.

If "00 00 0F" is selected, select either "00 00 10" or "++ ++ ++" for rear.

(Select "++ ++ ++" to input ID directly.)

If the appropriate driver ID is not displayed, input ID directly. (Refer to pg.53)

- Reproduction, redistribution or reproduction of the contents of this manual, in whole or in any part, without TEIN's prior written consent is prohibited by copyright law.



## "CUSTOM" Setup

Table 1 Combination of Damping Force (D/F) Adjustment Types and Driver Unit (DR)

	Type of Comp./Rebound D/F Adjustment		DR1	DR2	DR3	DR4
	Ft	Rr				
1	simultaneous	simultaneous	Ft	Rr	—	—
2	simultaneous	NOT adjustable	Ft	—	—	—
3	NOT adjustable	simultaneous	Rr	—	—	—
4	separate *1	separate *1	Ft1	Ft2	Rr1	Rr2
5	separate *1	separate *2	Ft1	Ft2	Rr rebound	Rr comp
6	separate *2	separate *1	Ft rebound	Ft comp	Rr1	Rr2
7	separate *2	separate *2	Ft rebound	Ft comp	Rr rebound	Rr comp
8	separate *1	simultaneous	Ft1	Ft2	Rr	—
9	separate *2	simultaneous	Ft rebound	Ft comp	Rr	—
10	separate *1	NOT adjustable	Ft1	Ft2	—	—
11	separate *2	NOT adjustable	Ft rebound	Ft comp	—	—
12	simultaneous	separate *1	Ft	Rr1	Rr2	—
13	simultaneous	separate *2	Ft	Rr rebound	Rr comp	—
14	NOT adjustable	separate *1	Rr1	Rr2	—	—
15	NOT adjustable	separate *2	Rr rebound	Rr comp	—	—
16	NOT adjustable	NOT adjustable	—	—	—	—

\*1 For controlling 1 individual comp./rebound adjustable damper with 1 driver unit; Ch1 on rebound side and Ch2 on comp.

\*2 For controlling 2 individual comp./rebound adjustable dampers with 2 driver units; 1 unit to control rebound side of both dampers and another unit to control comp.

## Manual Input of Driver ID

	Setting	Display	Operation	Instruction	Available Options
1				[Dial] Turn + Short press	DR1~DR4 CLEAR
2	Direct Input			[Dial] Turn + Short press	Manual Input
3	Input 1st Digit			[Dial] Turn + Short press	0~9, A~F
4	Input 2nd - 6th Digits			[Dial] Turn + Short press	0~9, A~F
5				Repeat the procedures 3-4.	
6				[Dial] Long press	
7	Return to Initial Display			[MODE] Short press	

\* The chart shows the sample driver ID and for reference only. Be sure to enter your own IDs.

- Republication, redistribution or reproduction of the contents of this manual, in whole or in any part, without TEIN's prior written consent is prohibited by copyright law.

# Explanation of Control Modes

Choose from one of the control modes and/or combined modes.

## Switching Control Modes

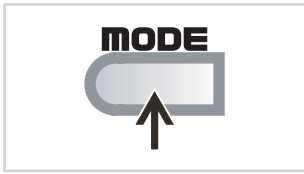

Short press of [MODE] switches between control modes.

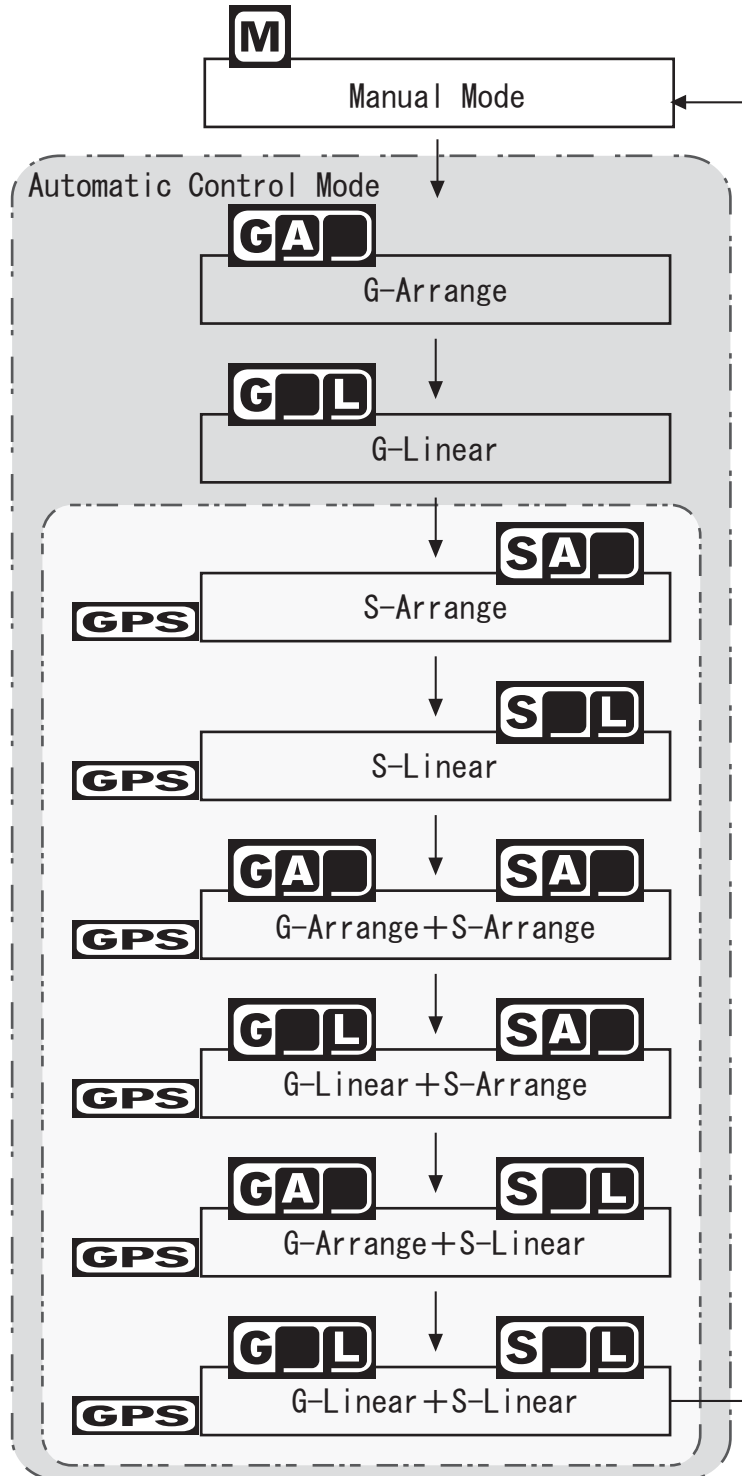

For details of each mode, refer to the following pages:

- Manual Mode ..... pg. 55
- Automatic Control Modes ..... pg. 57
- G-Actuated (G-\*\*) Adjustment ..... pg. 58~59
- Speed-Sensitive (S-\*\*) Adjustment ..... pg. 60~61

\* Modes with GPS symbol **GPS** can be selected only when optional GPS Kit is installed.

● Reproduction, redistribution or reproduction of the contents of this manual, in whole or in any part, without TEIN's prior written consent is prohibited by copyright law.

# Explanation of Control Modes

## Manual Mode

### • Explanation of Display

Without G-Force Bar Graph

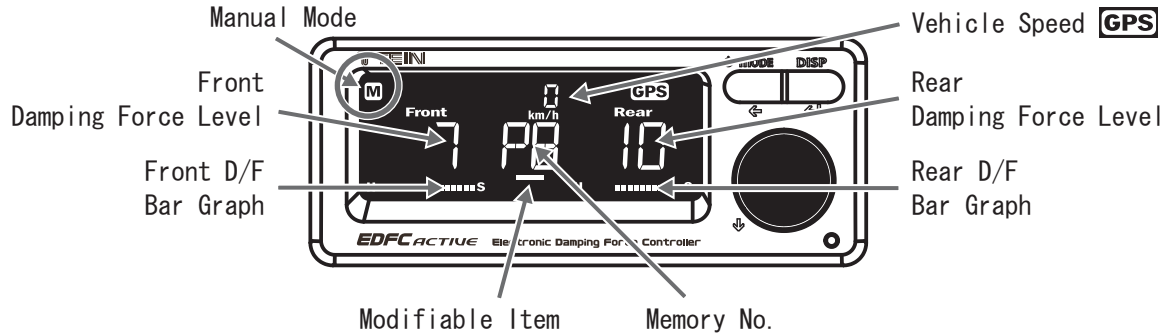

With G-Force Bar Graph (Refer to pg. 64 "1-1", "1-2")

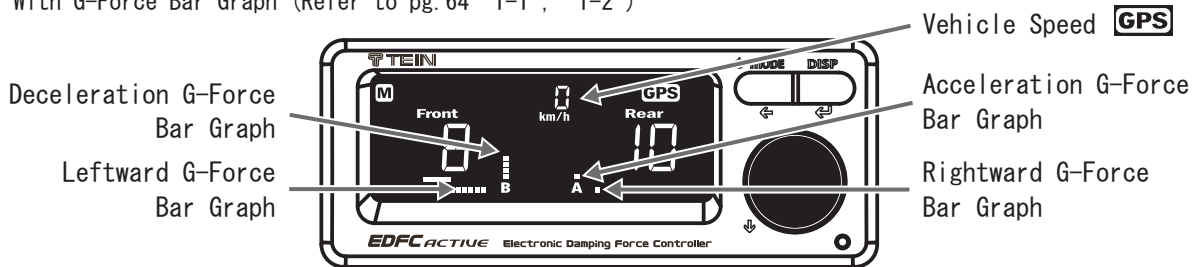

\* Vehicle speed can only be displayed when the optional GPS kit is connected/used.

### • How to Change Damping Force

Basic Operations

[Dial]

Short press to switch between menus

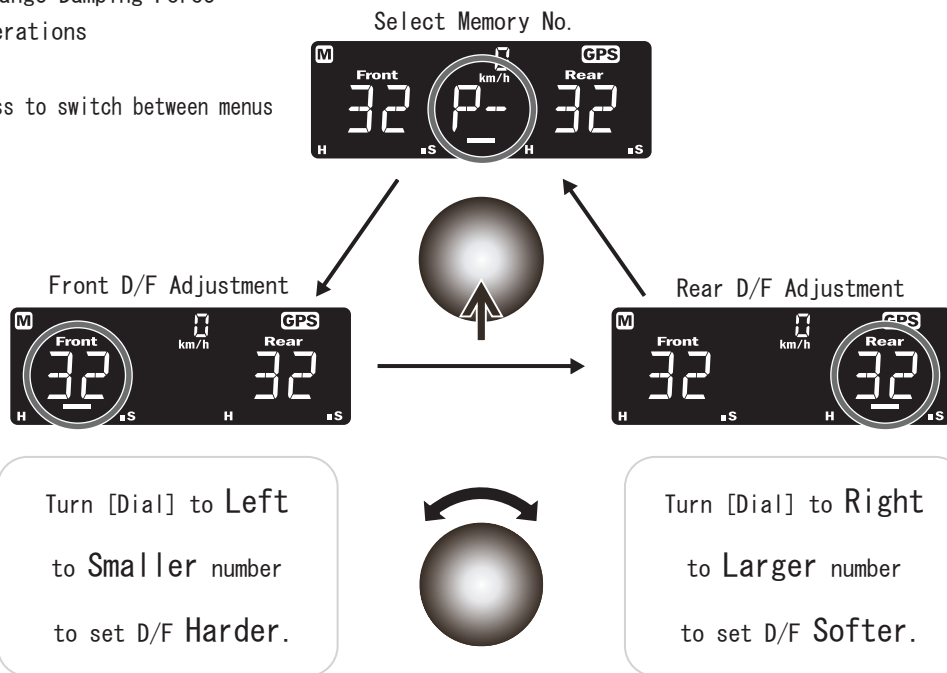

\* You can select from 3 different damping force adjustment modes; 0-16, 0-32 or 0-64, at initial setup. (Refer to pg. 64 "2-2")

● Reproduction, redistribution or reproduction of the contents of this manual, in whole or in any part, without TEIN's prior written consent is prohibited by copyright law.

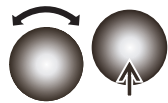

## Explanation of Control Modes

### • How to Recall Damping Force Setting from Memory

	Setting	Display	Operation	Instruction	Available Options
1	Retrieve Memory No.			[Dial] Turn + Short press	P0~P9

\* Note: Do NOT long-press Dial. By doing so, a new number of steps will be registered.

### • How to Set Desired Damping Force Level into Memory

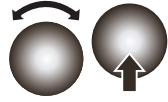
	Setting	Display	Operation	Instruction	Available Options
1	D/F Adjustment			Select the desired level	
2	Retrieve Memory No.			[Dial] Turn + Long press	P0~P9

### • Default Memory Parameters

Values in the table are in 16-level, 32-level and 64-level modes from left to right.

Table 2 Default Memory Parameters (Manual Mode)

Memory No.	Comp./Rebound Simultaneous Adjustment		Comp./Rebound Separate Adjustment			
	Ft	Rr	Ft (Comp.)	Ft (Rebound)	Rr (Comp.)	Rr (Rebound)
P0	16/32/64	16/32/64	16/32/64	16/32/64	16/32/64	16/32/64
P1	12/24/48	12/24/48	12/24/48	12/24/48	12/24/48	12/24/48
P2	8/16/32	8/16/32	8/16/32	8/16/32	8/16/32	8/16/32
P3	4/8/16	4/8/16	4/8/16	4/8/16	4/8/16	4/8/16
P4	0/0/0	0/0/0	0/0/0	0/0/0	0/0/0	0/0/0
P5	0/0/0	0/0/0	0/0/0	0/0/0	0/0/0	0/0/0
P6	0/0/0	0/0/0	0/0/0	0/0/0	0/0/0	0/0/0
P7	0/0/0	0/0/0	0/0/0	0/0/0	0/0/0	0/0/0
P8	0/0/0	0/0/0	0/0/0	0/0/0	0/0/0	0/0/0
P9	0/0/0	0/0/0	0/0/0	0/0/0	0/0/0	0/0/0

\* For how to change D/F adjustment modes; 16-level/32-level/64-level, refer to pg. 64 "2-2".

# Explanation of Control Modes

## Automatic Control Modes

EDFC ACTIVE enables automatic adjustment of damping force (D/F) based on acceleration/deceleration G-force and vehicle speed (optional GPS Kit is required).

Automatic adjustment is available in 2 different modes; arrange mode to adjust D/F at preset points and linear mode to adjust D/F more smoothly connecting preset points.

These modes can be combined for more comprehensive adjustment.

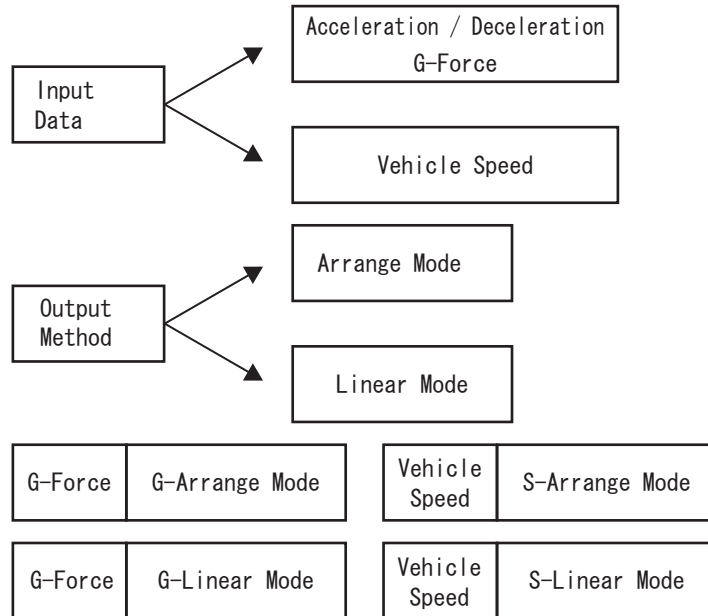

Image of Automatic Control Modes

Input data for switch timing is based on acceleration/deceleration G-force and/or speed for both Arrange and Linear modes; four patterns in total.

• How to Modify Settings

G-Force Setting: Refer to pg. 59 (default: pg. 58 Table 3)

Speed Setting: Refer to pg. 61 (default: pg. 60 Table 4)

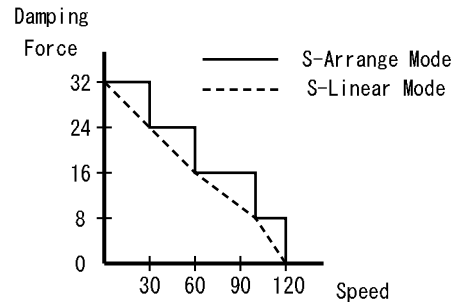

Fig : image of operation

• How to Change Control Modes

Setting	Display	Operation	Instruction	Available Options
1	Front 32 km/h Rear 32 50		[Dial] Short press	
2	G 1 5 1		[Dial] Turn + Short press	G1 S1 G2 S1 G1 S2 G2 S2

\* Only S1 is displayed for speed-sensitive mode and only G1 for G-actuated mode.

\* These options are NOT selectable in Manual Mode.

# Explanation of Control Modes

## G-Arrange / G-Linear Modes

• Explanation of Display

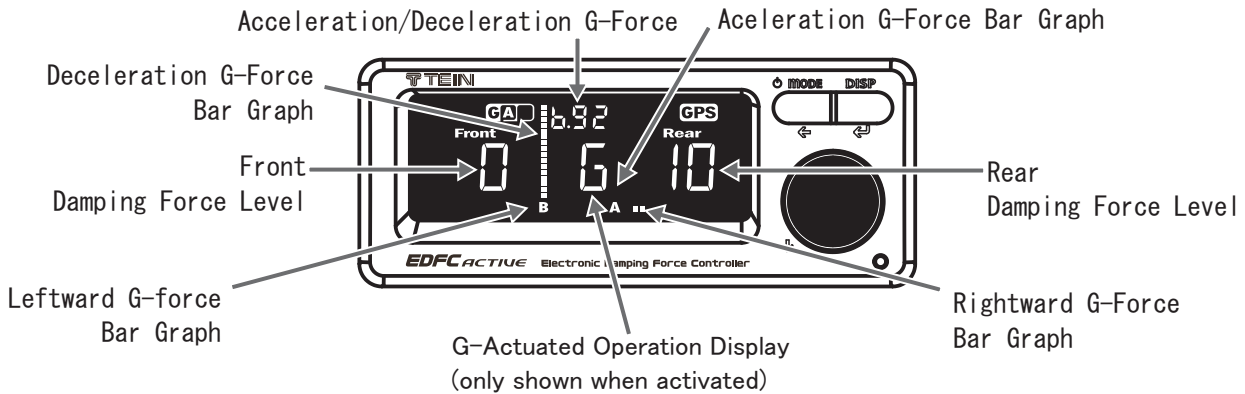

• Default Values

Values in the table are in 16-level, 32-level and 64-level modes from left to right.

Table 3 Default Memory Parameters (G-Actuated Adjustment)

MODE	No.	Comp./Rebound Simultaneous Adjustment		Comp./Rebound Separate Adjustment				G-Force
		Ft	Rr	Ft (Comp.)	Ft (Rebound)	Rr (Comp.)	Rr (Rebound)	
Memory 1 (Normal)	G0	-5/-10/-20	-2/-4/-8	-5/-10/-20	-5/-10/-20	-2/-4/-8	-2/-4/-8	b0.55
	G1	-4/-8/-16	-2/-4/-8	-4/-8/-16	-4/-8/-16	-2/-4/-8	-2/-4/-8	b0.45
	G2	-3/-6/-12	-1/-2/-4	-3/-6/-12	-3/-6/-12	-1/-2/-4	-1/-2/-4	b0.35
	G3	-2/-4/-8	-1/-2/-4	-2/-4/-8	-2/-4/-8	-1/-2/-4	-1/-2/-4	b0.25
	G4	-1/-2/-4	0	-1/-2/-4	-1/-2/-4	0	0	b0.15
	G5	0	-1/-2/-4	0	0	-1/-2/-4	-1/-2/-4	a0.15
	G6	-1/-2/-4	-2/-4/-8	-1/-2/-4	-1/-2/-4	-2/-4/-8	-2/-4/-8	a0.25
	G7	-1/-2/-4	-3/-6/-12	-1/-2/-4	-1/-2/-4	-3/-6/-12	-3/-6/-12	a0.35
	G8	-2/-4/-8	-4/-8/-16	-2/-4/-8	-2/-4/-8	-4/-8/-16	-4/-8/-16	a0.45
Memory 2 (Dynamic)	G9	-2/-4/-8	-5/-10/-20	-2/-4/-8	-2/-4/-8	-5/-10/-20	-5/-10/-20	a0.55
	G0	-6/-12/-24	-3/-6/-12	-6/-12/-24	-6/-12/-24	-3/-6/-12	-3/-6/-12	b0.55
	G1	-5/-10/-20	-3/-6/-12	-5/-10/-20	-5/-10/-20	-3/-6/-12	-3/-6/-12	b0.45
	G2	-4/-8/-16	-2/-4/-8	-4/-8/-16	-4/-8/-16	-2/-4/-8	-2/-4/-8	b0.35
	G3	-3/-6/-12	-2/-4/-8	-3/-6/-12	-3/-6/-12	-2/-4/-8	-2/-4/-8	b0.25
	G4	-1/-2/-4	0	-1/-2/-4	-1/-2/-4	0	0	b0.15
	G5	0	-1/-2/-4	0	0	-1/-2/-4	-1/-2/-4	a0.15
	G6	-2/-4/-8	-3/-6/-12	-2/-4/-8	-2/-4/-8	-3/-6/-12	-3/-6/-12	a0.25
	G7	-2/-4/-8	-4/-8/-16	-2/-4/-8	-2/-4/-8	-4/-8/-16	-4/-8/-16	a0.35
G8	-3/-6/-12	-5/-10/-20	-3/-6/-12	-3/-6/-12	-5/-10/-20	-5/-10/-20	a0.45	
G9	-3/-6/-12	-6/-12/-24	-3/-6/-12	-3/-6/-12	-6/-12/-24	-6/-12/-24	a0.55	

G-Force: b = Deceleration / a = Acceleration

\* For how to change D/F adjustment modes: 16-level/32-level/64-level, refer to pg. 64 "2-2".

● Reproduction, redistribution or reproduction of the contents of this manual, in whole or in any part, without TEIN's prior written consent is prohibited by copyright law.

# Explanation of Control Modes

## How to Modify G-Force Change-Points

Before starting operation, set the unit to the following conditions.

- Mode: GA (Note: Values can NOT be modified in GA+SA or GA+SL mode.)
- Display: Damping force level



	Setting	Display	Operation	Instruction	Available Options
1	Retrieve Memory to Modify			[Dial] Short press	
2				[Dial] Turn + Short press	G1: memory 1 G2: memory 2
3				[Dial] Long press	
4	Select Item to Modify			[Dial] Turn + Short press	G0 ... G9
5	Set G-Force Change-Point			[Dial] Turn + Short press	b2.0 ~ a2.0
6	Set Front D/F Level			[Dial] Turn + Short press	+64 ~ -64
7	Set Rear D/F Level			[Dial] Turn + Short press	+64/32/16 +64 ~ -64 -64/32/16
8				[Dial] Long press	+64/32/16 +64 ~ -64 -64/32/16
9				Repeat the above procedures 4-8	
10	Return to Initial Display			[MODE] Short press x 2 times	

- \* Above procedures 5, 6 and 7 may appear in different order, depending on the previous modification operation done.
- \* If G-force entered is the same as the previously input value, the old setting will be replaced with the new one.
- \* Memory numbers (G0 to G9) are automatically allocated based on the input G-force value in the ascending order (deceleration < 0 < acceleration). Numbers are constantly reallocated even while inputting.
- \* To delete the memory, enter "--" to G-force value and save. "--" can be found between "A" and "B".

- Republication, redistribution or reproduction of the contents of this manual, in whole or in any part, without TEIN's prior written consent is prohibited by copyright law.

# Explanation of Control Modes

## S-Arrange / S-Linear Modes



**CAUTION** Attach GPS unit firmly on the dashboard panel below the windshield.

GPS unit needs to recognize at least four valid signals from the satellites to start working and this usually takes 30 seconds to 1 minute after the power is turned on.

If the vehicle moves before receiving enough satellite signals, it may take longer to recognize. After turning on the power, wait until GPS unit receives valid signals to move the vehicle. GPS lamp will change from blinking to ON. GPS lamp will change from blinking to ON, once GPS is activated.

### • Explanation of Display

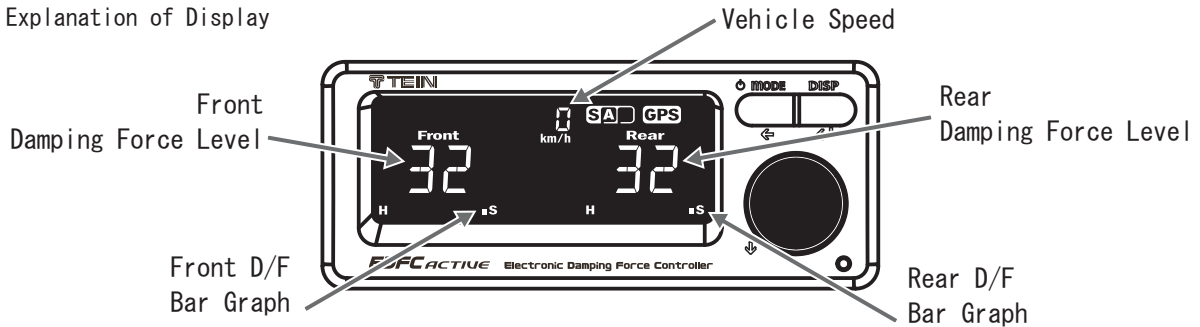

### • Default Values

Values in the table are in 16-level, 32-level and 64-level modes from left to right.

Table 4 Default Memory Parameters (Speed-Sensitive Adjustment)

Mode	No.	Comp. /Rebound Simultaneous Adjustment		Comp. /Rebound Separate Adjustment				Speed		
		Ft	Rr	Ft (Comp)	Ft (Rebound)	Rr (Comp)	Rr (Rebound)	km/h	MPH	
Memory 1 (Normal)	S0	14/28/56	14/28/56	14/28/56	14/28/56	14/28/56	14/28/56	0	0	
	S1	13/27/55	13/27/55	13/27/55	13/27/55	13/27/55	13/27/55	40	25	
	S2	12/24/48	12/24/48	12/24/48	12/24/48	12/24/48	12/24/48	60	40	
	S3	11/22/44	11/22/44	11/22/44	11/22/44	11/22/44	11/22/44	80	55	
	S4	10/20/40	10/20/40	10/20/40	10/20/40	10/20/40	10/20/40	100	65	
	S5	-	-	-	-	-	-	-	-	-
	S6	-	-	-	-	-	-	-	-	-
	S7	-	-	-	-	-	-	-	-	-
	S8	-	-	-	-	-	-	-	-	-
Memory 2 (Sporty)	S0	10/20/40	10/20/40	10/20/40	10/20/40	10/20/40	10/20/40	0	0	
	S1	9/19/39	9/19/39	9/19/39	9/19/39	9/19/39	9/19/39	40	25	
	S2	8/16/32	8/16/32	8/16/32	8/16/32	8/16/32	8/16/32	60	40	
	S3	7/14/28	7/14/28	7/14/28	7/14/28	7/14/28	7/14/28	80	55	
	S4	6/12/24	6/12/24	6/12/24	6/12/24	6/12/24	6/12/24	100	65	
	S5	-	-	-	-	-	-	-	-	-
	S6	-	-	-	-	-	-	-	-	-
	S7	-	-	-	-	-	-	-	-	-
	S8	-	-	-	-	-	-	-	-	-
S9	-	-	-	-	-	-	-	-	-	

\* For how to change D/F adjustment modes: 16-level/32-level/64-level, refer to pg. 64 "2-2".

● Reproduction, redistribution or reproduction of the contents of this manual, in whole or in any part, without TEIN's prior written consent is prohibited by copyright law.



# Explanation of Control Modes

## How to Modify Speed Change-Points

Before starting operation, set the unit to the following conditions.

- Mode: SA (Note: Values can NOT be modified in GA+SA or GA+SL mode.)
- Display: Damping force level



	Setting	Display	Operation	Instruction	Available Options
1	Retrieve Memory to Modify			[Dial] Short press	
2				[Dial] Turn + Short press	S1: memory 1 S2: memory 2
3				[Dial] Long press	
4	Select Item to Modify			[Dial] Turn + Short press	S0~S9
5	Set Speed Change-Point			[Dial] Turn + Short press	0~300
6	Set Front D/F Level			[Dial] Turn + Short press	0~16 0~32 0~64
7	Set Rear D/F Level			[Dial] Turn + Short press	0~16 0~32 0~64
8				[Dial] Long press	
9				Repeat the above procedures 4-8	
10	Return to Initial Display			[MODE] Short press x 2 times	

- \* Speed 0 in memory No. "S0" can NOT be modified.
- \* Speed can be set in 5km/h (or 5MPH) increments.
- \* When the same value is input, the old setting will be replaced.
- \* Memory numbers (S0 to S9) are automatically allocated based on the input speed value in the ascending order. Numbers are constantly reallocated even while inputting. To delete the memory, enter "--" to speed value and save.

● Republication, redistribution or reproduction of the contents of this manual, in whole or in any part, without TEIN's prior written consent is prohibited by copyright law.

# How to Switch Display

## How to Switch Display

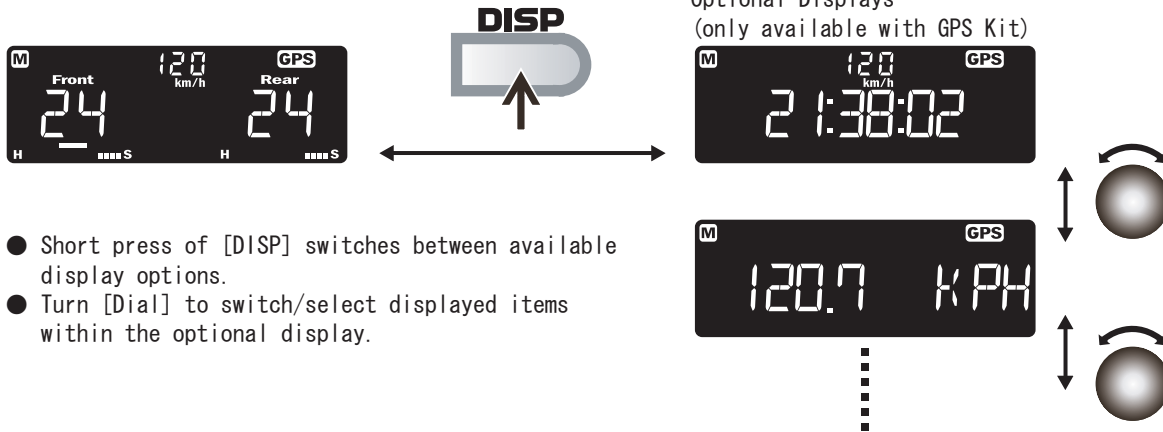

- Short press of [DISP] switches between available display options.
- Turn [Dial] to switch/select displayed items within the optional display.

## Optional Displays

### Clock Display



- [Dial] Long press: time difference input  
\* After input, long press [Dial] to return.

REF

Japan's time difference from UTC is +9 hours.

CONFIRMATION

Optional GPS Kit is required.

### Vehicle Speed Display

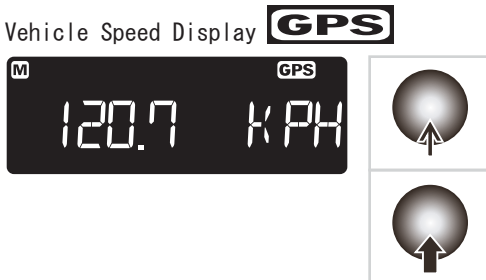

- Speed unit can be switched between km/h and MPH at initial setup. Refer to pg. 64 "2-1".

- [Dial] Short press: display peak speed
- [Dial] Long press: reset peak speed

REF

Speed is not displayed when GPS reception is not good.

CONFIRMATION

Optional GPS Kit is required.

### G-Force

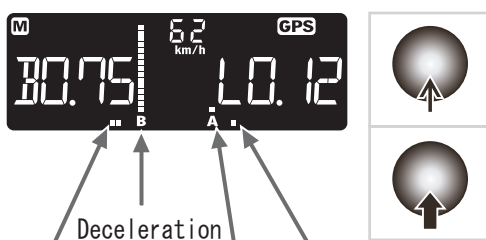

Deceleration G-Force Bar Graph

Leftward G-Force Bar Graph

Acceleration G-Force Bar Graph

Rightward G-Force Bar Graph

- Left side of LCD : G-Force (B = Deceleration / A = Acceleration)
- Right side of LCD : Left and Right G-Force (R = Rightward / L = Leftward)
- [Dial] Short press: display peak value (The largest G-force values in deceleration/leftward and acceleration/rightward will be displayed alternately.)
- [Dial] Long press: reset peak value

- Reproduction, redistribution or reproduction of the contents of this manual, in whole or in any part, without TEIN's prior written consent is prohibited by copyright law.

## How to Switch Display

### GPS Information Display



- Latitude, longitude and altitude are displayed.



ALT: Altitude (Unit of altitude is linked to unit of speed;  
km/h : M / MPH : ft)

E/W: Longitude

N/S: Latitude

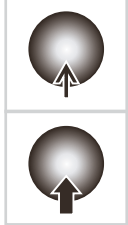

- [Dial] Short press: switch display between longitude, latitude and altitude
- [Dial] Long press: change coordinate displays (degrees, deg+min, or deg+min+sec)

REF

Error in GPS information is displayed as-is.

CONFIRMATION

Optional GPS Kit is required.

### Trip Meter Display



- Trip meter function based on GPS information can store up to 10 records in TP1 - TP10.

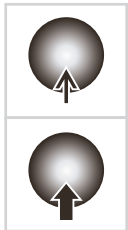

- [Dial] Short press: switch to the next trip data; TP1 - TP10
- [Dial] Long press: reset trip data

REF

Error in GPS information is displayed as-is.

REF

When GPS reception is interrupted, the system calculates the trip data from the straight-line distance between the positions before and after the interruption.

CONFIRMATION

Optional GPS Kit is required.

- Reproduction, redistribution or reproduction of the contents of this manual, in whole or in any part, without TEIN's prior written consent is prohibited by copyright law.

# How to Change Settings

## Changing Control Parameters

- How to Change Memory Settings in Manual Mode Refer to pg. 56.
- How to Modify G-Force Change-Points Refer to pg. 59.
- How to Modify Speed Change-Points Refer to pg. 61.



## Changing Basic Settings

Common Operations to Change Settings

### 1. Changing Display / Operation Menu

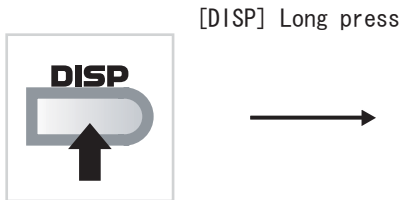

[DISP] Long press

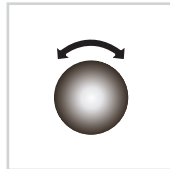

● Turn [Dial] to select from the following setting menus:

- 1-1. G-force bar graph display .....pg. 65
- 1-2. G-force bar graph scale .....pg. 65
- 1-3. Volume .....pg. 65
- 1-4. Display color .....pg. 66
- 1-5. Brightness .....pg. 66
- 1-6. Dimmer .....pg. 67
- 1-7. LCD view .....pg. 67
- 1-8. Correction of G-force .....pg. 67
- 1-9. Confirming communication status ...pg. 68

When setting is completed



● To move to other setting menu  
[Dial] Short press



To complete operation and return to initial display  
[DISP] Short press

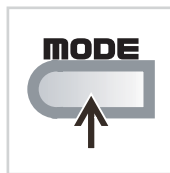

To return from setting displays  
[MODE] Short press

### 2. How to Change Basic Settings

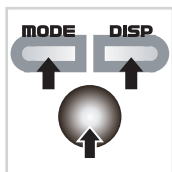

[MODE] + [DISP] + [Dial]  
Long press simultaneously

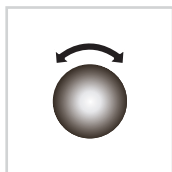

● Turn [Dial] to select from the following setting menus:

- 2-1. Vehicle speed unit .....pg. 51 2~4
- 2-2. Damping force adjustment mode ...pg. 51-52 5~7
- 2-3. Driver mode .....pg. 52 8~9
- 2-4. Driver unit .....pg. 52 10~15

● Reproduction, redistribution or reproduction of the contents of this manual, in whole or in any part, without TEIN's prior written consent is prohibited by copyright law.

## How to Change Settings

### Hot to Turn G-Force Bar Graph ON/OFF



- To turn ON/OFF G-force bar graph display in manual mode (pg.55).
- When the G-force bar graph is OFF, damping force level bar graph is displayed.

Setting	Display	Operation	Instruction	Available Options	Default
1	G BAR OFF		[Dial] Short press		
2	G BAR OFF		[Dial] Turn	ON OFF	ON

### How to Change Bar Graph Scale

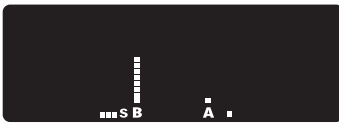

- The scale of bar graph can be selected from the followings:  
 0.3G : focuses on lower level (0 - 0.3)  
 1.0G : focuses wider range (0 - 1.0)  
 Sensitiveness : 1.0G < 0.3G

Setting	Display	Operation	Instruction	Available Options	Default
1	G SCAL 0.3G		[Dial] Short press		
2	G SCAL 0.3G		[Dial] Turn	0.3/1.0	0.3

### How to Change the Beeper Volume

VOL1 : Setting Operation Sound Volume

3=high, 2=medium, 1=low, 0=mute

Setting	Display	Operation	Instruction	Available Options	Default
1	VOL1 2		[Dial] Short press		
2	Adjust Volume 1 VOL1 2		[Dial] Turn + Short press	0~3	2

VOL2 : Setting Control Volume in GA/SA Modes

3=high, 2=medium, 1=low, 0=mute

Setting	Display	Operation	Instruction	Available Options	Default
1	VOL2 2		[Dial] Short press		
2	Adjust Volume 2 VOL2 2		[Dial] Turn + Short press	0~3	2

- Republication, redistribution or reproduction of the contents of this manual, in whole or in any part, without TEIN's prior written consent is prohibited by copyright law.

# How to Change Settings

## How to Change Display Color

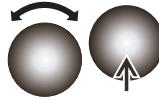

Switch Display Colors

Setting	Display	Operation	Instruction	Available Options	Default
1	COLOR GR		[Dial] Short press		
2	COLOR GR		[Dial] Turn + Short press	AM GR BL WH USER	WH

\* AM = Amber, GR = Green, BL = Blue, WH = White, USER = Custom Color

## How To Set Custom Color

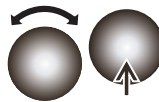
Adjust luminance of red, green and blue to select/set custom color.

Setting	Display	Operation	Instruction	Available Options	Default
1	COLOR USER		[Dial] Long press		
2 Adjust User Color	USER 636363		[Dial] Turn + Short press	0~63	
3			Repeat the above procedure 2		
4 Set User Color			[Dial] Long press		

\* First 2 digits of 6-digit color code are for red, 3rd & 4th digits are for green and last 2 digits are for blue.

## How to Adjust Brightness

Adjust Display Brightness

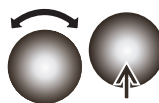
Setting	Display	Operation	Instruction	Available Options	Default
1	BRIGHT 2		[Dial] Short press		
2	BRIGHT 2		[Dial] Turn + Short press	0~3	2

\* Brightness: 3=bright, 2=normal, 1=dark, 0=unseen

## How to Change Settings

### How to Turn Dimmer Function ON/OFF

This function automatically adjusts brightness of the LCD according to the brightness of its surroundings.  
ON: enabled / OFF: disabled

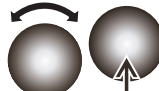
Setting	Display	Operation	Instruction	Available Options	Default
1	DIMMER ON		[Dial] Short press		
2	DIMMER ON		[Dial] Turn + Short press	ON OFF	ON

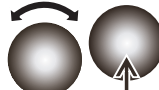

### How to Adjust LCD VIEW

LCD view angle can be adjusted for better visibility, according to the controller's position.  
LCD VIEW 1: the controller is installed at or around eye level  
LCD VIEW 2: the controller is installed at lower position

Setting	Display	Operation	Instruction	Available Options	Default
1	LCD VIEW 1				
2	LCD VIEW 1			LCD VIEW 1 LCD VIEW 2	LCD VIEW 1

### Recognizing Controller Installation Angle (Correction of G-Force Direction)

Allow the G-sensor to recognize its angle against the vehicle.  
Before starting operation, park the vehicle on the level surface where you can move the vehicle 20m (approx. 65ft) straight forward.  
As the sensor judges from acceleration, the vehicle needs to have approx. 0.2G.

Setting	Display	Operation	Instruction	Available Options
1	G INIT		[Dial] Short press	
2	G PUSH DIAL		[Dial] Short press	
	G STAND BY			
3	G RUN		After the beeper, move the vehicle straight forward. *1	
4	G STOP		Stop the vehicle when the beeper sounds. (after 5 seconds)	
5	G SET OK		[Dial] Short press	



**CAUTION**

\*1 Before moving, confirm the safety of surrounding conditions.

Move the vehicle straight forward, gradually accelerating.



**CONFIRMATION**

Stop the vehicle when "STOP" is shown and the beeper sounds  
(when the sensor detects more than 0.2G).



**CONFIRMATION**





Redo if the vehicle decelerates or backs up before the beeper sounds.

- Republication, redistribution or reproduction of the contents of this manual, in whole or in any part, without TEIN's prior written consent is prohibited by copyright law.

# How to Change Settings

## How to Confirm Status

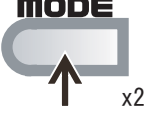
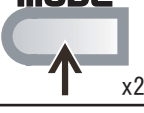
- You can confirm communication status with driver units.

	Setting	Display	Operation	Instruction
1	Normal	STATUS OK		[MODE] Short press
2	Error Found	STATUS NG		[Dial] Short press
2-1	Driver Unrecognized	NONE DR 1		[Mode] Short press x 2 times
2-2	Short Circuit	SHORT DR 11		[Mode] Short press x 2 times
2-3	Disconnected	OPEN DR 22		[Mode] Short press x 2 times
2-4	Driver Overheated	TMP-0 DR 1		[Mode] Short press x 2 times

\* DR1 is shown as sample. Actual driver ID (1-4) with any troubles will be displayed.

\* DR22 is shown as sample. DR\*#: \* indicates driver ID (1-4) and # is channel (1 or 2).

## Troubleshooting

### 2-1 Driver unrecognized

- Confirm that driver's power supply is connected properly. →pg. 47
- Confirm that all driver IDs are correctly set. If not, set correct IDs. →pg. 64 "2-4".
- Controller does not recognize any of driver units.  
→There is a possibility that the controller fails to operate properly.

- Controller recognizes driver units, except one. → One driver units may not be working.

### 2-2, 2-3 Short-circuit or Disconnection

- Confirm that all driver units and the motors are properly connected.
- Switch motors connected to Ch1 and Ch2:  
→If the same error is detected, the driver unit may not be operating properly.  
→If the error channel is changed, there might be problem in motor and/or the wiring.

### 2-4 Driver Overheated

- Check if the damping force display is "--".
- Check if the driver unit's surroundings are heated.  
→If this occurs often, relocate the driver unit to where it will not be exposed to high temperature.
- Check if the driver unit itself is heated. Do NOT touch the unit with bare hands, to prevent burns.

**CONFIRMATION** To operate again, turn off the power, wait until the driver unit and its surroundings are cooled down and then turn the power back on.

**REF** It is normal for the driver unit to get heated due to frequent motor rotation under certain settings.

- Republication, redistribution or reproduction of the contents of this manual, in whole or in any part, without TEIN's prior written consent is prohibited by copyright law.



## What To Do When You Encountered Problems

In case of any trouble, check the followings. If the trouble is not solved, please contact the nearest TEIN office listed on the front cover of this manual.

Power does not turn ON.

- Check if the controller and the connector of power supply filter are firmly connected. →pg. 47
- Check if the power supply filter's fuse has blown.
- Check if the power supply filter's is properly connected. →pg. 47
- Check the brightness of LCD. If the brightness is set to "0", display is barely visible.  
→pg. 64 "1-5"

Buttons do NOT work.

- Is the lock function on? →pg. 50

Driver unit(s) is/are not recognized.

- Check driver unit's communication status. →pg. 64 "1-9"
- Check if the driver unit is properly connected to the power source. →pg. 47
- Check if the driver unit's fuse has blown.
- Check if the driver IDs are input correctly. →pg. 64 "2-4"

Controlling front damping force changes rear damping force, or vice versa.

- Check if the driver IDs are not entered the wrong way around. →pg. 64 "2-4"
- Check if the driver mode is set correctly. →pg. 64 "2-3"

Speed, clock, latitude, longitude and/or altitude are not displayed.

- Check if GPS kit is connected properly. →pg. 47
- Is GPS receiving valid signals?  
→When GPS icon **GPS** is blinking, signals are weak or unavailable. pg. 43
- Roadside trees and/or tall buildings, besides tunnels, may interfere with or interrupt GPS signals.

Clock shows wrong time.

- Have you set time difference correctly? →pg. 62 "Clock Display"

Damping force level does not change though the vehicle speed is increasing.

- Is GPS effective?
- Check if GPS kit is connected properly. →pg. 47
- Is "SA" or "SL" mode selected? →pg. 54
- Have you input "SA" mode settings? →pg. 60
- Are you driving faster than the speed set in "S1"? →pg. 60

Damping force level does not change as you set.

- Have you set the memories correctly?  
→There are 2 separate memory patterns available; according to speed or G-force.  
→ pg. 57 "How to Change Control Modes"
- Have you input the settings in each memory as desired?  
→G-Force Change-Points pg. 58 / Speed Change-Points pg. 60

Speed displayed on LCD is not 0 when the car is parked or does NOT match the vehicle's speedometer.

- Depending on GPS reception, speed may not be calculated correctly
- In general, vehicle's speedometer reads faster than the actual speed.



**CAUTION** Speed displayed in this product is for reference only. Always drive according to vehicle's speedometer.

G-force displayed on LCD is not 0 when the car is parked. (G-force value is wrong.)

- Did you correct G-force on a level surface? →pg. 64 "1-8"
- Is the vehicle parked on a level surface? →if not, the G-sensor may detect G-force.
- Didn't you brake suddenly and the vehicle is stopped non-horizontally?  
→Release brake slowly to make the vehicle horizontal.
- Is the controller unit installed at an angle?  
→Adjust the controller unit so the screen is facing within 45 degrees to the opposite direction of travel, both horizontally and vertically.

- Republication, redistribution or reproduction of the contents of this manual, in whole or in any part, without TEIN's prior written consent is prohibited by copyright law.

Motor emits sounds.

- It is normal that you hear the motor's operating sound when damping force is being adjusted. The volume of the sound varies by vehicle.
- It is also normal that you may hear a small sound when the product is operating to keep the appropriate damping force level, even when the adjustment is not being made.

Error Display



When the system detects a short circuit, an error display comes on forcibly every 5 seconds.

DR\*#: \* indicates driver ID (1-4) and # is channel (1 or 2).

- To cancel the error, turn the power off once and turn it back on again.

Display (damping force level) does not react instantly to dial operation (damping force adjustment).

- LCD might be slow to respond in low-temperature surroundings, such as sub-zero temperature. This is normal and does not affect the operation of motors.
- Motors might also be slow to react under extreme cold but it will improve once the temperature is raised.

Motors are slow to react, right after the engine is started.

- It is normal for the driver units and motors to take longer time to communicate on start-up in low-temperature environment, such as sub-zero temperature.

Motor rotates by itself and/or malfunctions.

- Pairing a single driver ID with multiple controller units might cause false operation. Cancel the incorrect pairing setting and re-set with the correct driver ID. (Refer to pg.53)

Driver(s) is/are paired incorrectly.

- Once paired, a driver unit becomes unsearchable. Input driver IDs manually or reset/cancel the pairing setting(s) to search driver IDs again. (Refer to pg.53)

**CONFIRMATION** To reset driver pairing settings, disconnect 2 3P connectors, connect 2P connector to power supply and keep it connected for at least 20 seconds. Once reset, driver units can be searched from the controller unit.

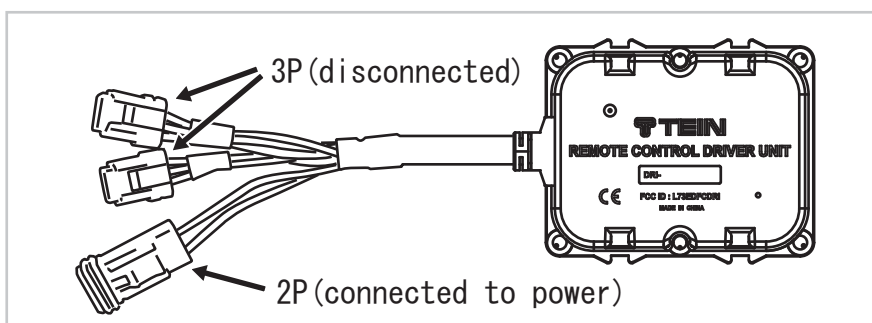

- Republication, redistribution or reproduction of the contents of this manual, in whole or in any part, without TEIN's prior written consent is prohibited by copyright law.

## Limited Warranty

### [Limited Warranty]

1. Subject to the terms of the Limited Warranty set forth below, TEIN warrants that EDFC ACTIVE for the time period stated below to the original purchaser for the use against defects in material and/or workmanship, when installed to and used on the passenger vehicles according to instructions, warnings and cautions described in this manual and under normal operating conditions. If the defect is found under such conditions, TEIN shall repair or replace the product free of charge. With the registering of the product, issuing of the Warranty Certificate shall not in any way limit the legal right of the purchaser. This Limited Warranty is void if any of the exemptions set for the below applies even within the warranty period stated below.
2. Though all the possible measures taken, TEIN assumes NO responsibility for any clerical error, including but not limited to misprinting and/or omission, in the contents of the catalogs published by TEIN.
3. TEIN reserves the right to revise the Limited Warranty without notice whenever the need arise. Should such revision is made, TEIN shall provide the Limited Warranty to the purchaser according to the revised terms.
4. TEIN, in any event, shall not be held liable to the purchaser, for economic loss, compensatory, incidental, consequential or punitive damages for lost profits, down-time, lost production, or defects in purchaser's material or workmanship and/or for labor or shipping charges, arising directly or indirectly from the use of the product. including but not limited to functional failures in other electronic appliances, fires and other accidents.

### [Terms and Conditions]

Provided that the product is installed and used under the normal condition, TEIN shall repair or replace the product free of charge if the defect is found.

1. Terms: For the period of one (1) year from the date of purchase
2. The product shall NOT be covered by the warranty if any of the conditions set forth hereunder applies.

### [Disclaimer – the product may be repaired for a fee, if requested]

- \* The product is reformed or modified in any way, by the purchaser, the installer or the workshop.
- \* Damage or defect, caused directly or indirectly by dropping the product, accident, natural disaster, abnormal voltage and/or the use of power not specified by TEIN. Deformation of controller and/or LCD failure, caused directly or indirectly by exposure to direct sunlight.
- \* Damage or defect caused during installation and/or removal process.
- \* The product is installed or used incorrectly or instructions and warnings are ignored or violated.
- \* Damage or defect, arising from the combined use of the product with the other manufacture's product(s).
- \* Work or job, including but not limited to the performance test of the product, requested by the purchaser.
- \* Damage or defect caused by rust and/or corrosion, due to contact with salt water, snow melting agent and such.
- \* Damage, defect or deterioration, after the expiration of the warranty term.

### [Exclusions – the warranty is void or not applicable]

- \* Unavoidable noise due to the characteristic(s) of the product, including but not limited to the sound generated by the motor.
- \* The product is used for off-road purposes and/or racing type competitions or activities.
- \* The product is not registered. (The purchaser cannot provide the warranty certificate.)
- \* Difference from newer TEIN products, due to product improvements.
- \* Economic loss, compensatory, incidental, consequential or punitive damages for lost profits, down-time, lost production, or defects in purchaser's material or workmanship and/or for labor or shipping charges, arising directly or indirectly from the use of the product.
- \* Damage to or interference with the motor, arising from the combined use of the product with the other manufacturer's bonnet/hood and/or strut tower bar(s).
- \* Damage or defect, due to over-tightening of motor, at above the specified torque.
- \* Clerical error, including but not limited to misprinting and/or omission, in the contents of the catalogs or manuals published by TEIN.
- \* The terms and conditions of the warranty are no longer effective, due to the revision made by TEIN.

- Republication, redistribution or reproduction of the contents of this manual, in whole or in any part, without TEIN's prior written consent is prohibited by copyright law.

## Specifications

- Name of Product : EDFC ACTIVE (Electronic Damping Force Controller Active)
- Application: Controlling the damping force from the driver's seat
- Vehicle to be installed : The vehicles specified by TEIN and the vehicles equipped with shock absorbers specified by TEIN (negative ground 12V DC).
- Conditions : Operation while the vehicle is stopped
- Power Consumption :
  - accessory power supply OFF: 0mA
  - accessory power supply ON (w/o GPS Kit): 50mA
  - accessory power supply ON (w GPS Kit): 120mA
  - if drivers are connected to constant power supply OFF: 3mA

## List of Contents

Description	Part Number	Remarks	
Controller Unit	—	—	
Driver Unit	EDC01-P7370	—	
Motor Cable	EDC01-P8026	—	
Power Supply Filter	EDC01-P8061	—	
Ft Driver Power Cable	EDC01-P8024	—	
Rr Driver Power Cable	EDC01-P8025	—	
Accessory Kit	EDC01-P8023	—	
Motor Kit	(M10, M10)	EDK05-10100	
	(M10, M12)	EDK05-10120	
	(M10, M14)	EDK05-10140	
	(M12, M12)	EDK05-12120	
	(M12, M14)	EDK05-12140	
	(M14, M14)	EDK05-14140	
		(sold separately) Select the one that matches the damper size.	
Strut Kit	EDK06-K4474	(sold separately) For use with pillow ball upper mount on strut suspension.	
GPS Kit	<b>GPS</b>	EDK07-P8022	(sold separately) Includes double-stick tape.

<p>For Japan, Asia(except mainland China), Oceania, Middle East, Russia and Africa</p> <p style="text-align: center;"><b>TEIN, INC.</b></p> <p>995-1 Kamiyabe-cho, Totsuka-ku, Yokohama-shi, Kanagawa 245-0053, Japan Phone : +81-45-810-5501 Fax : +81-45-810-5502 URL : <a href="http://www.tein.co.jp">http://www.tein.co.jp</a></p>	<p>For North, Central and South America</p> <p style="text-align: center;"><b>TEIN U. S. A. , INC.</b></p> <p>9798 Firestone Blvd. Downey, CA 90241 U.S.A. Phone : +1 (562) 861-9161 Fax : +1 (562) 861-9171 URL : <a href="http://www.tein.com">http://www.tein.com</a> E-mail: <a href="mailto:tus_sales@tein.com">tus_sales@tein.com</a></p>
<p>For UK, Europe and Turkey</p> <p style="text-align: center;"><b>TEIN UK LIMITED</b></p> <p>Unit 7 Avant Business Centre, Denbigh West Industrial Estate Milton Keynes MK1 1DL United Kingdom Phone : +44 (0) 1908 632 861 Fax : +44 (0) 1908 375 761 URL : <a href="http://www.tein.co.uk">http://www.tein.co.uk</a> E-mail: <a href="mailto:sales@tein.co.uk">sales@tein.co.uk</a></p>	<p>万一产品出现问题或对本书内容有不明确之处, 请联络本公司。</p> <p style="text-align: center;"><b>天御远东国际贸易(北京)有限公司</b></p> <p>地址: 广州市花都区新华街镜湖大道8号 国光工业园1号门外展厅2-4号 电话: +86 (20) 2860 6990 传真: +86 (20) 2860 6991 网址: <a href="http://cn.tein.com">http://cn.tein.com</a></p>

- Republication, redistribution or reproduction of the contents of this manual, in whole or in any part, without TEIN's prior written consent is prohibited by copyright law.

## 簡易操作マニュアル

簡易操作マニュアルは携帯用に使用頻度の多い設定を抜粋したものです。

本書を車両に携帯しない場合、本ページ左側の点線(切り取り線)に沿ってカットして携帯することを前提としておりますので、必要に応じてご利用下さい。

・インストール編

ドライバを2個使用する場合のみ。その他の場合は取扱説明書P16からの設定を参照して下さい。

※ 操作に入る前に、事前に記録したドライバIDをお手元にご用意下さい。

設定項目	表示画面	操作内容	操作説明	選択項目
1	EASY SET UP		「ダイヤル」 短押し	
2	SEARCHING			
3 ドライバ ペアリング	DR 1:00 00 OF		「ダイヤル」 回転 +短押し	フロントの ドライバIDを 選ぶ
4	DR 2:00 00 ID		「ダイヤル」 回転 +短押し	リアのドラ イバIDを 選ぶ
車両を水平な状態にでき、かつ真っ直ぐ前進できる場所を選んで停車したのち作業を開始する。				
1	G INIT		「ダイヤル」 短押し	
2	G PUSH DIAL		「ダイヤル」 短押し	
	G STAND BY			
3	G RUN		ブザー音が 鳴った後 真っ直ぐ前進 ※1	
4	G STOP		「ダイヤル」 短押し	
5 操作画面に 戻る	G SET OK		「ダイヤル」 短押し	

※1 : 周囲の状況を確認し、安全なことを確認した上で真っ直ぐ前進します。  
ブザー音が鳴ったら停止 (0.2G以上を感知で終了)  
ブザー音の前に減速した場合や、後退した場合はやり直して下さい。

# 簡易操作マニュアル

## ・操作編

「DISP」で表示の変更ができます。オプション画面内は[ダイヤル]短押し/回転で表示の切り替えを行います。

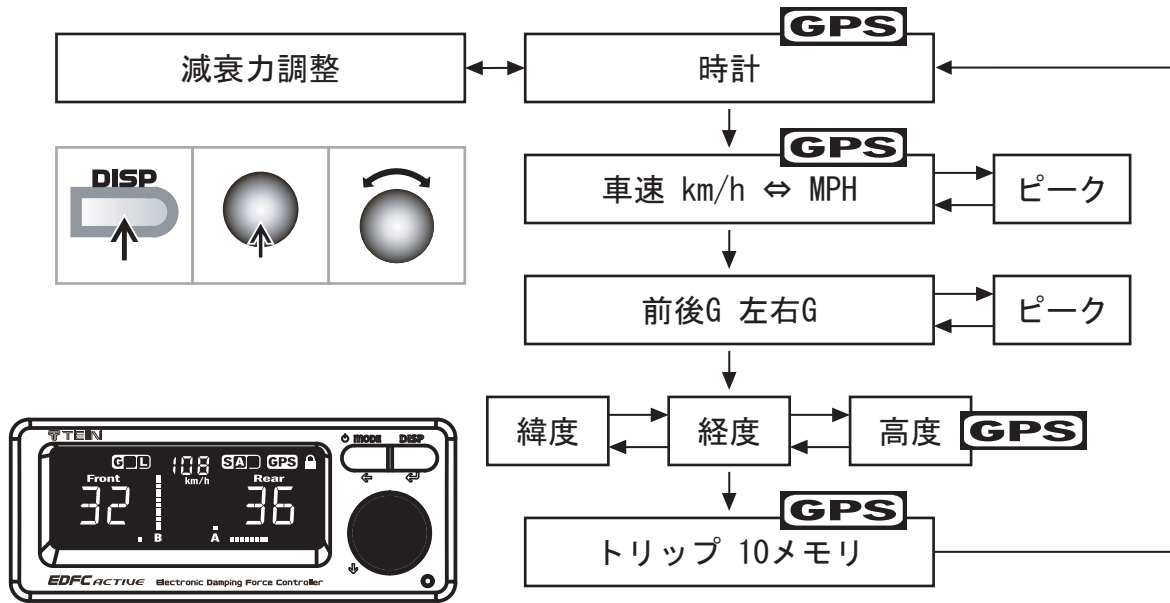

「MODE」で制御の変更ができます。

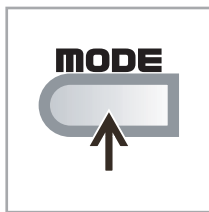





**GPS** GPSのマークがあるものは、別売りのGPSキットと併用した場合に使える機能になります。

## Quick Reference Guide

This guide shows most frequently performed operations exerted from the manual. In case the manual is not kept with the car, cut out this page along the dotted line and carry for quick reference.

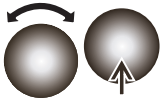
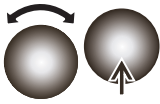
• Set up

- Only for the use of 2 drivers. For other cases, refer to setup procedures starting from pg.51 in the manual.
- Before starting operation, have your driver IDs ready.

	Setting	Display	Operation	Instruction	Available Options
1		EASY SET UP		[Dial] Short press	
2		SEARCHING			
3	Driver Pairing	DR 1:00 00 0F		[Dial] Turn + Short press	Select Ft Driver ID
4		DR 2:00 00 10		[Dial] Turn + Short press	Select Rr Driver ID
Before starting operation, park the vehicle on the level surface where you can move the vehicle 20m (approx. 65ft) straight forward.					
1		G INIT		[Dial] Short press	
2		G PUSH DIAL		[Dial] Short press	
		G STAND BY			
3		G RUN		After the beeper, move the vehicle straight forward. *1	
4		G STOP		Stop the vehicle when the beeper sounds. (after 5 seconds)	
5	Return to Initial Display	G SET OK		[Dial] Short press	

\*1: Before moving, confirm the safety of surrounding conditions. Move the vehicle straight forward, gradually accelerating.

Stop the vehicle when "STOP" is shown and the beeper sounds (when the sensor detects more than 0.2G).

Redo if the vehicle decelerates or backs up before the beeper sounds.

# Quick Reference Guide

• Operation

[DISP] Short press to switch between display options.

[Dial] Short press and/or turn to switch between menus.

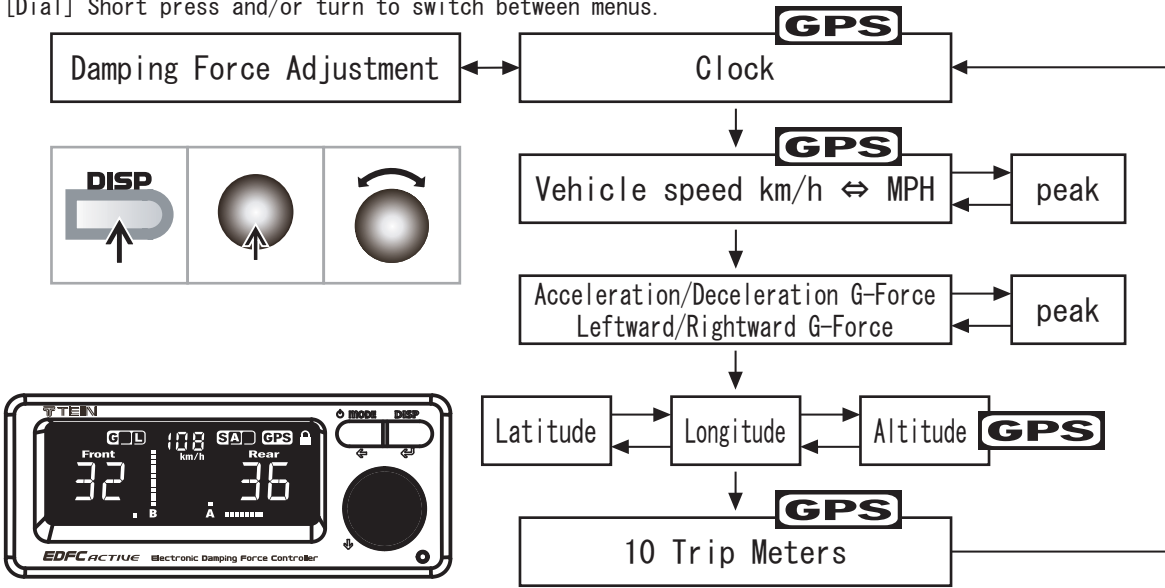

[MODE]

Short press to switch between control modes

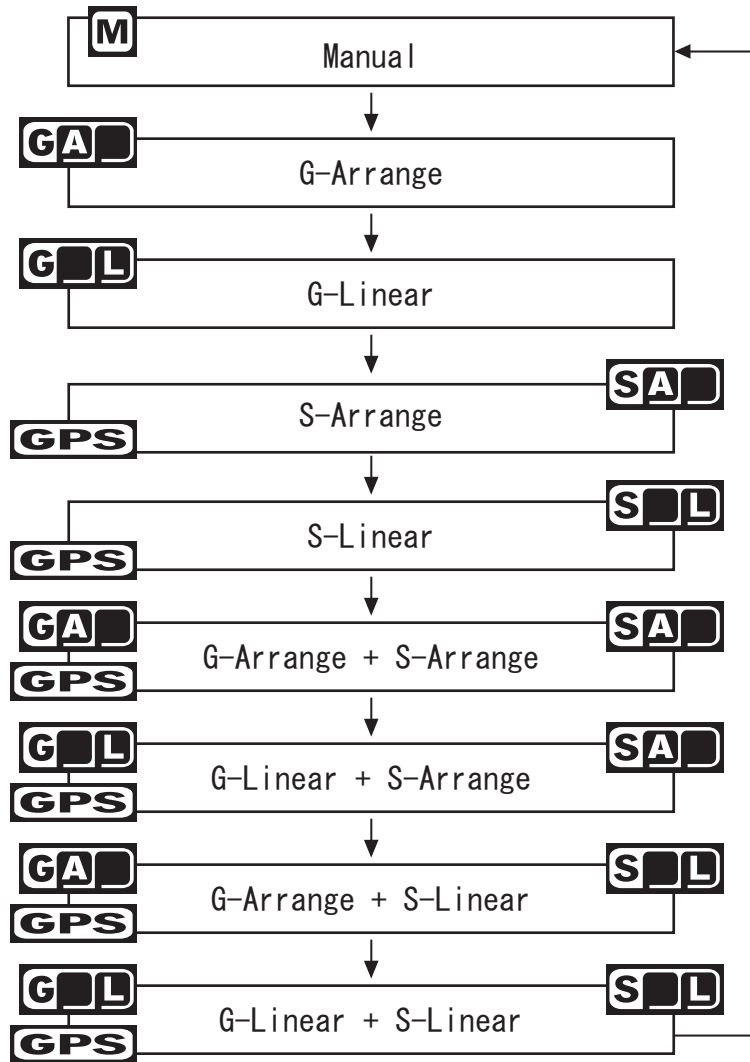
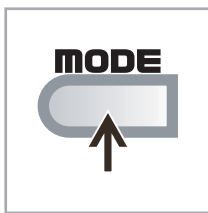

**GPS**

Operations, functions etc.. only enabled when optional GPS Kit (sold separately) is installed/used.