



NEXT GENERATION



# MT-4

Telemetry System  
OPERATING MANUAL

  
2.4 GHz

Spread Spectrum  
Technology By SANWA



# TABLE OF CONTENTS

## PACKAGING

The packaging of your Airtronics *MT-4 2.4GHz FHSS-4T* radio control system has been specially designed for the safe transportation and storage of the radio control system's components. ***After unpacking your radio control system, do not discard the packaging materials.*** Save the packaging materials for future use if you ever need to send your radio control system to us for service or to store your radio control system if you don't plan on using it for an extended period of time.

# INTRODUCTION

We appreciate your purchase of the new Airtronics *MT-4 2.4GHz FHSS-4T* radio control system. This Operating Manual is intended to acquaint you with the many unique features of your state of the art Telemetry-capable radio control system. Please read this operating manual carefully prior to use so that you may obtain maximum success and enjoyment from the operation of your new radio control system.

The *MT-4 2.4GHz FHSS-4T* radio control system has been designed for the utmost in comfort and precise control of all types of model cars and boats. We wish you the best of success and fun with your new purchase!

 Additional 2.4GHz receivers can be purchased and paired with the MT-4 transmitter through the Binding operation. Due to differences in the implementation of 2.4GHz technology among different manufacturers, only Airtronics brand 2.4GHz DS2, FHSS-2, FHSS-3 and FHSS-4T surface receivers are compatible with your radio control system. **Telemetry functions are available only when used with Telemetry-capable receivers.** Please see your Airtronics dealer or [www.airtronics.net](http://www.airtronics.net) for more information.

## SAFETY

 This is a high-output full-range radio control system that should well exceed the range needed for any surface model. For safety, the user should perform a range test at the area of operation to ensure that the radio control system has complete control of the model at the farthest reaches of the operational area. Rather than operating the model, we recommend that the user enlist the help of a fellow modeler to walk the model to the farthest reaches of the track (or for boats, to walk the shore line well in excess of the operational distance of the boat), then test for proper operation.

- Be certain to read this Operating Manual in its entirety.
- 'Safety First' for yourself, for others, and for your equipment.
- Observe all the rules of the field, track, or lake where you operate your radio control equipment.
- If at any time during the operation of your model, should you feel or observe erratic operation or abnormality, end your operation as quickly and safely as possible. DO NOT operate your model again until you are certain the problem has been corrected. TAKE NO CHANCES.
- Your model can cause serious damage or injury, so please use caution and courtesy at all times.
- Do not expose the radio control system to water or excessive moisture.
- Please waterproof the receiver and servos by placing them in a water-tight radio box when operating R/C model boats.
- If you have little to no experience operating R/C models, we strongly recommend you seek the assistance of experienced modelers or your local hobby shop for guidance.
- The Low Voltage Alarm will sound when the transmitter battery voltage drops to the minimum threshold. If this occurs, stop using the transmitter as soon as possible, then replace or recharge the transmitter battery.

 This radio control system operates on the 2.4GHz frequency band. The 2.4GHz connection is determined by the transmitter and receiver pair. Unlike ordinary crystal-based systems, your model can be used without frequency control.

## FCC COMPLIANCE STATEMENT

This equipment has been tested and found to comply with the limits for a Class B digital device, pursuant to Part 15 of the FCC Rules. These limits are designed to provide reasonable protection against harmful interference in a residential installation. This equipment generates, uses, and can radiate radio frequency energy and, if not installed and used in accordance with the operating instructions, may cause harmful interference to radio communications. However, there is no guarantee that interference will not occur in a particular installation.

If this equipment does cause harmful interference to radio or television reception, which can be determined by turning the equipment off and on, the user is encouraged to try to correct the interference by one or more of the following measures:

- Reorient or relocate the receiving antenna.
- Increase the separation between the equipment and the receiver.
- Connect the equipment into an outlet on a circuit different from that to which the receiver is connected.
- Consult the dealer or an experienced technician for help.

This device complies with Part 15 of the FCC Rules and with RSS-210 of Industry Canada. Operation is subject to the following two conditions:

- 1) This device may not cause harmful interference, and....
- 2) This device must accept any interference received, including interference that may cause undesired operation.

**WARNING:** Changes or modifications made to this equipment not expressly approved by Airtronics may void the FCC authorization to operate this equipment.

### RF Exposure Statement

This transmitter has been tested and meets the FCC RF exposure guidelines when used with the Airtronics accessories supplied or designated for this product, and provided at least 20cm separation between the antenna the user's body is maintained. Use of other accessories may not ensure compliance with FCC RF exposure guidelines.

# USAGE PRECAUTIONS

 In addition to the Safety and FCC Compliance sections on the previous page, please observe the following precautions regarding the 2.4GHz frequency band and using your new Airtronics *MT-4 2.4GHz FHSS-4T* radio control system. In addition, pay careful attention to the information in the *Receiver Precautions* section regarding installing the receiver into your model.

## 2.4GHZ FREQUENCY BAND PRECAUTIONS

- The 2.4GHz frequency band may be used by other devices, or other devices in the immediate area may cause interference on the same frequency band. Always before use, conduct a bench test to ensure that the servos operate properly. Also, conduct checks with the transmitter as distant as possible from your model.
- The response speed of the receiver can be affected if used where multiple 2.4GHz radio controllers are being used, therefore, carefully check the area before use. Also, if response seems slow during use, stop your model immediately and discontinue use.
- If the 2.4GHz frequency band is saturated (too many radio controllers on at once), as a safety precaution, the radio control system may not bind. This ensures that your radio control system does not get hit by interference. Once the frequencies have been cleared, or the saturation level has dropped, your radio control system should be able to bind without any problems.

## TRANSMITTER PRECAUTIONS

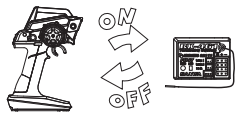

- Turn the transmitter 'ON' first and then turn the receiver 'ON'. After using your model, turn the receiver 'OFF' first, then turn the transmitter 'OFF'. It can be dangerous if you activate the components in reverse order as the servos may start up inadvertently.
- Before use, double-check that the transmitter and receiver batteries have sufficient power.



- The *MT-4 2.4GHz FHSS-4T* transmitter features an internal antenna installed inside the vertical back portion of the carrying handle. Do NOT grab the carrying handle during use! Doing so can block the RF signal, resulting in the loss of control of your model.
- During use, hold the transmitter so that the antenna is orientated as close to vertical as possible at all times. This provides the best RF signal between the transmitter and the receiver. You should never point the antenna directly at your model, nor should you ever 'follow' your model with the antenna, as this results in a weakened RF signal. For more information, see the *Transmitter Features Diagram* section on page XX.
- Do not expose the transmitter or any other components to excessive heat, moisture, fuel, exhaust residue, etc.
- If the outer case becomes dirty, it can be cleaned with a soft dry cloth. If the outer case becomes soiled, it can be cleaned with a damp cloth and liquid detergent. Do not use any solvents to clean the outer case. Solvents will damage the finish.

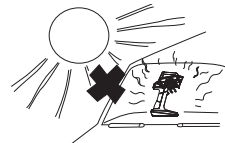

## RECEIVER PRECAUTIONS

- The receiver antenna consists of a coaxial cable and a reception wire (the thin tip at the end of the coaxial cable). When you mount the receiver antenna, do not bend the reception wire. Reception performance decreases if the reception wire is bent.

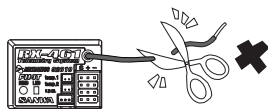

- The antenna wire is delicate, therefore, handle with care. Do not pull on the antenna wire with force. Do not cut or extend the antenna wire.
- The coaxial cable (the thicker portion of the antenna) can be bent into gentle curves, however, do not bend the coaxial cable acutely, or repeatedly bend it, or the antenna core can be damaged.

- The antenna wire should be installed into a vertical plastic tube per your particular model's assembly instructions. Keep the receiver antenna as far away from the motor, battery, and ESC as possible.
- There is a danger of runaway operation if connectors shake loose during use. Make sure that the receiver, servo(s), and switch connectors are securely fitted.
- The receiver is susceptible to vibration, shock, and moisture. Take appropriate measures to protect against vibration and moisture. Failure to take appropriate measures could result in runaway operation or damage to the receiver. We suggest wrapping the receiver in shock-absorbing foam or securing it with double-sided foam tape when installing it into your model.
- When installing the receiver and routing the receiver antenna, avoid contact with any carbon or metal chassis components. Contact between metal parts mounted on a model can result in electrical noise, which can adversely affect receiver performance and possibly result in runaway operation or damage to your model.
- With electric-powered models, be sure to fit the motor with a noise suppression capacitor. Without a noise suppression capacitor, excessive electrical noise generation can cause runaway operation and/or result in damage to your model.
- Use rubber anti-vibration absorbers with servos. Direct transmission of engine vibration to servos can cause servo failure and possibly result in runaway operation with damage to your model.

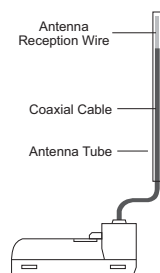

# FEATURES AND SPECIFICATIONS

## SYSTEM FEATURES

- 4-Channel 2.4GHz FHH-4T Digital High-Response Computer Radio with Advanced Programming
- Telemetry System Features Constantly Updated Temperature, RPM and Voltage Displayed on the Telemetry Screen
- High-Power FHSS-4T Technology Provides the Best Reception and Connectivity, Giving Racers Added Assurance
- 4 Cell Dry Cell Battery for Lighter Weight - Also Accepts Optional Ni-Cd/MH Batteries or 2S Li-Po or 2S Li-Fe/A123 Battery Packs
- 18 Model Memory
- Telemetry Logging
- Direct Model Select
- Channel Set Menu
- Servo Reversing
- Steering, Throttle and Brake Dual Rate
- End Point Adjustment
- Exponential or ARC Adjustment
- Servo Speed Adjustment
- Anti-Lock Braking
- Throttle Offset
- Lap and Interval Timers
- Total, Best and Individual Lap Display
- Four Wheel Steering Mixing
- Dual Throttle Mixing w/Dig & Burn
- Normal, SSR and SHR Servo Modes
- Center or Parallel Trim Types
- Step Auxiliary
- Point Auxiliary
- Auxiliary Mixing
- Programmable Fail Safe
- Receiver Battery Voltage Fail Safe
- Digital Trims
- Servo Sub-Trim
- Adjustable Throttle Trigger
- Programmable Switches, Lever and Dial
- Adjustable Steering Wheel
- Adjustable Grip
- Variable Rate Adjustment
- Model Naming
- Model Select
- Model Clear
- Mode Type (FH2/FH3/FH3F/DS2)
- Multi-Function LCD Contrast
- Adjustable Key Volume and Tone
- Programmable Low Voltage Alarm
- Inactivity and Over Voltage Alarms
- Digital Battery Voltage Monitor

## SYSTEM SPECIFICATIONS

### Transmitter

Model: MT-4 Telemetry System

Output Power: 100mW

Nominal Input Voltage: 4.8v ~ 7.4v

Operating Voltage Range: 4.0v ~ 9.6v

Dry Weight: 13.68oz (388gr)

Frequency: 2.4GHz FHSS-4T

### Receiver

Model: 92010 (RX-461) Telemetry

Frequency: 2.4GHz FHSS-4T

Nominal Input Voltage: 4.8v ~ 7.4v

Weight: 0.34oz (9.6gr)

Dimensions: 1.43 x 1.04 x 0.64in (36.2 x 26.5 x 16.3mm)

Fail Safe Limit: 3.5v ~ 7.4v (FH4T) / 3.5v ~ 5.0v (FH2/FH3)

## SERVO RECOMMENDATIONS

We recommend using Airtronics brand servos with your *MT-4 2.4GHz FHSS-4T* radio control system. These are a few of our more popular servos. See your local Airtronics dealer or [www.airtronics.net](http://www.airtronics.net) for pricing, availability and more selection.



Both analog and digital servos will work with your *MT-4 2.4GHz FHSS-4T* radio control system. To get the most out of your experience, we recommend the use of digital servos in SHR or SSR mode. For more information, see page XX.

### 94722 (SDX-1322) Digital Standard Ball Bearing Servo

Torque: 50oz/in (3.6kg/cm @ 4.8v)  
61oz/in (4.4kg/cm @ 6.0v)

Speed: 0.17 sec/60° @ 4.8v  
0.14 sec/60° @ 6.0v

Dimensions: 1.54 x 0.79 x 1.42in  
(39.1 x 20.0 x 36.0mm)

Weight: 1.55oz (43.9gr)

### 94775M (SDX-772) Digital High-Power Metal Gear Dual Ball Bearing Servo

Torque: 124oz/in (8.9kg/cm @ 4.8v)  
151oz/in (10.9kg/cm @ 6.0v)

Speed: 0.17 sec/60° @ 4.8v  
0.13 sec/60° @ 6.0v

Dimensions: 1.54 x 0.78 x 1.50in  
(39.0 x 20.0 x 37.4mm)

Weight: 1.93oz (56gr)

### 94746M (SDX-801) Digital Metal Gear Low-Profile Dual Ball Bearing Servo

Torque: 80oz/in (5.8kg/cm @ 4.8v)  
89oz/in (6.4kg/cm @ 6.0v)

Speed: 0.10 sec/60° @ 4.8v  
0.08 sec/60° @ 6.0v

Dimensions: 1.59 x 0.83 x 1.04in  
(40.4 x 21.1 x 26.4mm)

Weight: 1.77oz (50gr)

### 94780M (SDX-901) Digital High-Power Metal Gear Dual Ball Bearing Servo

Torque: 361oz/in (26.0kg/cm @ 4.8v)  
423oz/in (30.5kg/cm @ 6.0v)

Speed: 0.19 sec/60° @ 4.8v  
0.15 sec/60° @ 6.0v

Dimensions: 1.60 x 0.83 x 1.50in  
(40.6 x 21.1 x 38.1mm)

Weight: 2.33oz (66gr)

# FEATURES FAMILIARIZATION

## TRANSMITTER FEATURES DIAGRAMS

Use the diagrams in this section to familiarize yourself with the basic features of your *MT-4 2.4GHz FHSS-4T* transmitter. Descriptions of these features can be found in the *Transmitter and Receiver Features Descriptions* section on pages XX and XX.

**!** The transmitter antenna is mounted internally and is located in the vertical back portion of the carrying handle. When you're driving your model, hold the transmitter so that the antenna is orientated as close to vertical as possible at all times. This provides the best RF signal between the transmitter and the receiver. You should never point the antenna directly at your model, nor should you ever 'follow' your model with the antenna. Doing so can result in a weakened RF signal.

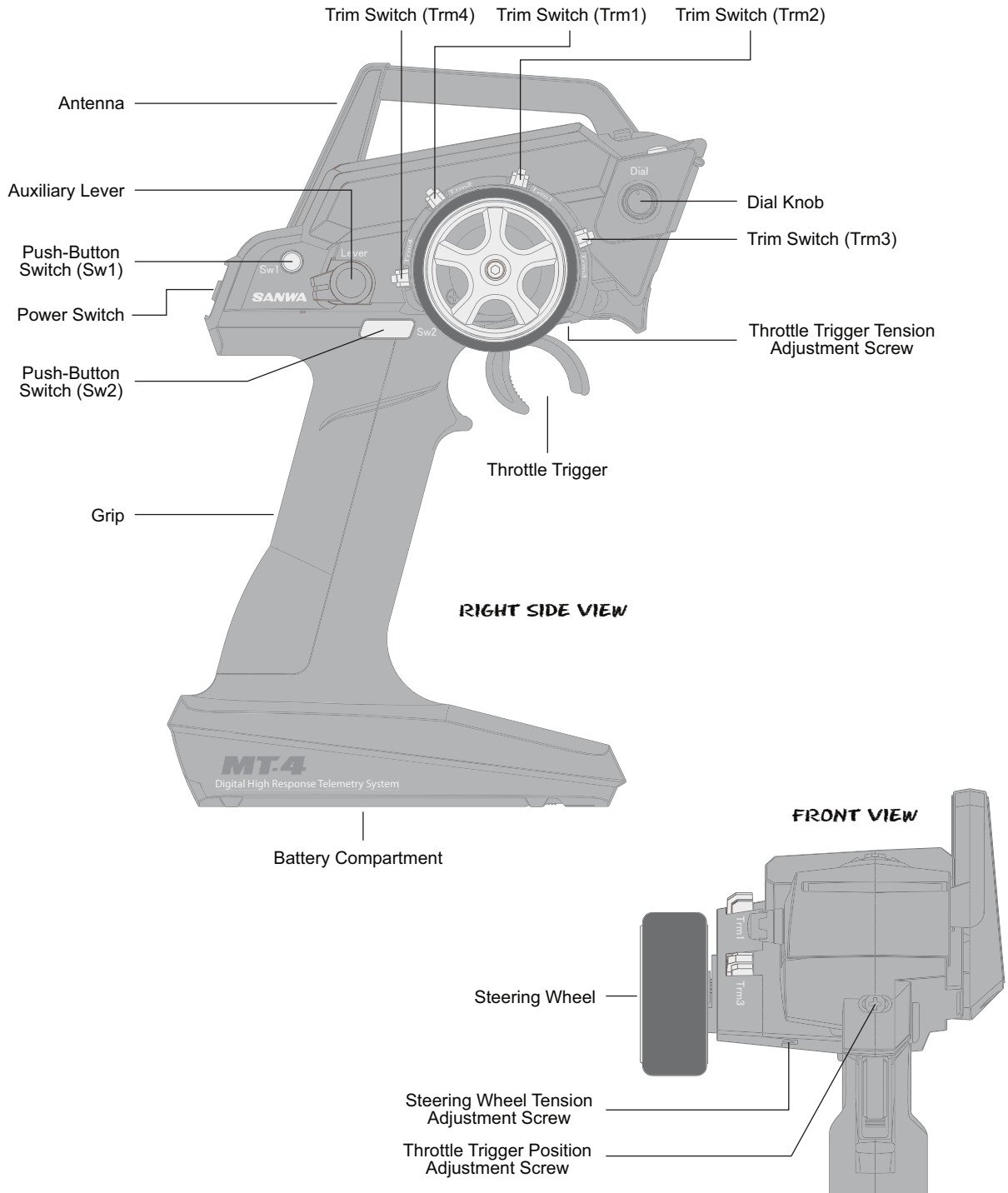

# FEATURES FAMILIARIZATION

## TRANSMITTER FEATURES DIAGRAMS, CONTINUED...

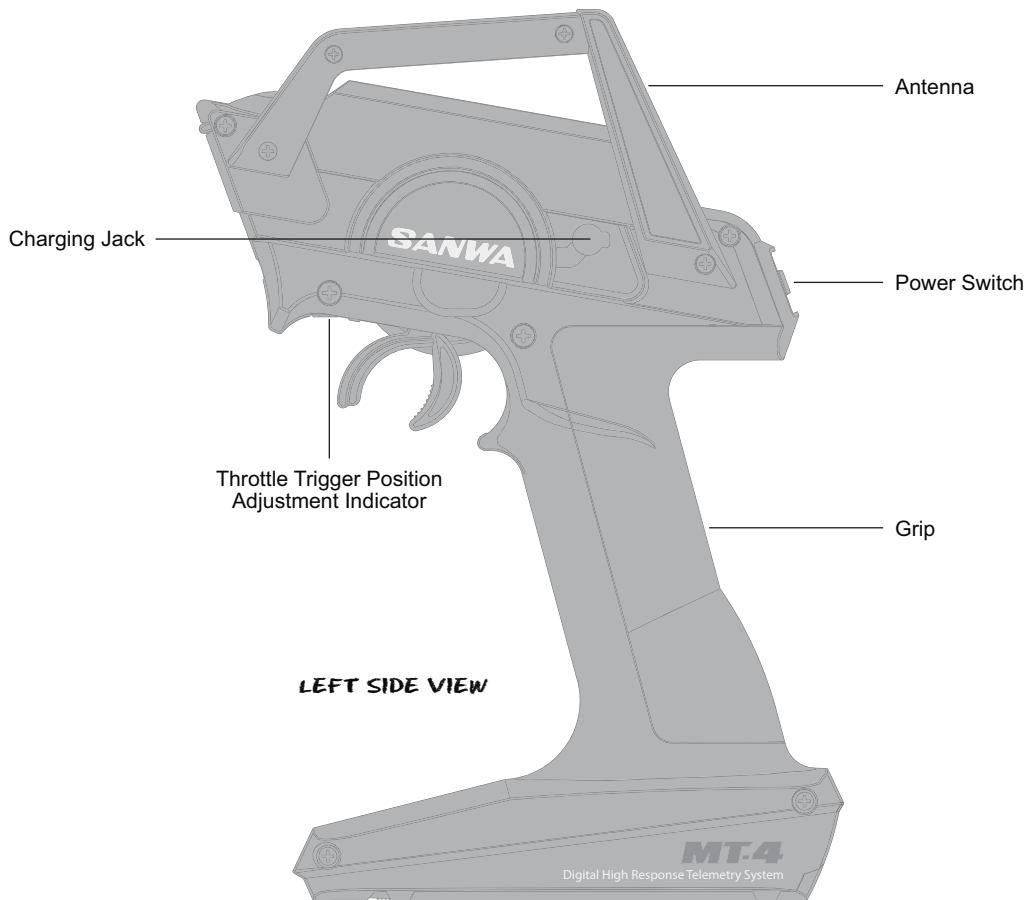
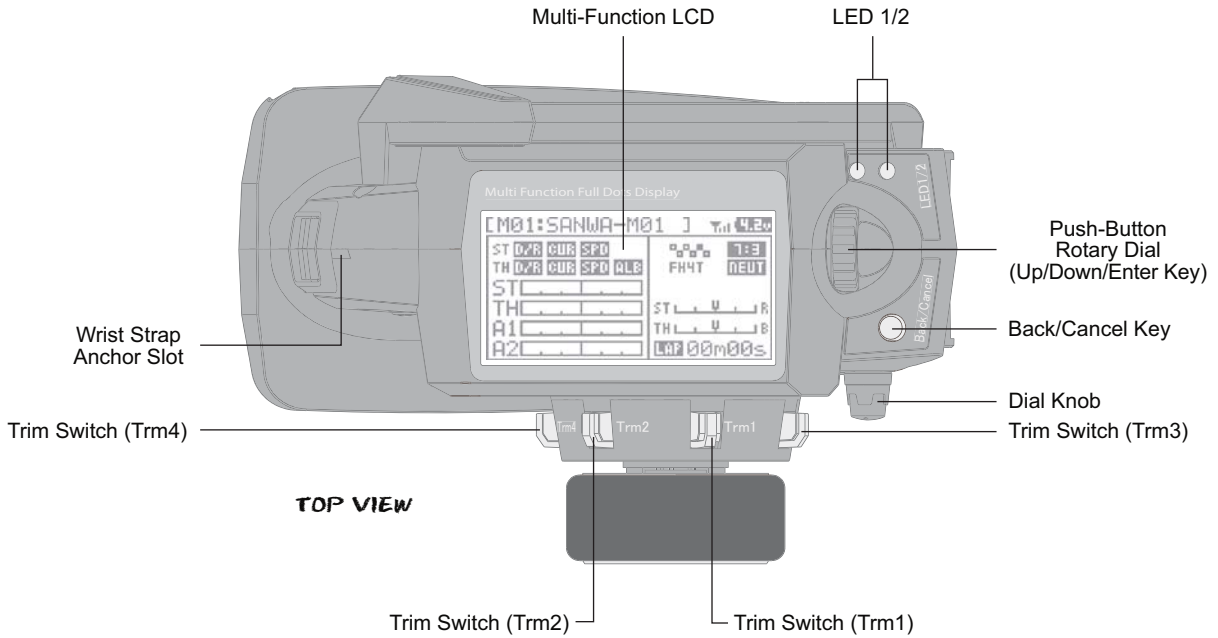

# FEATURES FAMILIARIZATION

## RECEIVER FEATURES DIAGRAM

Use the diagram below to familiarize yourself with the 92010 (RX-461) 4-Channel 2.4GHz FHSS-4T Telemetry receiver included with your *MT-4 2.4GHz FHSS-4T* radio control system. Descriptions of these features can be found in the *Transmitter and Receiver Features Descriptions* section below.

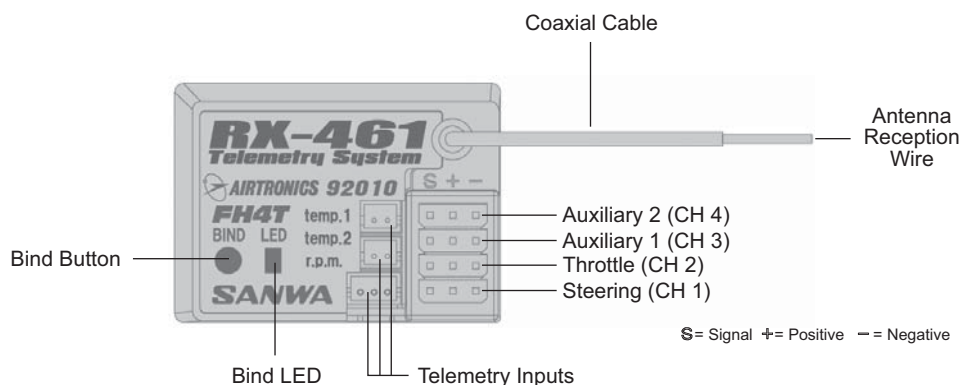

! The receiver battery can be plugged into any channel slot to power the receiver. To utilize all channels and a separate receiver battery, a Y-Harness (not included) must be used. For more information, see the *Receiver Mounting and Connections* section on page XX.

! For information about using the Telemetry System, see pages XX ~ XX and XX ~ XX.

## TRANSMITTER AND RECEIVER FEATURES DESCRIPTIONS

**Antenna:** Transmits the signal from the transmitter to the receiver in the model. Never touch the Antenna during use. Doing so may result in a weakened RF signal or complete loss of control of your model.

**Antenna Reception Wire:** The portion of the receiver antenna that receives the transmitter signal. The Antenna Reception Wire should never be bent or it could be damaged and limit the range of your model.

**Auxiliary Lever:** The Auxiliary Lever is programmable and will perform a different function depending on what function is assigned to it. For example, it can be used to control Auxiliary Channel 2 or to control the Servo Speed function.

**Back/Cancel Key:** Pressing the Back/Cancel Key returns the Programming Cursor to the previous menu. Press and HOLD the Back/Cancel Key to return to the Top Menu.

**Battery Compartment:** Houses the 4 'AA' Alkaline cells that power the transmitter. Alternatively, the transmitter can be powered using four 'AA' Ni-Cd or Ni-MH rechargeable batteries or a 2S Li-Po or 2S Li-Fe/A123 battery pack.

**Bind Button:** Used in the process of Binding the transmitter and receiver.

**Bind LED:** Displays the current status of the receiver.

**Charging Jack:** Used for onboard charging of optional Ni-Cd or Ni-MH batteries. Do not attempt to charge Alkaline batteries. Only the recommended Airtronics 110v AC charger should be used through the Charging Jack. If using an after-market Peak-Detection charger or other type of fast charger, the batteries should be removed from the transmitter to avoid damage to the transmitter circuitry and/or your batteries. Do not attempt to charge a Li-Po or Li-Fe/A123 battery pack through the Charging Jack.

**Coaxial Cable:** The portion of the receiver antenna that extends the Antenna Reception Wire. The Coaxial Cable can be bent into gentle curves, however, do not bend it acutely, or repeatedly bend it, or the antenna core can be damaged. The Coaxial Cable should be installed into a nylon tube (antenna tube) and positioned vertically in your model for the best reception.

**Dial Knob:** The Dial Knob can rotate 360° and is programmable to perform a different function depending on what function is assigned to it. For example, it can be used to increase and decrease programming values, control a trim function or control an Auxiliary Channel.

**Grip:** The Grip is molded from rubber in an ergonomic shape for increased comfort, control and feel. An optional Grip is included that is molded in a different shape that some users may find feels more comfortable.

**LED 1/2:** Displays the current signal output status of the transmitter (LED 1 - Blue) and the Telemetry connection (LED 2 - Red). In addition, one or both LEDs are used to indicate various transmitter conditions. For example, when a Throttle Offset percentage value is programmed, the blue LED will flash.

**Multi-Function LCD:** The heart of the programming and display features of the transmitter. All programming and transmitter display functions are shown on the Multi-Function LCD.



# FEATURES FAMILIARIZATION

## TRANSMITTER AND RECEIVER FEATURES DESCRIPTIONS, CONTINUED...

**Power Switch:** Turns the transmitter 'ON' and 'OFF'.

**Push-Button Rotary Dial:** The Push-Button Rotary Dial (also referred to as the Up Key, Down Key, or Enter key) is used along with the Back/Cancel Key to facilitate transmitter programming. It allows you to quickly and easily navigate the various Programming Menus and switch between the Top Menu and the Telemetry screen.

**Push-Button Switch:** The transmitter features two separate Push-Button Switches in different locations (Sw1 and Sw2). Each Push-Button Switch is programmable and will perform a different function depending on what function is assigned to it. For example, Sw1 can be used to operate a reverse servo in a gas- or glow-powered model and Sw2 can be used to toggle Anti-Lock Braking 'ON' and 'OFF'.

**Steering Wheel:** Proportionally operates the model's right and left steering control. The Steering Wheel features a foam grip for increased comfort, control and feel. In addition, the Steering Wheel spring tension and travel limits can be adjusted.

**Steering Wheel Tension Adjustment Screw:** Used to adjust the spring tension of the steering wheel to best suit the feel of the user. Turning the Steering Wheel Tension Adjustment Screw clockwise increases steering wheel tension and turning the Steering Wheel Tension Adjustment Screw counter-clockwise decreases steering wheel tension.

**Telemetry Inputs:** Located under a removable protective cover, the Telemetry Inputs are where you plug the Temperature and RPM Telemetry sensors into. Two separate temperature inputs and one RPM input are available.

**Throttle Trigger:** Controls the speed of the model, both forward and backward, or the model's brake. The Throttle Trigger position, angle and spring tension can all be adjusted.

**Throttle Trigger Position Adjustment Indicator:** Indicates the current position of the Throttle Trigger. As the throttle trigger position is adjusted forward or backward, the Throttle Trigger Position Adjustment Indicator will move forward or backward.

**Throttle Trigger Tension Adjustment Screw:** Used to adjust the spring tension of the throttle trigger to best suit the feel of the user. Turning the Throttle Trigger Tension Adjustment Screw clockwise increases throttle trigger tension and turning the Throttle Trigger Tension Adjustment Screw counter-clockwise decreases throttle trigger tension.

**Throttle Trigger Position Adjustment Screw:** Used to adjust the position of the Throttle Trigger either forward or backward.

**Trim Switch:** The transmitter features four separate Trim Switches positioned around the steering wheel (Trm1, Trm2, Trm3 and Trm4). Each Trim Switch is programmable and will perform a different function depending on what function is assigned to it. For example, Trm1 and Trm2 can be used to adjust steering and throttle Trim and Trm4 and Trm5 can be used to adjust Dual Rate and steering EPA.

**Wrist Strap Anchor Slot:** Used to attach the wrist strap anchor to the transmitter.

## SERVO CONNECTORS

The 92010 (RX-461) 4-Channel 2.4GHz FHSS-4T Telemetry receiver included with your *MT-4 2.4GHz FHSS-4T* radio control system uses Airtronics 'Z' connectors which are electronically compatible with the servos of other radio control system manufacturers. The connectors are rugged, but should be handled with care.



⚠ If using another brand of servo, double-check the polarity of the servo connector prior to plugging it into the receiver.

⚠ When unplugging the servo connector, it's best not to pull on the servo wire itself. This could result in damage to the servo wire pins in the plastic plug. Always grasp the plastic connector itself.

## TRANSMITTER SAFETY ALARMS AND LED CONDITION INDICATORS

The *MT-4 2.4GHz FHSS-4T* transmitter is equipped with several different safety alarms to warn you of an abnormal transmitter condition. In addition, LED 1 and LED 2 can also be used to indicate various transmitter conditions.

### Over Voltage Alarm

The Over Voltage Alarm will sound if the transmitter battery voltage is greater than 9.6 volts. To clear this alarm, turn the transmitter 'OFF' and replace the transmitter battery with one that when fully charged does not exceed 9.6 volts.

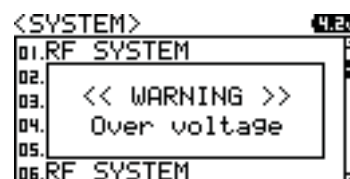

⚠ The *MT-4 2.4GHz FHSS-4T* transmitter's Operating Voltage Range is 4.0 ~ 9.6 volts. DO NOT use a transmitter battery with a voltage greater than 9.6 volts or the transmitter can be damaged!

# FEATURES FAMILIARIZATION

## TRANSMITTER SAFETY ALARMS AND LED CONDITION INDICATORS, CONTINUED...

### Power ON Alarm

The Power ON Alarm will sound if the transmitter is left on for a period of 10 minutes without any control input from the user. This alarm alerts you to prevent unwanted draining of the transmitter battery. To clear this alarm, either turn the transmitter 'OFF' or press the Back/Cancel key or the Push Button Rotary Dial.

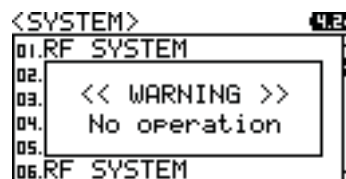

### Low Voltage Alert Alarm

The Low Voltage Alert Alarm will sound when the transmitter batteries reach the Alert Voltage value programmed in the SYSTEM - ALARM menu. The alarm will sound each time the transmitter battery voltage decreases by 0.1 volt. To clear this alarm, press the Back/Cancel key or the Push Button Rotary Dial. For more information about programming the Low Voltage Alert Alarm, see page XX.

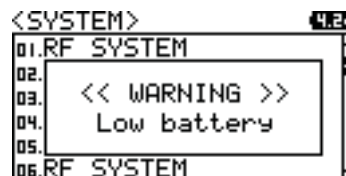

### Low Voltage Limit Alarm

The Low Voltage Limit Alarm will sound when the transmitter batteries reach the Limit Voltage value programmed in the SYSTEM - ALARM menu. This alarm can only be cleared by turning the transmitter 'OFF' and recharging or replacing the transmitter batteries. For more information about programming the Low Voltage Limit Alarm, see page XX.

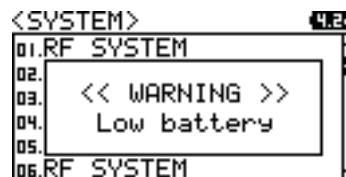

### Telemetry Temperature TEMP1 and TEMP2 Alarm

The Telemetry Temperature Alarm will sound when the TEMP1 and/or TEMP2 temperature reaches the Alert Temperature value programmed in the SYSTEM - TELEMETRY menu. To clear this alarm, press the Back/Cancel key or the Push Button Rotary Dial. For more information about programming the Telemetry Temperature Alarm, see page XX.

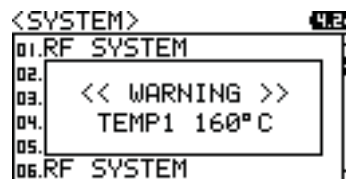

### Telemetry Receiver Input Voltage Alarm

The Telemetry Receiver Input Voltage Alarm will sound when the receiver battery reaches the Alert Voltage value you've programmed in the SYSTEM - TELEMETRY menu. To clear this alarm, press the Back/Cancel key or the Push Button Rotary Dial. For more information about programming the Telemetry Receiver Input Voltage Alarm, see page XX.

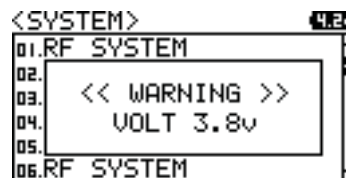

### LED Condition Indicators

LED 1 (Blue) and LED 2 (Red) can be used to determine various transmitter conditions at a glance. The LEDs will alert you to various warnings and other transmitter conditions, as shown in the table below.

LED COLOR	LED CONDITION	LED CONDITION DESCRIPTION
Blue	ON	RF Output Signal OK
Blue	Flash	Throttle Offset Value ON with Positive or Negative Value Programmed
Blue	Slow Flash	Telemetry Logger Function Operating
Blue	Fast Flash	Anti-Lock Braking Function Operating
Red	ON	No Transmitter/Receiver Telemetry Connection
Red	Flash	Telemetry Alarm Started
Red	Flash	Low Voltage Alert Alarm Started
Blue and Red	Flash Alternately	Bind Command Transmitted
Blue and Red	Flash	Power ON Alarm Started
Blue and Red	Fast Flash Alternately	Low Voltage Limit Alarm Started
Blue and Red	Fast Flash Alternately	Over Voltage Alarm Started

# TIPS AND SUGGESTIONS

Many of the Tips and Suggestions on the following pages can be found throughout this Operating Manual, however, we have listed what we feel are the more important ones in this section for your convenience.

# SYSTEM CONNECTIONS

## TRANSMITTER BATTERY OPTIONS

The *MT-4 2.4GHz FHSS-4T* transmitter's Operating Voltage Range is 4.0 ~ 9.6 volts. This allows you to use several different battery options (not included), depending on your preference.

**Alkaline** - In the default configuration, the transmitter is designed to be powered using 4 'AA' Alkaline batteries. This results in a transmitter that is lightweight and well-balanced for unmatched comfort.

**Ni-Cd/Ni-MH** - Rechargeable Ni-Cd or Ni-MH batteries of desired capacity can be used in place of the Alkaline batteries. Using rechargeable Ni-Cd or Ni-MH batteries is more convenient and cheaper in the long run. The higher capacity batteries will also provide longer usage time than most Alkaline batteries.

**Li-Po or Li-Fe/A123** - A 2 cell Li-Po battery pack or a 2 cell Li-Fe/A123 battery pack can be used to power the transmitter. These battery packs are popular due to their light weight and high capacity for long usage time between charges.

 Transmitter power output, range, and speed are the same, regardless of the battery voltage and type used. If using a Li-Po or Li-Fe/A123 battery pack, please observe the warnings in the *Warnings if Using Li-Po or Li-Fe/A123 Batteries* section below.

## ALKALINE BATTERY INSTALLATION

1) Remove the battery cover from the bottom of the transmitter by pushing firmly on the battery cover in the direction of the arrow.

2) Install four fresh 'AA' Alkaline batteries into the battery holder, making sure that the polarity is correct. The direction that each battery should be installed is molded into the bottom of the battery holder (+ Positive and - Negative).

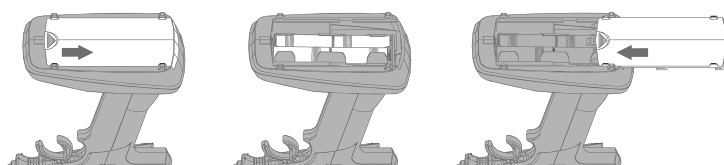

3) Slide the battery cover back onto the transmitter and push it firmly until it 'clicks' closed.

## TRANSMITTER BATTERY CHARGING OPTIONS

The *MT-4 2.4GHz FHSS-4T* transmitter features a Charging Jack that can be used with the Airtronics 95034 Dual Output charger (available separately) to charge the optional Ni-Cd or Ni-MH batteries. This allows you to charge these batteries without removing them from the transmitter.

**WARNING:** Do NOT attempt to recharge Alkaline batteries. Only Ni-Cd or Ni-MH batteries should be charged through the transmitter's Charging Jack, using only the Airtronics 95034 Dual Output charger or equivalent. DO NOT attempt to charge Li-Po or Li-Fe/A123 batteries through the Charging Jack. Do Not use the Charging Jack with a fast charger or a peak-detection charger, or the transmitter could be damaged.

If you use a fast charger or a peak-detection charger to charge the transmitter batteries, the battery holder must be removed from the transmitter first. The circuitry within the transmitter will interfere with the peak-detection charger's normal operation, resulting in over-charging and damaging the battery and possibly the transmitter itself. In addition, the higher charge rate common in many fast chargers can damage the transmitter's circuitry. Damage caused by fast-charging through the transmitter or using an incorrect battery type will not be covered under warranty.

## WARNINGS IF USING LI-PO OR LI-FE/A123 BATTERIES

- Use **ONLY** a 2 Cell Li-Po or Li-Fe/A123 battery pack of desired capacity.

 Both the transmitter and receiver have a Nominal Input Voltage of 4.8 ~ 7.4 volts. **DO NOT USE A 3 CELL LI-PO OR LI-FE/A123 BATTERY PACK** or the transmitter and/or receiver will be damaged.

- Do NOT charge your Li-Po or Li-Fe/A123 battery pack through the transmitter Charging Jack. The battery pack **MUST** be removed from the transmitter for charging or the transmitter could be damaged.
- Use a charger specifically designed to charge Li-Po or Li-Fe/A123 batteries.
- When changing the connector on your battery pack to match the battery power plug in the base of the transmitter or on the receiver's on/off switch, please observe correct polarity. Connecting with reverse polarity will damage the transmitter and/or receiver.
- Observe all safety precautions provided with your Li-Po or Li-Fe/A123 battery pack.
- Damage to the transmitter and/or receiver caused by improper use, wrong battery type, incorrect voltage or reverse polarity will not be covered under warranty.

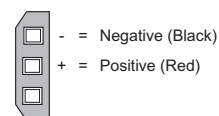

# SYSTEM CONNECTIONS

## RECEIVER CONNECTIONS AND MOUNTING

Use the diagram below to make the connections to the 92010 (RX-461) 4-Channel 2.4GHz FHSS-4T Telemetry receiver included with your *MT-4 2.4GHz FHSS-4T* radio control system.

**!** The 92010 (RX-461) receiver's Nominal Input Voltage is 4.8 ~ 7.4volts. A 2 cell Li-Po or 2 cell Li-Fe/A123 battery pack can be used to power the receiver without the use of a voltage regulator. In addition, this allows you to take advantage of the higher torque and speed provided by using 7.4 volt digital servos.

**!** If you're using an Electronic Speed Control with BEC circuitry, verify that it reduces the voltage to between 4.8 and 7.4 volts before making your connections and turning your radio control system 'ON'.

- We suggest Binding the transmitter and receiver and making all receiver connections to check for correct operation prior to mounting the receiver in your model.
- The receiver should be mounted as far away from any electrical components as possible.
- Route the receiver antenna up through a plastic tube so that it is in the vertical position.
- To protect the receiver from vibration and other damage, we recommend wrapping the receiver in shock absorbing foam or using double-sided foam tape when installing it in your model.

**IMPORTANT:** The receiver battery can be plugged into any channel slot to power the receiver. To utilize all channels and a separate receiver battery, a Y-Harness (not included) must be used. Not all items shown in the illustration below are included with your radio control system.

**!** As a safety precaution, set your model on a stand so the wheels are off the ground before turning on your radio control system or connecting your motor for the first time.

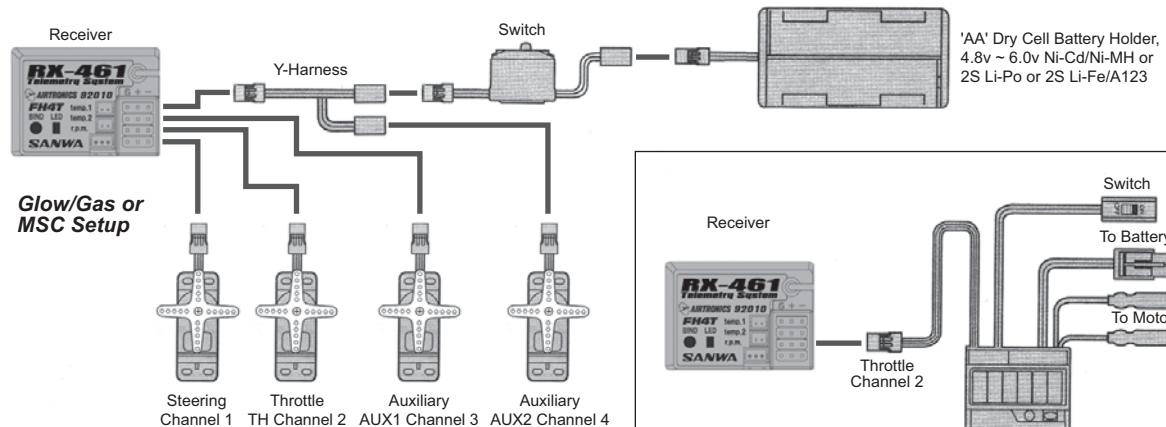

**!** Do NOT use servos rated for 4.8 or 6.0 volts with a 2S Li-Po or Li-Fe/A123 receiver battery pack or damage to the servos could result.

**Electronic Speed Control Setup**

### Bind LED Condition Indicator

The Bind LED on the receiver can be used to determine receiver condition at a glance. The Bind LED will alert you to various receiver conditions, as shown in the table below.

LED COLOR	LED CONDITION	LED CONDITION DESCRIPTION
Blue	ON	Receiving RF Signal
Blue	Slow Flash	Binding Operation
Blue	Flash	Receiving Signal Command
Yellow	ON	RPM Telemetry Sensor Connected and Receiving Input

**!** For information about using the Telemetry system, including mounting the Telemetry Sensors, see page XX.

# ADJUSTMENTS AND OPTIONS

## THROTTLE TRIGGER POSITION ADJUSTMENT

The position of the throttle trigger can be adjusted forward or backward to change the feel of the throttle trigger during use. Some users may prefer the throttle trigger positioned farther forward and some users may prefer the throttle trigger positioned farther back. It all depends on your personal preference.

To adjust the throttle trigger position, follow the step below:

- 1) To move the throttle trigger backward, use a # 1 philips head screwdriver to turn the Throttle Trigger Position Adjustment Screw (A) counter-clockwise. To move the throttle trigger forward, turn the Throttle Trigger Position Adjustment Screw clockwise.

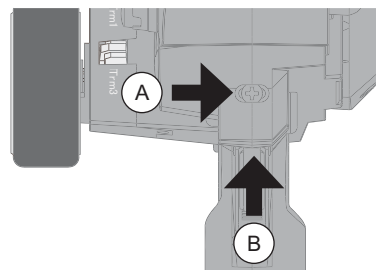

⚠ As you adjust the throttle trigger position, the Throttle Trigger Position Adjustment Indicator (B) will move, indicating the current position of the throttle trigger.

⚠ Moving the throttle trigger position does not affect the physical movement of the throttle trigger. Do not attempt to adjust the throttle trigger position beyond the limits indicated by the Throttle Trigger Position Adjustment Indicator or damage to the transmitter may result.

## THROTTLE TRIGGER ANGLE ADJUSTMENT

The angle of the throttle trigger can be adjusted right or left to change the feel of the throttle trigger during use. Some users may prefer the throttle trigger straight while some users may prefer the throttle trigger angled toward the right or left. It all depends on your personal preference. Throttle trigger adjustment plates are included to fine-tune the angle.

To adjust the throttle trigger angle, follow the steps below:

- 1) Use a # 1 philips head screwdriver to remove the throttle trigger mounting screw (A) from the left side of the transmitter.
- 2) Use the tip of a modeling knife to carefully pop the trigger adjustment plate (B) out of the transmitter.

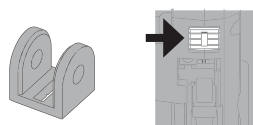
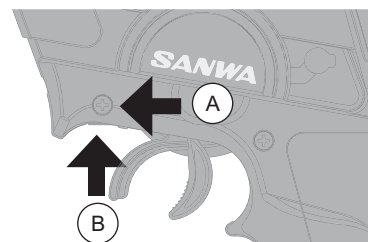

A - Throttle Trigger Centered (Stock)

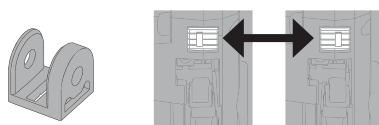

B - Throttle Trigger Angled Slightly.  
Angle Right or Left Depending on Orientation.



C - Throttle Trigger Angled More.  
Angle Right or Left Depending on Orientation.

- 3) Carefully press the desired trigger adjustment plate into the transmitter, making sure to orientate it in the direction you want to angle the throttle trigger, then reinstall and tighten the throttle trigger mounting screw.

## GRIP

Included is an optional molded rubber grip that is shaped differently from the stock grip that's preinstalled on the transmitter. The optional grip is straight near the bottom, which some users may find more comfortable.

To install the optional grip, follow the steps below:

- 1) Remove the original grip from the handle by firmly pulling down on the back of the grip (at the top), then by pulling the grip out along its front edges.
- 2) To install the new grip, align the molded tabs in the grip with the matching slots in the handle, then firmly push the molded tabs into slots, working your way around the grip until the edges of the grip are flush with the handle.

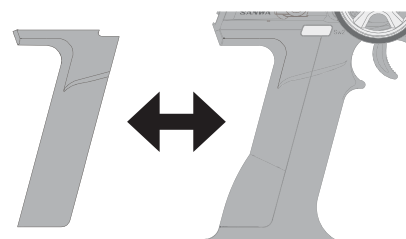

# ADJUSTMENTS AND OPTIONS

## THROTTLE TRIGGER AND STEERING WHEEL SPRING TENSION ADJUSTMENT

The spring tension of the throttle trigger and steering wheel can be adjusted to suit the best feel of the user. Some users may prefer the throttle trigger and/or steering wheel to feel 'firmer' and some users may prefer them to feel 'softer'. It all depends on your personal preference.

To adjust the throttle trigger spring tension, follow the step below:

- 1) To increase the spring tension of the throttle trigger (firmer), use a 1.5mm hex wrench to turn the Throttle Trigger Tension Adjustment Screw (A) clockwise. To decrease the spring tension of the throttle trigger (looser), turn the Throttle Trigger Tension Adjustment Screw counter-clockwise.

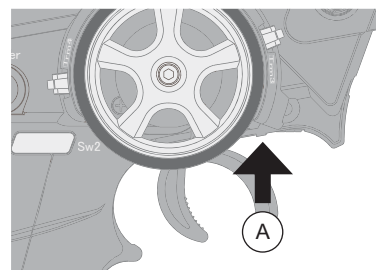

To adjust the steering wheel spring tension, follow the step below:

- 1) To increase the spring tension of the steering wheel (firmer), use a 1.5mm hex wrench to turn the Steering Wheel Tension Adjustment Screw (A) clockwise. To decrease the spring tension of the steering wheel (looser), turn the Steering Wheel Tension Adjustment Screw counter-clockwise.

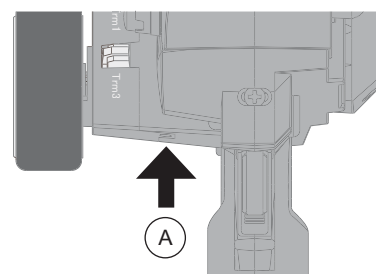

## STEERING WHEEL TRAVEL ADJUSTMENT

The maximum right and left travel of the steering wheel can be adjusted to suit the best feel of the steering wheel and your driving style. Some drivers prefer to limit the travel of the steering wheel as it makes them feel more 'connected' to their model.

To adjust the maximum travel of the steering wheel, follow the steps below:

- 1) Remove the foam steering wheel grip from the steering wheel by firmly pulling it straight off.
- 2) To limit the maximum travel of the steering wheel, use a 1.5mm hex wrench to turn both grub screws (A) clockwise equally the desired amount. To maximize the travel of the steering wheel, turn both grub screws counter-clockwise equally the desired amount.

⚠ After making steering wheel travel adjustments, you must use the VR Adjust function to ensure your steering servo travel limits are equal. For more information, see page XX.

⚠ Limiting the maximum travel of the steering wheel will increase the sensitivity of the steering. We recommend setting negative Exponential to soften the control feel around neutral. For more information, see page XX.

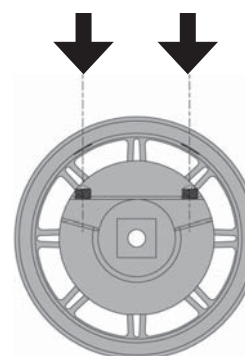

## WRIST STRAP ANCHOR

A wrist strap anchor is included that can be installed onto the transmitter to facilitate the use of a wrist strap (not included).

To install the wrist strap anchor, follow the steps below:

- 1) Remove the self-tapping screw (A) from the transmitter, using a # 1 philips head screwdriver.
- 2) Slide the wrist strap anchor into the mounting slot in the back of the transmitter, then reinstall and tighten the self-tapping screw.

⚠ When installing the wrist strap anchor, note its orientation. The U-shaped groove in the base of the wrist strap anchor should be pointing down.

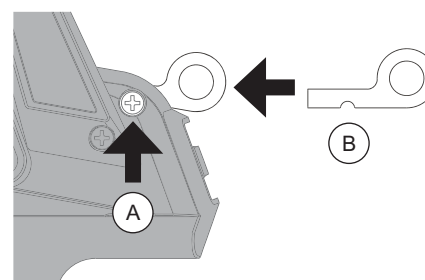

# LCD AND PROGRAMMING KEYS

The MT-4 2.4GHz FHSS-4T transmitter features a Push-Button Rotary Dial and a Back/Cancel key that are used to facilitate transmitter programming. This section describes the main areas of the different Multi-Function LCD screens, in addition to summarizing the functions the Push-Button Rotary Dial and the Back/Cancel key.

## MULTI-FUNCTION LCD OVERVIEW

Use the diagrams in this section to familiarize yourself with the layout and different indicators and displays that comprise the Top Menu and the Telemetry Menu.

### TOP MENU

The Top Menu is displayed when you turn the transmitter 'ON'. The Top Menu displays all pertinent information, such as the Model Name, Modulation Type, Timer, Servo Monitor and much more.

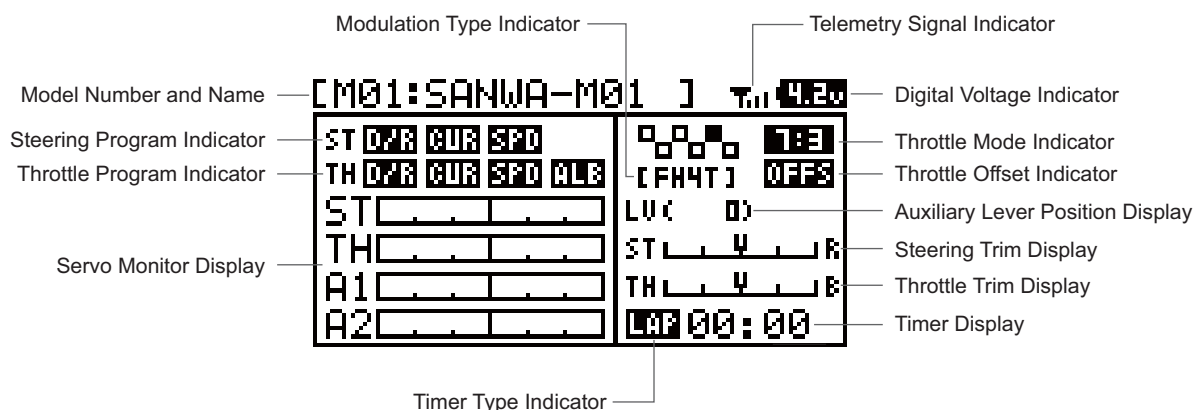

### TELEMETRY MENU

The Telemetry Menu displays all pertinent Telemetry information, such as RPM, Temperature and Receiver Voltage. To display the Telemetry Menu, from the Top Menu scroll DOWN using the Push-Button Rotary Dial.

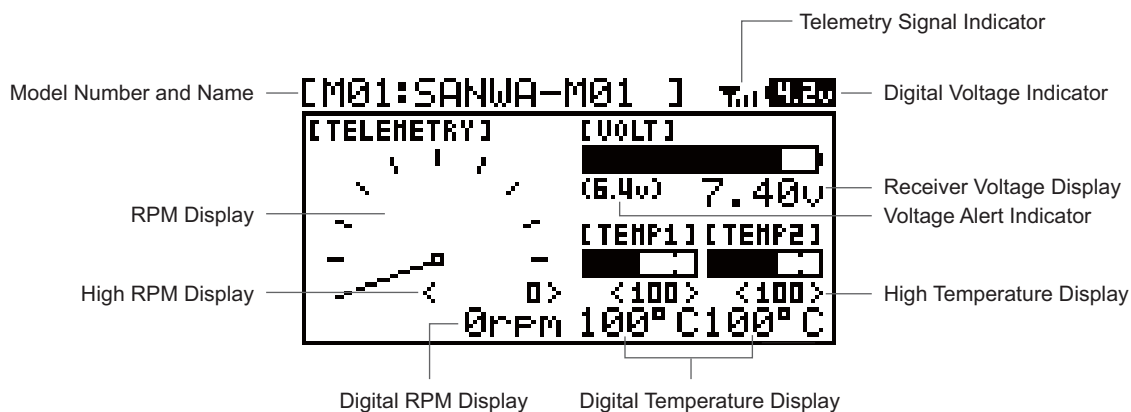

**Auxiliary Lever Position Display:** Displays the current position of the Auxiliary Lever.

**Digital RPM Display:** Displays the current RPM from the RPM Telemetry sensor in digital format.

**Digital Temperature Display:** Displays the current temperature from the TEMP1 and TEMP2 Telemetry sensors in digital format. Temperatures are also displayed in bar graph form above the digital displays.

**Digital Voltage Indicator:** Indicates the current Voltage of the transmitter batteries.

**High RPM Display:** Displays the last highest RPM reading.

**High Temperature Display:** Displays the last highest Temperature reading.

**Modulation Type Indicator:** Indicates the current Modulation Type that the transmitter is set to.

**Model Number and Name:** Displays the Model Number and Model Name of the currently selected model.



# LCD AND PROGRAMMING KEYS

## MULTI-FUNCTION LCD OVERVIEW, CONTINUED....

**Receiver Voltage Indicator:** Indicates the current voltage of the receiver battery.

**RPM Display:** Displays the current RPM from the RPM Telemetry sensor in graphical format.

**Servo Monitor Display:** Displays the output levels of the four different channels in bar graph form, allowing you to monitor servo operation in a virtual manner.

**Steering Program Indicator:** Indicates up to four different programming options that are currently programmed to the Steering channel. The Steering Program Indicator will only be displayed if a Steering channel programming value is programmed.

**Steering Trim Display:** Displays the current position of the Steering Trim Switch.

**Telemetry Signal Indicator:** Indicates the current signal strength of the Telemetry connection between the transmitter and receiver. The Telemetry Signal Indicator will only be displayed when the receiver is turned 'ON' and there is a Telemetry connection active.

**Throttle Mode Indicator:** Indicates the current Throttle Mode type.

**Throttle Offset Indicator:** Indicates that the Throttle Offset function is programmed. The Throttle Offset Indicator will only be displayed if a Throttle Offset percentage value is programmed.

**Throttle Program Indicator:** Indicates up to four different programming options that are currently programmed to the Throttle channel. The Throttle Program Indicator will only be displayed if a Throttle channel programming value is programmed.

**Throttle Trim Display:** Displays the current position of the Throttle Trim Switch.



**Timer Display:** Displays the time of the currently selected Timer.

**Timer Type Indicator:** Indicates the current Timer Type selected, either LAP or INT (Interval).

**Volatage Alert Indicator:** Indicates the currently programmed voltage that the receiver battery voltage must drop to to sound the Low Voltage Alarm.

## PROGRAMMING KEY OVERVIEW AND FUNCTIONS

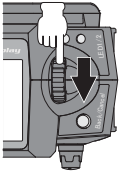
Moving around the different Multi-Function LCD screens and programming the transmitter is accomplished using the Push-Button Rotary Dial and the Back/Cancel key.

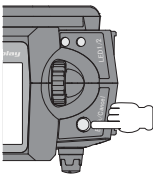
PROGRAMMING KEY	NAME	FUNCTION
	▲ Push-Button Rotary Dial (Scroll UP)	Scrolls the cursor Right or Up. In addition, increases programming values.
	Push-Button Rotary Dial (Scroll DOWN) ▼	Scrolls the cursor Left or Down. In addition, decreases programming values.
	Push-Button Rotary Dial Push (ENTER)	Opens the selected menu or programming option. Press and HOLD to reset the selected programming option to its default value.
	Back/Cancel Key	Returns to the previous menu. Press and HOLD to return to the Top Menu.

# TRANSMITTER AND RECEIVER BINDING

The Binding function allows you to 'Bind' the transmitter and receiver pair. When new, it is necessary to pair the transmitter and receiver to prevent interference from transmitters operated by other users. This operation is referred to as 'Binding'. Once the Binding process is complete, the setting is remembered even when the transmitter and receiver are turned 'OFF'. Therefore, this procedure usually only needs to be done once.

 Under some circumstances, the receiver may not operate after turning the transmitter and receiver 'ON'. If this occurs, perform the Binding process again.

**IMPORTANT:** This section details Binding the 92010 (RX-461) 4-Channel 2.4GHz FHSS-4T Telemetry receiver with Digital or Analog servos set to Normal mode. If you are binding a DS2, FHSS-2 or FHSS-3 receiver to the transmitter, or if you prefer to change the Servo Operating Mode, see the *Binding the Transmitter and Receiver* section on pages XX-XX.

 Before beginning the Binding process, connect your servos and receiver battery pack to the receiver, using the diagram on page XX. Make sure that both the transmitter and the receiver are turned 'OFF'.

## Transmitter and Receiver Binding

- 1) Turn the transmitter 'ON'. The Top Menu will be displayed. Press the ENTER key (Push-Button Rotary Dial) to open the Programming Menu list, then scroll UP or DOWN to highlight the SYSTEM menu. Press the ENTER key to open the SYSTEM menu, then scroll DOWN to highlight the BIND menu. Press the ENTER key to open the BIND menu.

```

<BIND> 4.2v
[RF MODE] : FH4T
[ST] : NOR
[TH] : NOR      BIND
[A1] : NOR      [ENTER]
[A2] : NOR
    
```

 Verify that [RF MODE]: FH4T is displayed. If it isn't, change the Modulation Type to FH4T. For more information, see the *Changing the Modulation Type* section on page XX.

- 2) Scroll UP or DOWN to highlight the [ENTER] command.

```

<BIND> 4.2v
[RF MODE] : FH4T
[ST] : NOR
[TH] : NOR      BIND
[A1] : NOR      [ENTER]
[A2] : NOR
    
```

- 3) While holding down the Bind Button on the receiver, turn the receiver 'ON'. The Bind LED on the receiver will flash slowly. After approximately 2 seconds, release the Bind Button. The Bind LED on the receiver will continue to flash slowly.

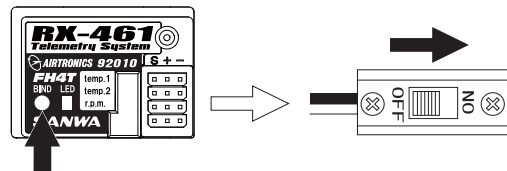

 Use the tip of a non-conductive instrument to press the Bind Button on the receiver. Do NOT use a sharp object!

- 4) Press the ENTER key. The [ENTER] command will begin to flash and the Bind LED on the receiver will flash rapidly, then go out.



```

<BIND> 4.2v
[RF MODE] : FH4T
[ST] : NOR
[TH] : NOR      >>>>>>>
[A1] : NOR      [ENTER]
[A2] : NOR
    
```

- 5) After the Bind LED on the receiver goes out, press the ENTER key a second time. The Bind LED on the receiver will illuminate solid blue and LED 2 on the transmitter will go out, indicating that the Binding procedure is complete and a Telemetry connection has been made.



- 6) Move the steering wheel and throttle trigger to verify that the servos are operating normally, then press and HOLD the Back/Cancel key to return to the Top Menu.

 When the Binding procedure is successful, the Bind LED on the receiver and LED 1 on the transmitter will illuminate solid blue. If the Bind LED on the receiver is flashing rapidly or is not illuminated at all, the transmitter and receiver are not paired. In this case, turn both the transmitter and receiver 'OFF', then repeat the Binding procedure again.

# PROGRAMMING MENUS

## OVERVIEW

To access the various Programming Menus, turn the transmitter 'ON', then press the ENTER key (Push-Button Rotary Dial). A list of Programming Menus will be displayed along the right side of the screen and the last Programming Menu when the transmitter was turned 'OFF' will be highlighted. The currently highlighted Programming Menu will be displayed in the background.

The following Programming Menus are available by scrolling UP or DOWN using the Push-Button Rotary Dial:

MENU	MENU NAME	MENU DESCRIPTION	PAGE #
01.CH-SET	Channel Set	Change Common Programming Options in One Convenient Location	PG. XX
02.D/R	Dual Rate	Adjust Channel Dual Rates	PG. XX
03.EPA	End Point Adjustments	Adjust Channel End Points	PG. XX
04.CURVE	Curve	Adjust Channel ARC or Exponential	PG. XX
05.SPEED	Servo Speed	Change the Servo Speed in the Forward and Return to Neutral Directions	PG. XX
06.ALB	Anti-Lock Braking	Program the Anti-Lock Braking Function	PG. XX
07.OFFSET	Throttle Offset	Program the Throttle Offset Position	PG. XX
08.AUX1	Auxiliary Channel 1	Choose and Adjust Auxiliary Channel 1 Functions and Programming	PG. XX
09.AUX2	Auxiliary Channel 2	Choose and Adjust Auxiliary Channel 2 Functions and Programming	PG. XX
10.TRIM	Servo Trim	Adjust Servo Trim and Servo Sub-Trim	PG. XX
11.REV	Servo Reversing	Change the Direction that the Servos Travel	PG. XX
12.TIMER	Lap and Interval Timers	Program the Lap Timer and the Interval Timer	PG. XX
13.LAP	Lap Times	Displays Current, Past and Best Lap Times	PG. XX
14.F/S	Fail Safe	Program Fail Safe Settings	PG. XX
15.LOGGER	Telemetry Logging	View Logs of Temperature, Voltage and RPM Telemetry Data	PG. XX
16.SYSTEM	System Menu	Access the System Menu	PG. XX

PROGRAMMING MENUS

## 01.CH-SET (CHANNEL SET)

The Channel Set function allows you to make programming changes to each of the four channels without the need to enter each Programming Menu separately. Essentially, the Channel Set function encompasses the most common programming options in one convenient location. For example, you can make all of your desired programming changes, such as End Point Adjustments, Exponential, Servo Speed, Fail Safe settings, etc., for each channel, all from within the same menu.

 This section details how to use the Channel Set function. For information about programming each of the Programming Menus within the CH-SET menu, refer to the specific Programming Menu sections on the pages shown in the table above.

- From the Top Menu, press the ENTER key to open the Programming Menu list.
- Scroll UP or DOWN to highlight the CH-SET menu, then press the ENTER key. The CH-SET menu will be displayed and the cursor will default to [ST].
- Scroll DOWN to move the cursor to the channel you would like to make programming value changes to. Choose from <CH-SET> [ST], <CH-SET> [TH], <CH-SET> [A1] or <CH-SET> [A2].

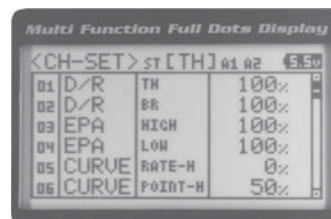
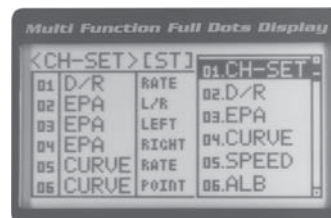

# PROGRAMMING MENUS

## 01.CH-SET (CHANNEL SET), CONTINUED...

- 4) Press the ENTER key to highlight the programming value in the upper right corner.
- 5) Scroll UP or DOWN to highlight the programming value you would like to change, then press the ENTER key to select it. The highlighted programming value will flash indicating you can change the programming value. Scroll UP or DOWN to change the programming value

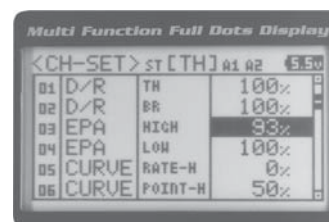

- 6) After changing the desired programming value, press the ENTER key or the Back/Cancel key and the highlighted option will stop flashing, indicating you can scroll UP or Down to highlight another programming option. To change to another channel, press the Back/Cancel key, then scroll UP or DOWN to select the desired channel. Repeat steps 4 and 5 above to change the desired programming values for that channel.
- 7) When complete, press and HOLD the Back/Cancel key to return to the Top Menu.

The following Programming Menus are available from within the Channel Set menu:

[ST] STEERING	[TH] THROTTLE	[A1] AUXILIARY 1	[A1] AUXILIARY 2
01.D/R - RATE	01.D/R - TH	01.EPA - HIGH	01.EPA - HIGH
02.EPA - L/R	02.D/R - BR	02.EPA - LOW	02.EPA - LOW
03.EPA - LEFT	03.EPA - HIGH	03.CURVE - RATE-H	03.CURVE - RATE-H
04.EPA - RIGHT	04.EPA - LOW	04.CURVE - POINT-H	04.CURVE - POINT-H
05.CURVE - RATE	05.CURVE - RATE-H	05.CURVE - RATE-L	05.CURVE - RATE-L
06.CURVE - POINT	06.CURVE - POINT-H	06.CURVE - POINT-L	06.CURVE - POINT-L
07.SPEED - FORWARD	07.CURVE - RATE-B	07.SPEED - FORWARD	07.SPEED - FORWARD
08.SPEED - RETURN	08.CURVE - RATE-H	08.SPEED - RETURN	08.SPEED - RETURN
09.TRIM	09.SPEED - FORWARD	09.TRIM	09.TRIM
10.SUB-T	10.SPEED - RETURN	10.SUB-T	10.SUB-T
11.REV	11.ALB - POINT	11.REV	11.REV
12.F/S	12.ALB - STROKE	12.F/S	12.F/S
	13.ALB - LAG		
	14.ALB - RELEASE		
	15.ALB - HOLD		
	16.TRIM		
	17.SUB-T		
	18.REV		
	19.F/S		

## 02.D/R - (DUAL RATE)

The Dual Rate function allows you to change the control authority of the Steering, Throttle High Side and Throttle Brake Side by changing the amount of servo travel relative to control input. For example, by increasing the Steering Dual Rate, you can make the steering servo travel more which might prevent your model from pushing during turns. If your model oversteers during turns, you can reduce the amount of Steering Dual Rate.

**IMPORTANT:** Prior to programming the Dual Rate function, you should adjust the maximum left and right (or High and Low) End Points, using the End Point Adjustment function. For more information, see page XX.

⚠ Dual Rate is a percentage of End Point Adjustment. For example, if you set the Steering Dual Rate percentage value to 100%, the steering will travel the same amount as defined by your End Point Adjustment programming, and if you set the Steering Dual Rate percentage value to 50%, the steering will travel half that amount.

# PROGRAMMING MENUS

## 02.D/R - (DUAL RATE), CONTINUED....

### Adjusting Steering Dual Rate

- 1) From the Top Menu, press the ENTER key to open the Programming Menu list.
- 2) Scroll UP or DOWN to highlight the D/R menu, then press the ENTER key. The D/R menu will be displayed and [ST] : RATE 100% will be highlighted.
- 3) Press the ENTER key, then scroll UP or DOWN to increase or decrease the Steering Dual Rate percentage value. When the Steering Dual Rate percentage value is decreased, steering servo travel is decreased. When the Steering Dual Rate percentage value is increased, steering servo travel is increased.

D/R ST setting range is 0% to 100%. The default setting is 100%.

