



FCC TEST REPORT

FCC ID: L73-RX-491

On Behalf of

Sanwa Electronic Instrument Co., Ltd

2.4GHz Radio Control System

Model No.: RX-491

Prepared for : Sanwa Electronic Instrument Co., Ltd
Address : 1-2-50, Yoshida Honmachi, Higashi-Osaka, Osaka 578-0982, Japan

Prepared By : Shenzhen Alpha Product Testing Co., Ltd.
Address : Building i, No.2, Lixin Road, Fuyong Street, Bao'an District, 518103,
Shenzhen, Guangdong, China

Report Number : T1881233 05
Date of Receipt : August 03, 2018
Date of Test : August 03, 2018-September 20, 2018
Date of Report : September 20, 2018
Version Number : REV0

TABLE OF CONTENTS

Description	Page
1. Summary of Standards And Results.....	6
1.1. Description of Standards and Results	6
2. General Information.....	7
2.1. Description of Device (EUT).....	7
2.2. Accessories of Device (EUT)	10
2.3. Tested Supporting System Details	10
2.4. Block Diagram of connection between EUT and simulators.....	10
2.5. Test Mode Description.....	10
2.6. Test Conditions	10
2.7. Test Facility.....	11
2.8. Measurement Uncertainty.....	11
2.9. Test Equipment List	12
3. Maximum Peak Output power	13
3.1. Limit.....	13
3.2. Test Procedure.....	13
3.3. Test Setup.....	13
3.4. Test Result.....	13
4. Bandwidth.....	15
4.1. Limit.....	15
4.2. Test Procedure.....	15
4.3. Test Result.....	15
5. Carrier Frequency Separation	19
5.1. Limit.....	19
5.2. Test Procedure.....	19
5.3. Test Result.....	19
6. Number Of Hopping Channel	21
6.1. Limit.....	21
6.2. Test Procedure.....	21
6.3. Test Result.....	21
7. Dwell Time	22
7.1. Test limit	22
7.2. Test Procedure.....	22
7.3. Test Result.....	22
8. Radiated emissions.....	26
8.1. Limit.....	26
8.2. Block Diagram of Test setup.....	27
8.3. Test Procedure.....	28
8.4. Test Result.....	28
9. Band Edge Compliance	32

9.1. Block Diagram of Test Setup.....	32
9.2. Limit.....	32
9.3. Test Procedure.....	32
9.4. Test Result.....	32
10. Power Line Conducted Emissions.....	45
10.1. Block Diagram of Test Setup.....	45
10.2. Limit.....	45
10.3. Test Procedure.....	45
10.4. Test Result.....	45
10.5. Limit.....	46
10.6. Result	46
11. Test setup photo	47
11.1. Photos of Radiated emission.....	47
12. Photos of The EUT.....	48

TEST REPORT DECLARATION

Applicant : Sanwa Electronic Instrument Co., Ltd
 Address : 1-2-50, Yoshida Honmachi, Higashi-Osaka, Osaka 578-0982, Japan
 Manufacturer : Dongguan Fountain Electronics
 Address : Qiaolian Industrial District, Erhuan St., Dongkeng Town, Dongguan City, Guangdong, P.R.China
 EUT Description : 2.4GHz Radio Control System
 (A) Model No. : RX-491
 (B) Trademark : SANWA

Measurement Standard Used:

FCC Rules and Regulations Part 15 Subpart C Section 15.247: 2017, ANSI C63.10:2013

The device described above is tested by Shenzhen Alpha Product Testing Co., Ltd. to determine the maximum emission levels emanating from the device. The maximum emission levels are compared to the FCC Part 15 Subpart C limits both conducted and radiated emissions. The test results are contained in this test report and Shenzhen Alpha Product Testing Co., Ltd. is assumed of full responsibility for the accuracy and completeness of these tests.

After the test, our opinion is that EUT compliance with the requirement of the above standards.

This report applies to above tested sample only. This report shall not be reproduced in parts without written approval of Shenzhen Alpha Product Testing Co., Ltd.

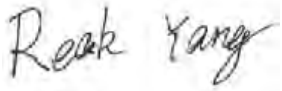
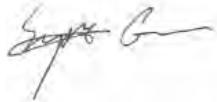
Tested by (name + signature).....:	Reak Yang Project Engineer	
Approved by (name + signature).....:	Simple Guan Project Manager	
Date of issue.....	September 20, 2018	

Revision History

Revision	Issue Date	Revisions	Revised By
00	September 20, 2018	Initial released Issue	Simple Guan

1. SUMMARY OF STANDARDS AND RESULTS

1.1. Description of Standards and Results

The EUT have been tested according to the applicable standards as referenced below:

Test Item	Standards Paragraph	Result
Maximum Peak Output Power	FCC Part 15: 15.247(b)(1) ANSI C63.10 :2013	P
Bandwidth	FCC Part 15: 15.215 ANSI C63.10 :2013	P
Carrier Frequency Separation	FCC Part 15: 15.247(a)(1) ANSI C63.10 :2013	P
Number Of Hopping Channel	FCC Part 15: 15.247(a)(1)(iii) ANSI C63.10 :2013	P
Dwell Time	FCC Part 15: 15.247(a)(1)(iii) ANSI C63.10 :2013	P
Radiated Emission	FCC Part 15: 15.209 FCC Part 15: 15.247(d) ANSI C63.10 :2013	P
Band Edge Compliance	FCC Part 15: 15.247(d) ANSI C63.10 :2013	P
Power Line Conducted Emissions	FCC Part 15: 15.207 ANSI C63.10 :2013	N/A
Antenna requirement	FCC Part 15: 15.203	P
Note:	1. P is an abbreviation for Pass. 2. F is an abbreviation for Fail. 3. N/A is an abbreviation for Not Applicable.	

2. GENERAL INFORMATION

2.1. Description of Device (EUT)

Description	: 2.4GHz Radio Control System
Model Number	: RX-491
Diff	: N/A
Trademark	: SANWA
Power rate	: DC 3.7-7.4V, 30mA
Test Power supply	: 4 *DC 1.5V by AA battery
Operation frequency	: ①2404-2470 MHz ②2405-2471 MHz ③2412-2478 MHz ④2413-2479MHz
Channel No.	: 34Channels
Channel Separation	: 2MHz
Modulation type	: GFSK
Antenna Type	: Integrated Antenna, Maximum Gain is 2.7dBi
Software version	: SP-131_VER1111
Hardware version	: 700A17131A

Channel list:

2404-2470MHz:

Channel	Freq (MHz)	Channel	Freq (MHz)	Channel	Freq (MHz)	Channel	Freq (MHz)
1CH	2404	10CH	2422	19CH	2440	28CH	2458
2CH	2406	11CH	2424	20CH	2442	29CH	2460
3CH	2408	12CH	2426	21CH	2444	30CH	2462
4CH	2410	13CH	2428	22CH	2446	31CH	2464
5CH	2412	14CH	2430	23CH	2448	32CH	2466
6CH	2414	15CH	2432	24CH	2450	33CH	2468
7CH	2416	16CH	2434	25CH	2452	34CH	2470
8CH	2418	17CH	2436	26CH	2454		
9CH	2420	18CH	2438	27CH	2456		

2405-2471MHz:

Channel	Freq (MHz)	Channel	Freq (MHz)	Channel	Freq (MHz)	Channel	Freq (MHz)
1CH	2405	10CH	2423	19CH	2441	28CH	2459
2CH	2407	11CH	2425	20CH	2443	29CH	2461
3CH	2409	12CH	2427	21CH	2445	30CH	2463
4CH	2411	13CH	2429	22CH	2447	31CH	2465
5CH	2413	14CH	2431	23CH	2449	32CH	2467
6CH	2415	15CH	2433	24CH	2451	33CH	2469
7CH	2417	16CH	2435	25CH	2453	34CH	2471
8CH	2419	17CH	2437	26CH	2455		
9CH	2421	18CH	2439	27CH	2457		

2412-2478MHz:

Channel	Freq (MHz)	Channel	Freq (MHz)	Channel	Freq (MHz)	Channel	Freq (MHz)
1CH	2412	10CH	2430	19CH	2448	28CH	2466
2CH	2414	11CH	2432	20CH	2450	29CH	2468
3CH	2416	12CH	2434	21CH	2452	30CH	2470
4CH	2418	13CH	2436	22CH	2454	31CH	2472
5CH	2420	14CH	2438	23CH	2456	32CH	2474
6CH	2422	15CH	2440	24CH	2458	33CH	2476
7CH	2424	16CH	2442	25CH	2460	34CH	2478
8CH	2426	17CH	2444	26CH	2462		
9CH	2428	18CH	2446	27CH	2464		

2413-2479MHz:

Channel	Freq (MHz)	Channel	Freq (MHz)	Channel	Freq (MHz)	Channel	Freq (MHz)
1CH	2413	10CH	2431	19CH	2449	28CH	2467
2CH	2415	11CH	2433	20CH	2451	29CH	2469
3CH	2417	12CH	2435	21CH	2453	30CH	2471
4CH	2419	13CH	2437	22CH	2455	31CH	2473
5CH	2421	14CH	2439	23CH	2457	32CH	2475
6CH	2423	15CH	2441	24CH	2459	33CH	2477
7CH	2425	16CH	2443	25CH	2461	34CH	2479
8CH	2427	17CH	2445	26CH	2463		
9CH	2429	18CH	2447	27CH	2465		

2.2. Accessories of Device (EUT)

Accessories1 : Motor
 Manufacturer : SANWA
 Model : PGS-CX

2.3. Tested Supporting System Details

No.	Description	Manufacturer	Model	Serial Number	Certification or DOC
1	AA Battery case	--	--	--	--

2.4. Block Diagram of connection between EUT and simulators

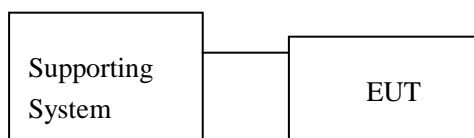

2.5. Test Mode Description

Tested mode, channel, and data rate information	
Mode	Channel
GFSK	Low
	Middle
	High

2.6. Test Conditions

Items	Required	Actual
Temperature range:	15-35 °C	27 °C
Humidity range:	25-75%	56%
Pressure range:	86-106kPa	980kPa

2.7. Test Facility

Shenzhen Alpha Product Testing Co., Ltd
 Building i, No.2, Lixin Road, Fuyong Street, Bao'an District, 518103,
 Shenzhen, Guangdong, China

June 21, 2018 File on Federal Communication Commission
 Registration Number: 293961

July 25, 2017 Certificated by IC
 Registration Number: 12135A

2.8. Measurement Uncertainty

(95% confidence levels, k=2)

Item	Uncertainty
Uncertainty for Power point Conducted Emissions Test	2.74dB
Uncertainty for Radiation Emission test in 3m chamber (below 30MHz)	2.13 dB(Polarize: V)
	2.57dB(Polarize: H)
Uncertainty for Radiation Emission test in 3m chamber (30MHz to 1GHz)	3.77dB(Polarize: V)
	3.80dB(Polarize: H)
Uncertainty for Radiation Emission test in 3m chamber (1GHz to 25GHz)	4.16dB(Polarize: H)
	4.13dB(Polarize: V)
Uncertainty for radio frequency	5.4×10^{-8}
Uncertainty for conducted RF Power	0.37dB
Uncertainty for temperature	0.2°C
Uncertainty for humidity	1%
Uncertainty for DC and low frequency voltages	0.06%

2.9. Test Equipment List

Equipment	Manufacture	Model No.	Serial No.	Last cal.	Cal Interval
3m Semi-Anechoic	ETS-LINDGRE N	N/A	SEL0017	2017.09.22	1 Year
Spectrum analyzer	Agilent	E4407B	MY46185649	2017.09.22	1 Year
Receiver	R&S	ESCI	1166.5950K03-1011	2017.09.22	1 Year
Receiver	R&S	ESCI	101202	2017.09.22	1 Year
Bilog Antenna	Schwarzbeck	VULB 9168	VULB9168-438	2016.09.30	2 Year
Horn Antenna	EMCO	3115	640201028-06	2016.09.30	2 Year
Active Loop Antenna	Beijing Daze	ZN30900A	SEL0097	2016.09.30	2 Year
Cable	Resenberger	N/A	No.1	2017.09.22	1 Year
Cable	SCHWARZBEC K	N/A	No.2	2017.09.22	1 Year
Cable	SCHWARZBEC K	N/A	No.3	2017.09.22	1 Year
Pre-amplifier	Schwarzbeck	BBV9743	9743-019	2017.09.22	1 Year
Pre-amplifier	R&S	AFS33-1800265 0-30-8P-44	SEL0080	2017.09.22	1 Year
Temperature controller	Terchy	MHQ	120	2017.09.22	1 Year
20db Attenuator	ICPROBING	IATS1	82347	2017.09.22	1 Year
18-40 Horn Antenna	18-40G antenna	Sas-574	571	2018-3-15	3 Year
Power Meter	Anritsu	ML2487A	6K00001491	2017.09.22	1 Year

3. MAXIMUM PEAK OUTPUT POWER

3.1.Limit

Please refer section15.247.

For frequency hopping systems operating in the 2400-2483.5 MHz band employing at least 75 non-overlapping hopping channels, and all frequency hopping systems in the 5725-5850 MHz band: 1 watt. For all other frequency hopping systems in the 2400-2483.5 MHz band: 0.125 watts, the e.i.r.p shall not exceed 4W

3.2.Test Procedure

The transmitter output is connected to the RF Power Meter. The RF Power Meter is set to the peak power detection.

3.3.Test Setup

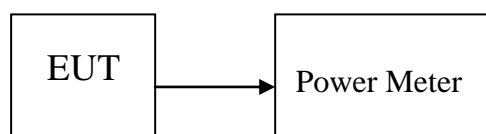

3.4.Test Result

2404-2470 MHz:

Mode	Freq (MHz)	PK Output Power (dBm)	PK Output Power (mW)	Limit (dBm)	Result
GFSK	2404	8.54	7.145	30	Pass
	2436	8.33	6.808	30	Pass
	2470	8.41	6.934	30	Pass
Conclusion: PASS					

2405-2471 MHz:

Mode	Freq (MHz)	PK Output Power (dBm)	PK Output Power (mW)	Limit (dBm)	Result
GFSK	2405	8.29	6.745	30	Pass
	2437	8.12	6.486	30	Pass
	2471	8.13	6.501	30	Pass
Conclusion: PASS					

2412-2478 MHz:

Mode	Freq (MHz)	PK Output Power (dBm)	PK Output Power (mW)	Limit (dBm)	Result
GFSK	2412	8.06	6.397	30	Pass
	2444	8.02	6.339	30	Pass
	2478	8.00	6.310	30	Pass
Conclusion: PASS					

2413-2479 MHz:

Mode	Freq (MHz)	PK Output Power (dBm)	PK Output Power (mW)	Limit (dBm)	Result
GFSK	2413	8.34	6.823	30	Pass
	2445	8.37	6.871	30	Pass
	2479	8.22	6.637	30	Pass
Conclusion: PASS					

4. BANDWIDTH

4.1.Limit

Intentional radiators operating under the alternative provisions to the general emission limits, as contained in §§ 15.217 through 15.257 and in Subpart E of this part, must be designed to ensure that the 20 dB bandwidth of the emission, or whatever bandwidth may otherwise be specified in the specific rule section under which the equipment operates, is contained within the frequency band designated in the rule section under which the equipment is operated.

4.2.Test Procedure

The RF output of EUT was connected to the spectrum analyzer by RF cable and attenuator. The bandwidth of the fundamental frequency was measured by spectrum analyzer with 30kHz RBW and 100kHz VBW. The 20dB bandwidth is defined as the total spectrum the power of which is higher than peak power minus 20dB.

4.3.Test Result

2404-2470 MHz:

Mode	Freq (MHz)	20dB Bandwidth (KHz)	Conclusion
GFSK	2404	1637	PASS
	2436	1850	PASS
	2470	1806	PASS

2405-2471 MHz:

Mode	Freq (MHz)	20dB Bandwidth (KHz)	Conclusion
GFSK	2405	1808	PASS
	2437	1794	PASS
	2471	1803	PASS

2412-2478 MHz:

Mode	Freq (MHz)	20dB Bandwidth (KHz)	Conclusion
GFSK	2412	1736	PASS
	2444	1870	PASS
	2478	1581	PASS

2413-2479MHz:

Mode	Freq (MHz)	20dB Bandwidth (KHz)	Conclusion
GFSK	2413	1404	PASS
	2445	1679	PASS
	2479	1794	PASS

Original Test data For 20dB bandwidth

GFSK mode



Lowest channel

Lowest channel



Middle channel

Middle channel



Highest channel

Highest channel

GFSK mode

2412-2478 MHz	2413-2479MHz
----------------------	---------------------



Lowest channel



Lowest channel



Middle channel



Middle channel



Highest channel



Highest channel

5. CARRIER FREQUENCY SEPARATION

5.1.Limit

Frequency hopping systems shall have hopping channel carrier frequencies separated by a minimum of 25 kHz or the 20 dB bandwidth of the hopping channel, whichever is greater. Alternatively, frequency hopping systems operating in the 2400-2483.5 MHz band may have hopping channel carrier frequencies that are separated by 25 kHz or two-thirds of the 20 dB bandwidth of the hopping channel, whichever is greater, provided the systems operate with an output power no greater than 125 mW

5.2.Test Procedure

The RF output of EUT was connected to the spectrum analyzer by RF cable and attenuator. The carrier frequency was measured by spectrum analyzer with 100kHz RBW and 300kHz VBW.

5.3.Test Result

Mode	Channel separation(MHz)	20dB Bandwidth (KHz)	Limit (KHz)	Conclusion
GFSK (2404-2470MHz)	2.000	1850	1233	PASS
GFSK (2405-2471MHz)	2.000	1808	1205	PASS
GFSK (2412-2478MHz)	2.000	1870	1247	PASS
GFSK (2413-2479MHz)	2.000	1794	1196	PASS

Original test data for channel separation

① 2404-2470 MHz

Channel separation(MHz): 2.000



② 2405-2471 MHz

Channel separation(MHz): 2.000



③ 2412-2478 MHz

Channel separation(MHz): 2.000



④ 2413-2479MHz

Channel separation(MHz): 2.000



6. NUMBER OF HOPPING CHANNEL

6.1.Limit

Frequency hopping systems in the 2400-2483.5 MHz band shall use at least 15 channels

6.2.Test Procedure

The RF output of EUT was connected to the spectrum analyzer by RF cable and attenuator. The number of hopping channel was measured by spectrum analyzer with 100kHz RBW and 300kHz VBW.

6.3.Test Result

Mode	Number of hopping channel	Limit	Conclusion
GFSK	34	>15	PASS

Original test data for hopping channel number

①2404-2470 MHz



②2405-2471 MHz



③2412-2478 MHz



④2413-2479MHz



7. DWELL TIME

7.1. Test limit

Please refer section 15.247

According to §15.247(a)(1)(iii), Frequency hopping systems operating in the 2400MHz-2483.5 MHz. The average time of occupancy on any frequency shall not be greater than 0.4 s within period of 0.4 seconds multiplied by the number of hopping channels employed.

7.2. Test Procedure

7.2.1. Place the EUT on the table and set it in transmitting mode.

7.2.2. Remove the antenna from the EUT and then connect a low loss RF cable from the antenna port to the spectrum analyzer.

7.2.3. Set center frequency of spectrum analyzer = operating frequency.

7.2.4. Set the spectrum analyzer as RBW=1MHz, VBW=1MHz, Span = 0Hz, Sweep = auto.

7.2.5. Repeat above procedures until all frequencies measured were complete.

7.3. Test Result

PASS.

Detailed information please see the following page.

2404-2470 MHz:

Mode	Frequency (MHz)	Pulse Duration (ms)	Dwell Time (ms)	Limit (ms)	Conclusion
GFSK	2404	0.129	82.560	400	PASS
	2436	0.129	82.560		PASS
	2470	0.129	82.560		PASS
Note: 1 A period time = 0.4 (s) * 34 = 13.6(s) 2 Time slot = Pulse Duration * (1600/(2*34)) * A period time/1000					

2405-2471 MHz:

Mode	Frequency (MHz)	Pulse Duration (ms)	Dwell Time (ms)	Limit (ms)	Conclusion
GFSK	2405	0.138	88.320	400	PASS
	2437	0.138	88.320		PASS
	2471	0.138	88.320		PASS
Note: 1 A period time = 0.4 (s) * 34 = 13.6(s) 2 Time slot = Pulse Duration * (1600/(2*34)) * A period time/1000					

2412-2478 MHz:

Mode	Frequency (MHz)	Pulse Duration (ms)	Dwell Time (ms)	Limit (ms)	Conclusion
GFSK	2412	0.138	88.320	400	PASS
	2444	0.138	88.320		PASS
	2478	0.138	88.320		PASS
Note: 1 A period time = 0.4 (s) * 34 = 13.6(s) 2 Time slot = Pulse Duration * (1600/(2*34)) * A period time/1000					

2413-2479MHz:

Mode	Frequency (MHz)	Pulse Duration (ms)	Dwell Time (ms)	Limit (ms)	Conclusion
GFSK	2413	0.138	88.320	400	PASS
	2445	0.138	88.320		PASS
	2479	0.138	88.320		PASS
Note: 1 A period time = 0.4 (s) * 34 = 13.6(s) 2 Time slot = Pulse Duration * (1600/(2*34)) * A period time/1000					

GFSK mode	
2404-2470 MHz	2405-2471 MHz

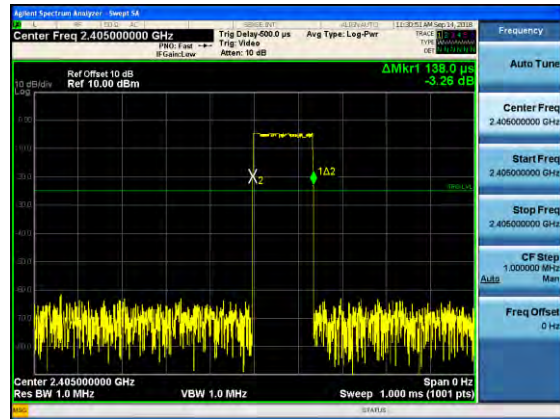
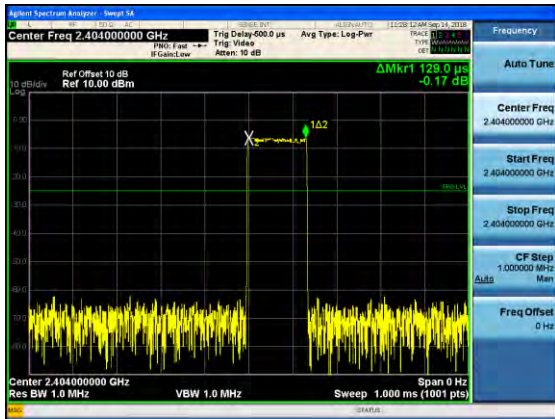

Lowest channel

Lowest channel

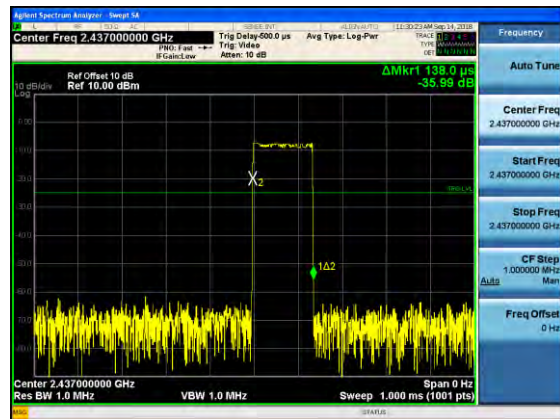
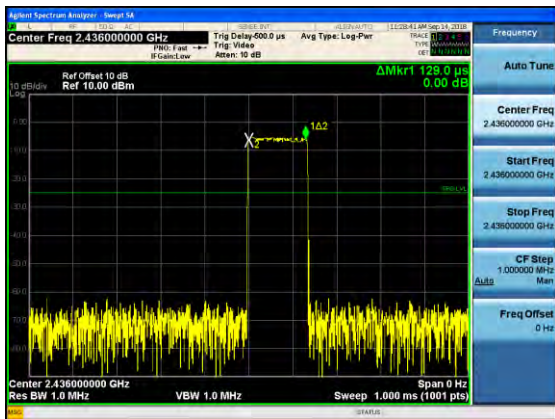

Middle channel

Middle channel

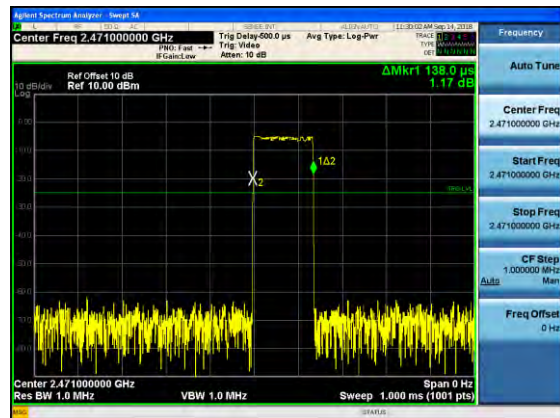

Highest channel

Highest channel

GFSK mode

2412-2478 MHz	2413-2479MHz
----------------------	---------------------

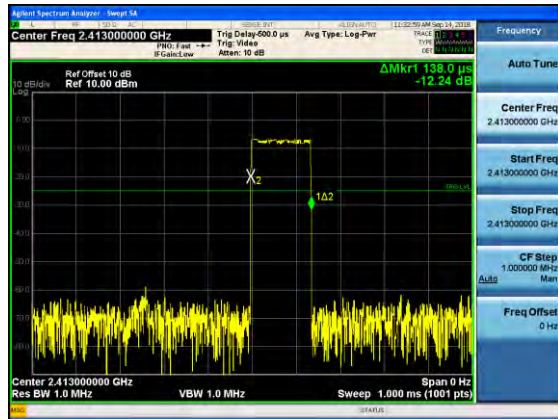
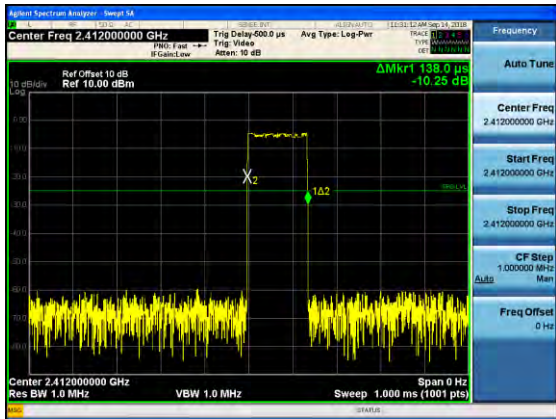

Lowest channel

Lowest channel

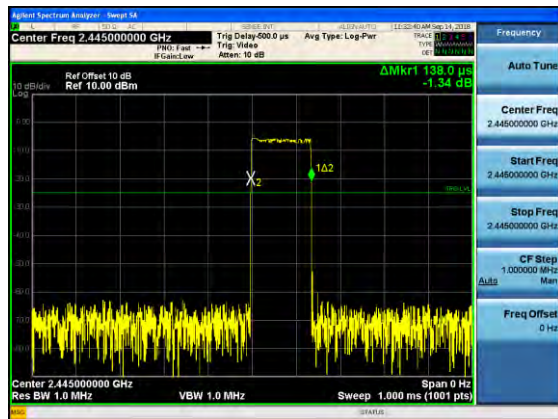

Middle channel

Middle channel

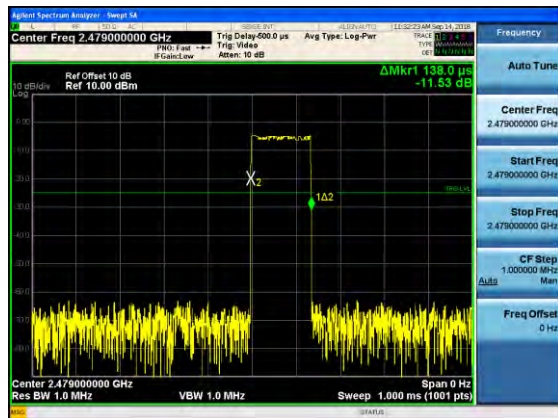
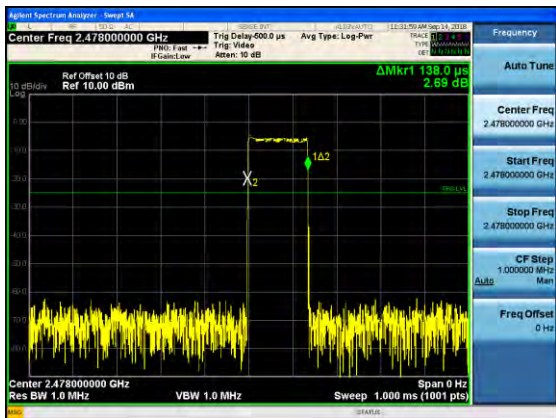

Highest channel

Highest channel

8. RADIATED EMISSIONS

8.1.Limit

All the emissions appearing within 15.205 restricted frequency bands shall not exceed the limits shown in 15.209, all the other emissions shall be at least 20dB below the fundamental emissions, or comply with 15.209 limits.

15.205 Restricted frequency band

MHz	MHz	MHz	GHz
0.090 - 0.110	16.42 - 16.423	399.9 - 410	4.5 - 5.15
¹ 0.495 - 0.505	16.69475 - 16.69525	608 - 614	5.35 - 5.46
2.1735 - 2.1905	16.80425 - 16.80475	960 - 1240	7.25 - 7.75
4.125 - 4.128	25.5 - 25.67	1300 - 1427	8.025 - 8.5
4.17725 - 4.17775	37.5 - 38.25	1435 - 1626.5	9.0 - 9.2
4.20725 - 4.20775	73 - 74.6	1645.5 - 1646.5	9.3 - 9.5
6.215 - 6.218	74.8 - 75.2	1660 - 1710	10.6 - 12.7
6.26775 - 6.26825	108 - 121.94	1718.8 - 1722.2	13.25 - 13.4
6.31175 - 6.31225	123 - 138	2200 - 2300	14.47 - 14.5
8.291 - 8.294	149.9 - 150.05	2310 - 2390	15.35 - 16.2
8.362 - 8.366	156.52475 - 156.52525	2483.5 - 2500	17.7 - 21.4
8.37625 - 8.38675	156.7 - 156.9	2690 - 2900	22.01 - 23.12
8.41425 - 8.41475	162.0125 - 167.17	3260 - 3267	23.6 - 24.0
12.29 - 12.293	167.72 - 173.2	3332 - 3339	31.2 - 31.8
12.51975 - 12.52025	240 - 285	3345.8 - 3358	36.43 - 36.5
12.57675 - 12.57725	322 - 335.4	3600 - 4400	(²)

15.209 Limit

FREQUENCY MHz	DISTANCE Meters	FIELD STRENGTHS LIMIT	
		$\mu\text{V}/\text{m}$	$\text{dB}(\mu\text{V})/\text{m}$
0.009-0.490	300	2400/F(KHz)	/
0.490-1.705	30	24000/F(KHz)	/
1.705-30	30	30	29.5
30 ~ 88	3	100	40.0
88 ~ 216	3	150	43.5
216 ~ 960	3	200	46.0
960 ~ 1000	3	500	54.0
Above 1000	3	74.0 dB(μV)/m (Peak) 54.0 dB(μV)/m (Average)	

8.2. Block Diagram of Test setup

8.2.1 In 3m Anechoic Chamber Test Setup Diagram for below 30MHz

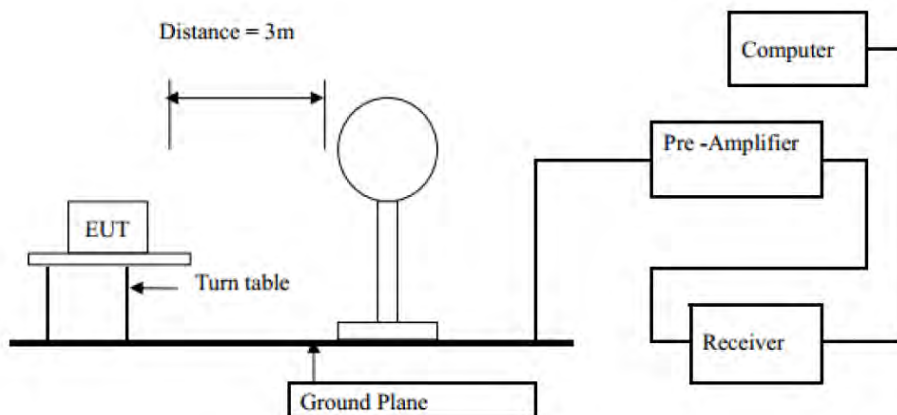

8.2.1 In 3m Anechoic Chamber Test Setup Diagram for below 1GHz

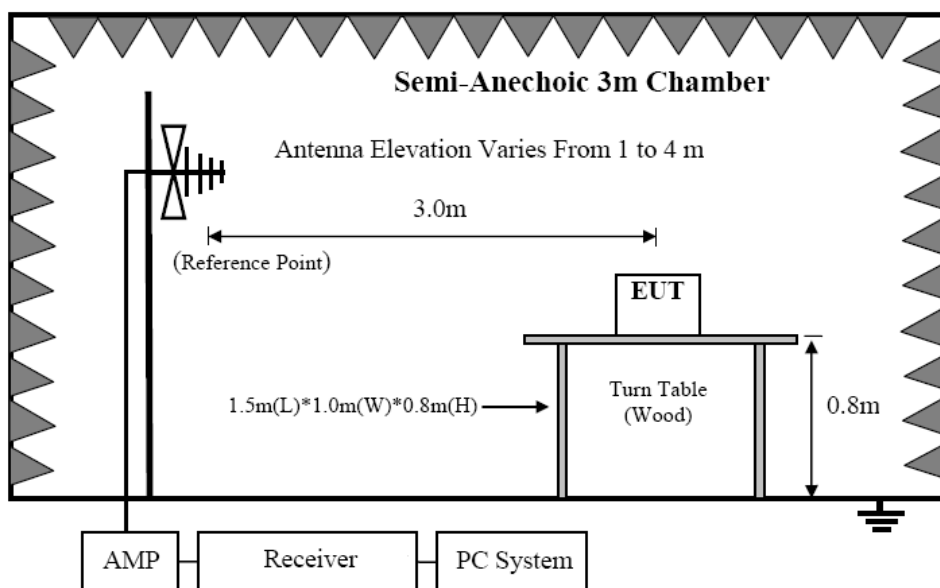

8.2.2 In 3m Anechoic Chamber Test Setup Diagram for frequency above 1GHz

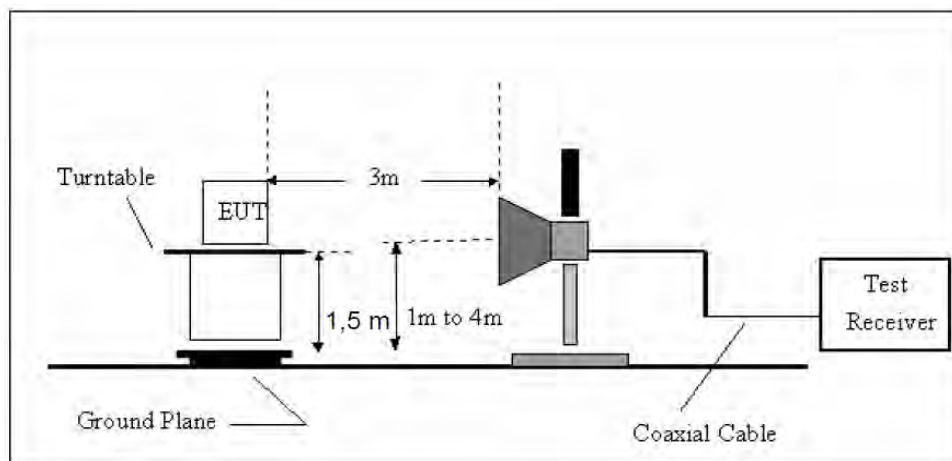

Note: For harmonic emissions test a appropriate high pass filter was inserted in the input port of AMP.

8.3. Test Procedure

- (1) The EUT was placed on a non-metallic table, 80 cm above the ground plane inside a semi-anechoic chamber for below 1GHz and 150 cm above the ground plane inside a semi-anechoic chamber for above 1GHz.
- (2) Setup EUT and simulator as shown in section 1.4 and 6.1
- (3) Test antenna was located 3m from the EUT on an adjustable mast. Below pre-scan procedure was first performed in order to find prominent radiated emissions.
 - (a) Change work frequency or channel of device if practicable.
 - (b) Change modulation type of device if practicable.
 - (c) Rotated EUT through three orthogonal axes to determine the attitude of EUT arrangement produces highest emissions
- (4) Spectrum frequency from 9KHz to 25GHz (tenth harmonic of fundamental frequency) was investigated
- (5) For final emissions measurements at each frequency of interest, the EUT were rotated and the antenna height was varied between 1m and 4m in order to maximize the emission. Measurements in both horizontal and vertical polarities were made and the data was recorded. In order to find the maximum emission, the relative positions of equipments and all of the interface cables were changed according to ANSI C63.10 :2013on Radiated Emission test.
- (6) For emissions above 1GHz, both Peak and Average level were measured with Spectrum Analyzer, and the RBW is set at 1MHz, VBW is set at 3MHz for Peak measure; RBW is set at 1MHz, VBW is set at 10Hz for Average measure.

8.4. Test Result

We have scanned the 10th harmonic from 9KHz to the EUT's highest frequency..
Detailed information please see the following page.

From 9KHz to 30MHz: Conclusion: PASS

Note: The amplitude of spurious emissions which are attenuated by more than 20dB below the permissible value has no need to be reported.

From 30MHz to 1000MHz: Conclusion: PASS

Vertical:

Radiated Emission Measurement

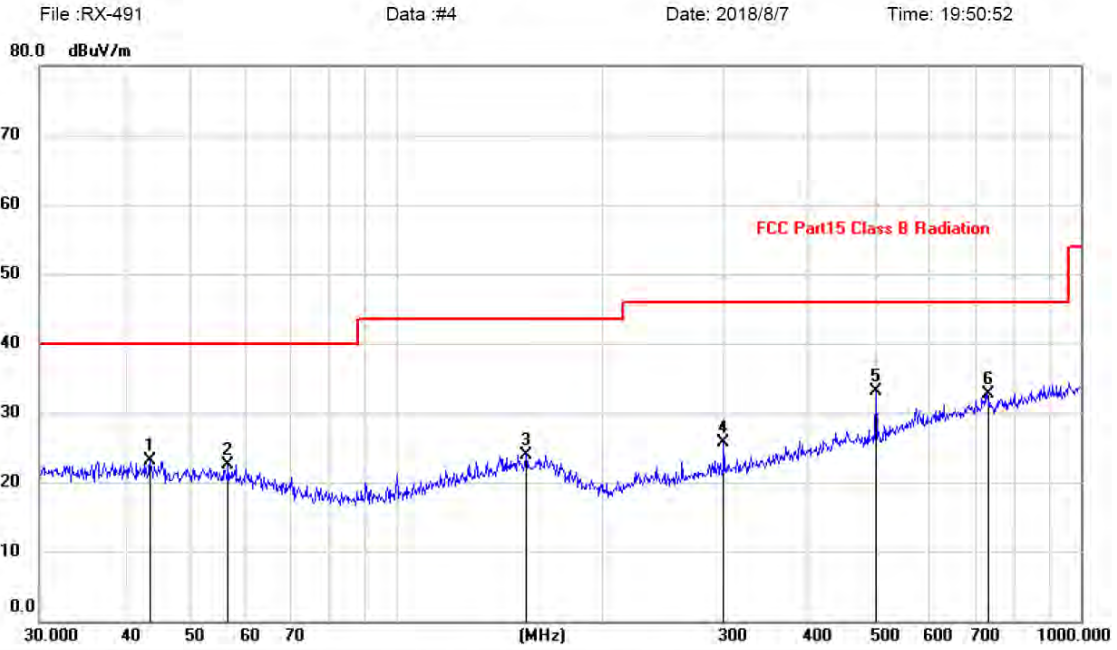

No.	Mk.	Freq.	Reading Level	Correct Factor	Measurement	Limit	Margin	Antenna Height	Table Degree
		MHz	dBuV	dB	dBuV/m	dBuV/m	dB	cm	degree
1		43.5057	9.28	13.90	23.18	40.00	-16.82	peak	
2		56.5929	9.36	13.13	22.49	40.00	-17.51	peak	
3		154.2786	9.44	14.56	24.00	43.50	-19.50	peak	
4		301.4224	12.25	13.51	25.76	46.00	-20.24	peak	
5	*	501.1790	15.89	17.22	33.11	46.00	-12.89	peak	
6		731.9203	11.24	21.38	32.62	46.00	-13.38	peak	

Note:1. *:Maximum data; x:Over limit; !:over margin.

2.Measurement=Reading Level+Correct Factor; Correct Factor=Antenna Factor+Cable Loss.

Horizontal:

Radiated Emission Measurement

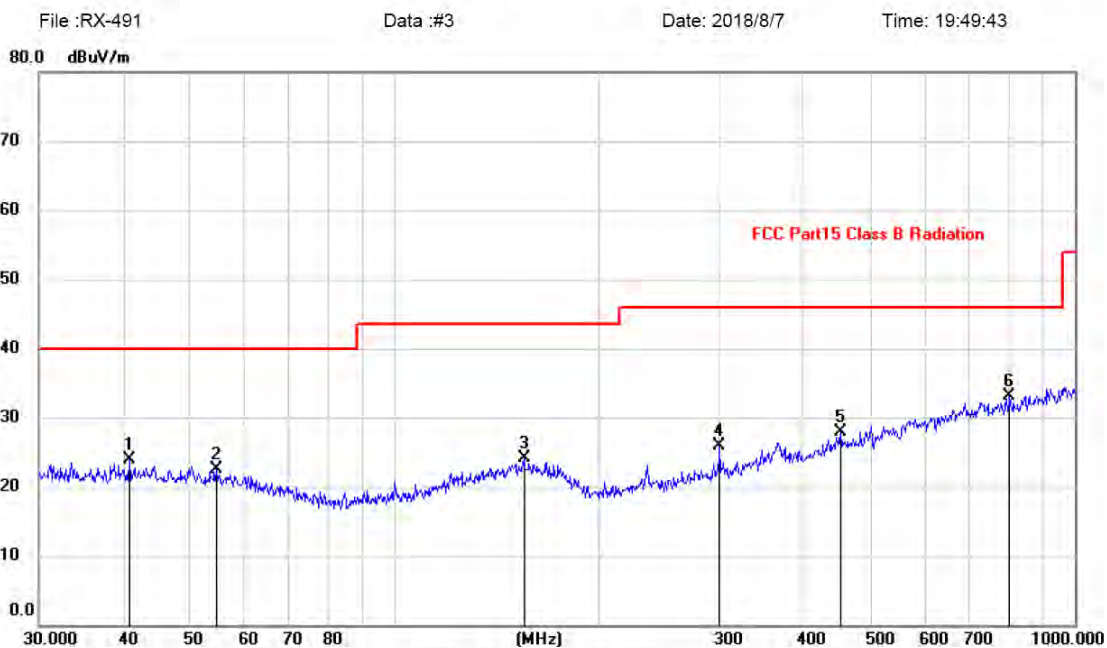

No.	Mk.	Freq.	Reading	Correct	Measure-	Limit	Margin	Antenna	Table	
		MHz	Level	Factor	ment			Height	Degree	Comment
			dBuV	dB	dBuV/m	dBuV/m	dB	cm	degree	
1		40.7016	9.85	14.15	24.00	40.00	-16.00			peak
2		54.6429	9.11	13.31	22.42	40.00	-17.58			peak
3		154.8204	9.64	14.56	24.20	43.50	-19.30			peak
4		301.4224	12.34	13.51	25.85	46.00	-20.15			peak
5		452.7197	10.96	17.03	27.99	46.00	-18.01			peak
6	*	801.7863	10.97	22.23	33.20	46.00	-12.80			peak

Note: 1. *:Maximum data; x:Over limit; !:over margin.

2.Measurement=Reading Level+Correct Factor; Correct Factor=Antenna Factor+Cable Loss.

Remark: All modes have been tested, and only worst data of GFSK mode, Channel 2479MHz (2413-2479MHz, DC 6V) was listed in this report.

From 1G-25GHz

Test Mode: GFSK TX Low									
Freq (MHz)	Read Level (dBuV/m)	Polar (H/V)	Antenna Factor (dB/m)	Cable loss(dB)	Amp Factor (dB)	Result (dBuV/m)	Limit (dBuV/m)	Margin (dB)	Remark
4808	44.23	V	33.95	10.18	34.26	54.10	74	19.90	PK
4808	33.41	V	33.95	10.18	34.26	43.28	54	10.72	AV
7212	/		/						
9616	/		/						
4808	44.40	H	33.95	10.18	34.26	54.27	74	19.73	PK
4808	33.14	H	33.95	10.18	34.26	43.01	54	10.99	AV
7212									
9616									
Test Mode: GFSK TX Mid									
4884	42.16	V	33.93	10.2	34.29	52.00	74	22.00	PK
4884	33.39	V	33.93	10.2	34.29	43.23	54	10.77	AV
7326	/								
9768	/								
4884	43.56	H	33.93	10.2	34.29	53.40	74	20.60	PK
4884	33.53	H	33.93	10.2	34.29	43.37	54	10.63	AV
7326									
9768									
Test Mode: GFSK TX High									
4958	43.01	V	33.98	10.22	34.25	52.96	74	21.04	PK
4958	33.15	V	33.98	10.22	34.25	43.10	54	10.90	AV
7437	/								
9916	/								
4958	42.78	H	33.98	10.22	34.25	52.73	74	21.27	PK
4958	32.19	H	33.98	10.22	34.25	42.14	54	11.86	AV
7437	/								
9916	/								
Note:									
1, Result = Read level + Antenna factor + cable loss-Amp factor									
2, All the other emissions not reported were too low to read and deemed to comply with FCC limit.									

9. BAND EDGE COMPLIANCE

9.1. Block Diagram of Test Setup

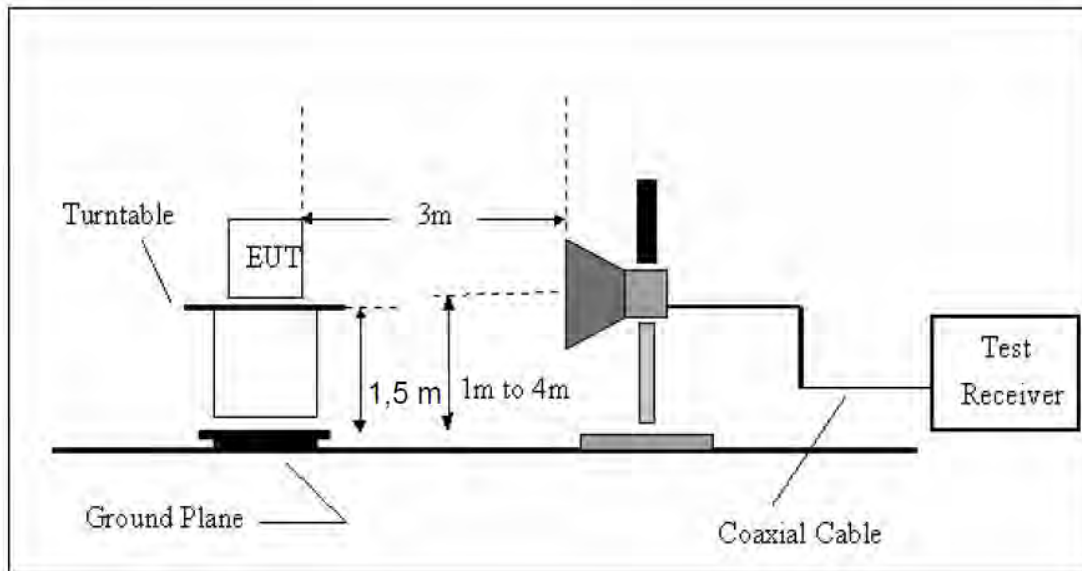

9.2. Limit

All the lower and upper band-edges emissions appearing within restricted frequency bands shall not exceed the limits shown in 15.209, all the other emissions outside operation shall be at least 20dB below the fundamental emissions, or comply with 15.209 limits.

9.3. Test Procedure

All restriction band and non- restriction band have been tested , only worse case is reported.

9.4. Test Result

PASS. (See below detailed test data)

Test Mode: GFSK-Low (2404MHz)

Polarization: Vertical

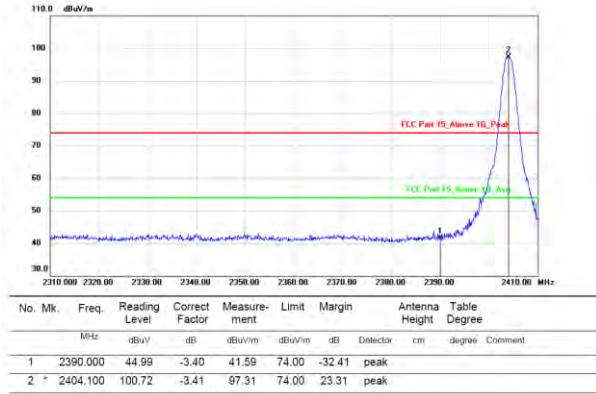

hopping-off

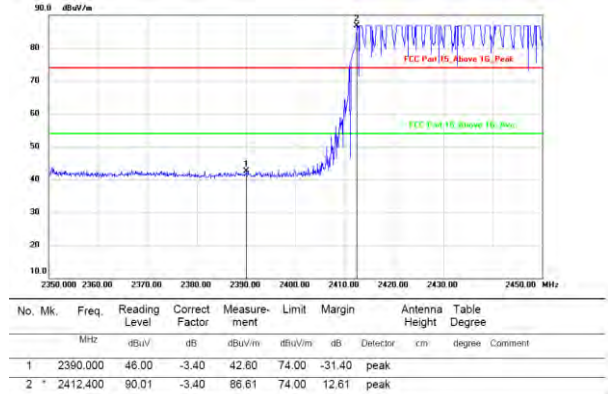

hopping-on

Polarization: Horizontal

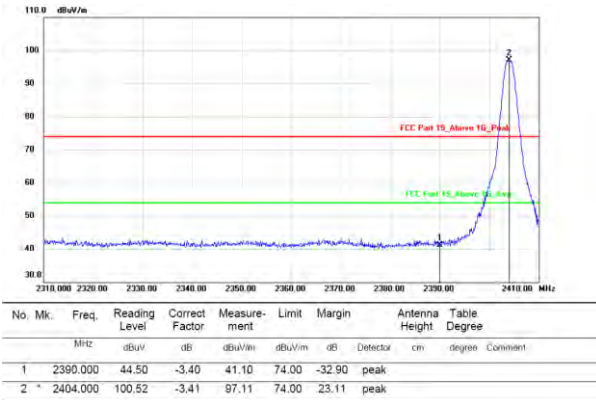

hopping-off

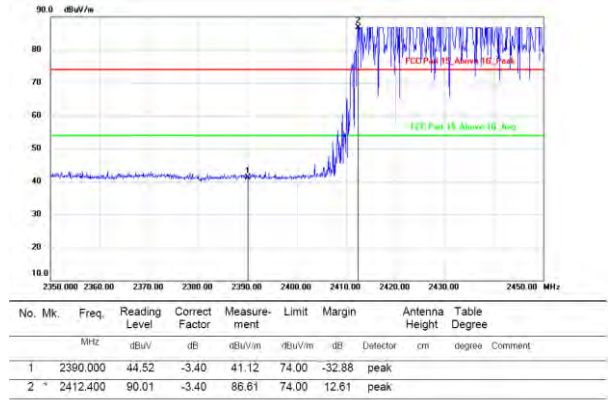

hopping-on

Test Mode: GFSK-High (2470MHz)

Polarization: Vertical

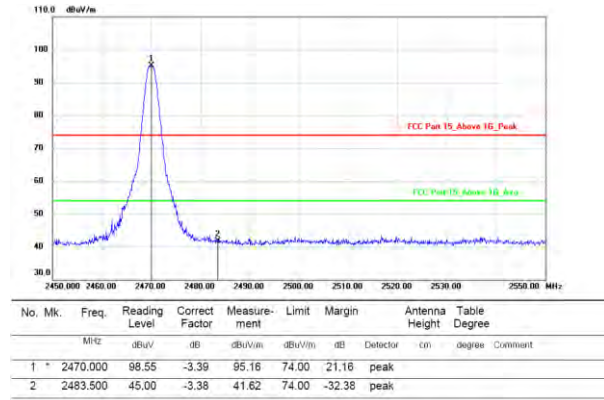

hopping-off

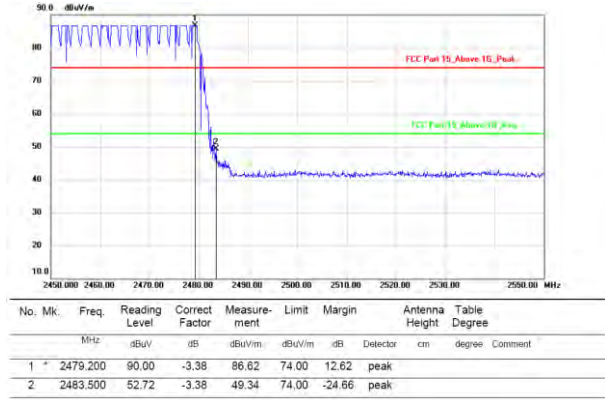

hopping-on

Polarization: Horizontal

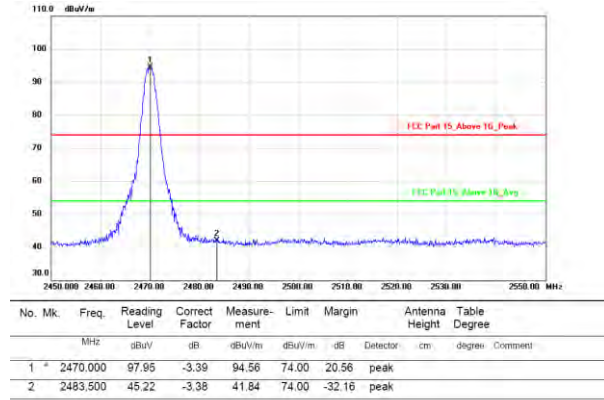

hopping-off

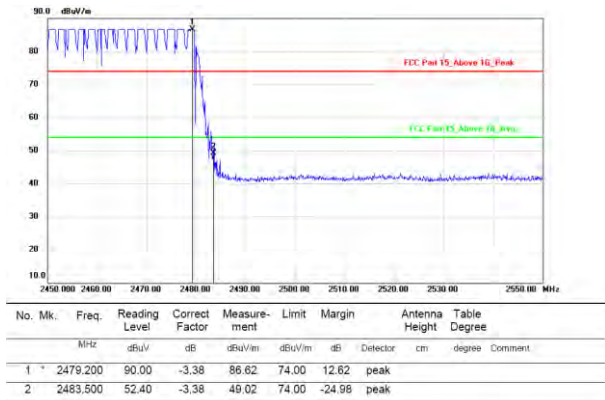

hopping-on

Test Mode: GFSK-Low (2405MHz)

Polarization: Vertical

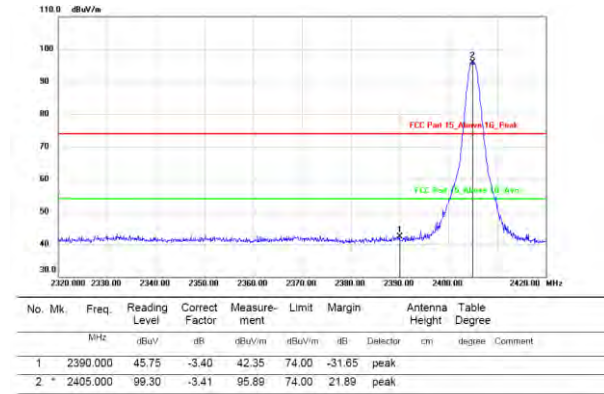

hopping-off

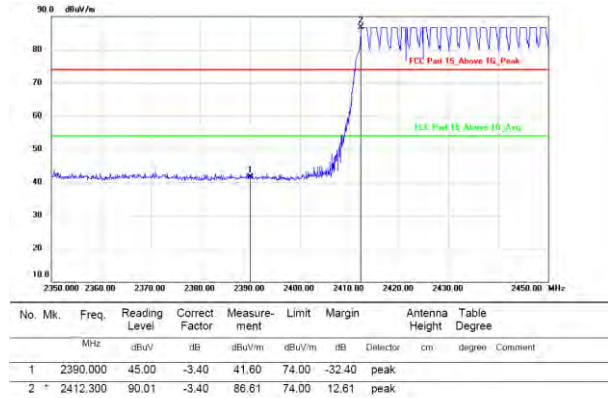

hopping-on

Polarization: Horizontal

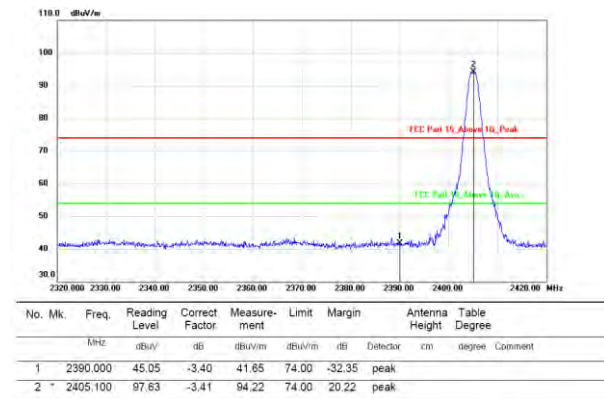

hopping-off

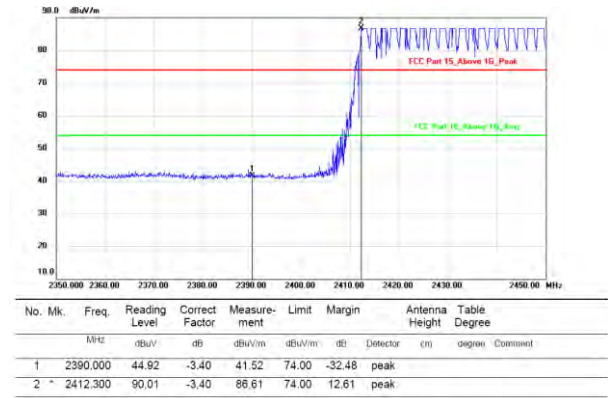

hopping-on

Test Mode: GFSK-High (2471MHz)

Polarization: Vertical

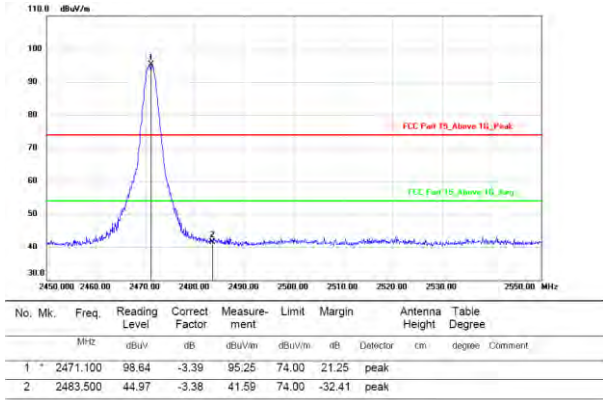

hopping-off

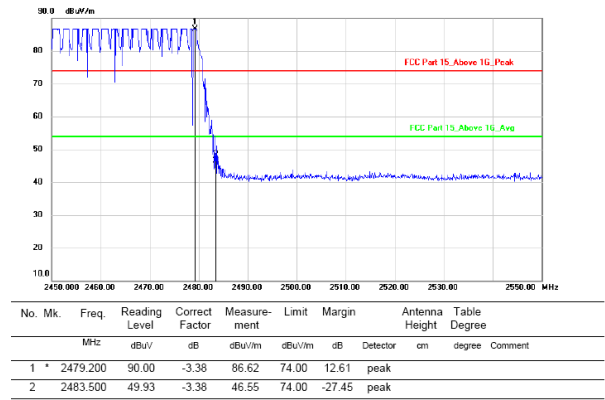

hopping-on

Polarization: Horizontal

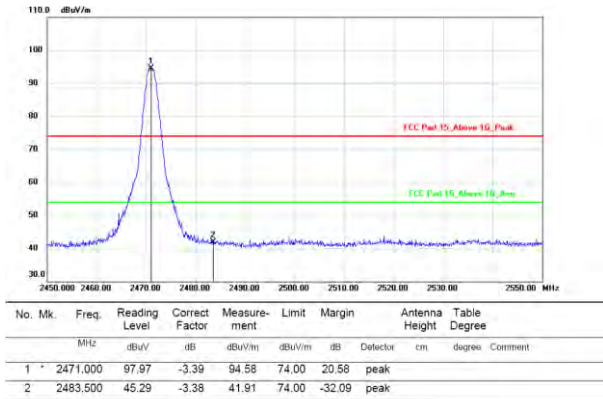

hopping-off

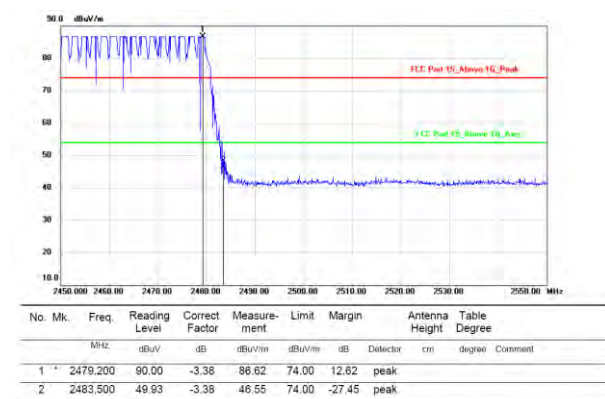

hopping-on

Test Mode: GFSK-Low (2412MHz)

Polarization: Vertical

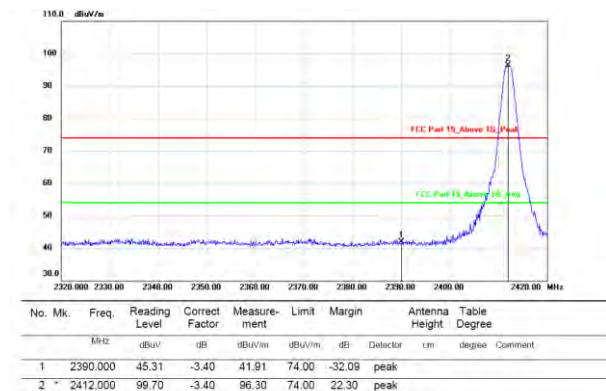

hopping-off

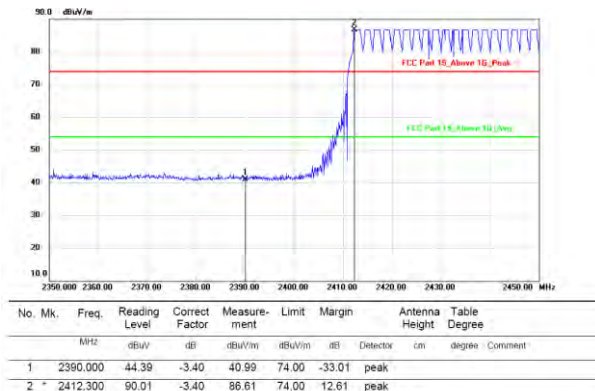

hopping-on

Polarization: Horizontal

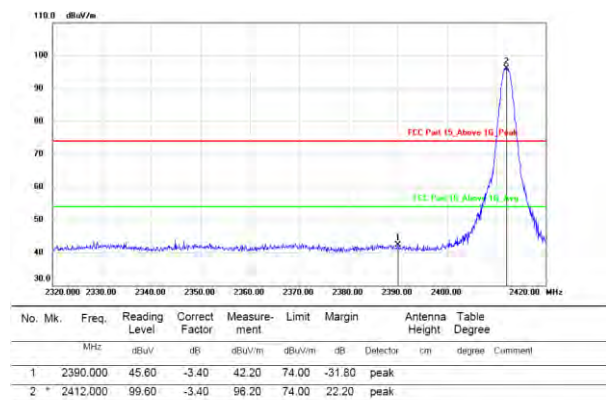

hopping-off

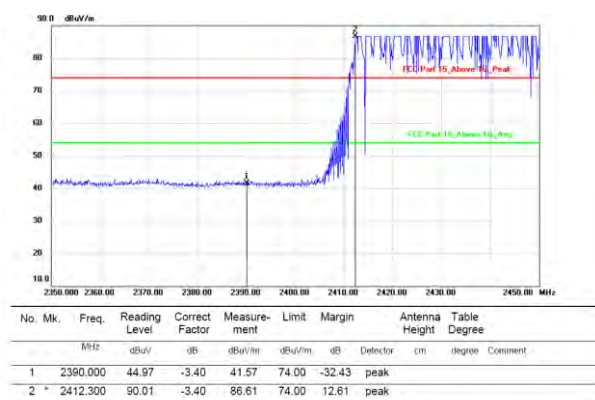

hopping-on

Test Mode: GFSK-High (2478MHz)

Polarization: Vertical

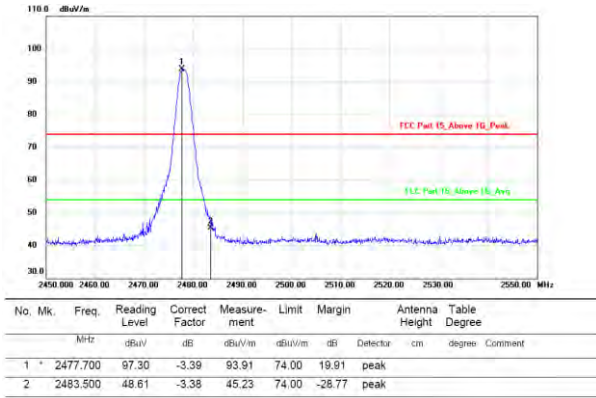

hopping-off

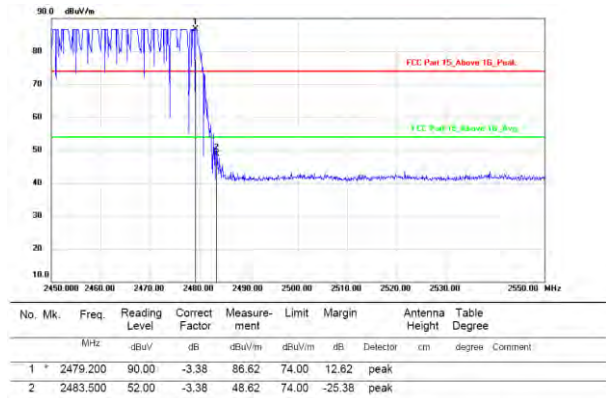

hopping-on

Polarization: Horizontal

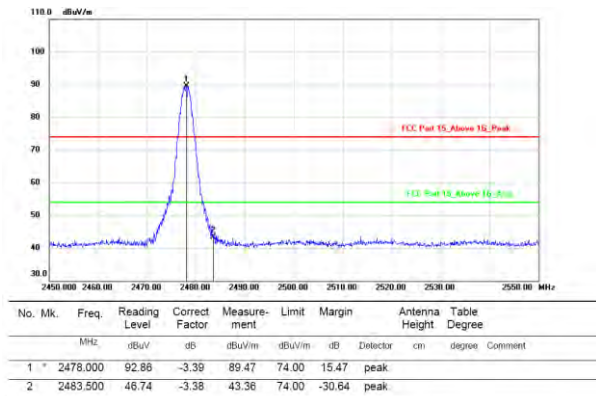

hopping-off

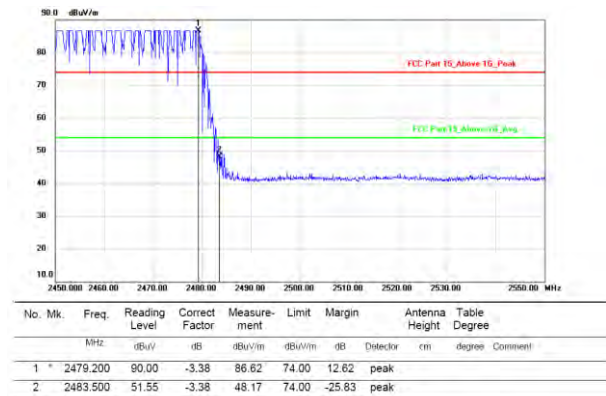

hopping-on

Test Mode: GFSK-Low (2413MHz)

Polarization: Vertical

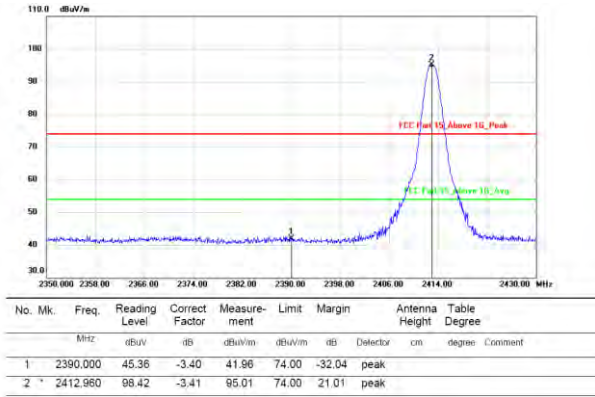

hopping-off

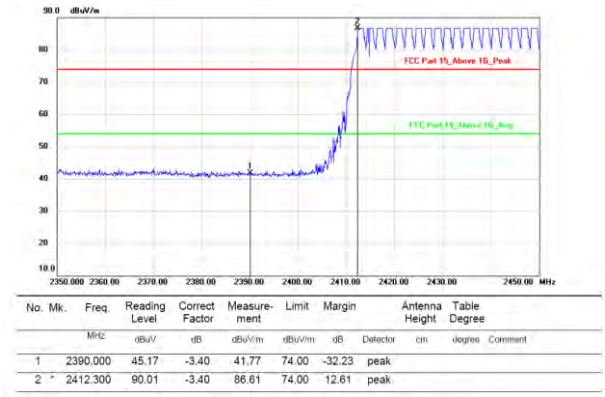

hopping-on

Polarization: Horizontal

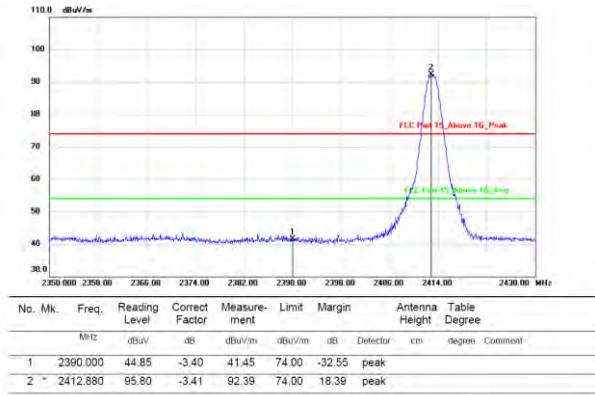

hopping-off

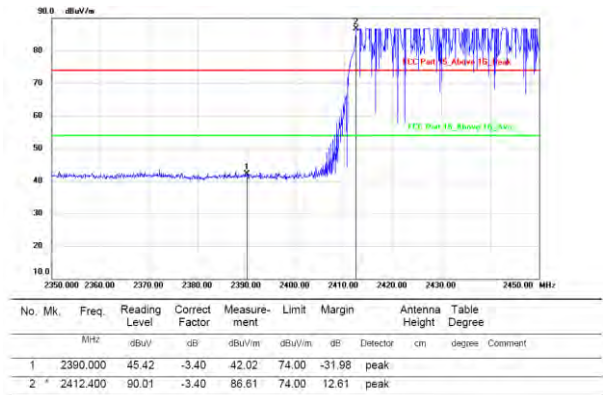

hopping-on

Test Mode: GFSK-High (2479MHz)

Polarization: Vertical

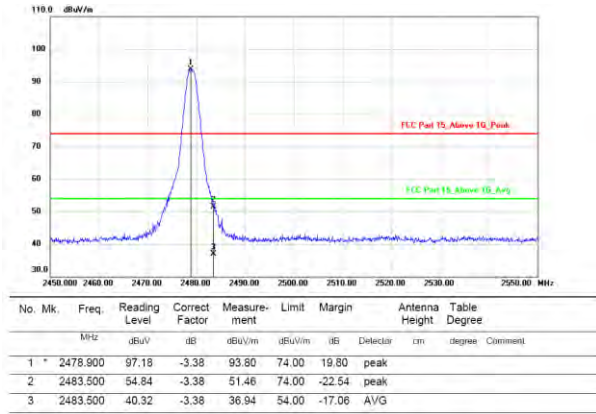

hopping-off

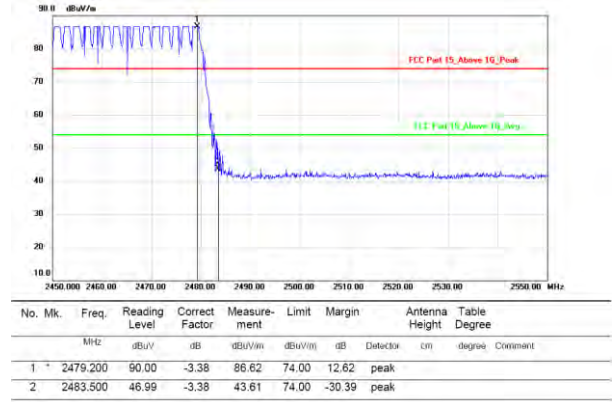

hopping-on

Polarization: Horizontal

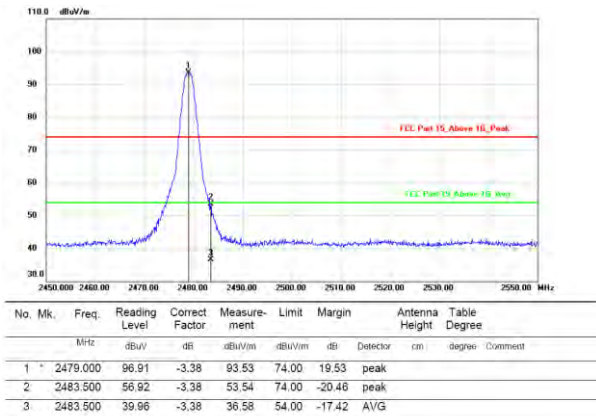

hopping-off

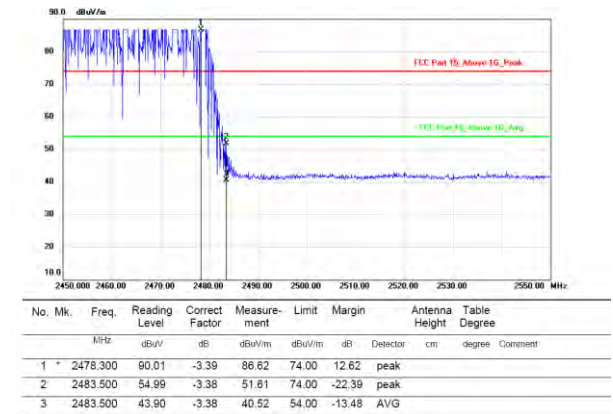

hopping-on

Note: 1. *:Maximum data; x:Over limit; !:over margin.

2.Measurement=Reading Level+Correct Factor; Correct Factor=Antenna Factor+Cable Loss.

Conducted Method

GFSK Mode:

2404-2470 MHz:

Test channel:

Lowest channel

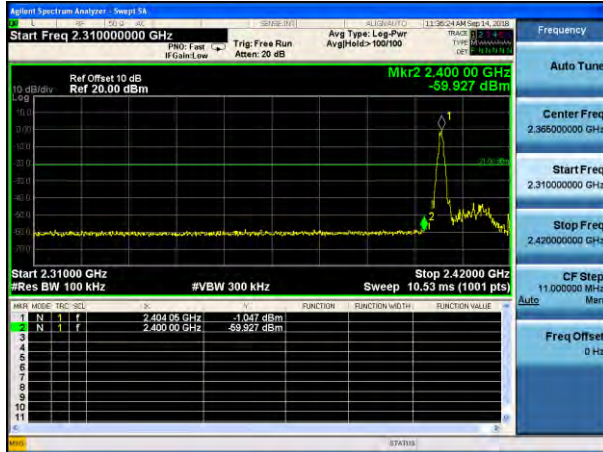

Hopping-off mode

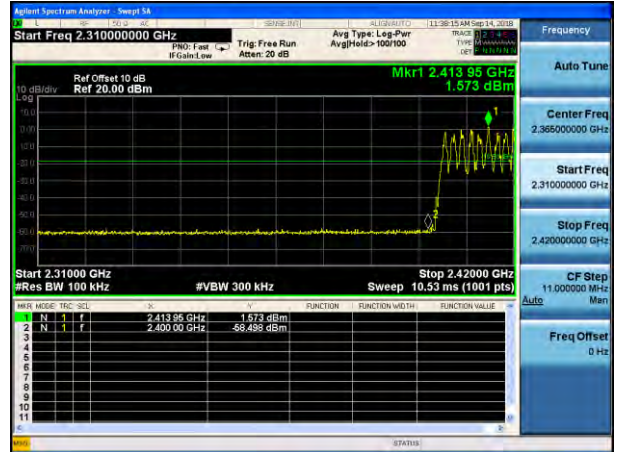

Hopping-on mode

Test channel:

Highest channel

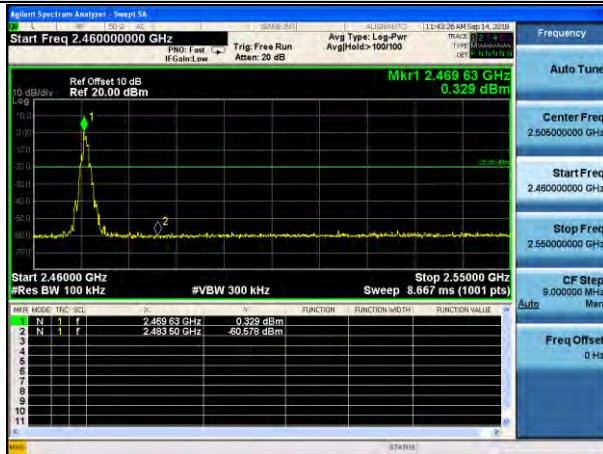

Hopping-off mode



Hopping-on mode

2405-2471 MHz:

Test channel:

Lowest channel

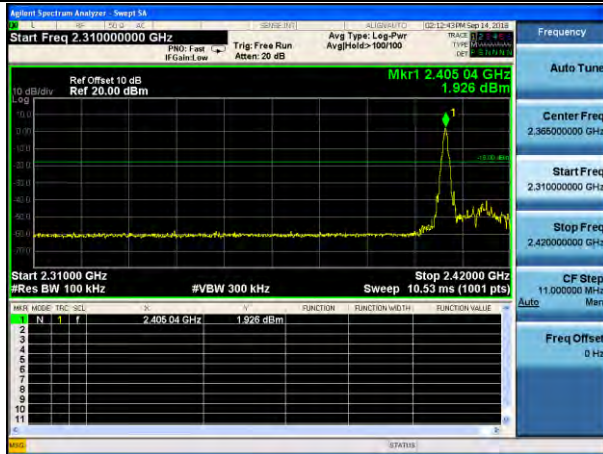

Hopping-off mode

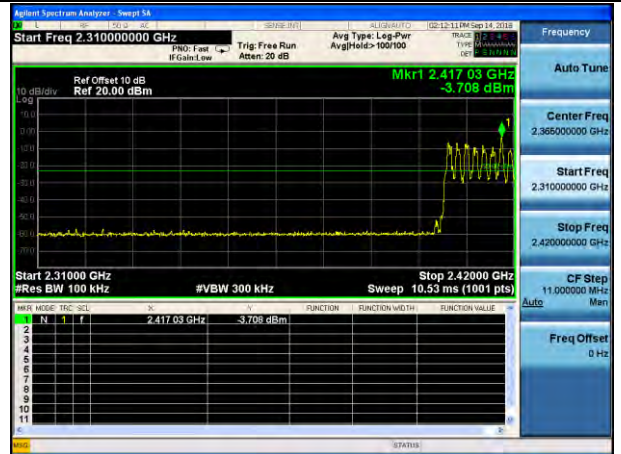

Hopping-on mode

Test channel:

Highest channel

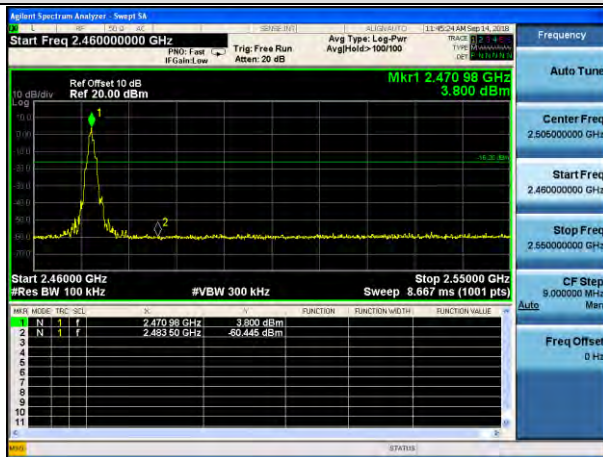

Hopping-off mode

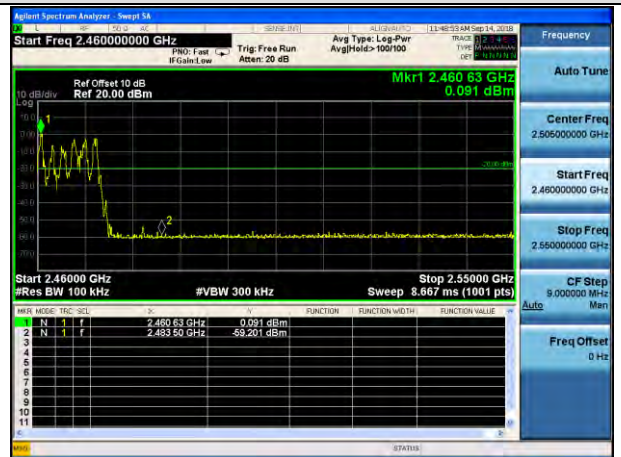

Hopping-on mode

2412-2478 MHz:

Test channel:

Lowest channel

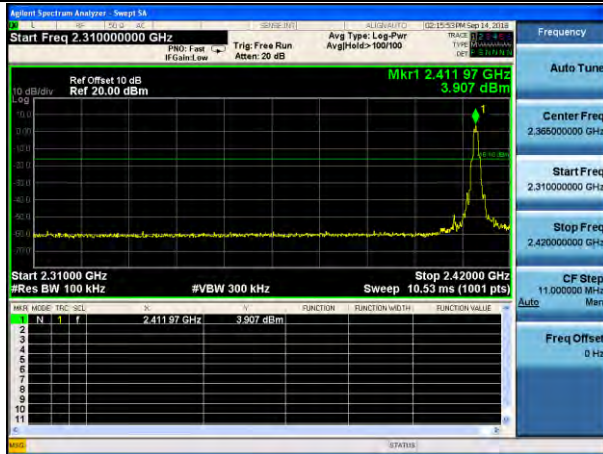

Hopping-off mode

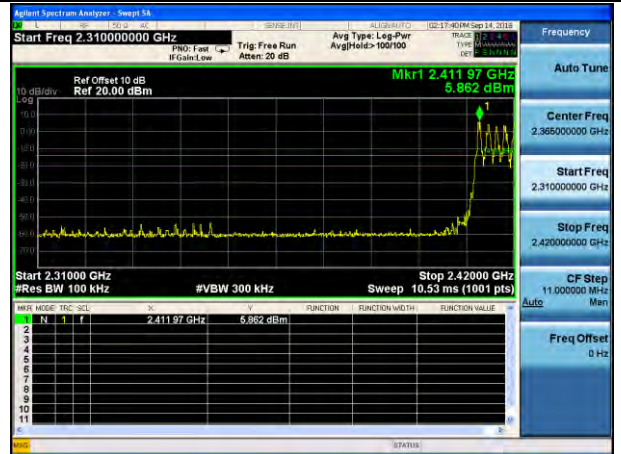

Hopping-on mode

Test channel:

Highest channel

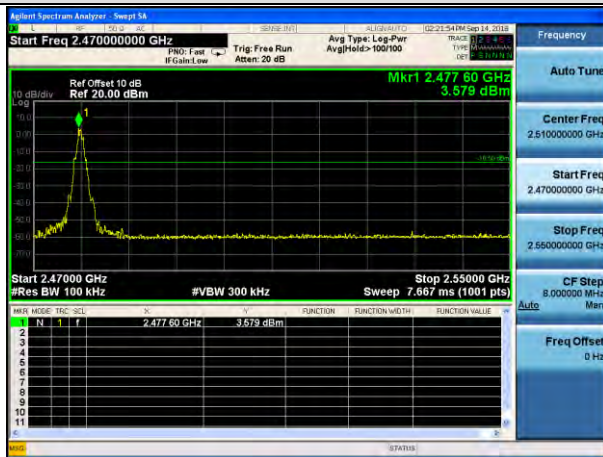

Hopping-off mode

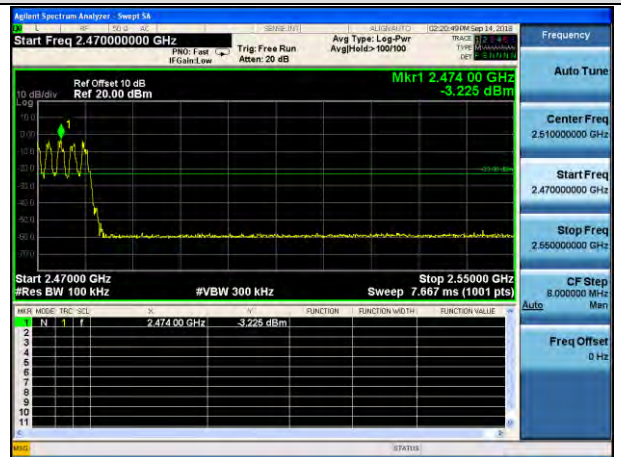

Hopping-on mode

2413-2479 MHz:

Test channel:

Lowest channel

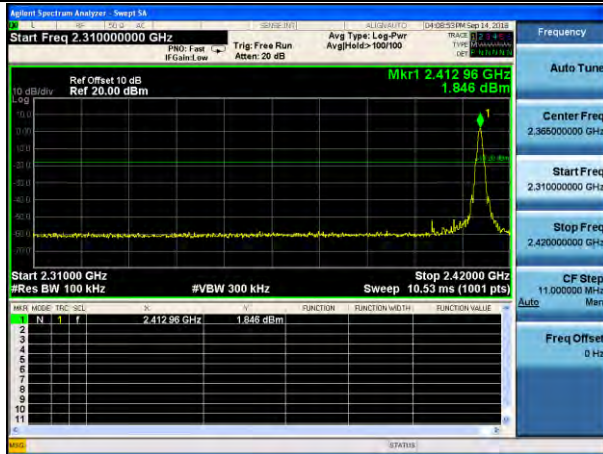

Hopping-off mode

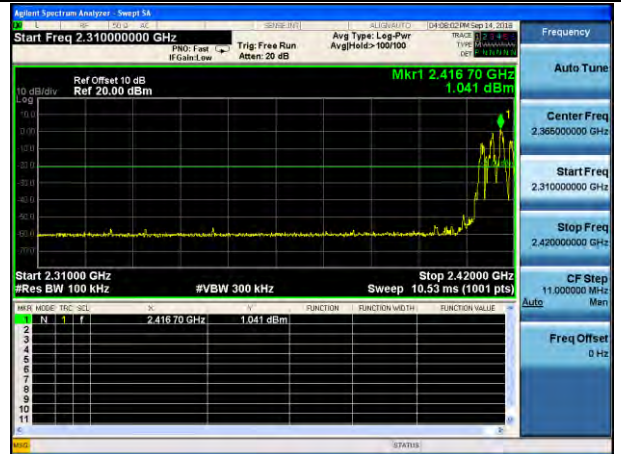

Hopping-on mode

Test channel:

Highest channel

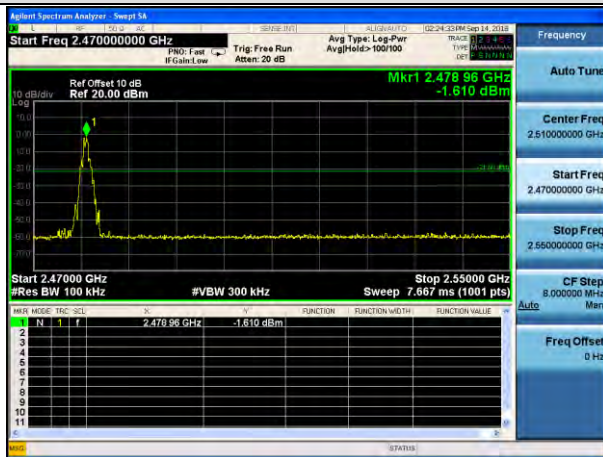

Hopping-off mode

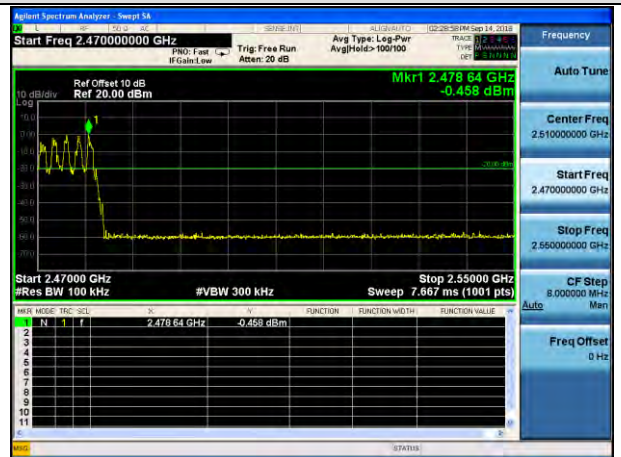

Hopping-on mode

10. POWER LINE CONDUCTED EMISSIONS

10.1. Block Diagram of Test Setup

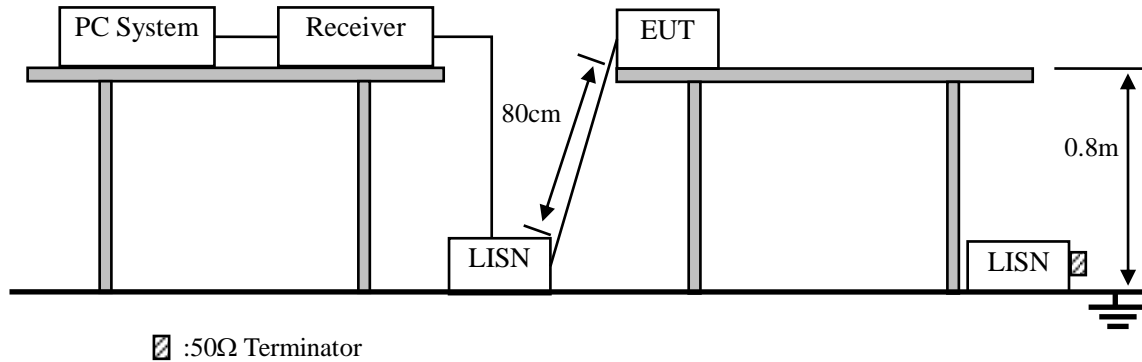

10.2. Limit

Frequency	Maximum RF Line Voltage	
	Quasi-Peak Level dB(μV)	Average Level dB(μV)
150kHz ~ 500kHz	66 ~ 56*	56 ~ 46*
500kHz ~ 5MHz	56	46
5MHz ~ 30MHz	60	50

Notes: 1. * Decreasing linearly with logarithm of frequency.

2. The lower limit shall apply at the transition frequencies.

10.3. Test Procedure

- (1) The EUT was placed on a non-metallic table, 80cm above the ground plane.
- (2) Setup the EUT and simulator as shown in 10.1
- (3) The EUT Power connected to the power mains through a power adapter and a line impedance stabilization network (L.I.S.N1). The other peripheral devices power cord connected to the power mains through a line impedance stabilization network (L.I.S.N2), this provided a 50-ohm coupling impedance for the EUT (Please refer to the block diagram of the test setup and photographs). Both sides of power line were checked for maximum conducted interference. In order to find the maximum emission, the relative positions of equipments and all of the interface cables were changed according to ANSI C63.10 :2013on conducted Emission test.
- (4) The bandwidth of test receiver is set at 10KHz.
- (5) The frequency range from 150 KHz to 30MHz is checked.

10.4. Test Result

PASS. (See below detailed test data)

Note: If peak Result comply with AV limit, QP and AV Result is deemed to comply with AV limit

Antenna Requirements

10.5.Limit

For intentional device, according to FCC 47 CFR Section 15.203, an intentional radiator shall be designed to ensure that no antenna other than that furnished by the responsible party shall be used with the device. And according to FCC 47 CFR Section 15.247 (b), if transmitting antennas of directional gain greater than 6dBi are used, the power shall be reduced by the amount in dB that the directional gain of the antenna exceeds 6dBi.

10.6.Result

Not applicable for equipment operated with battery power supply.

11. TEST SETUP PHOTO

11.1.Photos of Radiated emission

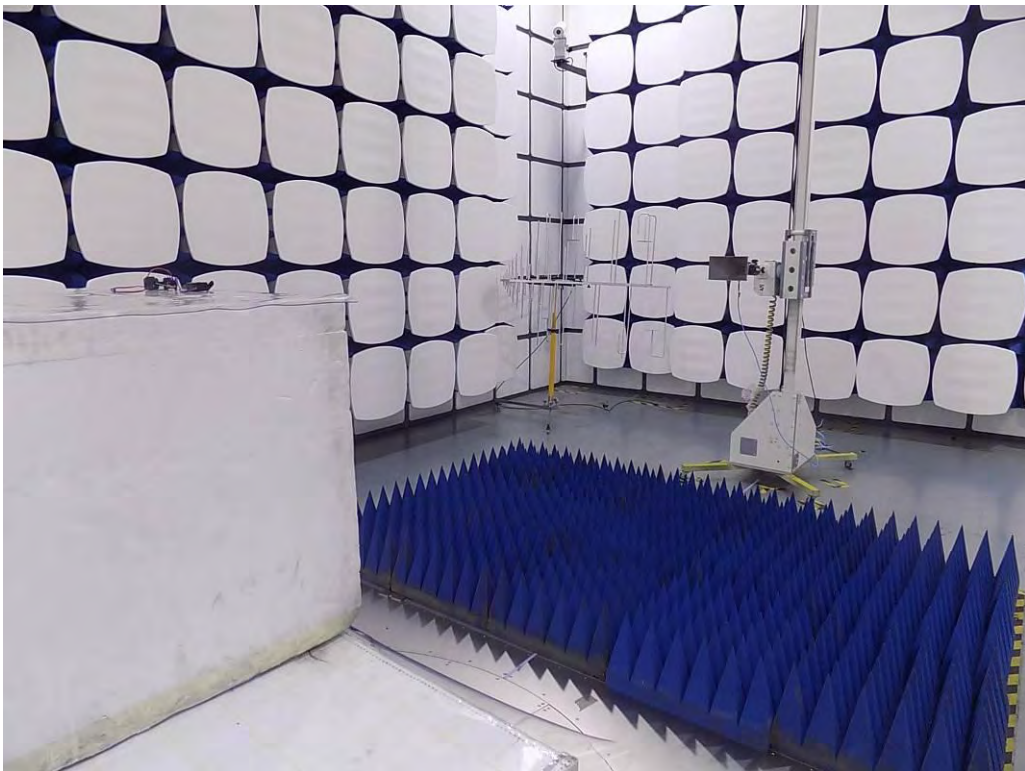
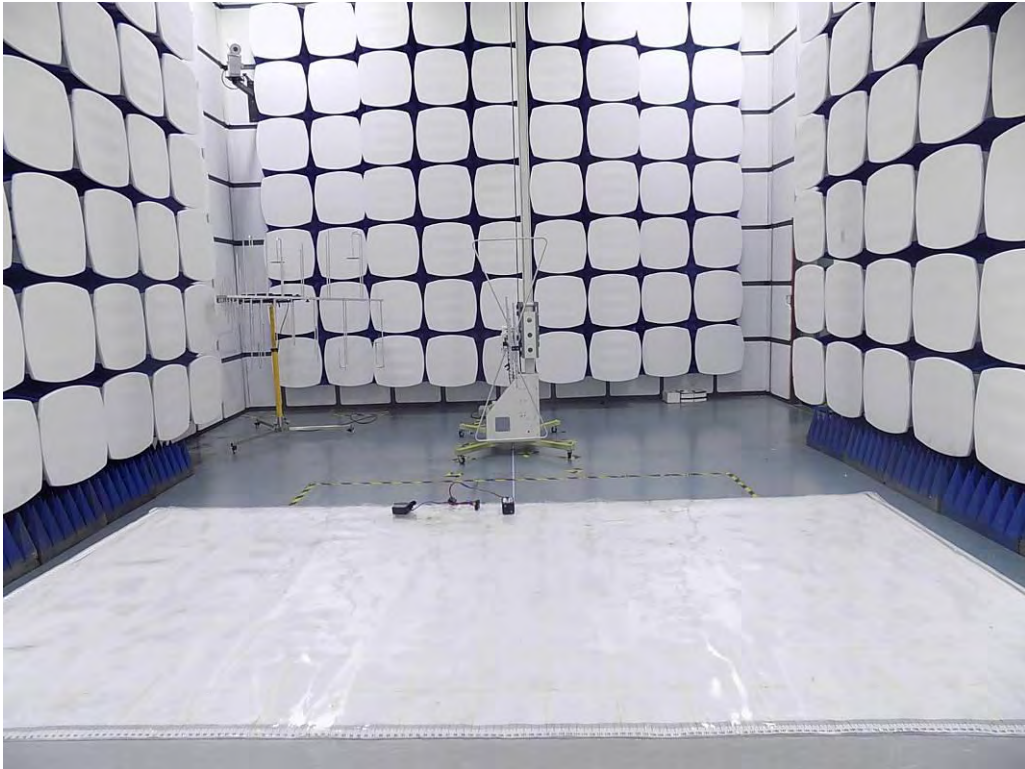

12. PHOTOS OF THE EUT

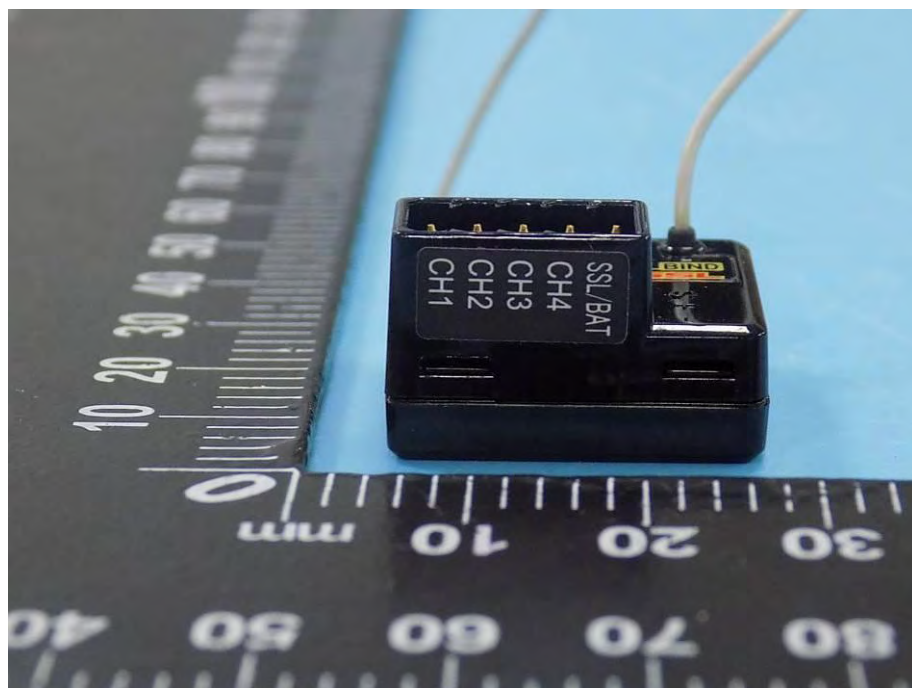
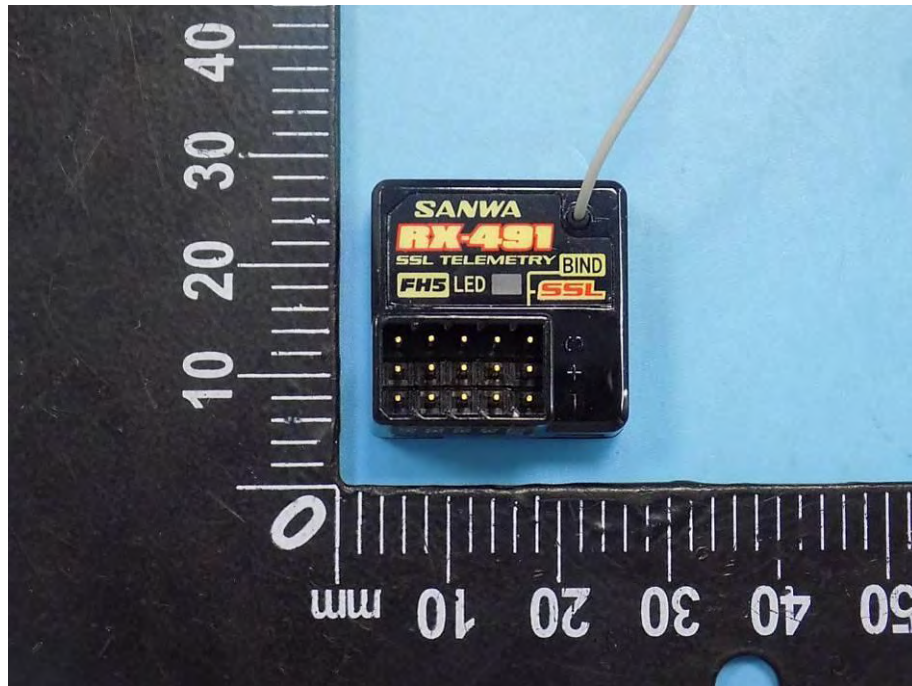

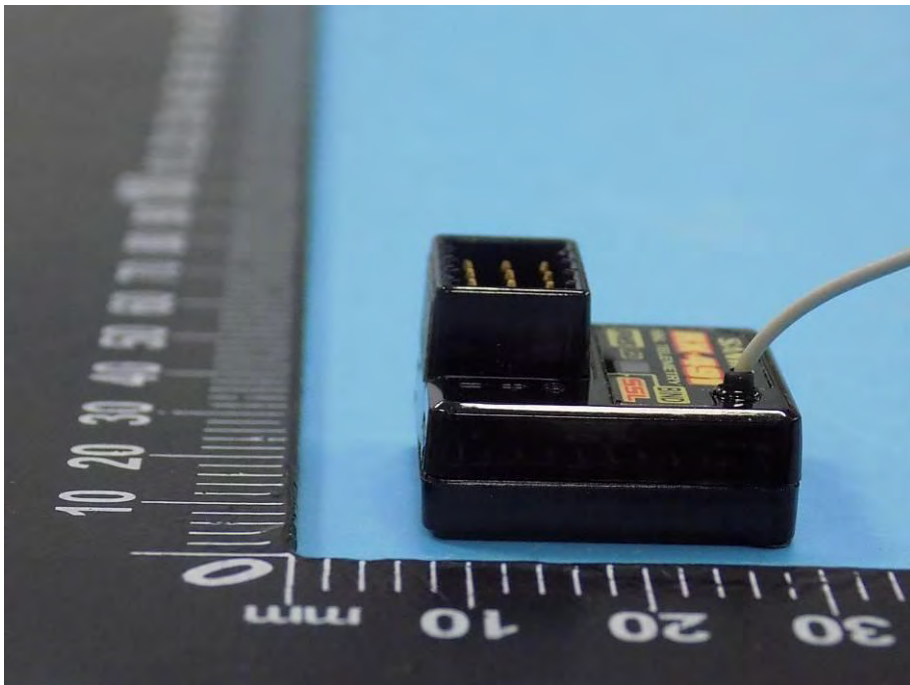
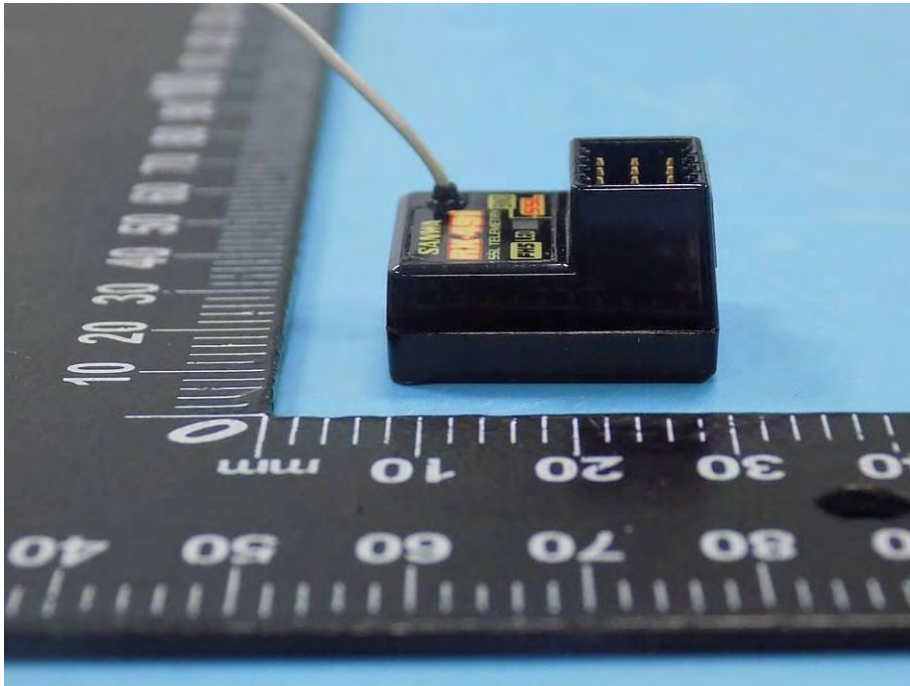

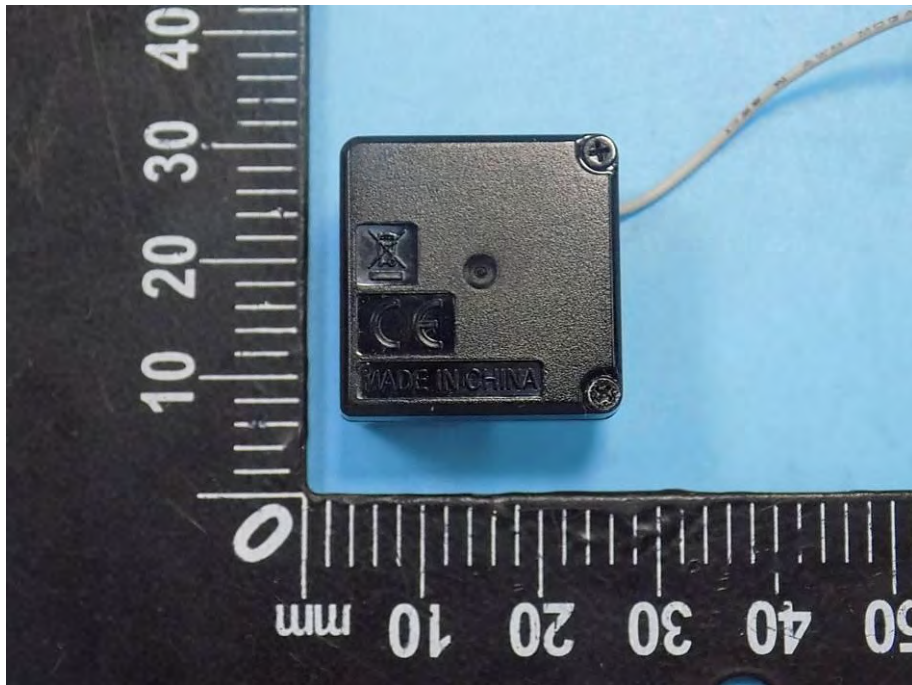
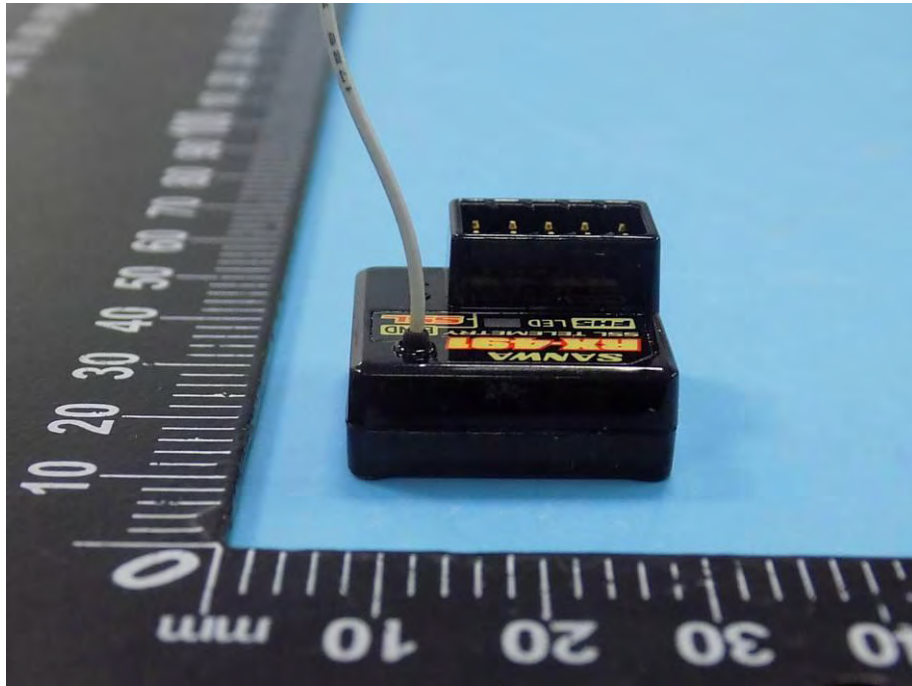

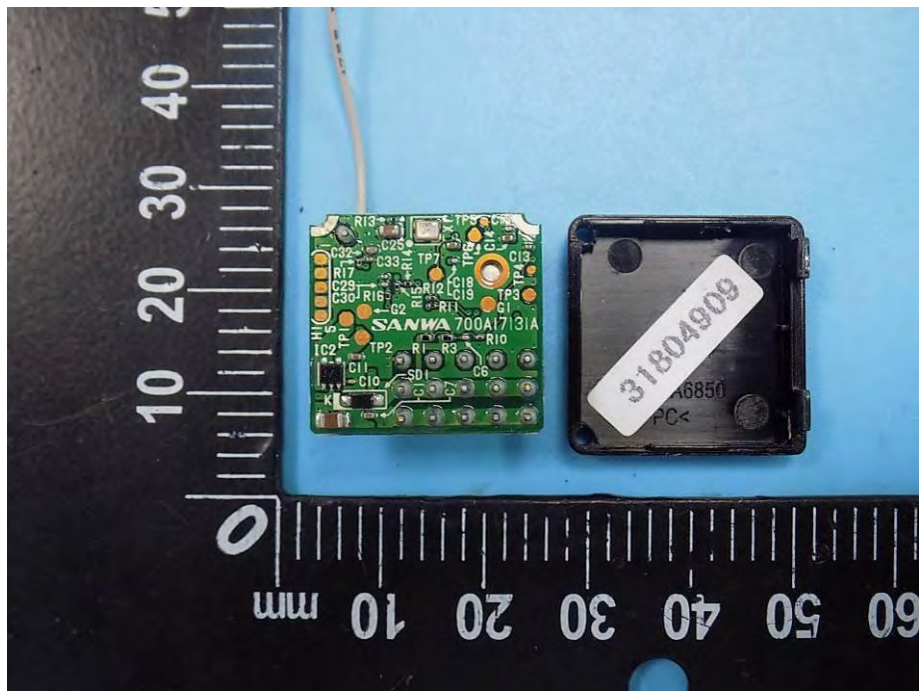
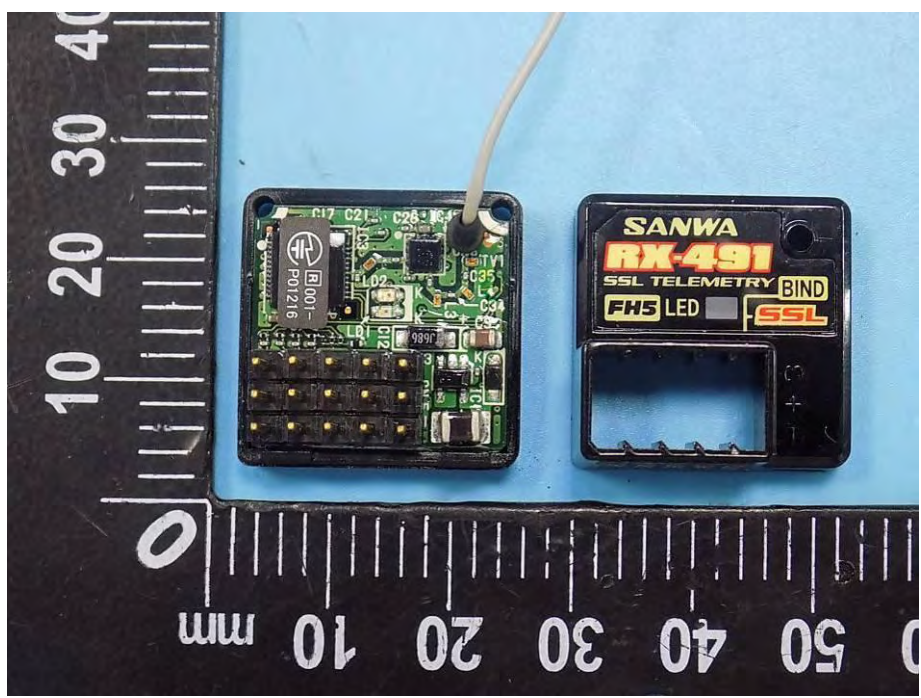

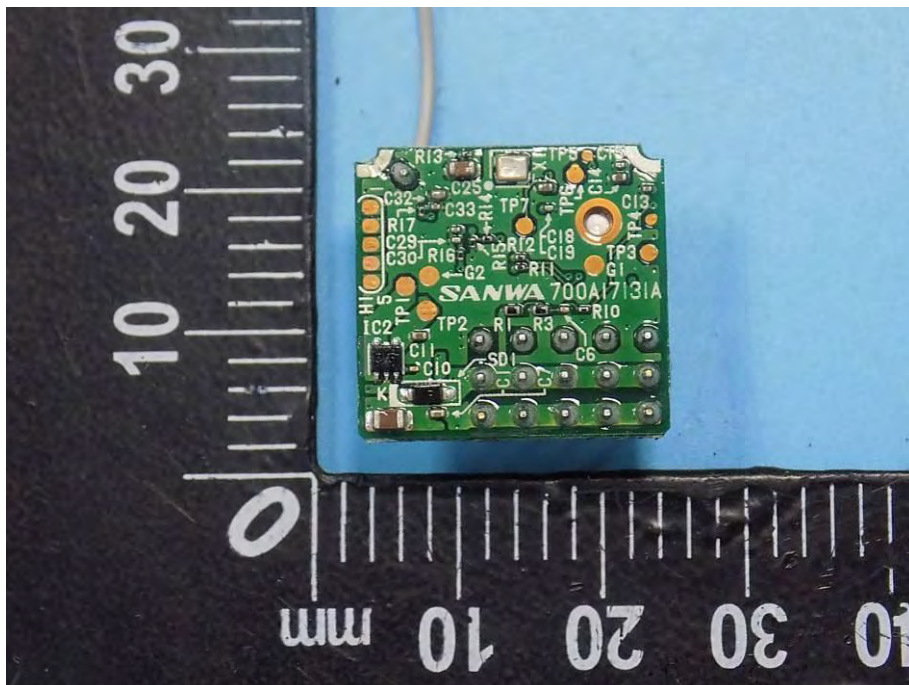
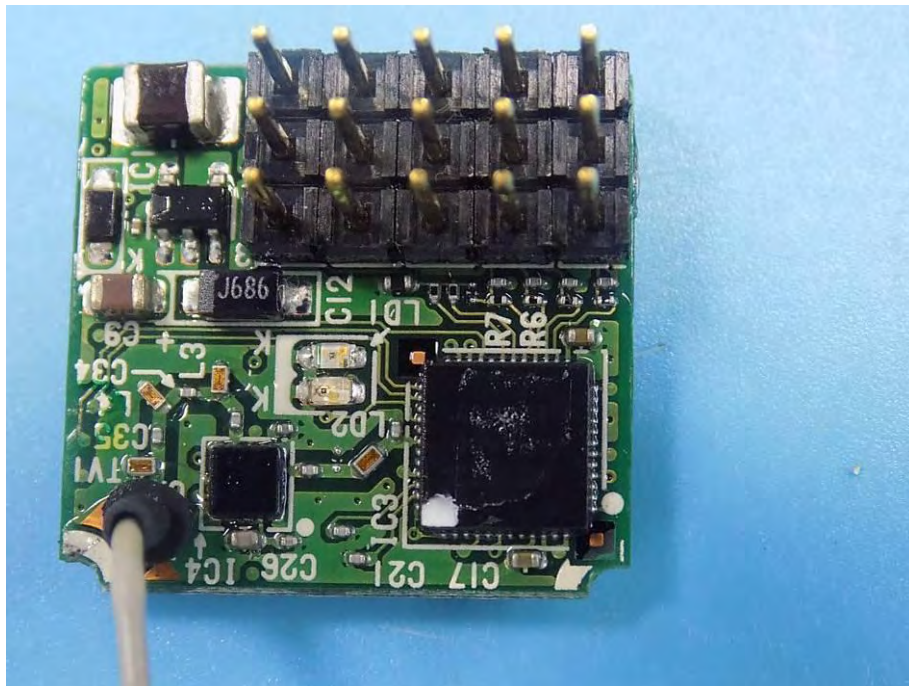

---END OF REPORT---