



# **FCC TEST REPORT**

**FCC ID: L73M17**

On Behalf of

**Sanwa Electronic Instrument Co., Ltd**

**2.4GHz Radio Control System**

**Model No.: M17**

Prepared for : Sanwa Electronic Instrument Co., Ltd  
Address : 1-2-50, Yoshida Honmachi, Higashi-Osaka, Osaka 578-0982, Japan

Prepared By : Shenzhen Alpha Product Testing Co., Ltd.  
Address : Building i, No.2, Lixin Road, Fuyong Street, Bao'an District, 518103,  
Shenzhen, Guangdong, China

Report Number : T1890004 05  
Date of Receipt : January 02, 2019  
Date of Test : January 02, 2019-January 18, 2019  
Date of Report : January 18, 2019  
Version Number : REV0

## TABLE OF CONTENTS

Description	Page
<b>1. Summary of Standards And Results.....</b>	<b>6</b>
1.1. Description of Standards and Results .....	6
<b>2. General Information.....</b>	<b>7</b>
2.1. Description of Device (EUT).....	7
2.2. Accessories of Device (EUT) .....	8
2.3. Tested Supporting System Details .....	8
2.4. Block Diagram of connection between EUT and simulators.....	8
2.5. Test Mode Description.....	8
2.6. Test Conditions .....	8
2.7. Test Facility.....	9
2.8. Measurement Uncertainty.....	9
2.9. Test Equipment List .....	10
<b>3. Maximum Peak Output power .....</b>	<b>11</b>
3.1. Limit.....	11
3.2. Test Procedure.....	11
3.3. Test Setup.....	11
3.4. Test Result.....	11
<b>4. Bandwidth.....</b>	<b>13</b>
4.1. Limit.....	13
4.2. Test Procedure.....	13
4.3. Test Result.....	13
<b>5. Carrier Frequency Separation .....</b>	<b>18</b>
5.1. Limit.....	18
5.2. Test Procedure.....	18
5.3. Test Result.....	18
<b>6. Number Of Hopping Channel .....</b>	<b>21</b>
6.1. Limit.....	21
6.2. Test Procedure.....	21
6.3. Test Result.....	21
<b>7. Dwell Time .....</b>	<b>23</b>
7.1. Test limit .....	23
7.2. Test Procedure.....	23
7.3. Test Result.....	23
<b>8. Radiated emissions .....</b>	<b>29</b>
8.1. Limit.....	29
8.2. Block Diagram of Test setup.....	30
8.3. Test Procedure.....	31
8.4. Test Result.....	31
<b>9. Band Edge Compliance .....</b>	<b>35</b>

---

9.1. Block Diagram of Test Setup.....	35
9.2. Limit.....	35
9.3. Test Procedure.....	35
9.4. Test Result.....	35
<b>10. Power Line Conducted Emissions.....</b>	<b>54</b>
10.1. Block Diagram of Test Setup.....	54
10.2. Limit.....	54
10.3. Test Procedure.....	54
10.4. Test Result.....	54
<b>11. Antenna Requirements.....</b>	<b>57</b>
11.1. Limit.....	57
11.2. Result.....	57
<b>12. Test setup photo .....</b>	<b>58</b>
12.1. Photos of Radiated emission.....	58
12.2. Photos of Conducted Emission test .....	59
<b>13. Photos of The EUT.....</b>	<b>60</b>

### TEST REPORT DECLARATION

Applicant : Sanwa Electronic Instrument Co., Ltd  
 Address : 1-2-50, Yoshida Honmachi, Higashi-Osaka, Osaka 578-0982, Japan  
 Manufacturer : Dongguan Fountain Electronics  
 Address : Qiaolian Industrial District, Erhuan St., Dongkeng Town, Dongguan City, Guangdong, P.R.China  
 EUT Description : 2.4GHz Radio Control System  
 (A) Model No. : M17  
 (B) Trademark : SANWA

Measurement Standard Used:

**FCC Rules and Regulations Part 15 Subpart C Section 15.247: 2017, ANSI C63.10:2013**

The device described above is tested by Shenzhen Alpha Product Testing Co., Ltd. to determine the maximum emission levels emanating from the device. The maximum emission levels are compared to the FCC Part 15 Subpart C limits both conducted and radiated emissions. The test results are contained in this test report and Shenzhen Alpha Product Testing Co., Ltd. is assumed of full responsibility for the accuracy and completeness of these tests.

After the test, our opinion is that EUT compliance with the requirement of the above standards.

This report applies to above tested sample only. This report shall not be reproduced in parts without written approval of Shenzhen Alpha Product Testing Co., Ltd.

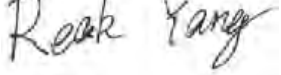
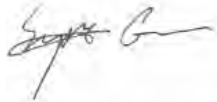
Tested by (name + signature).....:	Reak Yang Project Engineer	 .....
Approved by (name + signature).....:	Simple Guan Project Manager	 .....
Date of issue.....	January 18, 2019	

**Revision History**

Revision	Issue Date	Revisions	Revised By
00	January 18, 2019	Initial released Issue	Simple Guan

## 1. SUMMARY OF STANDARDS AND RESULTS

### 1.1. Description of Standards and Results

The EUT have been tested according to the applicable standards as referenced below:

<b>Test Item</b>	<b>Standards Paragraph</b>	<b>Result</b>
Maximum Peak Output Power	FCC Part 15: 15.247(b)(1) ANSI C63.10 :2013	P
Bandwidth	FCC Part 15: 15.215 ANSI C63.10 :2013	P
Carrier Frequency Separation	FCC Part 15: 15.247(a)(1) ANSI C63.10 :2013	P
Number Of Hopping Channel	FCC Part 15: 15.247(a)(1)(iii) ANSI C63.10 :2013	P
Dwell Time	FCC Part 15: 15.247(a)(1)(iii) ANSI C63.10 :2013	P
Radiated Emission	FCC Part 15: 15.209 FCC Part 15: 15.247(d) ANSI C63.10 :2013	P
Band Edge Compliance	FCC Part 15: 15.247(d) ANSI C63.10 :2013	P
Power Line Conducted Emissions	FCC Part 15: 15.207 ANSI C63.10 :2013	P
Antenna requirement	FCC Part 15: 15.203	P
Note:	1. P is an abbreviation for Pass. 2. F is an abbreviation for Fail. 3. N/A is an abbreviation for Not Applicable.	

## 2. GENERAL INFORMATION

### 2.1. Description of Device (EUT)

Description	: 2.4GHz Radio Control System
Model Number	: M17
Diff	: N/A
Trademark	: SANWA
Test Voltage	: Input rating: DC5V, 800mA DC 3.7V by Built-in battery
Operation frequency	: 2410-2465MHz, 2404-2470MHz, 2405-2471MHz, 2412-2478MHz, 2413-2479MHz, 2401-2467MHz 56Channels for 2410-2465MHz
Channel No.	: 34Channels for 2404-2470 MHz, 2405-2471 MHz, 2412-2478 MHz, 2413-2479MHz, 2401-2467MHz 1MHz for 2410-2465MHz
Channel Separation	: 2MHz for 2404-2470 MHz, 2405-2471 MHz, 2412-2478 MHz, 2413-2479MHz, 2401-2467MHz
Modulation type	: GFSK
Antenna Type	: PIFA Antenna, Maximum Gain is 3.14dBi
Antenna connector	: ipex connector
Software version	: SP-129_VER10105
Hardware version	: 700A17141A_700A17121A

## 2.2. Accessories of Device (EUT)

Accessories1 : /

Manufacturer : /

Model : /

## 2.3. Tested Supporting System Details

No.	Description	Manufacturer	Model	Serial Number	Certification or DOC
1	Notebook	ACER	ZQT	N/A	DOC

## 2.4. Block Diagram of connection between EUT and simulators

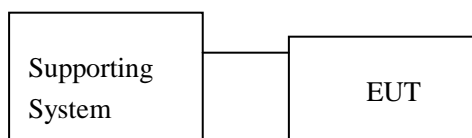

## 2.5. Test Mode Description

Mode	Channel
GFSK	Low
	Middle
	High

## 2.6. Test Conditions

Items	Required	Actual
Temperature range:	15-35°C	27°C
Humidity range:	25-75%	56%
Pressure range:	86-106kPa	980kPa



## 2.7. Test Facility

Shenzhen Alpha Product Testing Co., Ltd  
 Building i, No.2, Lixin Road, Fuyong Street, Bao'an District, 518103,  
 Shenzhen, Guangdong, China

June 21, 2018 File on Federal Communication Commission  
 Registration Number: 293961

July 25, 2017 Certificated by IC  
 Registration Number: 12135A

## 2.8. Measurement Uncertainty

(95% confidence levels, k=2)

Item	Uncertainty
Uncertainty for Power point Conducted Emissions Test	2.74dB
Uncertainty for Radiation Emission test in 3m chamber (below 30MHz)	2.13 dB(Polarize: V)
	2.57dB(Polarize: H)
Uncertainty for Radiation Emission test in 3m chamber (30MHz to 1GHz)	3.77dB(Polarize: V)
	3.80dB(Polarize: H)
Uncertainty for Radiation Emission test in 3m chamber (1GHz to 25GHz)	4.16dB(Polarize: H)
	4.13dB(Polarize: V)
Uncertainty for radio frequency	$5.4 \times 10^{-8}$
Uncertainty for conducted RF Power	0.37dB
Uncertainty for temperature	0.2°C
Uncertainty for humidity	1%
Uncertainty for DC and low frequency voltages	0.06%

## 2.9. Test Equipment List

Equipment	Manufacture	Model No.	Serial No.	Last cal.	Cal Interval
3m Semi-Anechoic	ETS-LINDGRE N	N/A	SEL0017	2018.09.21	1 Year
Spectrum analyzer	Agilent	E4407B	MY46185649	2018.09.21	1 Year
Receiver	R&S	ESCI	1166.5950K03-1011	2018.09.21	1 Year
Receiver	R&S	ESCI	101202	2018.09.21	1 Year
Bilog Antenna	Schwarzbeck	VULB 9168	VULB9168-438	2018.04.13	2 Year
Horn Antenna	EMCO	3115	640201028-06	2018.04.13	2 Year
Active Loop Antenna	Beijing Daze	ZN30900A	SEL0097	2018.04.13	2 Year
Cable	Resenberger	N/A	No.1	2018.09.21	1 Year
Cable	SCHWARZBEC K	N/A	No.2	2018.09.21	1 Year
Cable	SCHWARZBEC K	N/A	No.3	2018.09.21	1 Year
Pre-amplifier	Schwarzbeck	BBV9743	9743-019	2018.09.21	1 Year
Pre-amplifier	R&S	AFS33-18002650-30-8P-44	SEL0080	2018.09.21	1 Year
Temperature controller	Terchy	MHQ	120	2018.09.21	1 Year
L.I.S.N.#1	Schwarzbeck	NSLK8126	8126466	2018.09.21	1 Year
L.I.S.N.#2	ROHDE&SCHWARZ	ENV216	101043	2018.09.21	1 Year
20db Attenuator	ICPROBING	IATS1	82347	2018.09.21	1 Year
Horn Antenna	SCHWARZBEC K	BBHA 9170	BBHA 9170294	2018.04.13	2 Year
Power Meter	Anritsu	ML2487A	6K00001491	2018.09.21	1 Year

### 3. MAXIMUM PEAK OUTPUT POWER

#### 3.1.Limit

Please refer section 15.247.

For frequency hopping systems operating in the 2400-2483.5 MHz band employing at least 75 non-overlapping hopping channels, and all frequency hopping systems in the 5725-5850 MHz band: 1 watt. For all other frequency hopping systems in the 2400-2483.5 MHz band: 0.125 watts, the e.i.r.p shall not exceed 4W

#### 3.2.Test Procedure

The transmitter output is connected to the RF Power Meter. The RF Power Meter is set to the peak power detection.

#### 3.3.Test Setup

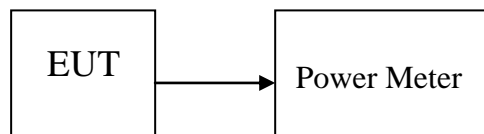

#### 3.4.Test Result

2404-2470 MHz:

Mode	Freq (MHz)	PK Output Power (dBm)	PK Output Power (mW)	Limit (dBm)	Result
GFSK	2404	8.96	7.870	30	Pass
	2438	<b>9.03</b>	7.998	30	Pass
	2470	8.87	7.709	30	Pass
Conclusion: PASS					

2405-2471 MHz:

Mode	Freq (MHz)	PK Output Power (dBm)	PK Output Power (mW)	Limit (dBm)	Result
GFSK	2405	8.95	7.852	30	Pass
	2439	9.00	7.943	30	Pass
	2471	8.86	7.691	30	Pass
Conclusion: PASS					

## 2412-2478 MHz:

Mode	Freq (MHz)	PK Output Power (dBm)	PK Output Power (mW)	Limit (dBm)	Result
GFSK	2412	8.92	7.798	30	Pass
	2446	8.99	7.925	30	Pass
	2478	8.93	7.816	30	Pass
Conclusion: PASS					

## 2413-2479 MHz:

Mode	Freq (MHz)	PK Output Power (dBm)	PK Output Power (mW)	Limit (dBm)	Result
GFSK	2413	9.01	7.962	30	Pass
	2447	8.94	7.834	30	Pass
	2479	8.92	7.798	30	Pass
Conclusion: PASS					

## 2410-2465 MHz:

Mode	Freq (MHz)	PK Output Power (dBm)	PK Output Power (mW)	Limit (dBm)	Result
GFSK	2410	8.95	7.852	30	Pass
	2437	8.99	7.925	30	Pass
	2465	8.89	7.745	30	Pass
Conclusion: PASS					

## 2401-2467 MHz:

Mode	Freq (MHz)	PK Output Power (dBm)	PK Output Power (mW)	Limit (dBm)	Result
GFSK	2401	8.95	7.852	30	Pass
	2435	8.99	7.925	30	Pass
	2467	8.89	7.745	30	Pass
Conclusion: PASS					

## 4. BANDWIDTH

### 4.1.Limit

Intentional radiators operating under the alternative provisions to the general emission limits, as contained in §§ 15.217 through 15.257 and in Subpart E of this part, must be designed to ensure that the 20 dB bandwidth of the emission, or whatever bandwidth may otherwise be specified in the specific rule section under which the equipment operates, is contained within the frequency band designated in the rule section under which the equipment is operated.

### 4.2.Test Procedure

The RF output of EUT was connected to the spectrum analyzer by RF cable and attenuator. The bandwidth of the fundamental frequency was measured by spectrum analyzer with 100kHz RBW and 300kHz VBW. The 20dB bandwidth is defined as the total spectrum the power of which is higher than peak power minus 20dB.

### 4.3.Test Result

2404-2470 MHz:

Mode	Freq (MHz)	20dB Bandwidth (KHz)	Conclusion
GFSK	2404	1888	PASS
	2438	1975	PASS
	2470	1890	PASS

2405-2471 MHz:

Mode	Freq (MHz)	20dB Bandwidth (KHz)	Conclusion
GFSK	2405	1813	PASS
	2439	1869	PASS
	2471	1915	PASS

2412-2478 MHz:

Mode	Freq (MHz)	20dB Bandwidth (KHz)	Conclusion
GFSK	2412	1886	PASS
	2446	1811	PASS
	2478	1877	PASS

## 2413-2479 MHz:

Mode	Freq (MHz)	20dB Bandwidth (KHz)	Conclusion
GFSK	2413	1960	PASS
	2447	1896	PASS
	2479	1781	PASS

## 2410-2465 MHz:

Mode	Freq (MHz)	20dB Bandwidth (KHz)	Conclusion
GFSK	2410	1270	PASS
	2437	1264	PASS
	2465	1282	PASS

## 2401-2467 MHz:

Mode	Freq (MHz)	20dB Bandwidth (KHz)	Conclusion
GFSK	2401	1715	PASS
	2435	1735	PASS
	2467	1697	PASS

Original Test data For 20dB bandwidth

GFSK mode

2404-2470 MHz



2405-2471 MHz



Lowest channel



Lowest channel



Middle channel



Middle channel



Highest channel

Highest channel

**GFSK mode**

<b>2412-2478 MHz</b>	<b>2413-2479MHz</b>
----------------------	---------------------



Lowest channel

Lowest channel



Middle channel

Middle channel



Highest channel

Highest channel



**GFSK mode**

<b>2410-2465MHz</b>	<b>2401-2467MHz</b>
---------------------	---------------------



**Lowest channel**



**Middle channel**



**Highest channel**

## 5. CARRIER FREQUENCY SEPARATION

### 5.1.Limit

Frequency hopping systems shall have hopping channel carrier frequencies separated by a minimum of 25 kHz or the 20 dB bandwidth of the hopping channel, whichever is greater. Alternatively, frequency hopping systems operating in the 2400-2483.5 MHz band may have hopping channel carrier frequencies that are separated by 25 kHz or two-thirds of the 20 dB bandwidth of the hopping channel, whichever is greater, provided the systems operate with an output power no greater than 125 mW

### 5.2.Test Procedure

The RF output of EUT was connected to the spectrum analyzer by RF cable and attenuator. The carrier frequency was measured by spectrum analyzer with 100kHz RBW and 300kHz VBW.

### 5.3.Test Result

Mode	Channel separation(MHz)	20dB Bandwidth (KHz)	Limit (KHz)	Conclusion
GFSK (2404-2470MHz)	2.000	1975	1317	PASS
GFSK (2405-2471MHz)	2.000	1915	1277	PASS
GFSK (2412-2478MHz)	2.000	1886	1257	PASS
GFSK (2413-2479MHz)	2.000	1960	1307	PASS
GFSK 2401-2467MHz	2.012	1735	1157	PASS
GFSK (2410-2465MHz)	1.000	1270	847	PASS

Original test data for channel separation

2404-2470 MHz

Channel separation(MHz): 2.000



2405-2471 MHz

Channel separation(MHz): 2.000



2412-2478 MHz

Channel separation(MHz): 2.000



2413-2479MHz

Channel separation(MHz): 2.000



2401-2467MHz

Channel separation(MHz): 2.012



2410-2465MHz

Channel separation(MHz): 1.000



## 6. NUMBER OF HOPPING CHANNEL

### 6.1.Limit

Frequency hopping systems in the 2400-2483.5 MHz band shall use at least 15 channels

### 6.2.Test Procedure

The RF output of EUT was connected to the spectrum analyzer by RF cable and attenuator. The number of hopping channel was measured by spectrum analyzer with 100kHz RBW and 300KHz VBW.

### 6.3.Test Result

Mode	Number of hopping channel	Limit	Conclusion
GFSK (2404-2470 MHz, 2405-2471 MHz, 2412-2478 MHz, 2413-2479MHz, 2401-2467MHz)	34	>15	PASS
GFSK (2410-2465MHz)	56	>15	PASS

Original test data for hopping channel number

2404-2470 MHz

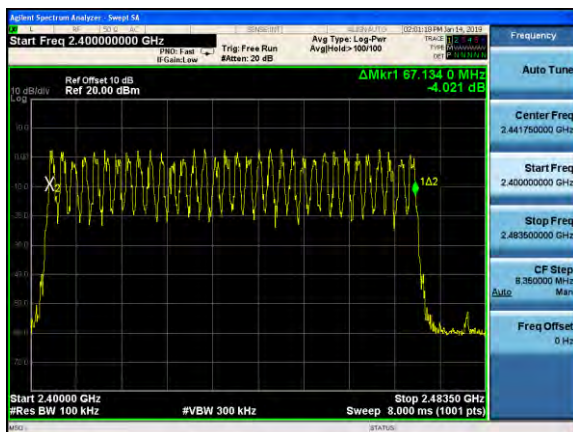

2405-2471 MHz



2412-2478 MHz



2413-2479MHz



2410-2465 MHz



2401-2467MHz



## 7. DWELL TIME

### 7.1. Test limit

Please refer section 15.247

According to §15.247(a)(1)(iii), Frequency hopping systems operating in the 2400MHz-2483.5 MHz. The average time of occupancy on any frequency shall not be greater than 0.4 s within period of 0.4 seconds multiplied by the number of hopping channels employed.

### 7.2. Test Procedure

7.2.1. Place the EUT on the table and set it in transmitting mode.

7.2.2. Remove the antenna from the EUT and then connect a low loss RF cable from the antenna port to the spectrum analyzer.

7.2.3. Set center frequency of spectrum analyzer = operating frequency.

7.2.4. Set the spectrum analyzer as RBW=1MHz, VBW=1MHz, Span = 0Hz, Sweep = auto.

7.2.5. Repeat above procedures until all frequency measurements were complete.

### 7.3. Test Result

PASS.

Detailed information please see the following page.

## 2404-2470 MHz:

Mode	Frequency (MHz)	Pulse Duration (ms)	Dwell Time (ms)	Limit (ms)	Conclusion
GFSK	2404	0.132	84.480	400	PASS
	2438	0.133	85.120		PASS
	2470	0.132	84.480		PASS
Note: 1 A period time = 0.4 (s) * 34 = 13.6(s) 2 Time slot = Pulse Duration * (1600/(2*34)) * A period time/1000					

## 2405-2471MHz:

Mode	Frequency (MHz)	Pulse Duration (ms)	Dwell Time (ms)	Limit (ms)	Conclusion
GFSK	2405	0.133	85.120	400	PASS
	2439	0.133	85.120		PASS
	2471	0.132	84.480		PASS
Note: 1 A period time = 0.4 (s) * 34 = 13.6(s) 2 Time slot = Pulse Duration * (1600/(2*34)) * A period time/1000					

## 2412-2478MHz:

Mode	Frequency (MHz)	Pulse Duration (ms)	Dwell Time (ms)	Limit (ms)	Conclusion
GFSK	2412	0.132	84.480	400	PASS
	2446	0.133	85.120		PASS
	2478	0.132	84.480		PASS
Note: 1 A period time = 0.4 (s) * 34 = 13.6(s) 2 Time slot = Pulse Duration * (1600/(2*34)) * A period time/1000					

## 2413-2479MHz:

Mode	Frequency (MHz)	Pulse Duration (ms)	Dwell Time (ms)	Limit (ms)	Conclusion
GFSK	2413	0.134	85.760	400	PASS
	2447	0.132	84.480		PASS
	2479	0.133	85.120		PASS
Note: 1 A period time = 0.4 (s) * 34 = 13.6(s) 2 Time slot = Pulse Duration * (1600/(2*34)) * A period time/1000					



## 2401-2467MHz:

Mode	Frequency (MHz)	Pulse Duration (ms)	Dwell Time (ms)	Limit (ms)	Conclusion
GFSK	2401	0.133	85.120	400	PASS
	2435	0.134	85.760		PASS
	2467	0.133	85.120		PASS
Note: 1 A period time = $0.4 (s) * 34 = 13.6(s)$ 2 Time slot = $Pulse\ Duration * (1600/(2*34)) * A\ period\ time/1000$					

## 2410-2465 MHz:

Mode	Frequency (MHz)	Pulse Duration (ms)	Dwell Time (ms)	Limit (ms)	Conclusion
GFSK	2410	0.386	247.040	400	PASS
	2437	0.389	248.960		PASS
	2465	0.388	248.320		PASS
Note: 1 A period time = $0.4 (s) * 56 = 22.4(s)$ 2 Time slot = $Pulse\ Duration * (1600/(2*56)) * A\ period\ time/1000$					

GFSK mode

---

2404-2470 MHz
2405-2471 MHz

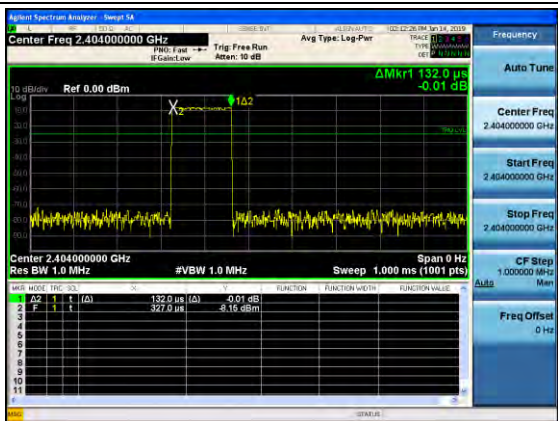

Lowest channel

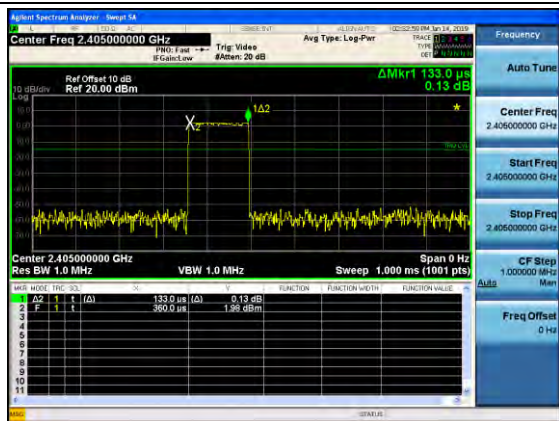

Lowest channel

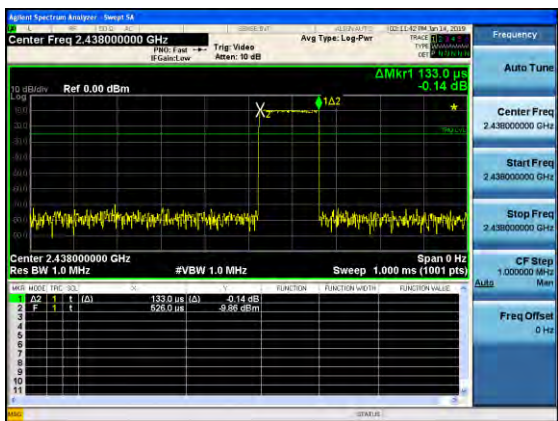

Middle channel

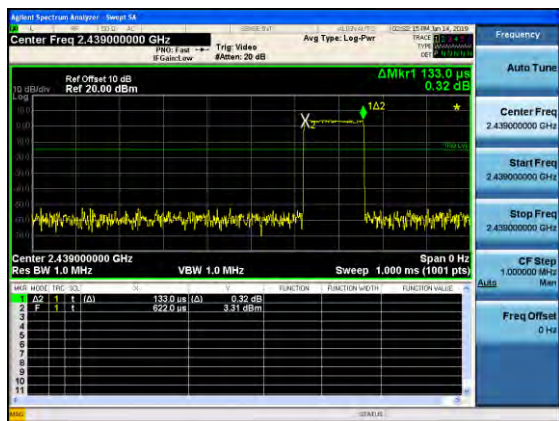

Middle channel

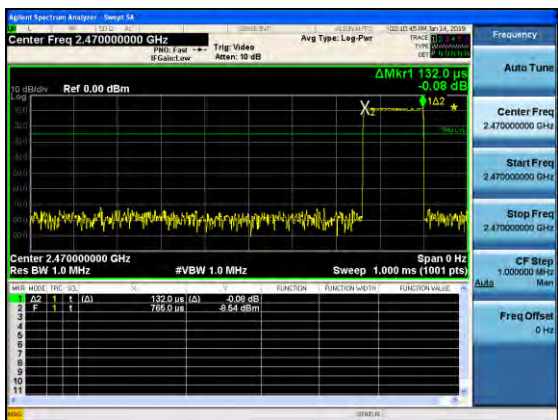

Highest channel

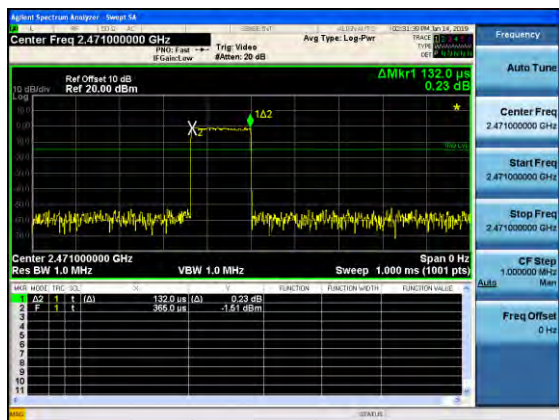

Highest channel

GFSK mode

2412-2478 MHz	2413-2479MHz
---------------	--------------

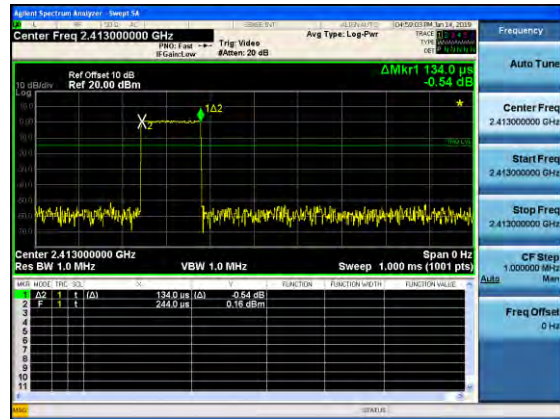
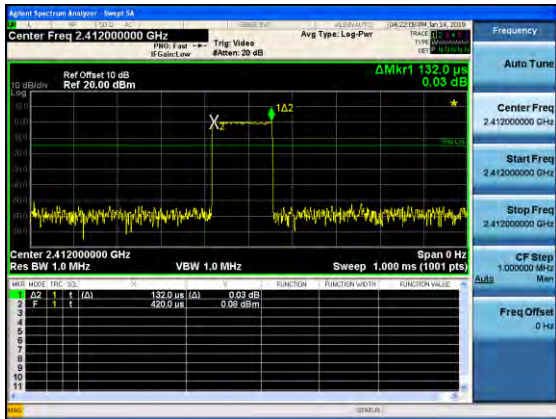

Lowest channel

Lowest channel

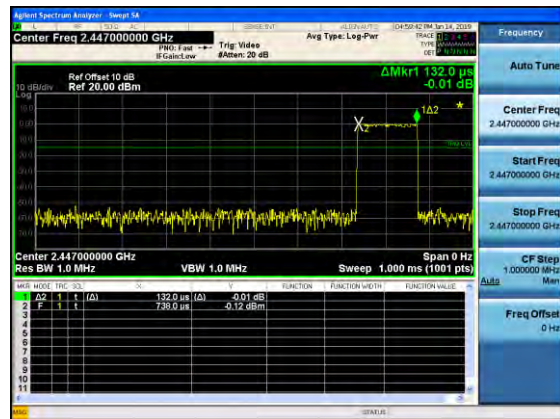
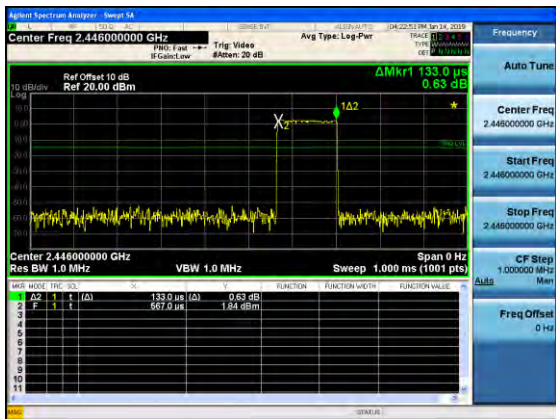

Middle channel

Middle channel

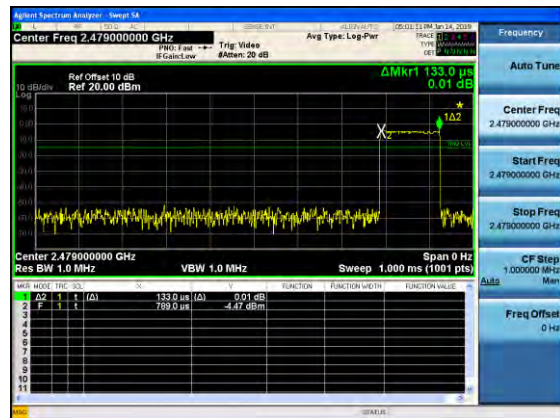
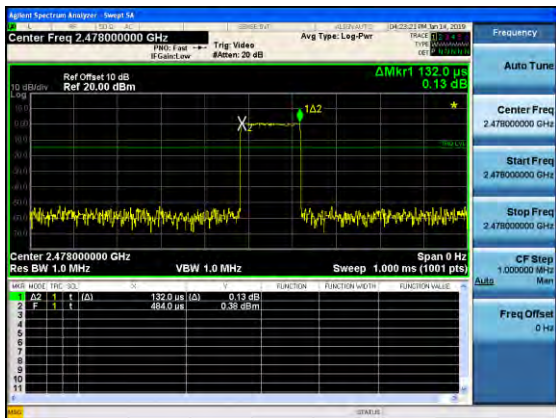

Highest channel

Highest channel

GFSK mode

---

2410-2465MHz
2401-2467MHz

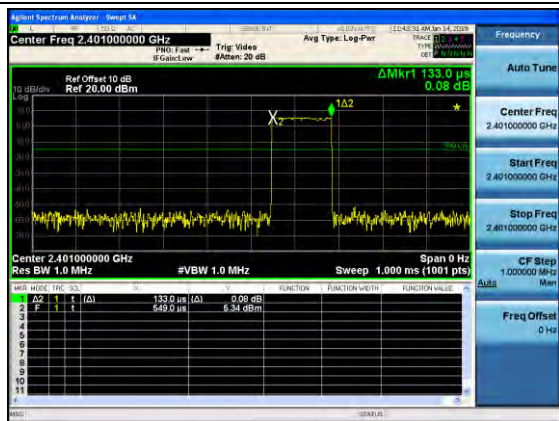
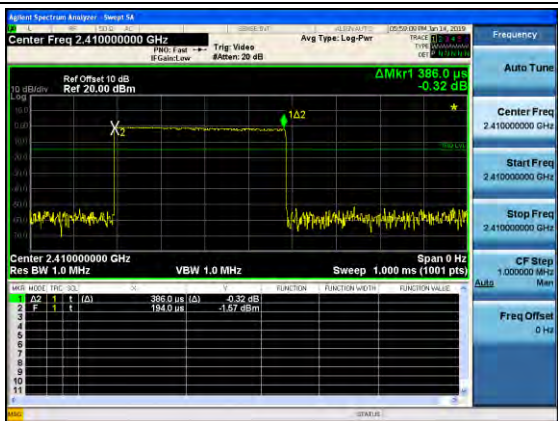

Lowest channel

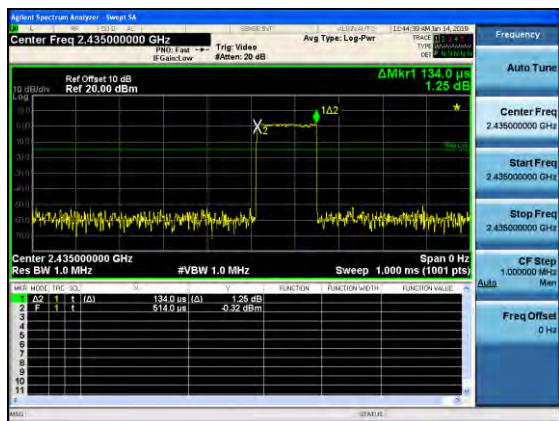
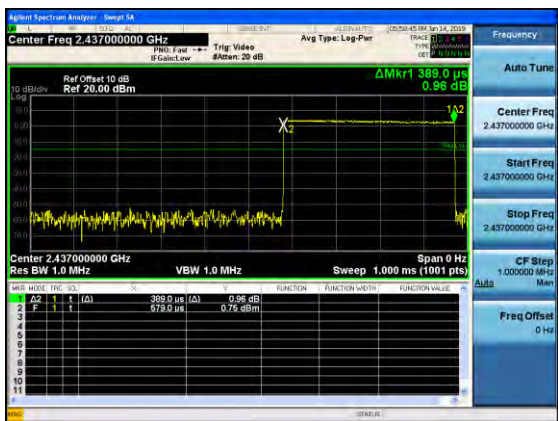

Middle channel

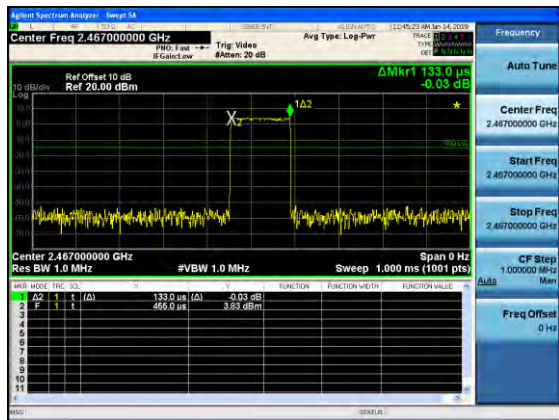
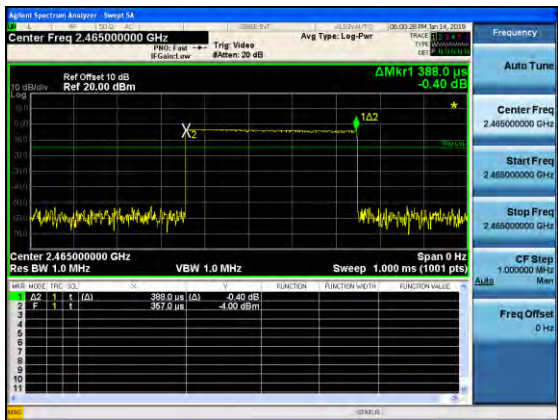

Highest channel

## 8. RADIATED EMISSIONS

### 8.1.Limit

All the emissions appearing within 15.205 restricted frequency bands shall not exceed the limits shown in 15.209, all the other emissions shall be at least 20dB below the fundamental emissions, or comply with 15.209 limits.

#### 15.205 Restricted frequency band

MHz	MHz	MHz	GHz
0.090 - 0.110	16.42 - 16.423	399.9 - 410	4.5 - 5.15
<sup>1</sup> 0.495 - 0.505	16.69475 - 16.69525	608 - 614	5.35 - 5.46
2.1735 - 2.1905	16.80425 - 16.80475	960 - 1240	7.25 - 7.75
4.125 - 4.128	25.5 - 25.67	1300 - 1427	8.025 - 8.5
4.17725 - 4.17775	37.5 - 38.25	1435 - 1626.5	9.0 - 9.2
4.20725 - 4.20775	73 - 74.6	1645.5 - 1646.5	9.3 - 9.5
6.215 - 6.218	74.8 - 75.2	1660 - 1710	10.6 - 12.7
6.26775 - 6.26825	108 - 121.94	1718.8 - 1722.2	13.25 - 13.4
6.31175 - 6.31225	123 - 138	2200 - 2300	14.47 - 14.5
8.291 - 8.294	149.9 - 150.05	2310 - 2390	15.35 - 16.2
8.362 - 8.366	156.52475 - 156.52525	2483.5 - 2500	17.7 - 21.4
8.37625 - 8.38675	156.7 - 156.9	2690 - 2900	22.01 - 23.12
8.41425 - 8.41475	162.0125 - 167.17	3260 - 3267	23.6 - 24.0
12.29 - 12.293	167.72 - 173.2	3332 - 3339	31.2 - 31.8
12.51975 - 12.52025	240 - 285	3345.8 - 3358	36.43 - 36.5
12.57675 - 12.57725	322 - 335.4	3600 - 4400	( <sup>2</sup> )

#### 15.209 Limit

FREQUENCY MHz	DISTANCE Meters	FIELD STRENGTHS LIMIT	
		$\mu\text{V}/\text{m}$	$\text{dB}(\mu\text{V})/\text{m}$
0.009-0.490	300	2400/F(KHz)	/
0.490-1.705	30	24000/F(KHz)	/
1.705-30	30	30	29.5
30 ~ 88	3	100	40.0
88 ~ 216	3	150	43.5
216 ~ 960	3	200	46.0
960 ~ 1000	3	500	54.0
Above 1000	3	74.0 dB( $\mu\text{V}$ )/m (Peak) 54.0 dB( $\mu\text{V}$ )/m (Average)	

## 8.2. Block Diagram of Test setup

### 8.2.1 In 3m Anechoic Chamber Test Setup Diagram for below 30MHz

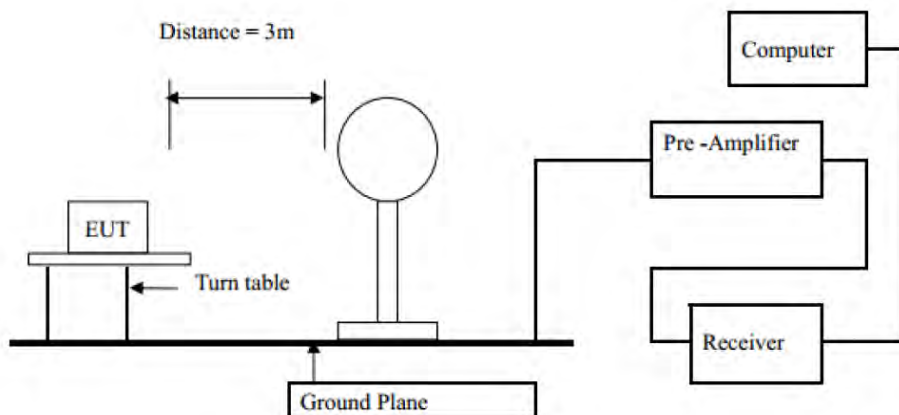

### 8.2.1 In 3m Anechoic Chamber Test Setup Diagram for below 1GHz

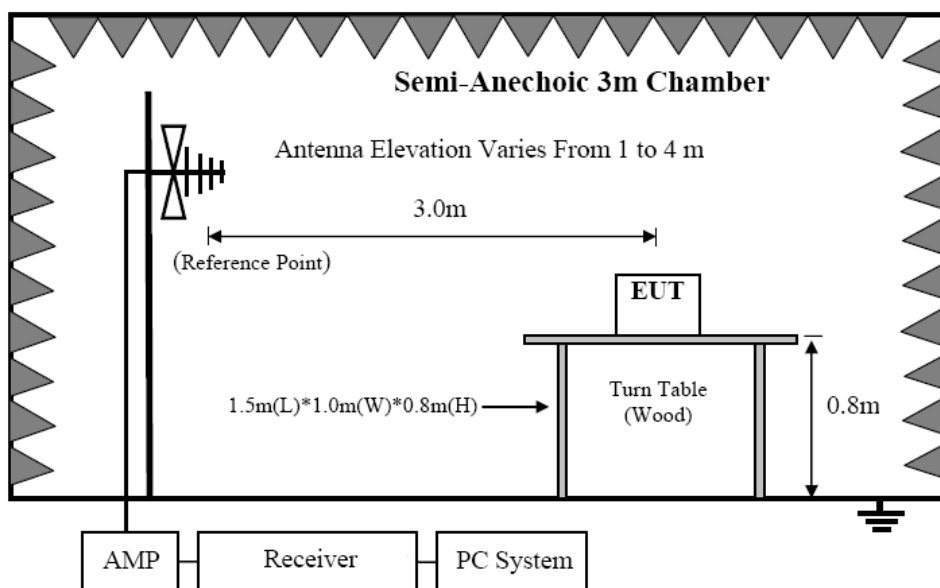

### 8.2.2 In 3m Anechoic Chamber Test Setup Diagram for frequency above 1GHz

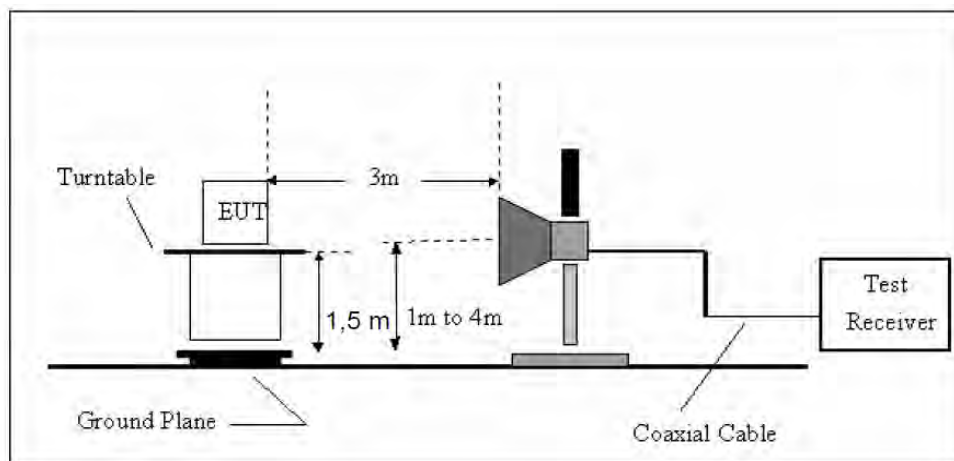

Note: For harmonic emissions test a appropriate high pass filter was inserted in the input port of AMP.

### 8.3. Test Procedure

- (1) The EUT was placed on a non-metallic table, 80 cm above the ground plane inside a semi-anechoic chamber for below 1GHz and 150 cm above the ground plane inside a semi-anechoic chamber for above 1GHz.
- (2) Setup EUT and simulator as shown in section 1.4 and 6.1
- (3) Test antenna was located 3m from the EUT on an adjustable mast. Below pre-scan procedure was first performed in order to find prominent radiated emissions.
  - (a) Change work frequency or channel of device if practicable.
  - (b) Change modulation type of device if practicable.
  - (c) Rotated EUT though three orthogonal axes to determine the attitude of EUT arrangement produces highest emissions
- (4) Spectrum frequency from 9KHz to 25GHz (tenth harmonic of fundamental frequency) was investigated
- (5) For final emissions measurements at each frequency of interest, the EUT were rotated and the antenna height was varied between 1m and 4m in order to maximize the emission. Measurements in both horizontal and vertical polarities were made and the data was recorded. In order to find the maximum emission, the relative positions of equipments and all of the interface cables were changed according to ANSI C63.10 :2013on Radiated Emission test.
- (6) For emissions above 1GHz, both Peak and Average level were measured with Spectrum Analyzer, and the RBW is set at 1MHz, VBW is set at 3MHz for Peak measure; RBW is set at 1MHz, VBW is set at 10Hz for Average measure.

### 8.4. Test Result

We have scanned the 10th harmonic from 9KHz to the EUT's highest frequency..  
Detailed information please see the following page.

From 9KHz to 30MHz: Conclusion: PASS

Note: The amplitude of spurious emissions which are attenuated by more than 20dB below the permissible value has no need to be reported.

From 30MHz to 1000MHz: Conclusion: PASS

Vertical:

**Radiated Emission Measurement**

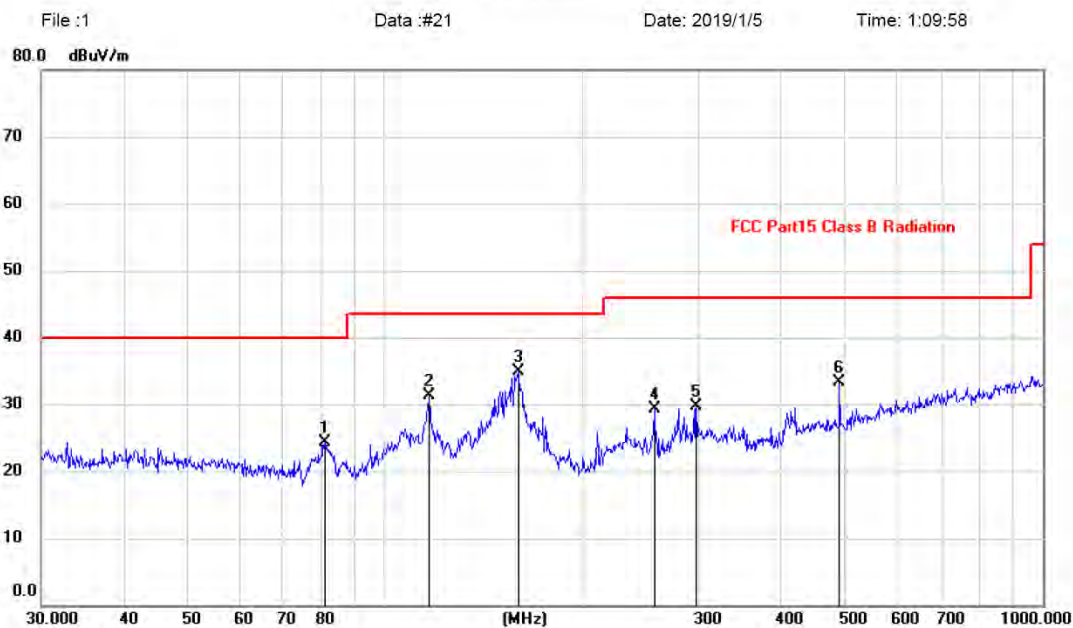

No.	Mk.	Freq.	Reading Level	Correct Factor	Measurement	Limit	Margin	Antenna Height	Table Degree	
		MHz	dBuV	dB	dBuV/m	dBuV/m	dB	cm	degree	Comment
1		80.9275	14.83	9.49	24.32	40.00	-15.68			peak
2		116.9495	18.95	12.27	31.22	43.50	-12.28			peak
3	*	159.2251	20.40	14.58	34.98	43.50	-8.52			peak
4		257.4222	16.99	12.27	29.26	46.00	-16.74			peak
5		297.2241	16.29	13.39	29.68	46.00	-16.32			peak
6		490.7447	15.84	17.39	33.23	46.00	-12.77			peak

Note:1. \*:Maximum data; x:Over limit; !:over margin.

2.Measurement=Reading Level+Correct Factor; Correct Factor=Antenna Factor+Cable Loss.



**Horizontal:**

**Radiated Emission Measurement**

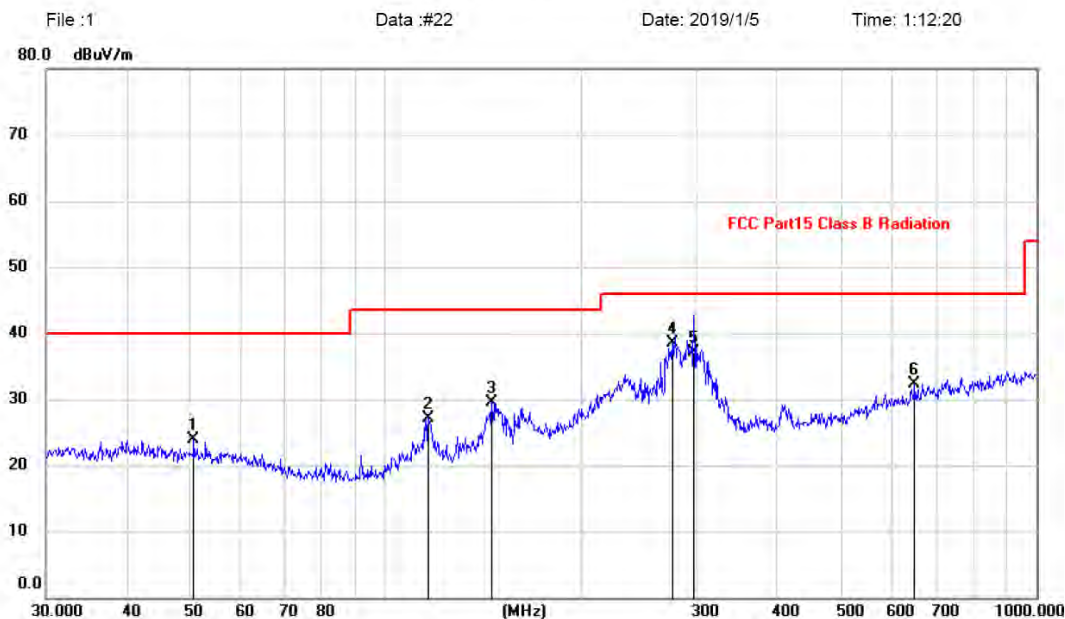

No.	Mk.	Freq.	Reading Level	Correct Factor	Measurement	Limit	Margin	Antenna Height	Table Degree	
		MHz	dBuV	dB	dBuV/m	dBuV/m	dB	cm	degree	Comment
1		50.7637	10.31	13.65	23.96	40.00	-16.04			peak
2		116.1321	14.86	12.18	27.04	43.50	-16.46			peak
3		145.3506	15.38	14.22	29.60	43.50	-13.90			peak
4	*	275.1570	25.60	12.87	38.47	46.00	-7.53			peak
5		297.2241	23.70	13.39	37.09	46.00	-8.91			QP
6		649.6597	12.02	20.33	32.35	46.00	-13.65			peak

Note:1. \*:Maximum data; x:Over limit; !:over margin.

2.Measurement=Reading Level+Correct Factor; Correct Factor=Antenna Factor+Cable Loss.

Remark: All modes have been tested, and only worst data of Channel 2438MHz (2404-2470MHz; DC 3.7V) was listed in this report.

From 1G-25GHz

Test Mode: GFSK TX Low									
Freq (MHz)	Read Level (dBuV/m)	Polar (H/V)	Antenna Factor (dB/m)	Cable loss(dB)	Amp Factor (dB)	Result (dBuV/m)	Limit (dBuV/m)	Margin (dB)	Remark
4802	45.23	V	33.95	10.18	34.26	55.10	74	18.90	PK
4802	34.53	V	33.95	10.18	34.26	44.40	54	9.60	AV
7203	/		/						
9604	/		/						
4802	45.86	H	33.95	10.18	34.26	55.73	74	18.27	PK
4802	34.06	H	33.95	10.18	34.26	43.93	54	10.07	AV
7203									
9604									
Test Mode: GFSK TX Mid									
4878	43.48	V	33.93	10.2	34.29	53.32	74	20.68	PK
4878	34.45	V	33.93	10.2	34.29	44.29	54	9.71	AV
7317	/								
9756	/								
4878	44.48	H	33.93	10.2	34.29	54.32	74	19.68	PK
4878	35.01	H	33.93	10.2	34.29	44.85	54	9.15	AV
7317									
9756									
Test Mode: GFSK TX High									
4958	43.53	V	33.98	10.22	34.25	53.48	74	20.52	PK
4958	34.05	V	33.98	10.22	34.25	44.00	54	10.00	AV
7437	/								
9916	/								
4958	43.64	H	33.98	10.22	34.25	53.59	74	20.41	PK
4958	32.61	H	33.98	10.22	34.25	42.56	54	11.44	AV
7437	/								
9916	/								
Note:									
1, Result = Read level + Antenna factor + cable loss-Amp factor									
2, All the other emissions not reported were too low to read and deemed to comply with FCC limit.									

## 9. BAND EDGE COMPLIANCE

### 9.1. Block Diagram of Test Setup

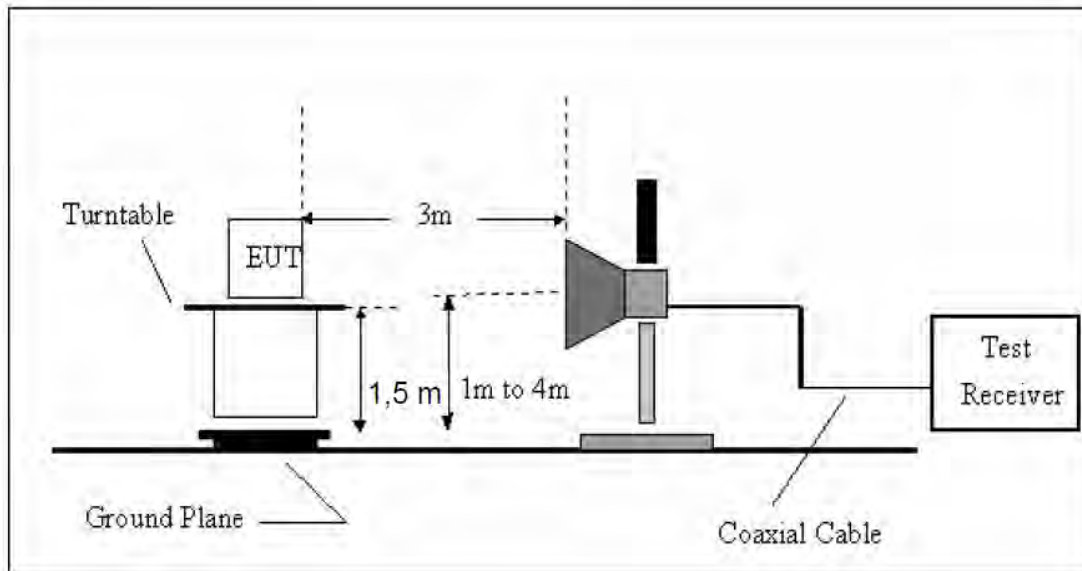

### 9.2. Limit

All the lower and upper band-edges emissions appearing within restricted frequency bands shall not exceed the limits shown in 15.209, all the other emissions outside operation shall be at least 20dB below the fundamental emissions, or comply with 15.209 limits.

### 9.3. Test Procedure

All restriction band and non- restriction band have been tested , only worse case is reported.

### 9.4. Test Result

PASS. (See below detailed test data)

Test Mode: GFSK-Low (2404MHz)

Polarization: Vertical

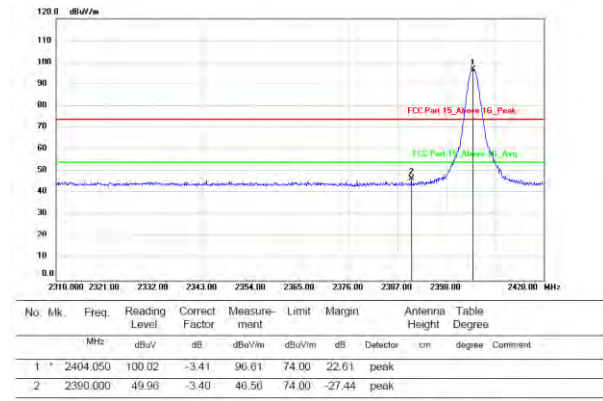

hopping-off

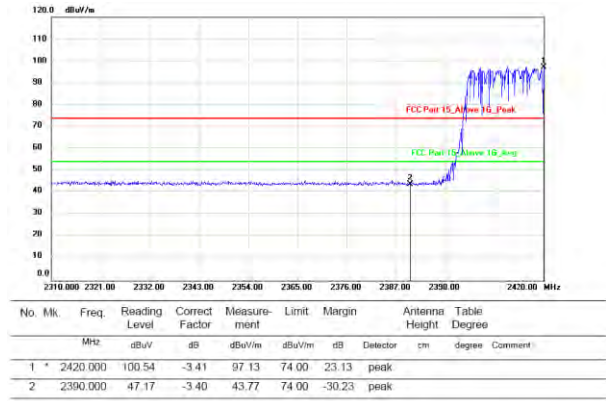

hopping-on

Polarization: Horizontal

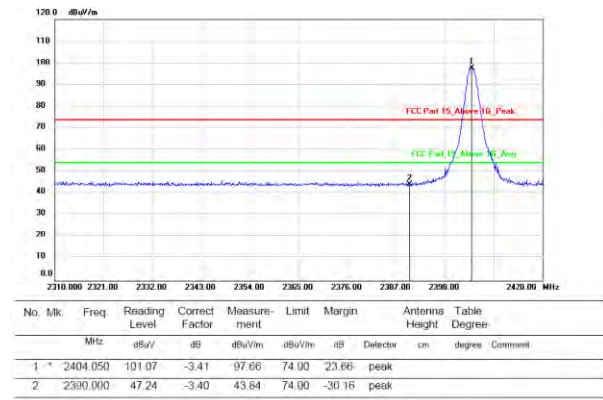

hopping-off

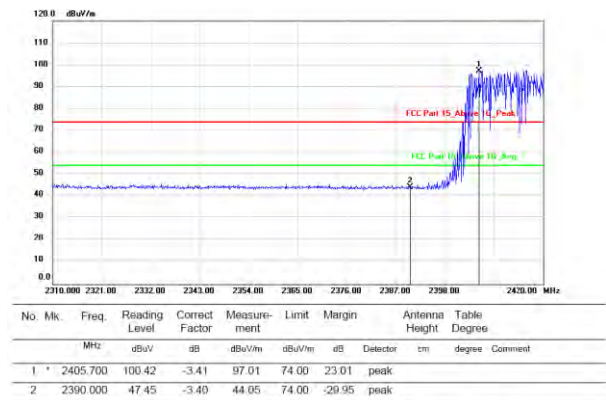

hopping-on

Test Mode: GFSK-High (2470MHz)

Polarization: Vertical

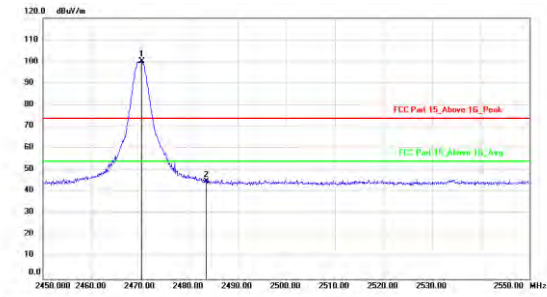

No.	Mk.	Freq.	Reading Level	Correct Factor	Measurement	Limit	Margin	Antenna Height	Table Degree	Comment
		MHz	dBuV	dB	dBuV/m	dBuV/m	dB	Detector	cm	degree
1	*	2470.300	103.78	-3.39	100.39	74.00	26.39	peak		
2		2483.500	48.30	-3.38	44.92	74.00	-29.08	peak		

hopping-off

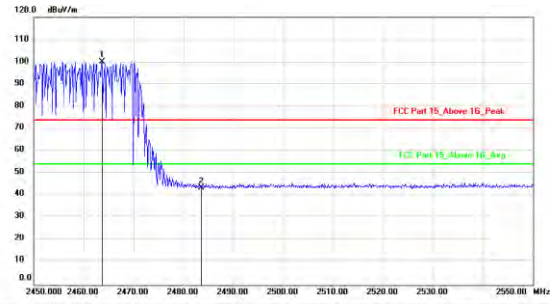

No.	Mk.	Freq.	Reading Level	Correct Factor	Measurement	Limit	Margin	Antenna Height	Table Degree	Comment
		MHz	dBuV	dB	dBuV/m	dBuV/m	dB	Detector	cm	degree
1	*	2463.600	103.30	-3.40	99.90	74.00	25.90	peak		
2		2483.500	46.86	-3.38	43.48	74.00	-30.52	peak		

hopping-on

Polarization: Horizontal

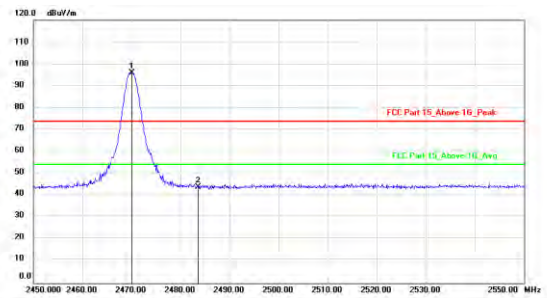

No.	Mk.	Freq.	Reading Level	Correct Factor	Measurement	Limit	Margin	Antenna Height	Table Degree	Comment
		MHz	dBuV	dB	dBuV/m	dBuV/m	dB	Detector	cm	degree
1	*	2470.000	99.34	-3.39	95.95	74.00	21.95	peak		
2		2483.500	46.99	-3.38	43.61	74.00	-30.39	peak		

hopping-off

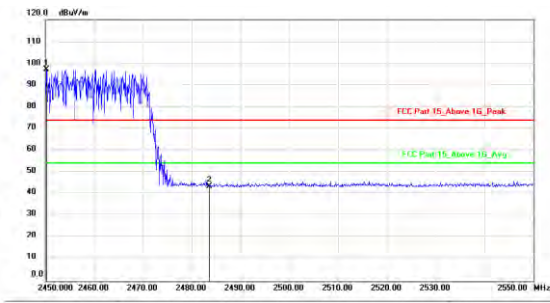

No.	Mk.	Freq.	Reading Level	Correct Factor	Measurement	Limit	Margin	Antenna Height	Table Degree	Comment
		MHz	dBuV	dB	dBuV/m	dBuV/m	dB	Detector	cm	degree
1	*	2450.200	100.29	-3.39	96.90	74.00	22.90	peak		
2		2483.500	46.81	-3.38	43.43	74.00	-30.57	peak		

hopping-on

Test Mode: GFSK-Low (2405MHz)

Polarization: Vertical

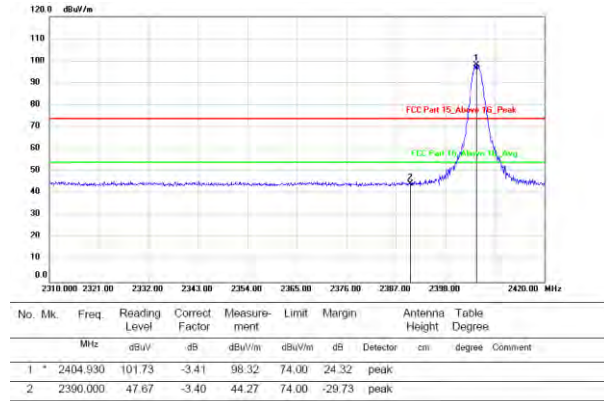

hopping-off

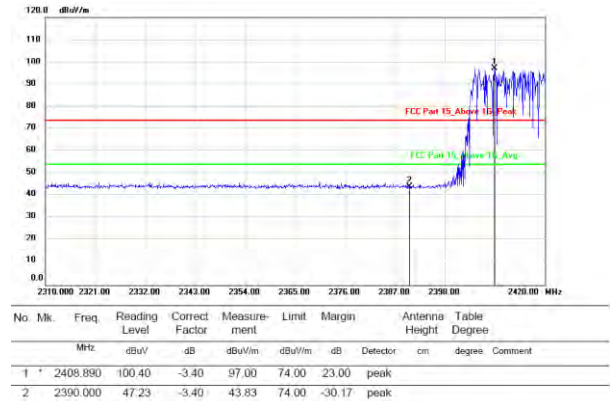

hopping-on

Polarization: Horizontal

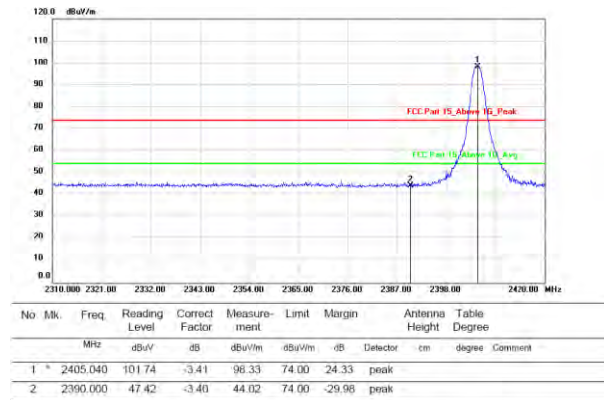

hopping-off

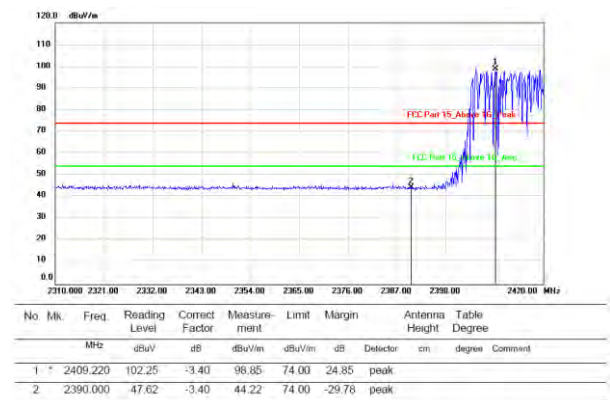

hopping-on

Test Mode: GFSK-High (2471MHz)

Polarization: Vertical

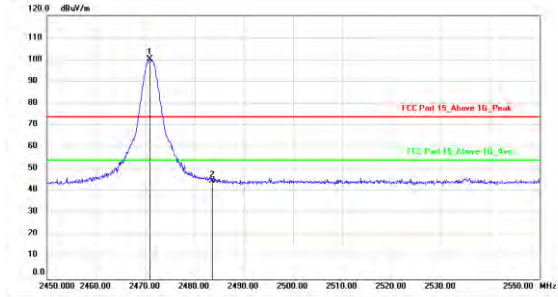

No.	Mk.	Freq.	Reading Level	Correct Factor	Measurement	Limit	Margin	Antenna Height	Table Degree		
		MHz	dBuV	dB	dBuV/m	dBuV/m	dB	Detector	cm	degree	Comment
1	*	2470.900	103.61	-3.39	100.22	74.00	26.22	peak			
2		2483.500	47.86	-3.38	44.48	74.00	-29.52	peak			

hopping-off

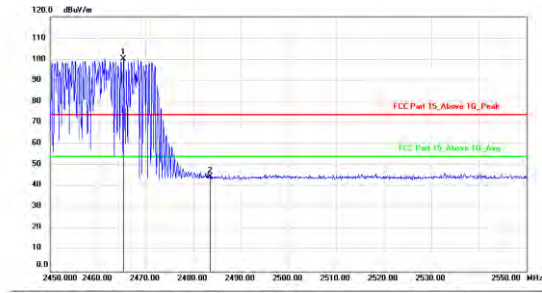

No.	Mk.	Freq.	Reading Level	Correct Factor	Measurement	Limit	Margin	Antenna Height	Table Degree		
		MHz	dBuV	dB	dBuV/m	dBuV/m	dB	Detector	cm	degree	Comment
1	*	2465.300	103.73	-3.39	100.34	74.00	26.34	peak			
2		2483.500	47.82	-3.38	44.44	74.00	-29.56	peak			

hopping-on

Polarization: Horizontal

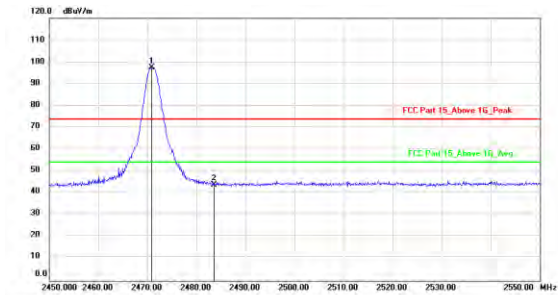

No.	Mk.	Freq.	Reading Level	Correct Factor	Measurement	Limit	Margin	Antenna Height	Table Degree		
		MHz	dBuV	dB	dBuV/m	dBuV/m	dB	Detector	cm	degree	Comment
1	*	2470.900	100.68	-3.39	97.29	74.00	23.29	peak			
2		2483.500	47.02	-3.38	43.64	74.00	-30.36	peak			

hopping-off

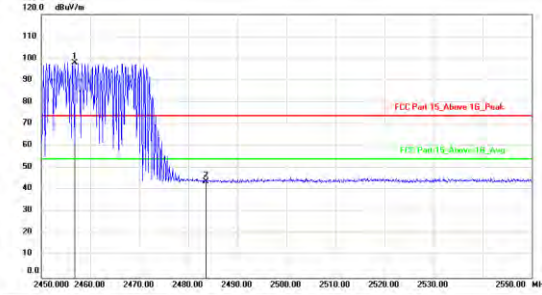

No.	Mk.	Freq.	Reading Level	Correct Factor	Measurement	Limit	Margin	Antenna Height	Table Degree		
		MHz	dBuV	dB	dBuV/m	dBuV/m	dB	Detector	cm	degree	Comment
1	*	2465.900	101.45	-3.39	98.06	74.00	24.06	peak			
2		2483.500	47.17	-3.38	43.79	74.00	-30.21	peak			

hopping-on

Test Mode: GFSK-Low (2412MHz)

Polarization: Vertical

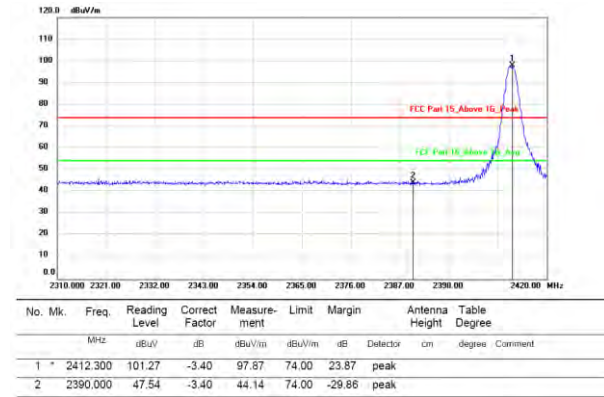

hopping-off

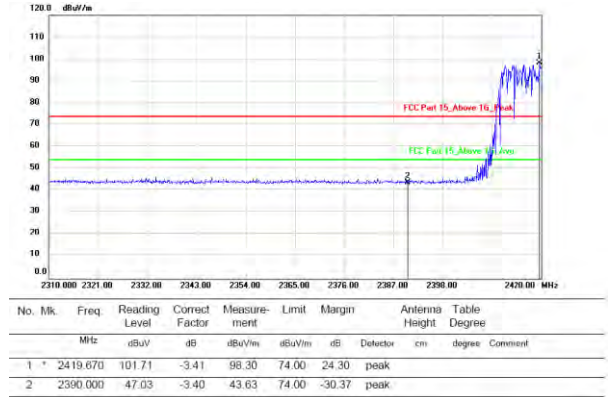

hopping-on

Polarization: Horizontal

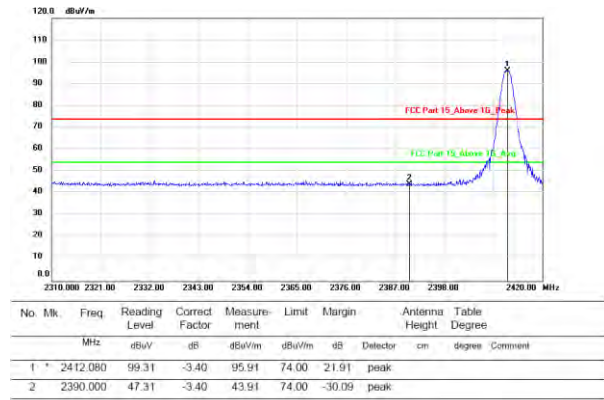

hopping-off

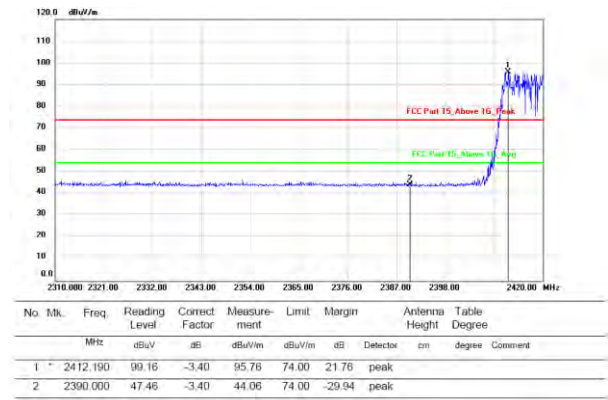

hopping-on



Test Mode: GFSK-High (2478MHz)

Polarization: Vertical

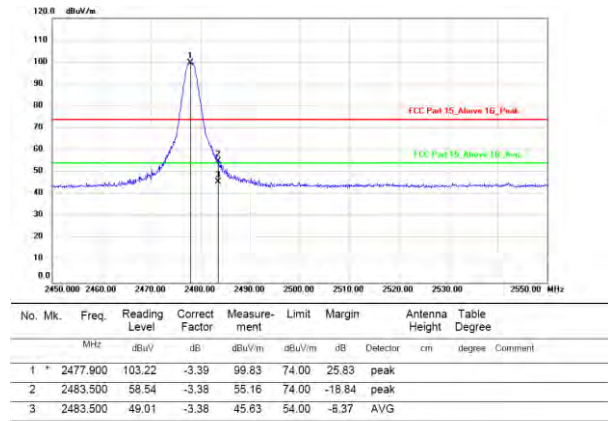

hopping-off

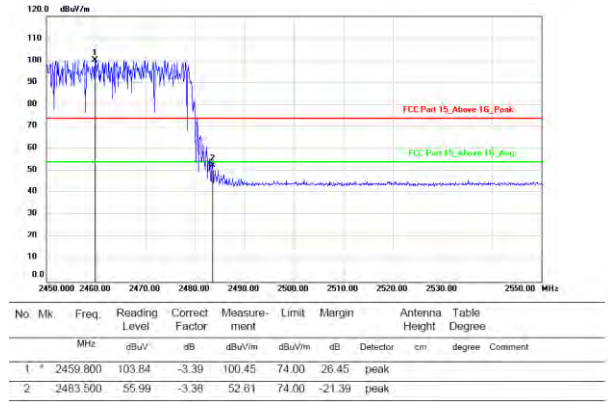

hopping-on

Polarization: Horizontal

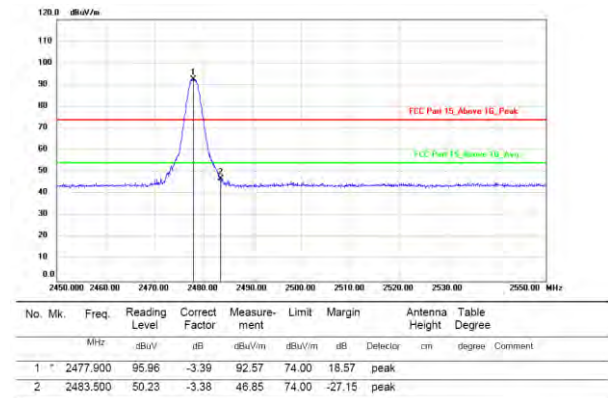

hopping-off

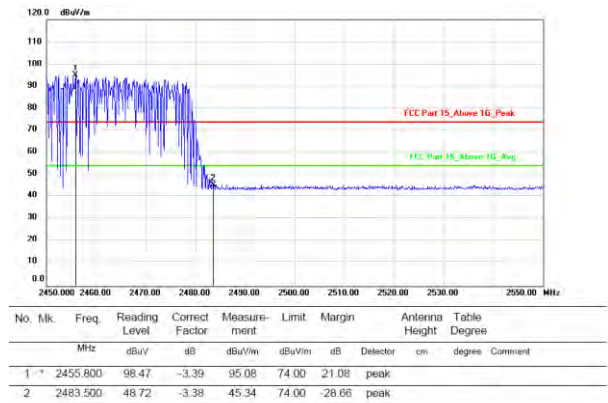

hopping-on

Test Mode: GFSK-Low (2413MHz)

Polarization: Vertical

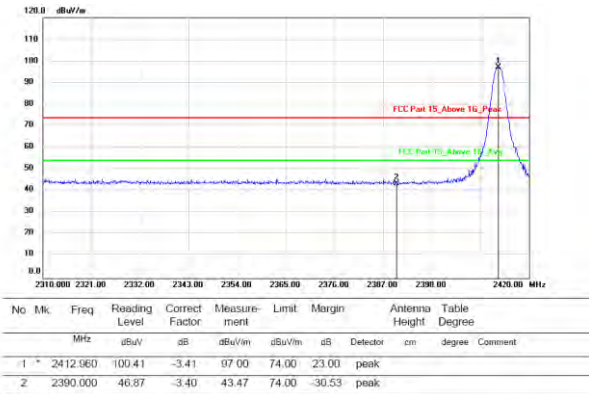

hopping-off

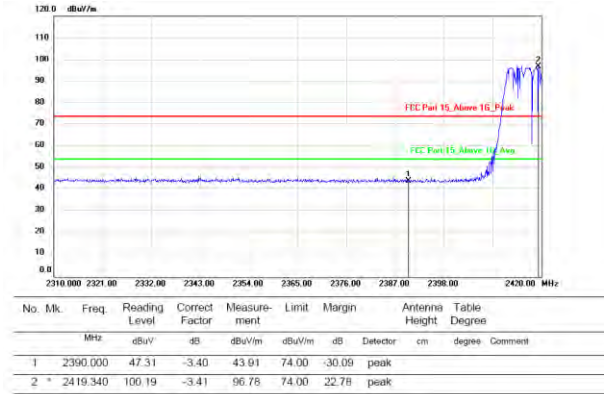

hopping-on

Polarization: Horizontal

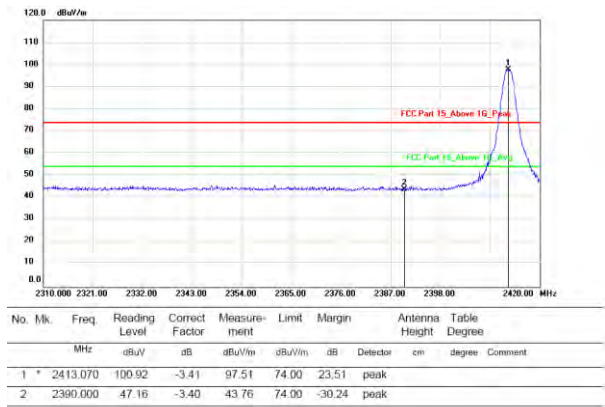

hopping-off

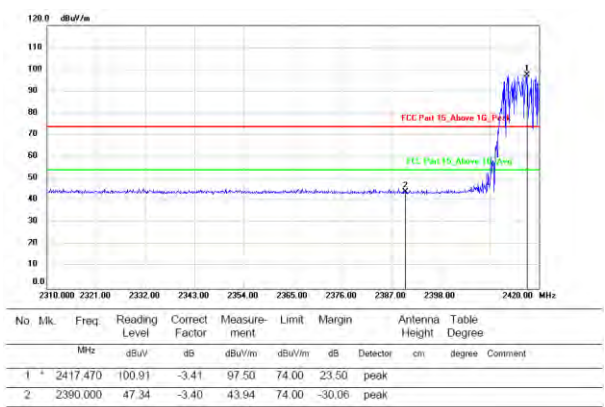

hopping-on

Test Mode: GFSK-High (2479MHz)

Polarization: Vertical

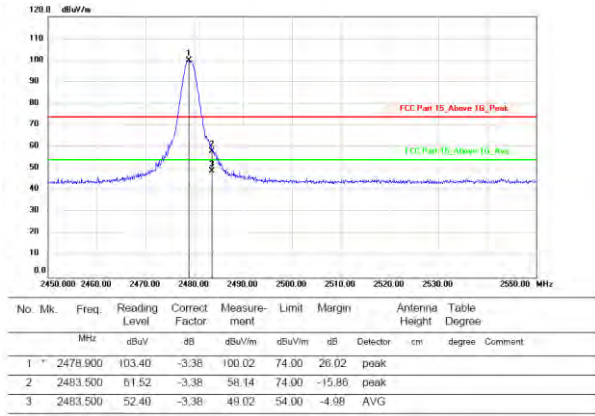

hopping-off

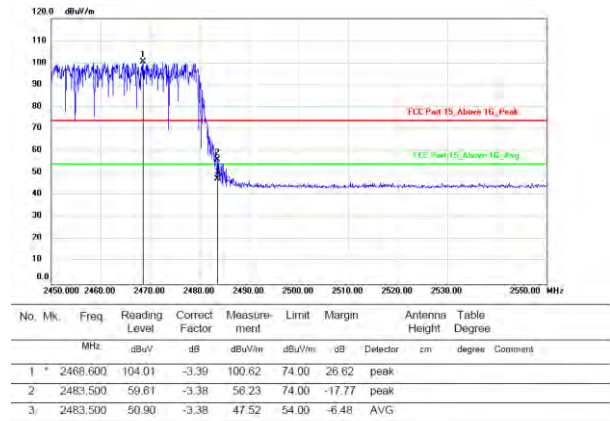

hopping-on

Polarization: Horizontal

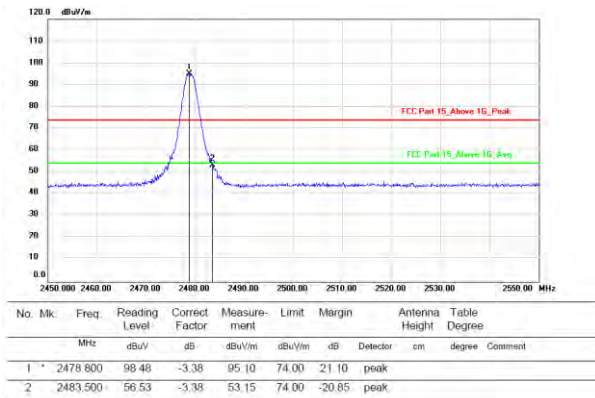

hopping-off

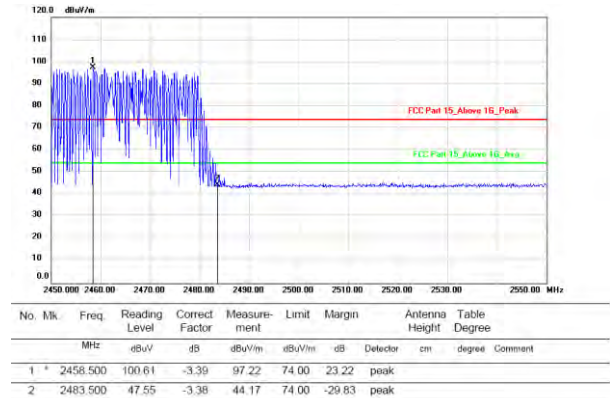

hopping-on

Test Mode: GFSK-Low (2410MHz)

Polarization: Vertical

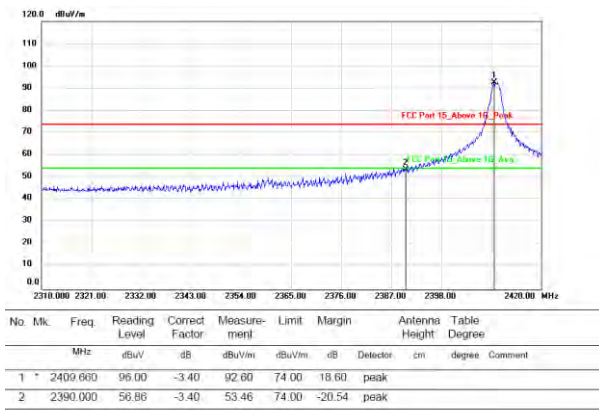

hopping-off

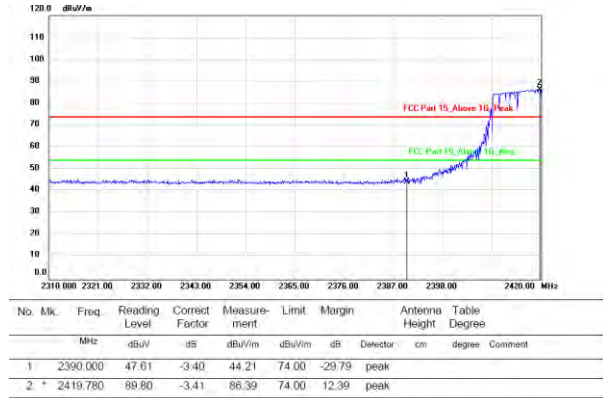

hopping-on

Polarization: Horizontal

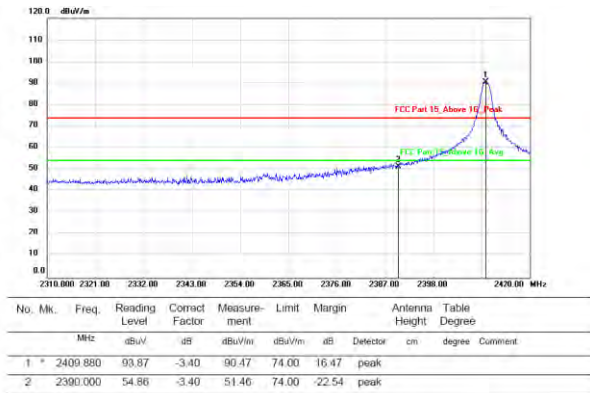

hopping-off

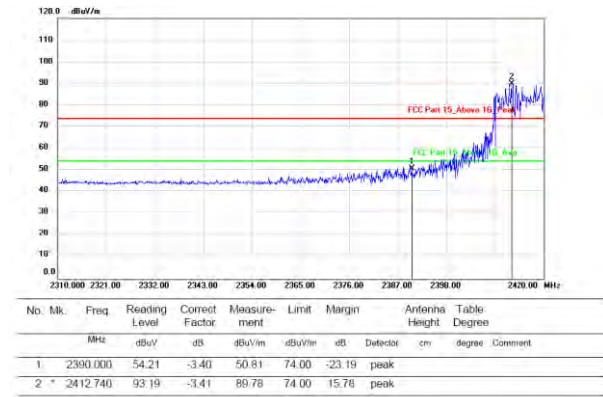

hopping-on

Test Mode: GFSK-High (2465MHz)

Polarization: Vertical

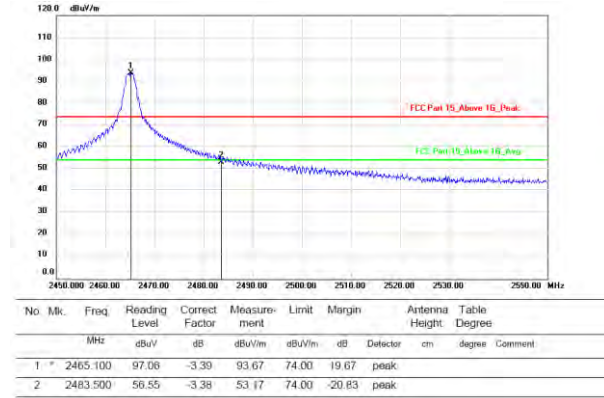

hopping-off

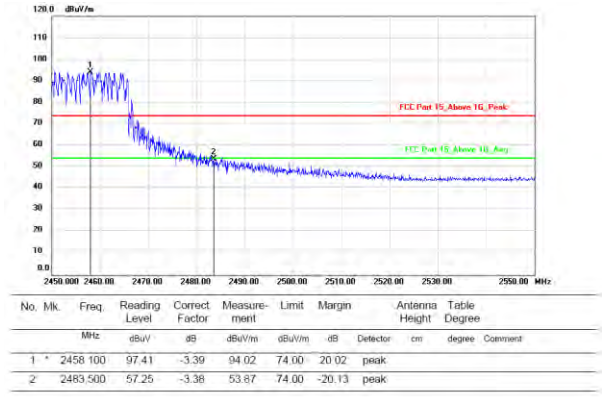

hopping-on

Polarization: Horizontal

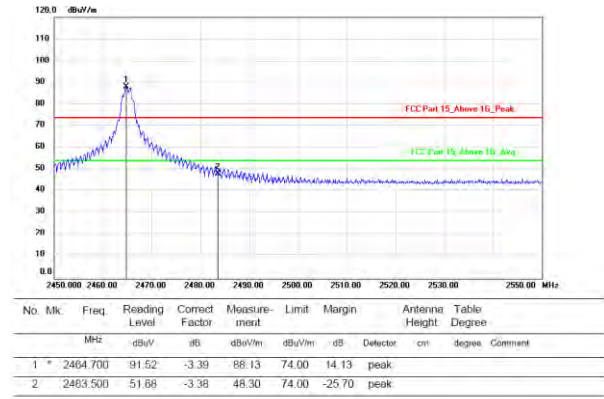

hopping-off

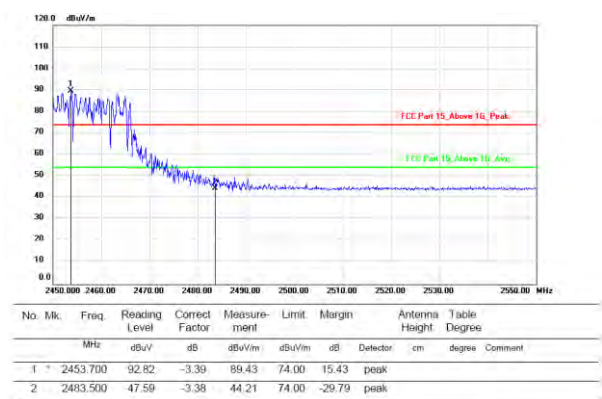

hopping-on

Test Mode: GFSK-Low (2401MHz)

Polarization: Vertical

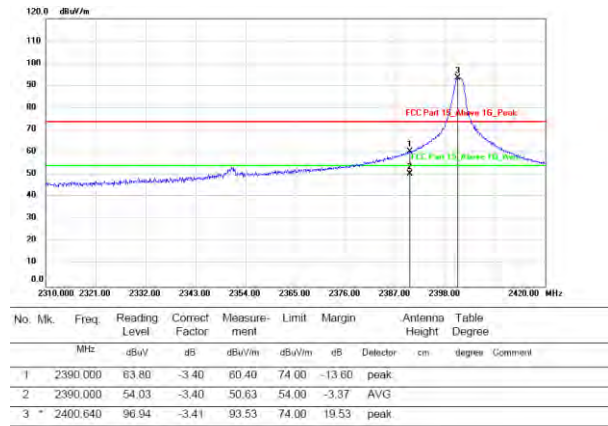

hopping-off

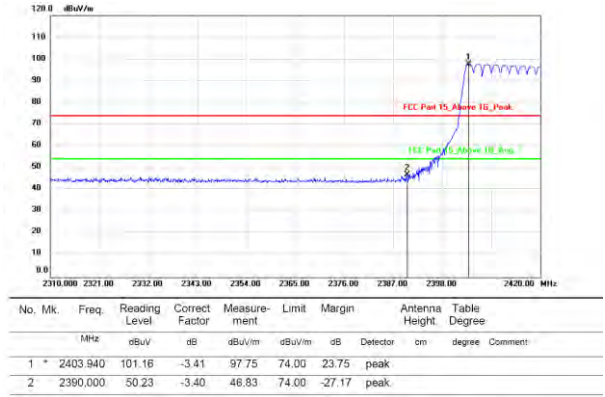

hopping-on

Polarization: Horizontal

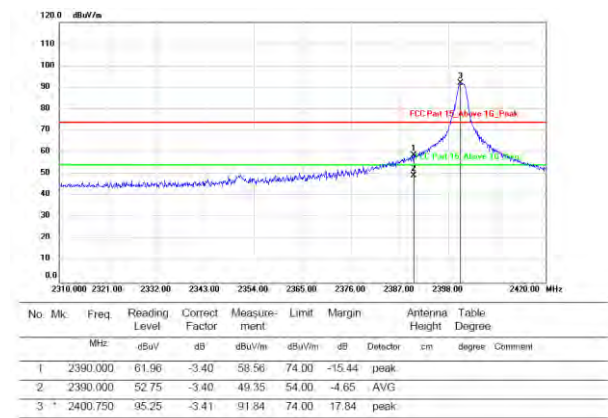

hopping-off

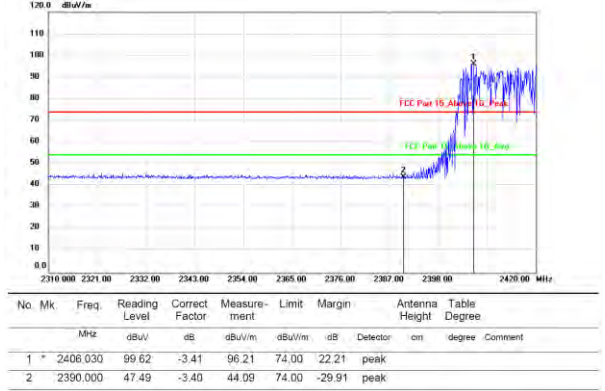

hopping-on

Test Mode: GFSK-High (2467MHz)

Polarization: Vertical

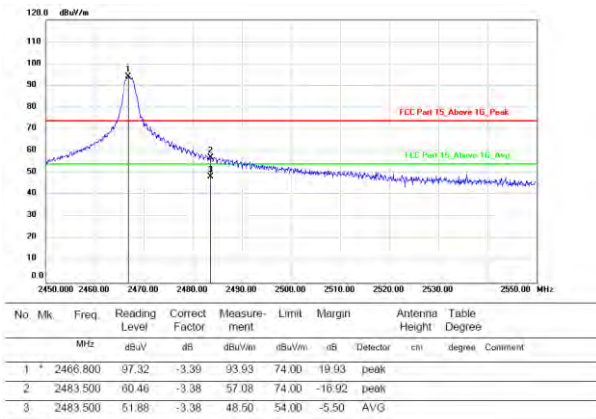

hopping-off

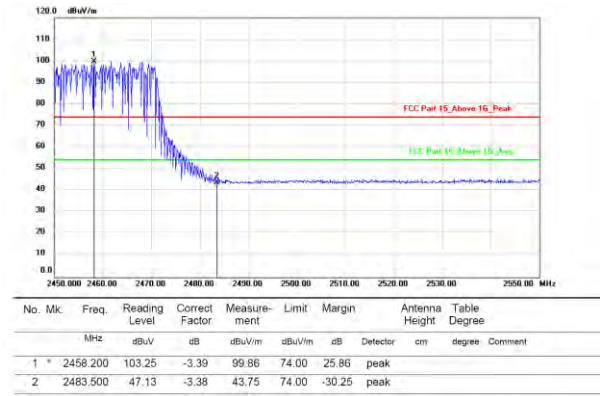

hopping-on

Polarization: Horizontal

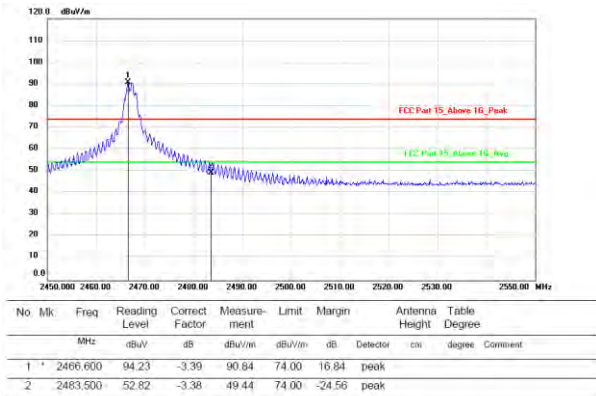

hopping-off

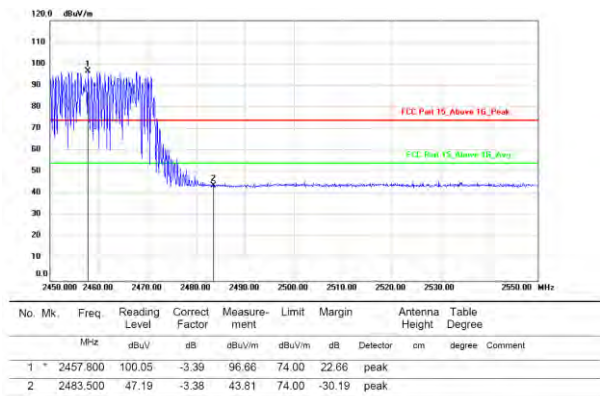

hopping-on

Note: 1. \*:Maximum data; x:Over limit; !:over margin.

2.Measurement=Reading Level+Correct Factor; Correct Factor=Antenna Factor+Cable Loss.

Conducted Method

**GFSK Mode:**

2404-2470 MHz:

Test channel:

Lowest channel

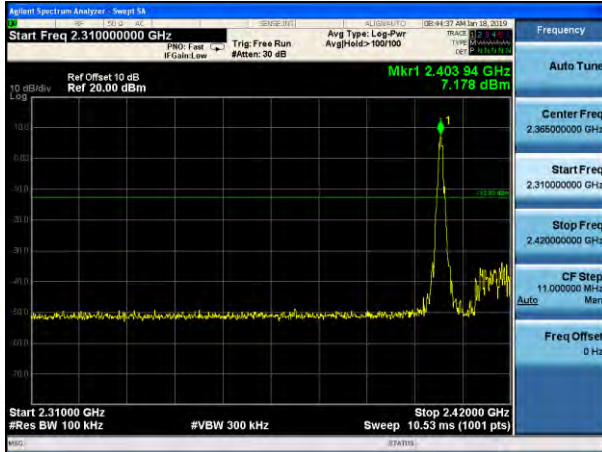

Hopping-off mode

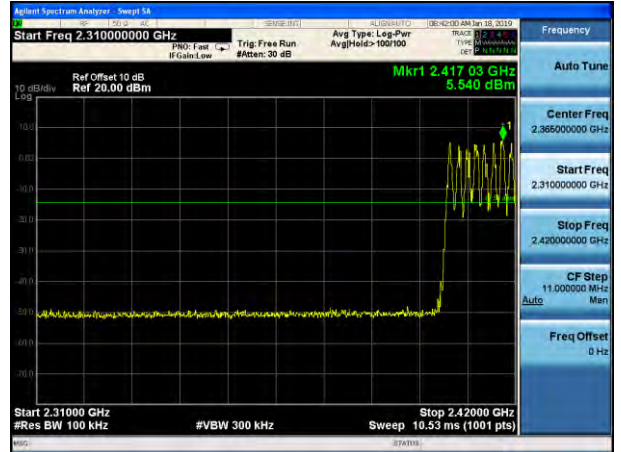

Hopping-on mode

Test channel:

Highest channel

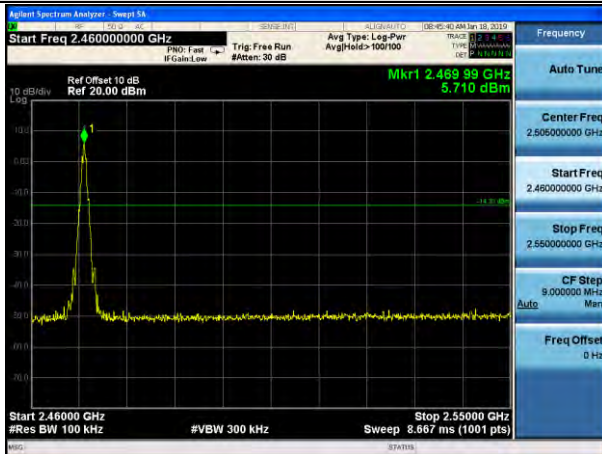

Hopping-off mode



Hopping-on mode



2405-2471 MHz:

Test channel:

Lowest channel

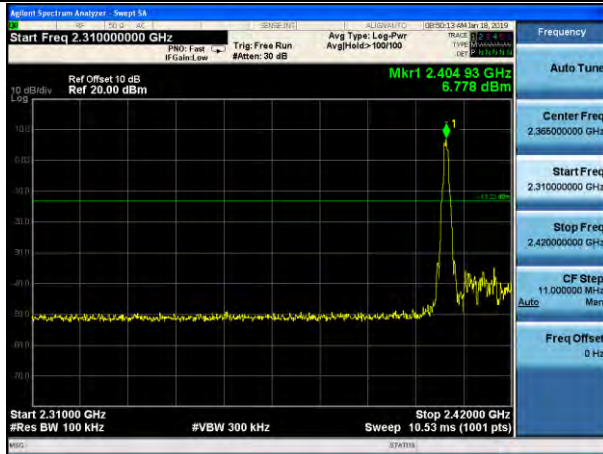

Hopping-off mode



Hopping-on mode

Test channel:

Highest channel

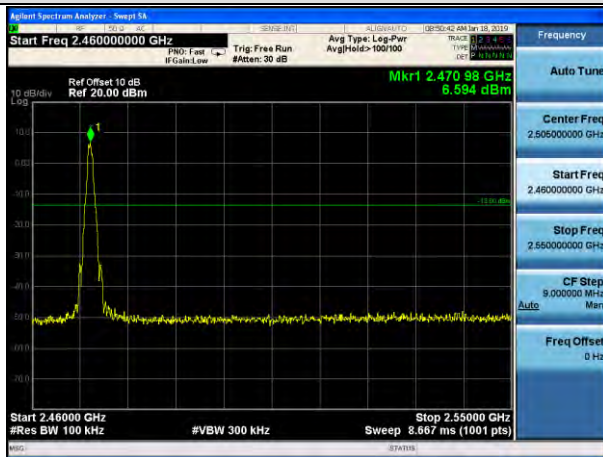

Hopping-off mode



Hopping-on mode

2412-2478 MHz:

Test channel:

Lowest channel

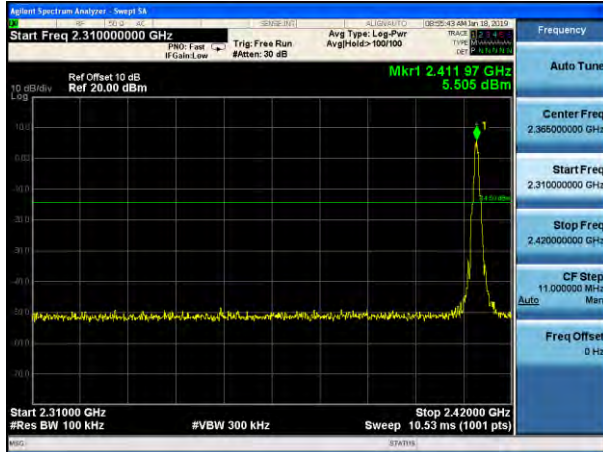

Hopping-off mode



Hopping-on mode

Test channel:

Highest channel



Hopping-off mode

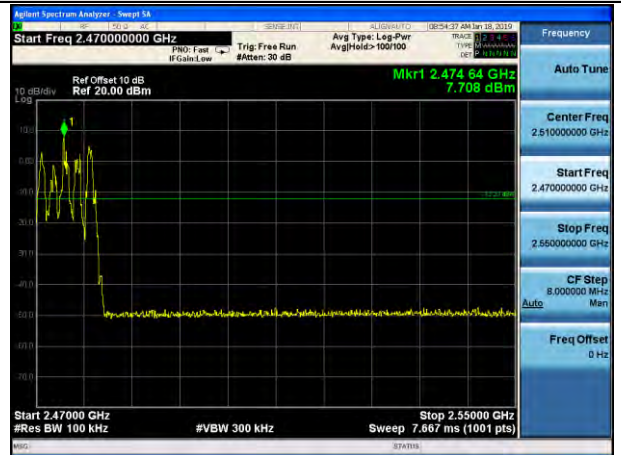

Hopping-on mode

2413-2479 MHz:

Test channel: Lowest channel



Hopping-off mode

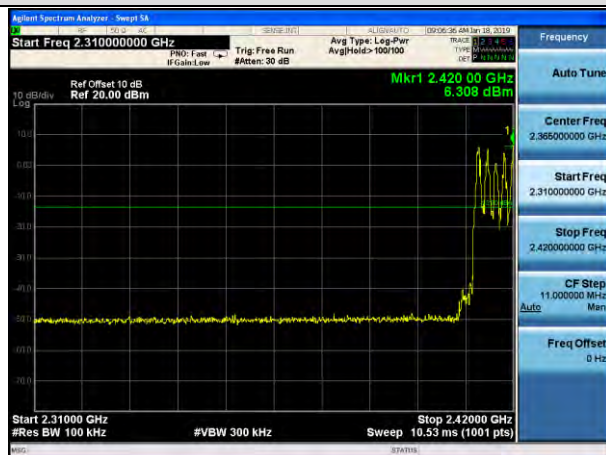

Hopping-on mode

Test channel: Highest channel

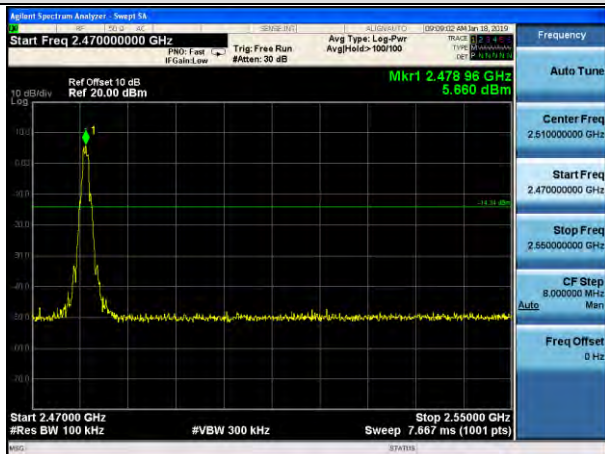

Hopping-off mode

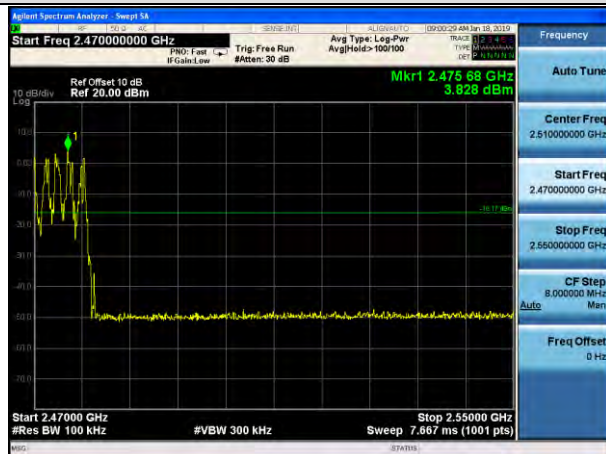

Hopping-on mode

2410-2465MHz:

Test channel:

Lowest channel

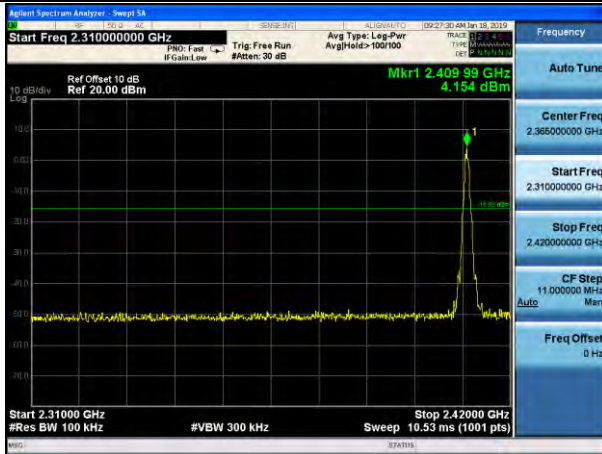

Hopping-off mode

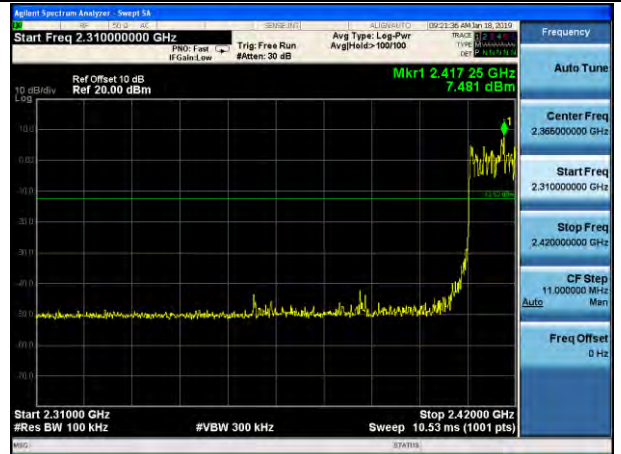

Hopping-on mode

Test channel:

Highest channel

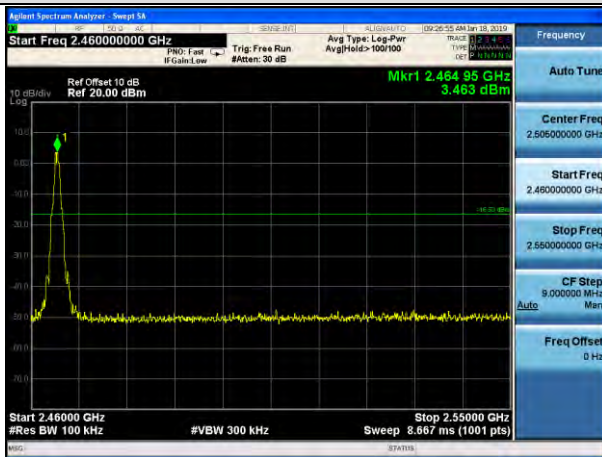

Hopping-off mode

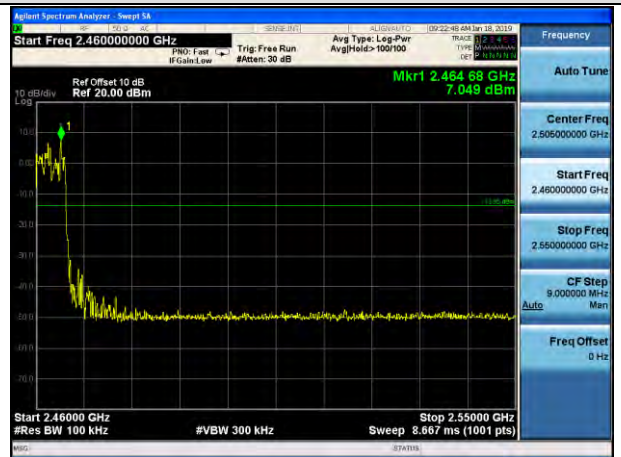

Hopping-on mode

2401-2467MHz:

Test channel:

Lowest channel

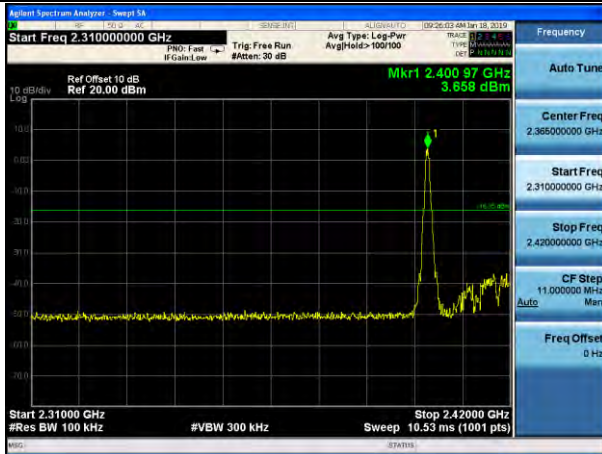

Hopping-off mode

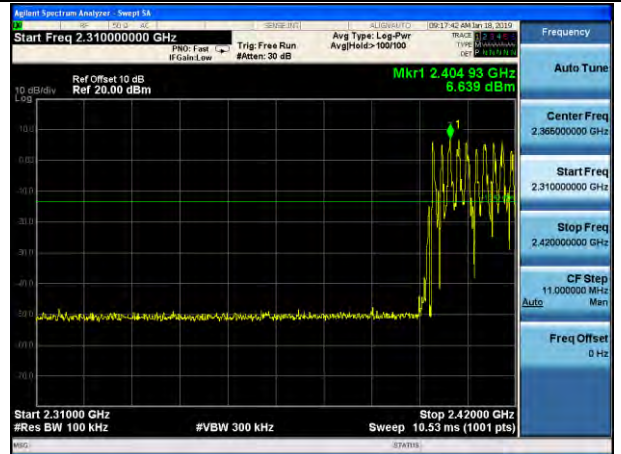

Hopping-on mode

Test channel:

Highest channel

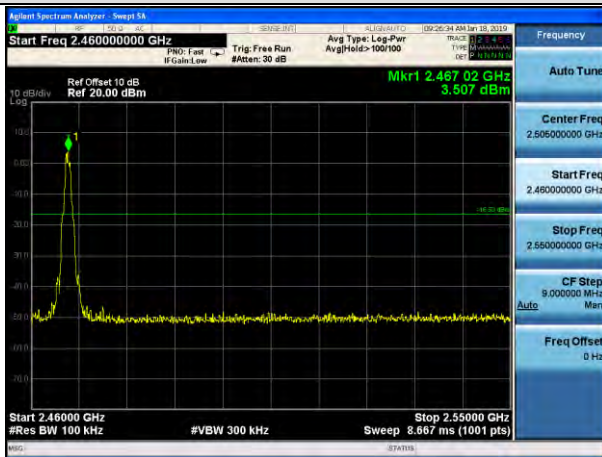

Hopping-off mode



Hopping-on mode

## 10. POWER LINE CONDUCTED EMISSIONS

### 10.1. Block Diagram of Test Setup

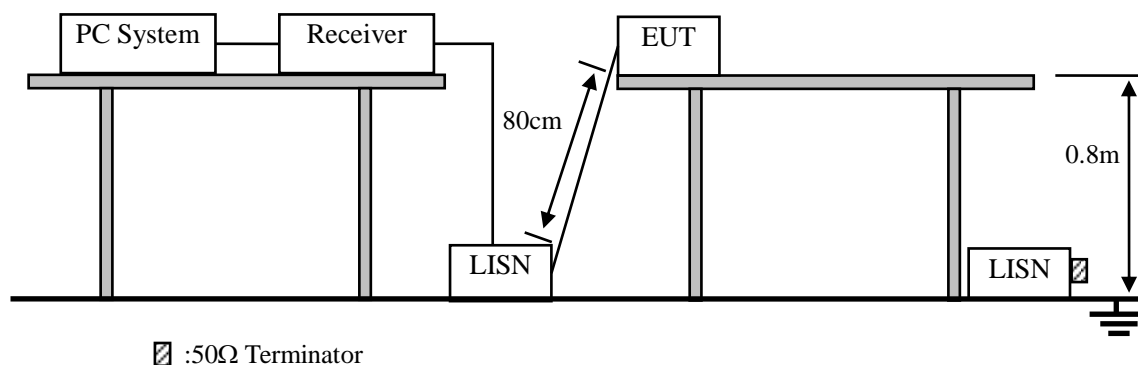

### 10.2. Limit

Frequency	Maximum RF Line Voltage	
	Quasi-Peak Level dB(μV)	Average Level dB(μV)
150kHz ~ 500kHz	66 ~ 56*	56 ~ 46*
500kHz ~ 5MHz	56	46
5MHz ~ 30MHz	60	50

Notes: 1. \* Decreasing linearly with logarithm of frequency.

2. The lower limit shall apply at the transition frequencies.

### 10.3. Test Procedure

- (1) The EUT was placed on a non-metallic table, 80cm above the ground plane.
- (2) Setup the EUT and simulator as shown in 10.1
- (3) The EUT Power connected to the power mains through a power adapter and a line impedance stabilization network (L.I.S.N1). The other peripheral devices power cord connected to the power mains through a line impedance stabilization network (L.I.S.N2), this provided a 50-ohm coupling impedance for the EUT (Please refer to the block diagram of the test setup and photographs). Both sides of power line were checked for maximum conducted interference. In order to find the maximum emission, the relative positions of equipments and all of the interface cables were changed according to ANSI C63.10 :2013on conducted Emission test.
- (4) The bandwidth of test receiver is set at 10KHz.
- (5) The frequency range from 150 KHz to 30MHz is checked.

### 10.4. Test Result

PASS. (See below detailed test data)

Note: If peak Result comply with AV limit, QP and AV Result is deemed to comply with AV limit

Line:

Conducted Emission Measurement

File :T1890004 01 CE

Data :#3

Date: 2019-1-3

Time: 14:42:38

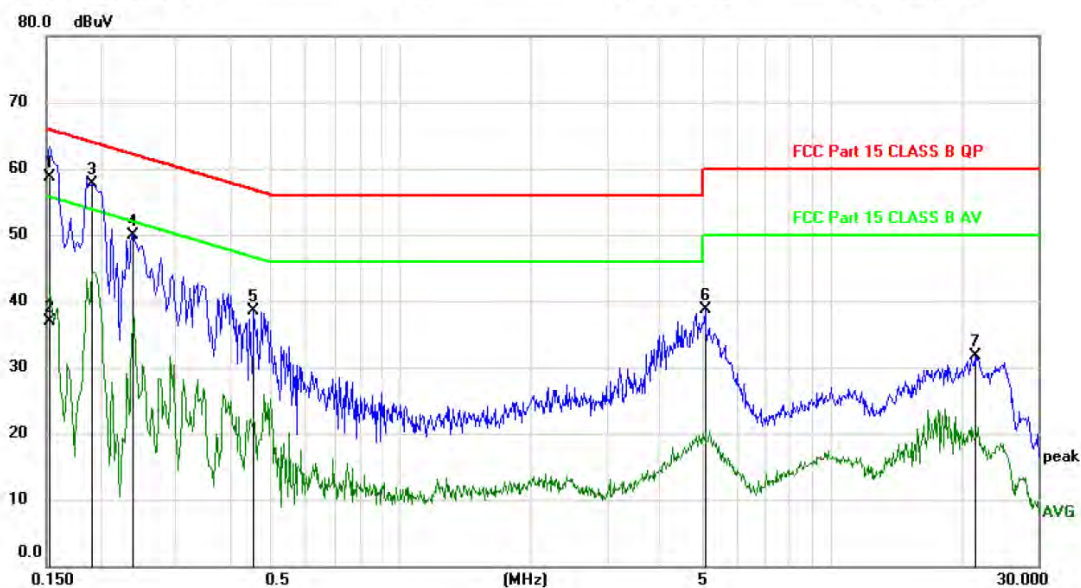

No.	Mk.	Freq. MHz	Reading Level dBuV	Correct Factor dB	Measure- ment dBuV	Limit dBuV	Margin dB	Detector	Comment
1		0.1530	48.88	9.73	58.61	65.84	-7.23	QP	
2		0.1530	27.27	9.73	37.00	55.84	-18.84	AVG	
3	*	0.1920	47.89	9.74	57.63	63.95	-6.32	peak	
4		0.2378	40.19	9.75	49.94	62.17	-12.23	peak	
5		0.4560	28.79	9.78	38.57	56.77	-18.20	peak	
6		5.0820	28.51	10.19	38.70	60.00	-21.30	peak	
7		21.4410	21.11	10.57	31.68	60.00	-28.32	peak	

\*:Maximum data x:Over limit !:over margin

Note: Measurement=Reading Level+Correc Factor. Factor=(LISN or ISN or PLC or Current Probe)Factor+Cable

Neutral:

Conducted Emission Measurement

File :T1890004 01 CE

Data :#4

Date: 2019-1-3

Time: 14:45:08

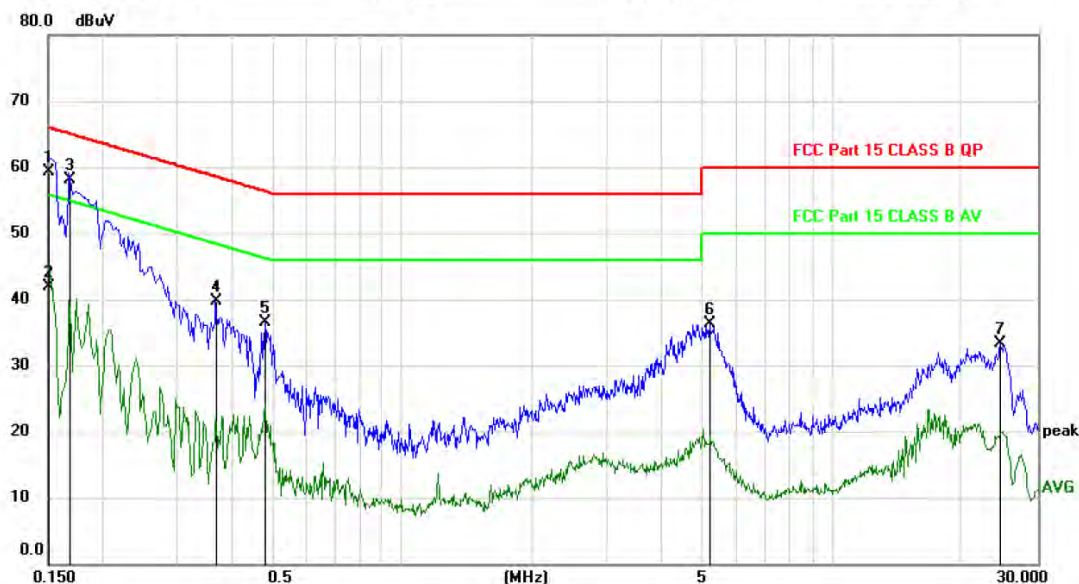

No.	Mk.	Freq. MHz	Reading Level dBuV	Correct Factor dB	Measure- ment dBuV	Limit dBuV	Margin dB	Detector	Comment
1	*	0.1500	49.49	9.73	59.22	66.00	-6.78	QP	
2		0.1500	32.22	9.73	41.95	56.00	-14.05	AVG	
3		0.1685	48.38	9.73	58.11	65.03	-6.92	peak	
4		0.3690	29.88	9.77	39.65	58.52	-18.87	peak	
5		0.4800	26.73	9.78	36.51	56.34	-19.83	peak	
6		5.1779	26.01	10.20	36.21	60.00	-23.79	peak	
7		24.6240	22.58	10.76	33.34	60.00	-26.66	peak	

\*:Maximum data x:Over limit !:over margin

Note: Measurement=Reading Level+Correc Factor. Factor=(LISN or ISN or PLC or Current Probe)Factor+Cable

Remark: All modes have been tested, and only worst data of Channel 2438MHz (2404-2470MHz; AC 120V/60Hz) was listed in this report.



## **11. ANTENNA REQUIREMENTS**

### **11.1. Limit**

For intentional device, according to FCC 47 CFR Section 15.203, an intentional radiator shall be designed to ensure that no antenna other than that furnished by the responsible party shall be used with the device. And according to FCC 47 CFR Section 15.247 (b), if transmitting antennas of directional gain greater than 6dBi are used, the power shall be reduced by the amount in dB that the directional gain of the antenna exceeds 6dBi.

### **11.2. Result**

The EUT antenna is PIFA Antenna. It complies with the standard requirement.

Antenna connector type: ipex connector.

## 12. TEST SETUP PHOTO

### 12.1.Photos of Radiated emission

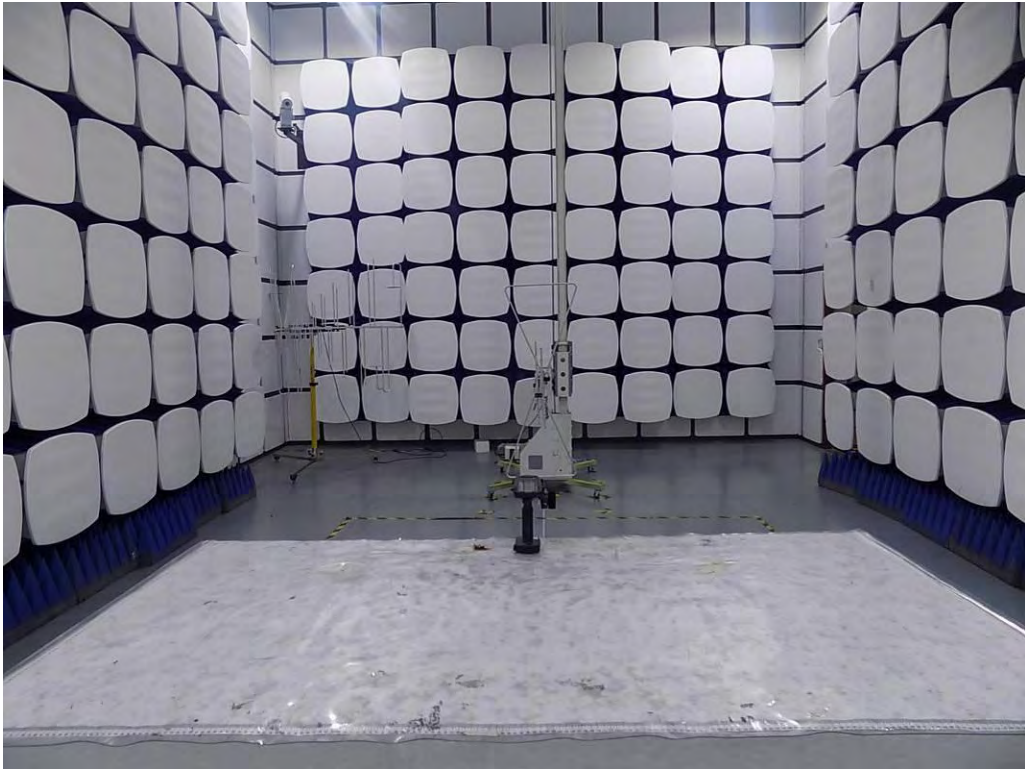

## 12.2.Photos of Conducted Emission test



## **13.PHOTOS OF THE EUT**

Please refer to separated files for External Photos & Internal Photos of the EUT.

----END OF REPORT----