



TEST REPORT

FCC ID: L73-92801

IC:7377A-92801

Applicant : Sanwa Electronic Instrument Co., Ltd
Address : 1-2-50, Yoshida Honmachi, Higashi-Osaka, Osaka 578-0982, Japan

Equipment Under Test (EUT):

Name : 2.4GHz Electronic Speed Controller
Model : 92801

In Accordance with: FCC PART 15, SUBPART C : 2014 (Section 15.247)&
IC RSS-210 ISSUE 8 with amendment June 2010
RSS-Gen Issue 4, ANSI C63.4:2014, CISPR 16-1-4:2010

Report No : T1850063 05
Date of Test : January 26- March 13, 2015
Date of Issue : March 13, 2015
Test Result : PASS

In the configuration tested, the EUT complied with the standards specified above

Authorized Signature



(Simple Guan)

Engineering Manager

The manufacture should ensure that all the products in series production are in conformity with the product sample detailed in this report. If the product in this report is used in any configuration other than that detailed in the report, the manufacturer must ensure the new system complies with all relevant standards. Any mention of Alpha Product Testing Laboratory or test done by Alpha Product Testing Laboratory Approvals in connection with, distribution or use of the product described in this report must be approved by Alpha Product Testing Laboratory Approvals in writing.

Contents

1. General Information	4
1.1. Description of Device (EUT)	4
1.2. Accessories of device (EUT)	4
1.3. Test Lab information	5
2. Summary of test	6
2.1. Summary of test result	6
2.2. Assistant equipment used for test.....	6
2.3. Block Diagram	7
2.4. Test mode	7
2.5. Test Conditions.....	8
2.6. Measurement Uncertainty (95% confidence levels, k=2).....	8
2.7. Test Equipment.....	9
3. Maximum Peak Output power	10
3.1. Limit.....	10
3.2. Test Procedure	10
3.3. Test Setup	10
3.4. Test Result.....	10
4. Bandwidth	11
4.1. Limit.....	11
4.2. Test Procedure	11
4.3. Test Result.....	11
5. Carrier Frequency Separation	14
5.1. Limit.....	14
5.2. Test Procedure	14
5.3. Test Result.....	14
6. Number Of Hopping Channel	16
6.1. Limit.....	16
6.2. Test Procedure	16
6.3. Test Result.....	16
7. Dwell Time	18
7.1. Test limit	18
7.2. Test Procedure.....	18
7.3. Test Results	18
8. Radiated emissions	21
8.1. Limit.....	21
8.2. Block Diagram of Test setup.....	22
8.3. Test Procedure	22
8.4. Test Result.....	23
9. Band Edge Compliance	29
9.1. Block Diagram of Test Setup	29
9.2. Limit.....	29
9.3. Test Procedure	29

9.4. Test Result.....	29
10. Power Line Conducted Emissions	34
10.1. Block Diagram of Test Setup	34
10.2. Limit.....	34
10.3. Test Procedure.....	34
10.4. Test Result.....	34
11. Antenna Requirements.....	35
11.1. Limit.....	35
11.2. Result.....	35
12. Test setup photo	36
12.1. Photos of Radiated emission	36
13. Photos of EUT	37

1. General Information

1.1. Description of Device (EUT)

EUT	: 2.4GHz Electronic Speed Controller
Model No.	: 92801
DIFF.	: N/A
Trade mark	: SANWA
Power supply	: DC 6V from battery
Operation frequency	: 2403-2478MHz
Modulation	: FHSS
Channel number	: 76
Channel spacing	: 1MHz
Antenna Type	: Integrate Antenna, max gain 3.14dBi
Applicant	: Sanwa Electronic Instrument Co., Ltd
Address	: 1-2-50, Yoshida Honmachi, Higashi-Osaka, Osaka 578-0982, Japan
Applicant	: Dongguan Dongkeng Sanwa Electro Device Factory
Address	: Qiaolian Industrial District, Erhuan St., Dongkeng Town, Dongguan City, Guangdong, P.R.China

1.2. Accessories of device (EUT)

Accessories 1	: N/A
Type	: N/A

1.3. Test Lab information

Alpha Product Testing Laboratory
Building B, East Area of Nanchang Second, Industrial Zone, Gushu 2nd Road,
Bao'an, Shenzhen, China

August 11, 2014 File on Federal Communication Commission
Registration Number: 203110

July 18, 2014 Certificated by IC
Registration Number: 12135A

2. Summary of test

2.1. Summary of test result

Description of Test Item	Standard	Results
Maximum Peak Output Power	FCC Part 15: 15.247 IC RSS-210 A8	PASS
Bandwidth	FCC Part 15: 15.215 IC RSS-210 A8	PASS
Carrier Frequency Separation	FCC Part 15: 15.247 IC RSS-210 A8	PASS
Number Of Hopping Channel	FCC Part 15: 15.247 IC RSS-210 A8	PASS
Dwell Time	FCC Part 15: 15.247 IC RSS-210 A8	PASS
Radiated Emission	FCC Part 15: 15.209 FCC Part 15: 15.247 IC RSS-210 A8	PASS
Band Edge Compliance	FCC Part 15: 15.247 IC RSS-210 A8	PASS
Power Line Conducted Emissions	FCC Part 15: 15.207 IC RSS Gen Issue 4 8.8	N/A
Antenna requirement	FCC Part 15: 15.203	PASS
Note: 1 N/A is not applicable. 2 EUT power supply by battery, so Power Line Conducted Emissions test not applicable.		

2.2. Assistant equipment used for test

Description	:	N/A
Manufacturer	:	N/A
Model No.	:	N/A

2.3. Block Diagram

For radiated emissions test: EUT was placed on a turn table, which is 0.8 meter high above ground. EUT was be set into FHSS test mode by adb.exe software before test.

EUT

2.4. Test mode

The test was used to control EUT work in Continuous TX mode, and select test channel, wireless mode

Tested mode, channel, and data rate information		
Mode	Channel	Frequency (MHz)
FHSS	Low :CH1	2403
	Middle: CH40	2442
	High: CH76	2478

FH3 Channel list							
CH1	2403MHz	CH20	2422MHz	CH39	2441MHz	CH58	2460MHz
CH2	2404MHz	CH21	2423MHz	CH40	2442MHz	CH59	2461MHz
CH3	2405MHz	CH22	2424MHz	CH41	2443MHz	CH60	2462MHz
CH4	2406MHz	CH23	2425MHz	CH42	2444MHz	CH61	2463MHz
CH5	2407MHz	CH24	2426MHz	CH43	2445MHz	CH62	2464MHz
CH6	2408MHz	CH25	2427MHz	CH44	2446MHz	CH63	2465MHz
CH7	2409MHz	CH26	2428MHz	CH45	2447MHz	CH64	2466MHz
CH8	2410MHz	CH27	2429MHz	CH46	2448MHz	CH65	2467MHz
CH9	2411MHz	CH28	2430MHz	CH47	2449MHz	CH66	2468MHz
CH10	2412MHz	CH29	2431MHz	CH48	2450MHz	CH67	2469MHz
CH11	2413MHz	CH30	2432MHz	CH49	2451MHz	CH68	2470MHz
CH12	2414MHz	CH31	2433MHz	CH50	2452MHz	CH69	2471MHz
CH13	2415MHz	CH32	2434MHz	CH51	2453MHz	CH70	2472MHz
CH14	2416MHz	CH33	2435MHz	CH52	2454MHz	CH71	2473MHz
CH15	2417MHz	CH34	2436MHz	CH53	2455MHz	CH72	2474MHz
CH16	2418MHz	CH35	2437MHz	CH54	2456MHz	CH73	2475MHz
CH17	2419MHz	CH36	2438MHz	CH55	2457MHz	CH74	2476MHz
CH18	2420MHz	CH37	2439MHz	CH56	2458MHz	CH75	2477MHz
CH19	2421MHz	CH38	2440MHz	CH57	2459MHz	CH76	2478MHz

2.5. Test Conditions

Temperature range	21-25 °C
Humidity range	40-75%
Pressure range	86-106kPa

2.6. Measurement Uncertainty (95% confidence levels, k=2)

Item	MU	Remark
Uncertainty for Power point Conducted Emissions Test	2.70dB	
Uncertainty for Radiation Emission test in 3m chamber (30MHz to 1GHz)	3.90 dB	Polarize: V
	3.92dB	Polarize: H
Uncertainty for Radiation Emission test in 3m chamber (1GHz to 25GHz)	4.26 dB	Polarize: H
	4.28 dB	Polarize: V
Uncertainty for conducted RF Power	0.16dB	

2.7. Test Equipment

Equipment	Manufacture	Model No.	Serial No.	Cal. Due day	Cal Interval
3m Semi-Anechoic	ETS-LINDGREN	N/A	SEL0017	2016.01.18	1 Year
Spectrum analyzer	Agilent	E4407B	MY49510055	2016.01.18	1 Year
Receiver	R&S	ESCI	101165	2016.01.18	1 Year
Bilog Antenna	SCHWARZBECK	VULB 9168	9168-438	2016.01.21	2 Year
Horn Antenna	SCHWARZBECK	BBHA 9120 D	BBHA 9120 D(1201)	2016.01.21	2 Year
Horn Antenna	SCHWARZBECK	BBHA 9170	BBHA 9170 D(1432)	2016.01.21	2 Year
Active Loop Antenna	Beijing Daze	ZN30900A	SEL0097	2016.01.21	1 Year
Cable	Resenberger	SUCOFLEX 104	MY6562/4	2016.01.18	1 Year
Cable	Resenberger	SUCOFLEX 104	309972/4	2016.01.18	1 Year
Cable	Resenberger	SUCOFLEX 104	329112/4	2016.01.18	1 Year
Power Meter	Anritsu	ML2487A	6K00001491	2016.01.18	1 Year
Power sensor	Anritsu	ML2491A	32516	2016.01.18	1 Year
Pre-amplifier	SCHWARZBECK	BBV9743	9743-019	2016.01.18	1 Year
Pre-amplifier	Quietek	AP-180C	CHM-0602012	2016.01.18	1 Year
Test Receiver	Rohde & Schwarz	ESCI	101165	2016.01.18	1 Year
L.I.S.N.#1	Schwarzbeck	NSLK8126	8126466	2016.01.18	1 Year
L.I.S.N.#2	ROHDE&SCHWARZ	ENV216	101043	2016.01.18	1 Year

3. Maximum Peak Output power

3.1. Limit

Please refer section 15.247 and RSS-210 issue 8, §A8.4 (2).

For frequency hopping systems operating in the 2400-2483.5 MHz band employing at least 75 non-overlapping hopping channels, and all frequency hopping systems in the 5725-5850 MHz band: 1 watt. For all other frequency hopping systems in the 2400-2483.5 MHz band: 0.125 watts, the e.i.r.p shall not exceed 4W

3.2. Test Procedure

The transmitter output is connected to the RF Power Meter. The RF Power Meter is set to the peak power detection.

3.3. Test Setup

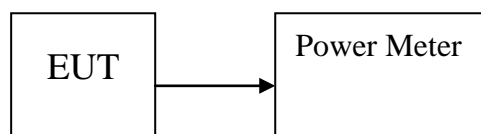

3.4. Test Result

EUT: 2.4GHz Electronic Speed Controller		M/N: 92801			
Test date: 2015-01-27		Test site: RF site		Tested by: Peter	
Mode	Freq (MHz)	PK Output Power (dBm)	PK Output Power (mW)	Limit (dBm)	Result
FHSS	2403	-2.49	0.56	21.00	Pass
	2442	2.65	1.84	21.00	Pass
	2478	1.42	1.39	21.00	Pass
Conclusion: PASS					

4. Bandwidth

4.1. Limit

Intentional radiators operating under the alternative provisions to the general emission limits, as contained in §§ 15.217 through 15.257 and in Subpart E of this part, must be designed to ensure that the 20 dB bandwidth of the emission, or whatever bandwidth may otherwise be specified in the specific rule section under which the equipment operates, is contained within the frequency band designated in the rule section under which the equipment is operated.

RSS-Gen §6.6, The transmitter shall be operated at its maximum carrier power measured under normal test conditions.

The span of the analyzer shall be set to capture all products of the modulation process, including the emission skirts.

The resolution bandwidth (RBW) shall be in the range of 1% to 5% of the occupied bandwidth (OBW) and video bandwidth (VBW) shall be approximately 3x RBW.

4.2. Test Procedure

The transmitter output was coupled to a spectrum analyzer via a antenna. The bandwidth of the fundamental frequency was measured by spectrum analyzer with 30kHz RBW and 100kHz VBW. The 20dB bandwidth is defined as the total spectrum the power of which is higher than peak power minus 20dB.

4.3. Test Result

EUT: 2.4GHz Electronic Speed Controller		M/N: 92801		
Test date: 2015-01-27		Test site: RF site		Tested by: Peter
Mode	Freq (MHz)	20dB Bandwidth (MHz)	Limit (kHz)	Conclusion
FHSS	2403	1.137	/	PASS
	2442	1.167	/	PASS
	2478	1.196	/	PASS

EUT: 2.4GHz Electronic Speed Controller		M/N: 92801		
Test date: 2015-01-28		Test site: RF site		Tested by: Peter
Mode	Freq (MHz)	99% Bandwidth (MHz)	Limit (kHz)	Conclusion
FHSS	2403	1.1102	/	PASS
	2442	1.1233	/	PASS
	2478	1.1844	/	PASS

Original Test data:

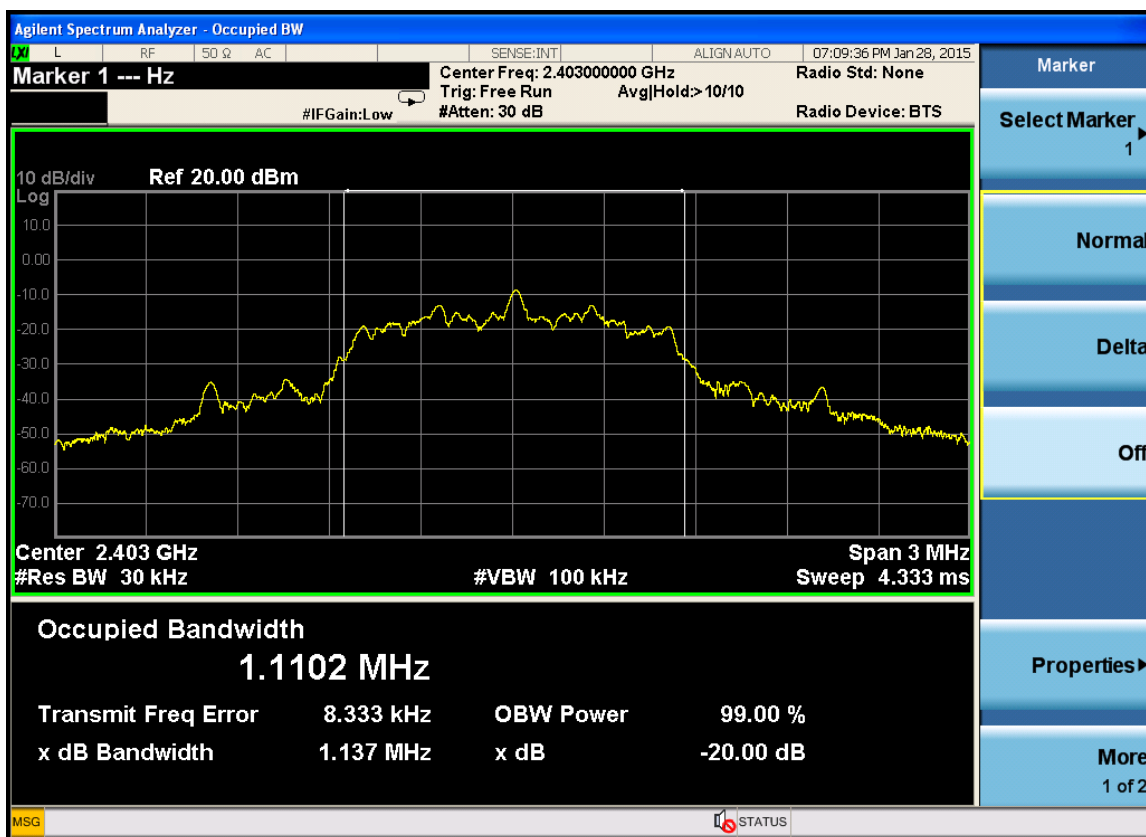

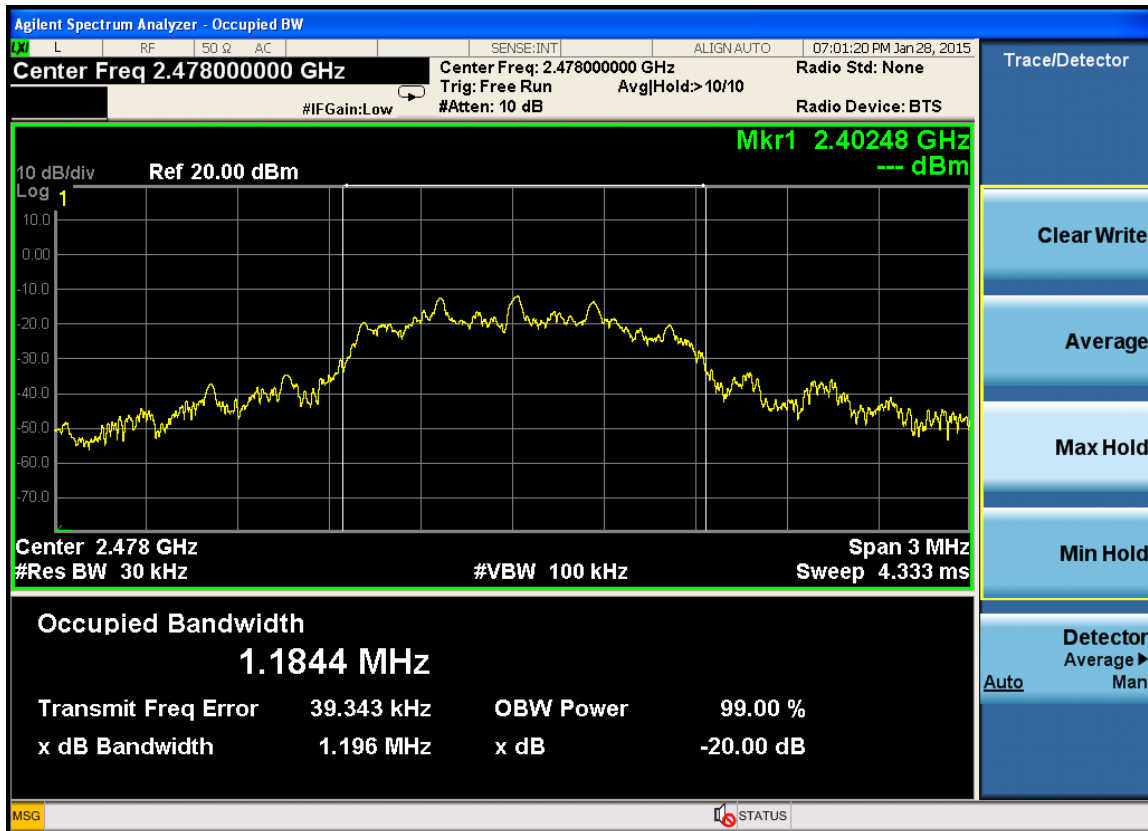
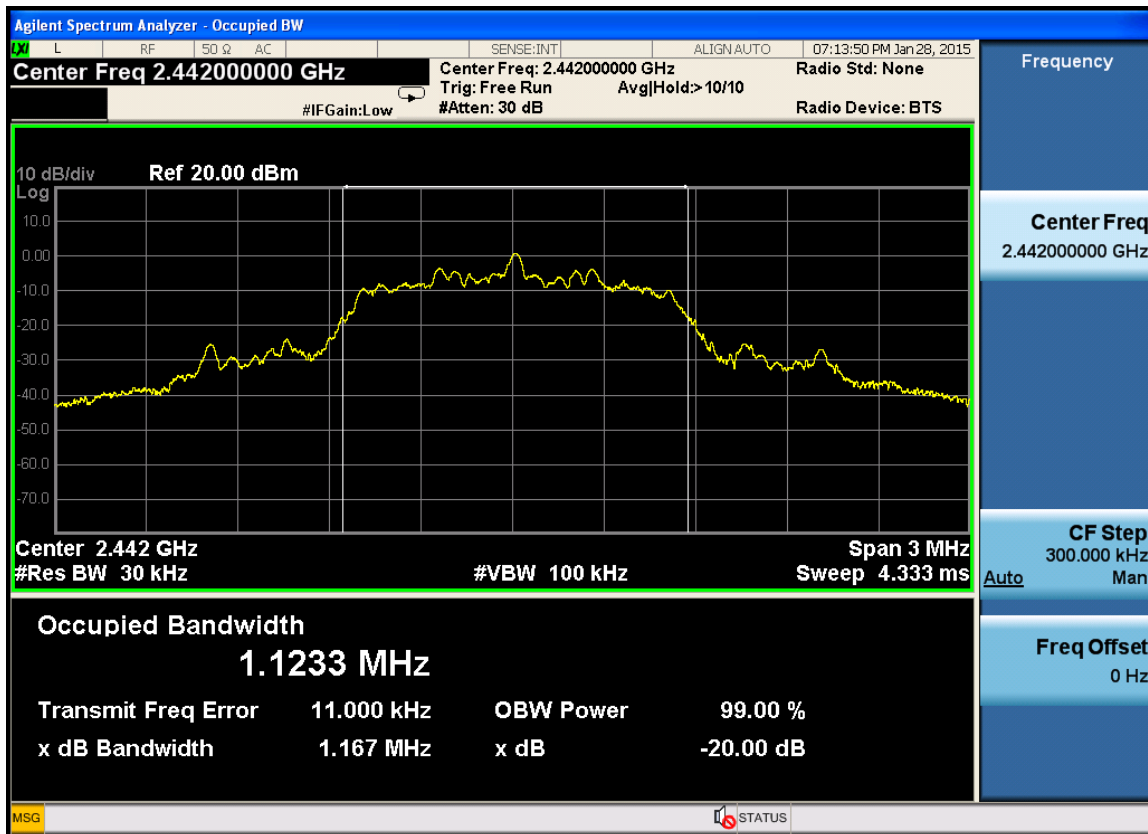

5. Carrier Frequency Separation

5.1. Limit

Please refer section 15.247 a(1) and RSS-210 issue 8, §A8.1 (b):

Frequency hopping systems shall have hopping channel carrier frequencies separated by a minimum of 25 kHz or the 20 dB bandwidth of the hopping channel, whichever is greater. Alternatively, frequency hopping systems operating in the 2400-2483.5 MHz band may have hopping channel carrier frequencies that are separated by 25 kHz or two-thirds of the 20 dB bandwidth of the hopping channel, whichever is greater, provided the systems operate with an output power no greater than 125 mW

5.2. Test Procedure

The transmitter output was coupled to a spectrum analyzer via an antenna. The carrier frequency was measured by spectrum analyzer with 30kHz RBW and 100kHz VBW.

5.3. Test Result

EUT: 2.4GHz Electronic Speed Controller M/N: 92801				
Test date: 2015-03-13		Test site: RF site		Tested by: Simple
Mode/Channel	Channel separation (MHz)	20dB Bandwidth (MHz)	Limit (MHz) 2/3 20dB bandwidth	Conclusion
FHSS	0.996	1.196	0.80	PASS

Original test data for channel separation



6. Number Of Hopping Channel

6.1. Limit

Please refer section 15.247 a(1) and RSS-210 issue 8, §A8.1 (d):
Frequency hopping systems in the 2400-2483.5 MHz band shall use at least 15 channels

6.2. Test Procedure

The transmitter output was coupled to a spectrum analyzer via an antenna. The number of hopping channels was measured by spectrum analyzer with 100kHz RBW and 300kHz VBW.

6.3. Test Result

EUT: 2.4GHz Electronic Speed Controller M/N: 92801			
Test date: 2015-01-27		Test site: RF site	Tested by: Peter
Mode	Number of hopping channel	Limit	Conclusion
FHSS	76	>15	PASS

Original test data for hopping channel number

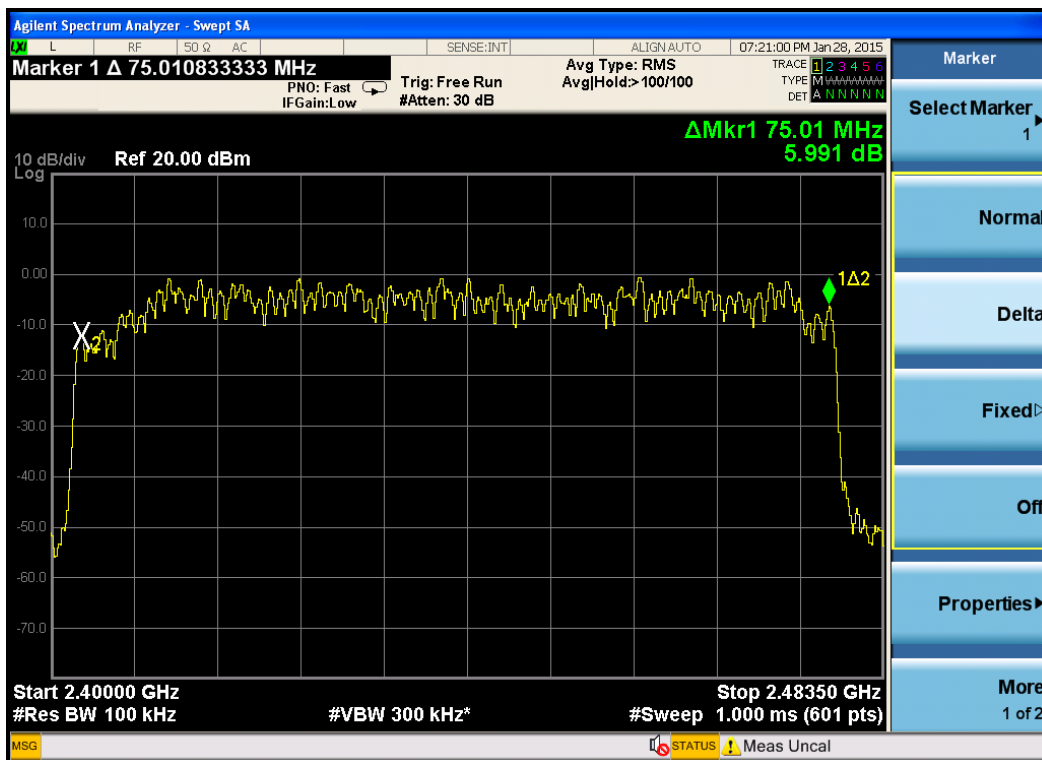

7. Dwell Time

7.1. Test limit

Please refer section 15.247 a(1) and RSS-210 issue 8, §A8.1 (d):

According to §15.247(a)(1)(iii), Frequency hopping systems operating in the 2400MHz-2483.5 MHz. The average time of occupancy on any frequency shall not greater than 0.4 s within period of 0.4 seconds multiplied by the number of hopping channel employed.

7.2. Test Procedure

7.2.1. Place the EUT on the table and set it in transmitting mode.

7.2.2. Remove the antenna from the EUT and then connect a low loss RF cable from the antenna port to the spectrum analyzer.

7.2.3. Set center frequency of spectrum analyzer = operating frequency.

7.2.4. Set the spectrum analyzer as RBW, VBW=1MHz, Span = 0Hz, Sweep = auto.

7.2.5. Repeat above procedures until all frequency measured were complete.

7.2.6. The spectrums are scanned by using the spectrum analyzer (*1). And the numbers of occupied channel per Nsec (period of 0.4 seconds multiplied by the number of hopping channels employed) were counted by using the delta-marker function of spectrum analyzer and recorded as "N".

7.2.7. The dwell time was calculated by $T_{on} \times N$.

7.3. Test Results

PASS.

Detailed information please see the following page.

EUT: 2.4GHz Electronic Speed Controller M/N: 92801					
Test date: 2015-01-28 2015-01-30		Test site: RF site Tested by: Peter			
Mode	Frequency (MHz)	Pulse Duration (ms)	Dwell Time (ms)	Limit (ms)	Conclusion
FHSS	2442	0.3167	115.28	<400	PASS
Note: 1 N=364 2 Dwell Time = Pulse Duration * N					

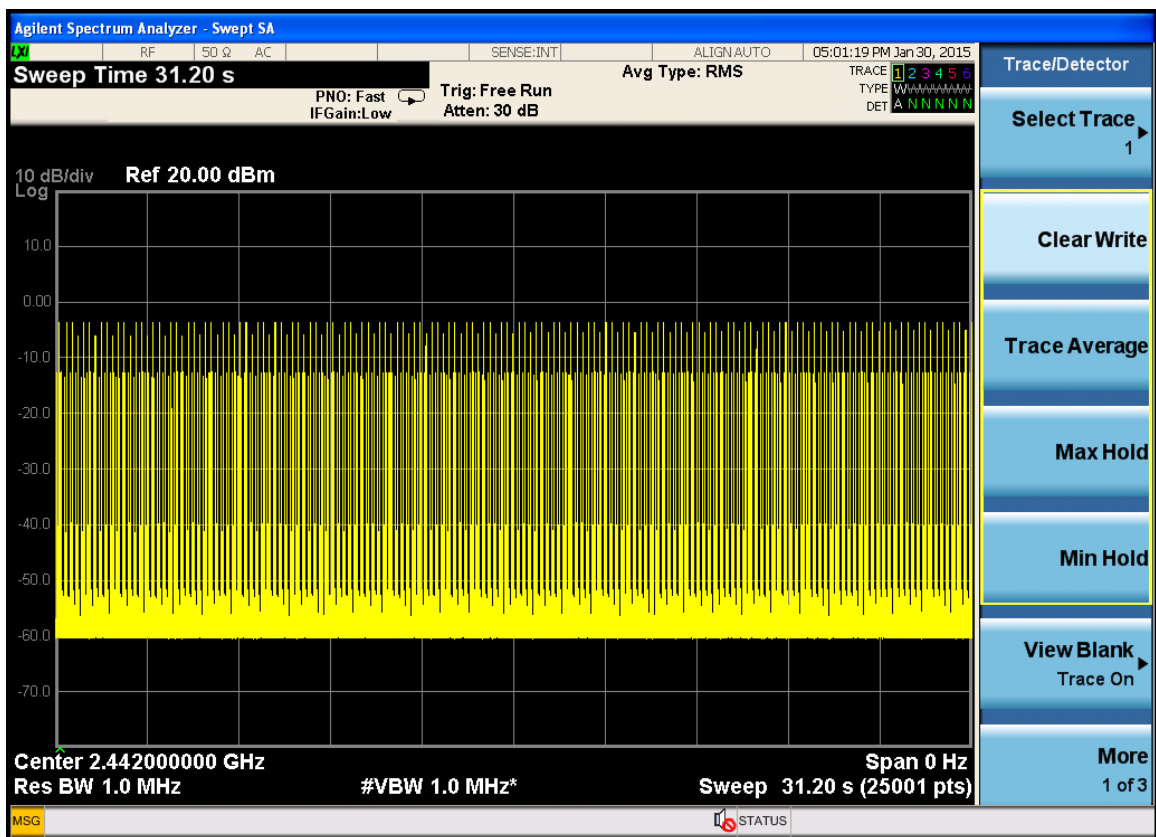
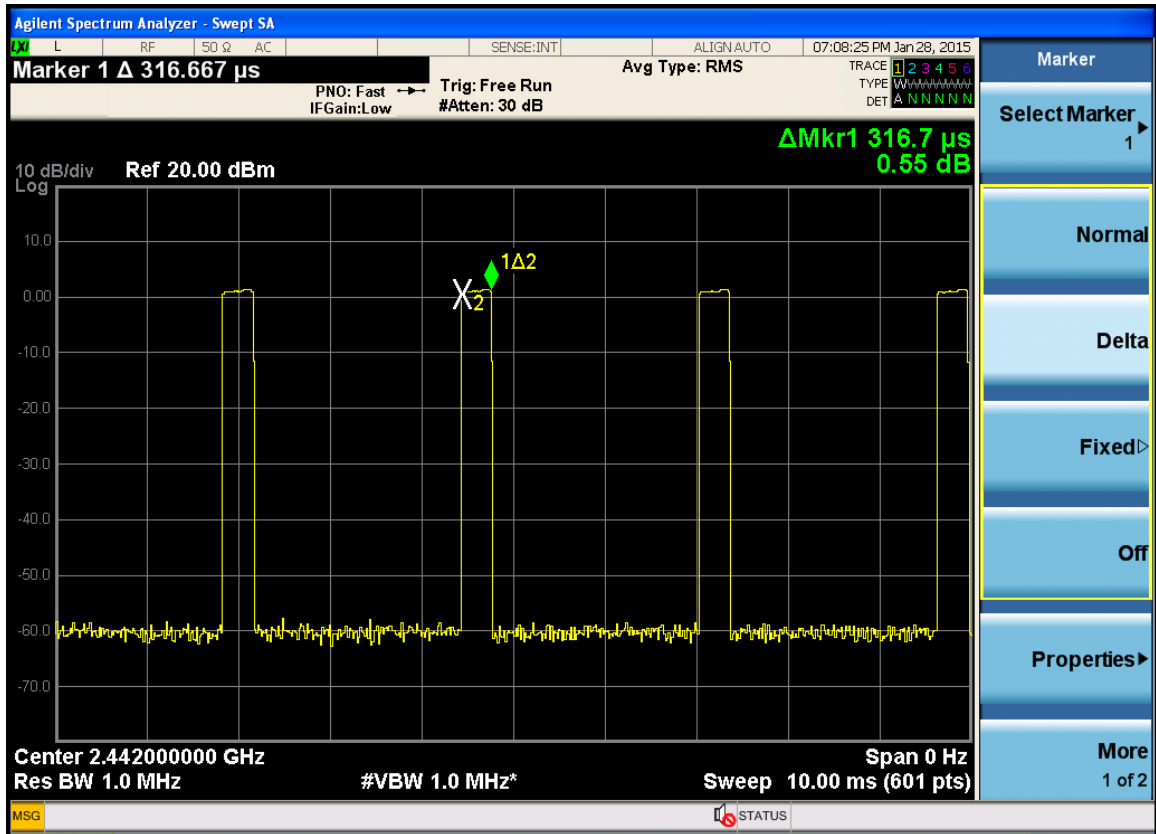

Note: The numbers is 364.

8. Radiated emissions

8.1. Limit

Please refer section 15.247 c and RSS-210 issue 8, §A8.5:

All the emissions appearing within 15.205 restricted frequency bands shall not exceed the limits shown in 15.209, all the other emissions shall be at least 20dB below the fundamental emissions, or comply with 15.209 limits.

15.205 Restricted frequency band

MHz	MHz	MHz	GHz
0.090 - 0.110	16.42 - 16.423	399.9 - 410	4.5 - 5.15
¹ 0.495 - 0.505	16.69475 - 16.69525	608 - 614	5.35 - 5.46
2.1735 - 2.1905	16.80425 - 16.80475	960 - 1240	7.25 - 7.75
4.125 - 4.128	25.5 - 25.67	1300 - 1427	8.025 - 8.5
4.17725 - 4.17775	37.5 - 38.25	1435 - 1626.5	9.0 - 9.2
4.20725 - 4.20775	73 - 74.6	1645.5 - 1646.5	9.3 - 9.5
6.215 - 6.218	74.8 - 75.2	1660 - 1710	10.6 - 12.7
6.26775 - 6.26825	108 - 121.94	1718.8 - 1722.2	13.25 - 13.4
6.31175 - 6.31225	123 - 138	2200 - 2300	14.47 - 14.5
8.291 - 8.294	149.9 - 150.05	2310 - 2390	15.35 - 16.2
8.362 - 8.366	156.52475 - 156.52525	2483.5 - 2500	17.7 - 21.4
8.37625 - 8.38675	156.7 - 156.9	2690 - 2900	22.01 - 23.12
8.41425 - 8.41475	162.0125 - 167.17	3260 - 3267	23.6 - 24.0
12.29 - 12.293	167.72 - 173.2	3332 - 3339	31.2 - 31.8
12.51975 - 12.52025	240 - 285	3345.8 - 3358	36.43 - 36.5
12.57675 - 12.57725	322 - 335.4	3600 - 4400	(²)

15.209 Limit

FREQUENCY MHz	DISTANCE Meters	FIELD STRENGTHS LIMIT	
		μV/m	dB(μV)/m
0.009-0.490	300	2400/F(KHz)	/
0.490-1.705	30	24000/F(KHz)	/
1.705-30	30	30	29.5
30 ~ 88	3	100	40.0
88 ~ 216	3	150	43.5
216 ~ 960	3	200	46.0
960 ~ 1000	3	500	54.0
Above 1000	3	74.0 dB(μV)/m (Peak) 54.0 dB(μV)/m (Average)	

8.2. Block Diagram of Test setup

8.2.1. In 3m Anechoic Chamber Test Setup Diagram for below 1GHz

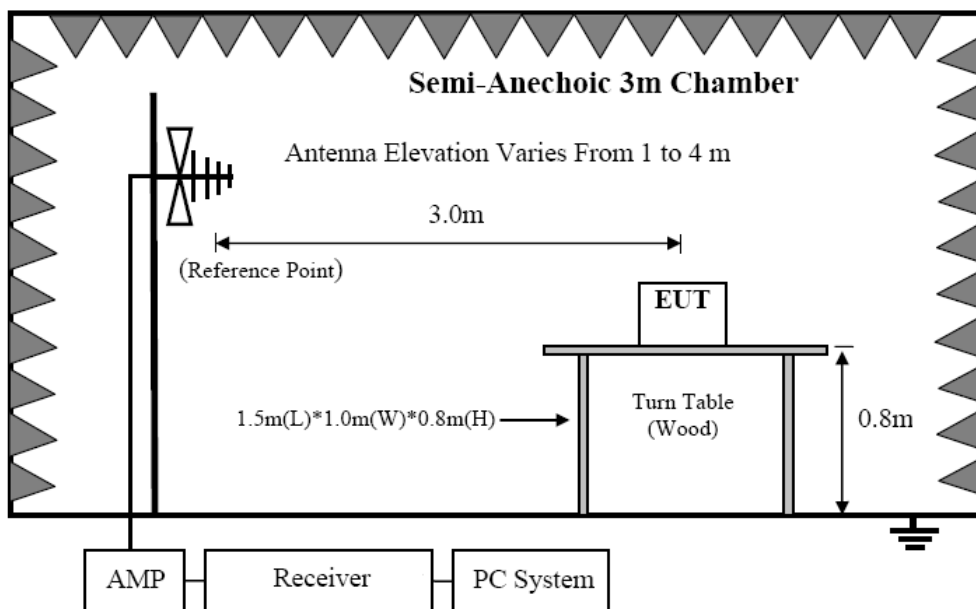

8.2.2. In 3m Anechoic Chamber Test Setup Diagram for frequency above 1GHz

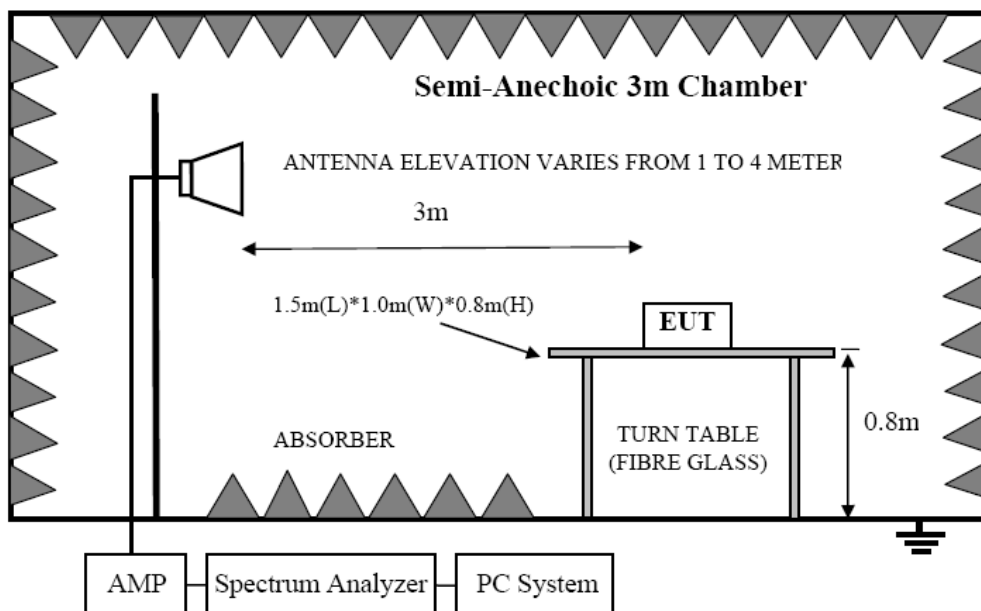

Note: For harmonic emissions test a appropriate high pass filter was inserted in the input port of AMP.

8.3. Test Procedure

(1) EUT was placed on a non-metallic table, 80 cm above the ground plane inside a semi-anechoic

chamber.

- (2) Setup EUT and simulator as shown in section 1.4 and 6.1
- (3) Test antenna was located 3m from the EUT on an adjustable mast. Below pre-scan procedure was first performed in order to find prominent radiated emissions.
 - (a) Change work frequency or channel of device if practicable.
 - (b) Change modulation type of device if practicable.
 - (c) Rotated EUT though three orthogonal axes to determine the attitude of EUT arrangement produces highest emissions
- (4) Spectrum frequency from 9KHz to 25GHz (tenth harmonic of fundamental frequency) was investigated
- (5) For final emissions measurements at each frequency of interest, the EUT were rotated and the antenna height was varied between 1m and 4m in order to maximize the emission. Measurements in both horizontal and vertical polarities were made and the data was recorded. In order to find the maximum emission, the relative positions of equipments and all of the interface cables were changed according to ANSI C63.4 2003 on Radiated Emission test.
- (6) For emissions above 1GHz, both Peak and Average level were measured with Spectrum Analyzer, and the RBW is set at 1MHz, VBW is set at 3MHz for Peak measure; RBW is set at 1MHz, VBW is set at 10Hz for Average measure.

8.4. Test Result

We have scanned the 10th harmonic from 9KHz to the EUT.
Detailed information please see the following page.

From 9KHz to 30MHz: Conclusion: PASS

Note: The amplitude of spurious emissions which are attenuated by more than 20dB below the permissible value has no need to be reported.

From 30MHz to 1000MHz: Conclusion: PASS



Alpha Product Testing Laboratory
 Building B, East Area of Nanchang Second Industrial Zone,
 Gushu 2nd Road, Bao'an District, Shenzhen 518126, P.R. China
 Tel: +86-755-29766001 FAX: +86-755-86375565
 Website: <http://www.a-lab.cn> Email: service@a-lab.cn

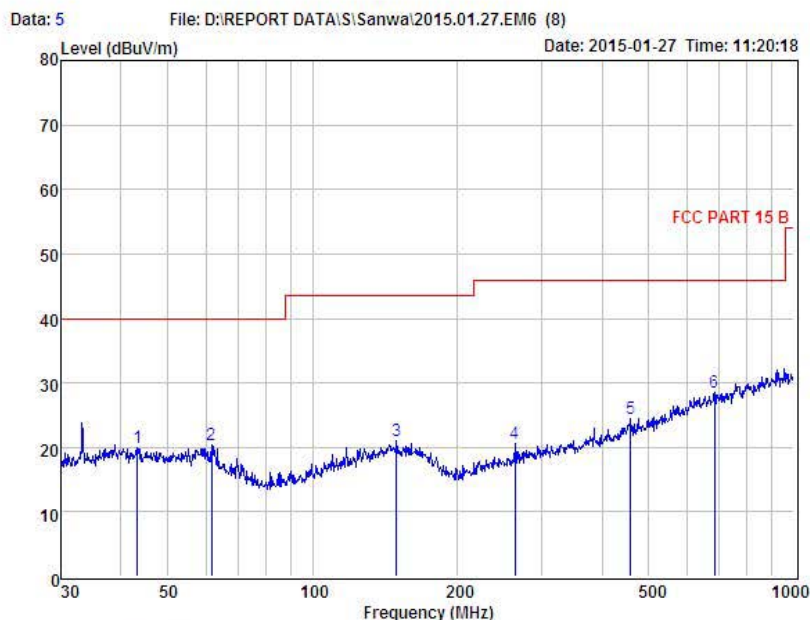

Condition : FCC PART 15 B 3m POL: VERTICAL
 EUT : 2.4G Electronic Speed Controller
 Model No : 92801
 Test Mode : Link Mode
 Power : DC 6V FROM BATTERY
 Test Engineer : Peter
 Remark :
 Temp : 24.2°C
 Hum : 54%

Item	Freq MHz	Read Level dBuV	Antenna Factor dB	Preamp Factor dB	Cable Loss dB	Level dBuV	Limit dBuV	Margin dBuV	Remark
1	43.20	37.83	13.79	31.87	0.09	19.84	40.00	-20.16	Peak
2	61.78	39.61	12.36	31.74	0.19	20.42	40.00	-19.58	Peak
3	149.49	37.77	14.03	31.19	0.35	20.96	43.50	-22.54	Peak
4	263.82	38.78	11.90	30.68	0.65	20.65	46.00	-25.35	Peak
5	457.51	37.05	16.04	29.91	1.16	24.34	46.00	-21.66	Peak
6	684.75	36.98	19.50	29.29	1.42	28.61	46.00	-17.39	Peak

Remark: Level = Read Level + Antenna Factor - Preamp Factor + Cable Loss

Remark1: All modes have been tested, and only worst data, Channel 2403MHz was listed in this report.

Remark2: Test for all x, y, z axes is performed and only the worst case of y axes was recorded in the test report.



Alpha Product Testing Laboratory
 Building B, East Area of Nanchang Second Industrial Zone,
 Gushu 2nd Road, Bao'an District, Shenzhen 518126, P.R. China
 Tel: +86-755-29766001 FAX: +86-755-86375565
 Website: http://www.a-lab.cn Email: service@a-lab.cn

Data: 6 File: D:\REPORT DATA\SI\Sanwa\2015.01.27.EM6 (8) Date: 2015-01-27 Time: 11:26:15

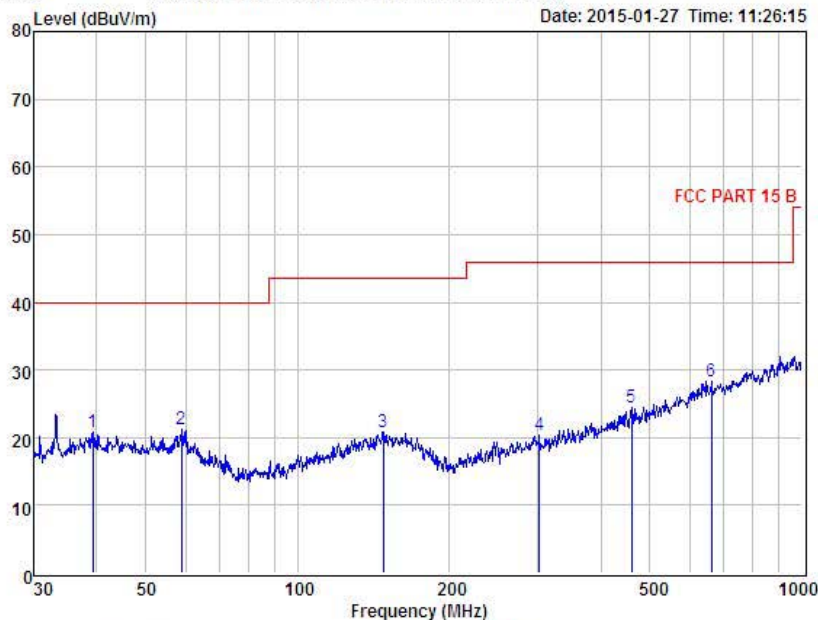

Condition : FCC PART 15 B 3m POL: HORIZONTAL
 EUT : 2.4G Electronic Speed Controller
 Model No : 92801
 Test Mode : Link Mode
 Power : DC 6V FROM BATTERY
 Test Engineer : Peter
 Remark :
 Temp : 24.2°C
 Hum : 54%

Item	Freq MHz	Read Level dBuV	Antenna Factor dB	Preamp Factor dB	Cable Loss dB	Level dBuV	Limit dBuV	Margin dBuV	Remark
1	39.30	38.43	14.07	31.89	0.17	20.78	40.00	-19.22	Peak
2	58.82	39.95	12.75	31.75	0.32	21.27	40.00	-18.73	Peak
3	147.92	37.73	14.03	31.20	0.32	20.88	43.50	-22.62	Peak
4	301.42	37.47	12.85	30.57	0.60	20.35	46.00	-25.65	Peak
5	459.11	37.10	16.06	29.88	1.10	24.38	46.00	-21.62	Peak
6	661.15	37.40	19.23	29.32	0.91	28.22	46.00	-17.78	Peak

Remark: Level = Read Level + Antenna Factor - Preamp Factor + Cable Loss

Remark1: All modes have been tested, and only worst data, Channel 2403MHz was listed in this report.

Remark2: Test for all x, y, z axes is performed and only the worst case of y axes was recorded in the test report.

1GHz—25GHz Radiated emission Test result									
EUT: 2.4GHz Electronic Speed Controller					M/N: 92801				
Power: DC 6.0V From battery									
Test date: 2015-01-27 Test site: 3m Chamber Tested by: Peter									
Test mode: Tx CH1 2403MHz									
Antenna polarity: Vertical									
No	Freq (MHz)	Read Level (dBuV/m)	Antenna Factor (dB/m)	Cable loss(dB)	Amp Factor (dB)	Result (dBuV/m)	Limit (dBuV/m)	Margin (dB)	Remark
1	4806	47.92	31.26	5.70	34.20	50.68	74	23.32	PK
2	4806	40.68	31.26	5.70	34.20	43.44	54	10.56	AV
3	7209	/							
4	9612	/							
5	12015	/							
Antenna Polarity: Horizontal									
1	4806	48.35	31.26	5.70	34.20	51.11	74	22.89	PK
2	4806	41.77	31.26	5.70	34.20	44.53	54	9.47	AV
3	7209	/							
4	9612	/							
5	12015	/							
Note:									
1, Measuring frequency from 1GHz to 25GHz									
2, Spectrum Set for PK measure: RBW=1MHz, VBW=1MHz, Sweep time=Auto, Detector: PK									
2, Spectrum Set for AV measure: RBW=1MHz, VBW=10Hz, Sweep time=Auto, Detector: PK									
3, Result = Read level + Antenna factor + cable loss-Amp factor									
4, All the other emissions not reported were too low to read and deemed to comply with FCC limit.									

1GHz—25GHz Radiated emission Test result									
EUT: 2.4GHz Electronic Speed Controller					M/N: 92801				
Power: DC 6.0V From battery									
Test date: 2015-01-27 Test site: 3m Chamber Tested by: Peter									
Test mode: Tx CH40 2442MHz									
Antenna polarity: Vertical									
No	Freq (MHz)	Read Level (dBuV/m)	Antenna Factor (dB/m)	Cable loss(dB)	Amp Factor (dB)	Result (dBuV/m)	Limit (dBuV/m)	Margin (dB)	Remark
1	4884	49.24	31.38	5.75	34.14	52.23	74	21.77	PK
2	4884	41.68	31.38	5.75	34.14	44.67	54	9.33	AV
3	7326	/							
4	9768	/							
5	12210	/							
Antenna Polarity: Horizontal									
1	4884	46.54	31.38	5.75	34.14	49.53	74	24.47	PK
2	4884	40.17	31.38	5.75	34.14	43.16	54	10.84	AV
3	7326	/							
4	9768	/							
5	12210	/							
Note:									
1, Measuring frequency from 1GHz to 25GHz									
2, Spectrum Set for PK measure: RBW=1MHz, VBW=1MHz, Sweep time=Auto, Detector: PK									
2, Spectrum Set for AV measure: RBW=1MHz, VBW=10Hz, Sweep time=Auto, Detector: PK									
3, Result = Read level + Antenna factor + cable loss-Amp factor									
4, All the other emissions not reported were too low to read and deemed to comply with FCC limit.									

1GHz—25GHz Radiated emission Test result									
EUT: 2.4GHz Electronic Speed Controller					M/N: 92801				
Power: DC 6.0V From battery									
Test date: 2015-01-27 Test site: 3m Chamber Tested by: Peter									
Test mode: Tx CH76 2478MHz									
Antenna polarity: Vertical									
No	Freq (MHz)	Read Level (dBuV/m)	Antenna Factor (dB/m)	Cable loss(dB)	Amp Factor (dB)	Result (dBuV/m)	Limit (dBuV/m)	Margin (dB)	Remark
1	4956	46.39	31.50	5.79	34.06	49.62	74	24.38	PK
2	4956	39.86	31.50	5.79	34.06	43.09	54	10.91	AV
3	7434	/							
4	9912	/							
5	12390	/							
Antenna Polarity: Horizontal									
1	4956	43.54	31.50	5.79	34.06	46.77	74	27.23	PK
2	4956	37.13	31.50	5.79	34.06	40.36	54	13.64	AV
3	7434	/							
4	9912	/							
5	12390	/							
Note:									
1, Measuring frequency from 1GHz to 25GHz									
2, Spectrum Set for PK measure: RBW=1MHz, VBW=1MHz, Sweep time=Auto, Detector: PK									
2, Spectrum Set for AV measure: RBW=1MHz, VBW=10Hz, Sweep time=Auto, Detector: PK									
3, Result = Read level + Antenna factor + cable loss-Amp factor									
4, All the other emissions not reported were too low to read and deemed to comply with FCC limit.									

9. Band Edge Compliance

9.1. Block Diagram of Test Setup

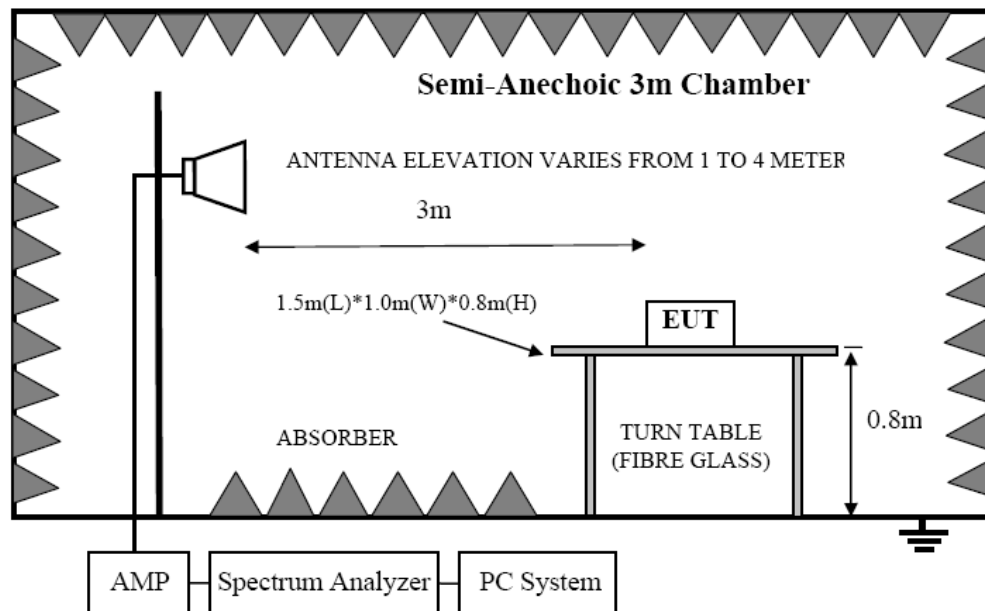

9.2. Limit

All the lower and upper band-edges emissions appearing within 2310MHz to 2390MHz and 2483.5MHz to 2500MHz restricted frequency bands shall not exceed the limits shown in 15.209, all the other emissions outside operation frequency band 2400MHz to 2483.5MHz and 5725MHz to 5850MHz shall be at least 20dB below the fundamental emissions, or comply with 15.209 limits.

9.3. Test Procedure

Same with clause 6.3 except change investigated frequency range from 2310MHz to 2415MHz, 2475MHz to 2500MHz.

9.4. Test Result

PASS.

NOTE : The Band Edge is showed the maximum power data of all mode(FH3, FH4T)

Band Edge Test result								
EUT: 2.4GHz Electronic Speed Controller					M/N: 92801			
Power: DC 6.0V From battery								
Test date: 2015-01-27 Test site: 3m Chamber Tested by: Peter								
Test mode: Tx CH1 2403MHz								
Antenna polarity: Vertical								
Freq (MHz)	Read Level (dBuV/m)	Antenna Factor (dB/m)	Cable loss(dB)	Amp Factor (dB)	Result (dBuV/m)	Limit (dBuV/m)	Margin (dB)	Remark
2390	44.27	27.62	3.92	34.97	40.84	74	33.16	PK
2390	/	27.62	3.92	34.97	/	54	/	AV
2400	45.81	27.62	3.94	34.97	42.40	74	31.60	PK
2400	/	27.62	3.94	34.97	/	54	/	AV
Antenna Polarity: Horizontal								
2390	43.65	27.62	3.92	34.97	40.22	74	33.78	PK
2390	/	27.62	3.92	34.97	/	54	/	AV
2400	44.08	27.62	3.94	34.97	40.67	74	33.33	PK
2400	/	27.62	3.94	34.97	/	54	/	AV
Note:								
1, Spectrum Set for PK measure: RBW=1MHz, VBW=1MHz, Sweep time=Auto, Detector: PK								
2, Spectrum Set for AV measure: RBW=1MHz, VBW=10Hz, Sweep time=Auto, Detector: PK								
3, Result = Read level + Antenna factor + cable loss-Amp factor								
4, All the other emissions not reported were too low to read and deemed to comply with FCC limit.								

Band Edge Test result								
EUT: 2.4GHz Electronic Speed Controller					M/N: 92801			
Power: DC 6.0V From battery								
Test date: 2015-01-27 Test site: 3m Chamber Tested by: Peter								
Test mode: Tx CH76 2478MHz								
Antenna polarity: Vertical								
Freq (MHz)	Read Level (dBuV/m)	Antenna Factor (dB/m)	Cable loss(dB)	Amp Factor (dB)	Result (dBuV/m)	Limit (dBuV/m)	Margin (dB)	Remark
2483.5	43.72	27.59	4.00	34.97	40.34	74	33.66	PK
2483.5	/	27.59	4.00	34.97	/	54	/	AV
Antenna Polarity: Horizontal								
2483.5	44.65	27.59	4.00	34.97	41.27	74	32.73	PK
2483.5	/	27.59	4.00	34.97	/	54	/	AV
Note:								
1, Spectrum Set for PK measure: RBW=1MHz, VBW=1MHz, Sweep time=Auto, Detector: PK								
2, Spectrum Set for AV measure: RBW=1MHz, VBW=10Hz, Sweep time=Auto, Detector: PK								
3, Result = Read level + Antenna factor + cable loss-Amp factor								
4, All the other emissions not reported were too low to read and deemed to comply with FCC limit.								

Band Edge Test result								
EUT: 2.4GHz Electronic Speed Controller					M/N: 92801			
Power: DC 6.0V From battery								
Test date: 2015-01-27			Test site: 3m Chamber		Tested by: Peter			
Test mode: Hopping								
Antenna polarity: Vertical								
Freq (MHz)	Read Level (dBuV/m)	Antenna Factor (dB/m)	Cable loss(dB)	Amp Factor (dB)	Result (dBuV/m)	Limit (dBuV/m)	Margin (dB)	Remark
2390	43.92	27.62	3.92	34.97	40.49	74	33.51	PK
2390	/	27.62	3.92	34.97	/	54	/	AV
2400	44.65	27.62	3.94	34.97	41.24	74	32.76	PK
2400	/	27.62	3.94	34.97	/	54	/	AV
Antenna Polarity: Horizontal								
2390	44.17	27.62	3.92	34.97	40.74	74	33.26	PK
2390	/	27.62	3.92	34.97	/	54	/	AV
2400	44.96	27.62	3.94	34.97	41.55	74	32.45	PK
2400	/	27.62	3.94	34.97	/	54	/	AV
Note:								
1, Spectrum Set for PK measure: RBW=1MHz, VBW=1MHz, Sweep time=Auto, Detector: PK								
2, Spectrum Set for AV measure: RBW=1MHz, VBW=10Hz, Sweep time=Auto, Detector: PK								
3, Result = Read level + Antenna factor + cable loss-Amp factor								
4, All the other emissions not reported were too low to read and deemed to comply with FCC limit.								

Band Edge Test result								
EUT: 2.4GHz Electronic Speed Controller					M/N: 92801			
Power: DC 6.0V From battery								
Test date: 2015-01-27 Test site: 3m Chamber Tested by: Peter								
Test mode: Hopping								
Antenna polarity: Vertical								
Freq (MHz)	Read Level (dBuV/m)	Antenna Factor (dB/m)	Cable loss(dB)	Amp Factor (dB)	Result (dBuV/m)	Limit (dBuV/m)	Margin (dB)	Remark
2483.5	44.51	27.59	4.00	34.97	41.13	74	32.87	PK
2483.5	/	27.59	4.00	34.97	/	54	/	AV
Antenna Polarity: Horizontal								
2483.5	43.68	27.59	4.00	34.97	40.30	74	33.70	PK
2483.5	/	27.59	4.00	34.97	/	54	/	AV
Note:								
1, Spectrum Set for PK measure: RBW=1MHz, VBW=1MHz, Sweep time=Auto, Detector: PK								
2, Spectrum Set for AV measure: RBW=1MHz, VBW=10Hz, Sweep time=Auto, Detector: PK								
3, Result = Read level + Antenna factor + cable loss-Amp factor								
4, All the other emissions not reported were too low to read and deemed to comply with FCC limit.								

10. Power Line Conducted Emissions

10.1. Block Diagram of Test Setup

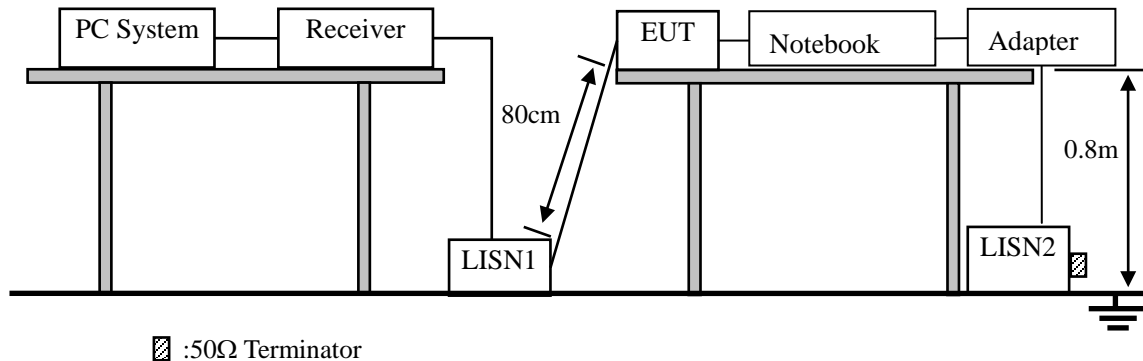

10.2. Limit

Frequency	Maximum RF Line Voltage	
	Quasi-Peak Level dB(μ V)	Average Level dB(μ V)
150kHz ~ 500kHz	66 ~ 56*	56 ~ 46*
500kHz ~ 5MHz	56	46
5MHz ~ 30MHz	60	50

Notes: 1. * Decreasing linearly with logarithm of frequency.

2. The lower limit shall apply at the transition frequencies.

10.3. Test Procedure

- (1) The EUT was placed on a non-metallic table, 80cm above the ground plane.
- (2) Setup the EUT and simulator as shown in 10.1
- (3) The EUT Power connected to the power mains through a notebook and a line impedance stabilization network (L.I.S.N1). The other peripheral devices power cord connected to the power mains through a line impedance stabilization network (L.I.S.N2), this provided a 50-ohm coupling impedance for the EUT (Please refer to the block diagram of the test setup and photographs). Both sides of power line were checked for maximum conducted interference. In order to find the maximum emission, the relative positions of equipments and all of the interface cables were changed according to ANSI C63.4 2003 on conducted Emission test.
- (4) The bandwidth of test receiver is set at 10KHz.
- (5) The frequency range from 150 KHz to 30MHz is checked.

10.4. Test Result

EUT power supply by battery, so this test item not applicable.

11. Antenna Requirements

11.1. Limit

For intentional device, according to FCC 47 CFR Section 15.203, an intentional radiator shall be designed to ensure that no antenna other than that furnished by the responsible party shall be used with the device. And according to FCC 47 CFR Section 15.247 (b), if transmitting antennas of directional gain greater than 6dBi are used, the power shall be reduced by the amount in dB that the directional gain of the antenna exceeds 6dBi.

11.2. Result

The antennas used for this product are Integrate Antenna, no antenna other than that furnished by the responsible party shall be used with the device, the maximum peak gain of the transmit antenna is only 3.14dBi.

12. Test setup photo

12.1. Photos of Radiated emission

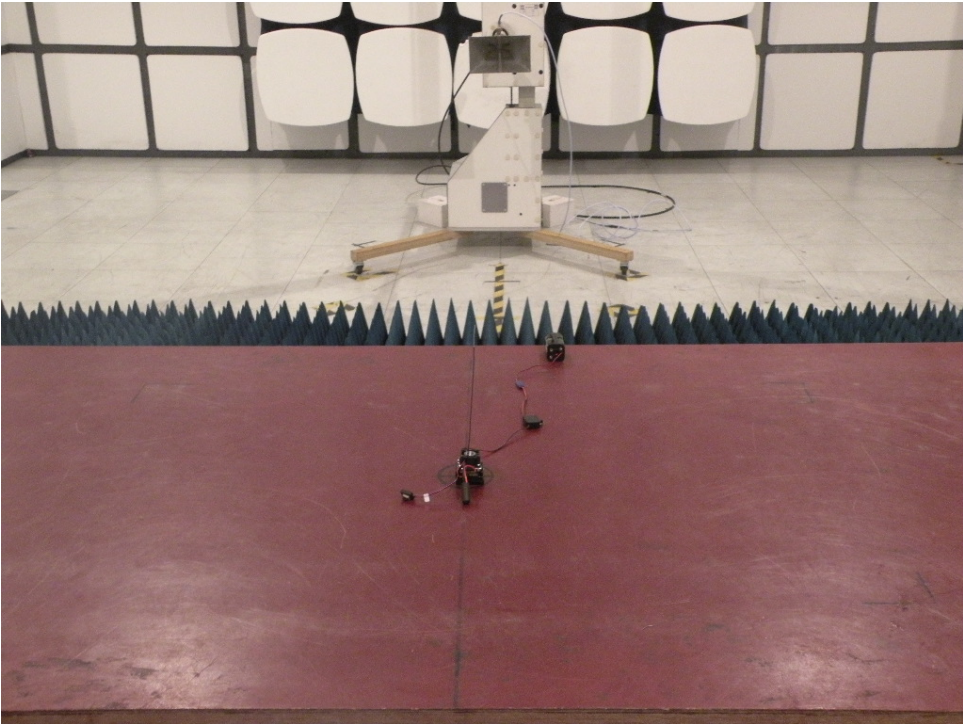
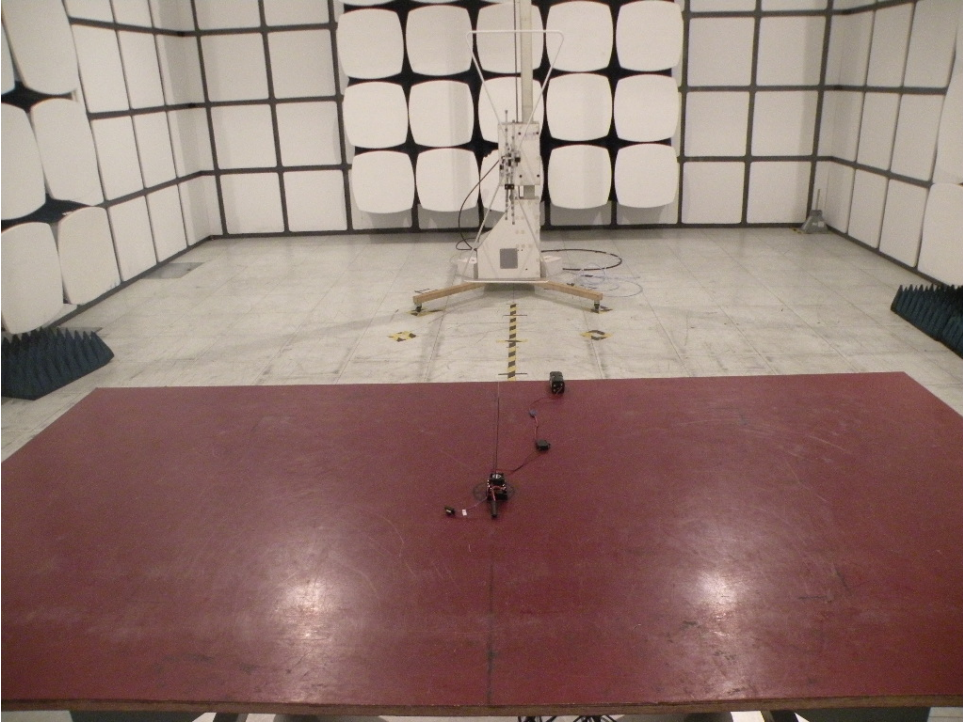

13.Photos of EUT

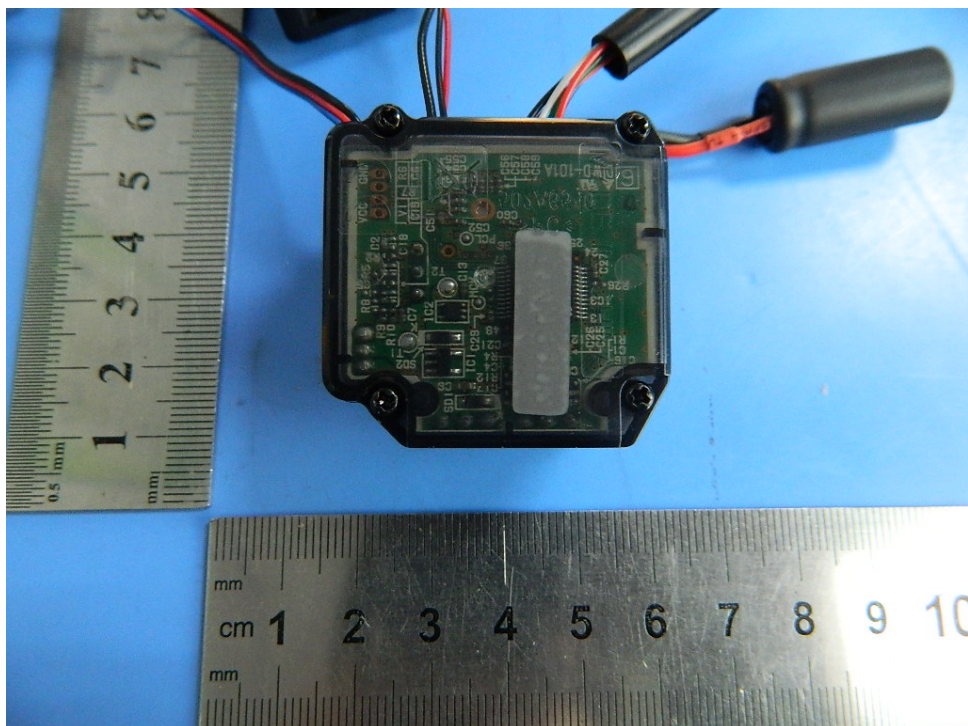
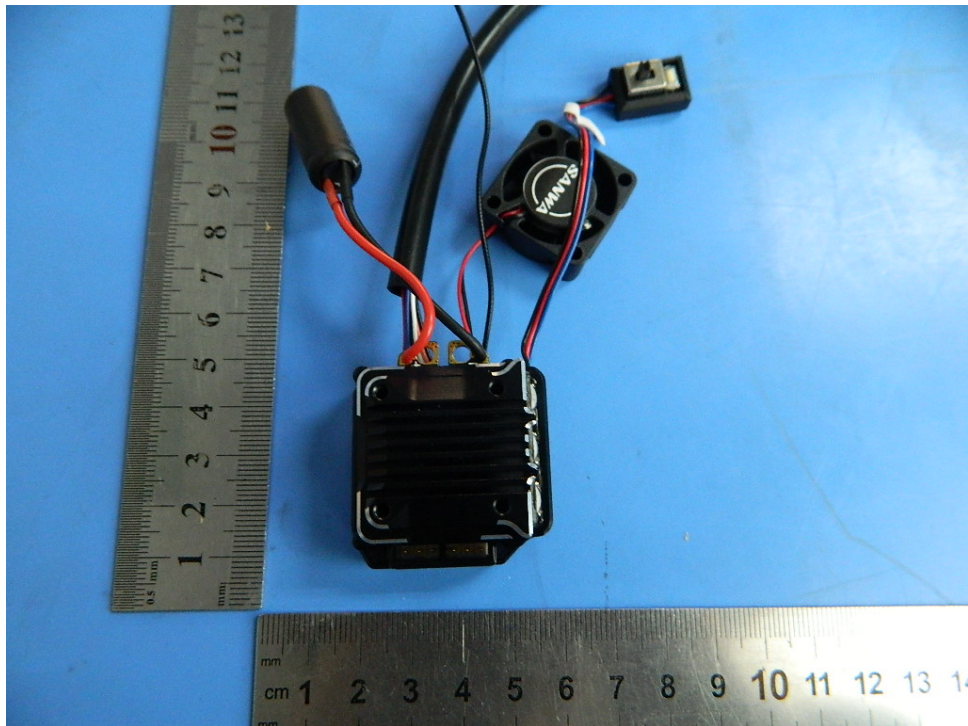

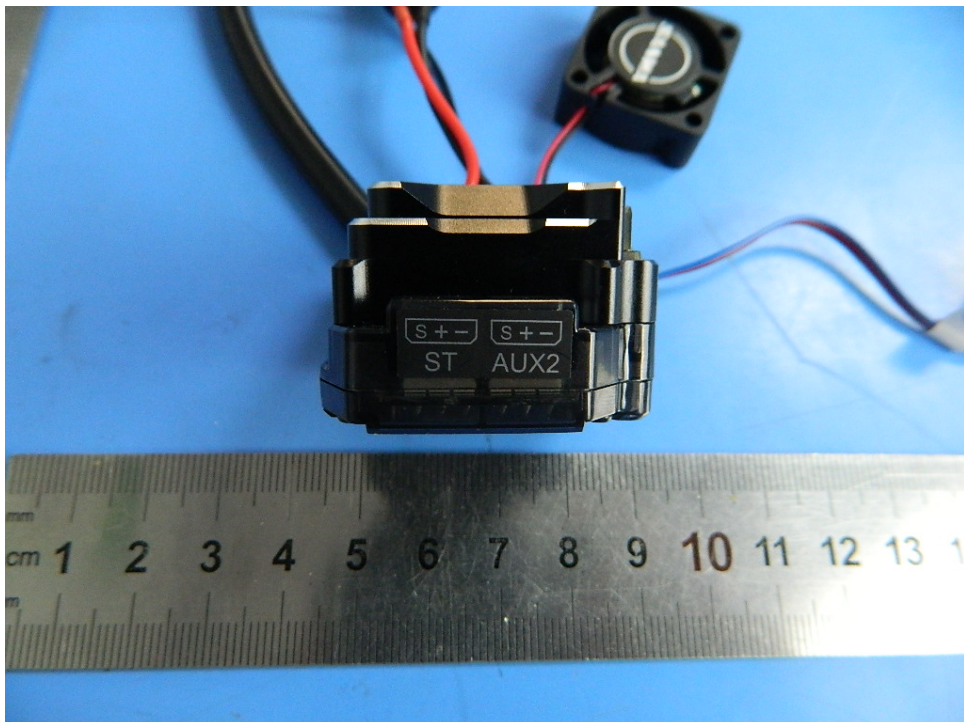
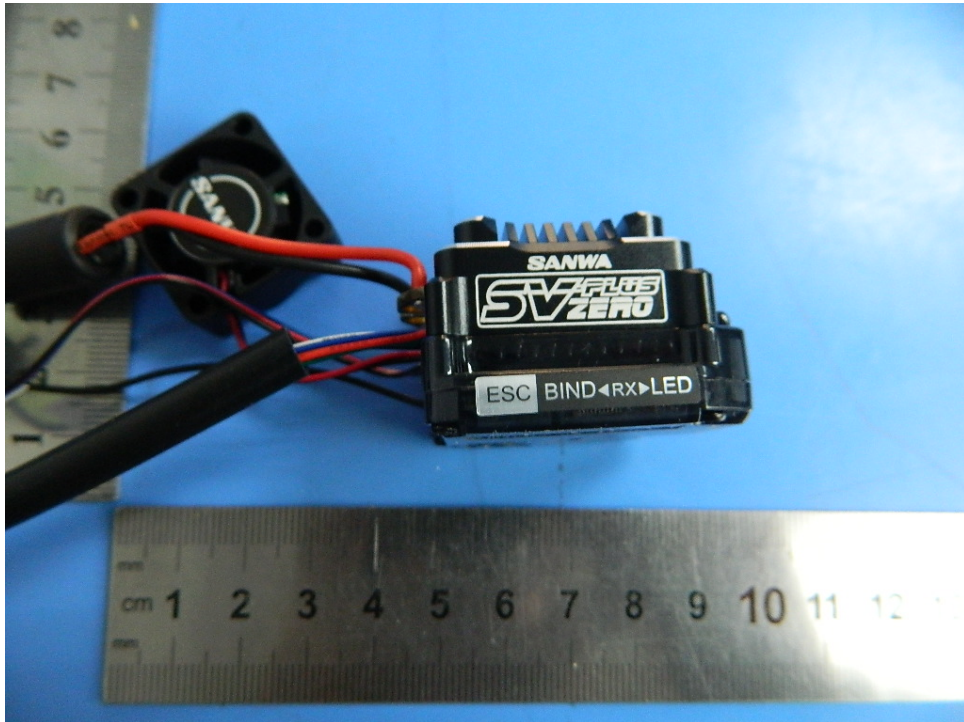

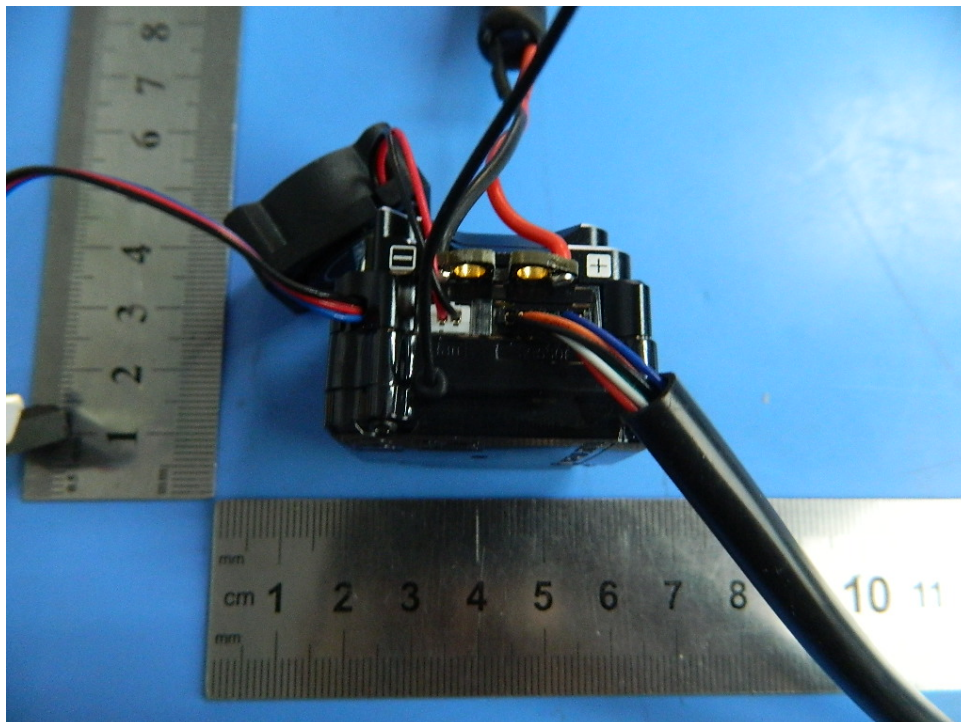
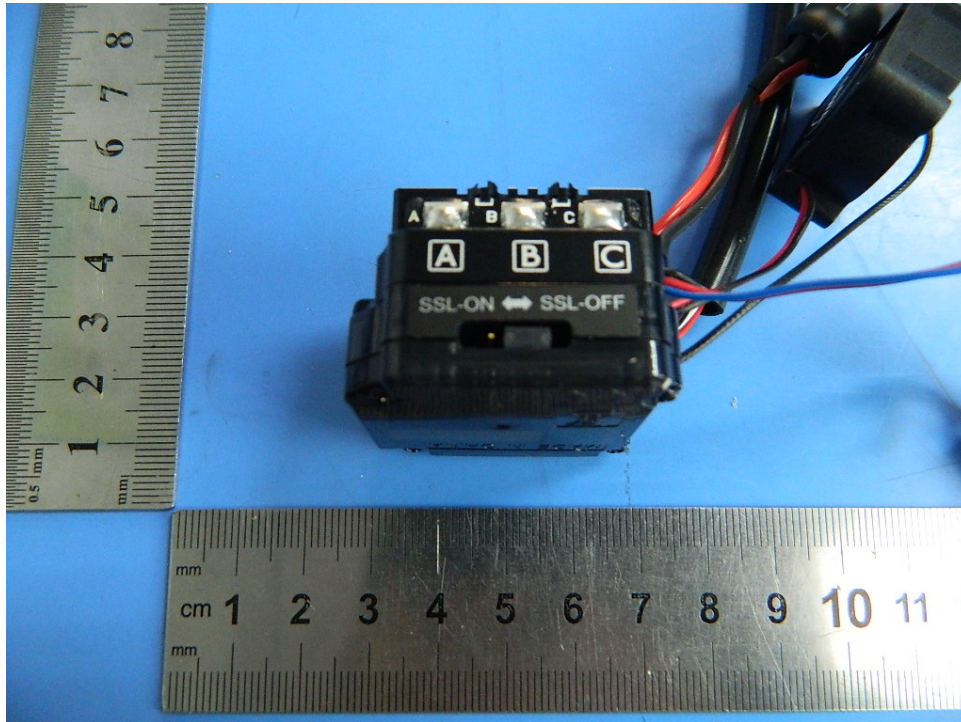

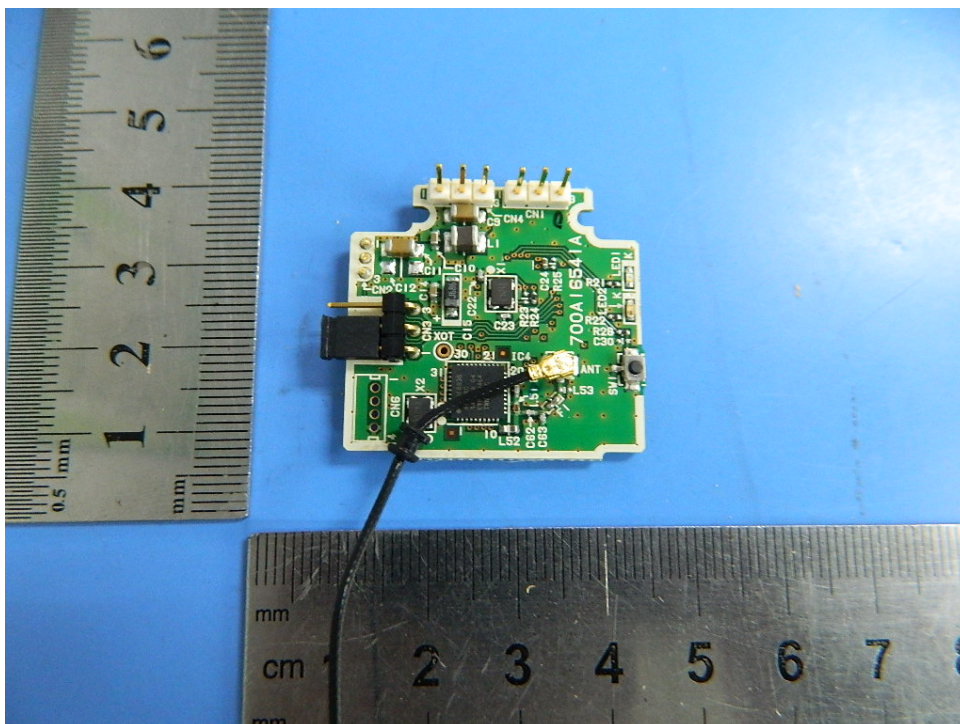
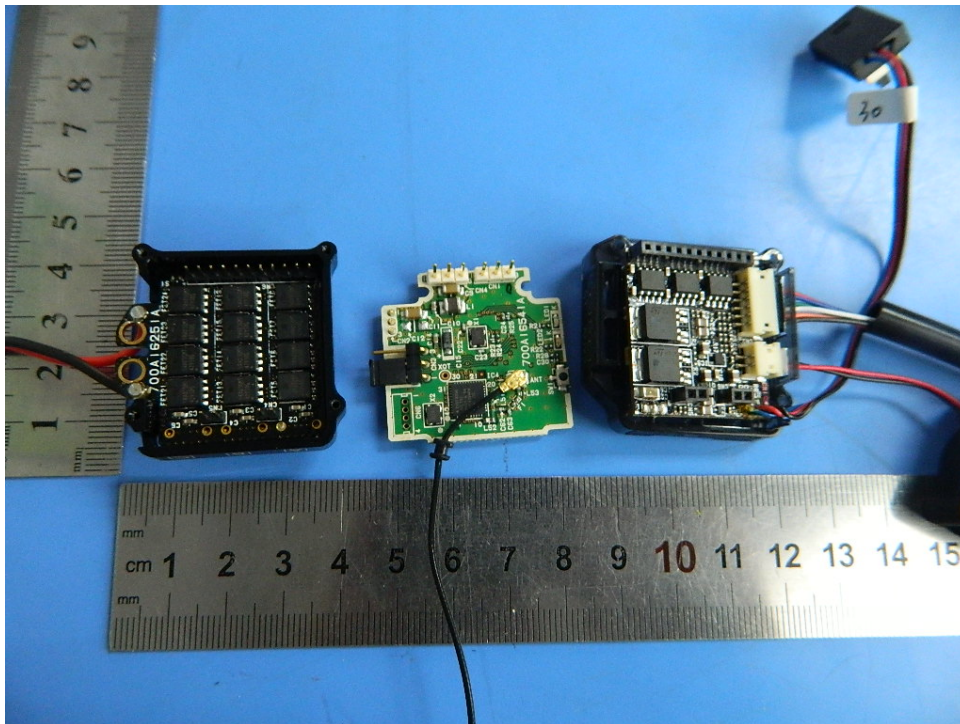

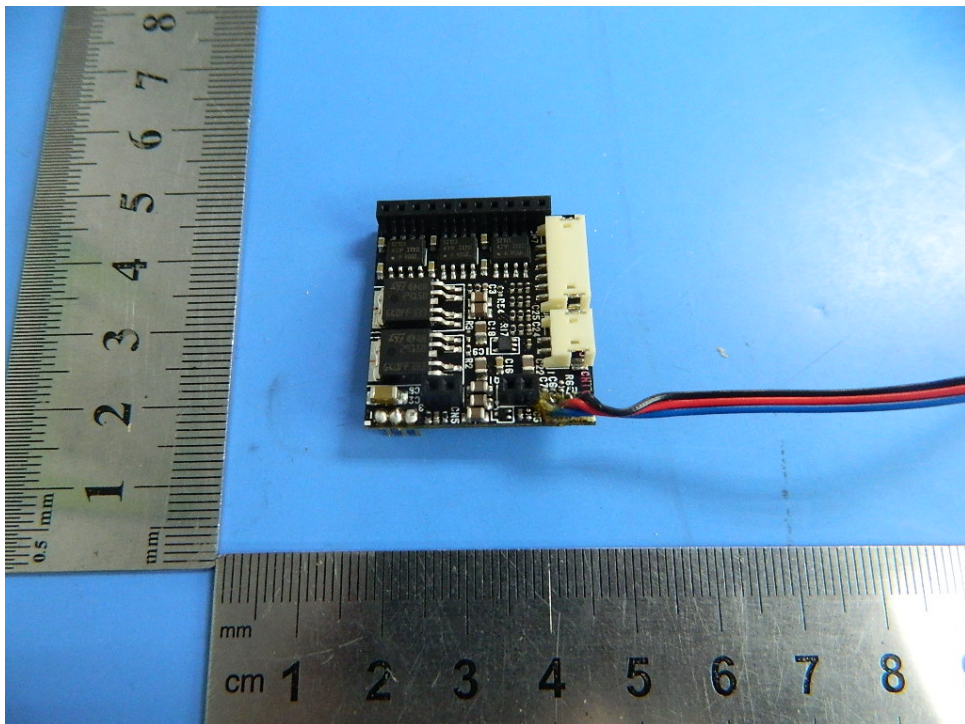
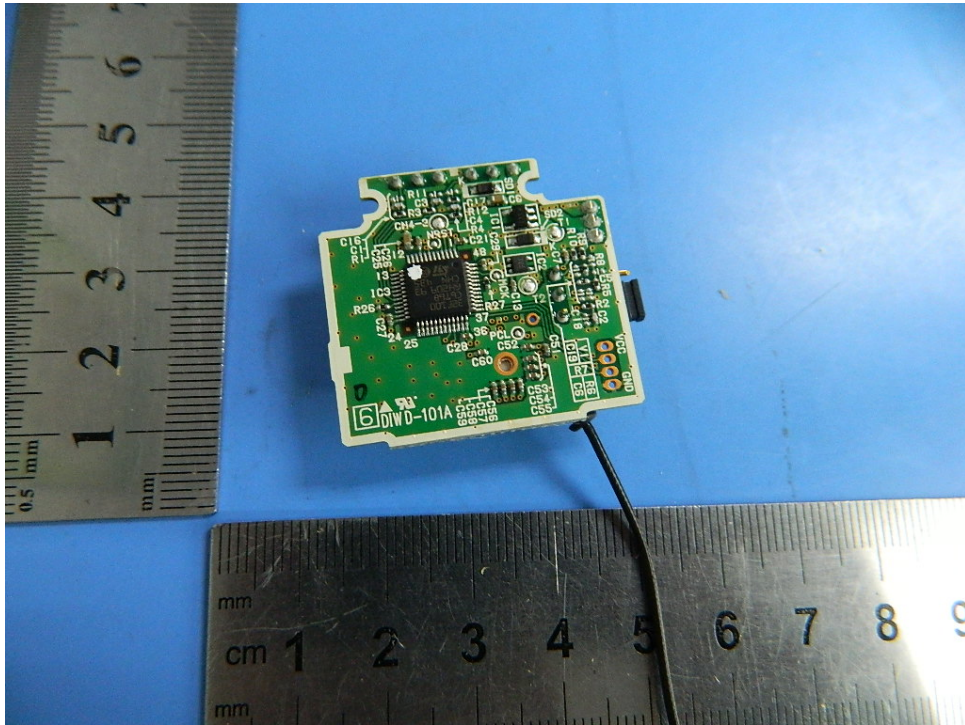

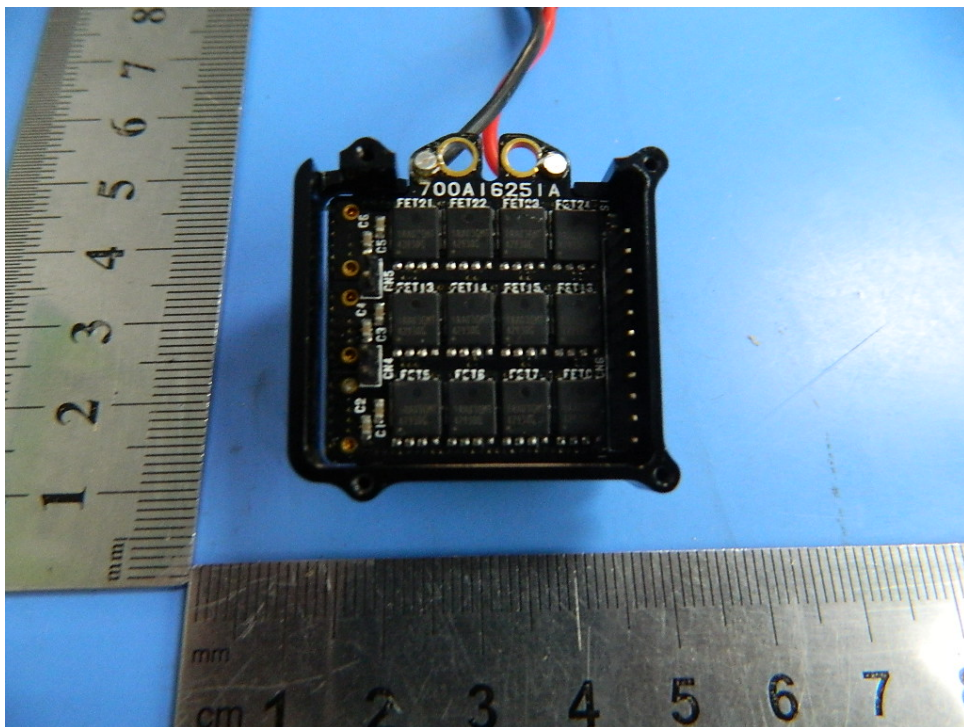
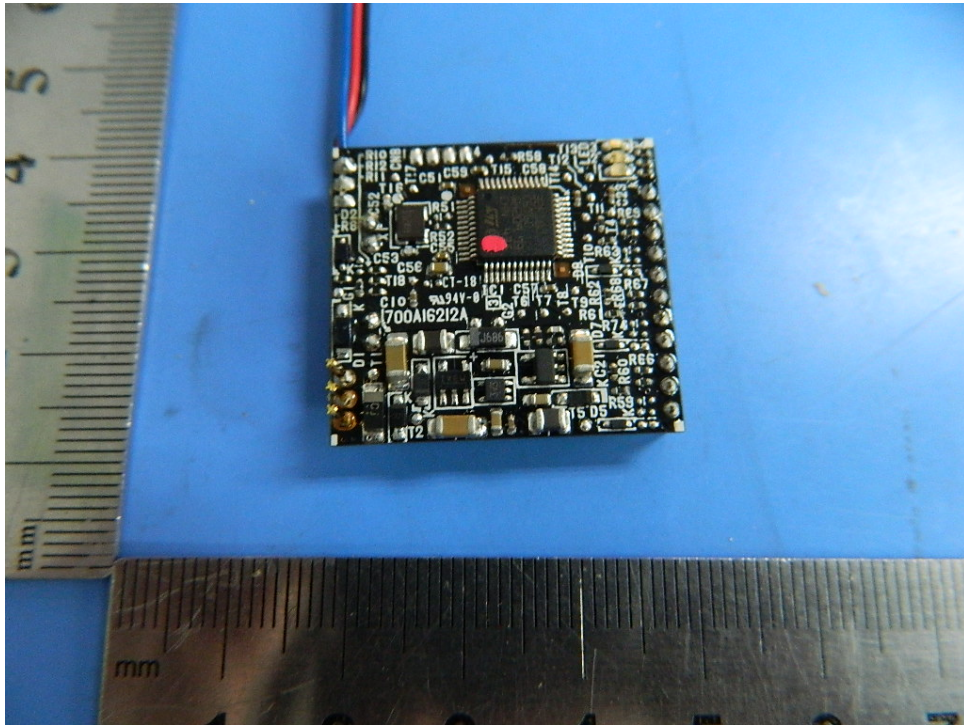

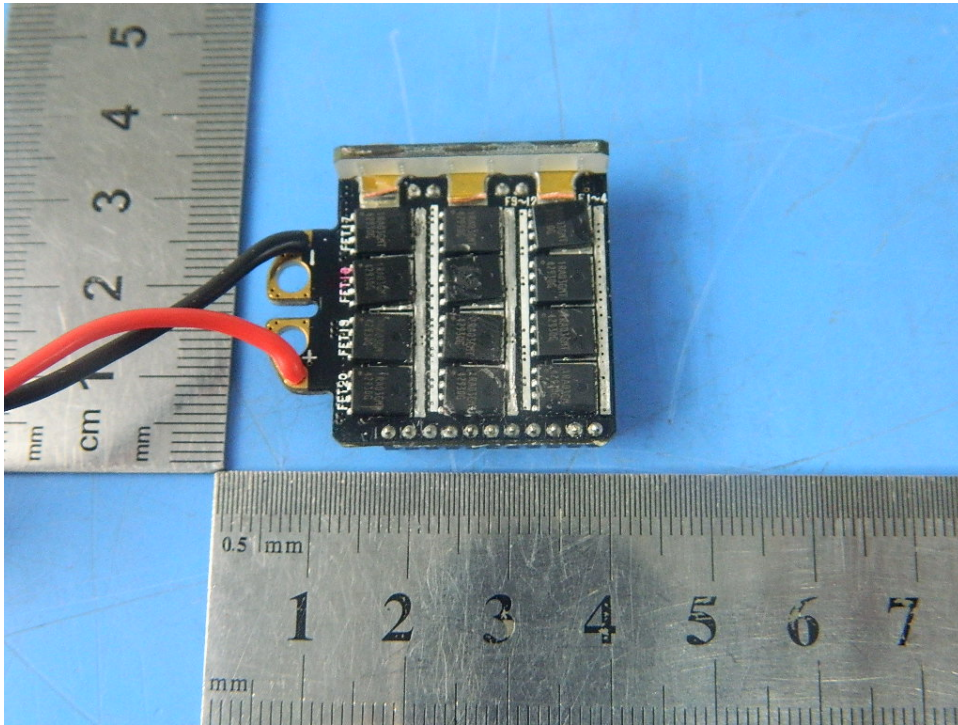

-----THE END OF REPORT-----