

FCC Part 15 Subpart C Requirement  
and Industry Canada RSS-210  
Measurement and Test Report



For

**Sanwa Electronic Instrument Co., Ltd**

1-2-50, Yoshida Honmachi, Higashi-Osaka, Osaka 578-0982, Japan

**FCC ID: L73-90490**  
**IC: 7377A-90490**

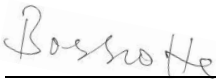
January 08, 2014

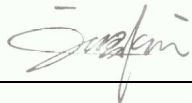
|   |   |
|---|---|
| <b>This Report Concerns:</b><br><input checked="" type="checkbox"/> Original Report   | <b>Equipment Type:</b><br>2.4GHz Radio Control System |
| <b>Tested By:</b>  Bossco He (Test Engineer)  |   |
| <b>Report Number:</b> SE14A-533FI   |   |
| <b>Test Date:</b> December 26, 2013 to January 07, 2014   |   |
| <b>Reviewed By:</b>  Karbon Y. Chung (Senior Manager)  |   |
| <b>Prepared By:</b> S&E Technologies Laboratory Ltd<br>Room 407, Block A Shennan Garden, Hi-Tech Industrial Park,<br>Shenzhen 518057, P.R. China.<br>Tel: 86-755-26636573, 26630631<br>Fax: 86-755-26630557           |   |

**Note:** This test report is limited to the above client company and the product model only.  
It may not be duplicated without prior written consent of S&E Technologies  
Laboratory Ltd.

## Table of Contents

|   |           |
|---|-----------|
| <b>1-TEST RESULT CERTIFICATION</b> .....                                      | <b>3</b>  |
| <b>2- EUT DESCRIPTION</b> .....   | <b>4</b>  |
| <b>3-TEST SYSTEM</b> .....  | <b>5</b>  |
| 3.1 TEST MODE.....  | 5         |
| 3.2 TEST SETUP DIAGRAM .....  | 6         |
| 3.3 DESCRIPTION OF TEST AUXILIARY EQUIPMENTS .....                            | 7         |
| 3.4 BLOCK DIAGRAM OF EUT SYSTEM .....   | 7         |
| 3.5 LIST OF CABLES .....  | 7         |
| <b>4- TEST EQUIPMENT AND CALIBRATION</b> .....                                | <b>8</b>  |
| <b>5- LABORATORY ACCREDITATIONS AND MEASUREMENT UNCERTAINTY</b> .....         | <b>9</b>  |
| 5.1 LABORATORY ACCREDITATION .....  | 9         |
| 5.2 MEASUREMENT UNCERTAINTY .....   | 9         |
| <b>6- TECHNICAL REQUIREMENTS AND RESULTS</b> .....                            | <b>10</b> |
| 6.1 CARRIER FREQUENCY SEPARATION MEASUREMENT .....                            | 10        |
| 6.2 NUMBER OF HOPPING FREQUENCIES MEASUREMENT .....                           | 12        |
| 6.3 TIME OF OCCUPY (DWELL TIME) MEASUREMENT .....                             | 14        |
| 6.4 PEAK OUTPUT POWER MEASUREMENT.....  | 17        |
| 6.5 BAND EDGE OF CONDUCTED EMISSION AND SPURIOUS RF CONDUCTED EMISSIONS ..... | 22        |
| 6.6 SPURIOUS RADIATED EMISSION MEASUREMENT .....                              | 30        |
| 6.7 CONDUCTED EMISSION MEASUREMENT .....                                      | 38        |
| 6.8 BAND EDGE AND RESTRICTED BAND OF RADIATED EMISSION MEASUREMENT.....       | 40        |
| 6.9 99% BANDWIDTH MEASUREMENT .....   | 46        |
| 6.10 20dB BANDWIDTH MEASUREMENT.....  | 51        |
| 6.11 POWER SPECTRAL DENSITY MEASUREMENT .....                                 | 56        |
| 6.12 RF EXPOSURE .....  | 59        |
| 6.13 ANTENNA REQUIREMENT.....   | 61        |

# 1-Test Result Certification

Applicant: Sanwa Electronic Instrument Co., Ltd  
 1-2-50, Yoshida Honmachi, Higashi-Osaka,  
 Osaka 578-0982, Japan

Equipment Under Test: 2.4GHz Radio Control System

Trade Name: **SANWA**

Model: 90490

Type of Modulation: FHSS (Mode FH4T, FH4FT)  
 FHSS-DSSS Hybrid (Mode FH3, FH3F, FH2)

Number of Channels: 56

Channel Separation: 1MHz

Operation Frequency: Mode FH4T: 2410-2465MHz  
 Mode FH4FT: 2410-2450MHz  
 Mode FH3: 2410-2465MHz  
 Mode FH3F: 2410-2450MHz  
 Mode FH2: 2415-2465MHz

Antenna Designation: Non-user replaceable (fixed)

Battery Voltage: DC6.0V [4 'AA' alkaline or Ni-Cd/Ni-MH cells or 2S LiPo or 2S LiFe battery pack]

Date of Test: December 26, 2013 to January 07, 2014

| Applicable Standards   |                         |
|--|-------------------------|
| Standard   | Test Result             |
| FCC 47 CFR Part 15 Subpart C: 2012, §15.247<br>Industry Canada: RSS-210 issue 8: 2010, Annex 8<br>Industry Canada: RSS-Gen issue 3: 2010 | No non-compliance noted |

**We hereby certify that:**

The above equipment was tested at laboratory of Guangdong Galanz Enterprises Co., Ltd, 25 South Ronggui Rd, Shunde, Foshan, Guangdong, China. The test data, data evaluation, test procedures, and equipment configurations shown in this report were made in accordance with the procedures given in ANSI C63.4: 2003 and Public Notice DA00-705. The energy emitted by the sample EUT tested as described in this report is in compliance with conducted and radiated emission limits of FCC Rules Part 15C: 2012, §15.247 and RSS-210 Issue 8, Annex 8.

The test results of this report relate only to the tested sample identified in this report.

## 2- EUT Description

|                      |   |
|----------------------|---|
| Product              | 2.4GHz Radio Control System                                       |
| Trade Name           | <b>SANWA</b>  |
| Model Number         | 90490   |
| Model Difference     | N/A   |
| Type of Modulation:  | FHSS (Mode FH4T, FH4FT)<br>FHSS-DSSS Hybrid (Mode FH3, FH3F, FH2) |
| Number of Channels:  | 56  |
| Channel Separation:  | 1MHz  |
| Power Supply         | 6.0V DC power from [1.5V*4 "AA" Ni-MH battery pack]               |
| Operation Frequency: | 2410~2465 MHz   |
| Antenna Designation  | Non-user replaceable (fixed)                                      |

*Remark: This submittal(s) of test report is intended for FCC ID: L73-90490, IC: 7377A-90490 filing to comply with Section 15.247 of the FCC Part 15, Subpart C Rules and RSS-210 Issue 8, Annex 8.*

## 3-Test System

### 3.1 Test Mode

The compliance test was performed under test modes:

Mode 1: Transmitting at 2410MHz without hopping in FHSS modulation.

Mode 2: Transmitting at 2438MHz without hopping in FHSS modulation.

Mode 3: Transmitting at 2465MHz without hopping in FHSS modulation.

Mode 4: Transmitting with hopping in FHSS modulation.

Mode 5: Transmitting at 2410MHz in FHSS-DSSS hybrid modulation.

Mode 6: Transmitting at 2438MHz in FHSS-DSSS hybrid modulation.

Mode 7: Transmitting at 2465MHz in FHSS-DSSS hybrid modulation.

The EUT is designed to be both of horizontally and vertically placed during radiated emission measurement, each condition was conducted.

As a result, the operation that produces the maximum emission under was reported.

- a) Carrier Frequency Separation Measurement ---Mode 4
- b) Number of Hopping Frequencies Measurement --- Mode 4
- c) Time of Occupancy Measurement --- Mode 4
- d) Peak Output Power Measurement --- Mode 1, Mode 2, Mode 3, Mode 5, Mode 6, Mode 7
- e) Band Edge of RF Conducted Measurement --- Mode 1, Mode 3, Mode 4, Mode 5, Mode 7.
- f) Radiated Emission Measurement --- Mode 1, Mode 2, Mode 3, Mode 5, Mode 6, Mode 7
- g) Band Edge and Restricted Band of Radiated Emission Measurement--- Mode 1, Mode 3,  
Mode 5, Mode 7
- h) 99% and 20dB Bandwidth measurement --- Mode 1, Mode 2, Mode 3,  
Mode 5, Mode 6, Mode 7
- i) Power Spectral Density Measurement --- Mode 5, Mode 6 and Mode 7.

### 3.2 Test Setup Diagram

- . Carrier Frequency Separation
- . Number of Hopping Frequencies
- . Time of Occupancy (Dwell Time)
- . Peak Output Power
- . Band Edge of RF Conducted Emission
- . Band Edge and Restricted Band of Radiated Emission measurement
- . 99% Bandwidth
- . 20dB Bandwidth
- Power Spectral Density Measurement

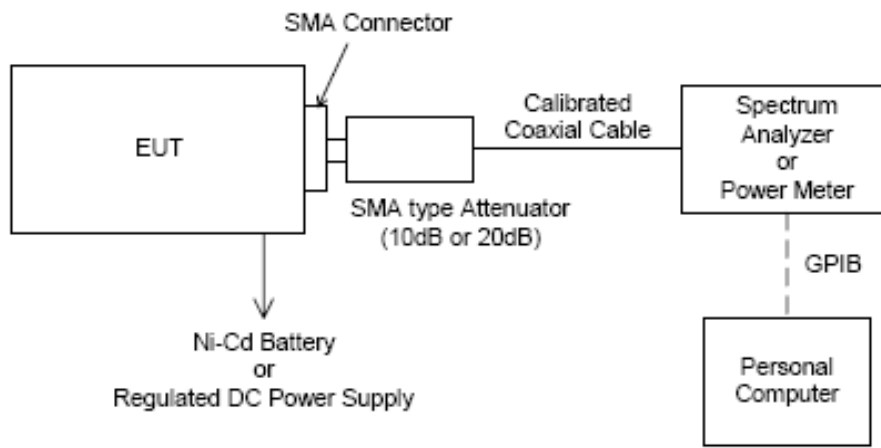

*Note: Regulated DC power supply is not used in this report.*

#### . Radiated Emission

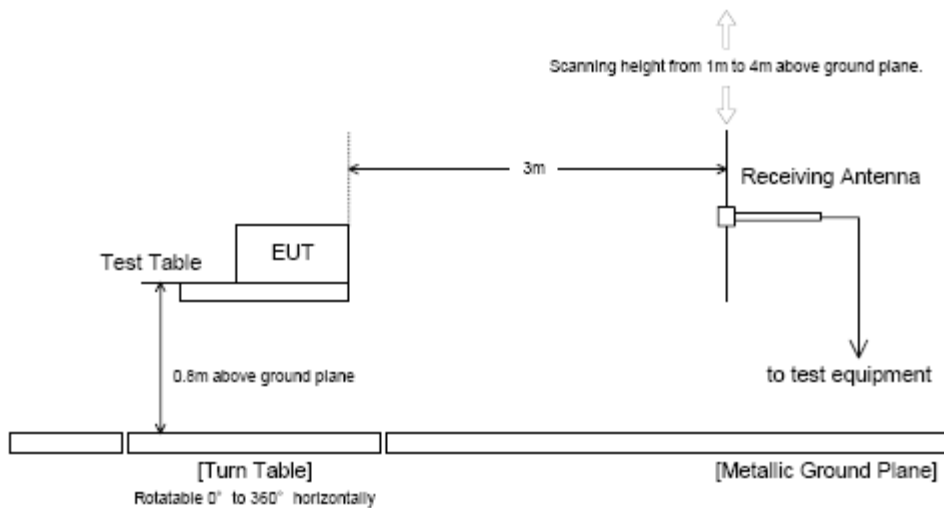

### 3.3 Description of Test Auxiliary Equipments

| Description | Manufacturer                         | Model No. | Certificate |
|-------------|--------------------------------------|-----------|-------------|
| Receiver    | Sanwa Electronic Instrument Co., Ltd | RX-472    | L73-92015   |
| Servo motor |                                      | SRM-102   | FCC         |
| Battery box |                                      | 4xAA      | N/A         |

### 3.4 Block Diagram of EUT System

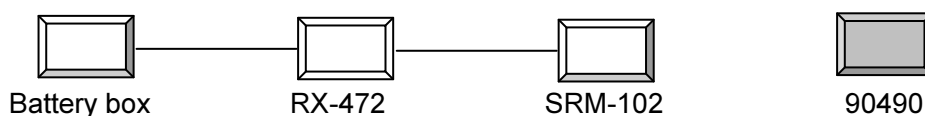

### 3.5 List of Cables

| No | Cable Name | Shielded (Y/N) | Length (m) | Note | Remark |
|----|------------|----------------|------------|------|--------|
| 1  | Antenna    | Y              | 0.15       | /    | /      |

#### 4- Test Equipment and Calibration

| Equipment type                       | Manufacturer | Model    | Serial Number | Last Calibration | Calibration Period |
|--------------------------------------|--------------|----------|---------------|------------------|--------------------|
| Biconilog Antenna                    | ETS          | 3142C    | 00042672      | 2013/09          | 1 year             |
| Receiver                             | SCHAFFNER    | SMR4503  | 11725         | 2013/07          | 1 year             |
| Spectrum Analyzer                    | R/S          | FSP30    | 100755        | 2013/11          | 1 year             |
| Double-Ridged-Waveguide Horn Antenna | ETS          | 3115     | 6587          | 2013/08          | 1 year             |
| Double-Ridged-Waveguide Horn Antenna | ETS          | 3160     | 00052486      | 2013/08          | 1 year             |
| Amplifier                            | Agilent      | 83017A   | MY39500438    | 2013/11          | 1 year             |
| Band-pass Filter                     | Micro-Tronic | BRM50702 | S/N-030       | 2013/11          | 1 year             |
| HF Loop Antenna                      | TESEQ        | HLA6120  | 26348         | 2013/10          | 1 year             |
| Anechoic Chamber                     | ETS          | N/A      | N/A           | 2013/05          | 1 year             |



## 5- Laboratory Accreditations and Measurement Uncertainty

### 5.1 Laboratory Accreditation

FCC-Registration No.: 580210

Guangdong Galanz Enterprises Co., Ltd EMC Laboratory has been registered and fully described in a report filed with the FCC (Federal Communications Commission). The acceptance letter from the FCC is maintained in our files. Listing date: November 28, 2012.

IC-Registration No.: 8801A

Guangdong Galanz Enterprises Co., Ltd EMC Laboratory has been registered by Certification and Engineering Bureau of Industry Canada for the performance of radiated measurements with Registration No. 7949A on May 03, 2013.

### 5.2 Measurement Uncertainty

of +/-  $3 \times 10^{-9}$  for Carrier Frequency Separation Measurement  
of +/-  $3 \times 10^{-9}$  for Number of Hopping Frequencies Measurement  
of +/-  $3 \times 10^{-9}$  for 20dB Bandwidth Measurement  
of +/-  $3 \times 10^{-9}$  for Time of Occupancy (Dwell time) Measurement  
of +/- 0.8 dB for Peak Output Power Measurement  
of +/- 0.8 dB for Band Edge RF Conducted Measurement  
of +/- 0.8 dB for Spurious RF Conducted Emission Measurement  
of +/- 0.8 dB for Power Density  
of +/- 4.8 dB for Radiated Emissions  
of +/- 2.3 dB for Conducted Emissions

## 6- Technical Requirements and Results

### 6.1 Carrier Frequency Separation Measurement

#### Applicable Standard:

According to §15.247(a)(1), frequency hopping systems shall have hopping channel carrier frequencies separated by a minimum of 25 kHz or the 20 dB bandwidth of the hopping channel, whichever is greater. Alternatively, frequency hopping systems operating in the 2400-2483.5 MHz band may have hopping channel carrier frequencies that are separated by 25 kHz or two-thirds of the 20 dB bandwidth of the hopping channel, whichever is greater.

According to RSS 210 issue 8, A8.1(b), frequency hopping systems operating in the 2400-2483.5 MHz band may have hopping channel carrier frequencies that are separated by 25 kHz or two-thirds of the 20dB bandwidth of the hopping channel, whichever is greater.

#### Test Procedure:

1. Connect the EUT RF output port to spectrum analyzer via calibrated coaxial cable and suitable attenuator (if necessary).
2. Activates the EUT system and execute the software prepared for test, if necessary.
3. To find out the maximum emission condition, the transmitting data rate of EUT is set to maximum data rate.
4. The spectrums are scanned and allow the trace stabilized.
5. The separation between the peaks of the peaks of adjacent channel were measured by using delta-maker function of the spectrum analyzer

Spectrum analyzer setup conditions:

Frequency span : 2MHz  
Resolution bandwidth : 100kHz  
Video bandwidth :  $\cong$  RBW  
Sweep : Auto  
Detector function : Peak  
Trace mode : Max Hold

Test Result:

|                |                              |
|----------------|------------------------------|
| Temperature:   | 21 °C                        |
| Humidity:      | 51%                          |
| EUT Operation: | FHSS modulation with hopping |
| Test Date:     | December 29, 2013            |

| Carrier Frequency Separation [ MHz ] | [ MHz ] Limit |
|--------------------------------------|---------------|
| 0.996                                | > 0.887       |

Note: Test plot shown in figure 1 on page 11.

Figure 1: Channel Separation

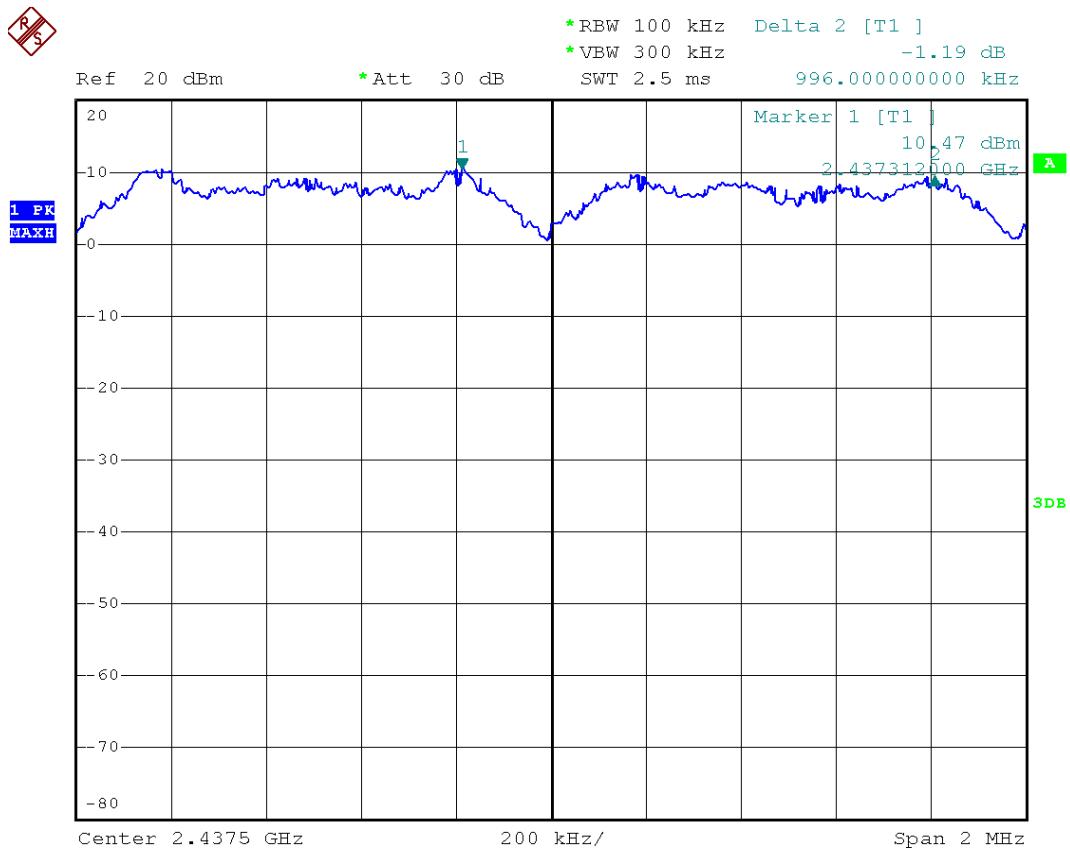

## 6.2 Number of Hopping Frequencies Measurement

### Applicable Standard:

According to §15.247(a)(1)(iii), frequency hopping systems operating in the 2400MHz-2483.5 MHz bands shall use at least 15 hopping frequencies.

According to RSS-210 issue 8, §A8.1(d), frequency hopping systems operating in the 2400-2483.5MHz band shall use at least 15 hopping channels. The average time of occupancy on any channel shall not be greater than 0.4 seconds within a period of 0.4 seconds multiplied by the number of hopping channels employed. Transmissions on particular hopping frequencies may be avoided or suppressed provided that a minimum of 15 hopping channels are used.

### Test Procedure:

1. Connect the EUT RF output port to spectrum analyzer via calibrated coaxial cable and suitable attenuator (if necessary).
2. Activates the EUT system and executes the software prepared for test, if necessary.
3. To find out the maximum emission condition, the transmitting data rate of EUT is set to maximum data rate.
4. The spectrums are scanned and allow the trace to stabilize.
5. The number of hopping frequencies were counted on the spectrum analyzer and recorded.

Spectrum analyzer setup conditions:

Resolution bandwidth : 100KHz

Video bandwidth :  $\cong$  RBW

Sweep : Auto

Detector function : Peak

Trace mode : Max Hold

### Test Result:

|                |                                   |
|----------------|-----------------------------------|
| Temperature:   | 22 °C                             |
| Humidity:      | 51%                               |
| EUT Operation: | FHSS modulation with hopping mode |
| Test Date:     | December 30, 2013                 |

| Number of Hopping Frequencies                             | [ MHz ] Limit |
|---|---------------|
| 56  | > 15          |
| <i>Note: Test plot shown in figure 2 to 3 on page 13.</i> |               |

Figure 2: Number of Hopping Frequencies

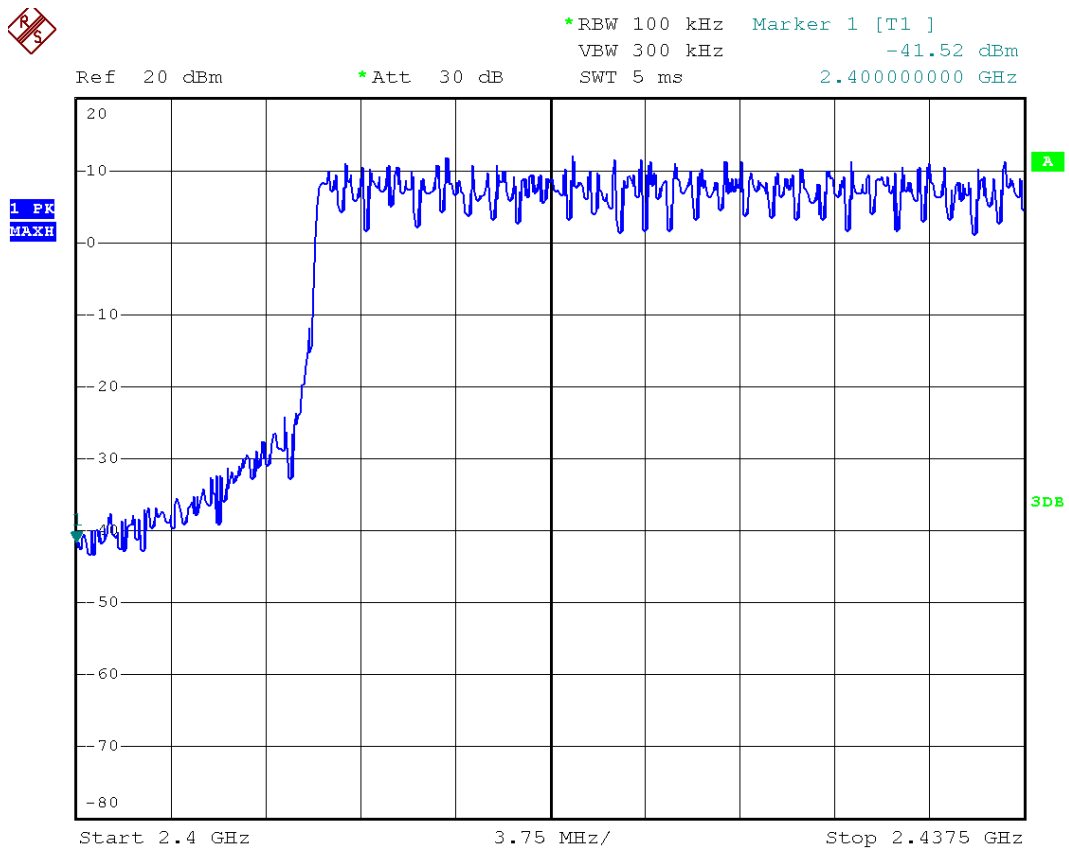
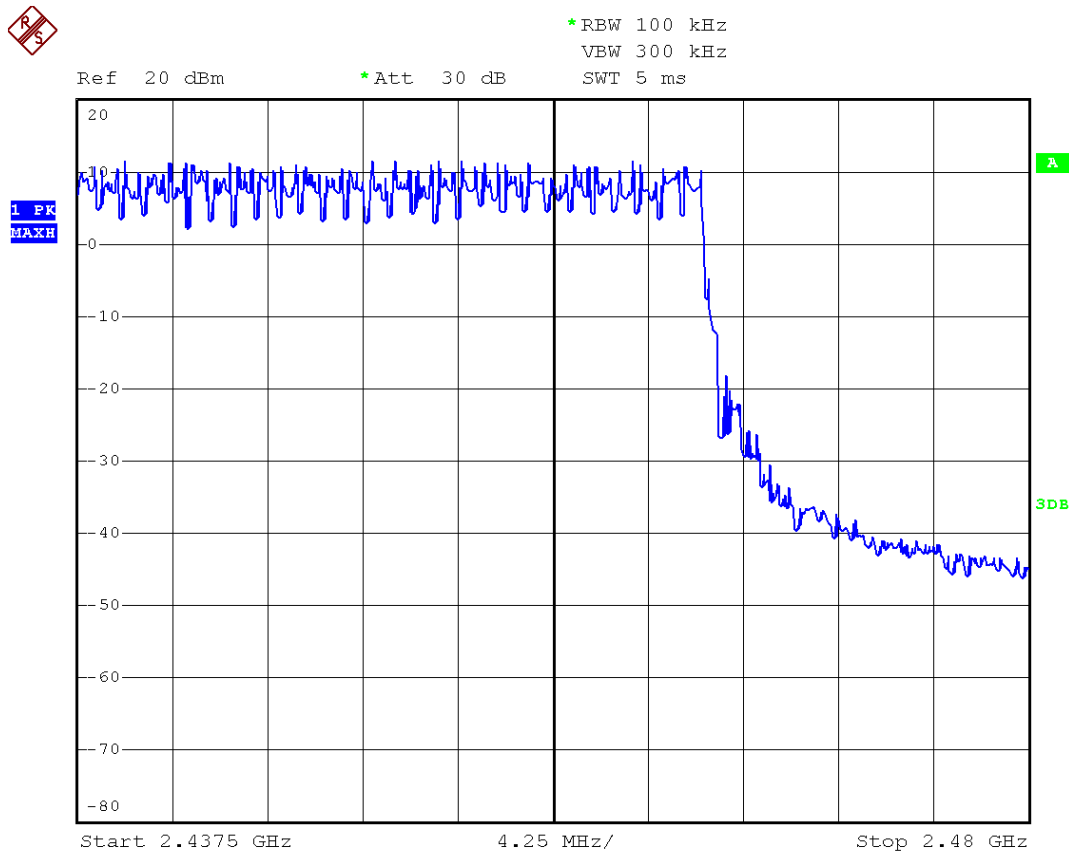

Figure 3: Number of Hopping Frequencies



### 6.3 Time of Occupy (Dwell Time) Measurement

#### Applicable Standard:

According to §15.247(a)(1)(iii), frequency hopping systems operating in the 2400MHz-2483.5 MHz. The average time of occupancy on any frequency shall not greater than 0.4 s within period of 0.4 seconds multiplied by the number of hopping channel employed.

According to RSS-210 issue 8, §A8.1 (d), frequency hopping systems operating in the 2400-2483.5MHz bands shall use at least 15 hopping channels. The average time of occupancy on any channel shall not be greater than 0.4 seconds within a period of 0.4 seconds multiplied by the number of hopping channels employed. Transmissions on particular hopping frequencies may be avoided or suppressed provided that a minimum of 15 hopping channels are used.

#### Test Procedure:

1. Connect the EUT RF output port to spectrum analyzer via calibrated coaxial cable and suitable attenuator (if necessary).
2. Activates the EUT system and execute the software prepared for test, if necessary.
3. To find out the maximum emission condition, the transmitting data rate of EUT is set to maximum data rate.
4. The span of spectrum analyzer was set to zero (sweep time 30msec). The occupied time at center on a hopping frequency was observed and recorded as "Ton".
5. The spectrums are scanned by using the spectrum analyzer (\*1). And the numbers of occupied channel per Nsec (period of 0.4 seconds multiplied by the number of hopping channels employed) were counted by using the delta-marker function of spectrum analyzer and recorded as "N".
6. The dwell time was calculated by  $T_{on} \times N$ .

Spectrum analyzer setup conditions:

Frequency span : Zero span

Resolution bandwidth : 1MHz

Video bandwidth :  $\cong$  RBW

Sweep : as necessary to capture the entire dwell time per hopping channel.

Detector function : Peak

Trace mode : Max Hold

**Test Result:**

|                |                                   |
|----------------|-----------------------------------|
| Temperature:   | 21 °C                             |
| Humidity:      | 50%                               |
| EUT Operation: | FHSS modulation with hopping mode |
| Test Date:     | December 30, 2013                 |

| [ ms ]Dwell Time   | [ ms ] Limit |
|--|--------------|
| 0.405ms x 156= 63.180  | < 400        |
| <i>Note: Test plots shown in figures 4 to 5 on pages 16.</i> |              |

Figure 4: Duration of One Transmission

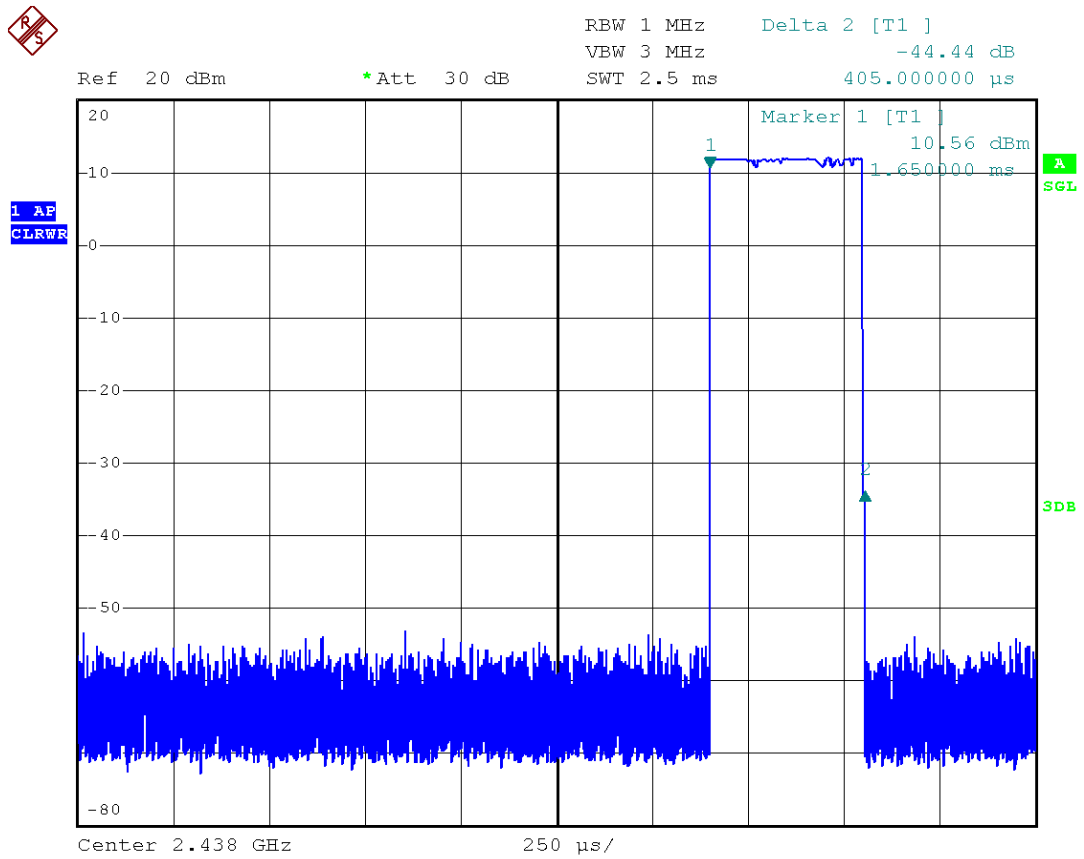
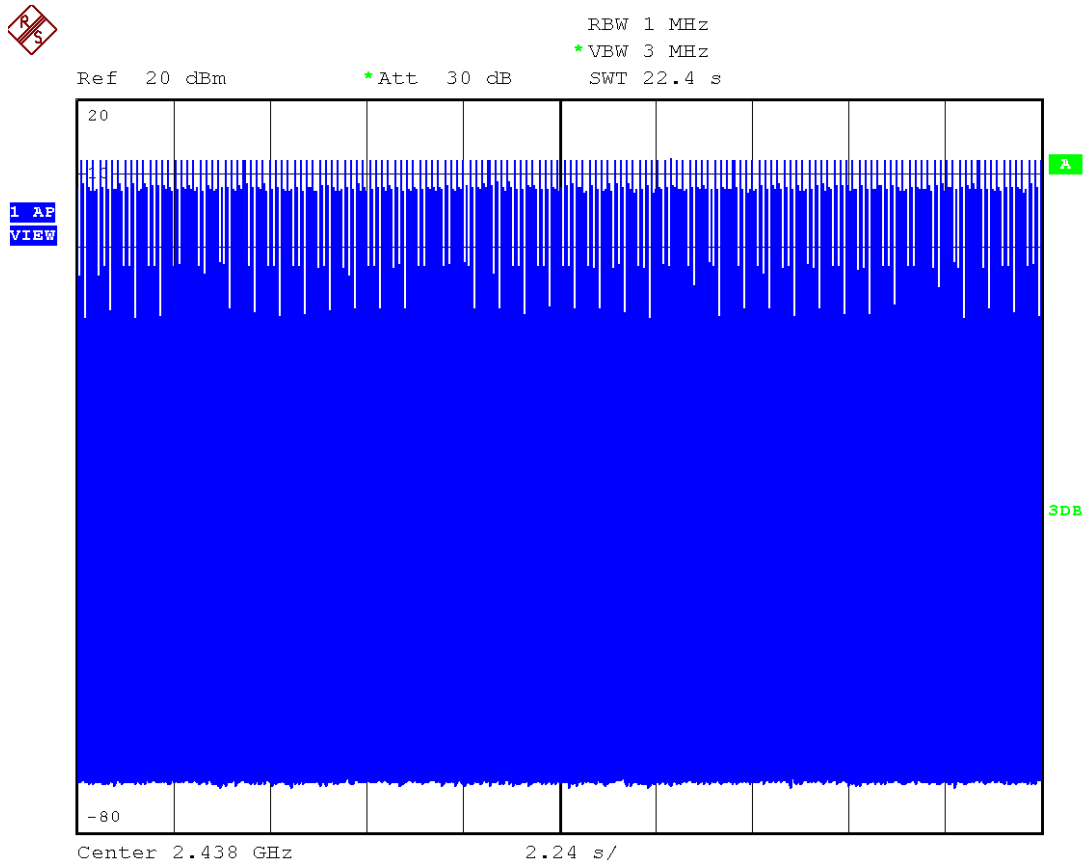

Figure 5: Number of Transmission at 30.4 s





**6.4 Peak Output Power Measurement****Applicable Standard:**

According to §15.247(b), 1) For frequency hopping systems operating in the 2400-2483.5 MHz band employing at least 75 hopping channels, and all frequency hopping systems in the 5725-5850MHz band: 1Watt. For all other frequency hopping systems in the 2400 – 2483.5MHz band: 0.125 Watts.3) For systems using digital modulation in the 902-928 MHz, 2400-2483.5 MHz, and 5725-5850 MHz bands: 1 Watt. As an alternative to a peak power measurement, compliance with the one Watt limit can be based on a measurement of the maximum conducted output power.

According to RSS-210 issue 8, §A8.4 (2), For frequency hopping systems operating in the 2400-2483.5 MHz band employing at least 75 hopping channels, the maximum conducted output power shall not exceed 1 W. For all other frequency hopping systems, the maximum peak conducted output power shall not exceed 0.125 W. (4) For systems employing digital modulation techniques operating in the bands 902-928 MHz, 2400-2483.5 MHz and 5725-5850 MHz, the maximum peak conducted output power shall not exceed 1 W.

**Test Procedure:**

1. Connect the EUT RF output port to spectrum analyzer via calibrated coaxial cable and suitable attenuator (if necessary).
2. Activates the EUT system and executes the software prepared for test, if necessary.
3. To find out the worst case, the transmitting data rate of EUT is varied with the different modes of operation. The final test condition is recorded in this report.
4. The spectrums are scanned and allow the trace to stabilize.
5. The peak output power was determined by using the marker-data function of spectrum analyzer or peak type power meter.

Spectrum analyzer setup conditions:

Frequency span : 5 times 20dB bandwidth of the emission being measured

Resolution bandwidth : 3MHz

Video bandwidth :  $\cong$  RBW

Sweep : Auto

Detector function : Peak

Trace mode : Max Hold

**Test Result:**

|                |  |
|----------------|--|
| Temperature:   | 21 °C  |
| Humidity:      | 51%  |
| EUT Operation: | FHSS without hopping and FHSS-DSSS hybrid mode |
| Test Date:     | January 02, 2014                               |

| Type of Modulation: FHSS |            |         |         |         |        |
|--------------------------|------------|---------|---------|---------|--------|
| Frequency                | Cable Loss | Reading | Power   | Limit   | Margin |
| [ MHz ]                  | [ dB ]     | [ dBm ] | [ dBm ] | [ dBm ] | [ dB ] |
| 2410                     | 1.0        | 11.61   | 12.61   | 30.00   | -17.39 |
| 2438                     | 1.0        | 11.52   | 12.52   | 30.00   | -17.48 |
| 2465                     | 1.0        | 11.36   | 12.36   | 30.00   | -17.64 |

*Note: Test plots shown in figures 6 to 8 on pages 19 to 20.*

| Type of Modulation: FHSS-DSSS hybrid |            |         |         |         |        |
|--------------------------------------|------------|---------|---------|---------|--------|
| Frequency                            | Cable Loss | Reading | Power   | Limit   | Margin |
| [ MHz ]                              | [ dB ]     | [ dBm ] | [ dBm ] | [ dBm ] | [ dB ] |
| 2410                                 | 1.0        | 11.00   | 12.00   | 30.00   | -18.00 |
| 2438                                 | 1.0        | 11.12   | 12.12   | 30.00   | -17.88 |
| 2465                                 | 1.0        | 11.09   | 12.09   | 30.00   | -17.91 |

*Note: Test plots shown in figures 9 to 11 on pages 20 to 21.*

Figure 6: Peak Output Power - Low Channel

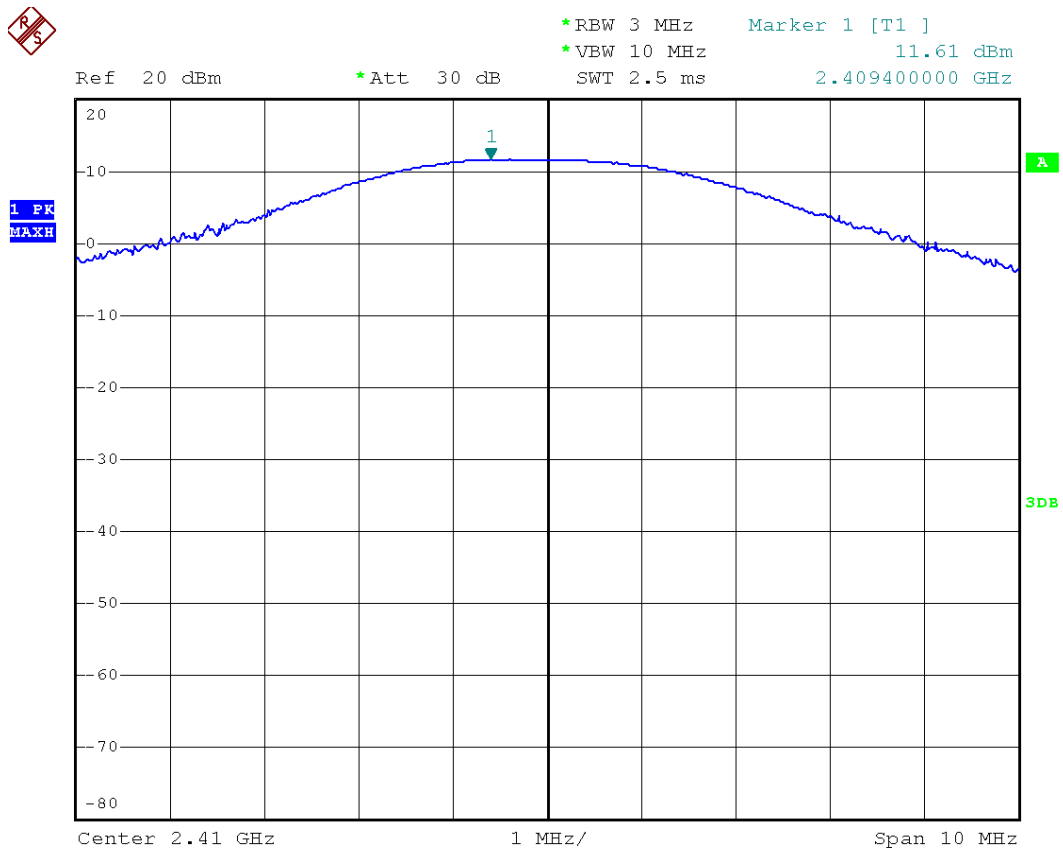

Figure 7: Peak Output Power - Middle Channel

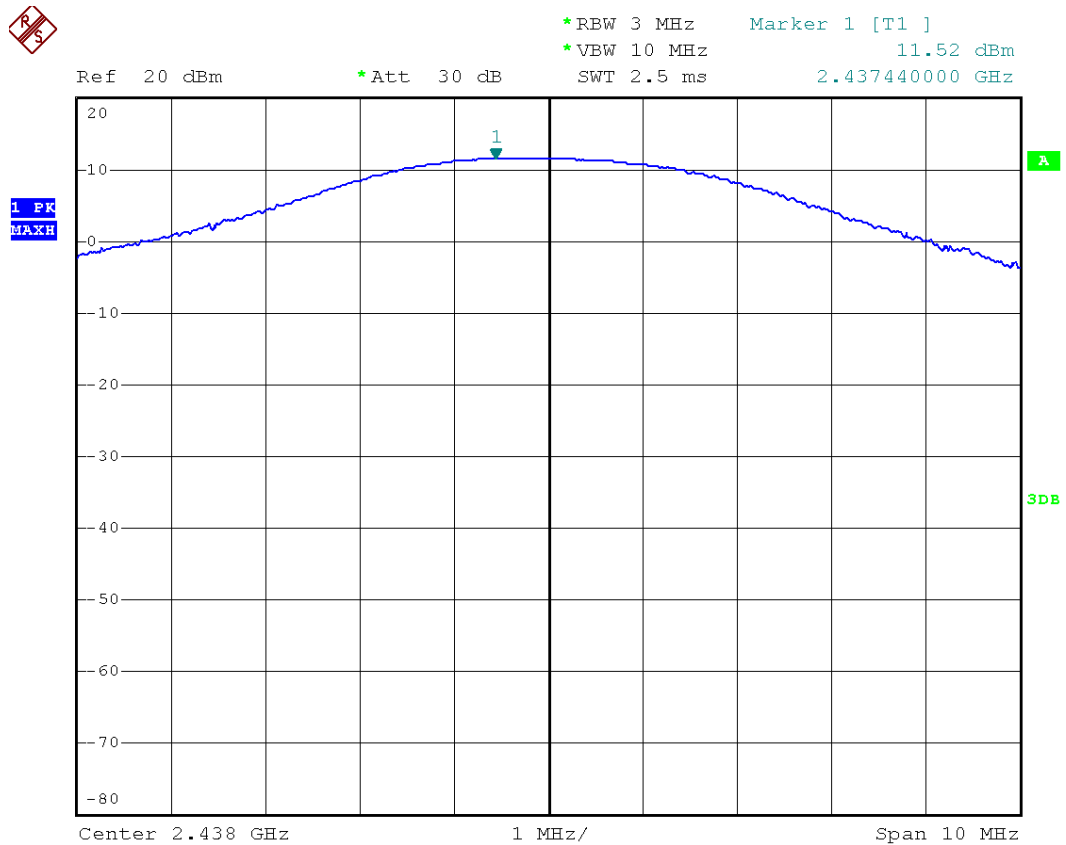

Figure 8: Peak Output Power - High Channel

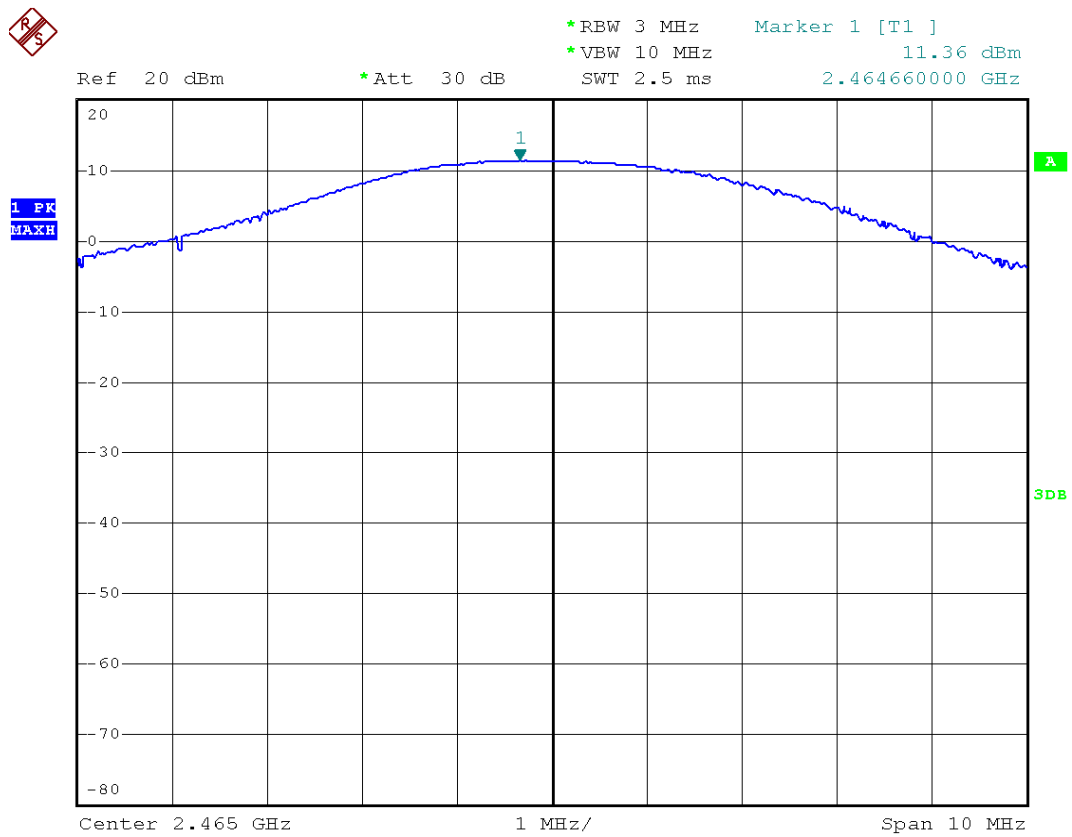

Figure 9: Peak Output Power - Low Channel

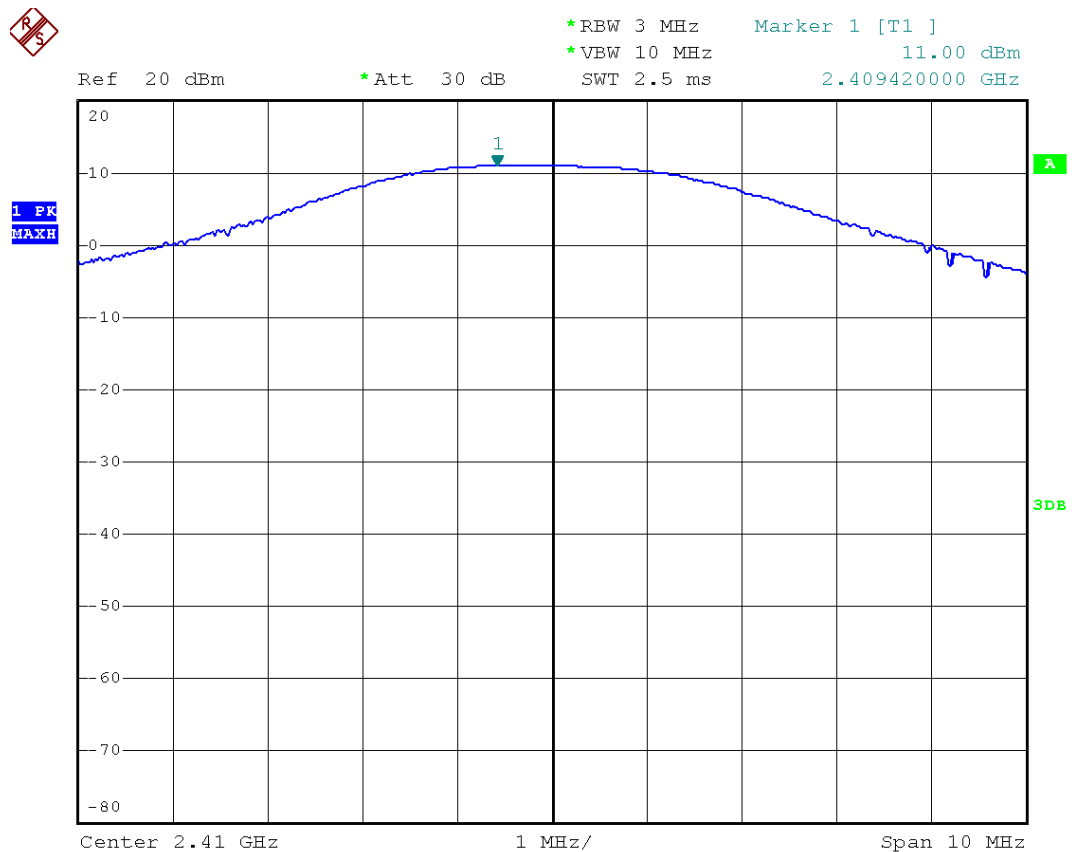

Figure 10: Peak Output Power - Middle Channel

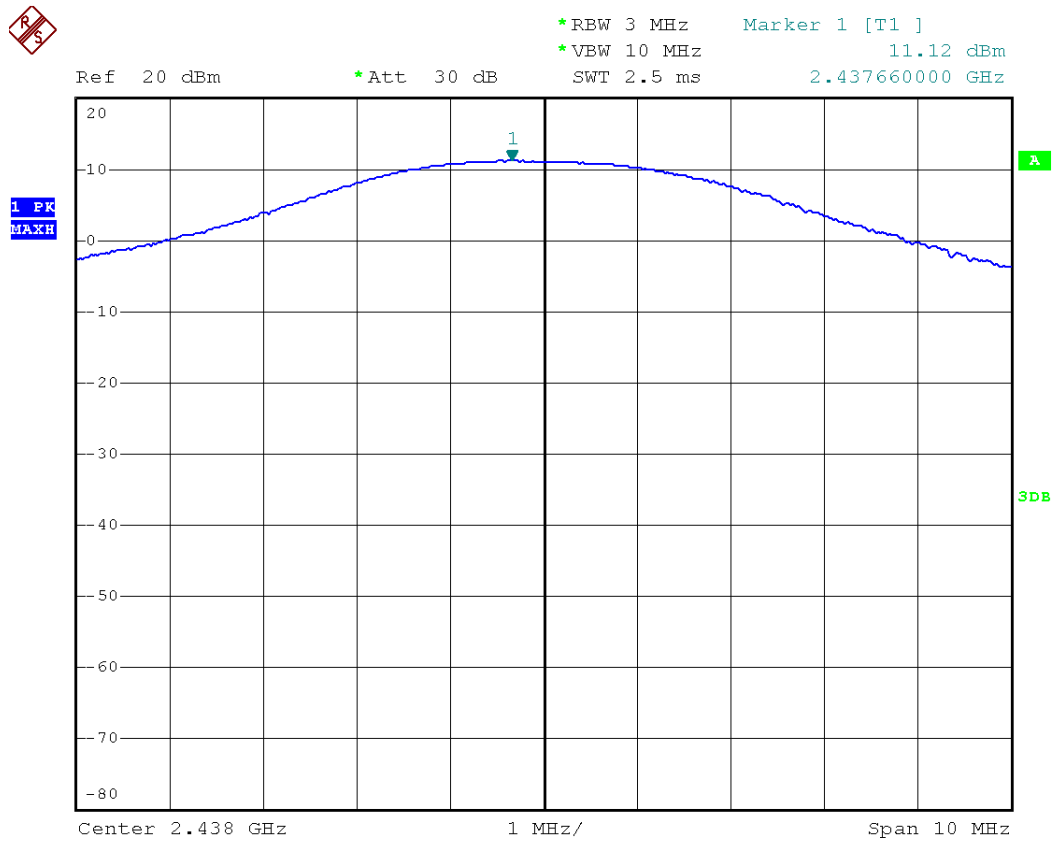
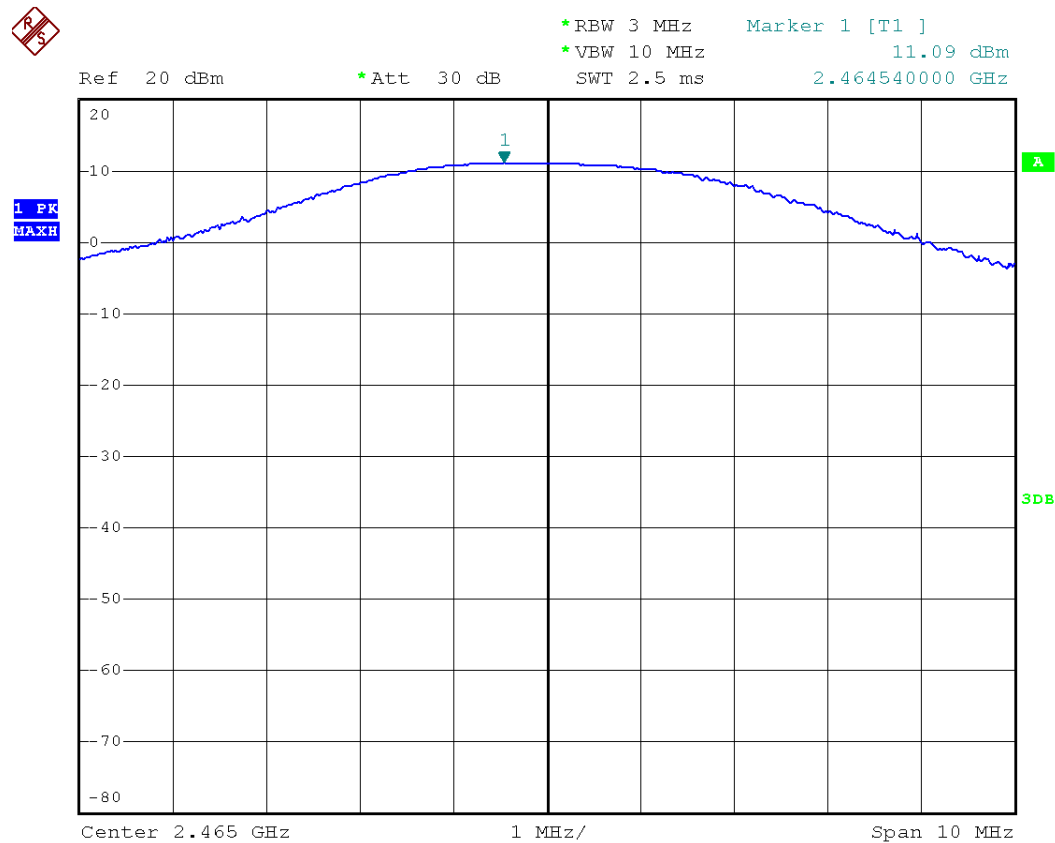

Figure 11: Peak Output Power - High Channel



## 6.5 Band Edge of Conducted Emission and Spurious RF Conducted Emissions

### Applicable Standard:

According to §15.247(d), in any 100 KHz bandwidth outside the frequency bands in which the spread spectrum intentional radiator is operating, the radio frequency power that is produced by the intentional radiator shall be at least 20dB below that in the 100KHz bandwidth within the band that contains the highest level of the desired power, In addition, radiated emissions which fall in the restricted bands, as defined in §15.205(a), must also comply with the radiated emission limits specified in 15.209(a).

According to RSS-210 issue 8, §A8.5, in any 100 kHz bandwidth outside the frequency band in which the spread spectrum or digitally modulated device is operating, the radio frequency power that is produced shall be at least 20 dB below that in the 100 kHz bandwidth within the band that contains the highest level of the desired power, based on either an RF conducted or a radiated measurement, provided the transmitter demonstrates compliance with the peak conducted power limits. If the transmitter complies with the conducted power limits based on the use of RMS averaging over a time interval, as permitted under section A8.4(4), the attenuation required shall be 30 dB instead of 20 dB. Attenuation below the general limits specified in Tables 2 and 3 is not required. In addition, radiated emissions which fall in the restricted bands of Table 1 must also comply with the radiated emission limits specified in Tables 2 and 3.

### Test Procedure:

1. Connect the EUT RF output port to the spectrum analyzer via calibrated coaxial cable and suitable attenuator (if necessary).
2. Activate the EUT System and execute the software prepared for test, if necessary.
3. To find out the maximum emission condition, the transmitting data rate of EUT is set to maximum data rate.
4. The spectrum is scanned.
5. The emission at the band edge or the highest modulation product outside of band were measured by using the marker function of spectrum analyzer (\*1).
6. The peak of the in-band emission were measured by using the marker to peak function of spectrum analyzer.
7. Above measurement were repeated at other side band edge.

### Spectrum analyzer setup conditions:

Frequency span : Wide enough to capture the peak level of emission on the band edge

Resolution bandwidth : 100kHz

Video bandwidth :  $\cong$  RBW

Sweep : Auto

Detector function : Peak

Trace mode : Max Hold

**Test Results:**

|                |   |
|----------------|---|
| Temperature:   | 21°C  |
| Humidity:      | 51%   |
| EUT Operation: | Transmission with/without hopping in FHSS and FHSS-DSSS hybrid mode |
| Test Date:     | January 02, 2014  |

The unit does meet the requirement.

*Note: Test plots shown in figures 12 to 23 on pages 24 to 29*

Figure 12: Band Edge - Low frequency side in FHSS mode without hopping

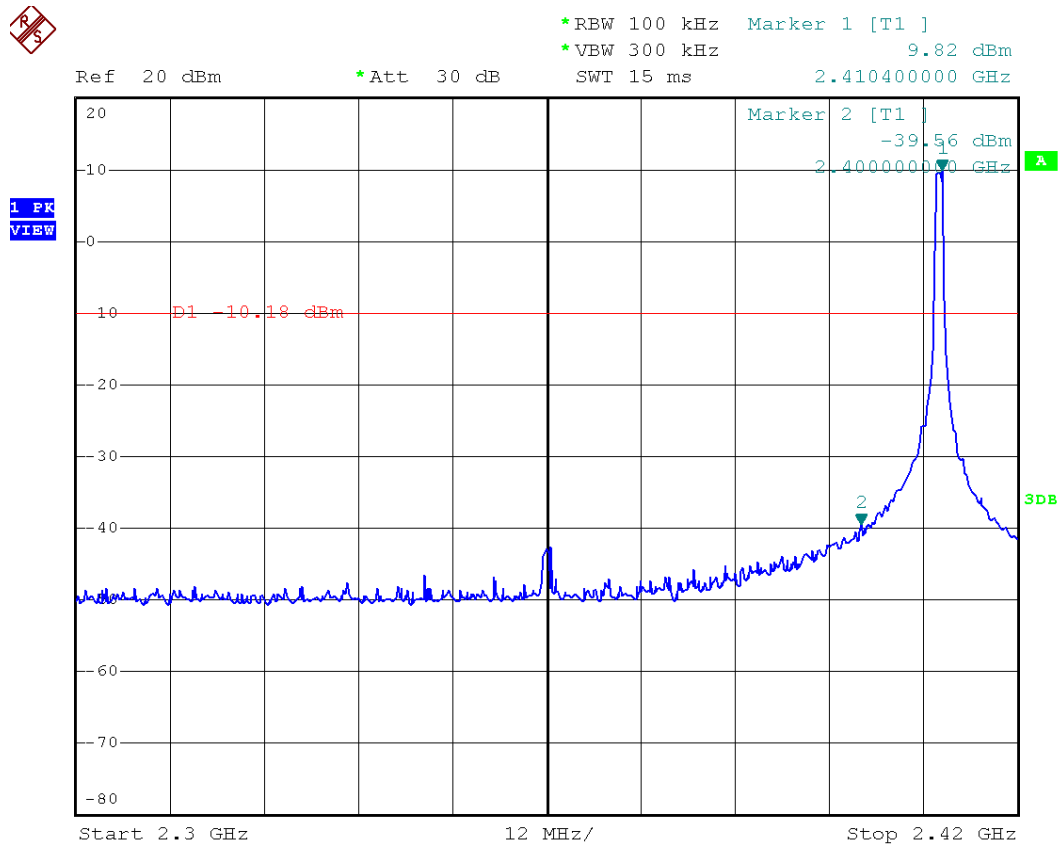

Figure 13: Band Edge – High frequency side in FHSS mode without hopping

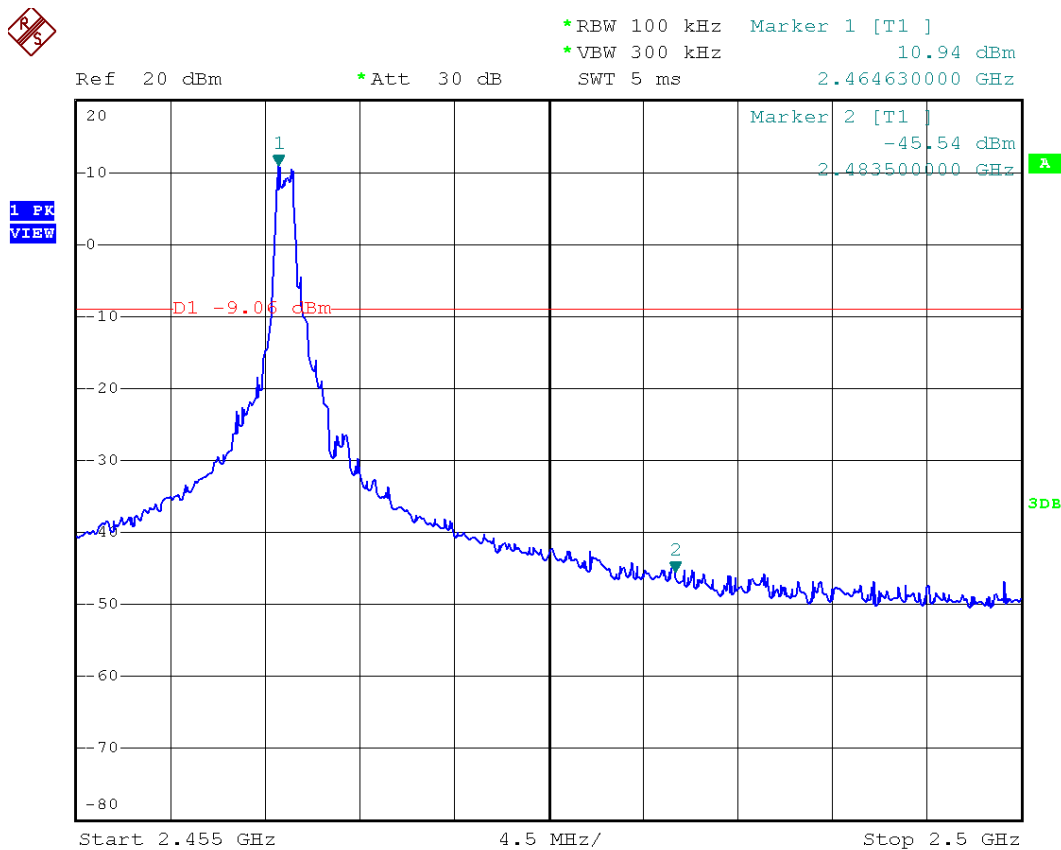



Figure 14: Band Edge – Low frequency side in FHSS mode with hopping

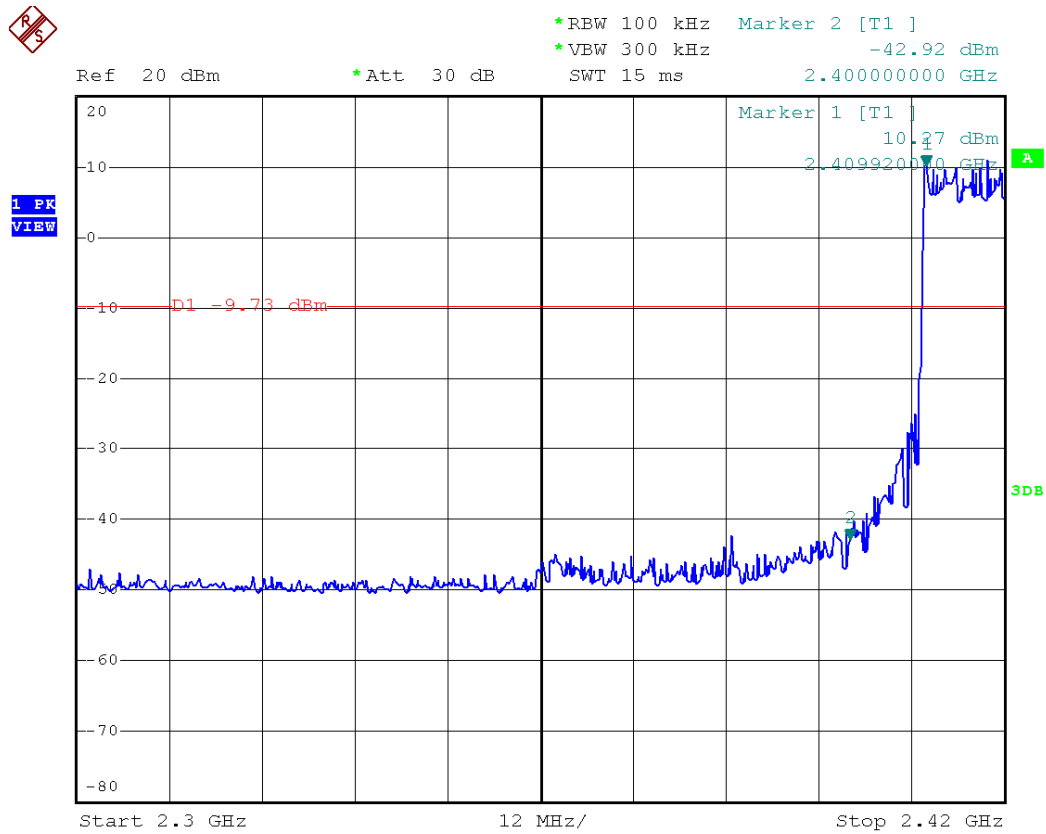

Figure 15: Band Edge – High frequency side in FHSS mode with hopping

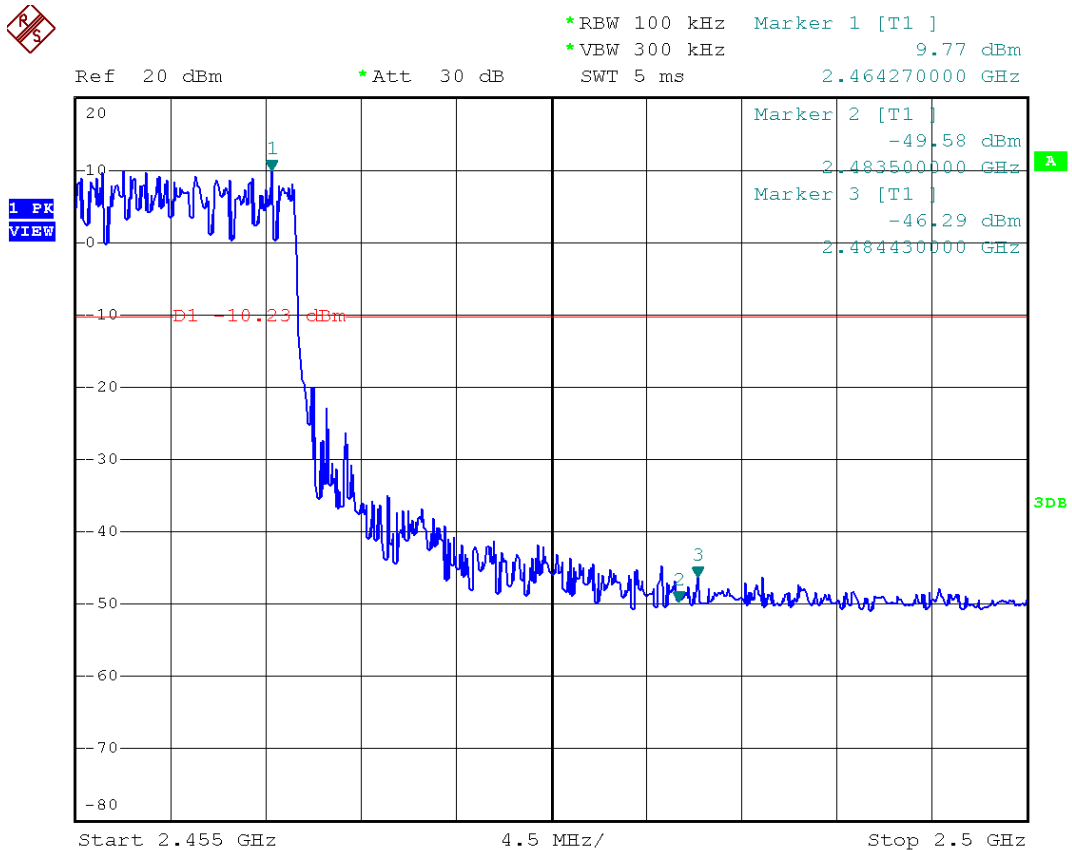

Figure 16 Conducted Spurious Emissions - Low channel in FHSS mode

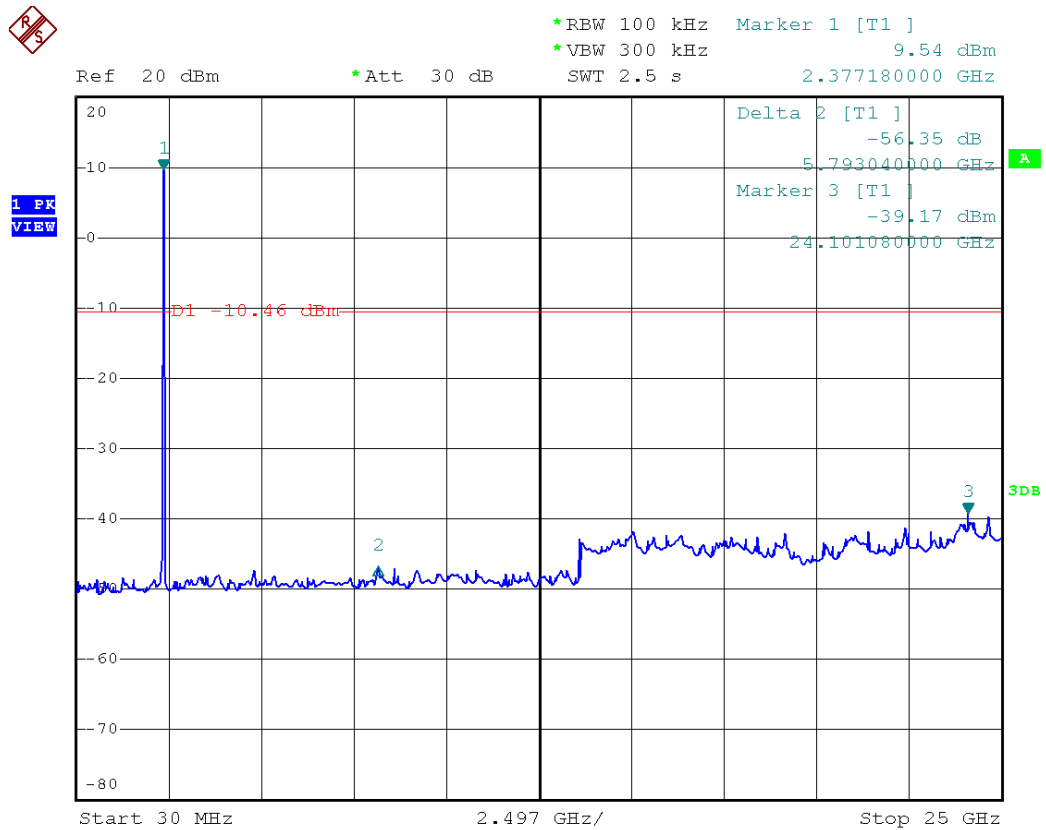

Figure 17 Conducted Spurious Emissions - Middle channel in FHSS mode

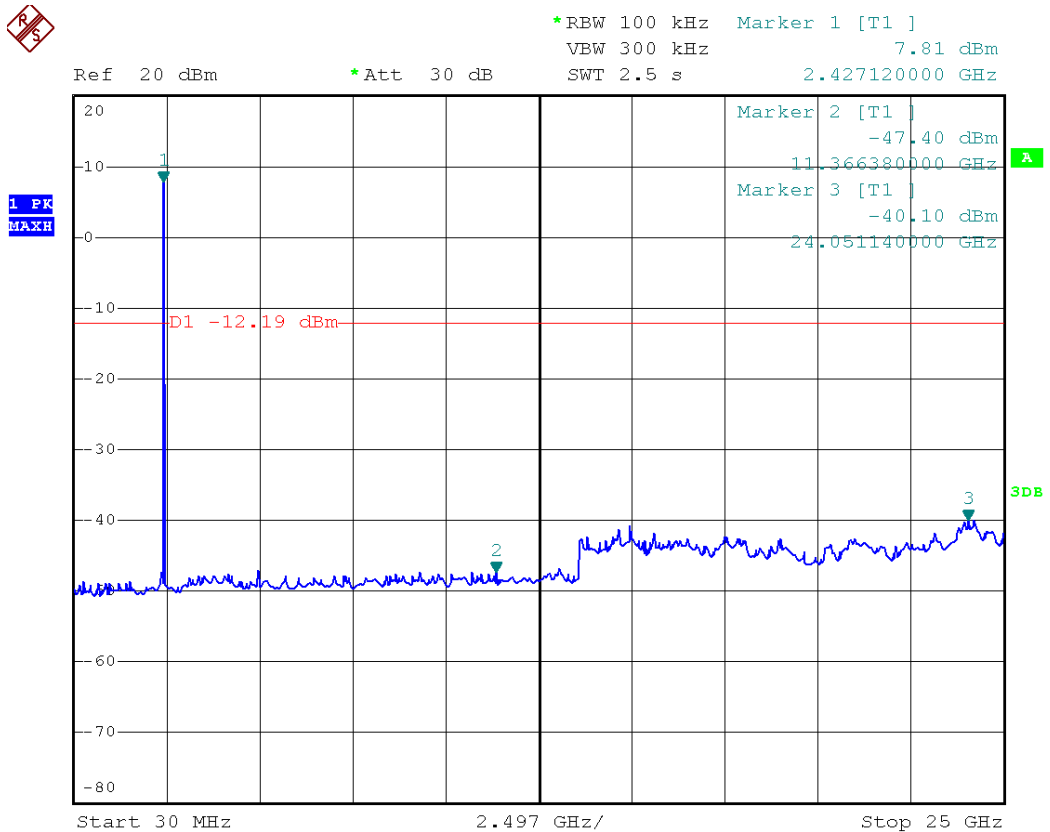

Figure 18 Conducted Spurious Emissions - High channel in FHSS mode

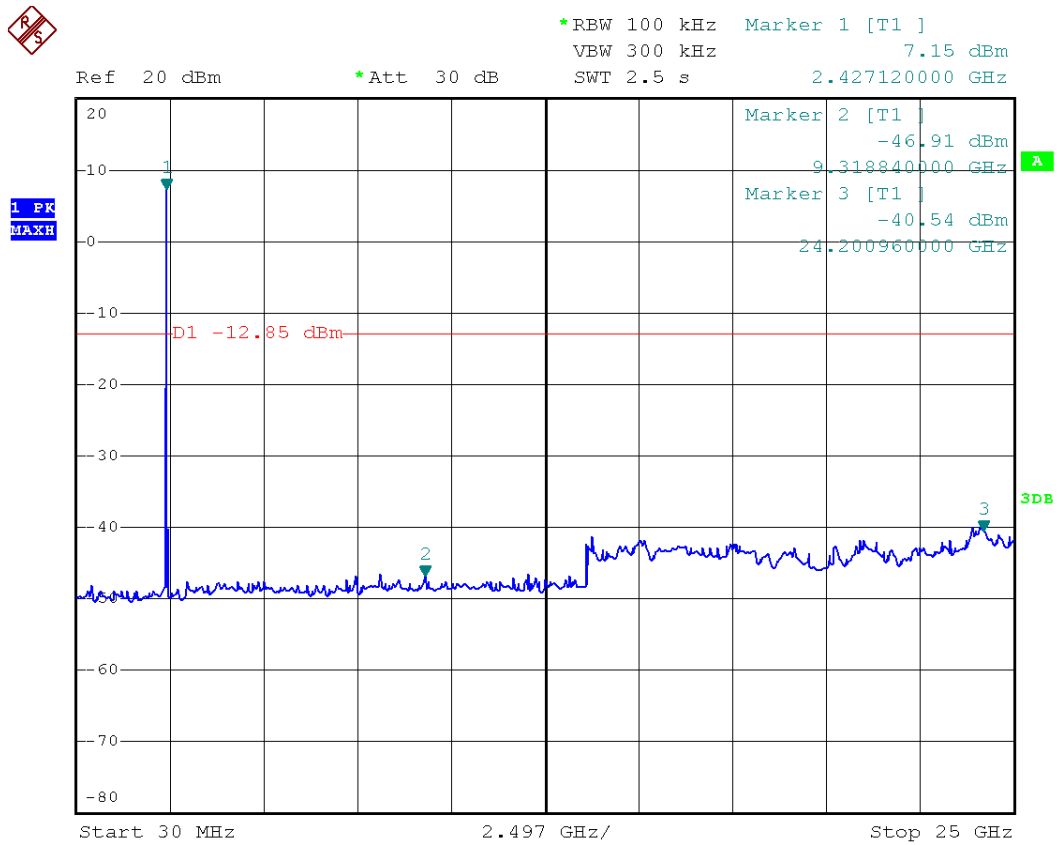

Figure 19: Band Edge - Low frequency side in FHSS-DSSS mode without hopping

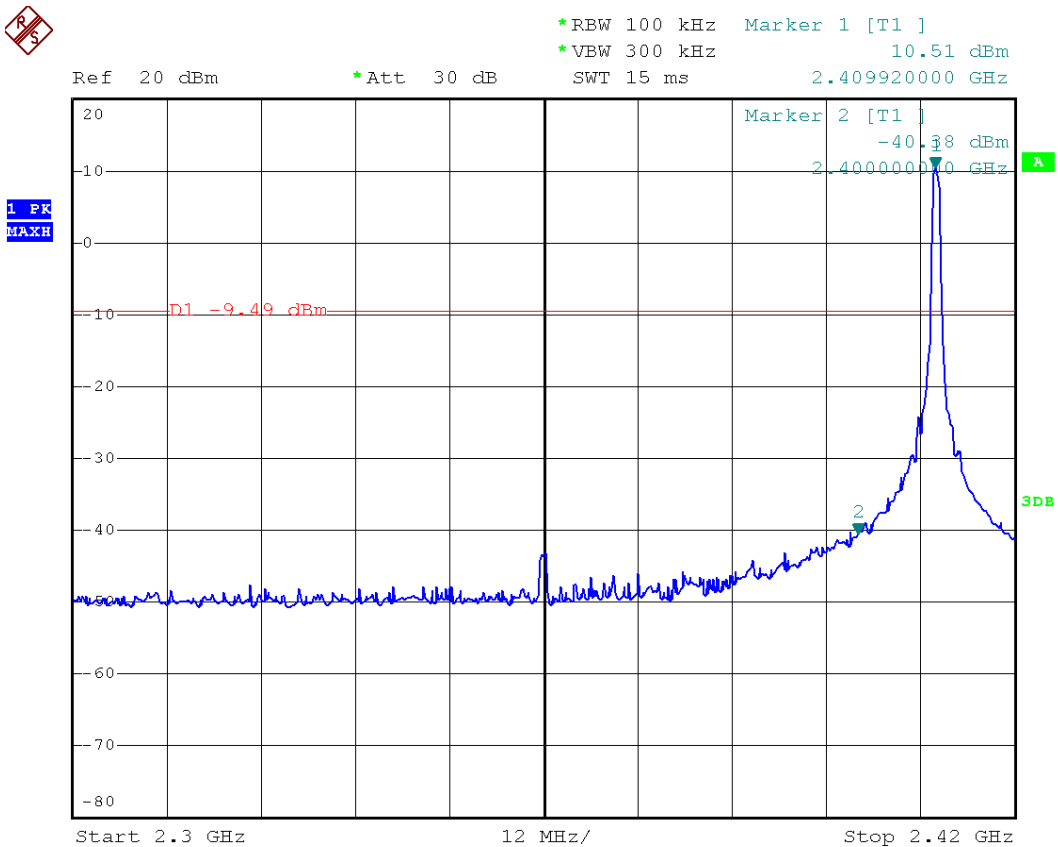

Figure 20: Band Edge – High frequency side in FHSS-DSSS mode without hopping

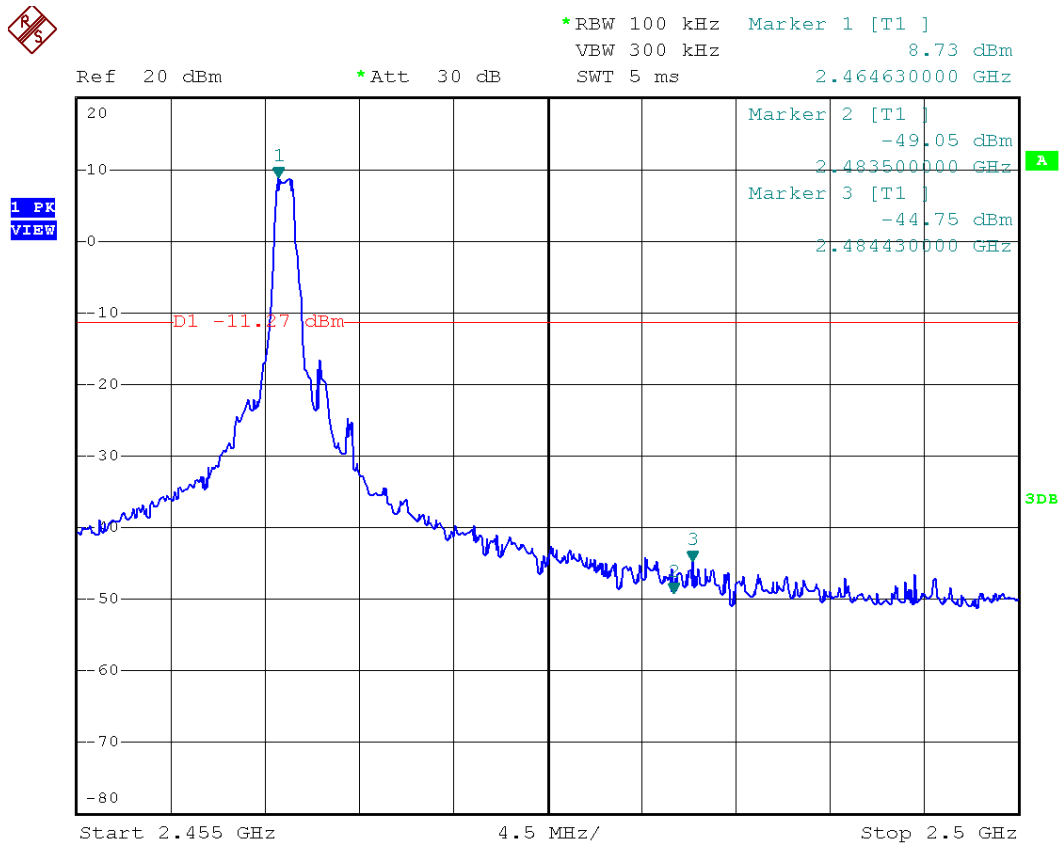
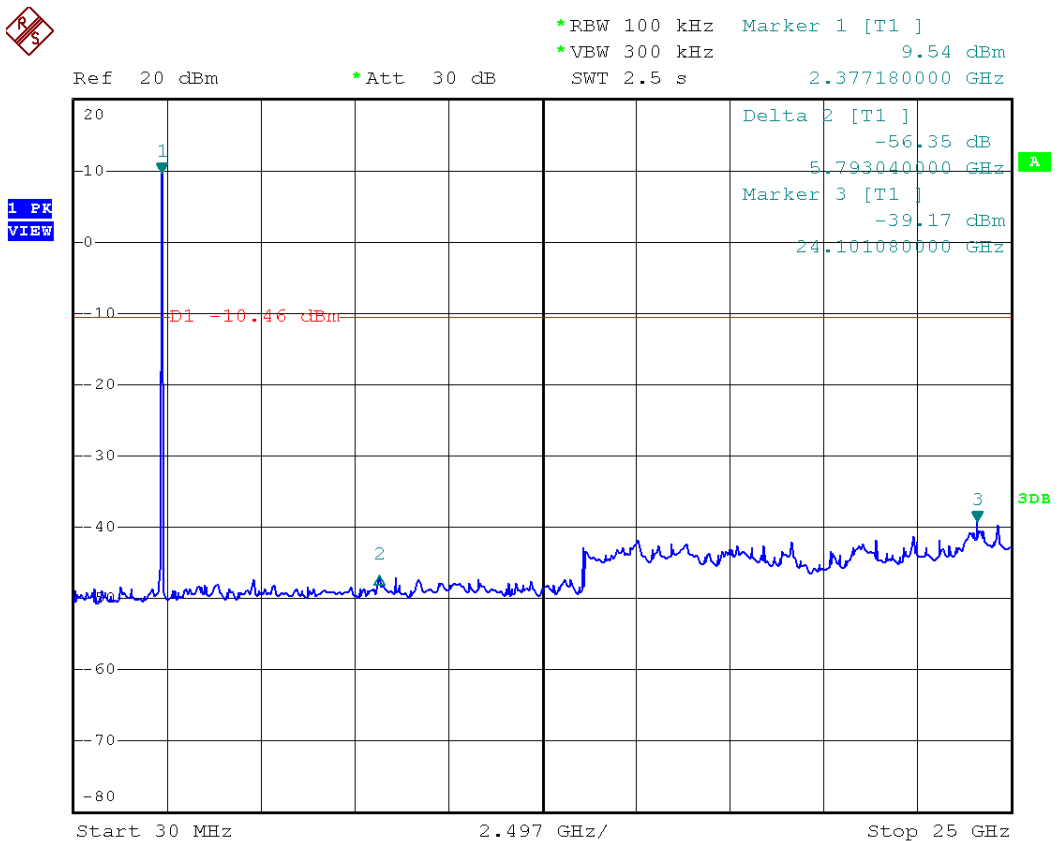

Figure 21 Conducted Spurious Emissions - Low channel in FHSS-DSSS mode





## 6.6 Spurious Radiated Emission Measurement

### Applicable Standard:

According to §15.247(c), all other emissions outside these bands shall not exceed the general radiated emission limits specified in §15.209(a). And according to §15.33(a)(1), for an intentional radiator operates below 10GHz, the frequency range of measurements: to the tenth harmonic of the highest fundamental frequency or to 40GHz, whichever is lower. According to §15.31(o), the amplitude of spurious emissions from intentional radiators and emissions from unintentional radiators which are attenuated more than 20 dB below the permissible value need not be reported unless specifically required elsewhere in this part.

According to RSS-210 issue 8, §A8.5, in any 100 kHz bandwidth outside the frequency band in which the spread spectrum or digitally modulated device is operating, the radio frequency power that is produced shall be at least 20 dB below that in the 100 kHz bandwidth within the band that contains the highest level of the desired power, based on either an RF conducted or a radiated measurement, provided the transmitter demonstrates compliance with the peak conducted power limits. If the transmitter complies with the conducted power limits based on the use of RMS averaging over a time interval, as permitted under section A8.4(4), the attenuation required shall be 30 dB instead of 20 dB. Attenuation below the general limits specified in Tables 2 and 3 is not required. In addition, radiated emissions which fall in the restricted bands of Table 1 must also comply with the radiated emission limits specified in Tables 2 and 3.

### Test Procedure:

1. The EUT was placed on a turn table which is 0.8m above ground plane.
2. The turn table shall rotate 360 degrees to determine the position of maximum emission level.
3. EUT is set 3m away from the receiving antenna which varied from 1m to 4m to find out the highest emissions.
4. Maximum procedure was performed on the six highest emissions to ensure EUT compliance.
5. And also, each emission was to be maximized by changing the polarization of receiving antenna both horizontal and vertical.
6. Repeat above procedures until all frequency measured were complete.

The field strength is calculated by adding the Antenna Factor and Cable Factor and subtracting the Amplifier Gain and Duty Cycle Correction Factor(if any) from the measured reading. The basic equation with a sample calculation is as follows:

$$FS = RA + AF + CL - AG$$

|                           |  |
|---------------------------|--|
| Where FS = Field Strength | CL = Cable Attenuation Factor (Cable Loss) |
| RA = Reading Amplitude    | AG = Amplifier Gain                        |
| AF = Antenna Factor       |  |

Test Configuration between 9K to 1 GHz:

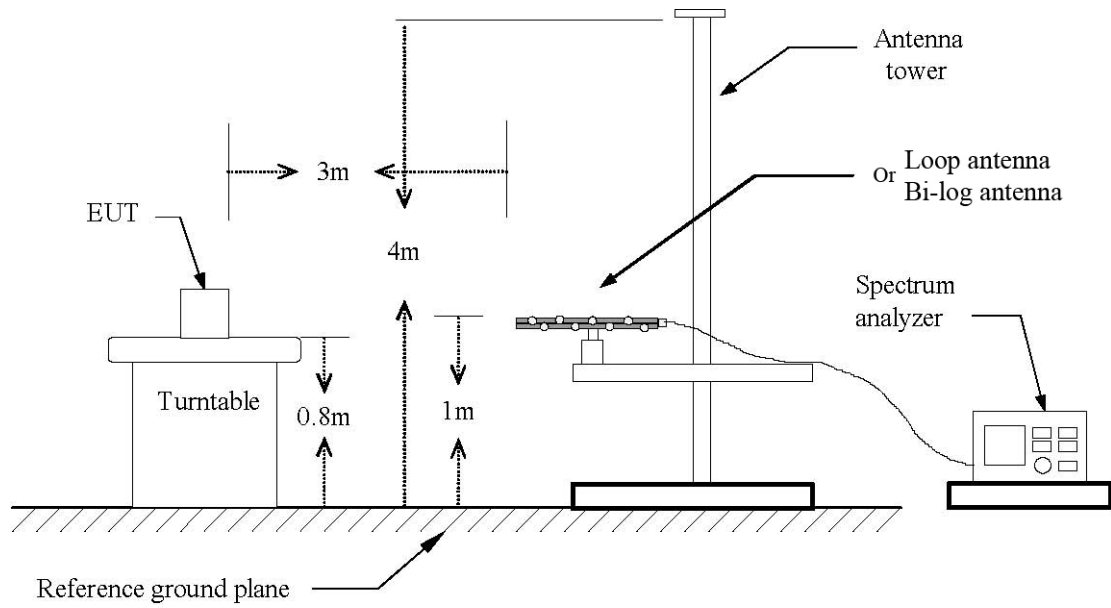

Test Configuration above 1 GHz:

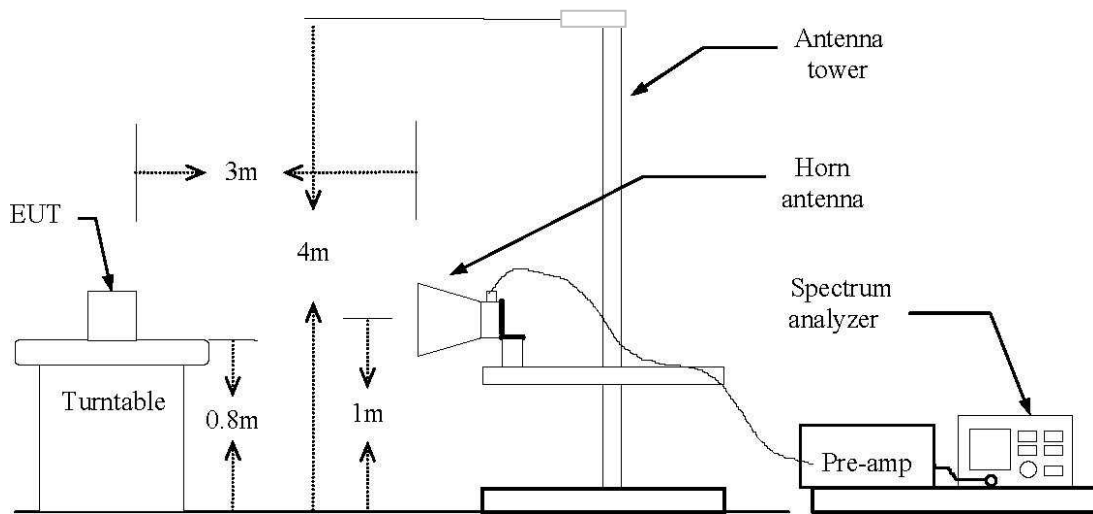

**Test Results:**

|                |   |
|----------------|---|
| Temperature:   | 22°C  |
| Humidity:      | 51%   |
| EUT Operation: | FHSS modulation without hopping and FHSS-DSSS hybrid mode |
| Test Date:     | January 03, 2014  |



**Spurious Emission In the Frequency Rang between 9kHz to 1GHz:**

Pre-scan the EUT in FHSS and FHSS-DSSS hybrid modulation respectively and find out the worst case is the FHSS modulation in transmitting.

Fc= 2410MHz Transmitting Operation

| Freq. (MHz) | Ant.Pol. (H/V) | Detector Mode (PK/QP) | Reading (dBuV) | Ant./CL/ Amp.CF (dB) | Actual FS (dBuV/m) | Limit 3m (dBuV/m) | Margin (dB) |
|-------------|----------------|-----------------------|----------------|----------------------|--------------------|-------------------|-------------|
| 30.30       | H              | QP                    | 3.9            | 16.7                 | 20.6               | 40.0              | -19.4       |
| 172.02      | H              | QP                    | 15.8           | 10.2                 | 26.0               | 43.5              | -16.5       |
| 180.00      | H              | QP                    | 20.4           | 6.7                  | 27.1               | 43.5              | -16.4       |
| 30.90       | V              | QP                    | 4.8            | 16.7                 | 21.5               | 40.0              | -18.5       |
| 172.02      | V              | QP                    | 22.0           | 10.2                 | 32.2               | 43.5              | -11.3       |
| 180.00      | V              | QP                    | 28.2           | 6.7                  | 34.9               | 43.5              | -8.6        |
| -           | -              | -                     | -              | -                    | -                  | -                 | -           |

Fc= 2438MHz Transmitting Operation

| Freq. (MHz) | Ant.Pol. (H/V) | Detector Mode (PK/QP) | Reading (dBuV) | Ant./CL/ Amp.CF (dB) | Actual FS (dBuV/m) | Limit 3m (dBuV/m) | Margin (dB) |
|-------------|----------------|-----------------------|----------------|----------------------|--------------------|-------------------|-------------|
| 30.50       | H              | QP                    | 4.5            | 16.7                 | 21.2               | 40.0              | -18.8       |
| 172.00      | H              | QP                    | 15.6           | 10.2                 | 25.8               | 43.5              | -17.7       |
| 180.00      | H              | QP                    | 20.8           | 6.7                  | 27.5               | 43.5              | -16.0       |
| 30.80       | V              | QP                    | 5.4            | 16.7                 | 22.1               | 40.0              | -17.9       |
| 172.00      | V              | QP                    | 21.7           | 10.2                 | 31.9               | 43.5              | -11.6       |
| 180.00      | V              | QP                    | 27.6           | 6.7                  | 34.3               | 43.5              | -9.2        |
| -           | -              | -                     | -              | -                    | -                  | -                 | -           |

Fc= 2465MHz Transmitting Operation

| Freq. (MHz) | Ant.Pol. (H/V) | Detector Mode (PK/QP) | Reading (dBuV) | Ant./CL/ Amp.CF (dB) | Actual FS (dBuV/m) | Limit 3m (dBuV/m) | Margin (dB) |
|-------------|----------------|-----------------------|----------------|----------------------|--------------------|-------------------|-------------|
| 31.20       | H              | QP                    | 4.2            | 16.7                 | 20.9               | 40.0              | -19.1       |
| 172.04      | H              | QP                    | 16.3           | 10.2                 | 26.5               | 43.5              | -17.0       |
| 180.04      | H              | QP                    | 20.6           | 6.7                  | 27.3               | 43.5              | -16.2       |
| 31.00       | V              | QP                    | 5.4            | 16.7                 | 22.1               | 40.0              | -17.9       |
| 172.04      | V              | QP                    | 22.4           | 10.2                 | 32.6               | 43.5              | -10.9       |
| 180.04      | V              | QP                    | 27.6           | 6.7                  | 34.3               | 43.5              | -9.2        |
| -           | -              | -                     | -              | -                    | -                  | -                 | -           |

*Note: For spurious emission measurement, the compliance tests were performed both of horizontally and vertically placed in EUT(X position, Y position, Z position). As a result, the data of operation mode that produce the maximum emission were reported. The other emissions shown “-“ are more than 20dB below the limits.*

**Spurious Emission In the Frequency Rang above 1GHz:**

Pre-scan the EUT in FHSS and FHSS-DSSS hybrid modulation and find out the worst case is the FHSS modulation mode in transmitting.

Fc= 2410MHz Transmitting Operation - Horizontal

| Freq. (MHz) | Peak Reading (dBuV) | AV Reading (dBuV) | Ant./CL/ Amp.CF (dB) | Actual FS     |             | Peak Limit (dBuV/m) | AV Limit (dBuV/m) | Margin |
|-------------|---------------------|-------------------|----------------------|---------------|-------------|---------------------|-------------------|--------|
|             |                     |                   |                      | Peak (dBuV/m) | AV (dBuV/m) |                     |                   |        |
| 4807.00     | 62.29               | 38.89             | 0.92                 | 63.21         | 39.81       | 74.00               | 54.00             | -10.79 |
| 7213.40     | 53.21               | 35.99             | 4.22                 | 57.43         | 40.21       | 74.00               | 54.00             | -13.79 |
| 9638.60     | 50.89               | 33.16             | 7.70                 | 58.59         | 40.86       | 74.00               | 54.00             | -13.14 |
| -           | -                   | -                 | -                    | -             | -           | -                   | -                 | -      |

Fc= 2410MHz Transmitting Operation - Vertical

| Freq. (MHz) | Peak Reading (dBuV) | AV Reading (dBuV) | Ant./CL/ Amp.CF (dB) | Actual FS     |             | Peak Limit (dBuV/m) | AV Limit (dBuV/m) | Margin |
|-------------|---------------------|-------------------|----------------------|---------------|-------------|---------------------|-------------------|--------|
|             |                     |                   |                      | Peak (dBuV/m) | AV (dBuV/m) |                     |                   |        |
| 4808.00     | 66.05               | 39.34             | 0.92                 | 66.97         | 40.26       | 74.00               | 54.00             | -7.03  |
| 7213.40     | 55.99               | 37.73             | 4.22                 | 60.21         | 41.95       | 74.00               | 54.00             | -12.05 |
| 9638.60     | 50.91               | 34.34             | 7.70                 | 58.61         | 42.04       | 74.00               | 54.00             | -11.96 |
| -           | -                   | -                 | -                    | -             | -           | -                   | -                 | -      |

*Note: Data of measurement within this frequency range shown “-” in the table above means the reading of emissions are attenuated more than 20dB below the permissible limits or the field strength is too small to be measured.*

Fc= 2438MHz Transmitting Operation - Horizontal

| Freq. (MHz) | Peak Reading (dBuV) | AV Reading (dBuV) | Ant./CL/ Amp.CF (dB) | Actual FS     |             | Peak Limit (dBuV/m) | AV Limit (dBuV/m) | Margin |
|-------------|---------------------|-------------------|----------------------|---------------|-------------|---------------------|-------------------|--------|
|             |                     |                   |                      | Peak (dBuV/m) | AV (dBuV/m) |                     |                   |        |
| 4878.00     | 61.76               | 38.83             | 0.92                 | 62.68         | 39.75       | 74.00               | 54.00             | -11.32 |
| 7336.00     | 54.11               | 35.74             | 4.22                 | 58.33         | 39.96       | 74.00               | 54.00             | -14.04 |
| 9750.00     | 51.01               | 32.82             | 7.70                 | 58.71         | 40.52       | 74.00               | 54.00             | -13.48 |
| -           | -                   | -                 | -                    | -             | -           | -                   | -                 | -      |

Fc= 2438MHz Transmitting Operation - Vertical

| Freq. (MHz) | Peak Reading (dBuV) | AV Reading (dBuV) | Ant./CL/ Amp.CF (dB) | Actual FS     |             | Peak Limit (dBuV/m) | AV Limit (dBuV/m) | Margin |
|-------------|---------------------|-------------------|----------------------|---------------|-------------|---------------------|-------------------|--------|
|             |                     |                   |                      | Peak (dBuV/m) | AV (dBuV/m) |                     |                   |        |
| 4878.00     | 64.42               | 39.21             | 0.92                 | 65.34         | 40.13       | 74.00               | 54.00             | -8.66  |
| 7336.00     | 55.55               | 37.40             | 4.22                 | 59.77         | 41.62       | 74.00               | 54.00             | -12.38 |
| 9750.00     | 50.56               | 33.64             | 7.70                 | 58.26         | 41.34       | 74.00               | 54.00             | -12.66 |
| -           | -                   | -                 | -                    | -             | -           | -                   | -                 | -      |

*Note: Data of measurement within this frequency range shown “-” in the table above means the reading of emissions are attenuated more than 20dB below the permissible limits or the field strength is too small to be measured.*

Fc= 2465MHz Transmitting Operation - Horizontal

| Freq. (MHz) | Peak Reading (dBuV) | AV Reading (dBuV) | Ant./CL/ Amp.CF (dB) | Actual FS     |             | Peak Limit (dBuV/m) | AV Limit (dBuV/m) | Margin |
|-------------|---------------------|-------------------|----------------------|---------------|-------------|---------------------|-------------------|--------|
|             |                     |                   |                      | Peak (dBuV/m) | AV (dBuV/m) |                     |                   |        |
| 4938.00     | 61.21               | 38.52             | 0.92                 | 62.13         | 39.44       | 74.00               | 54.00             | -11.87 |
| 7395.00     | 53.46               | 35.45             | 4.22                 | 57.68         | 39.67       | 74.00               | 54.00             | -14.33 |
| 9958.00     | 49.85               | 32.46             | 7.70                 | 57.55         | 40.16       | 74.00               | 54.00             | -13.84 |
| -           | -                   | -                 | -                    | -             | -           | -                   | -                 | -      |

Fc= 2465MHz Transmitting Operation - Vertical

| Freq. (MHz) | Peak Reading (dBuV) | AV Reading (dBuV) | Ant./CL/ Amp.CF (dB) | Actual FS     |             | Peak Limit (dBuV/m) | AV Limit (dBuV/m) | Margin |
|-------------|---------------------|-------------------|----------------------|---------------|-------------|---------------------|-------------------|--------|
|             |                     |                   |                      | Peak (dBuV/m) | AV (dBuV/m) |                     |                   |        |
| 4938.00     | 64.50               | 39.23             | 0.92                 | 65.42         | 40.15       | 74.00               | 54.00             | -8.58  |
| 7395.00     | 55.56               | 36.15             | 4.22                 | 59.78         | 40.37       | 74.00               | 54.00             | -13.63 |
| 9958.00     | 50.75               | 33.88             | 7.70                 | 58.45         | 41.58       | 74.00               | 54.00             | -12.42 |
| -           | -                   | -                 | -                    | -             | -           | -                   | -                 | -      |

*Note: Data of measurement within this frequency range shown “--- ” in the table above means the reading of emissions are attenuated more than 20dB below the permissible limits or the field strength is too small to be measured.*

## 6.7 Conducted Emission Measurement

### Applicable Standard:

According to §15.207(a), except as shown in paragraphs (b) and (c) of this section, for an intentional radiator that is designed to be connected to the public utility (AC) power line, the radio frequency voltage that is conducted back onto the AC power line on any frequency or frequencies within the band 150 kHz to 30 MHz shall not exceed the limits in the following table, as measured using a 50  $\mu$ H/50 ohms line impedance stabilization network (LISN). Compliance with the provisions of this paragraph shall be based on the measurement of the radio frequency voltage between each power line and ground at the power terminal. The lower limit applies at the boundary between the frequency ranges.

| Frequency of Emission (MHz) | Conducted Limit (dB $\mu$ V) |           |
|-----------------------------|------------------------------|-----------|
|                             | Quasi-peak                   | Average   |
| 0.15 ~ 0.5                  | 66 to 56*                    | 56 to 46* |
| 0.5 ~ 5                     | 56                           | 46        |
| 5 ~ 30                      | 60                           | 50        |

Note: \*Decreases with the logarithm of the frequency.

Measurements to demonstrate compliance with the conducted limits are not required for devices which only employ battery power for operation and which do not operate from the AC power lines or contain provisions for operation while connected to the AC power lines. Devices that include, or make provisions for, the use of battery chargers which permit operating while charging, AC adapters or battery eliminators or that connect to the AC power lines indirectly, obtaining their power through another device which is connected to the AC power lines, shall be tested to demonstrate compliance with the conducted limits.

According to RSS-GEN Section 7.2.2, the purpose of this test is to measure unwanted radio frequency currents induced in any AC conductor external to the equipment which could conduct interference to other equipment via the AC electrical network. Except when the requirements applicable to a given device state otherwise, for any license-exempt radio communication device equipped to operate from the public utility AC power supply, either directly or indirectly, the radio frequency voltage that is conducted back onto the AC power lines in the frequency range of 0.15 MHz to 30 MHz shall not exceed the limits shown in Table 2. The tighter limit applies at the frequency range boundaries.

The conducted emissions shall be measured with a 50 ohm/50 microhenry line impedance stabilization network.

**Test Procedure:**

1. The EUT was placed on a table which is at least 0.8 m high. Place the EUT so that it is 0.4 m from the wall of the shielding room, or place the EUT on a table which is 0.4 m high so that the bottom of the EUT is 0.4 m above the ground plane.
2. All the other conductive surface of the EUT shall be at least 0.8 m from the reference ground plane.
3. If the mains lead of the EUT is longer than necessary to be connected to the LISN the length of this lead in excess of 0.8 m shall be folded back and forth parallel to the lead so as to form a horizontal bundle with a length between 0.3 m and 0.4 m.
4. Maximum procedure was performed on the six highest emissions to ensure EUT compliance.

**Test Configuration:**

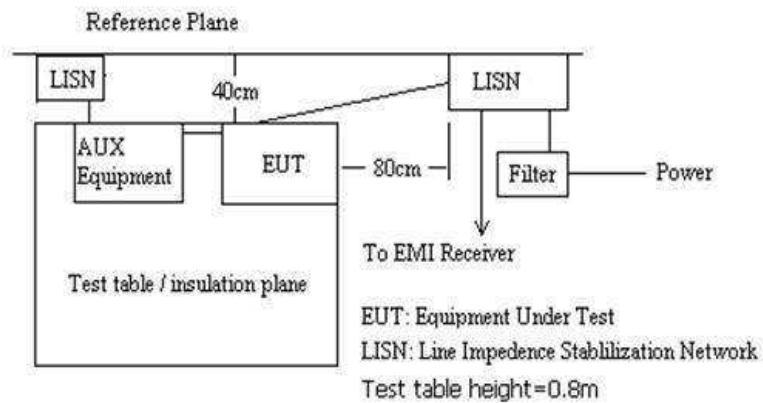

**Test Result:**

On the basis of field operation in the test site, while put the round connector of charger into the charging jack near the built-in antenna, the charger LED will illuminate red indicating that the charger is plugged in and charging. Meanwhile, the LCD display of EUT will be turned off and automatically stop ALL functions except for charging. Therefore, conducted emission test is not applicable to this device.

[Specification of charger equipped by the manufacturer - model no.: 95034, input voltage: 110V]

## 6.8 Band Edge and Restricted Band of Radiated Emission Measurement

### Applicable Standard:

According to §15.247(d), radiated emissions which fall in the restricted bands, as defined in §15.205(a), must also comply with the radiated emission limits specified in 15.209(a).

According to RSS-210 issue 8, §A8.5, radiated emissions which fall in the restricted bands of Table 1 must also comply with the radiated emission limits specified in Tables 2 and 3.

According to DA 00-705, in making radiated band-edge measurements, the following technique for determining band edge compliance.

Step 1: perform an in band field strength measurement of the fundamental emission using the RBW and detector function required by ANSI C63.4: 2003 and our Rules for the frequency being measured. For transmitters operating above 1 GHz, use a 1 MHz RBW, a 1 MHz VBW, and a peak detector (as required by Section 15.35). Repeat the measurement with an average detector (i.e., 1 MHz RBW with 10 Hz VBW).

Step 2: choose a spectrum analyzer span that encompasses both the peak of the fundamental emission and the band-edge emission under investigation. Set the analyzer RBW to 1% of the total span (but never less than 30 kHz) with a video bandwidth equal to or greater than the RBW. Record the peak levels of the fundamental emission and the relevant band-edge emission (i.e., run several sweeps in peak hold mode). Observe the stored trace and measure the amplitude delta between the peak of the fundamental and the peak of the band-edge emission. This is not a field strength measurement, it is only a relative measurement to determine the amount by which the emission drops at the band edge relative to the highest fundamental emission level.

Step 3: subtract the delta measured in step (2) from the field strengths measured in step (1). The resultant field strengths (CISPR QP, average, or peak, as appropriate) are then used to determine band edge compliance as required by Section 15.205.

Step 4: the above "delta" measurement technique may be used for measuring emissions that are up to two "standard" bandwidths away from the band edge, where a "standard" bandwidth is the bandwidth specified by ANSI C63.4: 2003 for the frequency being measured.



**Test Procedure:**

1. The EUT was placed on a turn table which is 0.8m above ground plane.
2. The turn table shall rotate 360 degrees to determine the position of maximum emission level.
3. EUT is set 3m away from the receiving antenna which varied from 1m to 4m to find out the highest emissions.
4. Maximum procedure was performed on the highest emissions in restricted band to ensure EUT compliance.

The field strength is calculated by adding the Antenna Factor and Cable Factor and subtracting the Amplifier Gain and Duty Cycle Correction Factor(if any) from the measured reading. The basic equation with a sample calculation is as follows:

$$FS = RA + AF + CL - AG$$

|                           |  |
|---------------------------|--|
| Where FS = Field Strength | CL = Cable Attenuation Factor (Cable Loss) |
| RA = Reading Amplitude    | AG = Amplifier Gain                        |
| AF = Antenna Factor       |  |

**Test Results:**

|                |                                 |
|----------------|---------------------------------|
| Temperature:   | 21°C                            |
| Humidity:      | 53%                             |
| EUT Operation: | FHSS modulation without hopping |
| Test Date:     | January 05, 2014                |

Pre-scan the EUT in all operation modes respectively and find out the worst case is FHSS-DSSS hybrid modulation without hopping in transmitting. The unit does meet the requirements.

*Note: Test plots shown in figures 24 to 31 on pages 42 to 45.*

Figure 24 Band Edge of Radiated Emission – Low frequency side without hopping  
Peak measurement in horizontal polarization

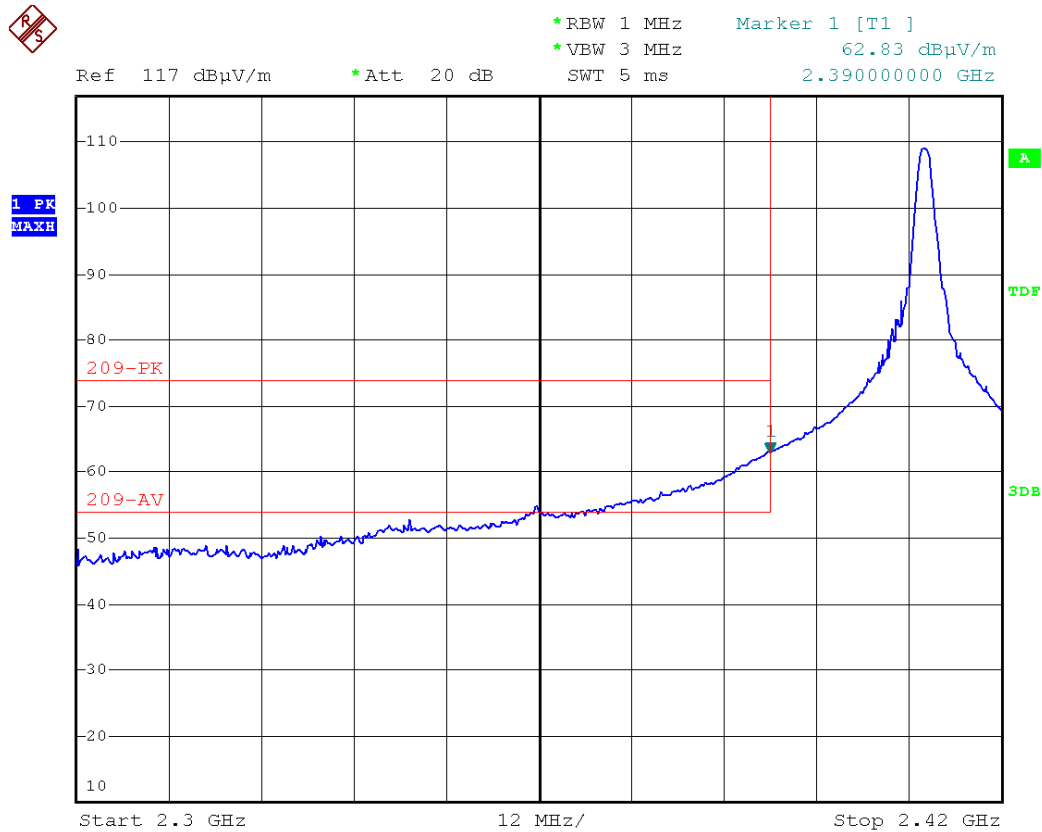

Figure 25 Band Edge of Radiated Emission – Low frequency side without hopping  
Average measurement in horizontal polarization

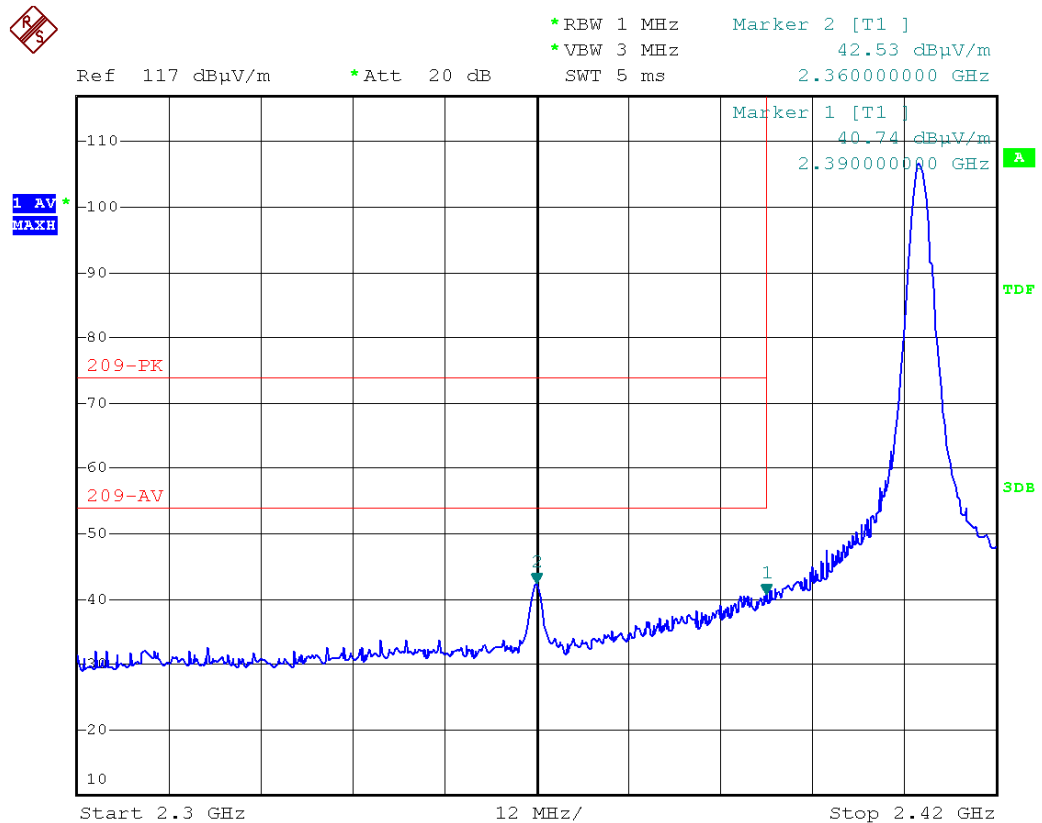

Figure 26 Band Edge of Radiated Emission – Low frequency side without hopping  
Peak measurement in vertical polarization

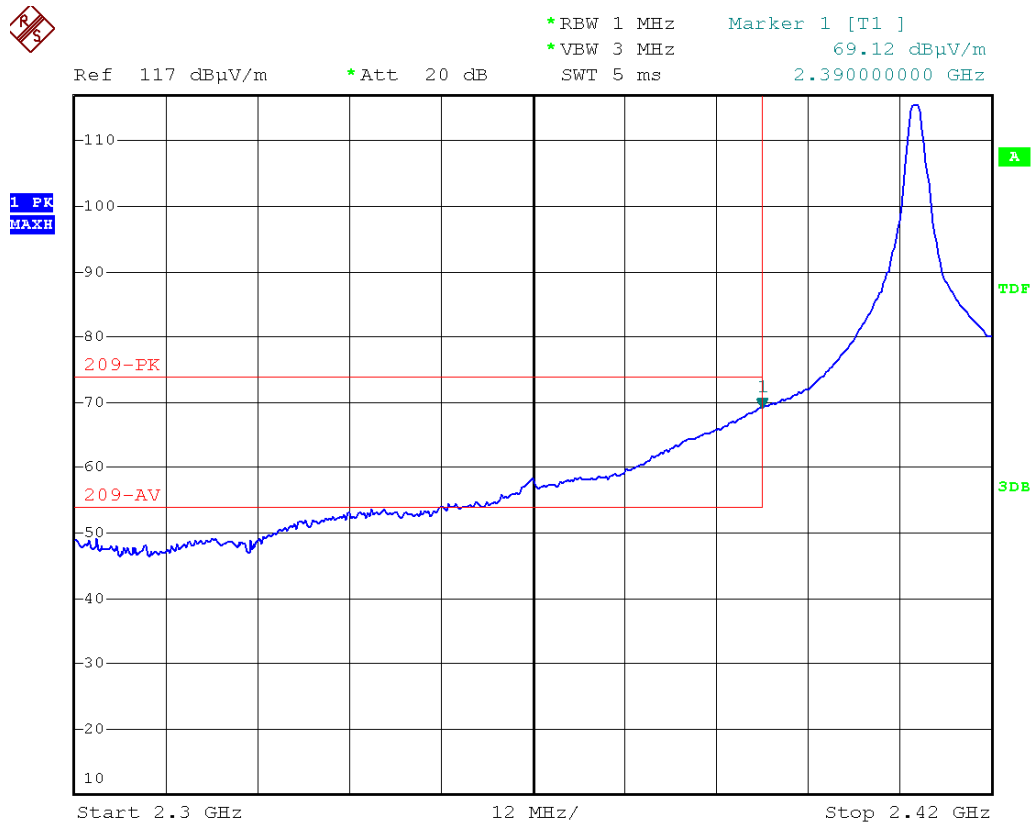

Figure 27 Band Edge of Radiated Emission – Low frequency side without hopping  
Average measurement in vertical polarization

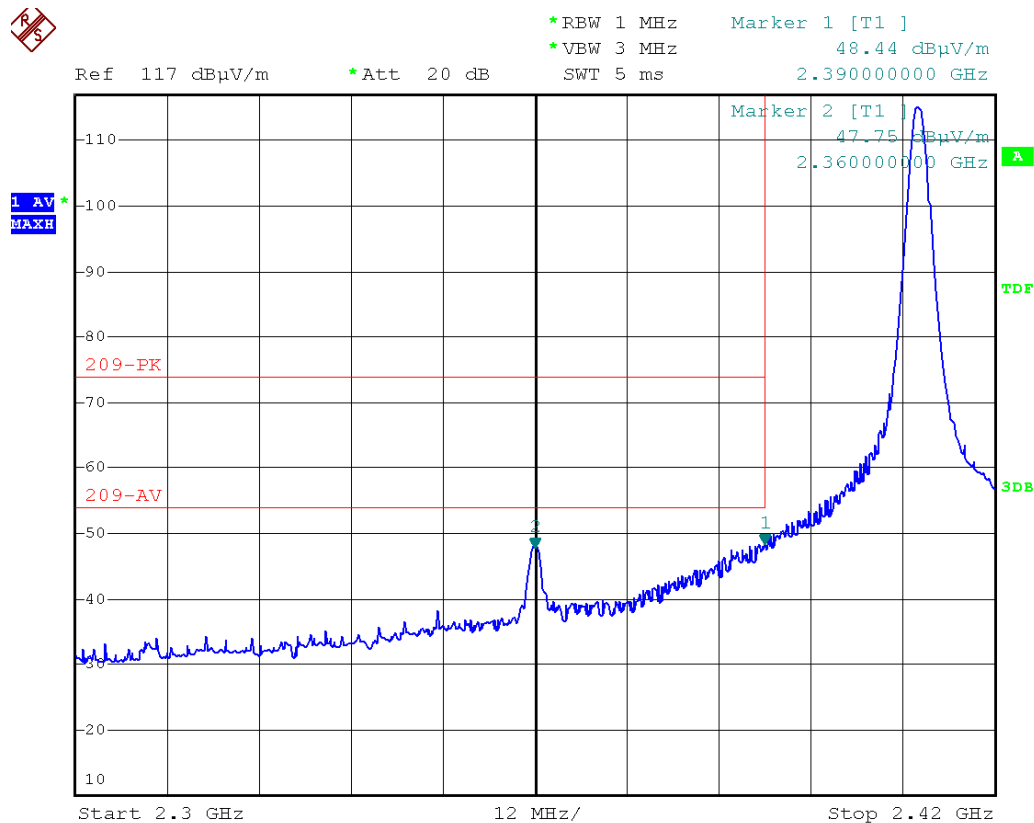

Figure 28 Band Edge of Radiated Emission – High frequency side without hopping  
Peak measurement in horizontal polarization

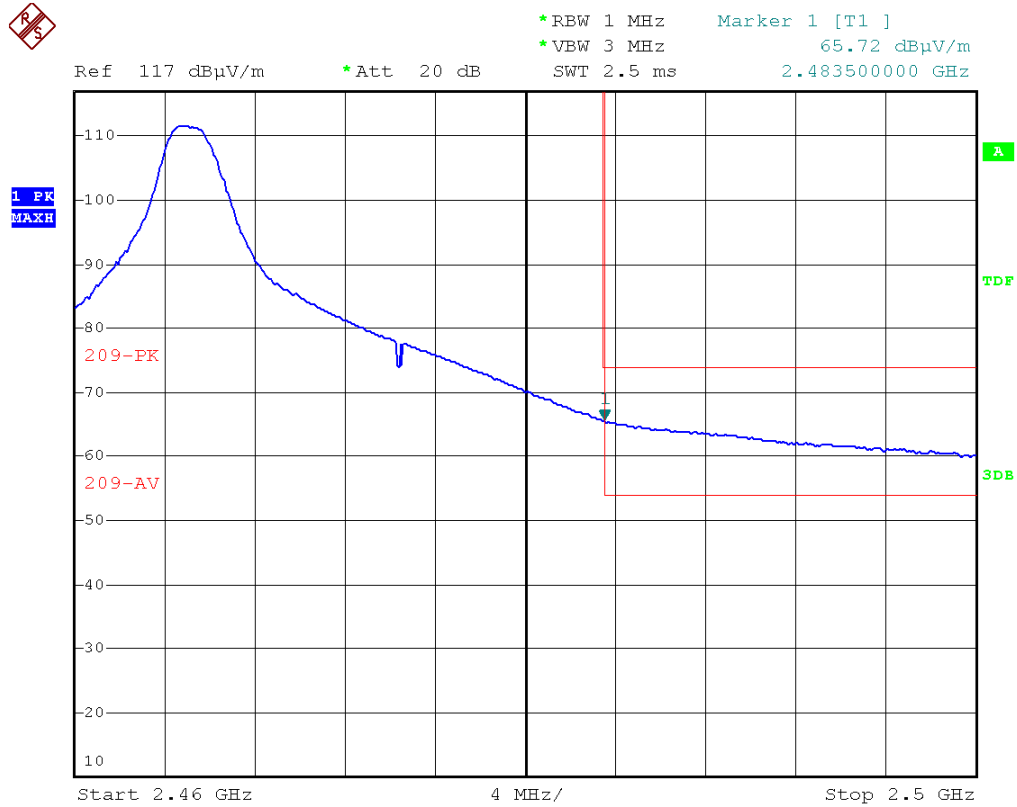

Figure 29 Band Edge of Radiated Emission – High frequency side without hopping  
Average measurement in horizontal polarization

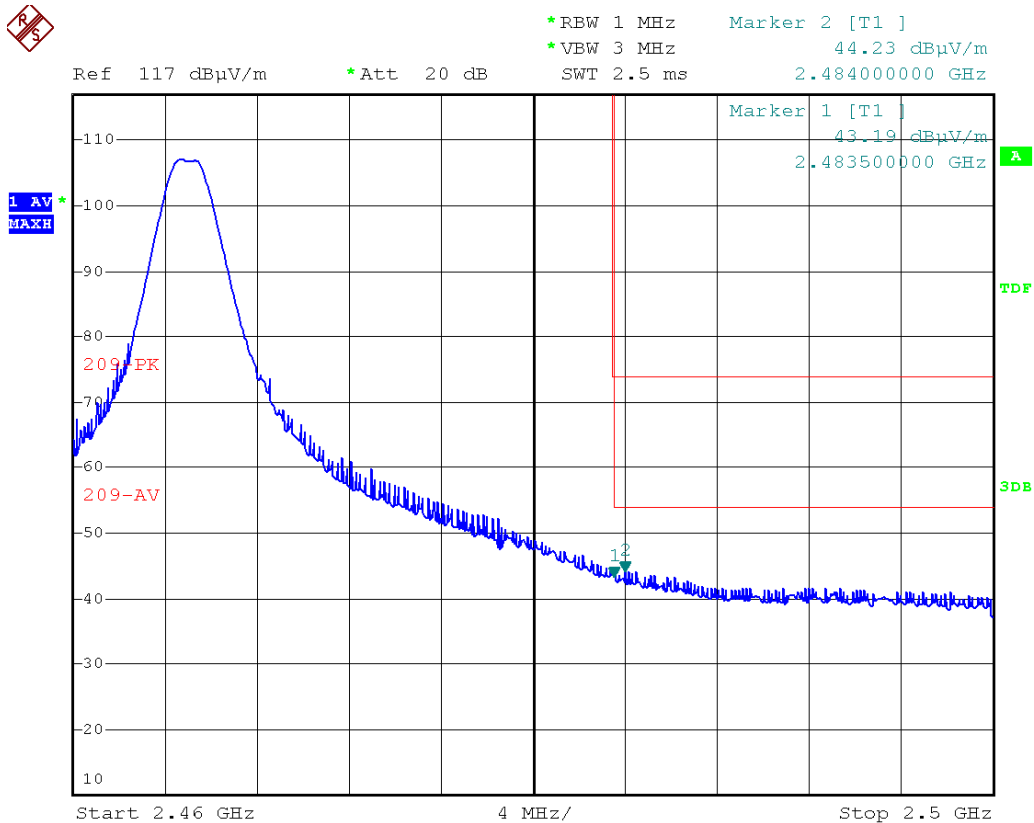

Figure 30 Band Edge of Radiated Emission – High frequency side without hopping  
Peak measurement in vertical polarization

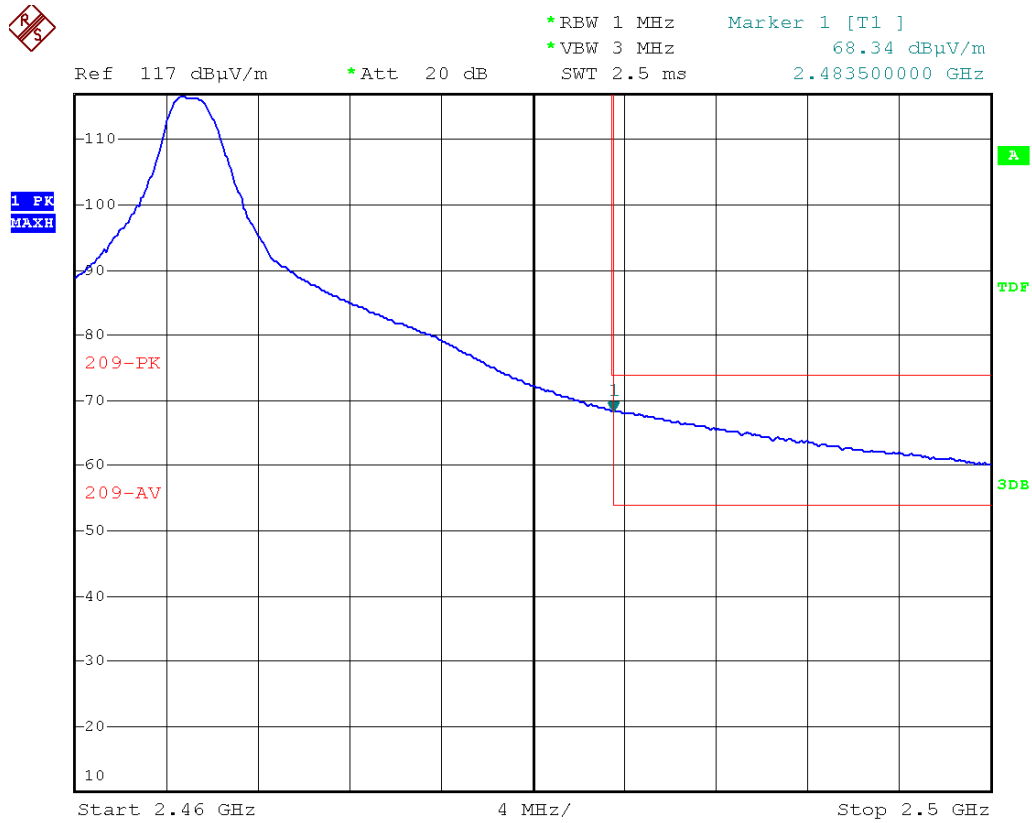
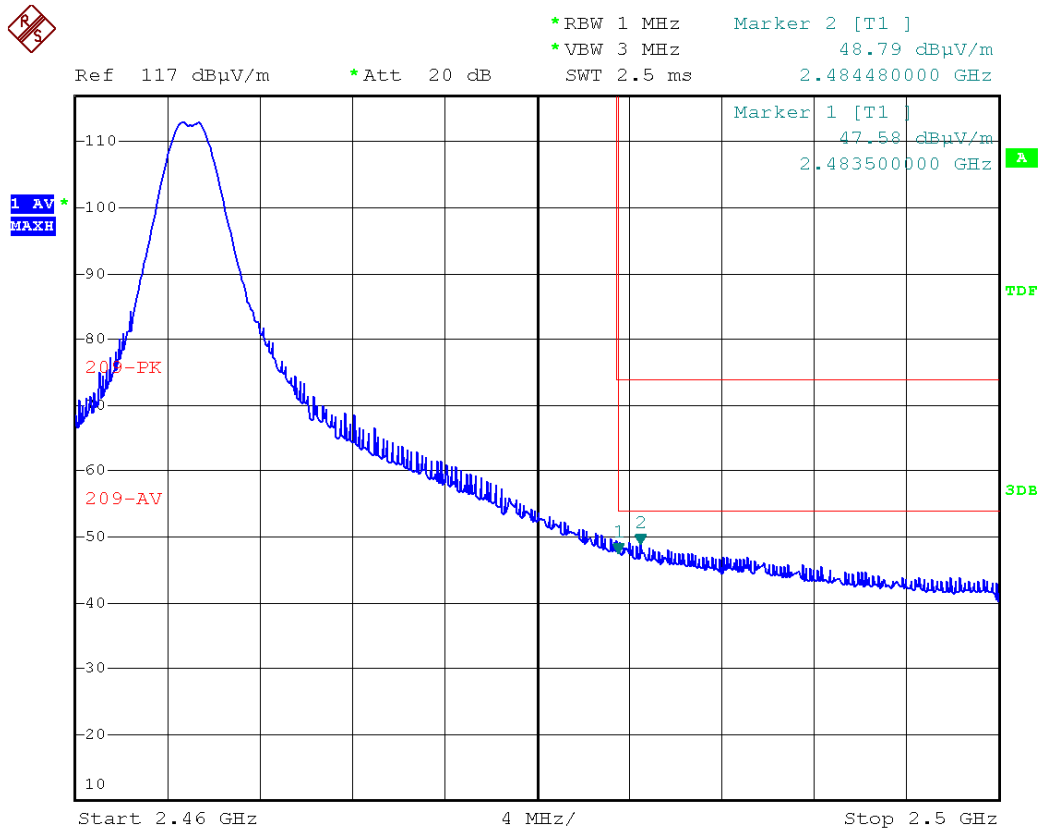

Figure 31 Band Edge of Radiated Emission – High frequency side without hopping  
Average measurement in vertical polarization



**6.9 99% Bandwidth Measurement****Applicable Standard:**

RSS-Gen §4.4.1, the transmitter shall be operated at its maximum carrier power measured under normal test conditions. The span of the analyzer shall be set to capture all products of the modulation process, including the emission skirts. The resolution bandwidth shall be set to as close to 1% of the selected span as is possible without being below 1%. The video bandwidth shall be set to 3 times the resolution bandwidth. Video averaging is not permitted. Where practical, a sampling detector shall be used since a peak or, peak hold, may produce a wider bandwidth than actual.

The trace data points are recovered and are directly summed in linear terms. The recovered amplitude data points, beginning at the lowest frequency, are placed in a running sum until 0.5% of the total is reached and that frequency recorded. The process is repeated for the highest frequency data points. This frequency is recorded. The span between the two recorded frequencies is the occupied bandwidth.

Spectrum analyzer set up conditions:

Span = 3MHz

Resolution Bandwidth = 100KHz

Video Bandwidth = 300KHz

Sweep = auto

Detector function = peak

Trace = max hold

**Test Results:**

|                |  |
|----------------|--|
| Temperature:   | 21°C   |
| Humidity:      | 51%  |
| EUT Operation: | FHSS without hopping and FHSS-DSSS hybrid mode |
| Test Date:     | January 07, 2014                               |

| Type of modulation: FHSS |                     |
|--------------------------|---------------------|
| Frequency (MHz )         | 99% Bandwidth (MHz) |
| 2410                     | 1.200               |
| 2438                     | 1.218               |
| 2465                     | 1.224               |

*Note: Test plots shown in figures 32 to 34 on pages 48 to 49.*

| Type of modulation: FHSS-DSSS hybrid |                     |
|--------------------------------------|---------------------|
| Frequency (MHz )                     | 99% Bandwidth (MHz) |
| 2410                                 | 1.254               |
| 2438                                 | 1.200               |
| 2465                                 | 1.248               |

*Note: Test plots shown in figures 35 to 37 on pages 49 to 50.*

Figure 32- 99% Bandwidth Measurement (fc=2410MHz)

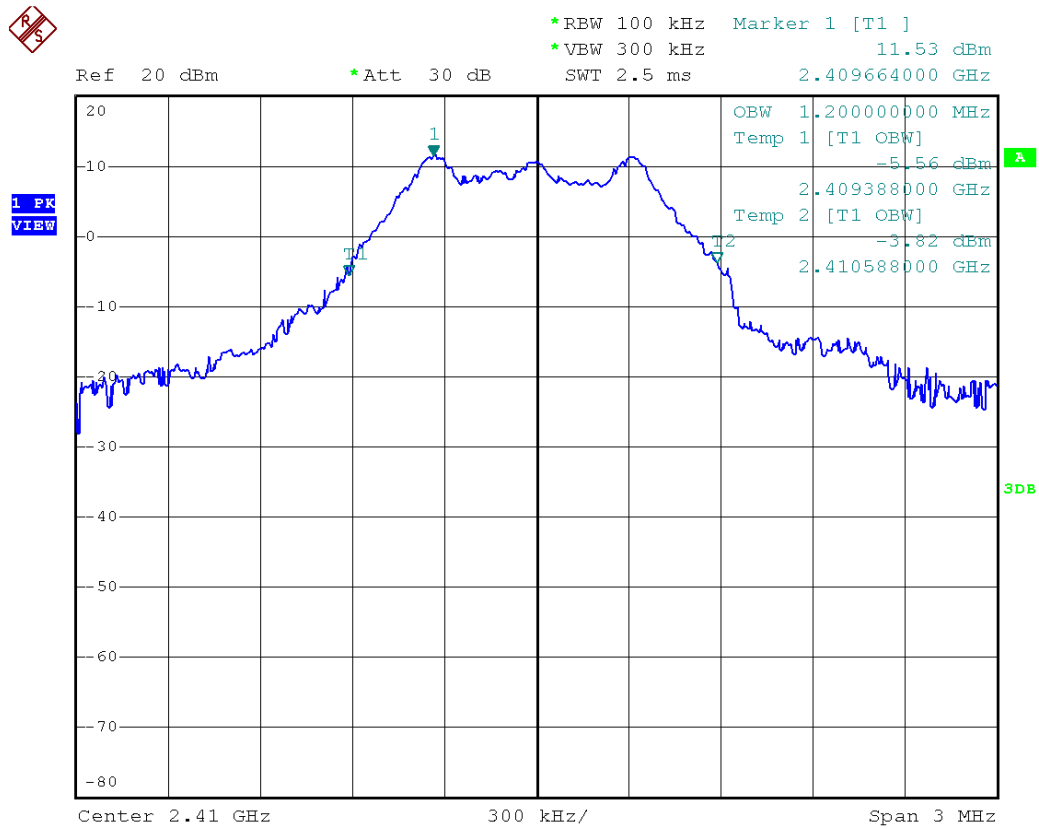

Figure 33- 99% Bandwidth Measurement (fc=2438MHz)

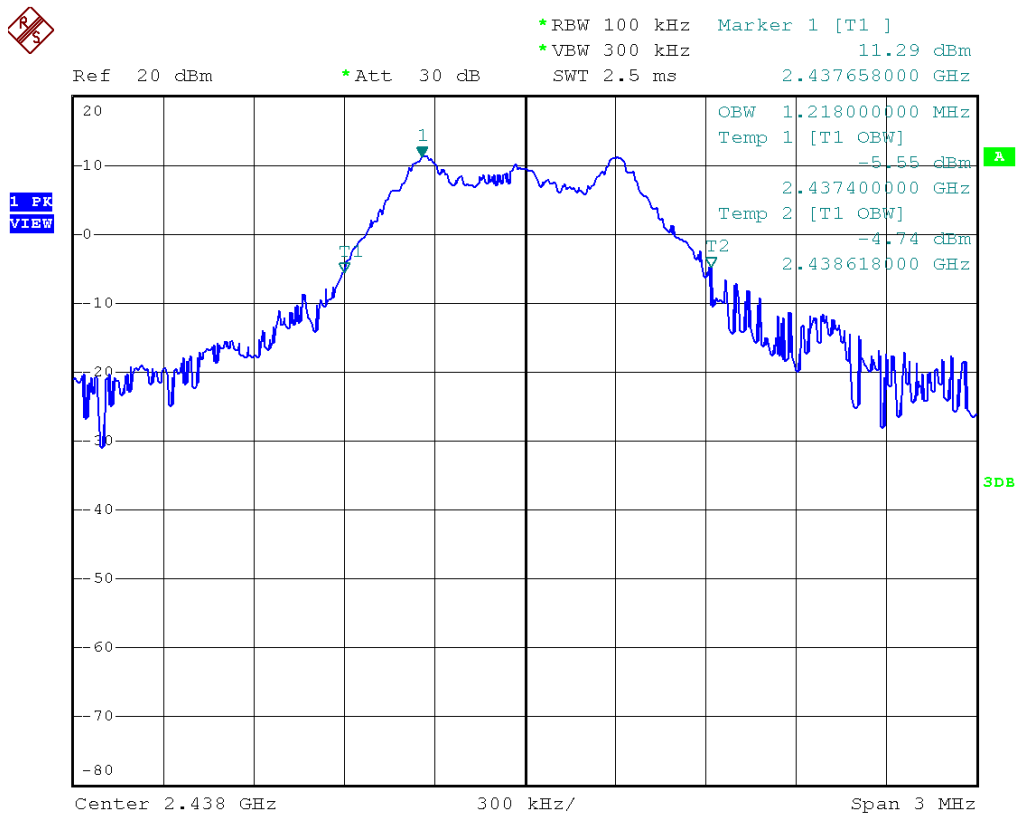



Figure 34- 99% Bandwidth Measurement (fc=2465MHz)

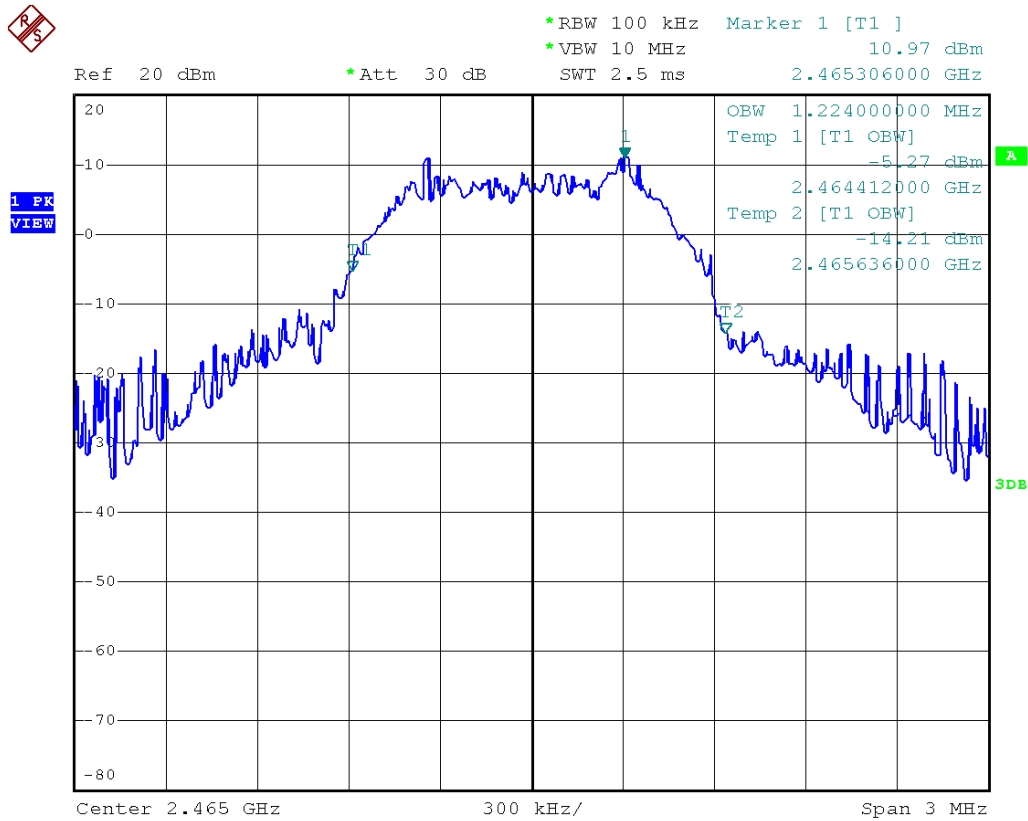

Figure 35- 99% Bandwidth Measurement (fc=2410MHz)

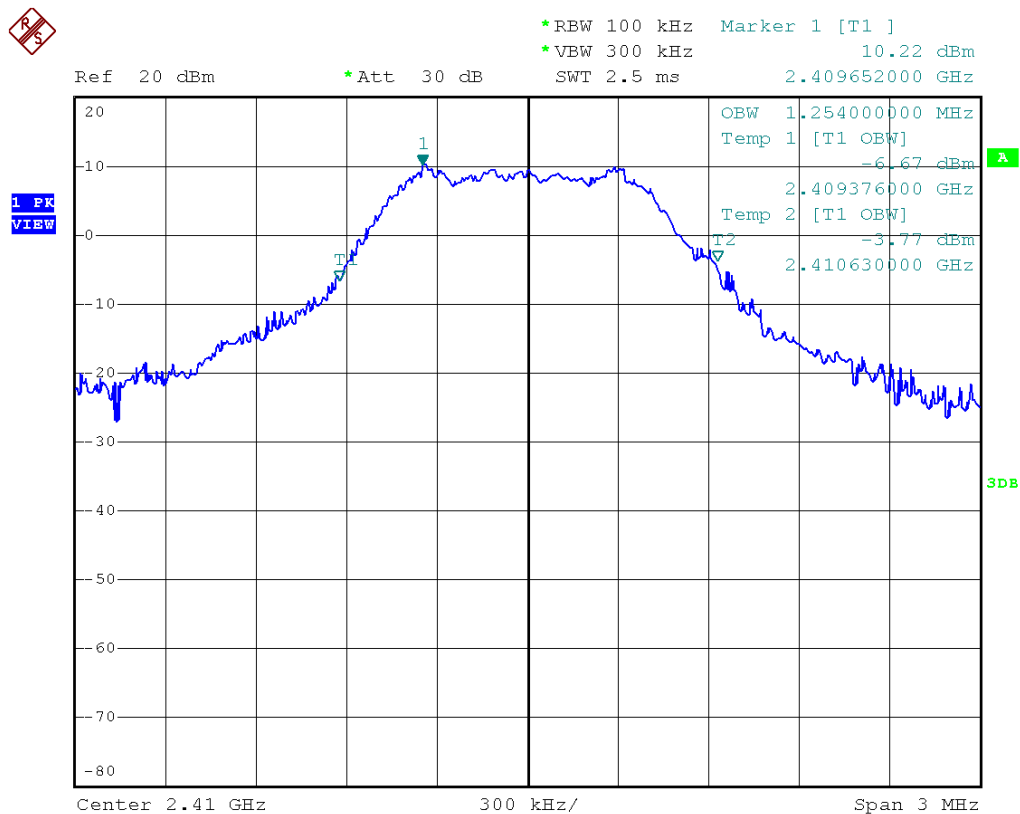

Figure 36- 99% Bandwidth Measurement (fc=2438MHz)

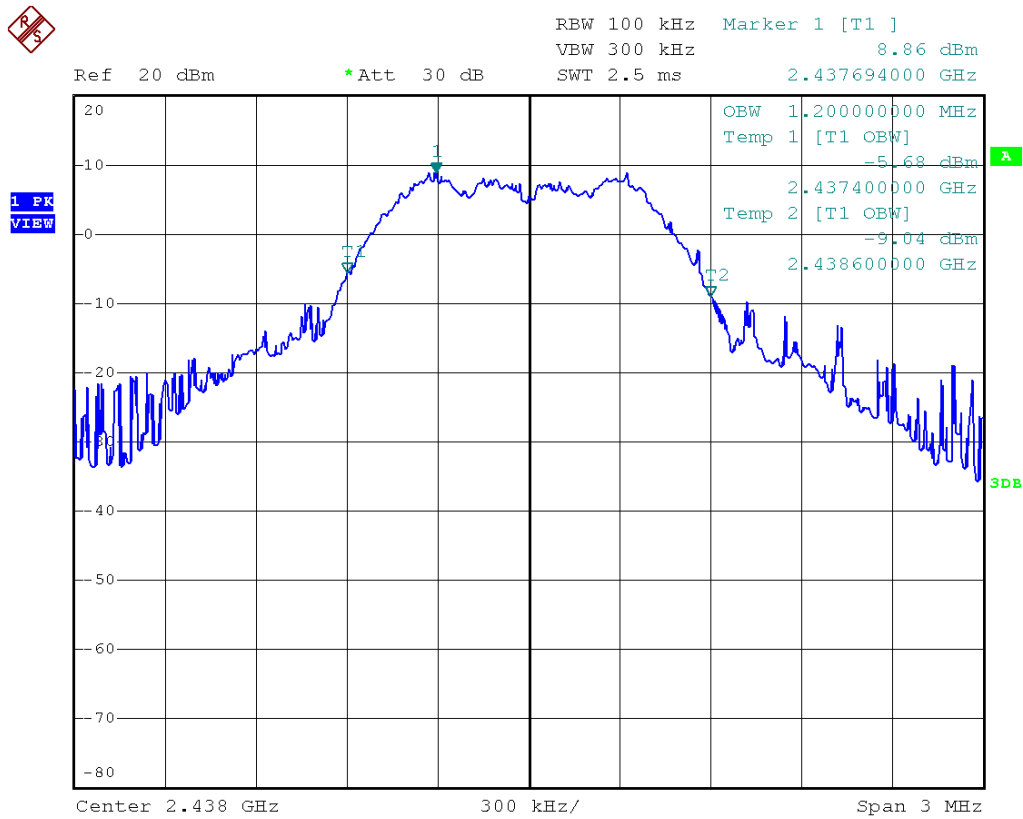
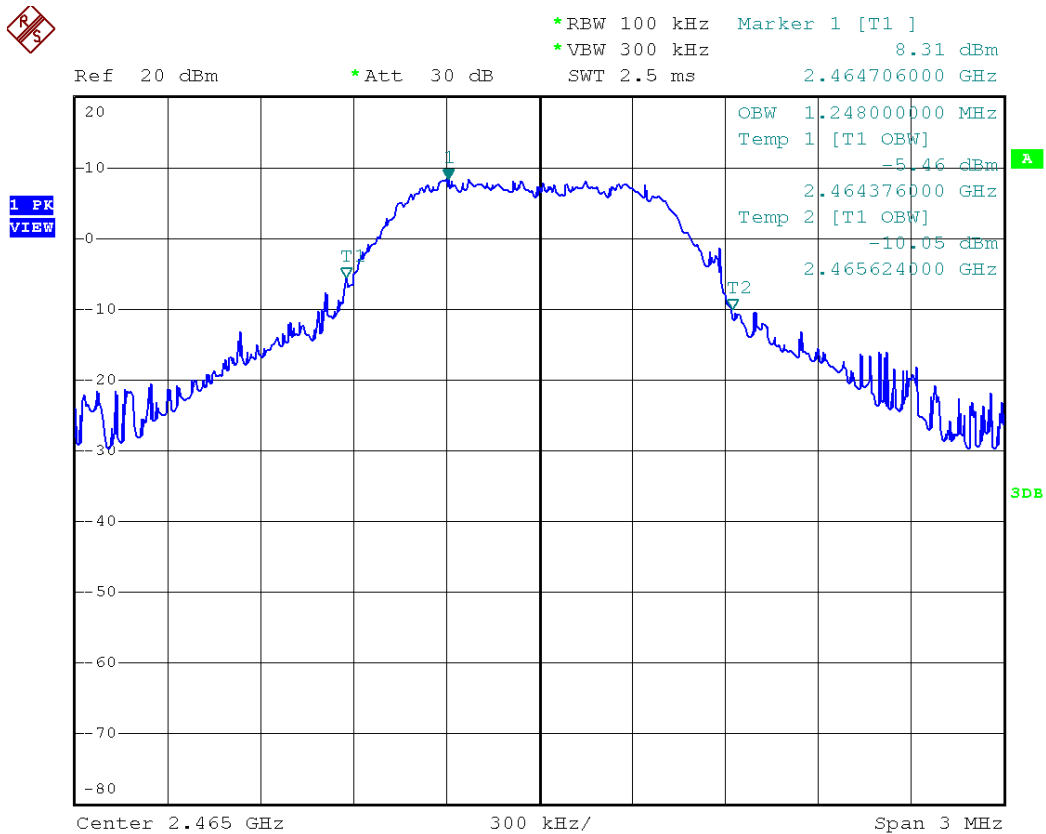

Figure 37- 99% Bandwidth Measurement (fc=2465MHz)



**6.10 20dB Bandwidth Measurement****Applicable Standard:**

According to §15.247(a)(1) Frequency hopping systems shall have hopping channel carrier frequencies separated by a minimum of 25kHz or the 20 dB bandwidth of the hopping channel, whichever is greater. Alternatively frequency hopping systems operating in the 2400–2483.5 MHz band may have hopping channel carrier frequencies that are separated by 25 kHz or two-thirds of the 20 dB bandwidth of the hopping channel, whichever is greater, provided the systems operate with an output power no greater than 125 mW. The system shall hop to channel frequencies that are selected at the system hopping rate from a pseudo randomly ordered list of hopping frequencies. Each frequency must be used equally on the average by each transmitter. The system receivers shall have input bandwidths that match the hopping channel bandwidths of their corresponding transmitters and shall shift frequencies in synchronization with the transmitted signals.

The trace data points are recovered and are directly summed in linear terms. The recovered amplitude data points, beginning at the lowest frequency, are placed in a running sum until 0.5% of the total is reached and that frequency recorded. The process is repeated for the highest frequency data points. This frequency is recorded. The span between the two recorded frequencies is the occupied bandwidth.

Spectrum analyzer set up conditions:

Span = 3MHz

Resolution Bandwidth = 100KHz

Video Bandwidth = 300KHz

Sweep = auto

Detector function = peak

Trace = max hold

**Test Results:**

|                |                                     |
|----------------|-------------------------------------|
| Temperature:   | 22°C                                |
| Humidity:      | 51%                                 |
| EUT Operation: | Data Transmission (without hopping) |
| Test Date:     | December 31, 2013                   |

| Type of modulation: FHSS |                      |
|--------------------------|----------------------|
| Frequency (MHz )         | 20dB Bandwidth (MHz) |
| 2410                     | 1.330                |
| 2438                     | 1.266                |
| 2465                     | 1.296                |

*Note: Test plots shown in figures 38 to 40 on pages 53 to 54.*

| Type of modulation: FHSS-DSSS hybrid |                      |
|--------------------------------------|----------------------|
| Frequency (MHz )                     | 20dB Bandwidth (MHz) |
| 2410                                 | 1.326                |
| 2438                                 | 1.326                |
| 2465                                 | 1.320                |

*Note: Test plots shown in figures 41 to 43 on pages 54 to 55.*

Figure 38 – 20dB Bandwidth Measurement (fc=2410MHz)

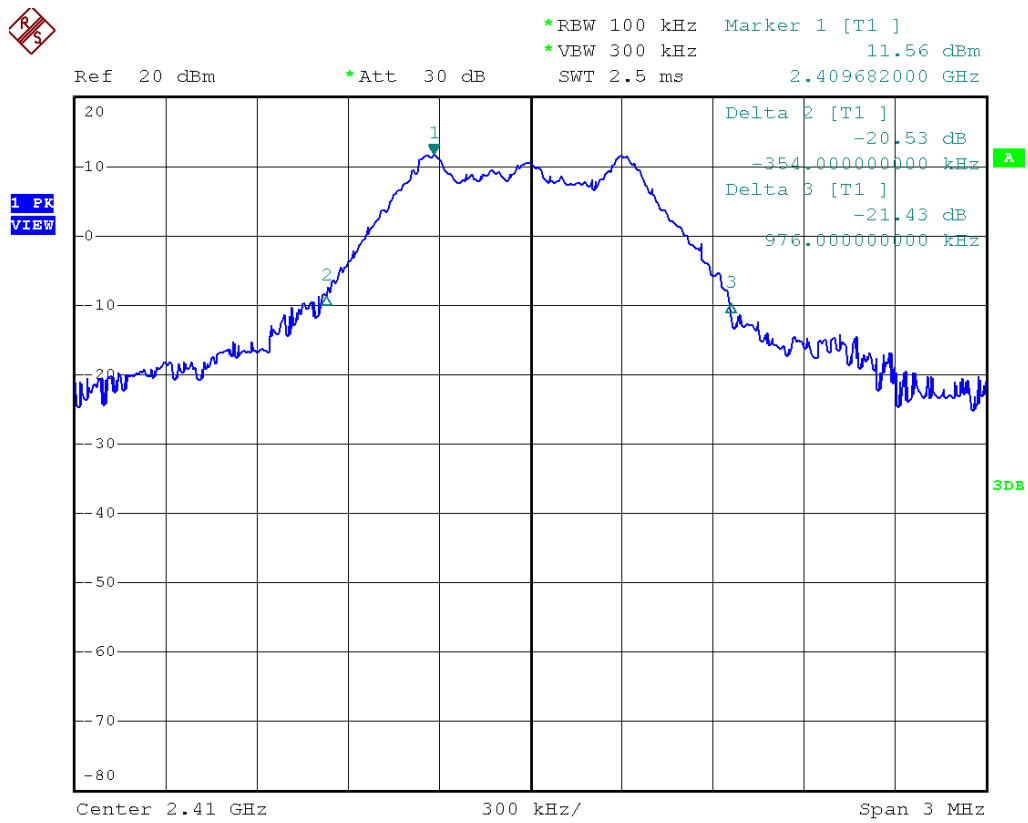

Figure 39 - 20dB Bandwidth Measurement (fc=2438MHz)

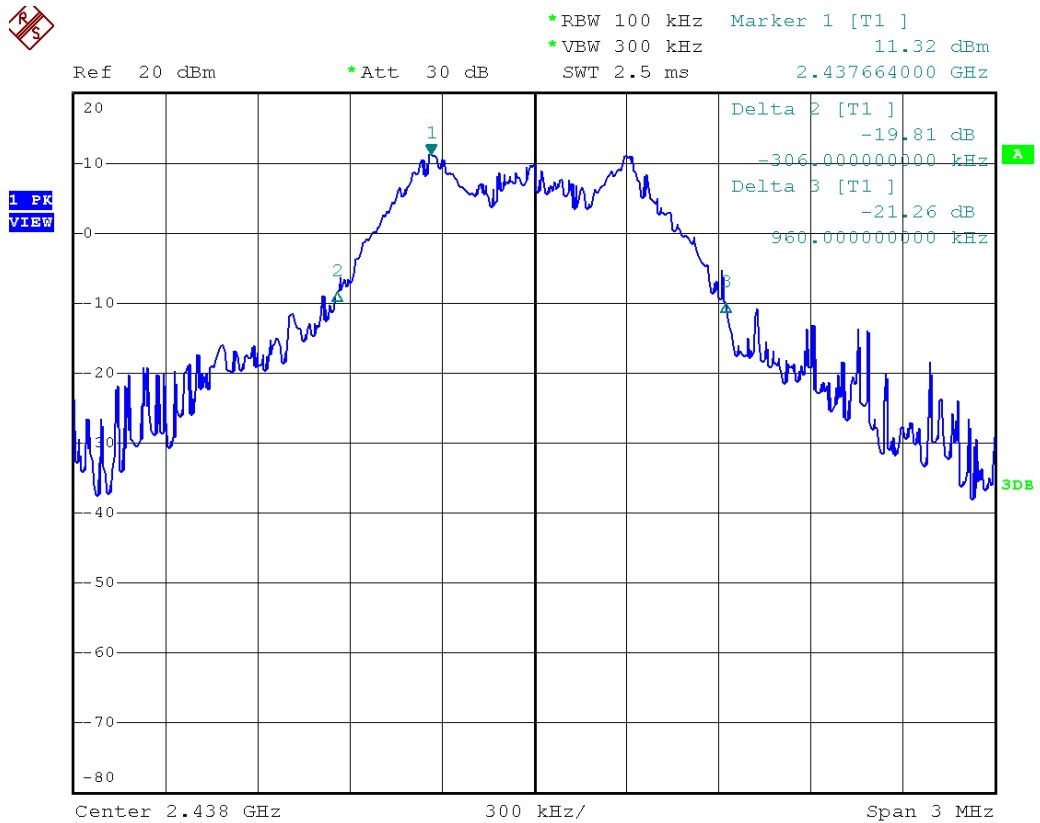

Figure 40- 20dB Bandwidth Measurement (fc=2465MHz)

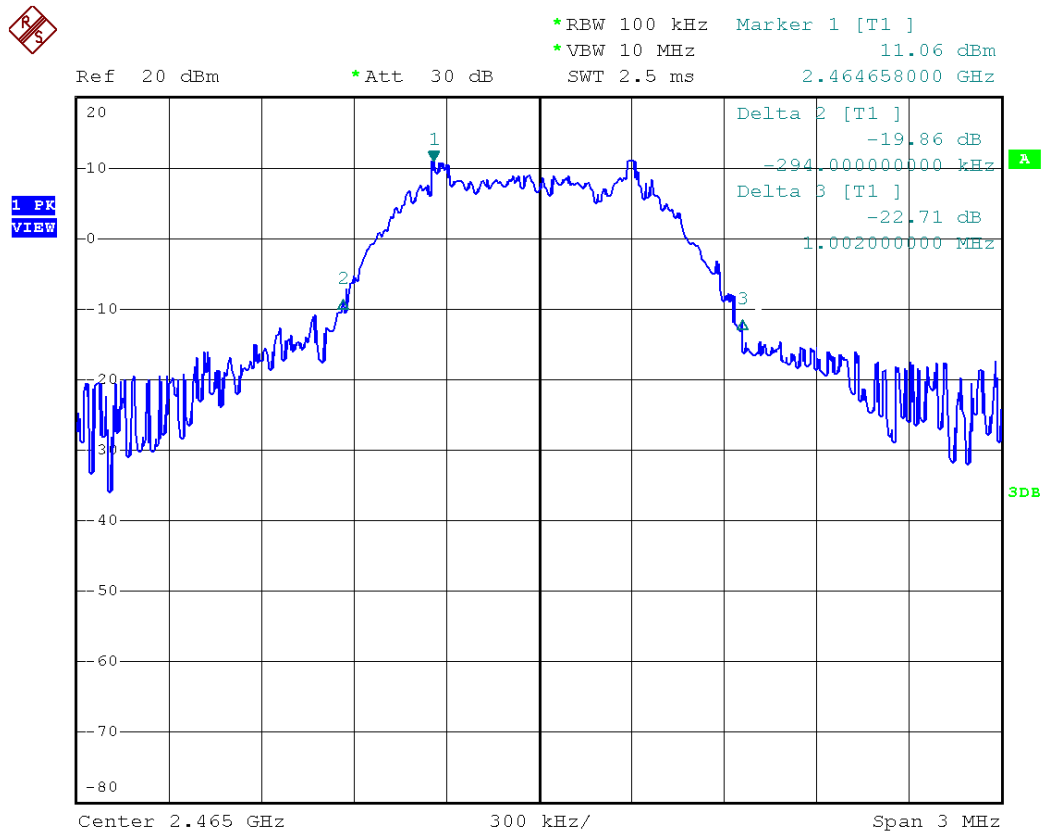

Figure 41 - 20dB Bandwidth Measurement (fc=2410MHz)

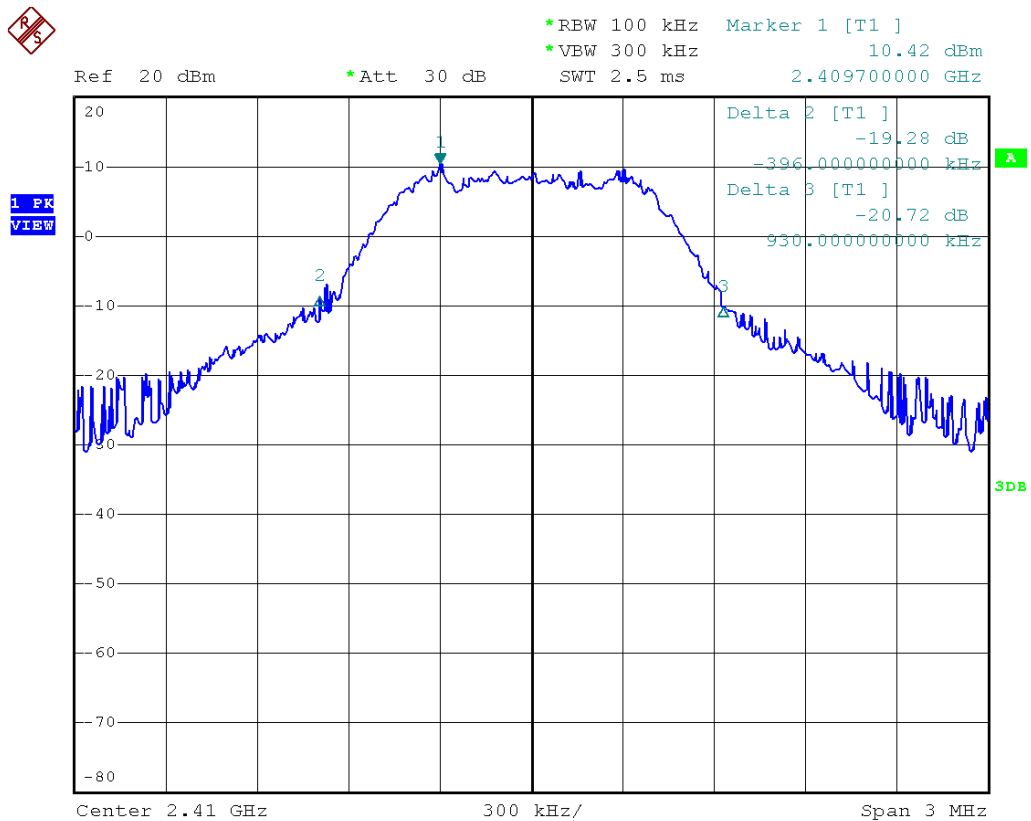

Figure 42 - 20dB Bandwidth Measurement (fc=2438MHz)

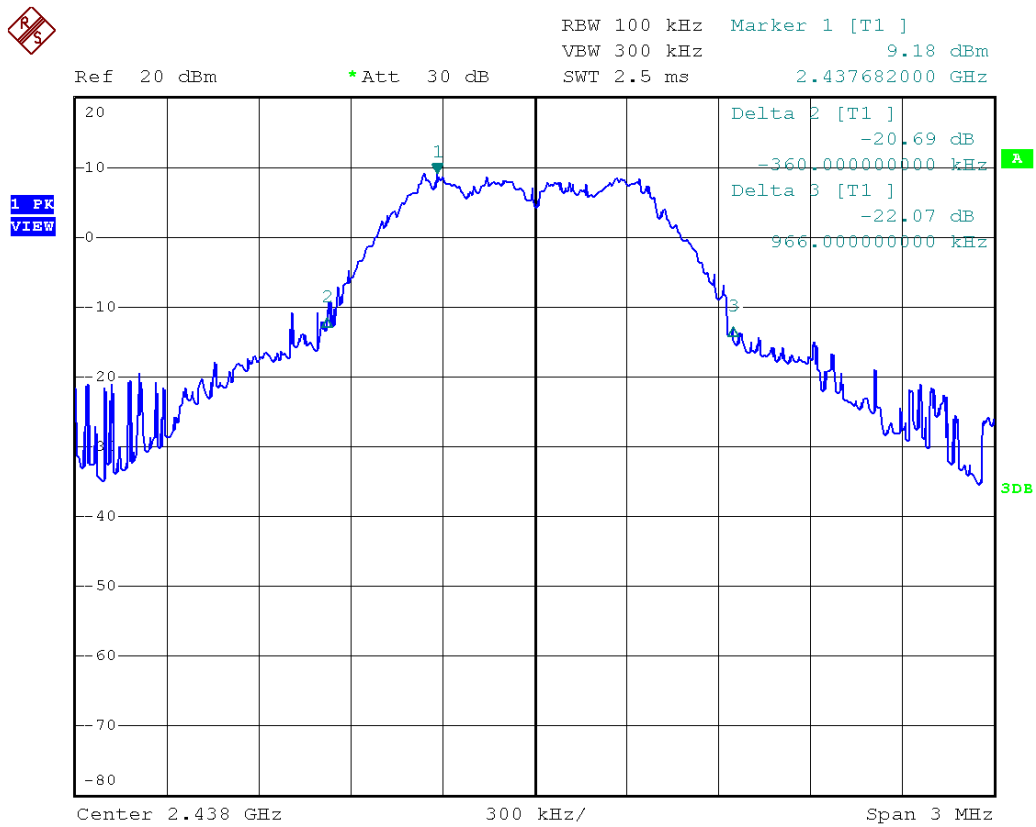
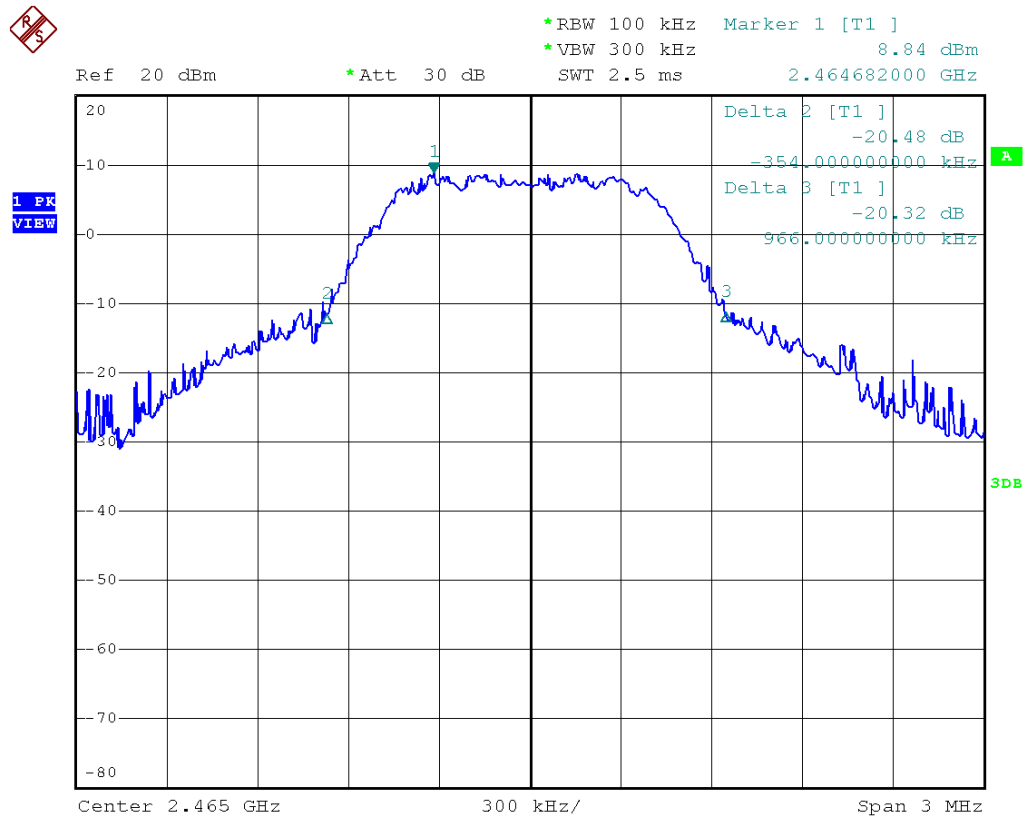

Figure 43 - 20dB Bandwidth Measurement (fc=2465MHz)



**6.11 Power Spectral Density Measurement**

**Standard Applicable:**

According to §15.247 (e) For digitally modulated systems, the power spectral density conducted from the intentional radiator to the antenna shall not be greater than 8 dBm in any 3 kHz band during any time interval of continuous transmission.

RSS-210 According to RSS-210 issue 8, §A8.2, (b) The transmitter power spectral density conducted from the transmitter to the antenna shall not be greater than 8 dBm in any 3 kHz band during any time interval of continuous transmission or over 1.0 second if the transmission exceeds 1.0-second duration. .

Use the following spectrum analyzer settings:

- Span = 300kHz
- Resolution Bandwidth = 3KHz
- Video Bandwidth = 10KHz
- Sweep Times= 100s
- Detector function = peak
- Trace = max hold

**Test Results:**

|                |   |
|----------------|---|
| Temperature:   | 21°C  |
| Humidity:      | 53%   |
| EUT Operation: | FHSS-DSSS hybrid modulation in transmitting |
| Test Date:     | January 04, 2014                            |

| Frequency | Cable Loss | Reading | Power   | Limit   | Margin |
|-----------|------------|---------|---------|---------|--------|
| [ MHz ]   | [ dB ]     | [ dBm ] | [ dBm ] | [ dBm ] | [ dB ] |
| 2410      | 1.0        | -1.41   | -0.41   | 8.00    | -8.41  |
| 2438      | 1.0        | -1.65   | -0.65   | 8.00    | -8.65  |
| 2465      | 1.0        | -2.84   | -1.84   | 8.00    | -9.84  |

*Note: Test plots shown in figures 44 to 46 on pages 57 to 58.*

The unit does meet the requirements.





Figure 46 Power Spectral Density Measurement (fc=2465MHz)

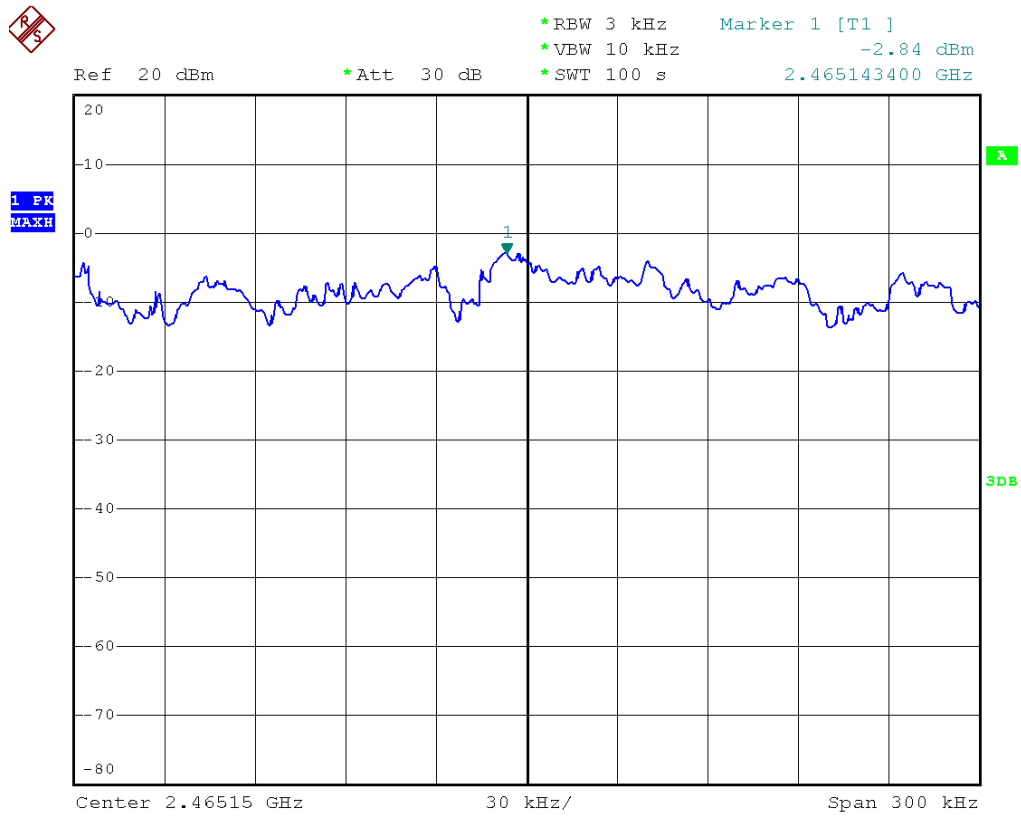

**6.12 RF Exposure**

**Applicable Standard:**

According to FCC part 15.247(i) and 1.1307 (b)(1), systems operating under the provisions of this section shall be operated in a manner that ensures that the public is not exposed to radio frequency energy levels in excess of the Commission's guidelines.

And for KDB 447498 SAR D01 General RF Exposure Guidance v05 Appendix B

**SAR Test Exclusion Thresholds for 100 MHz – 6 GHz and > 50 mm**

Approximate SAR test exclusion power thresholds at selected frequencies and test separation distances are illustrated in the following table.

| MHz  | 50  | 60  | 70  | 80  | 90  | 100 | 110 | 120 | 130 | 140  | 150  | 160  | 170  | 180  | 190  | mm |
|------|-----|-----|-----|-----|-----|-----|-----|-----|-----|------|------|------|------|------|------|----|
| 100  | 474 | 481 | 487 | 494 | 501 | 507 | 514 | 521 | 527 | 534  | 541  | 547  | 554  | 561  | 567  | mW |
| 150  | 387 | 397 | 407 | 417 | 427 | 437 | 447 | 457 | 467 | 477  | 487  | 497  | 507  | 517  | 527  |    |
| 300  | 274 | 294 | 314 | 334 | 354 | 374 | 394 | 414 | 434 | 454  | 474  | 494  | 514  | 534  | 554  |    |
| 450  | 224 | 254 | 284 | 314 | 344 | 374 | 404 | 434 | 464 | 494  | 524  | 554  | 584  | 614  | 644  |    |
| 835  | 164 | 220 | 275 | 331 | 387 | 442 | 498 | 554 | 609 | 665  | 721  | 776  | 832  | 888  | 943  |    |
| 900  | 158 | 218 | 278 | 338 | 398 | 458 | 518 | 578 | 638 | 698  | 758  | 818  | 878  | 938  | 998  |    |
| 1500 | 122 | 222 | 322 | 422 | 522 | 622 | 722 | 822 | 922 | 1022 | 1122 | 1222 | 1322 | 1422 | 1522 |    |
| 1900 | 109 | 209 | 309 | 409 | 509 | 609 | 709 | 809 | 909 | 1009 | 1109 | 1209 | 1309 | 1409 | 1509 |    |
| 2450 | 96  | 196 | 296 | 396 | 496 | 596 | 696 | 796 | 896 | 996  | 1096 | 1196 | 1296 | 1396 | 1496 |    |
| 3600 | 79  | 179 | 279 | 379 | 479 | 579 | 679 | 779 | 879 | 979  | 1079 | 1179 | 1279 | 1379 | 1479 |    |
| 5200 | 66  | 166 | 266 | 366 | 466 | 566 | 666 | 766 | 866 | 966  | 1066 | 1166 | 1266 | 1366 | 1466 |    |
| 5400 | 65  | 165 | 265 | 365 | 465 | 565 | 665 | 765 | 865 | 965  | 1065 | 1165 | 1265 | 1365 | 1465 |    |
| 5800 | 62  | 162 | 262 | 362 | 462 | 562 | 662 | 762 | 862 | 962  | 1062 | 1162 | 1262 | 1362 | 1462 |    |

According to RSS-102 Section 2.5.1, SAR evaluation is required if the separation distance between the user and the radiating element of the device is less than or equal to 20cm, except when the device operates above 2.2 GHz and up to 3 GHz inclusively, and with output power [ i.e. the higher of the conducted or radiated (e.i.r.p.) source-based, time-averaged output power ] that is less than or equal to 20 mW for general public use and 100 mW for controlled use.

**Test Results:**

This is a portable device for general public use, which will be hand-held by users during normal operation with an antenna separation distance to the body of not less than 120 mm in worst case (between the antenna base and handle of EUT).

For FCC evaluation, the peak conduct output power is 12.61dBm and the best gain of antenna is 1.5dBi, the max out power is 14.11dBm (25.76mW) and it is less than the corresponding SAR test exclusion power thresholds (796mW).

For IC evaluation, the EIRP of EUT is 11.19dBm (13.15mW) and it is less than SAR test exclusion power thresholds (20mW) for general public use (refer to the IC SAR Exemption document)

The unit does meet the requirements of SAR exemption.



Location of Antenna

## **6.13 Antenna Requirement**

### **Standard Applicable**

According to §15.203, an intentional radiator shall be designed to ensure that no antenna other than furnished by the responsible party shall be used with the device. And according to §15.246(1), if transmitting antennas of directional gain greater than 6dBi are used the power shall be reduced by the amount in dB that the directional gain of the antenna exceeds 6 dBi.

According to RSS-GEN 7.1.4, a transmitter can only be sold or operated with antennas with which it was certified. A transmitter may be certified with multiple antenna types. An antenna type comprises antennas having similar in-band and out-of-band radiation patterns. Testing shall be performed using the highest-gain antenna of each combination of transmitter and antenna type for which certification is being sought, with the transmitter output power set at the maximum level. Any antenna of the same type and having equal or lesser gain as an antenna that had been successfully tested for certification with the transmitter, will also be considered certified with the transmitter, and may be used and marketed with the transmitter. The manufacturer shall include with the application for certification a list of acceptable antenna types to be used with the transmitter.

### **Antenna Construction:**

The directional gain of antenna used for transmitting is 1.3~1.5 dBi, and the antenna connector is designed with permanent attachment and no consideration of replacement. Please see EUT photo for details.

The unit does meet the requirement.