

FCC Part 15 Subpart C Requirement
and Industry Canada RSS-210
Measurement and Test Report

For

Sanwa Electronic Instrument Co., Ltd

1-2-50, Yoshida Honmachi, Higashi-Osaka, Osaka 578-0982, Japan

FCC ID: L73-90482
IC: 7377A-90482

July 28, 2012

This Report Concerns: <input checked="" type="checkbox"/> Original Report	Equipment Type: 2.4GHz Radio Control System
Test Engineer:	Bossco He
Report Number:	SE12H-191FI
Test Date:	June 28 to July 20, 2012
Reviewed By:	 Karbon Y.Chung (Senior Manager) 
Prepared By:	S&E Technologies Laboratory Ltd Room 407, Block A Shennan Garden, Hi-Tech Industrial Park, Shenzhen 518057, P.R. China. Tel: 86-755-26636573, 26630631 Fax: 86-755-26630557

Note: This test report is limited to the above client company and the product model only. It may not be duplicated without prior written consent of S&E Technologies Laboratory Ltd.

Table of Contents

1-TEST RESULT CERTIFICATION.....	3
2- EUT DESCRIPTION	4
3-TEST SYSTEM	5
3.1 TEST MODE	5
3.2 TEST SETUP DIAGRAM	5
3.3 BLOCK DIAGRAM OF EUT SYSTEM.....	6
3.4 LIST OF CABLES	6
4- TEST EQUIPMENT AND CALIBRATION	7
5- LABORATORY ACCREDITATIONS AND MEASUREMENT UNCERTAINTY	8
5.1 LABORATORY ACCREDITATION.....	8
5.2 MEASUREMENT UNCERTAINTY	8
6- TECHNICAL REQUIREMENTS AND RESULTS.....	9
6.1 CARRIER FREQUENCY SEPARATION MEASUREMENT.....	9
6.2 NUMBER OF HOPPING FREQUENCIES MEASUREMENT	11
6.3 TIME OF OCCUPY (DWELL TIME) MEASUREMENT	13
6.4 PEAK OUTPUT POWER MEASUREMENT.....	15
6.5 BAND EDGE OF CONDUCTED EMISSION AND SPURIOUS RF CONDUCTED EMISSIONS.....	24
6.6 SPURIOUS RADIATED EMISSION MEASUREMENT	31
6.7 BAND EDGE AND RESTRICTED BAND OF RADIATED EMISSION MEASUREMENT.....	37
6.8 99% BANDWIDTH MEASUREMENT.....	43
6.9 POWER SPECTRAL DENSITY MEASUREMENT	48
6.10 RF EXPOSURE	53
6.11 ANTENNA REQUIREMENT	53

1- Test Result Certification

Applicant: Sanwa Electronic Instrument Co., Ltd
 1-2-50, Yoshida Honmachi, Higashi-Osaka, Osaka
 578-0982, Japan

Equipment Under Test: 2.4GHz Radio Control System

Trade Mark: **SANWA**

Model Number.: 90482

Type of Modulation: FHSS
 FHSS-DSSS Hybrid
 [Mode FH2, FH3, FH3F, FH4T, FH4FT]

Number of Channels: 56

Channel Separation: 1MHz

Operation Frequency: 2410-2465MHz

Antenna Designation: Non-user replaceable (fixed)

Power Supply: DC6.0V [4*1.5V size "AA" batteries]

Date of Test: June 28 to July 20, 2012

Applicable Standards	
Standard	Test Result
FCC 47 CFR Part 15 Subpart C, §15.247 Industry Canada: RSS-210 issue 8: 2010, Annex 8 Industry Canada: RSS-Gen issue 3: 2010	No non-compliance noted

We hereby certify that:

The above equipment was tested at ATC Lab Co., Ltd (Guangdong, China). The test data, data evaluation, test procedures, and equipment configurations shown in this report were made in accordance with the procedures given in ANSI C63.4-2003 and Public Notice DA 00-705. The energy emitted by the sample EUT tested as described in this report is in compliance with conducted and radiated emission limits of FCC Rules Part 15C: 2007, §15.247 and RSS-210 Issue 8, Annex 8.

The test results of this report relate only to the tested sample identified in this report.

2- EUT Description

Product Name:	2.4GHz Radio Control System
Trade Mark:	SANWA
Model Number:	90482
Model Difference:	N/A
Type of Modulation::	FHSS FHSS-DSSS Hybrid [Mode FH2, FH3, FH3F, FH4T, FH4FT]
Number of Channels:	56
Channel Separation:	1MHz
Power Supply:	6.0V DC power from 4*1.5V size "AA" batteries
Frequency Range:	2410~2465 MHz
Antenna Designation:	Non-user replaceable (fixed)

Remark: This submittal(s) test report is intended for FCC ID: L73-90482, IC: 7377A-90482 filing to comply with Section 15.247 of the FCC Part 15, Subpart C Rules and RSS-210 Issue 8, Annex 8.

3-Test System

3.1 Test Mode

The compliance test was performed under test modes:

Mode 1: Transmitting at 2410MHz without hopping in FHSS mode.

Mode 2: Transmitting at 2437MHz without hopping in FHSS mode.

Mode 3: Transmitting at 2465MHz without hopping in FHSS mode.

Mode 4: Transmitting with hopping in FHSS mode.

Mode 5: Transmitting at 2410MHz in FHSS-DSSS Hybrid Mode

Mode 6: Transmitting at 2437MHz in FHSS-DSSS Hybrid Mode

Mode 7: Transmitting at 2465MHz in FHSS-DSSS Hybrid Mode

The EUT is designed both of horizontally placed and vertically placed. In radiated emission measurement, each condition was conducted.

As a result, the below operation that produce the maximum emission were reported.

- a) Carrier Frequency Separation measurement ---Mode 4
- b) Number of Hopping Frequencies measurement --- Mode 4
- c) Time of Occupancy measurement --- Mode 4
- d) Peak Output Power measurement --- Mode 1, Mode 2, Mode 3, Mode5, Mode 6, Mode7.
- e) Band Edge of RF Conducted measurement --- Mode 1, Mode 3, Mode 4, Mode 5, Mode 7.
- f) Radiated Emission measurement --- Mode 1, Mode 2, Mode 3, Mode 5, Mode 6, Mode 7.
- g) Band Edge and Restricted Band of Radiated Emission measurement--- Mode 1, Mode 3, Mode 5, Mode 7.
- h) 99% Bandwidth measurement --- Mode 1, Mode 2, Mode 3, Mode 5, Mode 6, Mode7.
- f) Power Spectral Density Measurement--- Mode 5, Mode 6 and Mode 7.

3.2 Test Setup Diagram

- . Carrier Frequency Separation
- . Number of Hopping Frequencies
- . Time of Occupancy (Dwell Time)
- . Peak Output Power
- . Band Edge of RF Conducted Emission
- . 99% Bandwidth
- . Power Spectral Density Measurement

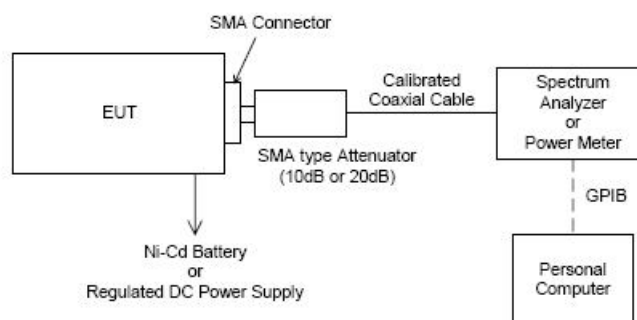

Note: Regulated DC power supply is not used in this report.

. Radiated Emision

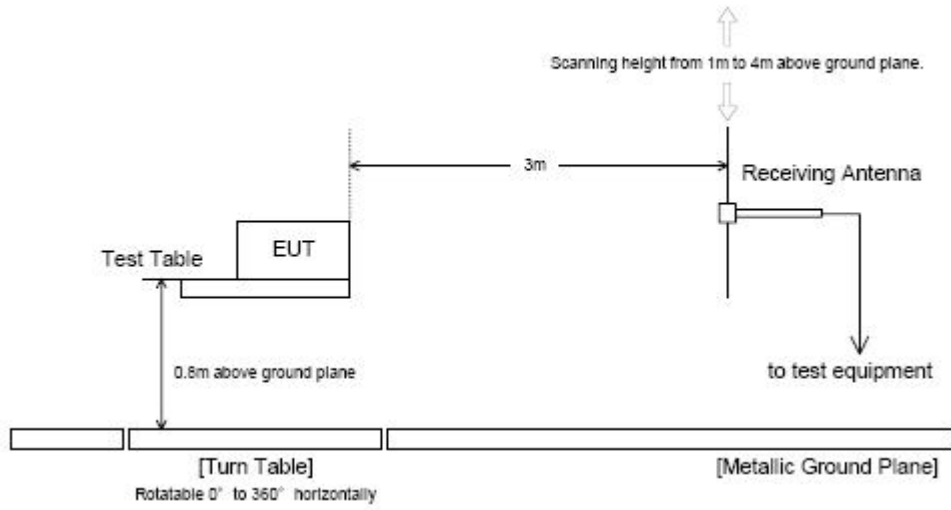

3.3 Block Diagram of EUT System

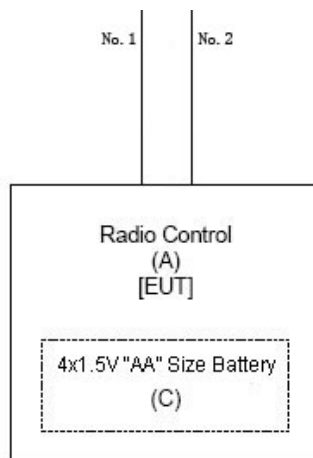

[The transmitter has two antennas (No.1 & No.2), which are located in the vertical back portion of the carrying handle and work alternately]

3.4 List of Cables

No	Cable Name	Shielded (Y/N)	Length (m)	Note	Remark
1	Antenna	Y	0.15	/	/
2	Antenna	Y	0.15	/	/

4- Test Equipment and Calibration

Equipment type	Manufacturer	Model	Serial Number	Calibration Due
Biconilog Antenna	ETS	3142C	00042672	2012/09
HF Loop Antenna	TESEQ	HLA6120	26348	2012/09
Receiver	SCHAFFNER	SMR4503	11725	2013/07
Spectrum Analyzer	R/S	FSP30	100755	2012/11
Double-Ridged Wave Guide Horn Antenna	ETS	3115	6587	2012/08
Double-Ridged Wave Guide Horn Antenna	ETS	3160	00052486	2012/08
Amplifier	Agilent	83017A	MY39500438	2012/11
Band-pass Filter	Micro-Tronic	BRM50702	S/N-030	2012/11

5- Laboratory Accreditations and Measurement Uncertainty

5.1 Laboratory Accreditation

FCC-Registration No.: 415467

ATC Lab Co., Ltd (Guangdong, China) EMC Laboratory has been registered and fully described in a report filed with the FCC (Federal Communications Commission). The acceptance letter from the FCC is maintained in our files: Registration 415467, Listing date December 01, 2011.

IC-Registration No.: 7949A

The 3m Alternate Test Site of ATC Lab Co., Ltd (Guangdong, China) has been registered by Certification and Engineering Bureau of Industry Canada for the performance of radiated measurements with Registration No. 7949A on May 25th, 2011.

5.2 Measurement Uncertainty

of +/- 3×10^{-9} for Carrier Frequency Separation Measurement
of +/- 3×10^{-9} for Number of Hopping Frequencies Measurement
of +/- 3×10^{-9} for 20dB Bandwidth Measurement
of +/- 3×10^{-9} for Time of Occupancy (Dwell time) Measurement
of +/- 0.8 dB for Peak Output Power Measurement
of +/- 0.8 dB for Band Edge RF Conducted Measurement
of +/- 0.8 dB for Spurious RF Conducted Emission Measurement
of +/- 0.8 dB for Power Density
of +/- 4.8 dB for Radiated Emissions
of +/- 2.3 dB for Conducted Emissions

6- Technical Requirements and Results

6.1 Carrier Frequency Separation Measurement

Applicable Standard:

According to §15.247(a)(1), Frequency hopping systems shall have hopping channel carrier frequencies separated by a minimum of 25 kHz or the 20 dB bandwidth of the hopping channel, whichever is greater. Alternatively, frequency hopping systems operating in the 2400-2483.5 MHz band may have hopping channel carrier frequencies that are separated by 25 kHz or two-thirds of the 20 dB bandwidth of the hopping channel, whichever is greater

According to RSS 210 issue 8, A8.1(b), frequency hopping systems operating in the 2400-2483.5 MHz band may have hopping channel carrier frequencies that are separated by 25 kHz or two-thirds of the 20dB bandwidth of the hopping channel, whichever is greater.

Test Procedure:

1. Connect the EUT RF output port to spectrum analyzer via calibrated coaxial cable and suitable attenuator (if necessary).
2. Activates the EUT System and execute the software prepared for test, if necessary.
3. To find out the maximum emission condition, the transmitting data rate of EUT is set to maximum data rate.
4. The Spectrums are scanned and allow the trace stabilized.
5. The separation between the peaks of the peaks of adjacent channel were measured by using delta-maker function of the spectrum analyzer

Spectrum analyzer setup condition:

Frequency Span : 2MHz
 Resolution bandwidth : 100kHz
 Video bandwidth : \cong RBW
 Sweep : Auto
 Detector function : Peak
 Trace mode : Max Hold

Test Result:

Temperature:	25°C
Humidity:	53%
EUT Operation:	FHSS modulation with hopping mode
Test Date:	June 29, 2012

Carrier Frequency Separation [MHz]	[MHz] Limit
1.000	> 0.025
Note: Test plot shown in figure 1 on page 10.	

Figure 1: Channel Separation

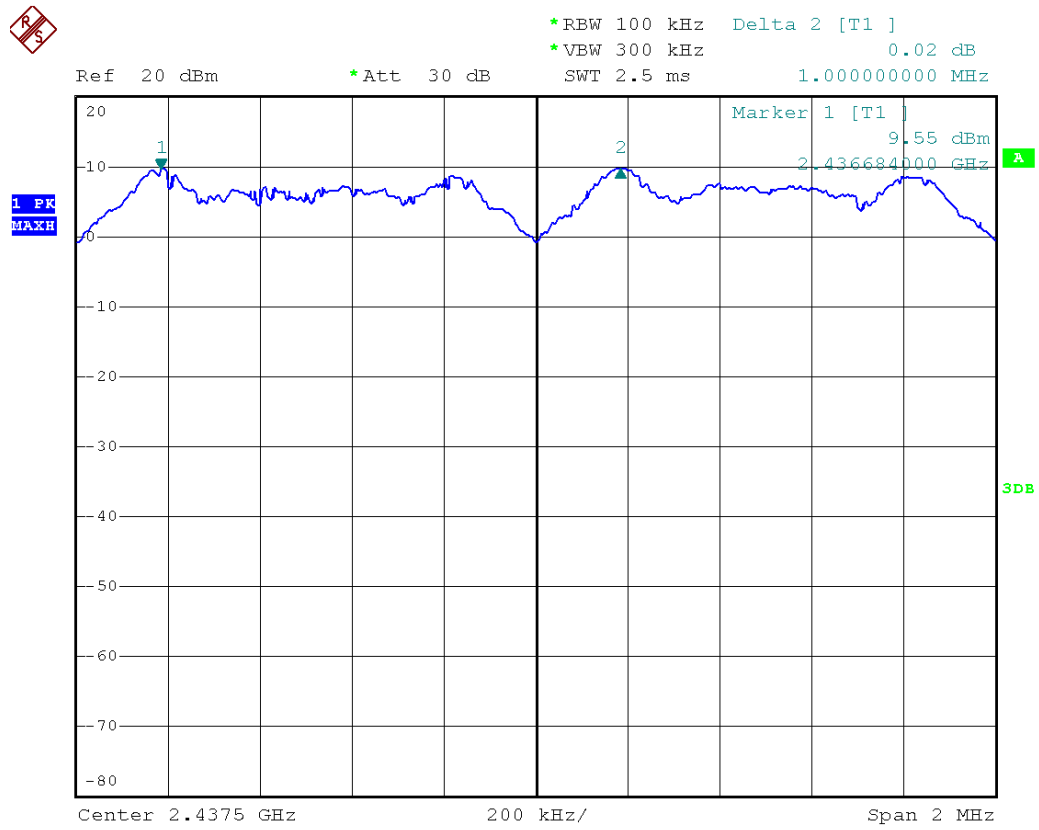

6.2 Number of Hopping Frequencies Measurement

Applicable Standard:

According to §15.247(a)(1)(iii), Frequency hopping systems operating in the 2400MHz-2483.5 MHz bands shall use at least 15 hopping frequencies.

According to RSS-210 issue 8, §A8.1(d), Frequency hopping systems operating in the 2400-2483.5MHz band shall use at least 15 hopping channels. The average time of occupancy on any channel shall not be greater than 0.4 seconds within a period of 0.4 seconds multiplied by the number of hopping channels employed. Transmissions on particular hopping frequencies may be avoided or suppressed provided that a minimum of 15 hopping channels are used.

Test Procedure:

1. Connect the EUT RF output port to spectrum analyzer via calibrated coaxial cable and suitable attenuator (if necessary).
2. Activates the EUT System and executes the software prepared for test, if necessary.
3. To find out the maximum emission condition, the transmitting data rate of EUT is set to maximum data rate.
4. The spectrums are scanned and allow the trace to stabilize.
5. The number of hopping frequencies were counted on the spectrum analyzer and recorded.

Spectrum analyzer setup condition :

Resolution bandwidth : 100KHz
 Video bandwidth : \cong RBW
 Sweep : Auto
 Detector function : Peak
 Trace mode : Max Hold

Test Result:

Temperature:	25 °C
Humidity:	53%
EUT Operation:	FHSS modulation with hopping mode
Test Date:	June 29, 2012

Number of Hopping Frequencies	[MHz] Limit
56	> 15
Note: Test plot shown in figure 2, 3 on page 12.	

Figure 2: Number of Hopping Frequencies

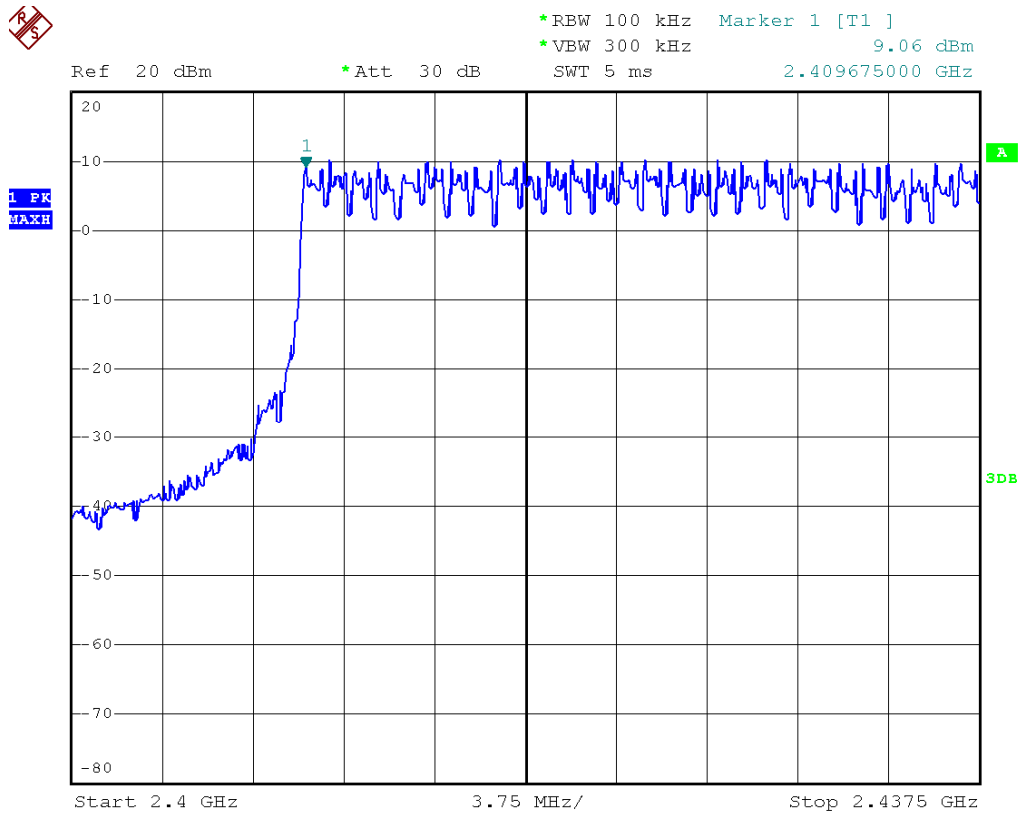
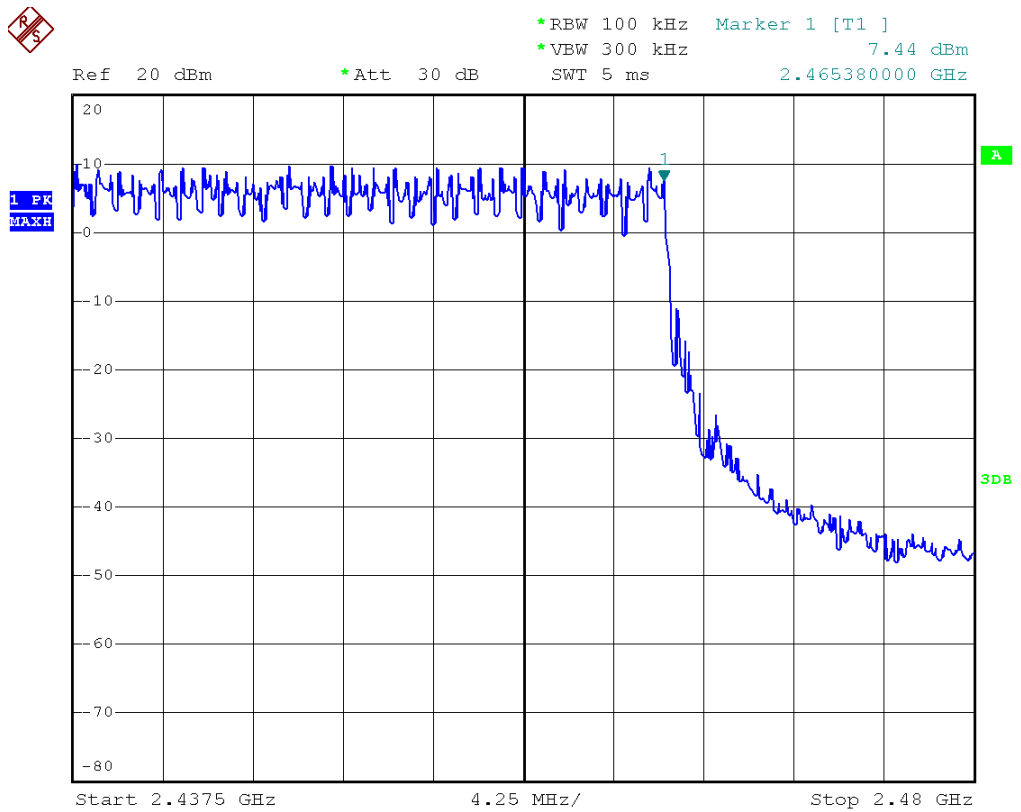

Figure 3: Number of Hopping Frequencies



6.3 Time of Occupy (Dwell Time) Measurement

Applicable Standard:

According to §15.247(a)(1)(iii), Frequency hopping systems operating in the 2400MHz-2483.5 MHz. The average time of occupancy on any frequency shall not greater than 0.4 s within period of 0.4 seconds multiplied by the number of hopping channel employed.

According to RSS-210 issue 8, §A8.1 (d), Frequency hopping systems operating in the 2400-2483.5MHz bands shall use at least 15 hopping channels. The average time of occupancy on any channel shall not be greater than 0.4 seconds within a period of 0.4 seconds multiplied by the number of hopping channels employed. Transmissions on particular hopping frequencies may be avoided or suppressed provided that a minimum of 15 hopping channels are used.

Test Procedure:

1. Connect the EUT RF output port to spectrum analyzer via calibrated coaxial cable and suitable attenuator (if necessary).
2. Activates the EUT System and execute the software prepared for test, if necessary.
3. To find out the maximum emission condition, the transmitting data rate of EUT is set to maximum data rate.
4. The span of spectrum analyzer was set to zero (sweep time 30msec). The occupied time at center on a hopping frequency was observed and recorded as "Ton".
5. The spectrums are scanned by using the spectrum analyzer (*1). And the numbers of occupied channel per Nsec (period of 0.4 seconds multiplied by the number of hopping channels employed) were counted by using the delta-marker function of spectrum analyzer and recorded as "N".
6. The dwell time was calculated by $T_{on} \times N$.

Spectrum analyzer setup condition:

Frequency Span : Zero span

Resolution bandwidth : 1MHz

Video bandwidth : \cong RBW

Sweep : as necessary to capture the entire dwell time per hopping channel.

Detector function : Peak

Trace Mode : Max Hold

Test Result:

Temperature:	25 °C
Humidity:	53%
EUT Operation:	FHSS modulation with hopping mode
Test Date:	June 30, 2012

[ms]Dwell Time	[ms] Limit
0.405ms x 304= 123.12	< 400
Note: Test plots shown in figures 4, 5 on pages 14.	

Figure 4: Duration of One Transmission

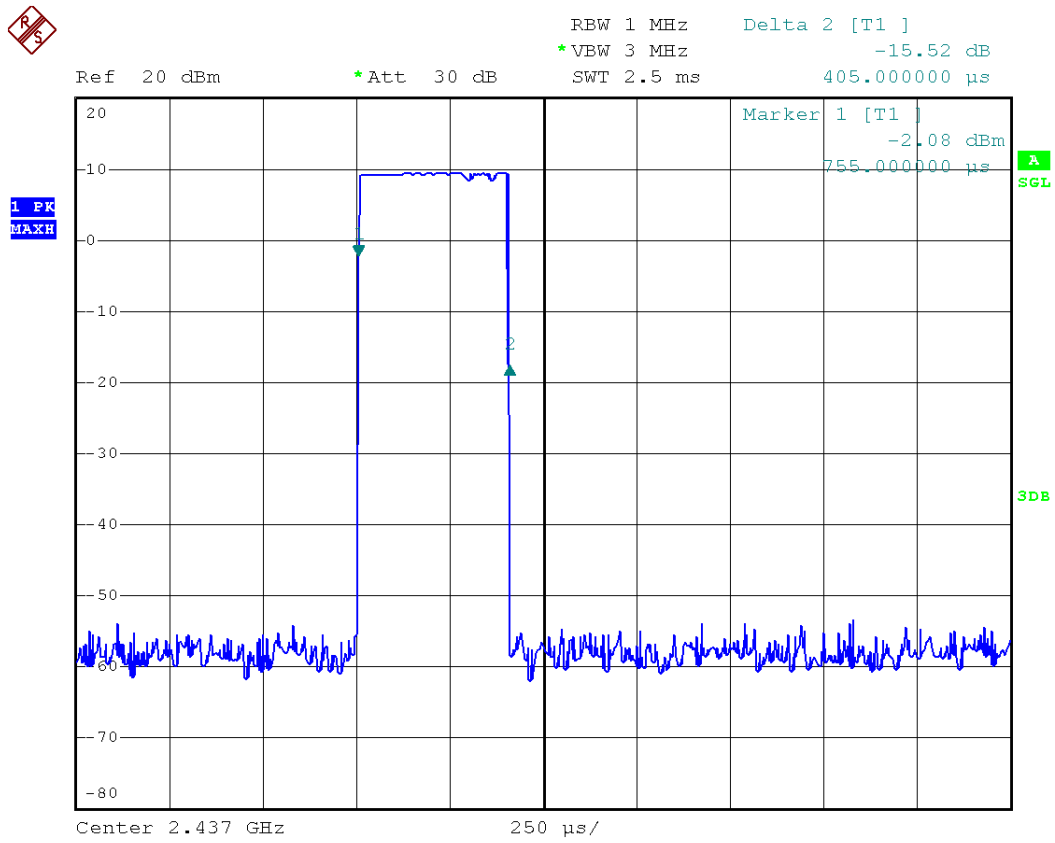
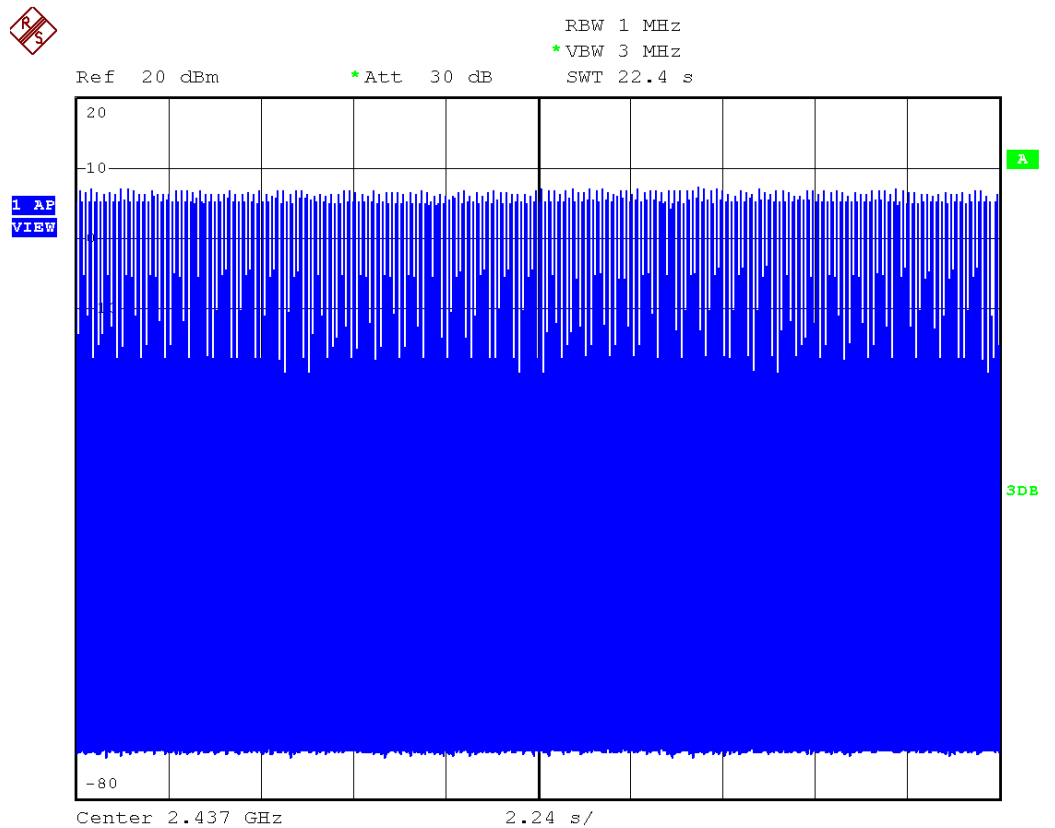

Figure 5: Number of Transmission at 22.4 s



6.4 Peak Output Power Measurement

Applicable Standard:

According to §15.247(b), 1) For frequency hopping systems operating in the 2400-2483.5 MHz band employing at least 75 hopping channels, and all frequency hopping systems in the 5725-5850MHz band: 1Watt. For all other frequency hopping systems in the 2400 – 2483.5MHz band: 0.125 Watts.3) For systems using digital modulation in the 902-928 MHz, 2400-2483.5 MHz, and 5725-5850 MHz bands: 1 Watt. As an alternative to a peak power measurement, compliance with the one Watt limit can be based on a measurement of the maximum conducted output power.

And according to KDB558074 for FHSS-DSSS hybrid mode.

According to RSS-210 issue 8, §A8.4 (2), For frequency hopping systems operating in the 2400-2483.5 MHz band employing at least 75 hopping channels, the maximum conducted output power shall not exceed 1 W. For all other frequency hopping systems, the maximum peak conducted output power shall not exceed 0.125 W. (4) For systems employing digital modulation techniques operating in the bands 902-928 MHz, 2400-2483.5 MHz and 5725-5850 MHz, the maximum peak conducted output power shall not exceed 1 W.

Test Procedure:

1. Connect the EUT RF output port to spectrum analyzer via calibrated coaxial cable and suitable attenuator (if necessary).
2. Activates the EUT System and executes the software prepared for test, if necessary.
3. To find out the worst case, the transmitting data rate of EUT is varied with the different modes of operation. The final test condition is recorded in this report.
4. The spectrums are scanned and allow the trace to stabilize.
5. The peak output power was determined by using the marker-data function of spectrum analyzer or peak type power meter.

Spectrum Analyzer Set Up Conditions

Frequency Span : 5 times 20dB bandwidth of the emission being measured

Resolution bandwidth : 3MHz

Video bandwidth : \cong RBW

Sweep : Auto

Detector function : Peak

Trace Mode : Max Hold

Test Result:

Temperature:	25 °C
Humidity:	52%
EUT Operation:	FHSS without hopping and FHSS-DSSS hybrid mode
Test Date:	July 04, 2012

Antenna Port 1# Type of Modulation: FHSS					
Frequency	Factor	Reading	Power	Limit	Margin
[MHz]	[dB]	[dBm]	[dBm]	[dBm]	[dB]
2410	1.00	10.33	11.33	30.00	-18.67
2437	1.00	9.99	10.99	30.00	-19.01
2465	1.00	9.32	10.32	30.00	-19.68

Note: Test plots shown in figures 6, 7 and 8 on pages 18, 19.

Antenna Port 1# Type of Modulation: FHSS-DSSS hybrid					
Frequency	Factor	Reading	Power	Limit	Margin
[MHz]	[dB]	[dBm]	[dBm]	[dBm]	[dB]
2410	1.00	11.33	12.33	30.00	-17.67
2437	1.00	11.30	12.30	30.00	-17.70
2465	1.00	11.18	12.18	30.00	-17.82

Note: Test plots shown in figures 9, 10, 11 on pages 19, 20.

Antenna Port 2# Type of Modulation: FHSS					
Frequency	Factor	Reading	Power	Limit	Margin
[MHz]	[dB]	[dBm]	[dBm]	[dBm]	[dB]
2410	1.00	12.52	13.52	30.00	-16.48
2437	1.00	12.16	13.16	30.00	-16.84
2465	1.00	11.85	12.85	30.00	-17.15

Note: Test plots shown in figures 12, 13 and 14 on pages 21, 22.

Antenna Port 2# Type of Modulation: FHSS-DSSS hybrid					
Frequency	Factor	Reading	Power	Limit	Margin
[MHz]	[dB]	[dBm]	[dBm]	[dBm]	[dB]
2410	1.00	12.55	13.55	30.00	-16.45
2437	1.00	12.31	13.31	30.00	-16.69
2465	1.00	11.76	12.76	30.00	-17.24

Note: Test plots shown in figures 15, 16, 17 on pages 22, 23.

Figure 6: Peak Output Power - low channel

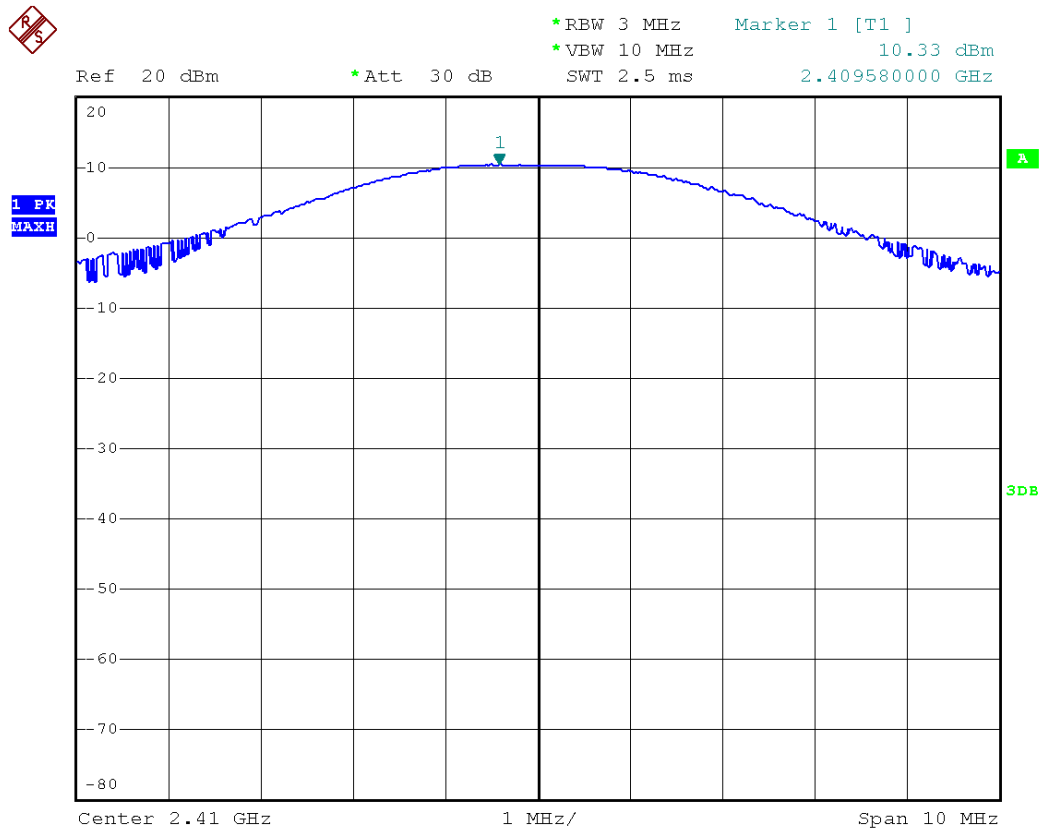

Figure 7: Peak Output Power - middle channel

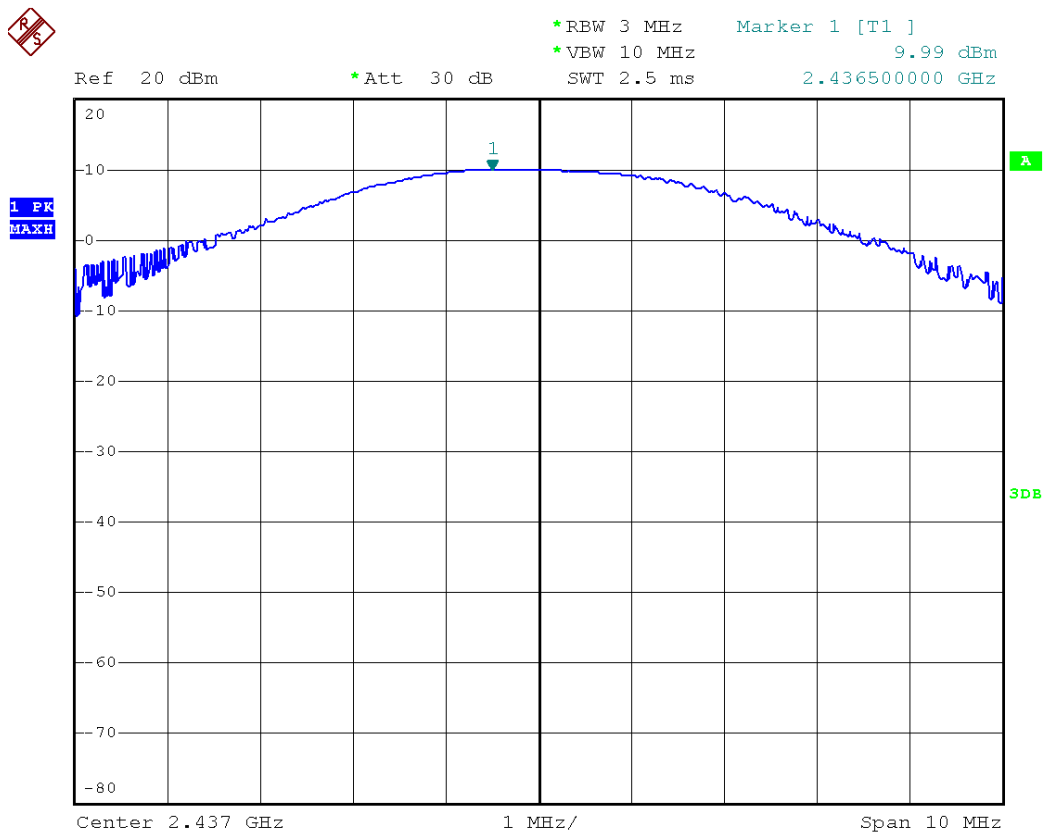

Figure 8: Peak Output Power - high channel

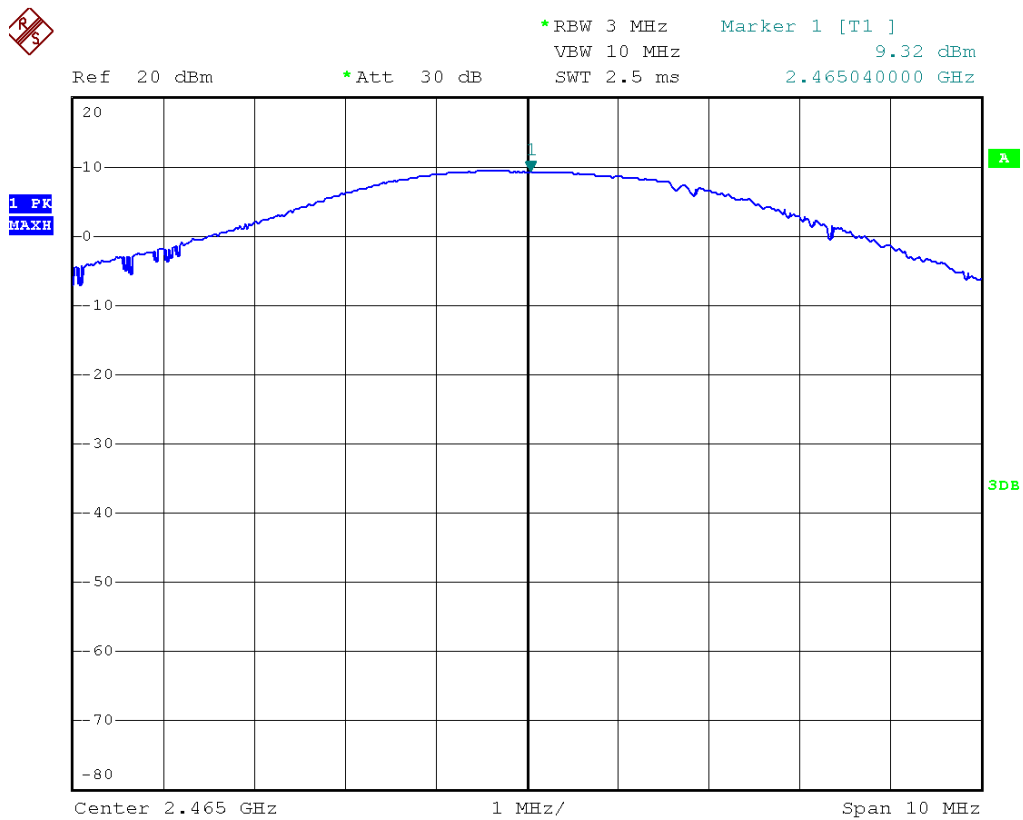

Figure 9: Peak Output Power - low channel

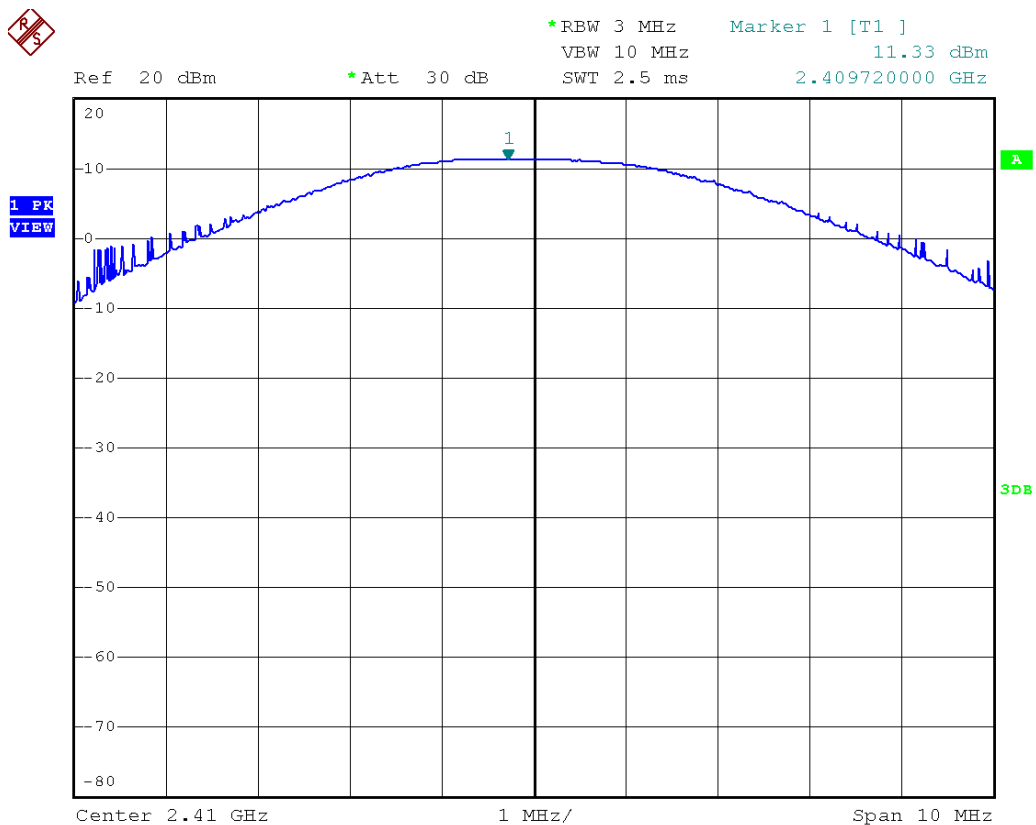

Figure 10: Peak Output Power - middle channel

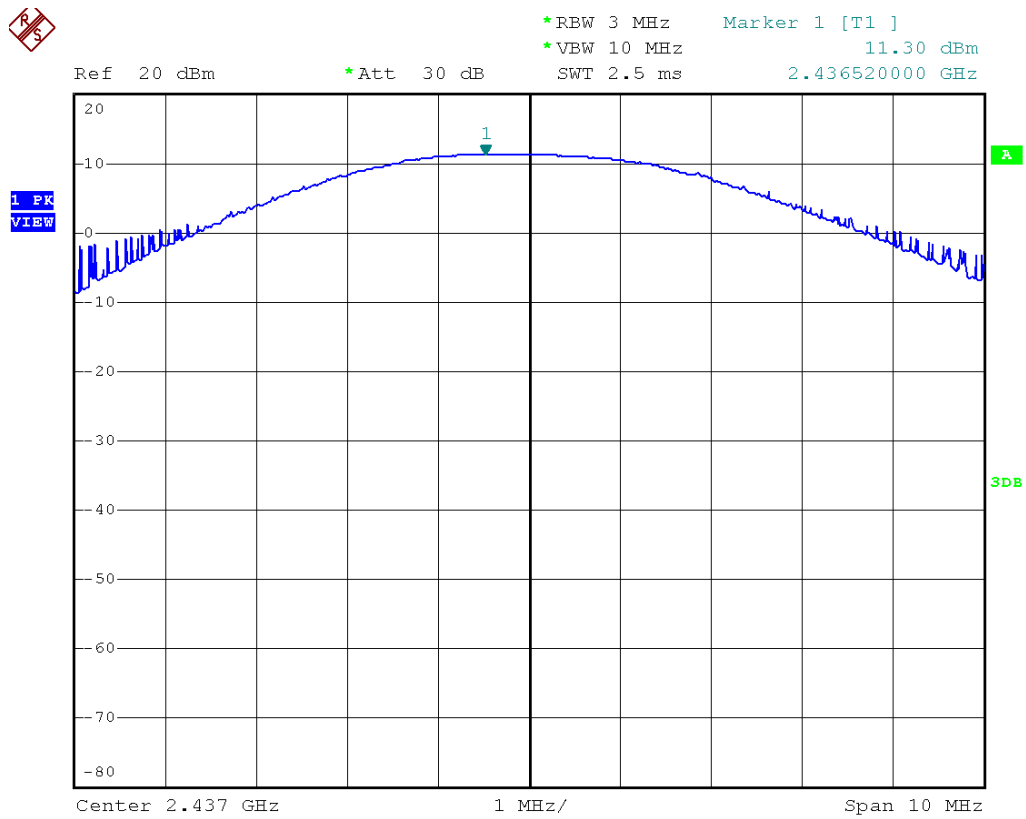

Figure 11: Peak Output Power - high channel

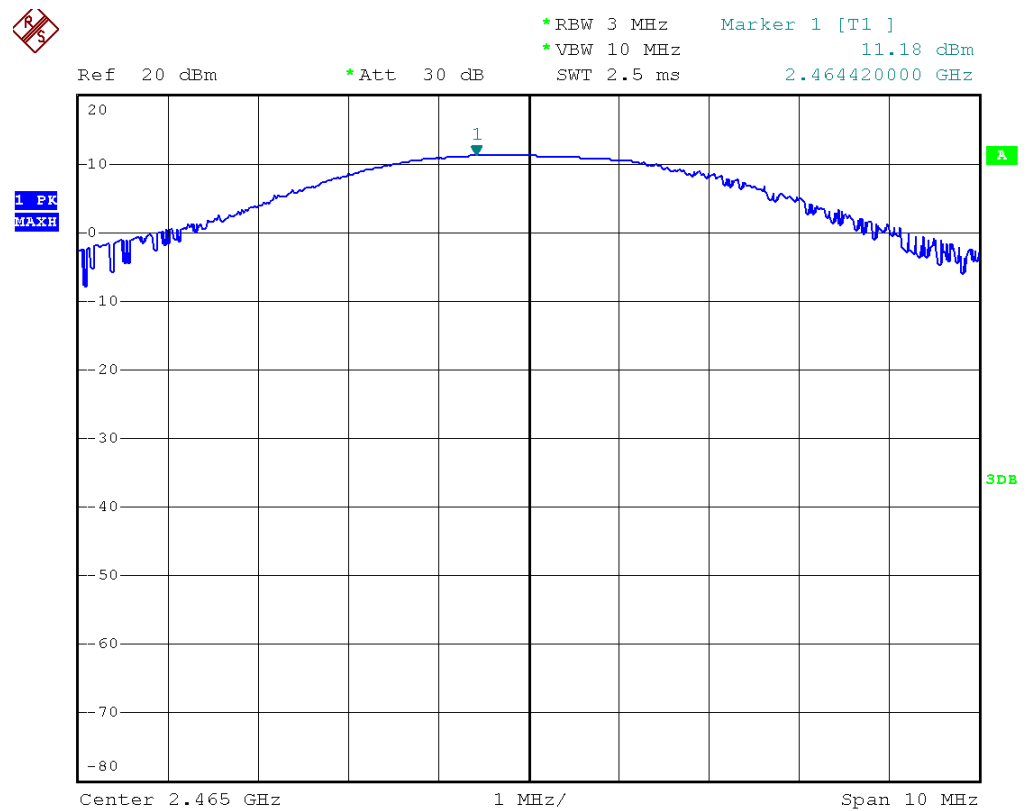

Figure 12: Peak Output Power - low channel

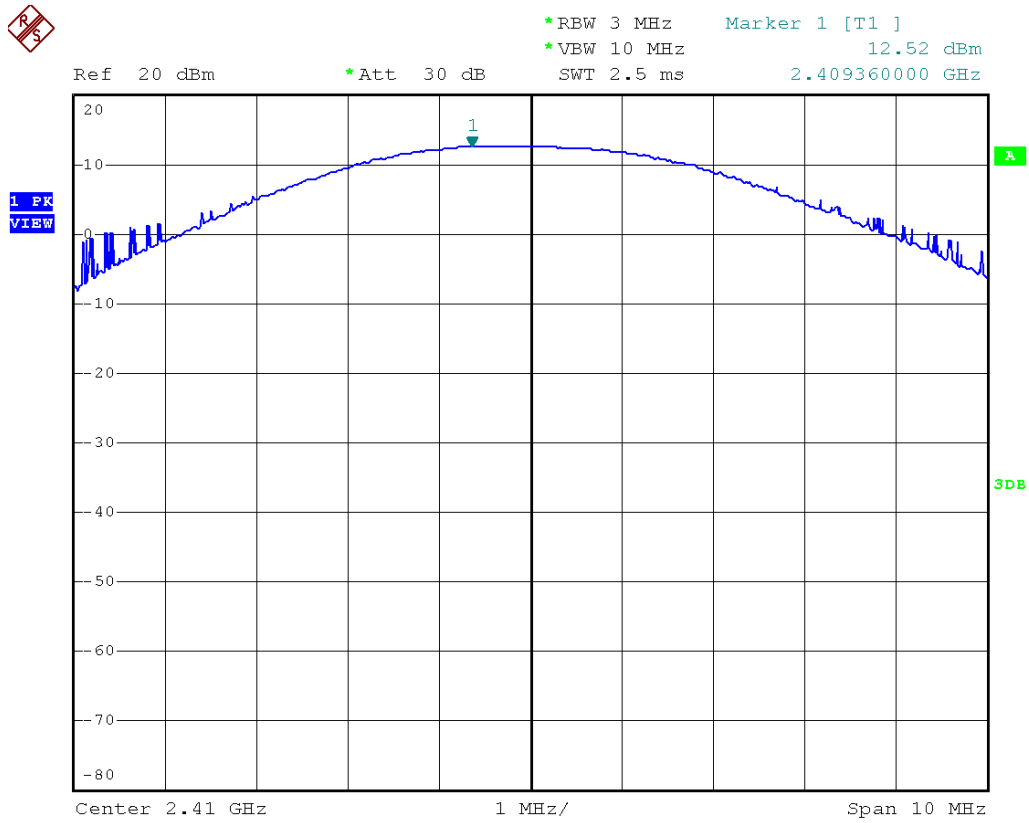

Figure 13: Peak Output Power - middle channel

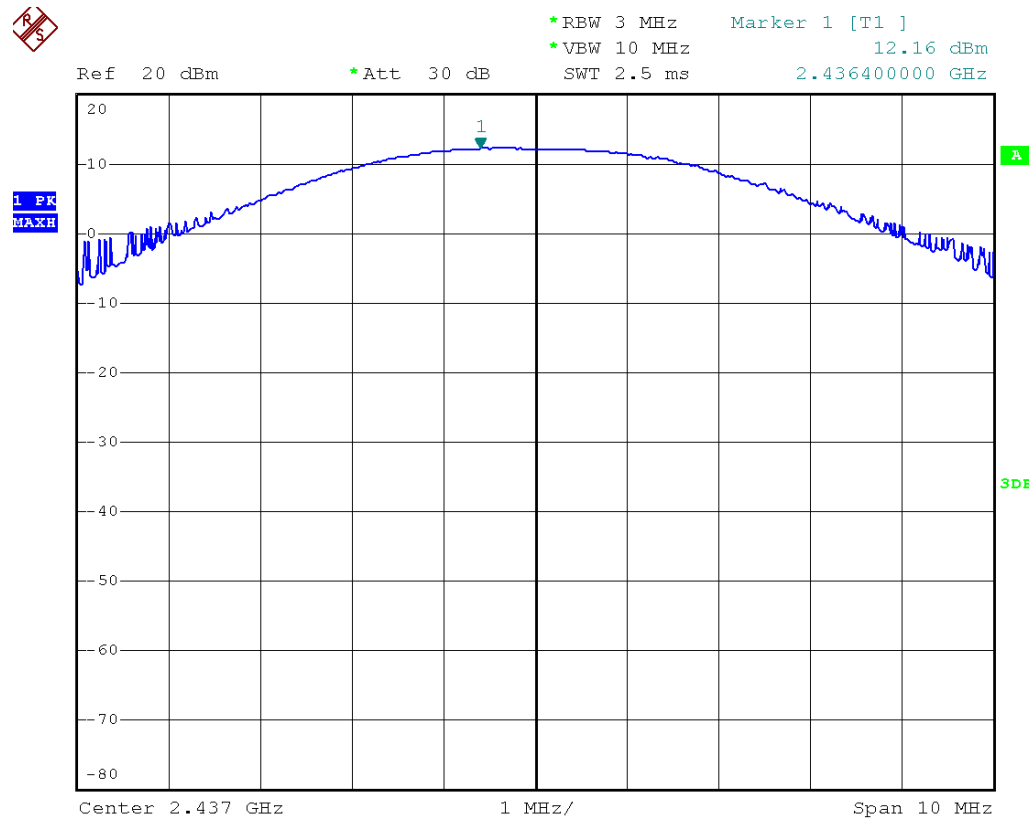

Figure14: Peak Output Power - high channel

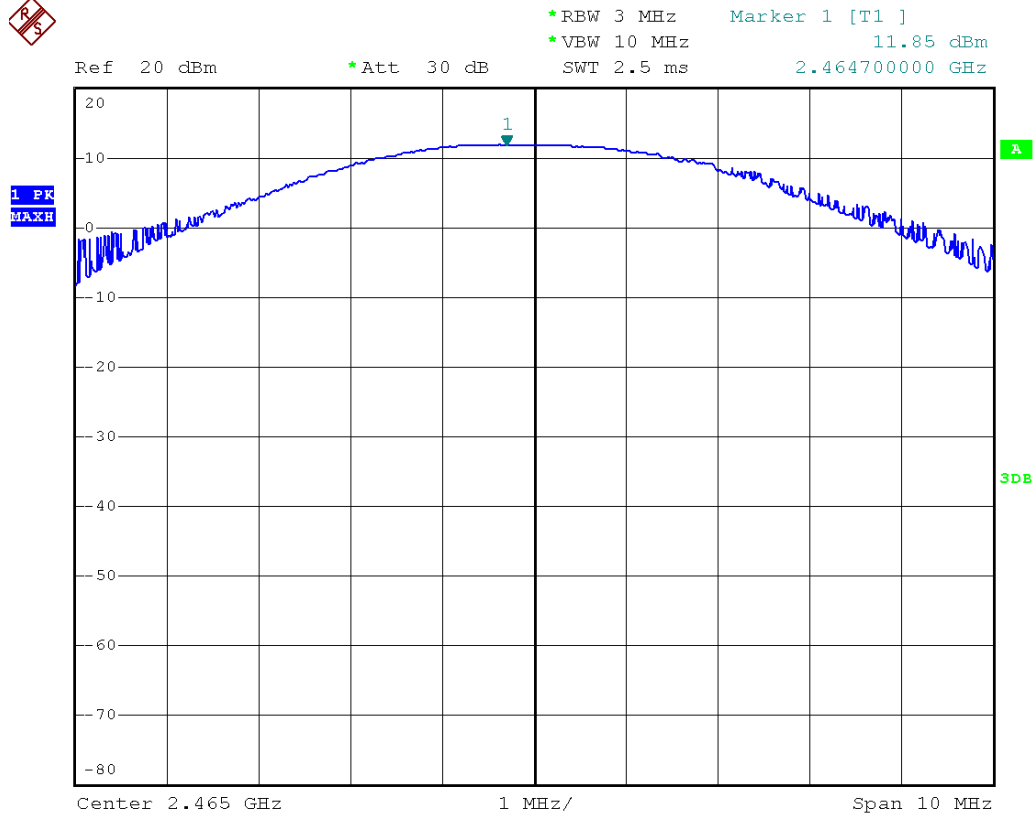

Figure 15: Peak Output Power - low channel

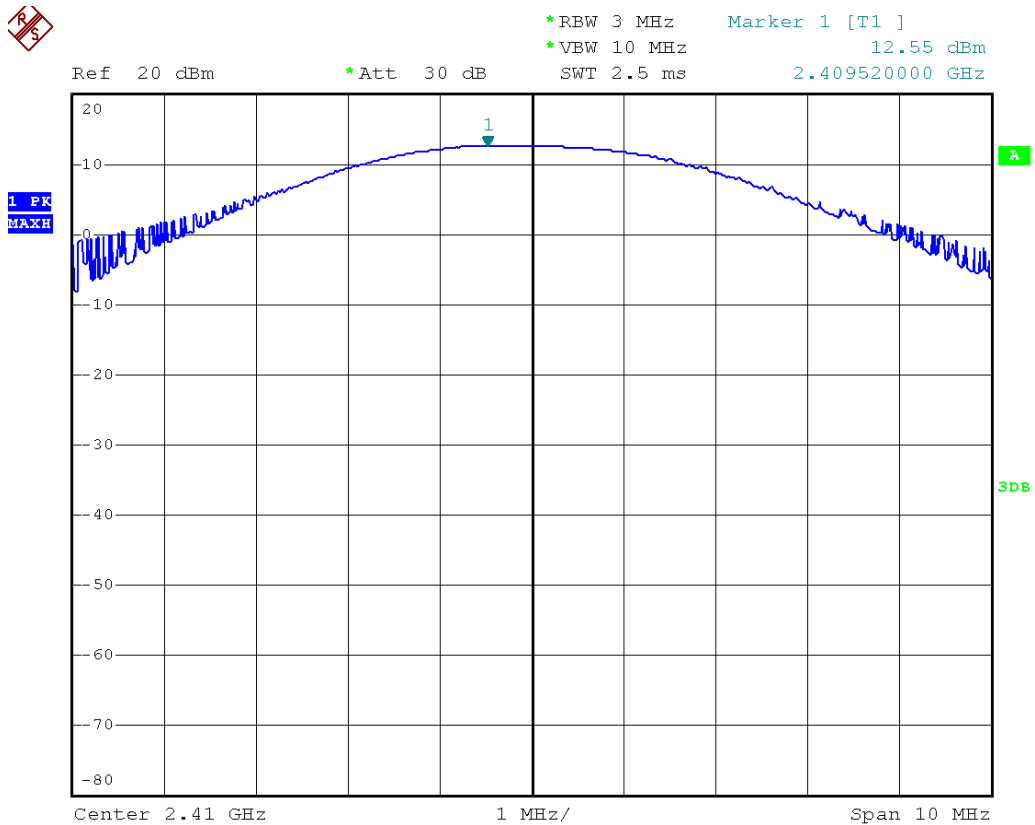

Figure 16: Peak Output Power - middle channel

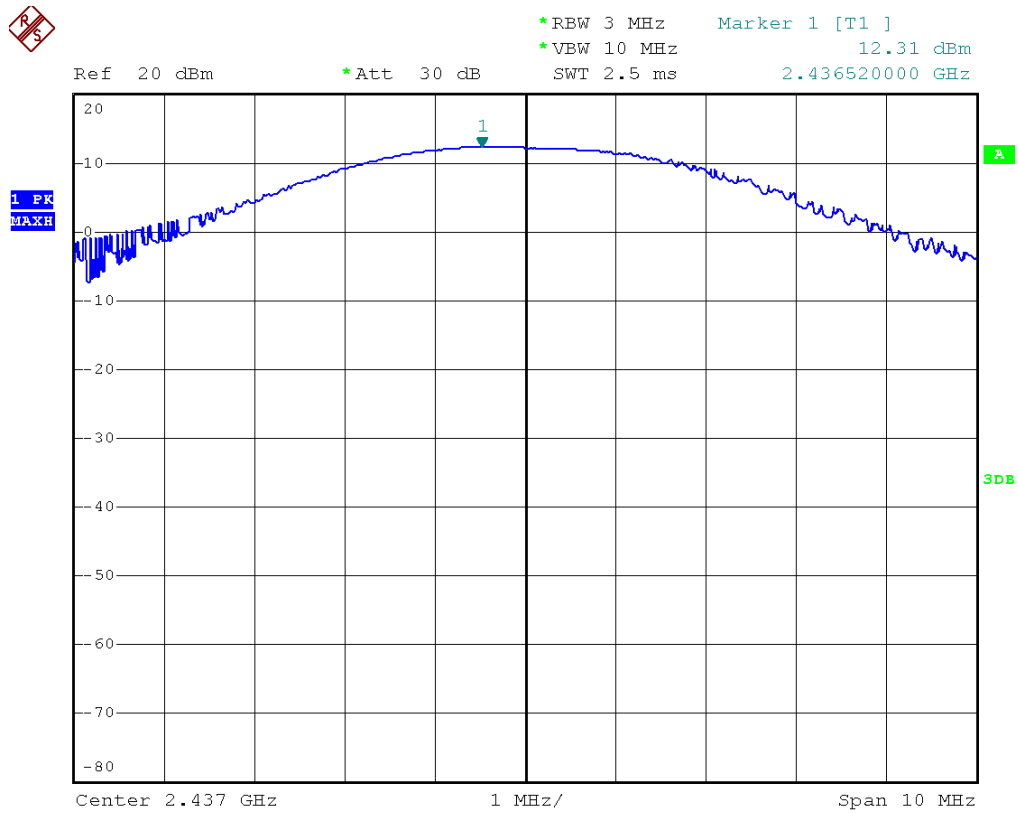
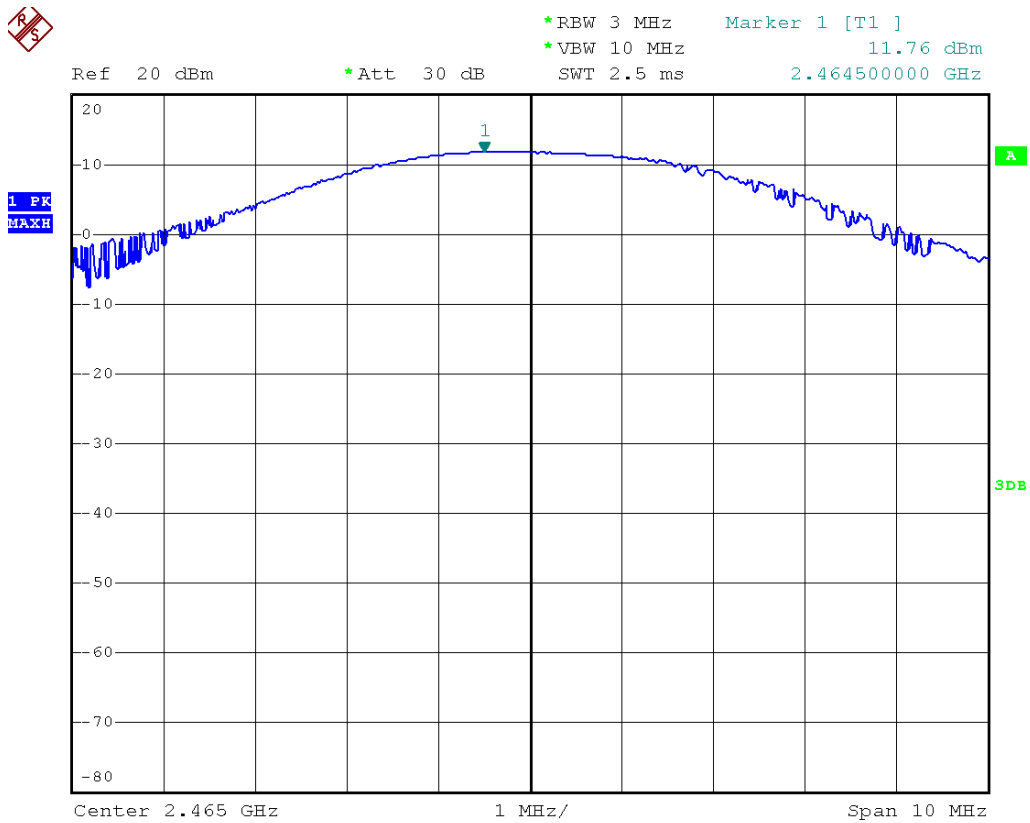

Figure 17: Peak Output Power - high channel



6.5 Band Edge of Conducted Emission and Spurious RF Conducted Emissions

Applicable Standard:

According to §15.247(d), in any 100 KHz bandwidth outside the frequency bands in which the spread spectrum intentional radiator is operating, the radio frequency power that is produced by the intentional radiator shall be at least 20dB below that in the 100KHz bandwidth within the band that contains the highest level of the desired power, In addition, radiated emissions which fall in the restricted bands, as defined in §15.205(a), must also comply with the radiated emission limits specified in 15.209(a).

And according to KDB558074 for FHSS-DSSS hybrid mode.

According to RSS-210 issue 8, §A8.5, In any 100 kHz bandwidth outside the frequency band in which the spread spectrum or digitally modulated device is operating, the radio frequency power that is produced shall be at least 20 dB below that in the 100 kHz bandwidth within the band that contains the highest level of the desired power, based on either an RF conducted or a radiated measurement, provided the transmitter demonstrates compliance with the peak conducted power limits. If the transmitter complies with the conducted power limits based on the use of RMS averaging over a time interval, as permitted under section A8.4(4), the attenuation required shall be 30 dB instead of 20 dB. Attenuation below the general limits specified in Tables 2 and 3 is not required. In addition, radiated emissions which fall in the restricted bands of Table 1 must also comply with the radiated emission limits specified in Tables 2 and 3.

Test Procedure:

1. Connect the EUT RF output port to the spectrum analyzer via calibrated coaxial cable and suitable attenuator (if necessary).
2. Activates the EUT System and executes the software prepared for test, if necessary.
3. To find out the maximum emission condition, the transmitting data rate of EUT is set to maximum data rate.
4. The spectrum are scanned.
5. The emission at the band edge or the highest modulation product outside of band were measured by using the marker function of spectrum analyzer (*1).
6. The peak of the in-band emission were measured by using the marker to peak function of spectrum analyzer.
7. Above measurement were repeated at other side band edge.

Frequency Span : Wide enough to capture the peak level of emission on the band edge

Resolution bandwidth : 100kHz

Video bandwidth : \cong RBW

Sweep : Auto

Detector function : Peak

Trace Mode : Max Hold

Temperature:	25 °C
Humidity:	51%
EUT Operation:	Hopping & without hopping in FHSS and FHSS-DSSS hybrid mode
Test Date:	July 05, 2012

The unit does meet the requirements.

Test plots in FHSS mode shown in figures 18, 19, 20, 21, 22, 23, 24 on pages 25, 26, 27, 28;

Test plots in FHSS-DSSS hybrid mode shown in figures 25, 26, 27, 28, 29 on pages 28, 29, 30.

Figure 18: Band Edge - low frequency side without hopping

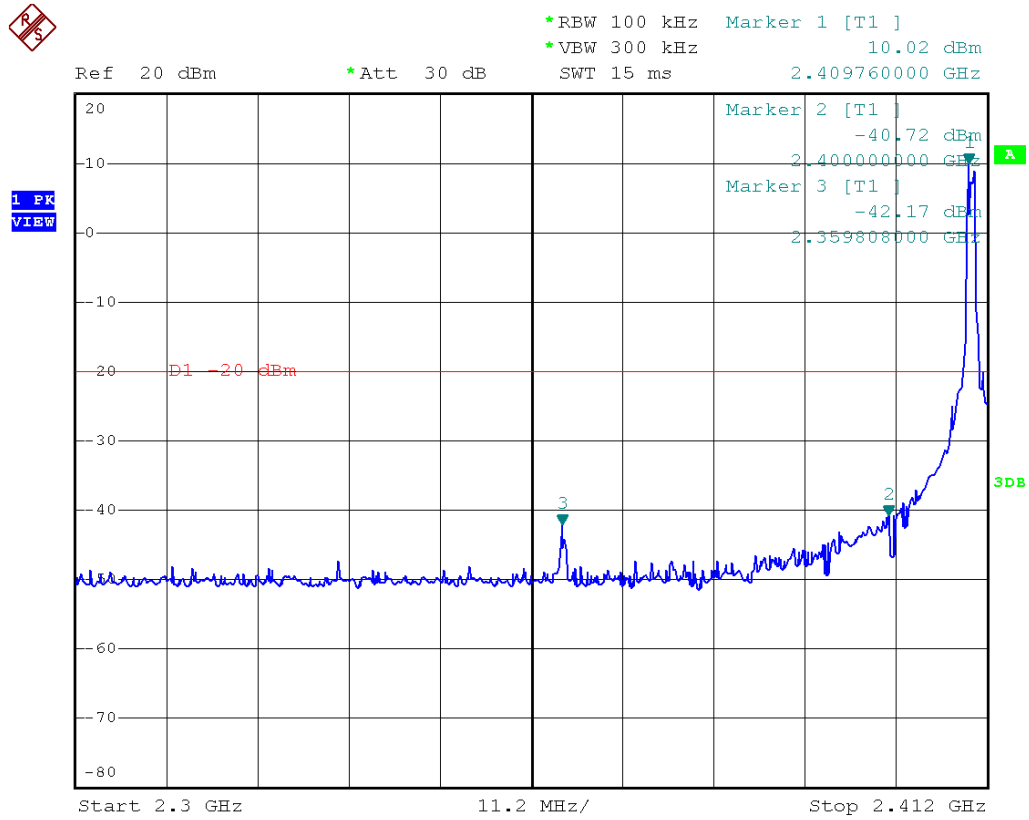

Figure 19: Band Edge – high frequency side without hopping

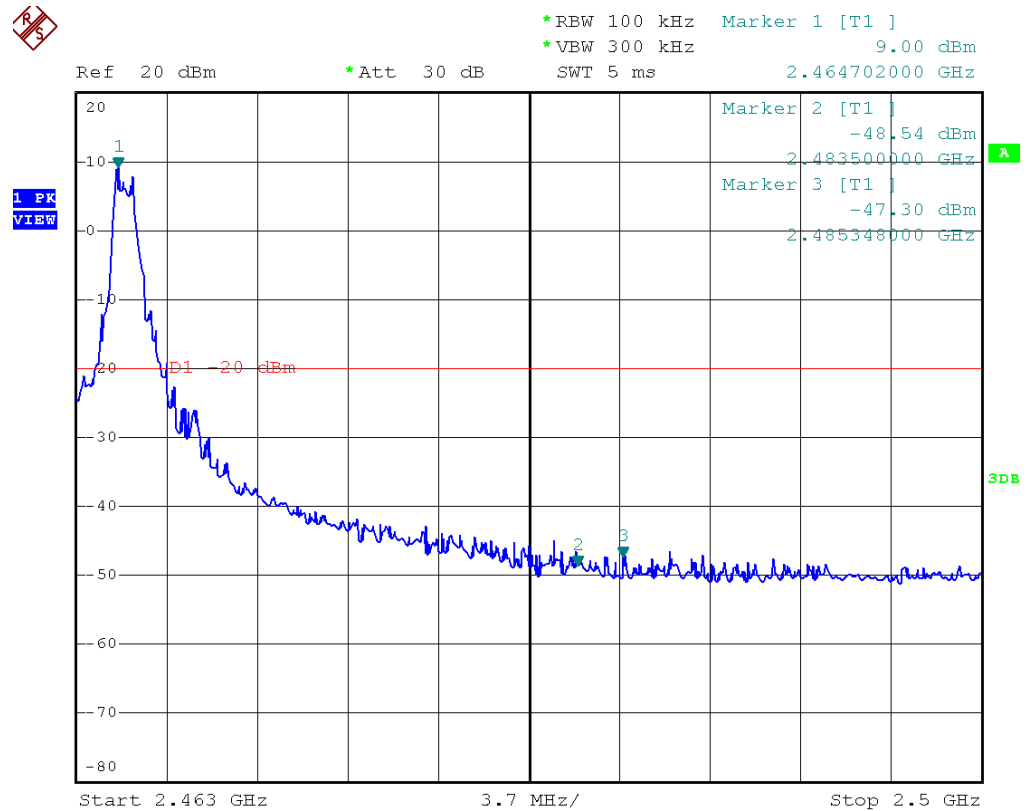

Figure 20: Band Edge – low frequency side with hopping

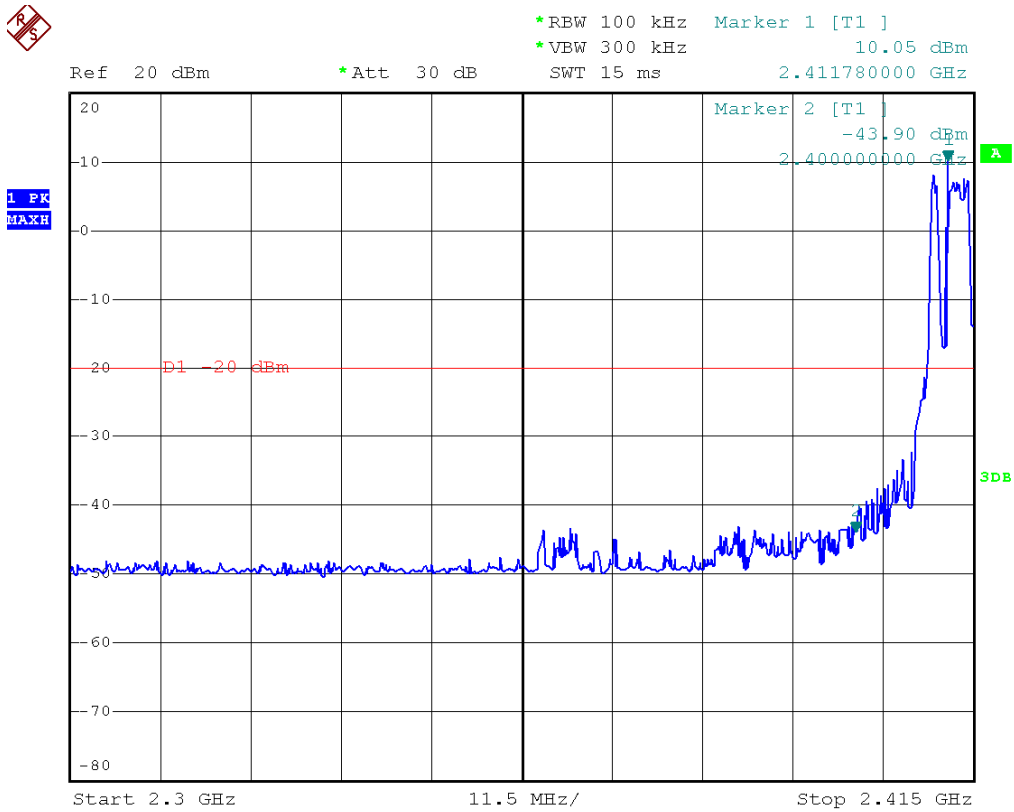

Figure 21: Band Edge – high frequency side with hopping

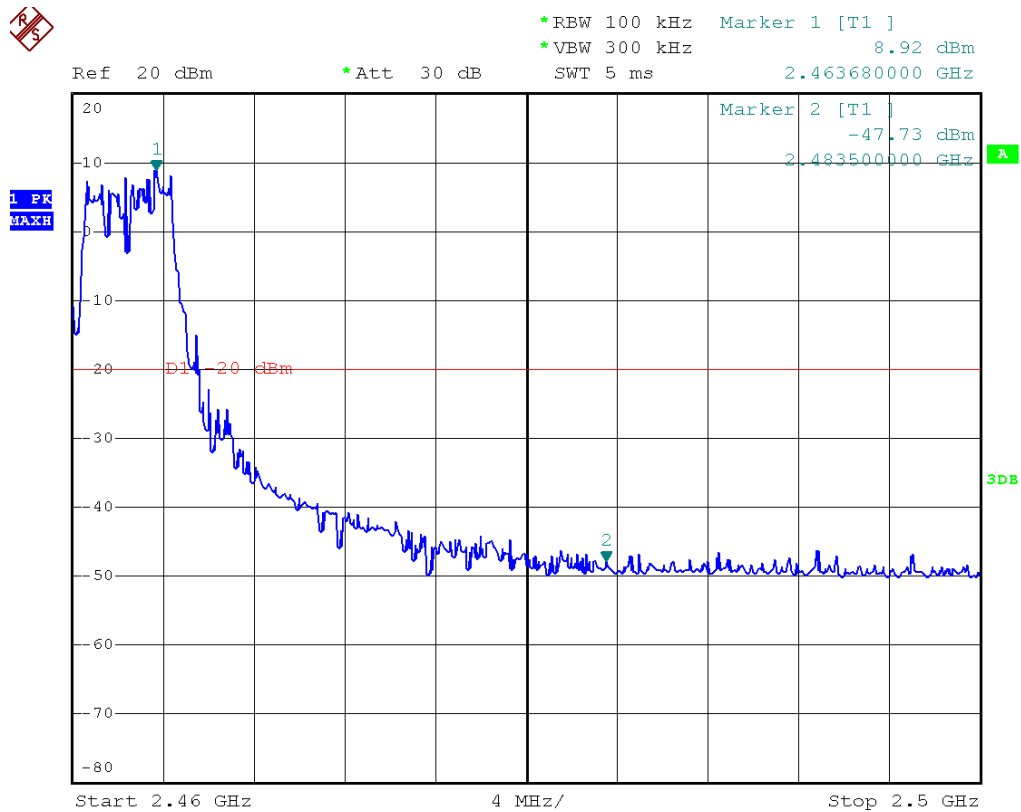

Figure 22 Conducted Spurious Emissions, low channel

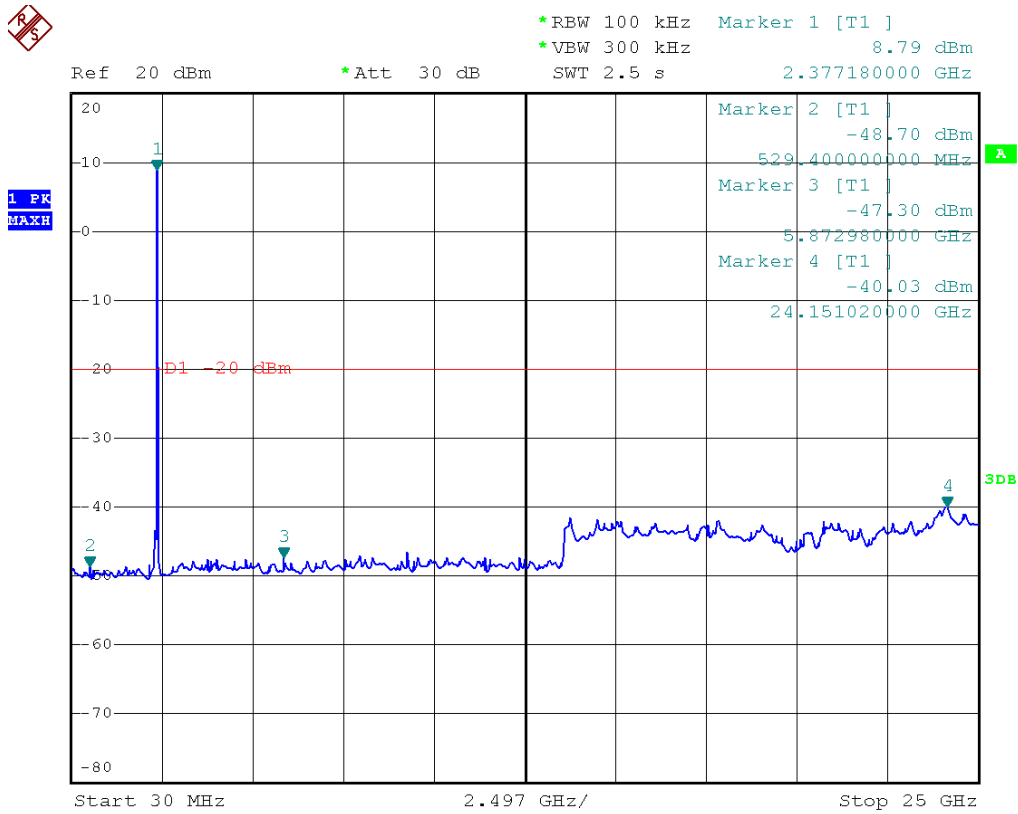

Figure 23 Conducted Spurious Emissions, middle channel

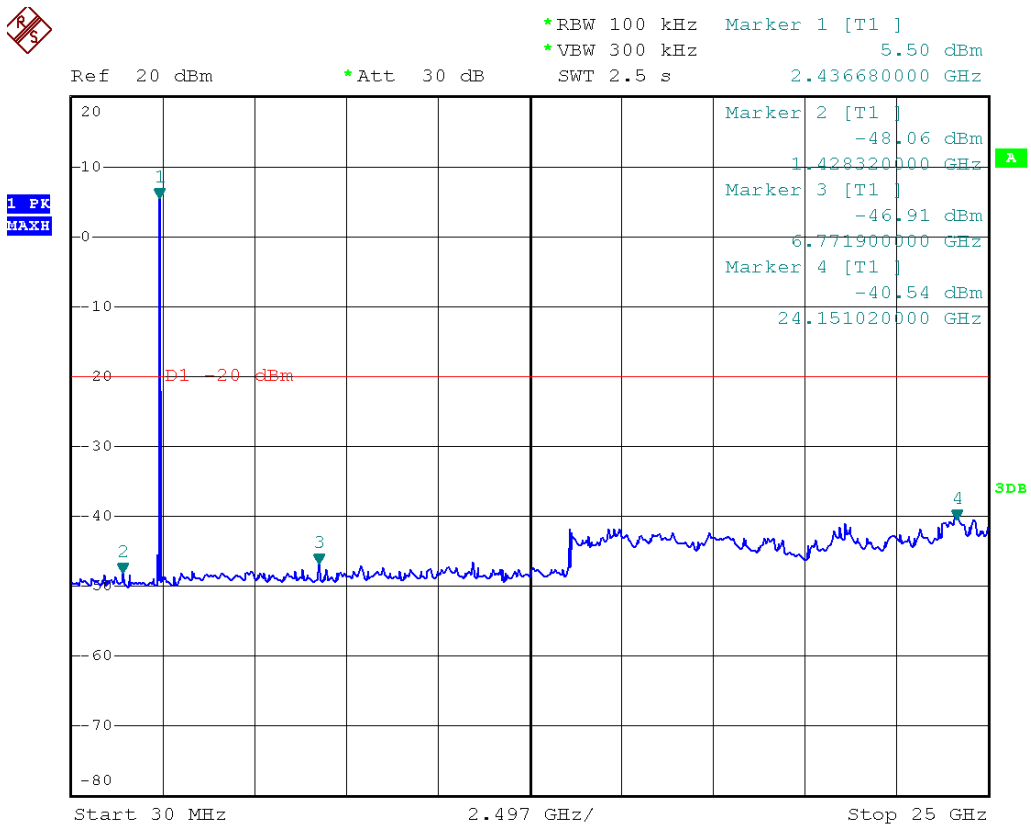

Figure 24 Conducted Spurious Emissions, high channel

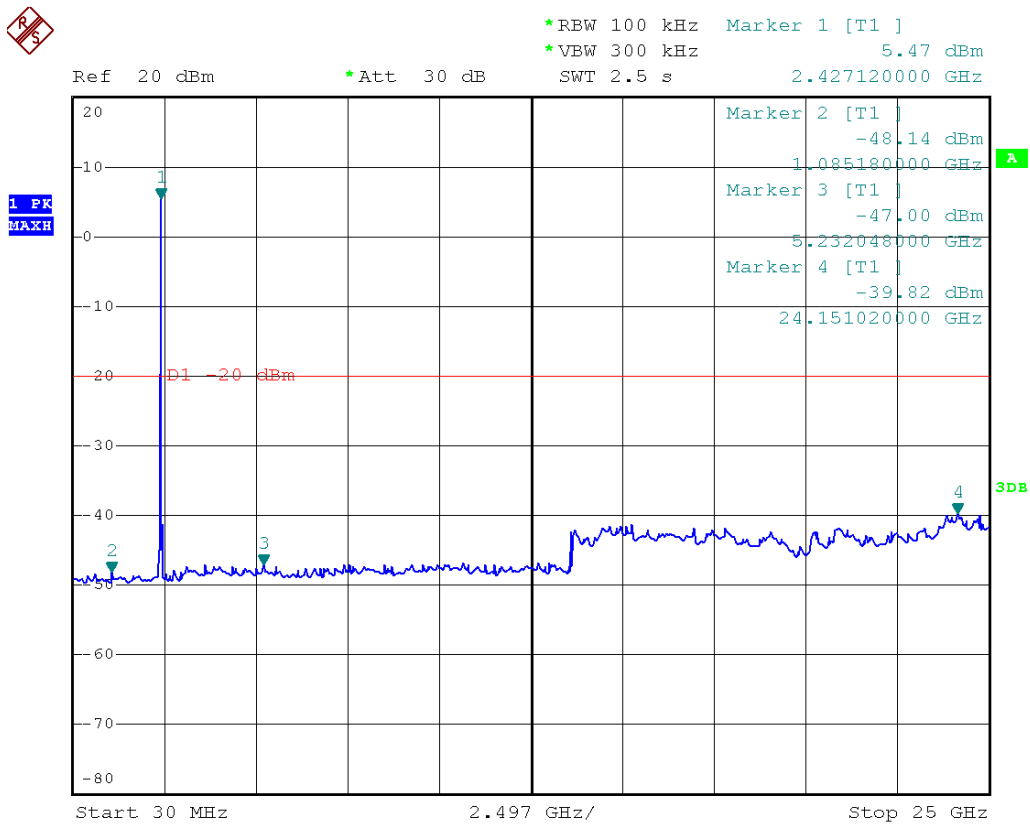

Figure 25: Band Edge - low frequency side without hopping

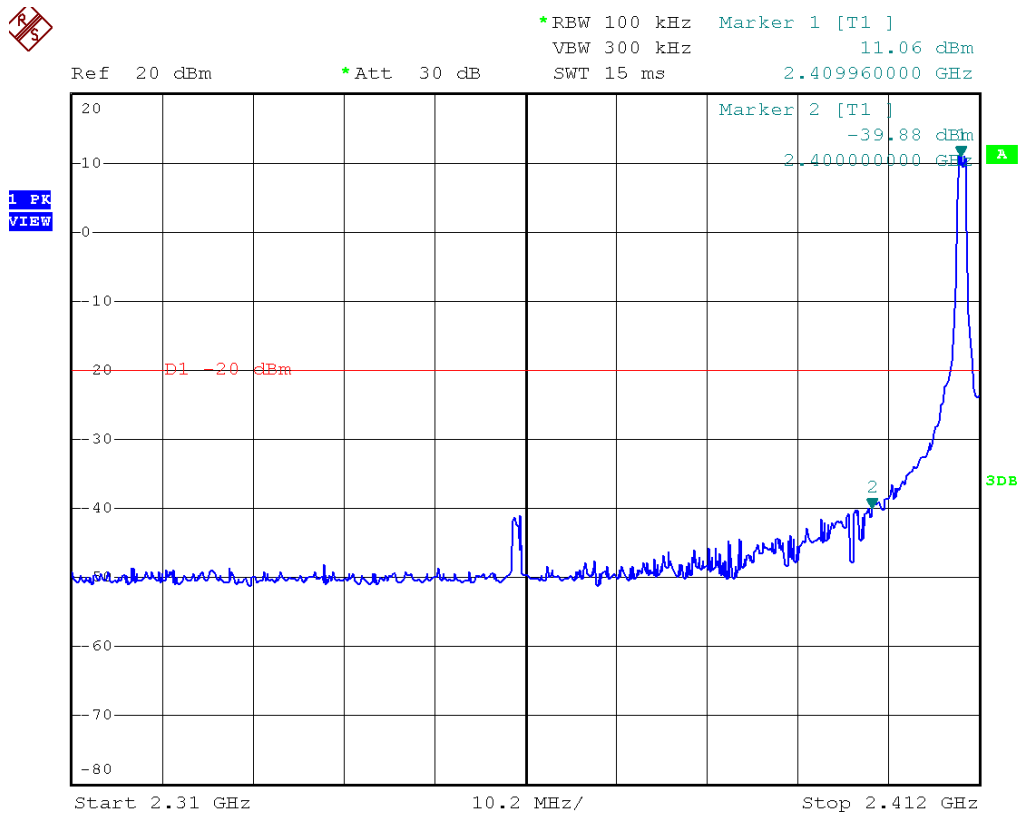

Figure 26: Band Edge – high frequency side without hopping

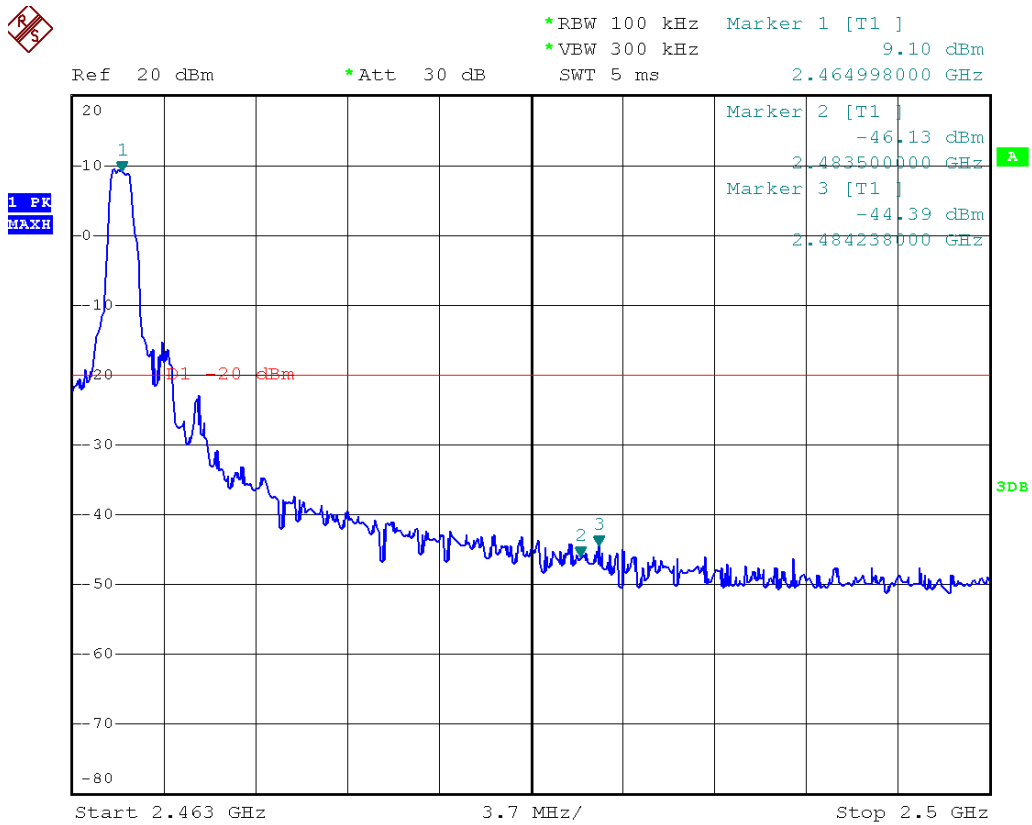

Figure 27 Conducted Spurious Emissions, low channel

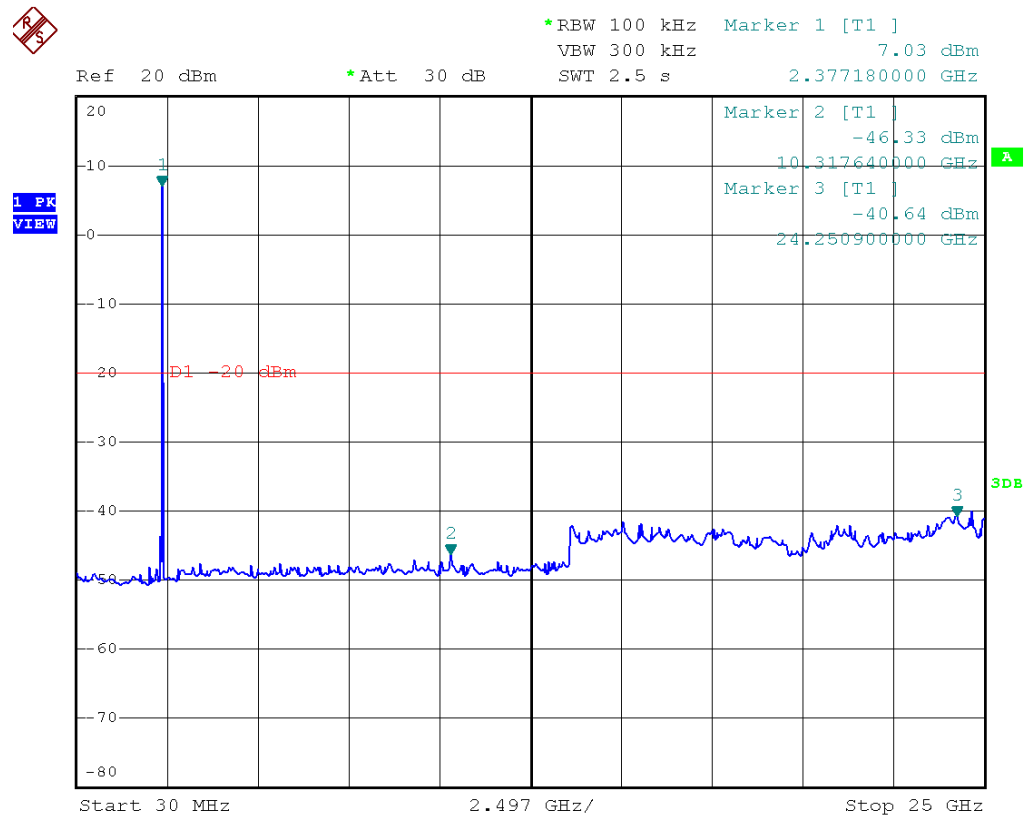

Figure 28 Conducted Spurious Emissions, middle channel

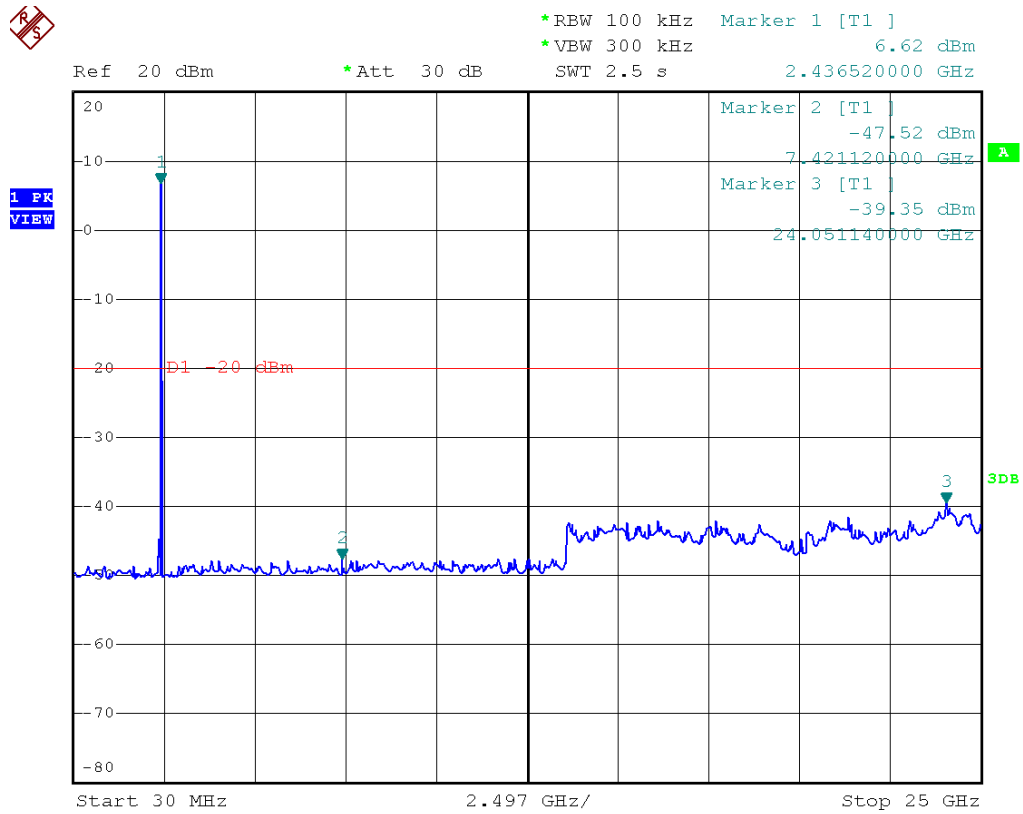
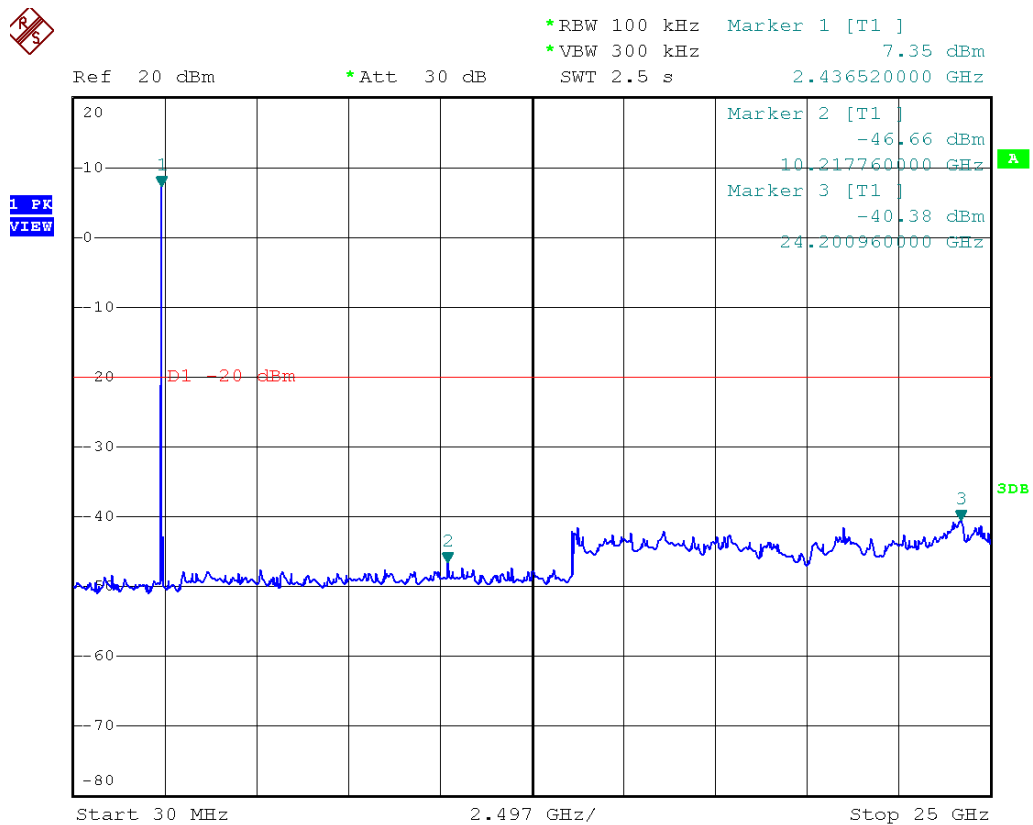

Figure 29 Conducted Spurious Emissions, high channel



6.6 Spurious Radiated Emission Measurement

Applicable Standard:

According to §15.247(c), all other emissions outside these bands shall not exceed the general radiated emission limits specified in §15.209(a). And according to §15.33(a)(1), for an intentional radiator operates below 10GHz, the frequency range of measurements: to the tenth harmonic of the highest fundamental frequency or to 40GHz, whichever is lower. And according to KDB558074 for FHSS-DSSS hybrid mode.

According to RSS-210 issue 8, §A8.5, in any 100 kHz bandwidth outside the frequency band in which the spread spectrum or digitally modulated device is operating, the radio frequency power that is produced shall be at least 20 dB below that in the 100 kHz bandwidth within the band that contains the highest level of the desired power, based on either an RF conducted or a radiated measurement, provided the transmitter demonstrates compliance with the peak conducted power limits. If the transmitter complies with the conducted power limits based on the use of RMS averaging over a time interval, as permitted under section A8.4(4), the attenuation required shall be 30 dB instead of 20 dB. Attenuation below the general limits specified in Tables 2 and 3 is not required. In addition, radiated emissions which falls in the restricted bands of Table 1 must also comply with the radiated emission limits specified in Tables 2 and 3.

Test Procedure:

1. The EUT was placed on a turn table which is 0.8m above ground plane.
2. The turn table shall rotate 360 degrees to determine the position of maximum emission level.
3. EUT is set 3m away from the receiving antenna which varied from 1m to 4m to find out the highest emissions.
4. Maximum procedure was performed on the six highest emissions to ensure EUT compliance.
5. And also, each emission was to be maximized by changing the polarization of receiving antenna both horizontal and vertical.
6. Repeat above procedures until all frequency measured were complete.

The field strength is calculated by adding the Antenna Factor and Cable Factor and subtracting the Amplifier Gain and Duty Cycle Correction Factor(if any) from the measured reading. The basic equation with a sample calculation is as follows:

$$FS = RA + AF + CL - AG$$

Where FS = Field Strength	CL = Cable Attenuation Factor (Cable Loss)
RA = Reading Amplitude	AG = Amplifier Gain
AF = Antenna Factor	

Test Configuration 9K-1 GHz:

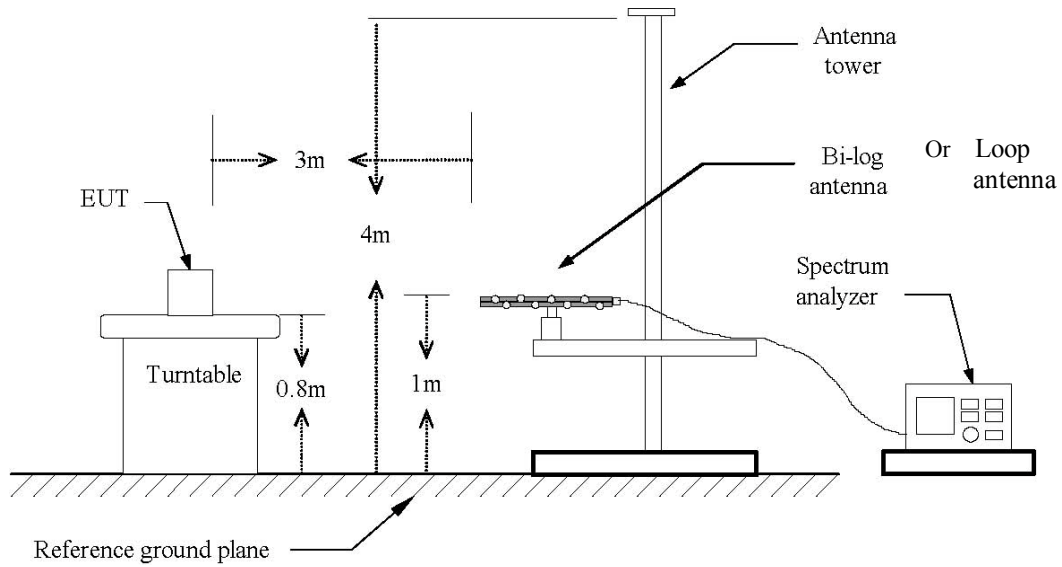

Test Configuration Above 1 GHz:

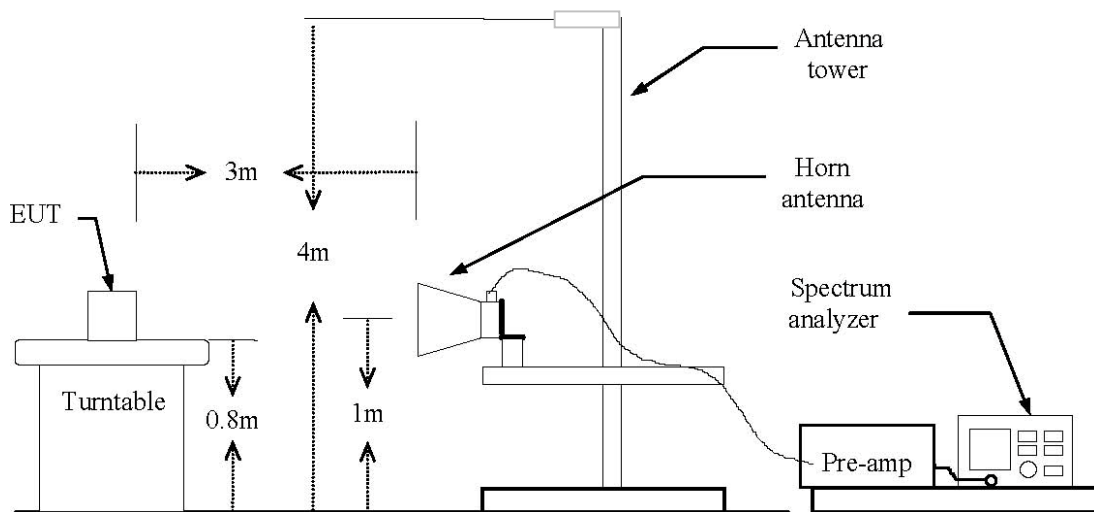

Test Results:

Temperature:	25°C
Humidity:	52%
EUT Operation:	FHSS without hopping and FHSS-DSSS hybrid mode
Test Date:	July 06, 2012

Spurious Emission In the Frequency Rang 9K-1GHz:

Pre-scan the EUT in FHSS and FHSS-DSSS hybrid modulation and find out the worst case is the FHSS-DSSS hybrid modulation mode in transmitting.

Fc= 2410MHz Transmitting Operation

Freq. (MHz)	Ant.Pol. (H/V)	Detector Mode (PK/QP)	Reading (dBuV)	Ant./CL/ Amp.CF (dB)	Actual FS (dBuV/m)	Limit 3m (dBuV/m)	Margin (dB)
36.80	H	QP	15.0	12.0	27.0	40.0	-13.0
278.96	H	QP	13.3	14.3	27.6	46.0	-18.4
954.16	H	QP	9.9	23.5	33.4	46.0	-12.6
36.72	V	QP	15.7	12.0	27.7	40.0	-12.3
154.48	V	QP	18.2	10.5	28.7	43.5	-14.8
954.16	V	QP	12.0	23.5	35.5	46.0	-10.5

Fc= 2437MHz Transmitting Operation

Freq. (MHz)	Ant.Pol. (H/V)	Detector Mode (PK/QP)	Reading (dBuV)	Ant./CL/ Amp.CF (dB)	Actual FS (dBuV/m)	Limit 3m (dBuV/m)	Margin (dB)
36.80	H	QP	15.2	12.0	27.2	40.0	-12.8
278.94	H	QP	14.2	14.3	28.5	46.0	-17.5
954.16	H	QP	7.8	23.5	31.3	46.0	-14.7
36.88	V	QP	16.2	12.0	28.2	40.0	-11.8
154.50	V	QP	17.6	10.5	28.1	43.5	-15.4
954.16	V	QP	11.7	23.5	35.2	46.0	-10.8

Fc= 2465MHz Transmitting Operation

Freq. (MHz)	Ant.Pol. (H/V)	Detector Mode (PK/QP)	Reading (dBuV)	Ant./CL/ Amp.CF (dB)	Actual FS (dBuV/m)	Limit 3m (dBuV/m)	Margin (dB)
36.80	H	QP	14.5	12.0	26.5	40.0	-13.5
277.24	H	QP	13.0	14.3	27.3	46.0	-18.7
954.16	H	QP	7.0	23.5	30.5	46.0	-15.5
36.64	V	QP	16.0	12.0	28.0	40.0	-12.0
154.72	V	QP	18.4	10.5	28.9	43.5	-14.6
954.16	V	QP	12.7	23.5	36.2	46.0	-9.8

Note: For spurious emission measurement, the compliance tests were performed both of horizontally placed and vertically placed in EUT (X position, Y position, Z position). As a result, the data of operation mode that produce the maximum emission were reported. The other emissions are more than 25dB below the limit.

Spurious Emission In the Frequency Rang above 1GHz:

Pre-scan the EUT in FHSS and FHSS-DSSS hybrid modulation and find out the worst case is the FHSS-DSSS hybrid modulation mode in transmitting.

Fc= 2410MHz Transmitting Operation- Horizontal

Freq. (MHz)	Peak Reading (dBuV)	AV Reading (dBuV)	Ant./CL/ Amp.CF (dB)	Actual FS		Peak Limit (dBuV/m)	AV Limit (dBuV/m)	Margin
				Peak (dBuV/m)	AV (dBuV/m)			
4820.00	43.02	29.16	1.20	44.22	30.36	74.00	54.00	-23.64
7230.00	45.12	30.45	4.22	49.34	34.67	74.00	54.00	-19.33
9642.00	41.38	29.02	7.70	49.08	36.72	74.00	54.00	-17.28
-								

Fc= 2410MHz Transmitting Operation- Vertical

Freq. (MHz)	Peak Reading (dBuV)	AV Reading (dBuV)	Ant./CL/ Amp.CF (dB)	Actual FS		Peak Limit (dBuV/m)	AV Limit (dBuV/m)	Margin
				Peak (dBuV/m)	AV (dBuV/m)			
4820.00	44.82	28.24	1.20	46.02	29.44	74.00	54.00	-24.56
7230.00	48.16	29.39	4.22	52.38	33.61	74.00	54.00	-20.39
9642.00	41.38	28.24	7.70	49.08	35.94	74.00	54.00	-18.06
-								

Note: Data of measurement within this frequency range shown “— ” in the table above means the reading of emissions are attenuated more than 25dB below the permissible limits or the field strength is too small to be measured.

Fc= 2437MHz Transmitting Operation- Horizontal

Freq. (MHz)	Peak Reading (dBuV)	AV Reading (dBuV)	Ant./CL/ Amp.CF (dB)	Actual FS		Peak Limit (dBuV/m)	AV Limit (dBuV/m)	Margin
				Peak (dBuV/m)	AV (dBuV/m)			
4876.00	44.26	29.02	1.20	45.46	30.22	74.00	54.00	-23.78
7311.00	45.78	30.04	4.22	50.00	34.26	74.00	54.00	-19.74
9742.00	41.47	29.14	7.71	49.18	36.85	74.00	54.00	-17.15
-								

Fc= 2437MHz Transmitting Operation- Vertical

Freq. (MHz)	Peak Reading (dBuV)	AV Reading (dBuV)	Ant./CL/ Amp.CF (dB)	Actual FS		Peak Limit (dBuV/m)	AV Limit (dBuV/m)	Margin
				Peak (dBuV/m)	AV (dBuV/m)			
4874.00	43.26	29.24	1.20	44.46	30.44	74.00	54.00	-23.56
7311.00	47.93	30.11	4.22	52.15	34.33	74.00	54.00	-19.67
9738.00	40.08	28.74	7.71	47.78	36.45	74.00	54.00	-17.55
-								

Note: Data of measurement within this frequency range shown “— ” in the table above means the reading of emissions are attenuated more than 25dB below the permissible limits or the field strength is too small to be measured.

Fc= 2465MHz Transmitting Operation- Horizontal

Freq. (MHz)	Peak Reading (dBuV)	AV Reading (dBuV)	Ant./CL/ Amp.CF (dB)	Actual FS		Peak Limit (dBuV/m)	AV Limit (dBuV/m)	Margin
				Peak (dBuV/m)	AV (dBuV/m)			
4932.00	42.16	28.53	1.20	43.36	29.73	74.00	54.00	-24.27
7395.00	44.69	29.86	4.22	48.91	34.08	74.00	54.00	-19.92
9860.00	41.28	28.43	7.80	49.08	36.23	74.00	54.00	-17.77
-								

Fc= 2465MHz Transmitting Operation- Vertical

Freq. (MHz)	Peak Reading (dBuV)	AV Reading (dBuV)	Ant./CL/ Amp.CF (dB)	Actual FS		Peak Limit (dBuV/m)	AV Limit (dBuV/m)	Margin
				Peak (dBuV/m)	AV (dBuV/m)			
4930.00	47.22	28.76	1.20	48.42	29.96	74.00	54.00	-24.04
7386.00	47.36	30.24	4.22	51.58	34.46	74.00	54.00	-19.54
9847.00	40.27	28.82	7.80	48.07	36.62	74.00	54.00	-17.38
-								

Note: Data of measurement within this frequency range shown “— ” in the table above means the reading of emissions are attenuated more than 25dB below the permissible limits or the field strength is too small to be measured.

6.7 Band Edge and Restricted Band of Radiated Emission Measurement

Applicable Standard:

According to §15.247(d), radiated emissions which fall in the restricted bands, as defined in §15.205(a), must also comply with the radiated emission limits specified in 15.209(a).

According to RSS-210 issue 8, §A8.5, radiated emissions which fall in the restricted bands of Table 1 must also comply with the radiated emission limits specified in Tables 2 and 3.

According to DA 00-705, in making radiated band-edge measurements, the following technique for determining band-edge compliance.

STEP 1) Perform an in-band field strength measurement of the fundamental emission using the RBW and detector function required by C63.4 and our Rules for the frequency being measured. For transmitters operating above 1 GHz, use a 1 MHz RBW, a 1 MHz VBW, and a peak detector (as required by Section 15.35). Repeat the measurement with an average detector (i.e., 1 MHz RBW with 10 Hz VBW).

STEP 2) Choose a spectrum analyzer span that encompasses both the peak of the fundamental emission and the band-edge emission under investigation. Set the analyzer RBW to 1% of the total span (but never less than 30 kHz) with a video bandwidth equal to or greater than the RBW. Record the peak levels of the fundamental emission and the relevant band-edge emission (i.e., run several sweeps in peak hold mode). Observe the stored trace and measure the amplitude delta between the peak of the fundamental and the peak of the band-edge emission. This is not a field strength measurement, it is only a relative measurement to determine the amount by which the emission drops at the band-edge relative to the highest fundamental emission level.

STEP 3) Subtract the delta measured in step (2) from the field strengths measured in step (1). The resultant field strengths (CISPR QP, average, or peak, as appropriate) are then used to determine band-edge compliance as required by Section 15.205.

STEP 4) The above "delta" measurement technique may be used for measuring emissions that are up to two "standard" bandwidths away from the band-edge, where a "standard" bandwidth is the bandwidth specified by C63.4 for the frequency being measured.

Test Procedure:

1. The EUT was placed on a turn table which is 0.8m above ground plane.
2. The turn table shall rotate 360 degrees to determine the position of maximum emission level.
3. EUT is set 3m away from the receiving antenna which varied from 1m to 4m to find out the highest emissions.
4. Maximum procedure was performed on the highest emissions in restricted band to ensure EUT compliance.

The field strength is calculated by adding the Antenna Factor and Cable Factor and subtracting the Amplifier Gain and Duty Cycle Correction Factor(if any) from the measured reading. The basic equation with a sample calculation is as follows:

$$FS = RA + AF + CL - AG$$

Where FS = Field Strength	CL = Cable Attenuation Factor (Cable Loss)
RA = Reading Amplitude	AG = Amplifier Gain
AF = Antenna Factor	

Test Results:

Temperature:	24°C
Humidity:	53%
EUT Operation:	FHSS modulation without hopping
Test Date:	July 06, 2012

Pre-scan the EUT in FHSS and FHSS-DSSS hybrid modulation and find out the worst case is FHSS modulation without hopping mode in transmitting.

The unit does meet the requirements.

The FHSS modulation without hopping mode test plots shown in figures 30, 31, 32, 33, 34, 35, 36, 37 on pages 39, 40, 41, 42.

Figure 30 Band Edge of Radiated Emission – low frequency side without hopping
Peak measurement in horizontal polarization

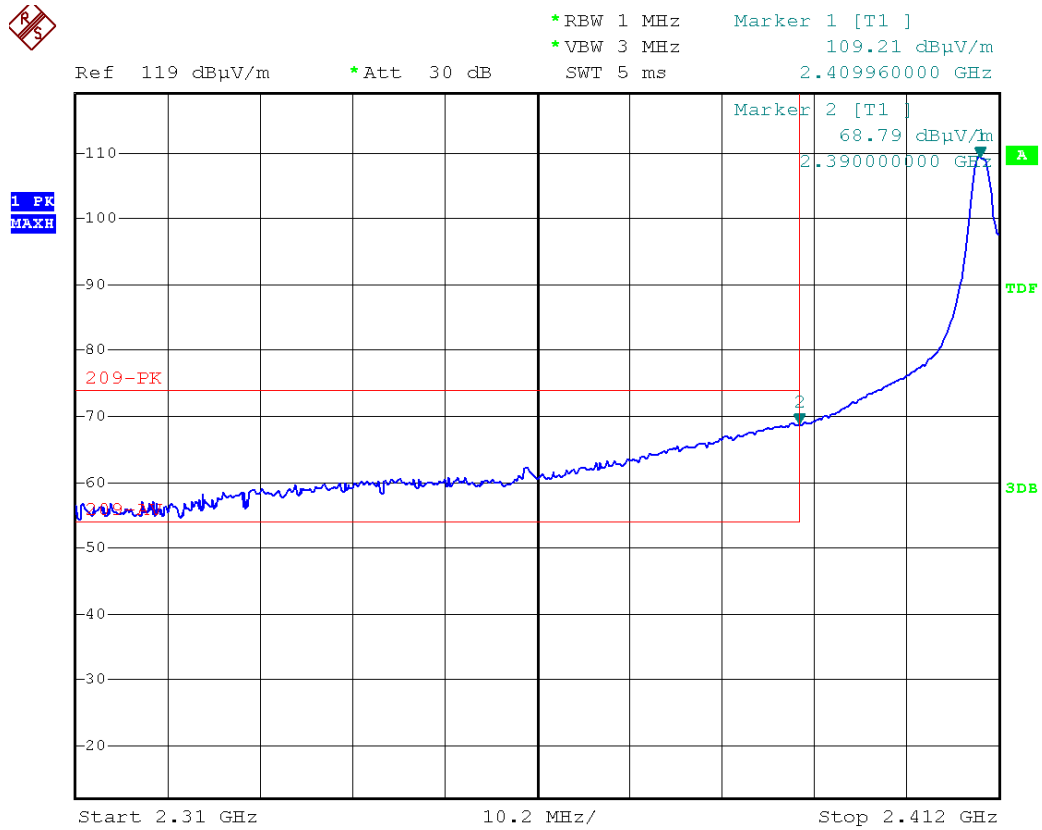

Figure 31 Band Edge of Radiated Emission – low frequency side without hopping
Average measurement in horizontal polarization

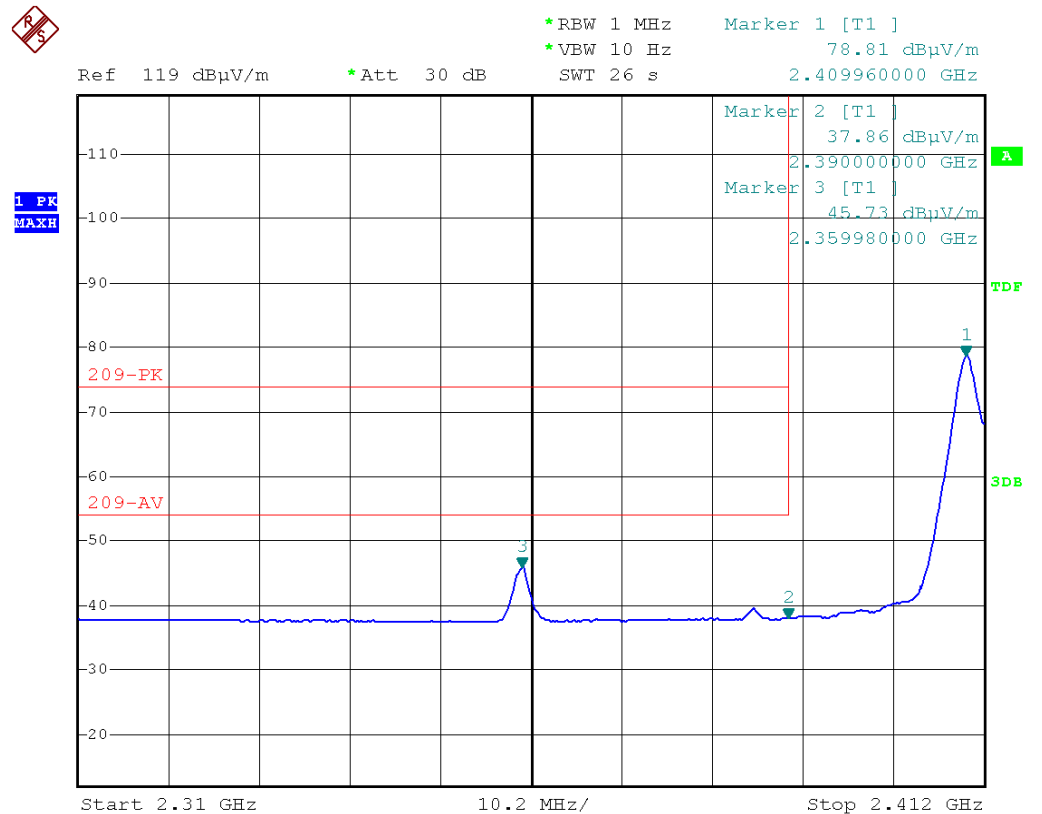

Figure 32 Band Edge of Radiated Emission – low frequency side without hopping
Peak measurement in vertical polarization

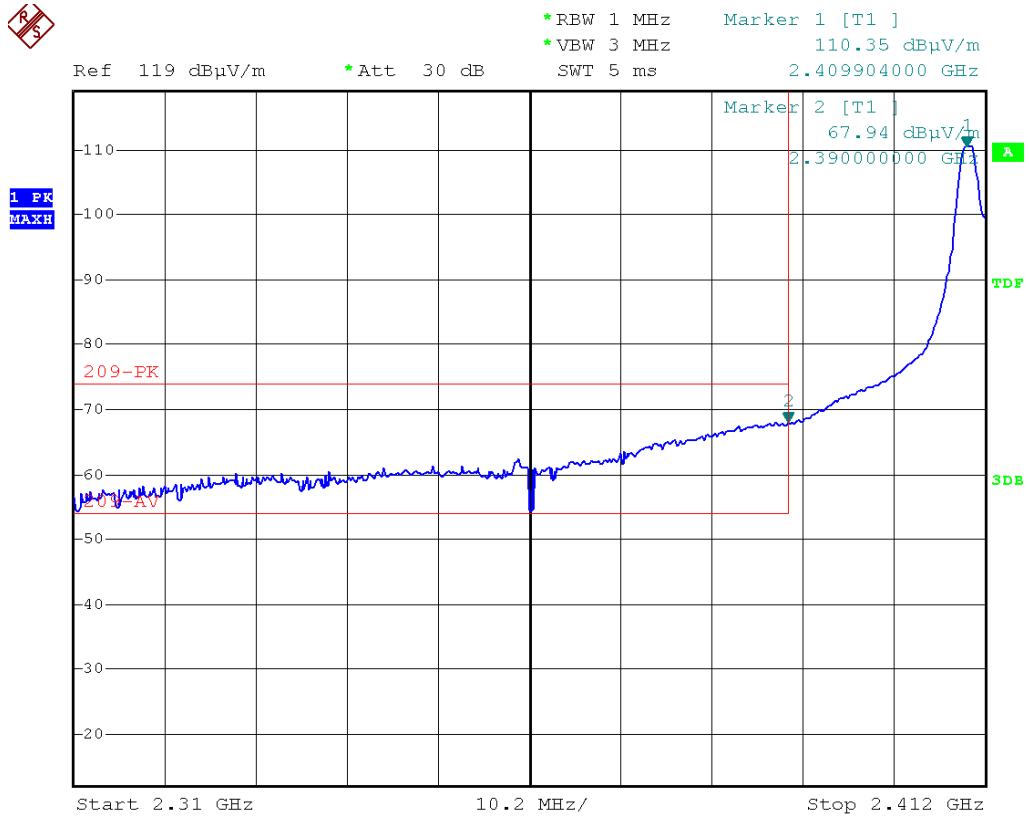

Figure 33 Band Edge of Radiated Emission – low frequency side without hopping
Average measurement in vertical polarization

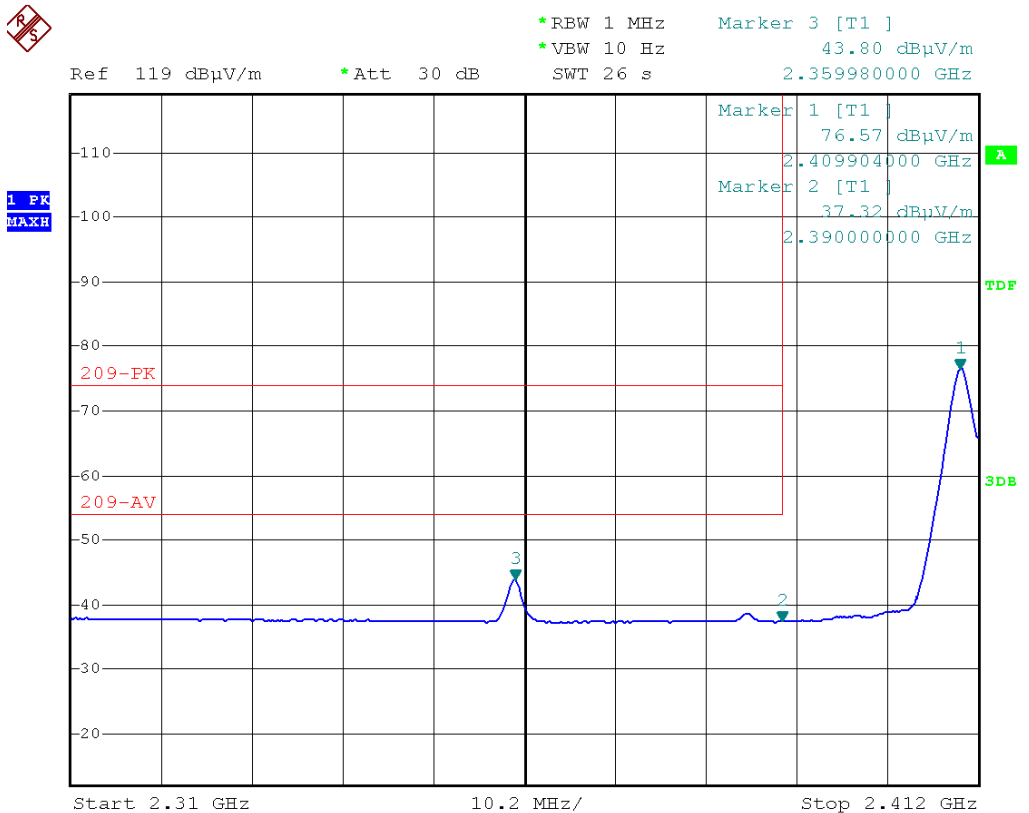

Figure 34 Band Edge of Radiated Emission – high frequency side without hopping
Peak measurement in horizontal polarization

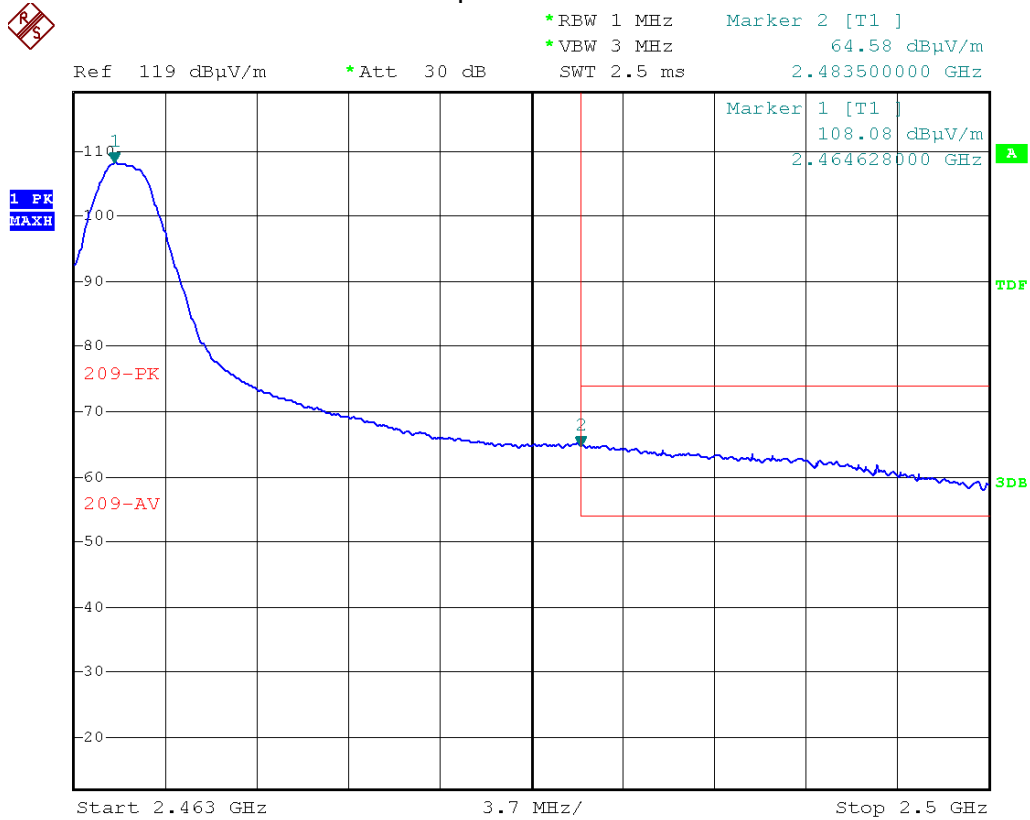

Figure 35 Band Edge of Radiated Emission – high frequency side without hopping
Average measurement in horizontal polarization

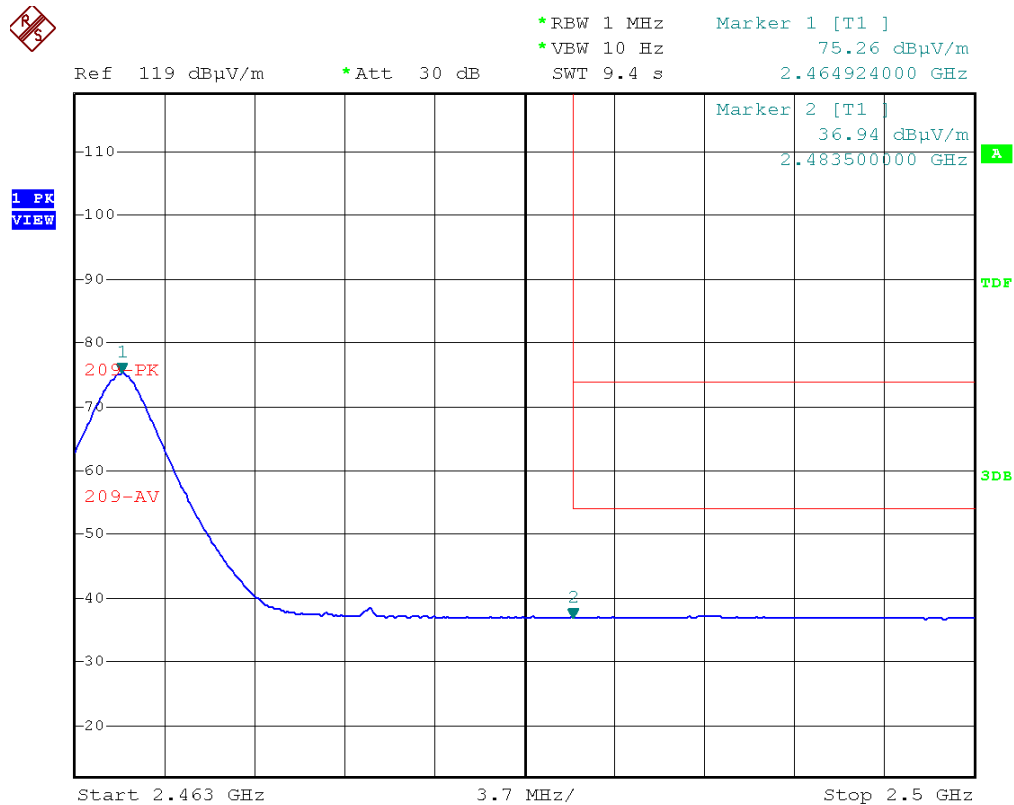

Figure 36 Band Edge of Radiated Emission – high frequency side without hopping
Peak measurement in vertical polarization

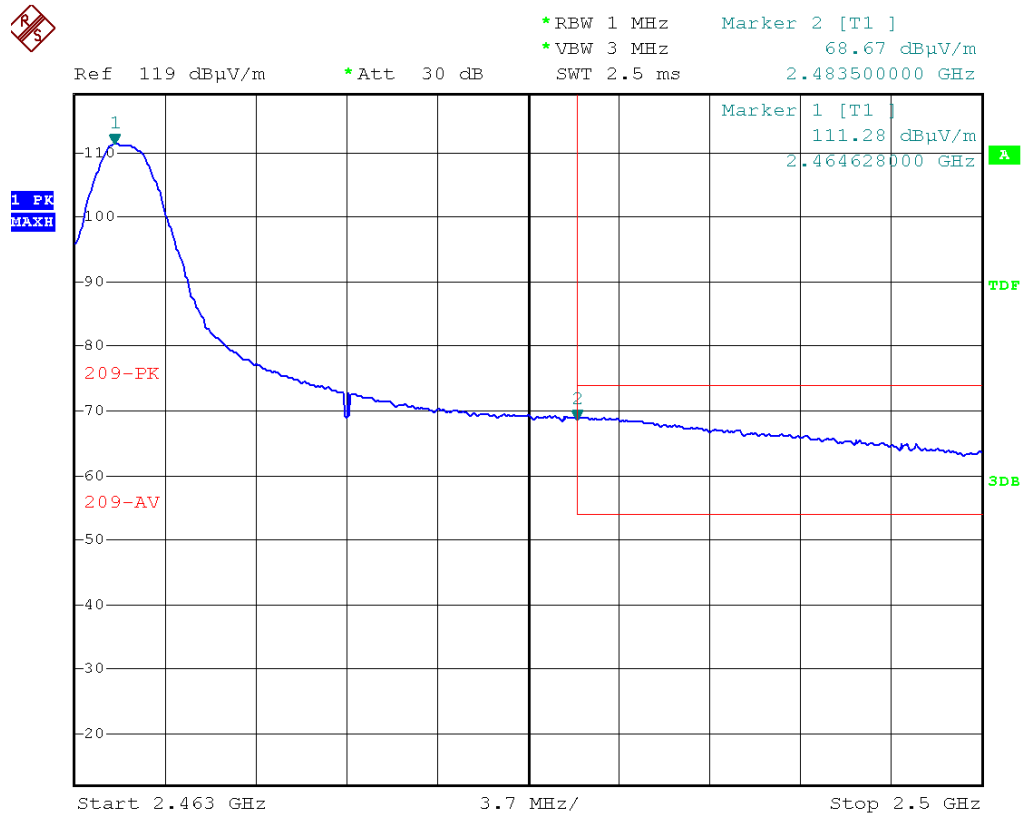
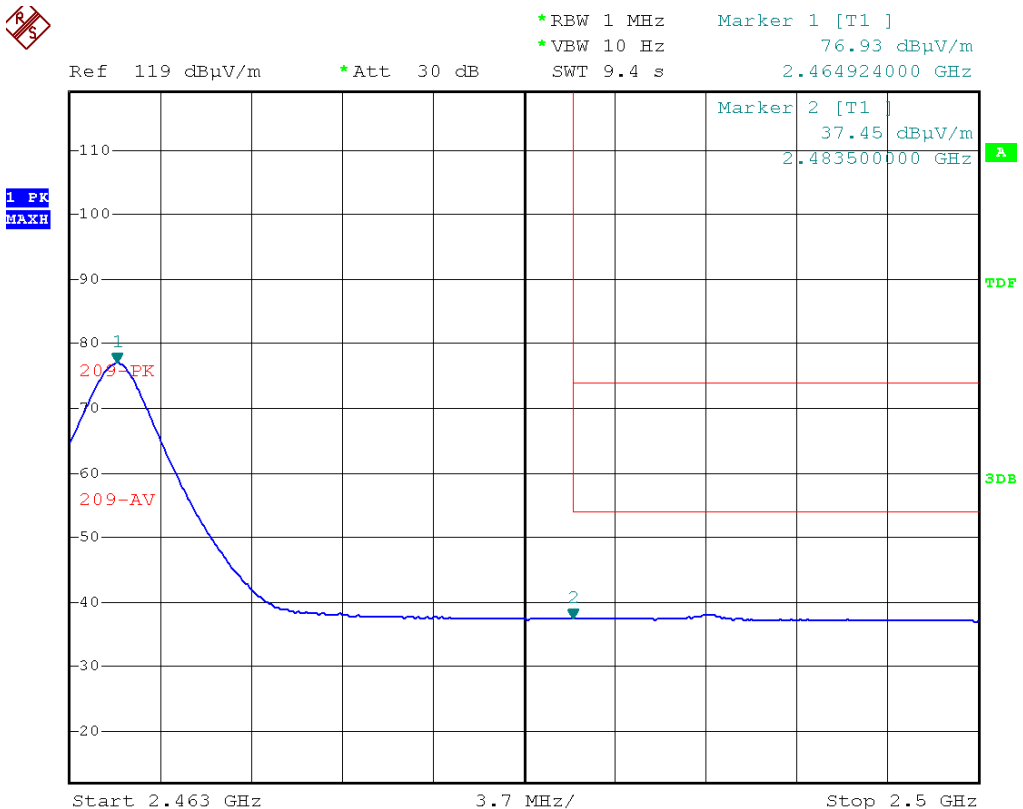

Figure 37 Band Edge of Radiated Emission – high frequency side without hopping
Average measurement in vertical polarization



6.8 99% Bandwidth Measurement

Standard Applicable:

RSS-Gen §4.4.1, the transmitter shall be operated at its maximum carrier power measured under normal test conditions. The span of the analyzer shall be set to capture all products of the modulation process, including the emission skirts. The resolution bandwidth shall be set to as close to 1% of the selected span as is possible without being below 1%. The video bandwidth shall be set to 3 times the resolution bandwidth. Video averaging is not permitted. Where practical, a sampling detector shall be used since a peak or, peak hold, may produce a wider bandwidth than actual.

The trace data points are recovered and are directly summed in linear terms. The recovered amplitude data points, beginning at the lowest frequency, are placed in a running sum until 0.5% of the total is reached and that frequency recorded. The process is repeated for the highest frequency data points. This frequency is recorded. The span between the two recorded frequencies is the occupied bandwidth.

Test Procedure:

Use the following spectrum analyzer settings:

Span = 3MHz

Resolution Bandwidth = 100KHz

Video Bandwidth = 300KHz

Sweep = auto

Detector function = peak

Trace = max hold

Test Results:

Temperature:	25°C
Humidity:	54%
EUT Operation:	FHSS without hopping and FHSS-DSSS hybrid mode
Test Date:	July 06, 2012

Type of modulation: FHSS	
Frequency (MHz)	99% Bandwidth (MHz)
2410	1.140
2437	1.210
2465	1.350

Note: Test plots shown in figures 38, 39, 40 on pages 45, 46.

Type of modulation: FHSS-DSSS hybrid	
Frequency (MHz)	99% Bandwidth (MHz)
2410	1.160
2437	1.240
2465	1.260

Note: Test plots shown in figures 41, 42, 43 on pages 46, 47.

Figure 38- 99% Bandwidth Measurement (fc=2410MHz)

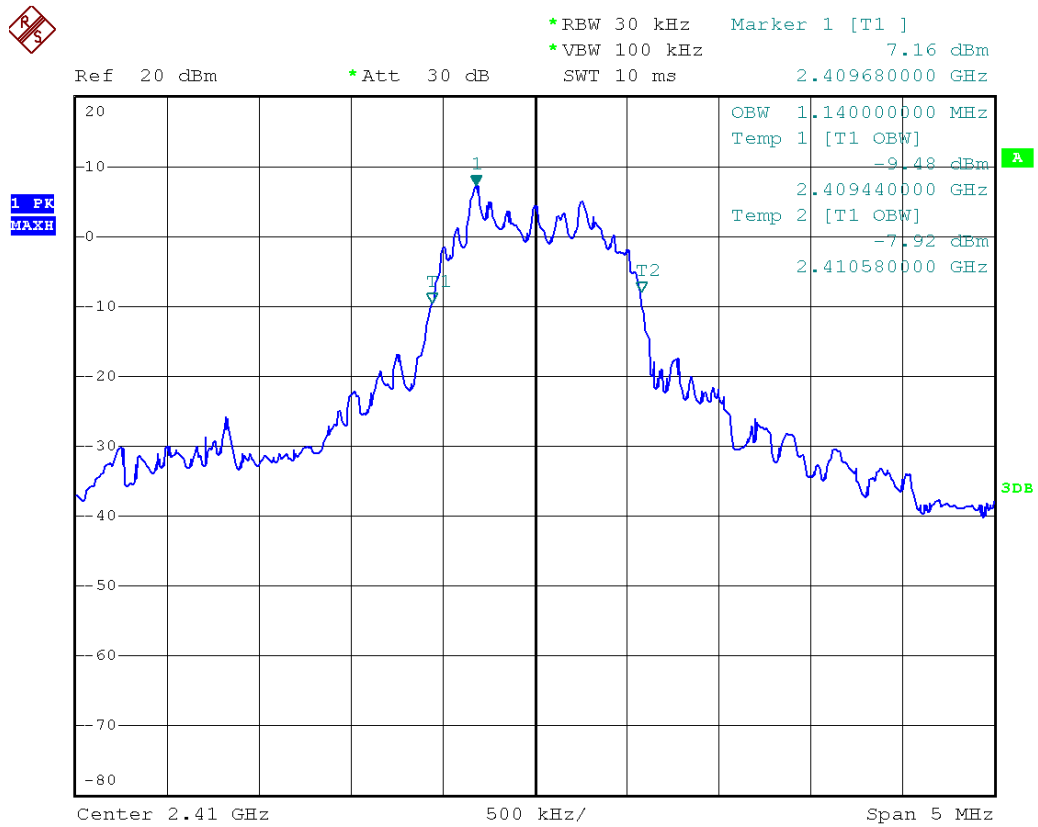

Figure 39- 99% Bandwidth Measurement (fc=2437MHz)

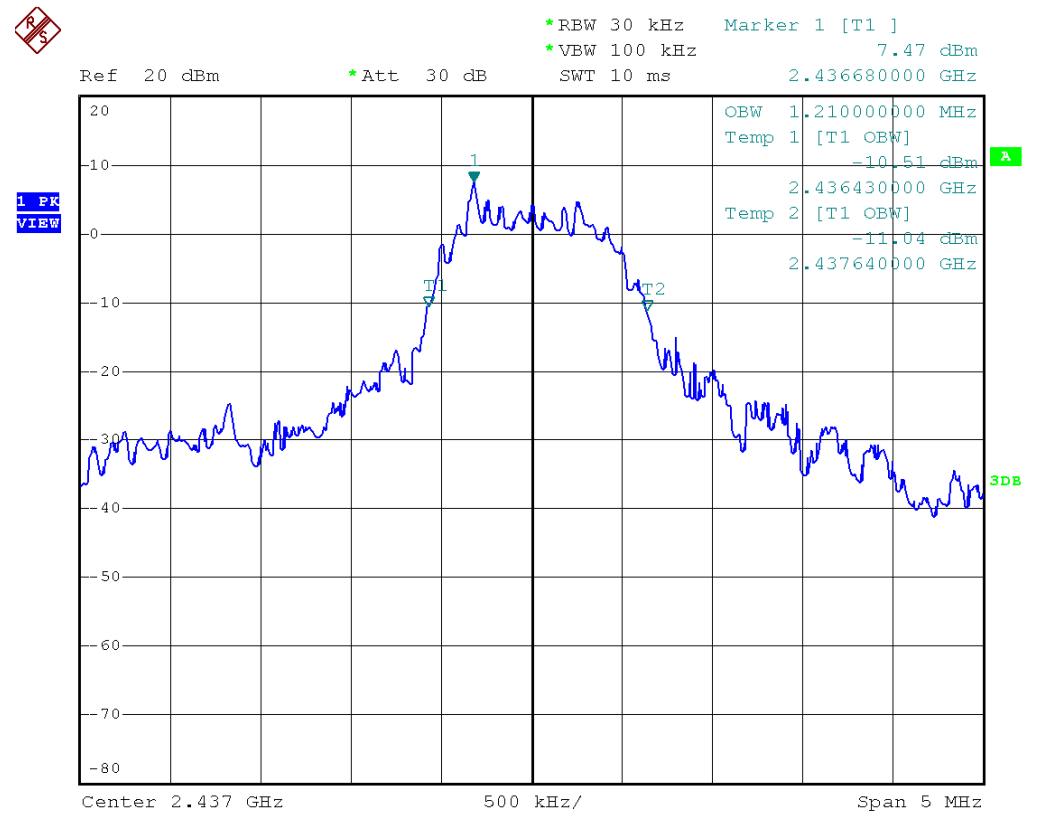

Figure 40- 99% Bandwidth Measurement (fc=2465MHz)



Figure 41- 99% Bandwidth Measurement (fc=2410MHz)

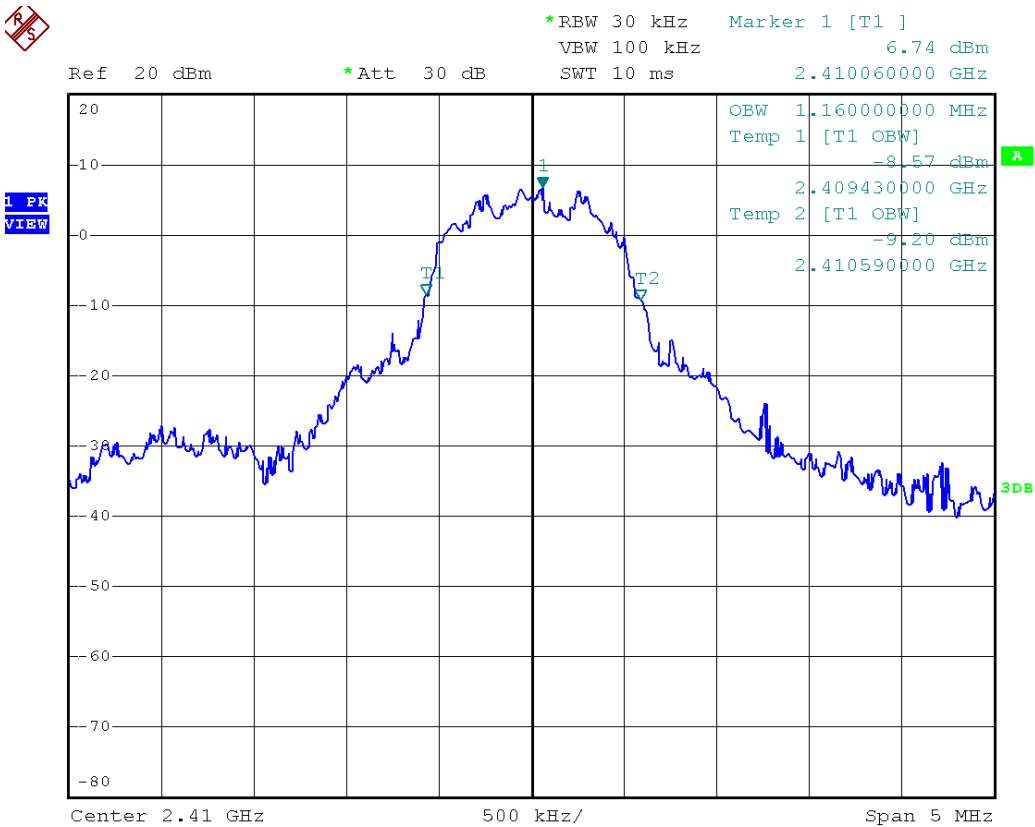

Figure 42- 99% Bandwidth Measurement (fc=2437MHz)

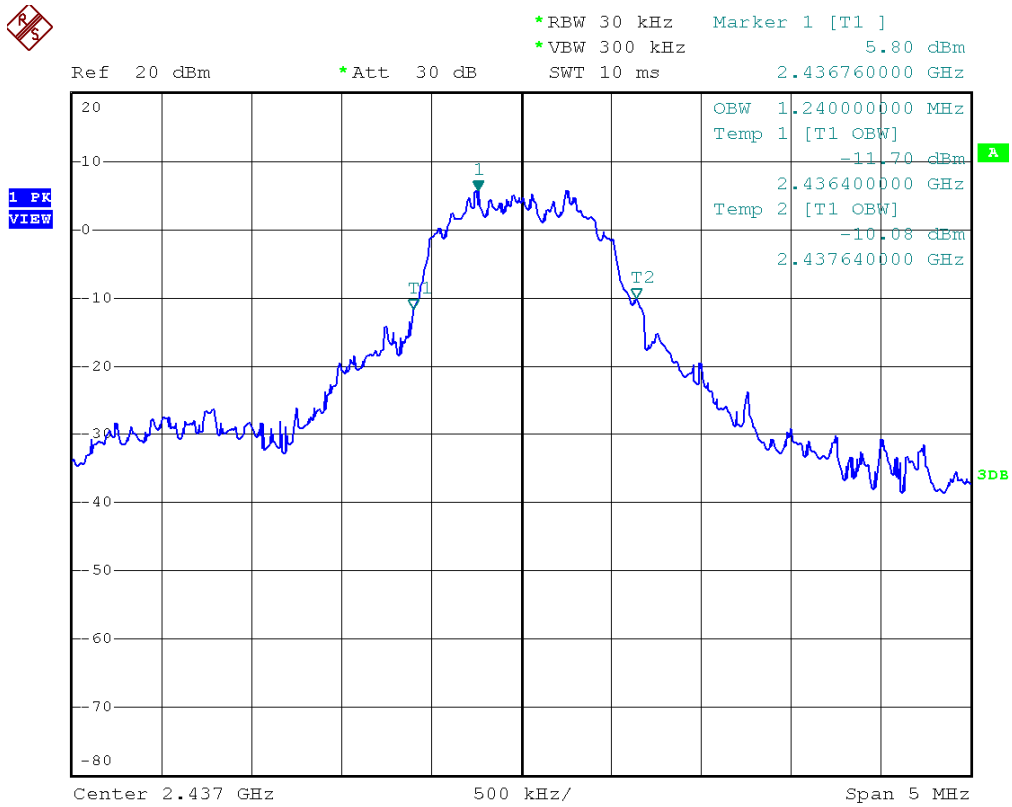
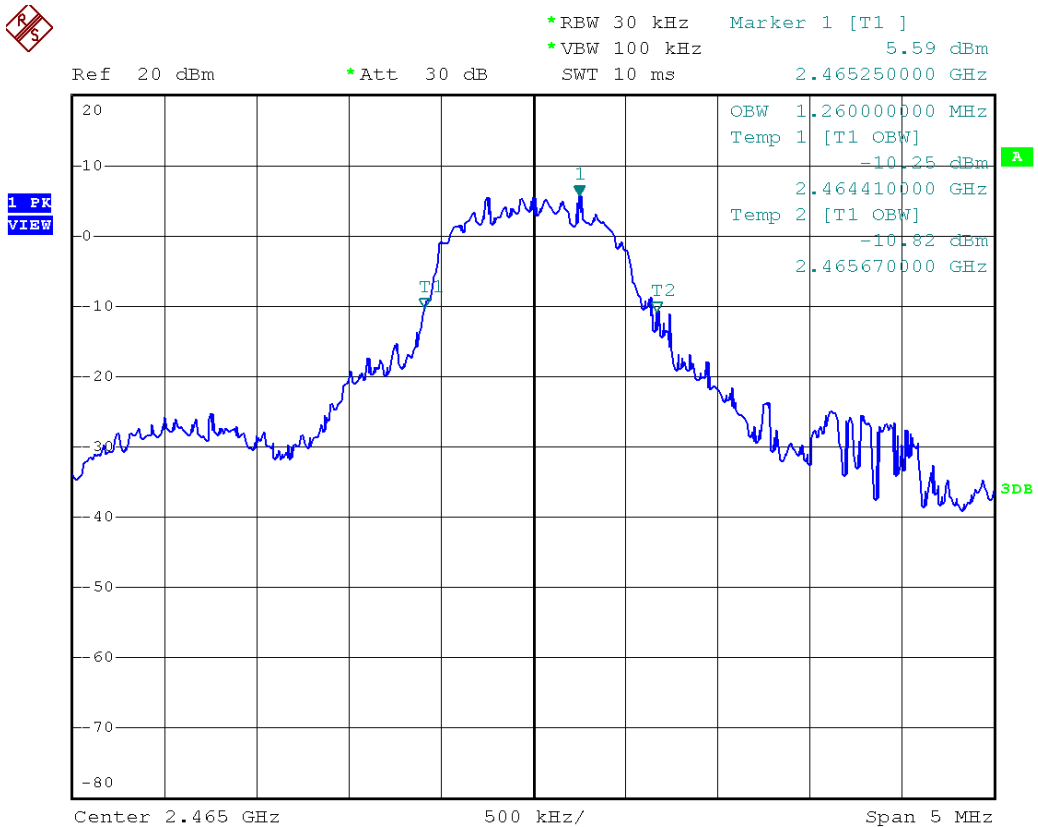

Figure 43- 99% Bandwidth Measurement (fc=2465MHz)



6.9 Power Spectral Density Measurement

Standard Applicable:

According to §15.247 (d) and KDB558074 for digitally modulated systems, the power spectral density conducted from the intentional radiator to the antenna shall not be greater than 8 dBm in any 3 kHz band during any time interval of continuous transmission.

RSS-210 According to RSS-210 issue 8, §A8.2, (b) The transmitter power spectral density conducted from the transmitter to the antenna shall not be greater than 8 dBm in any 3 kHz band during any time interval of continuous transmission or over 1.0 second if the transmission exceeds 1.0-second duration. .

Test Procedure:

Use the following spectrum analyzer settings:

Span = 300kHz

Resolution Bandwidth = 3KHz

Video Bandwidth = 10KHz

Sweep Times= 100s

Detector function = peak

Trace = max hold

Test Results:

Temperature:	23°C
Humidity:	53%
EUT Operation:	FHSS-DSSS hybrid modulation in transmitting
Test Date:	July 10, 2012

Antenna Port 1#					
Frequency	Factor	Reading	Power	Limit	Margin
[MHz]	[dB]	[dBm]	[dBm]	[dBm]	[dB]
2410	1.0	-1.77	-0.77	8.00	-8.77
2437	1.0	-2.57	-1.57	8.00	-9.57
2465	1.0	-3.35	-2.35	8.00	-10.35

Note: Test plots shown in figures 44, 45, 46 on pages 50, 51.

Antenna Port 2#					
Frequency	Factor	Reading	Power	Limit	Margin
[MHz]	[dB]	[dBm]	[dBm]	[dBm]	[dB]
2410	1.0	-1.60	-0.60	8.00	-8.60
2437	1.0	-2.26	-1.26	8.00	-9.26
2465	1.0	-3.40	-2.40	8.00	-10.40

Note: Test plots shown in figures 47, 48, 49 on pages 51, 52.

The unit does meet the requirements.

Figure 44 Power Spectral Density Measurement (fc=2410MHz)

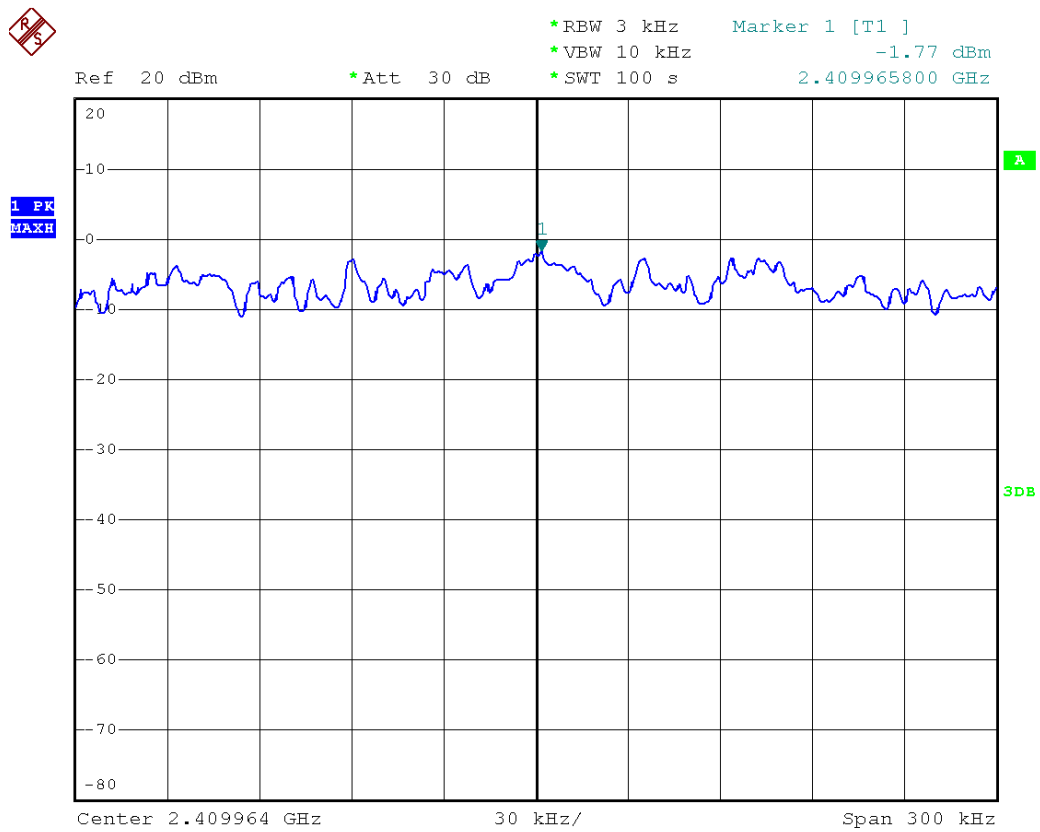

Figure 45 Power Spectral Density Measurement (fc=2437MHz)

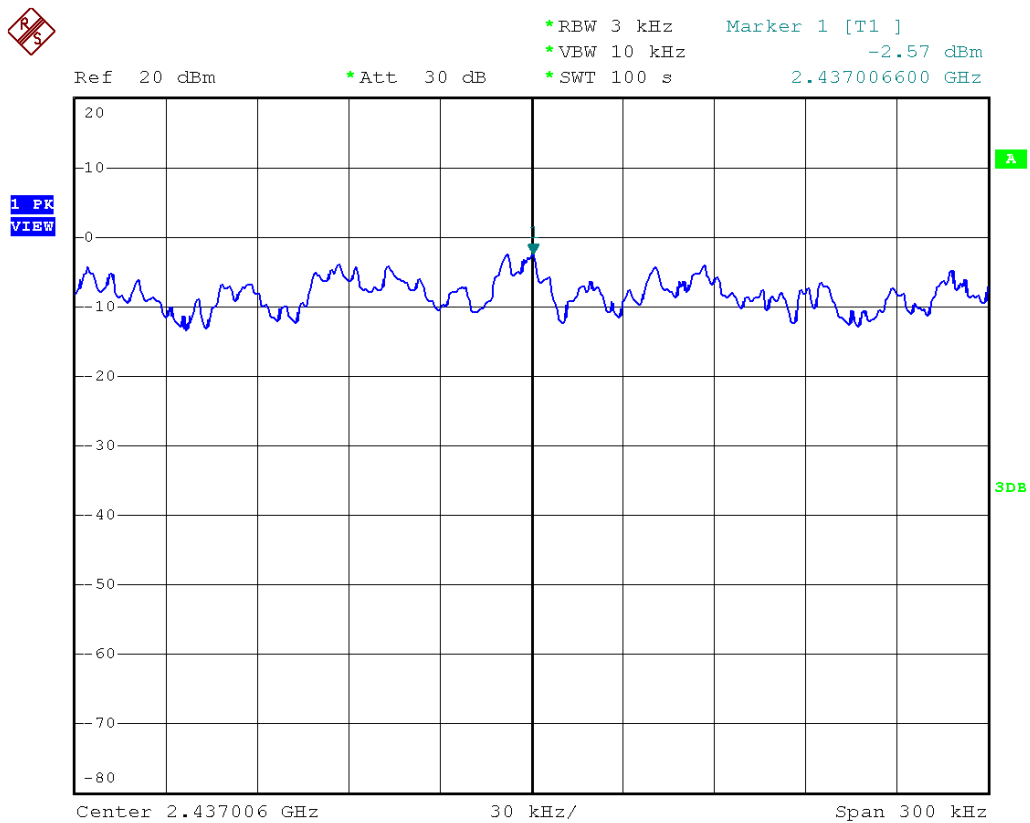

Figure 46 Power Spectral Density Measurement (fc=2465MHz)

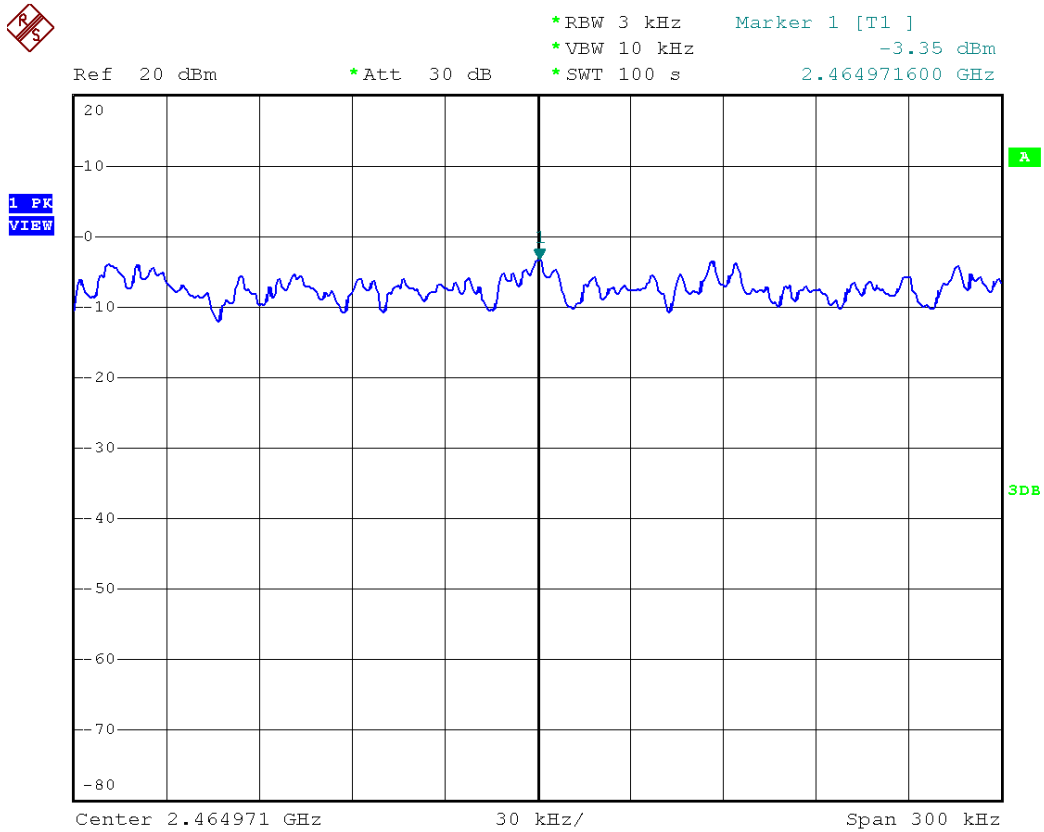

Figure 47 Power Spectral Density Measurement (fc=2410MHz)

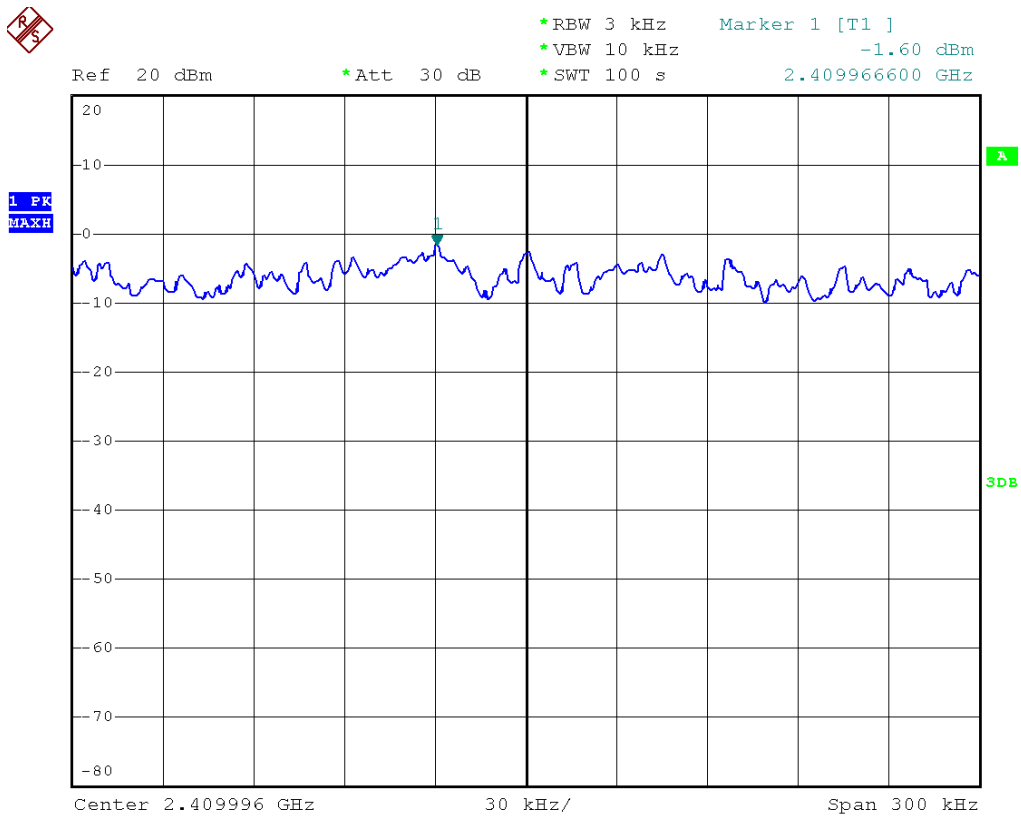

Figure 48 Power Spectral Density Measurement (fc=2437MHz)

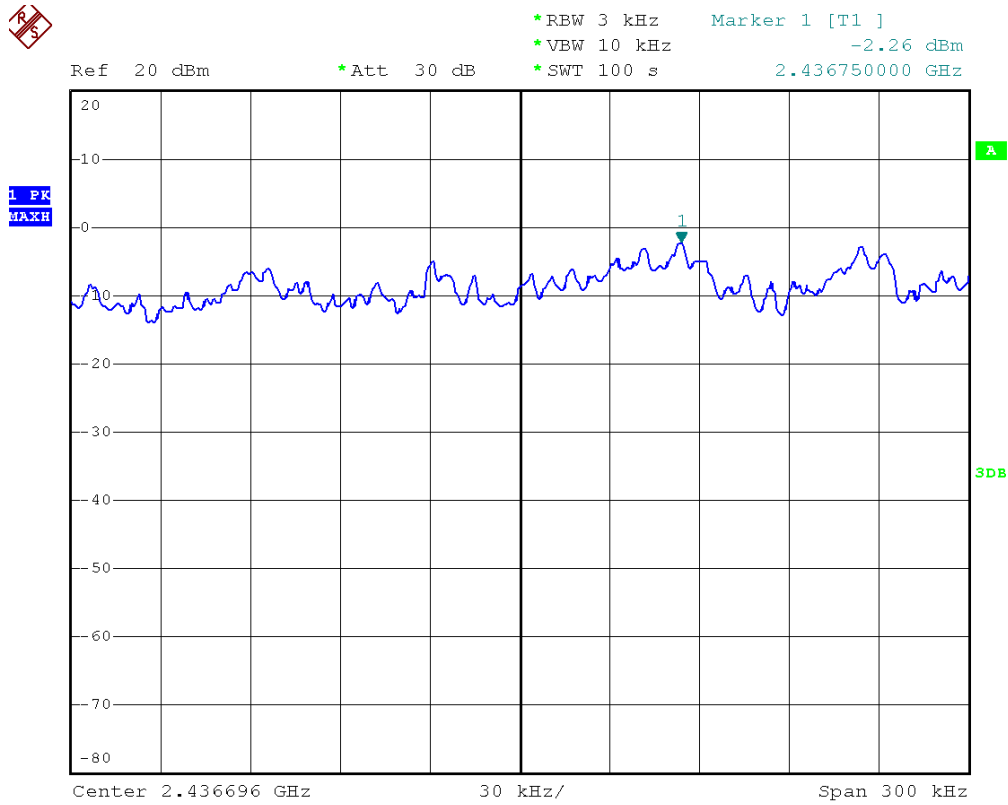
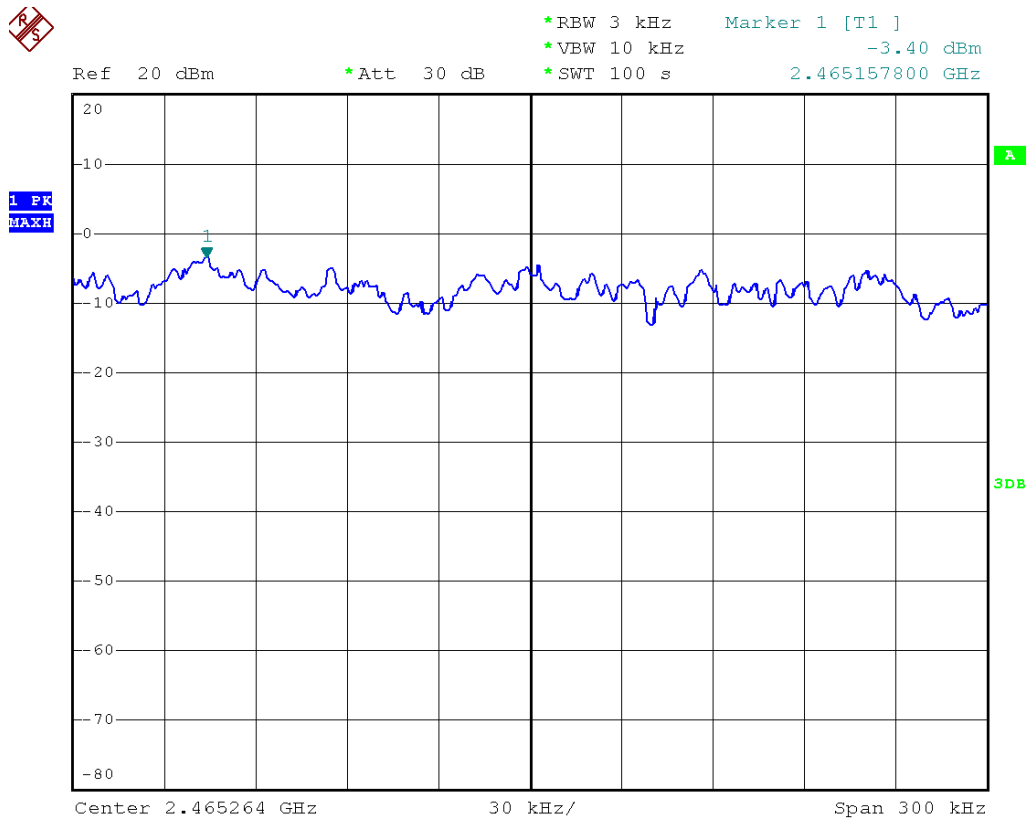

Figure 49 Power Spectral Density Measurement (fc=2465MHz)



6.10 RF Exposure

Standard Applicable

According to 1.1307 (b)(1), systems operating under the provisions of this section shall be operated in a manner that ensure that the public is not exposed to radio frequency energy level in excess of the Commission's guideline.

This is a portable device.

Measurement Result:

This is a portable device and the max peak output power is 13.55dBm = (22.65mW), lower than low threshold 60/f GHz mW = (24.90mW), d <2.5 cm general population category.

The SAR/MPE measurement is not necessary.

6.11 Antenna Requirement

Standard Applicable

According to §15.203, an intentional radiator shall be designed to ensure that no antenna other than furnished by the responsible party shall be used with the device. And according to §15.246(1), if transmitting antennas of directional gain greater than 6dBi are used the power shall be reduced by the amount in dB that the directional gain of the antenna exceeds 6 dBi.

According to RSS-GEN 7.1.4, a transmitter can only be sold or operated with antennas with which it was certified. A transmitter may be certified with multiple antenna types. An antenna type comprises antennas having similar in-band and out-of-band radiation patterns. Testing shall be performed using the highest-gain antenna of each combination of transmitter and antenna type for which certification is being sought, with the transmitter output power set at the maximum level. Any antenna of the same type and having equal or lesser gain as an antenna that had been successfully tested for certification with the transmitter, will also be considered certified with the transmitter, and may be used and marketed with the transmitter. The manufacturer shall include with the application for certification a list of acceptable antenna types to be used with the transmitter.

Antenna Construction:

The directional gins of antenna used for transmitting is 1.3~1.5 dBi, and the antenna connector is designed with permanent attachment and no consideration of replacement. Please see EUT photo for details.

The unit does meet the requirement.