

FCC Part 15 Subpart C Requirement  
and Industry Canada RSS-210  
Measurement and Test Report

For

**Sanwa Electronic Instrument Co., Ltd**

1-2-50, Yoshida Honmachi, Higashi-Osaka, Osaka 578-0982, Japan

**FCC ID: L73-90480**  
**IC: 7377A-90480**

February 24, 2009

<b>This Report Concerns:</b> <input checked="" type="checkbox"/> Original Report	<b>Equipment Type:</b> 2.4GHz Radio Control System
<b>Test Engineer:</b>	Bossc0 He
<b>Report Number:</b>	SE09B-020FI
<b>Test Date:</b>	February 19-21, 2009
<b>Reviewed By:</b>	<i>Souis</i>
<b>Prepared By:</b>	S&E Technologies Laboratory Ltd Room 407, Block A Shennan Garden, Hi-Tech Industrial Park, Shenzhen 518057, P.R. China. Tel: 86-755-26636573, 26630631 Fax: 86-755-26630557

**Note:** This test report is limited to the above client company and the product model only. It may not be duplicated without prior written consent of S&E Technologies Laboratory Ltd.

## Table of Contents

<b>1-TEST RESULT CERTIFICATION.....</b>	<b>3</b>
<b>2- EUT DESCRIPTION.....</b>	<b>4</b>
<b>3-TEST SYSTEM .....</b>	<b>5</b>
3.1 TEST MODE .....	5
3.2 TEST SETUP DIAGRAM.....	5
3.3 BLOCK DIAGRAM OF EUT SYSTEM .....	6
3.4 LIST OF CABLES .....	6
<b>4- TEST EQUIPMENT AND CALIBRATION .....</b>	<b>7</b>
<b>5- LABORATORY ACCREDITATIONS AND MEASUREMENT UNCERTAINTY .....</b>	<b>8</b>
5.1 LABORATORY ACCREDITATION.....	8
5.2 MEASUREMENT UNCERTAINTY .....	8
<b>6- TECHNICAL REQUIREMENTS AND RESULTS .....</b>	<b>9</b>
6.1 CARRIER FREQUENCY SEPARATION MEASUREMENT .....	9
6.2 NUMBER OF HOPPING FREQUENCIES MEASUREMENT .....	11
6.3 TIME OF OCCUPY (DWELL TIME) MEASUREMENT .....	13
6.4 PEAK OUTPUT POWER MEASUREMENT .....	17
6.5 BAND EDGE OF CONDUCTED EMISSION .....	20
6.6 SPURIOUS RADIATED EMISSION MEASUREMENT .....	22
6.7 99% BANDWIDTH MEASUREMENT .....	28
6.8 RF EXPOSURE .....	31
6.9 ANTENNA REQUIREMENT .....	31
<b>APPENDIX 1 PHOTOGRAPHS OF TEST SETUP .....</b>	<b>32</b>
<b>APPENDIX 2 PHOTOGRAPHS OF CONSTRUCTIONAL DETAILS .....</b>	<b>33</b>
EUT- FRONT VIEW .....	33
EUT- TOP VIEW.....	33
EUT- SIDE VIEW .....	34
EUT- REAR VIEW .....	35
EUT- INTERNAL VIEW .....	36
EUT- PCB VIEW.....	37
<b>APPENDIX 3 FCC/IC LABEL .....</b>	<b>41</b>

### 1-Test Result Certification

Applicant: Sanwa Electronic Instrument Co., Ltd  
 1-2-50, Yoshida Honmachi, Higashi-Osaka,  
 Osaka 578-0982, Japan

Equipment Under Test: 2.4GHz Radio Control System

Trade Name: SANWA

Model: 90480

Type of Modulation: FHSS

Number of Channels: 76

Channel Separation: 1MHz

Operation Frequency: 2403 ~2478MHz

Antenna Designation: Non-user replaceable (fixed)

Battery Voltage: DC7.2V [1.2V\*6 "AA" Ni-MH battery]

Date of Test: February 19-21, 2009

Applicable Standards	
Standard	Test Result
FCC 47 CFR Part 15 Subpart C, §15.247 Industry Canada: RSS-210 issue 7:2007, Annex 8 Industry Canada: RSS-Gen issue 2:2007	No non-compliance noted

**We hereby certify that:**

The above equipment was tested at ATC Lab Co., Ltd (Guangdong, China). The test data, data evaluation, test procedures, and equipment configurations shown in this report were made in accordance with the procedures given in ANSI C63.4 and the energy emitted by the sample EUT tested as described in this report is in compliance with conducted and radiated emission limits of FCC Rules Part 15C: 2007, §15.247 and RSS-210 Issue 7, Annex 8.

The test results of this report relate only to the tested sample identified in this report.

## 2- EUT Description

Product	2.4GHz Radio Control System
Trade Name	SANWA
Model Number	90480
Model Difference	N/A
Type of Modulation:	FHSS
Number of Channels:	76
Channel Separation:	1MHz
Power Supply	7.2V DC power from [1.2V*6 "AA" Ni-MH battery]
Frequency Range	2403 ~2478 MHz
Antenna Designation	Non-user replaceable (fixed)

**Remark:** This submittal(s) test report is intended for FCC ID: L73-90480, IC: 7377A-90480 filing to comply with Section 15.247 of the FCC Part 15, Subpart C Rules and RSS-210 Issue 7, Annex 8.

## 3-Test System

### 3.1 Test Mode

The compliance test was performed under test modes:

Mode 1: Transmitting at 2403MHz without hopping.

Mode 2: Transmitting at 2440MHz without hopping.

Mode 3: Transmitting at 2478MHz without hopping.

Mode 4: Transmitting with hopping.

The EUT is designed both of horizontally placed and vertically place. In radiated emission measurement, each condition was conducted.

As a result, the emission that produce the maximum operation under were reported.

- a) Carrier Frequency Separation measurement ---Mode 4
- b) Number of Hopping Frequencies measurement --- Mode 4
- c) Time of Occupancy measurement --- Mode 4
- d) Peak Output Power measurement --- Mode 1, Mode 2, Mode 3
- e) Band Edge of RF Conducted measurement --- Mode 4
- f) Radiated Emission measurement --- Mode 1, Mode 2, Mode 3
- g) 99% Bandwidth measurement --- Mode 1, Mode 2, Mode 3

### 3.2 Test Setup Diagram

- . Carrier Frequency Separation
- . Number of Hopping Frequencies
- . Time of Occupancy (Dwell Time)
- . Peak Output Power
- . Band Edge of RF Conducted Emission
- . 99% Bandwidth

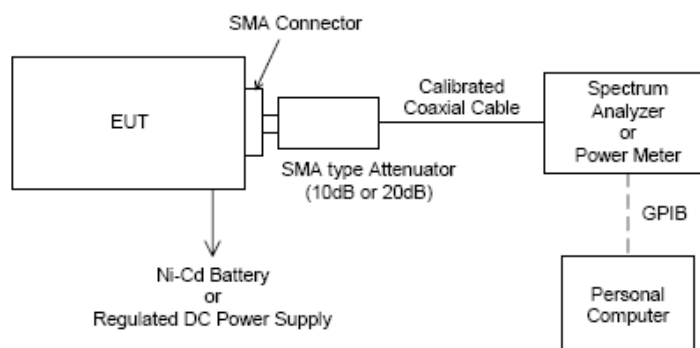

*Note: Regulated DC power supply is not used in this report.*

. Radiated Emisison

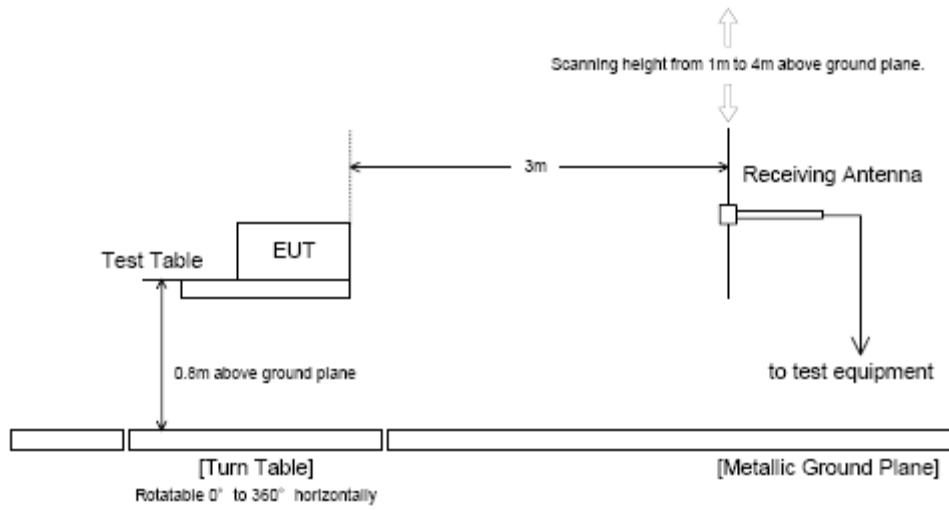

3.3 Block Diagram of EUT System

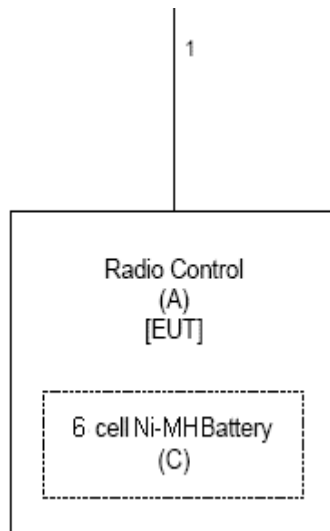

3.4 List of Cables

No	Cable Name	Shielded (Y/N)	Length (m)	Note	Remark
1	Antenna	Y	0.1		

#### 4- Test Equipment and Calibration

Equipment type	Manufacturer	Model	Serial Number	Calibration Due
Biconilog Antenna	ETS	3142C	00042672	2009/09/26
Receiver	SCHAFFNER	SMR4503	11725	2009/07/08
Spectrum Analyzer	R/S	FSP30	100755	2009/11/26
Double-Ridged-Wave-guide Horn Antenna	ETS	3115	6587	2009/08/02
Amplifier	Agilent	83017A	MY39500438	2009/11/26

## 5- Laboratory Accreditations and Measurement Uncertainty

### 5.1 Laboratory Accreditation

FCC-Registration No.: 415467

ATC Lab Co., Ltd (Guangdong, China) EMC Laboratory has been registered and fully described in a report filed with the FCC (Federal Communications Commission). The acceptance letter from the FCC is maintained in our files. Registration 415467. Listing date October 10, 2008.

IC-Registration No.: 7949A

The 3m Alternate Test Site of ATC Lab Co., Ltd (Guangdong, China) has been registered by Certification and Engineering Bureau of Industry Canada for the performance of radiated measurements with Registration No. 7949A on Oct. 29th, 2008.

### 5.2 Measurement Uncertainty

of +/-  $3 \times 10^{-9}$  for Carrier Frequency Separation Measurement  
of +/-  $3 \times 10^{-9}$  for Number of Hopping Frequencies Measurement  
of +/-  $3 \times 10^{-9}$  for 20dB Bandwidth Measurement  
of +/-  $3 \times 10^{-9}$  for Time of Occupancy (Dwell time) Measurement  
of +/- 0.8 dB for Peak Output Power Measurement  
of +/- 0.8 dB for Band Edge RF Conducted Measurement  
of +/- 0.8 dB for Spurious RF Conducted Emission Measurement  
of +/- 0.8 dB for Power Density  
of +/- 4.8 dB for Radiated Emissions  
of +/- 2.3 dB for Conducted Emissions



## 6- Technical Requirements and Results

### 6.1 Carrier Frequency Separation Measurement

#### Applicable Standard:

According to §15.247(a)(1), Frequency hopping systems shall have hopping channel carrier frequencies separated by minimum of 25KHz or the 20dB bandwidth of the hopping channel, whichever is greater.

According to RSS 210 issue 7, A8.1(b), frequency hopping systems operating in the 2400-2483.5 MHz band may have hopping channel carrier frequencies that are separated by 25 kHz or two-thirds of the 20dB bandwidth of the hopping channel, whichever is greater.

#### Test Procedure:

1. Connect the EUT RF output port to spectrum analyzer via calibrated coaxial cable and suitable attenuator (if necessary).
2. Activates the EUT System and execute the software prepared for test, if necessary.
3. To find out the maximum emission condition, the transmitting data rate of EUT is set to maximum data rate.
4. The Spectrums are scanned and allow the trace stabilized.
5. The separation between the peaks of the peaks of adjacent channel were measured by using delta-maker function of the spectrum analyzer

Spectrum analyzer setup condition :

Frequency Span : 2MHz  
 Resolution bandwidth : 100kHz  
 Video bandwidth :  $\cong$  RBW  
 Sweep : Auto  
 Detector function : Peak  
 Trace Mode : Max Hold

#### Test Result:

Temperature:	22 °C
Humidity:	45%
EUT Operation:	Data Transmission (hopping)
Test Date:	February 21, 2009

Carrier Frequency Separation [ MHz ]	[ MHz ] Limit
1.2084	> 0.025
Note: Test plots see next page figure 1.	

Figure 1: Channel Separation

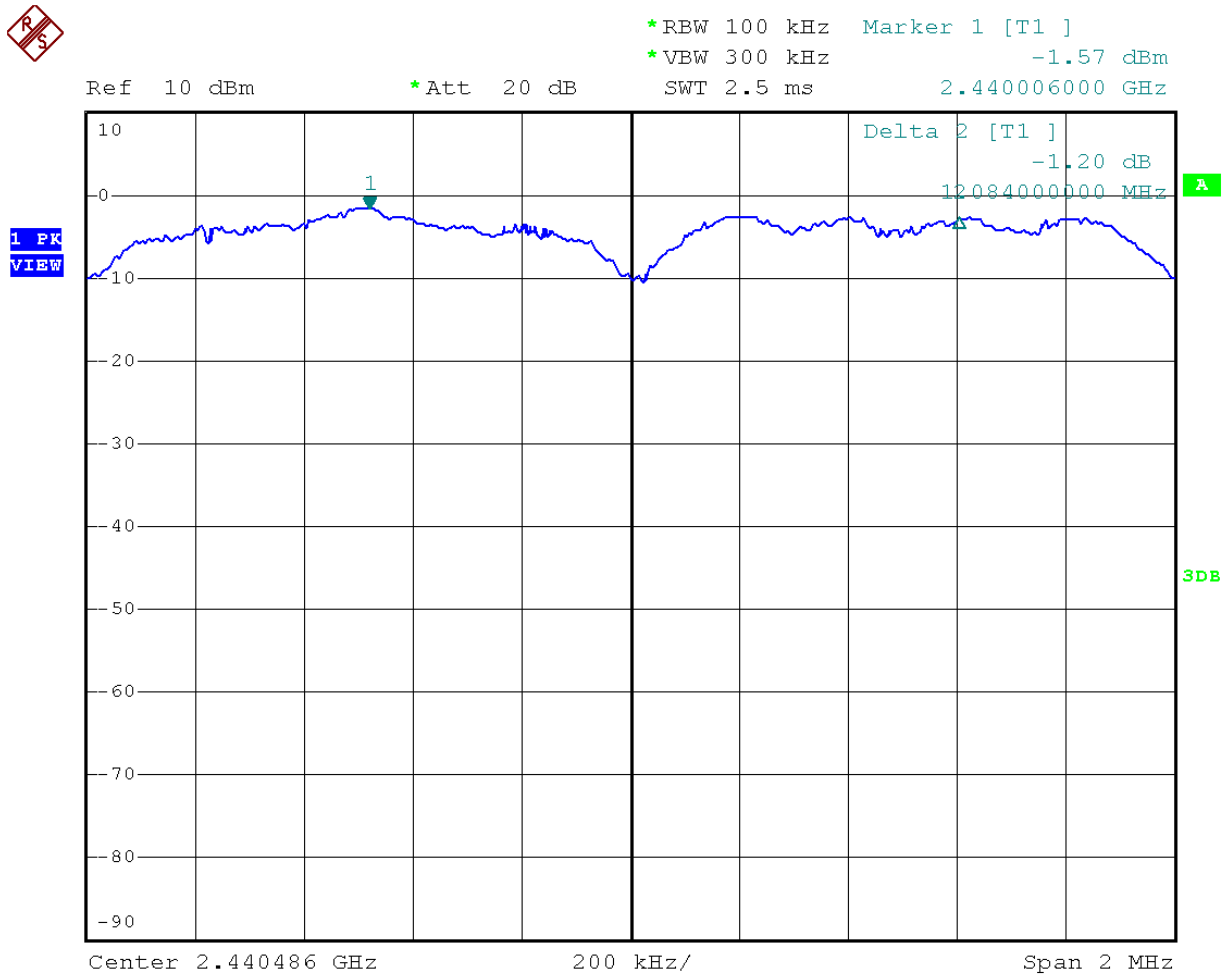

## 6.2 Number of Hopping Frequencies Measurement

### Applicable Standard:

According to §15.247(a)(1)(iii), Frequency hopping systems operating in the 2400MHz-2483.5 MHz bands shall use at least 15 hopping frequencies.

According to RSS-210 issue 7, §A8.1(d), Frequency hopping systems operating in the 2400-2483.5MHz band shall use at least 15 hopping channels. The average time of occupancy on any channel shall not be greater than 0.4 seconds within a period of 0.4 seconds multiplied by the number of hopping channels employed. Transmissions on particular hopping frequencies may be avoided or suppressed provided that a minimum of 15 hopping channels are used.

### Test Procedure:

1. Connect the EUT RF output port to spectrum analyzer via calibrated coaxial cable and suitable attenuator (if necessary).
2. Activates the EUT System and executes the software prepared for test, if necessary.
3. To find out the maximum emission condition, the transmitting data rate of EUT is set to maximum data rate.
4. The spectrums are scanned and allow the trace to stabilize.
5. The number of hopping frequencies were counted on the spectrum analyzer and recorded.

Spectrum analyzer setup condition :

Frequency Span : 81MHz  
 Resolution bandwidth : 300KHz  
 Sweep : Auto  
 Detector function : Peak  
 Trace Mode : Max Hold

### Test Result:

Temperature:	22 °C
Humidity:	45%
EUT Operation:	Data Transmission (hopping)
Test Date:	February 21, 2009

Number of Hopping Frequencies	[ MHz ] Limit
76	> 15
Note: Test plots see next page figure 2.	

Figure 2: Number of Hopping Frequencies

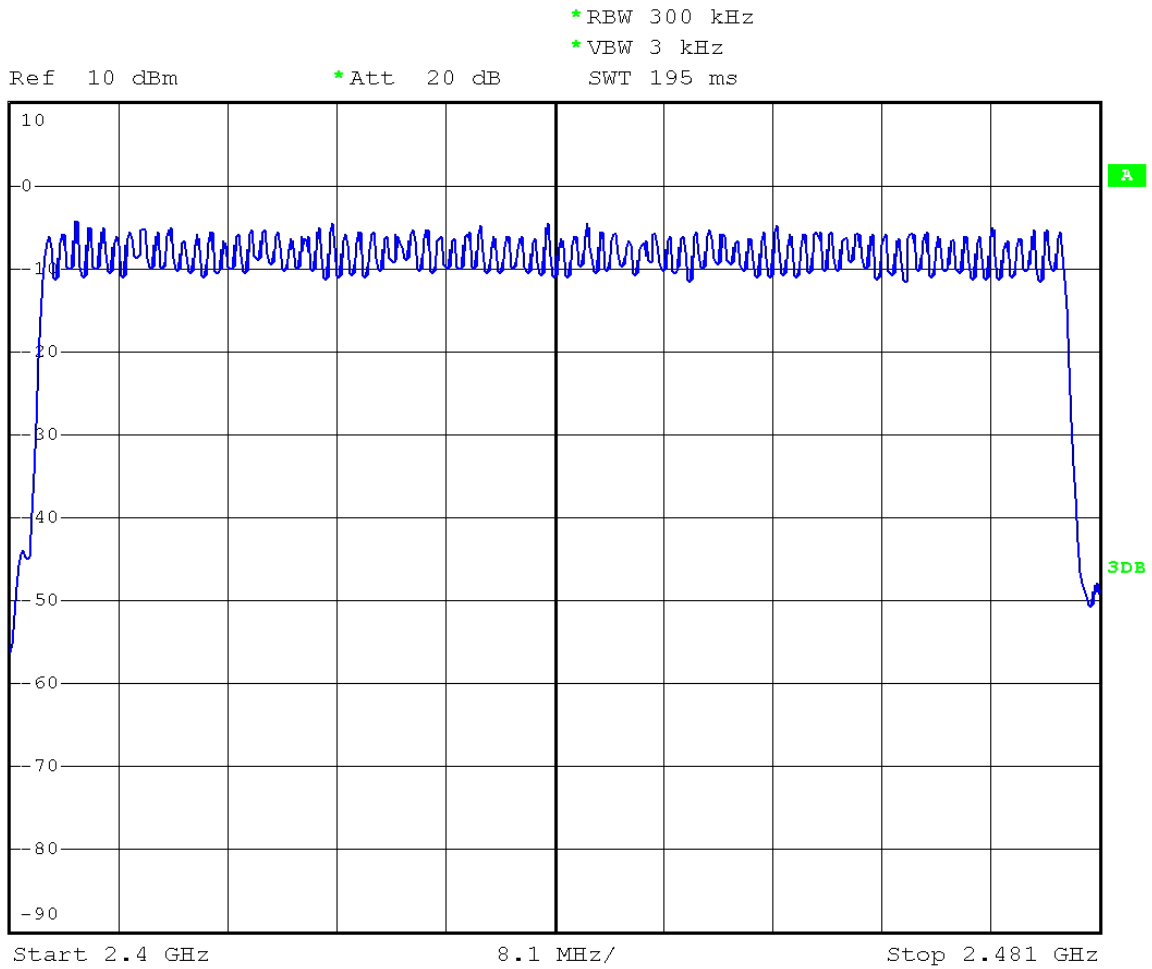

### 6.3 Time of Occupy (Dwell Time) Measurement

**Applicable Standard:**

According to §15.247(a)(1)(iii), Frequency hopping systems operating in the 2400MHz-2483.5 MHz. The average time of occupancy on any frequency shall not greater than 0.4 s within period of 0.4 seconds multiplied by the number of hopping channel employed.

According to RSS-210 issue 7, §A8.1 (d), Frequency hopping systems operating in the 2400-2483.5MHz bands shall use at least 15 hopping channels. The average time of occupancy on any channel shall not be greater than 0.4 seconds within a period of 0.4 seconds multiplied by the number of hopping channels employed. Transmissions on particular hopping frequencies may be avoided or suppressed provided that a minimum of 15 hopping channels are used.

**Test Procedure:**

1. Connect the EUT RF output port to spectrum analyzer via calibrated coaxial cable and suitable attenuator (if necessary).
2. Activates the EUT System and execute the software prepared for test, if necessary.
3. To find out the maximum emission condition, the transmitting data rate of EUT is set to maximum data rate.
4. The span of spectrum analyzer was set to zero (sweep time 30msec). The occupied time at center on a hopping frequency was observed and recorded as "Ton".
5. The spectrums are scanned by using the spectrum analyzer (\*1). And the numbers of occupied channel per Nsec (period of 0.4 seconds multiplied by the number of hopping channels employed) were counted by using the delta-marker function of spectrum analyzer and recorded as "N".
6. The dwell time was calculated by  $Ton \times N$ .

Spectrum analyzer setup condition:

Frequency Span : Zero span

Resolution bandwidth : 10KHz

Video bandwidth :  $\cong$  RBW

Sweep : as necessary to capture the entire dwell time per hopping channel.

Detector function : Peak

Trace Mode : Max Hold

**Test Result:**

Temperature:	22 °C
Humidity:	45%
EUT Operation:	Data Transmission (hopping)
Test Date:	February 21, 2009

[ ms ]Dwell Time	[ ms ] Limit
1.4145ms x 248 = 350.796	< 400
Note: Test plots see next page figures 3, 4 and 5.	

Figure 3: Duration of one transmission

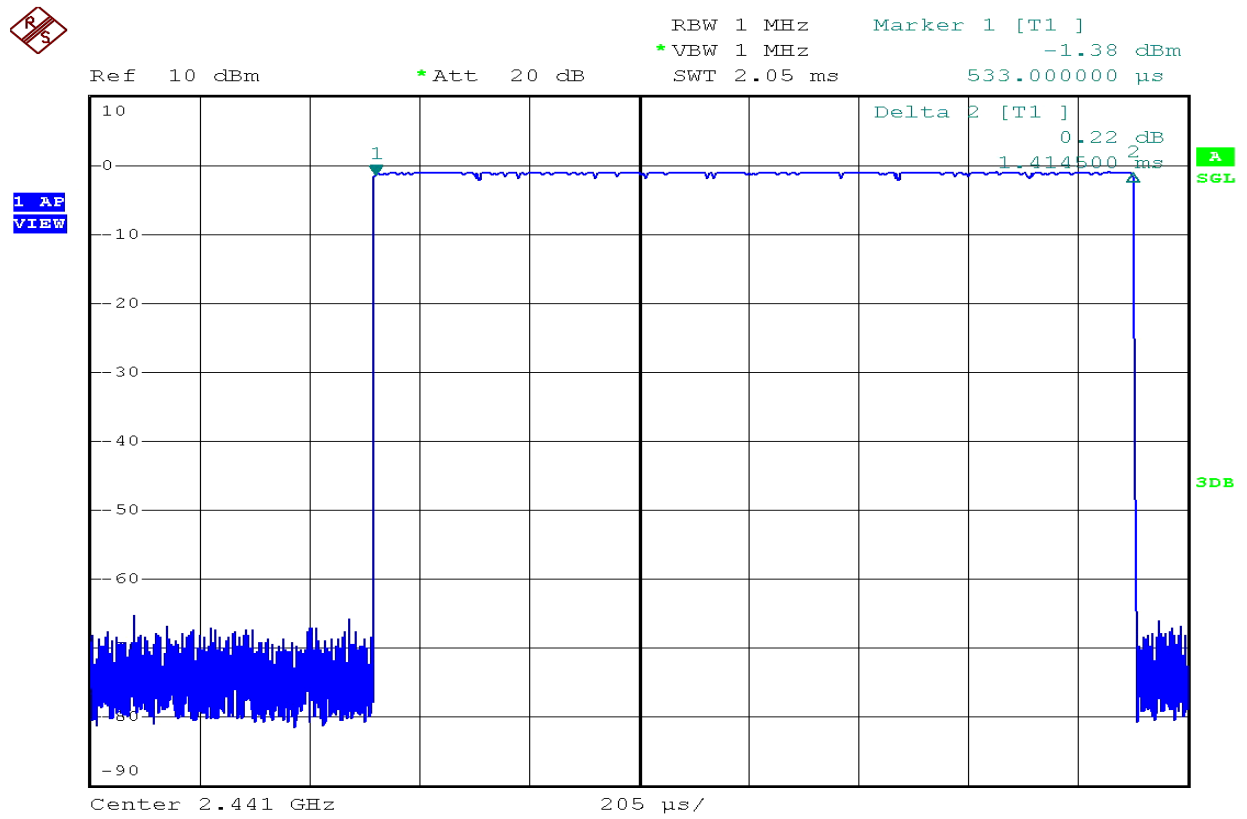

Figure 4: Number of Transmission at 3.8 s

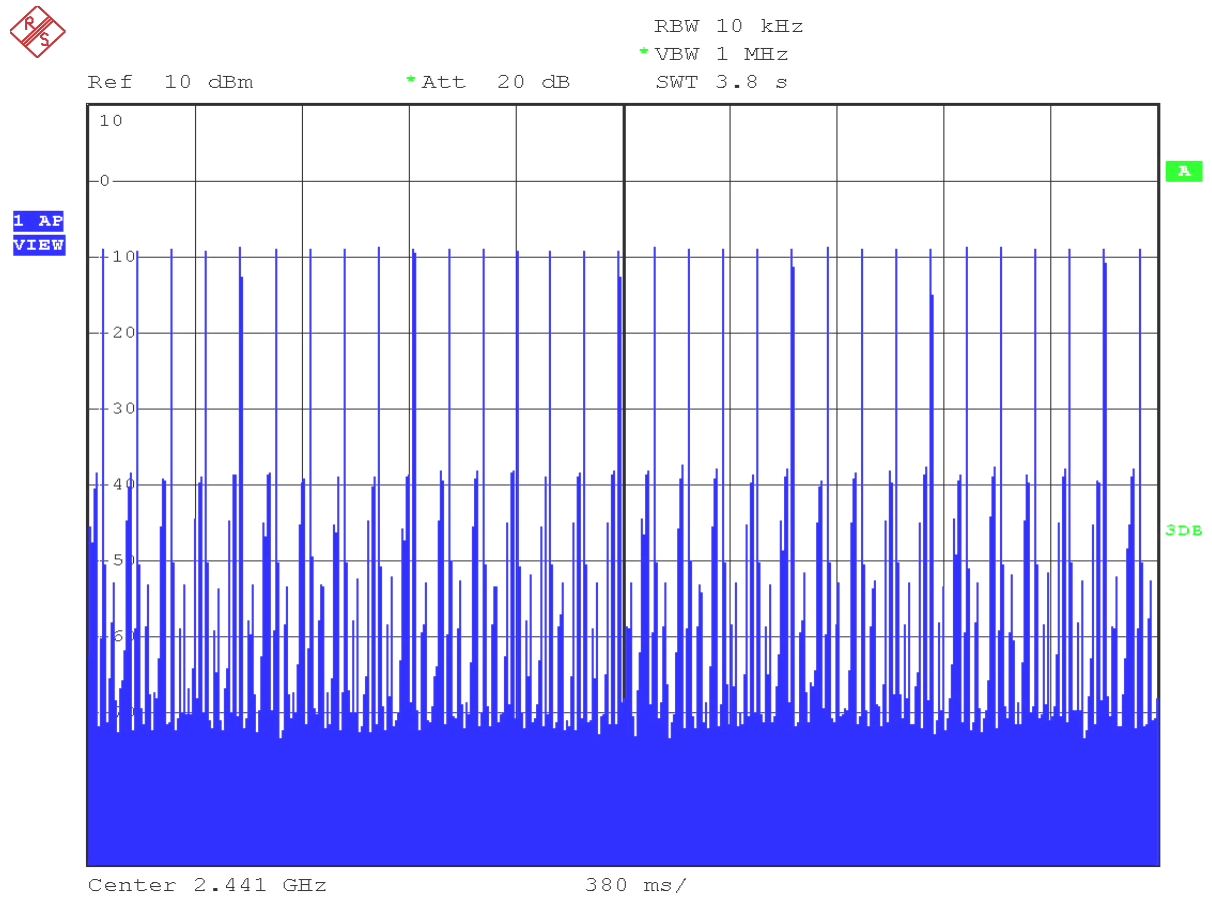
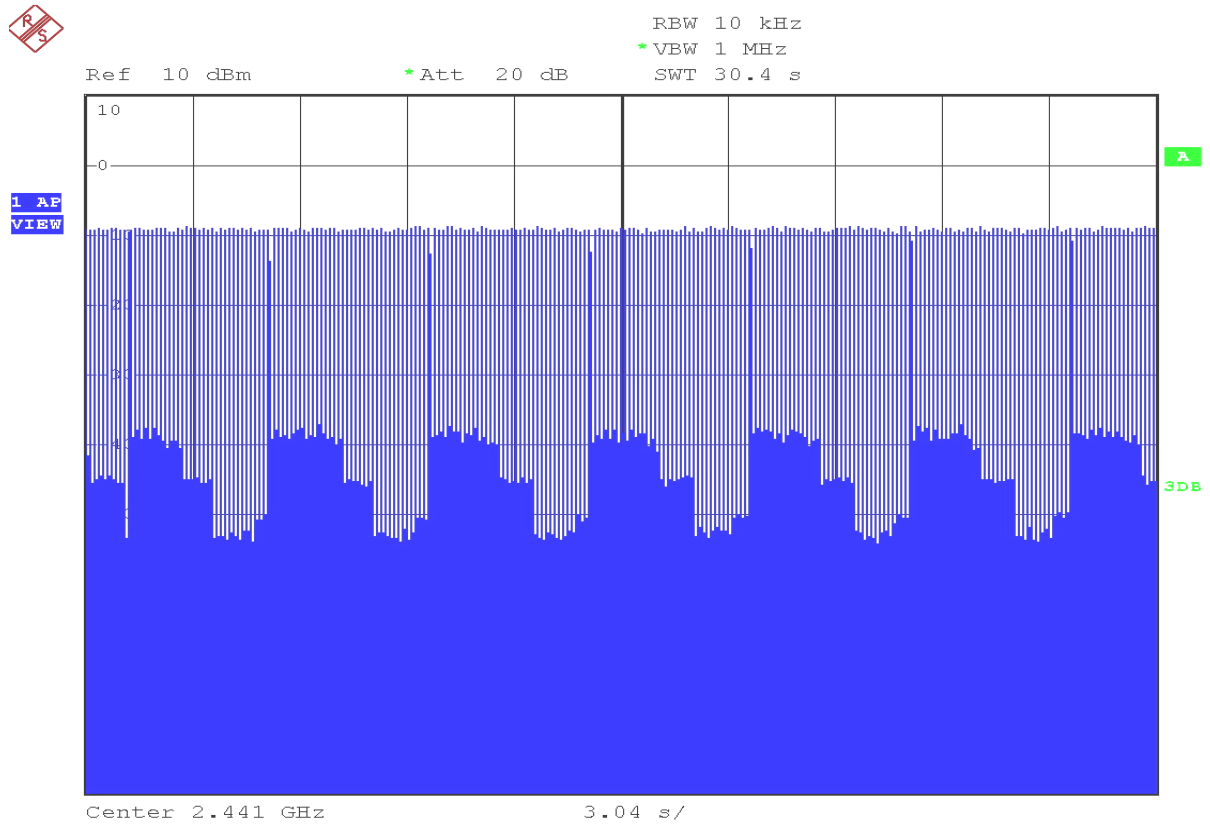

Figure 5: Number of Transmission at 30.4 s





## 6.4 Peak Output Power Measurement

### Applicable Standard:

According to §15.247(b), For frequency hopping systems operating in the 2400-2483.5 MHz band employing at least 75 hopping channels, and all frequency hopping systems in the 5725-5850MHz band: 1Watt. For all other frequency hopping systems in the 2400 – 2483.5MHz band: 0.125 Watts.

According to RSS-210 issue 7, §A8.4 (2), For frequency hopping systems operating in the 2400-2483.5 MHz band employing at least 75 hopping channels, the maximum conducted output power shall not exceed 1 W. For all other frequency hopping systems, the maximum peak conducted output power shall not exceed 0.125 W.

### Test Procedure:

1. Connect the EUT RF output port to spectrum analyzer via calibrated coaxial cable and suitable attenuator (if necessary).
2. Activates the EUT System and executes the software prepared for test, if necessary.
3. To find out the worst case, the transmitting data rate of EUT is varied with the different modes of operation. The final test condition is recorded in this report.
4. The spectrums are scanned and allow the trace to stabilize.
5. The peak output power was determined by using the marker-data function of spectrum analyzer or peak type power meter.

### Spectrum Analyzer Set Up Conditions

Frequency Span : above 20dB bandwidth of the emission being measured

Resolution bandwidth : 3MHz

Video bandwidth :  $\cong$  RBW

Sweep : Auto

Detector function : Peak

Trace Mode : Max Hold

### Test Result:

Temperature:	22 °C
Humidity:	45%
EUT Operation:	Data Transmission (without hopping)
Test Date:	February 21, 2009

Frequency	Factor	Reading	Power	Limit	Margin
[ MHz ]	[ dB ]	[ dBm ]	[ dBm ]	[ dBm ]	[ dB ]
2403	5.20	-0.68	4.52	20.97	16.45
2441	5.20	-0.62	4.58	20.97	16.39
2478	5.20	-0.69	4.51	20.97	16.46

Note: Test plots see next page figures 6, 7 and 8

Figure 6: Peak Output Power-low channel

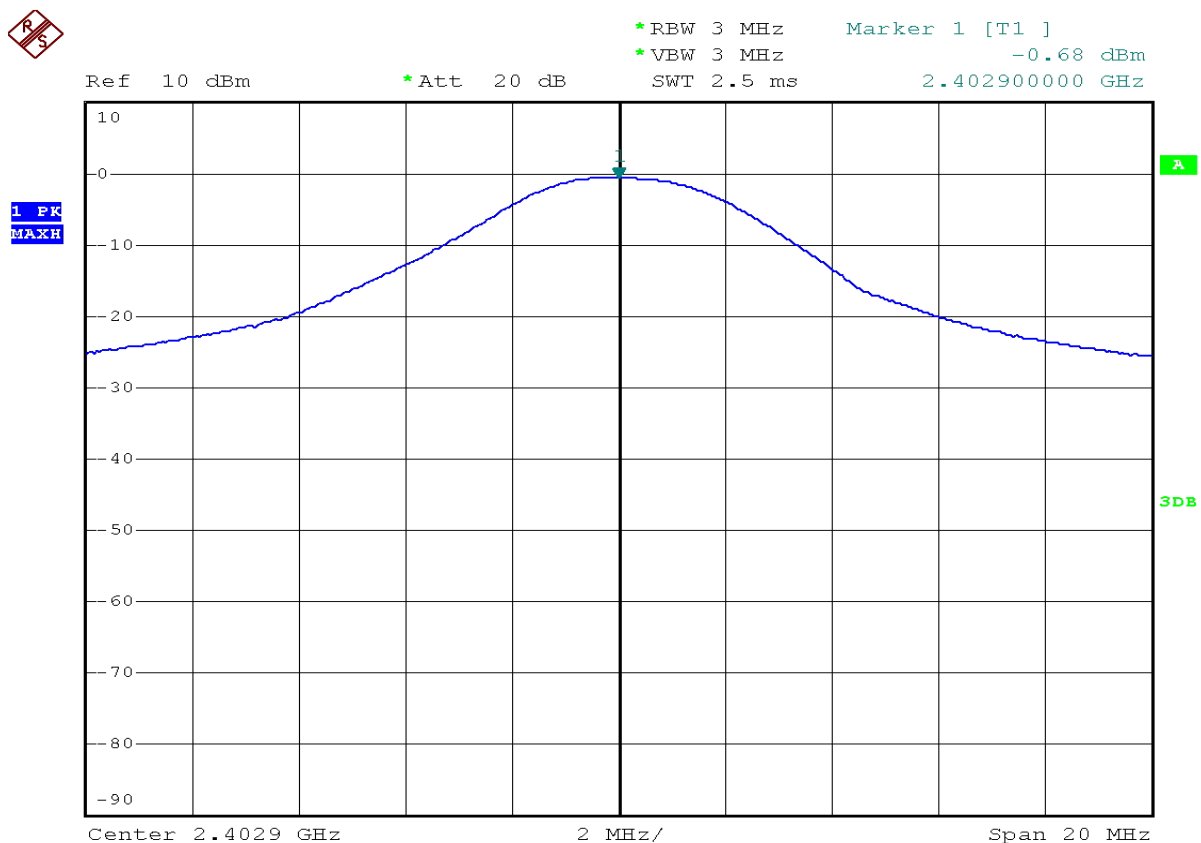

Figure 7: Peak Output Power-mid channel

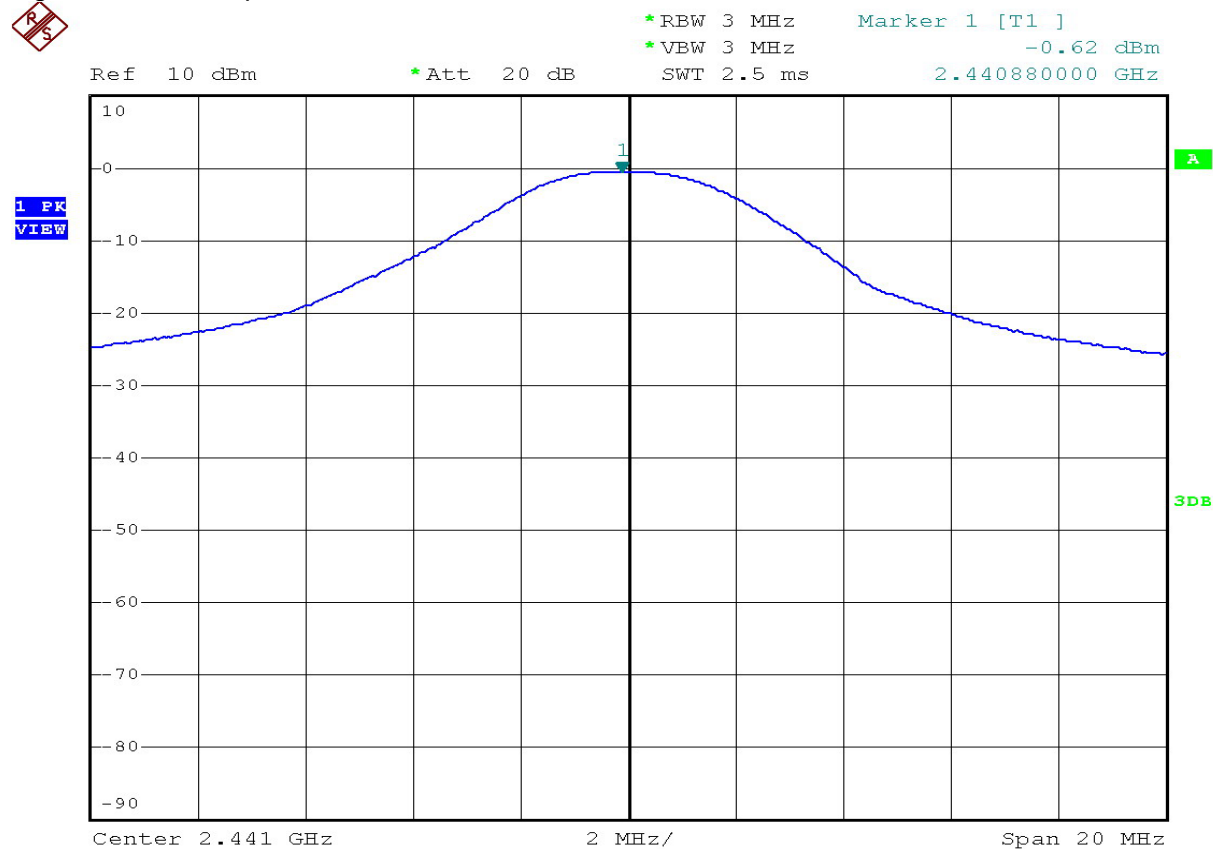
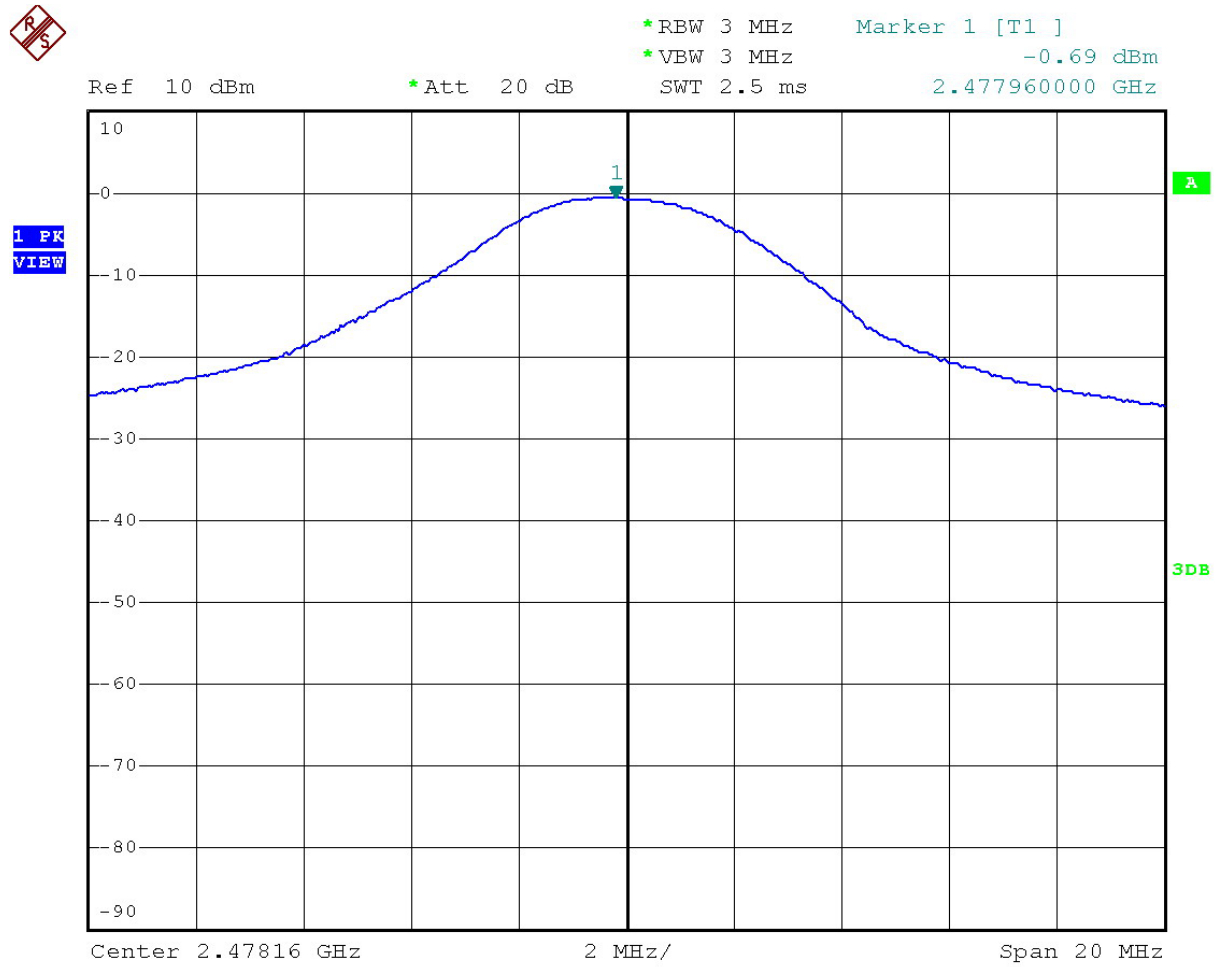

Figure 8: Peak Output Power-high channel



## 6.5 Band Edge of Conducted Emission

### Applicable Standard:

According to §15.247(d), in any 100 KHz bandwidth outside the frequency bands in which the spread spectrum intentional radiator is operating, the radio frequency power that is produced by the intentional radiator shall be at least 20dB below that in the 100KHz bandwidth within the band that contains the highest level of the desired power, In addition, radiated emissions which fall in the restricted bands, as defined in §15.205(a), must also comply with the radiated emission limits specified in 15.209(a).

According to RSS-210 issue 7, §A8.5, In any 100 kHz bandwidth outside the frequency band in which the spread spectrum or digitally modulated device is operating, the radio frequency power that is produced shall be at least 20 dB below that in the 100 kHz bandwidth within the band that contains the highest level of the desired power, based on either an RF conducted or a radiated measurement, provided the transmitter demonstrates compliance with the peak conducted power limits. If the transmitter complies with the conducted power limits based on the use of RMS averaging over a time interval, as permitted under section A8.4(4), the attenuation required shall be 30 dB instead of 20 dB. Attenuation below the general limits specified in Tables 2 and 3 is not required. In addition, radiated emissions which fall in the restricted bands of Table 1 must also comply with the radiated emission limits specified in Tables 2 and 3.

### Test Procedure:

1. Connect the EUT RF output port to the spectrum analyzer via calibrated coaxial cable and suitable attenuator (if necessary).
2. Activates the EUT System and executes the software prepared for test, if necessary.
3. To find out the maximum emission condition, the transmitting data rate of EUT is set to maximum data rate.
4. The spectrum are scanned.
5. The emission at the band edge or the highest modulation product outside of band were measured by using the marker function of spectrum analyzer (\*1).
6. The peak of the in-band emission were measured by using the marker to peak function of spectrum analyzer.
7. Above measurement were repeated at other side band edge.

Frequency Span : Wide enough to capture the peak level of emission on the band edge

Resolution bandwidth : 100kHz

Video bandwidth :  $\geq$  RBW

Sweep : Auto

Detector function : Peak

Trace Mode : Max Hold

Temperature:	22 °C
Humidity:	45%
EUT Operation:	Data Transmission (without hopping)
Test Date:	February 21, 2009

The unit does meet the requirement, see the next page figures 9 and 10.

Figure 9: Band Edge - low frequency side

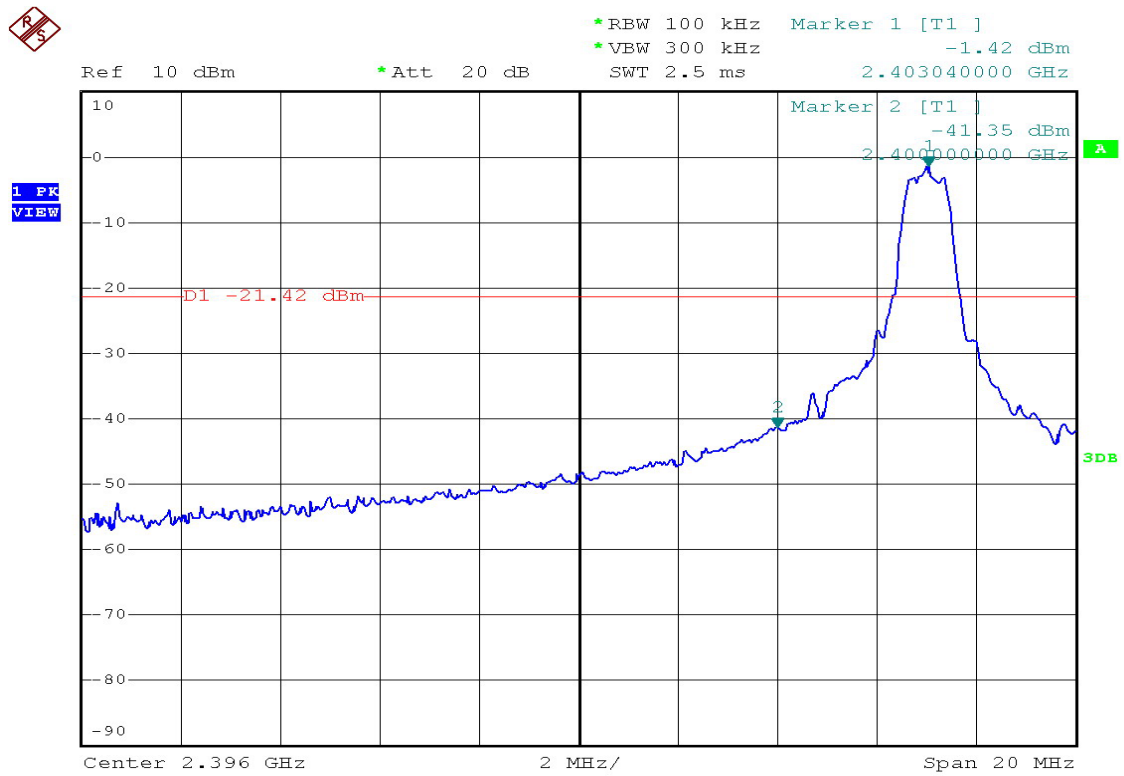
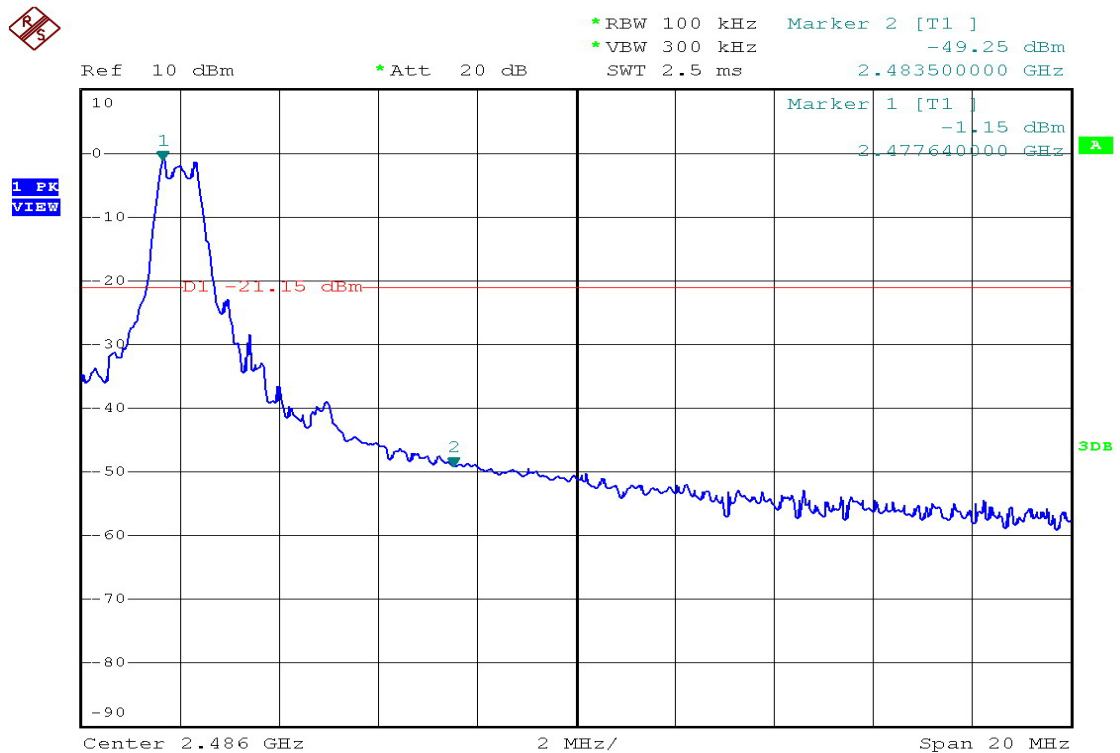

Figure 10: Band Edge – high frequency side



### 6.6 Spurious Radiated Emission Measurement

**Applicable Standard:**

According to §15.247(c), all other emissions outside these bands shall not exceed the general radiated emission limits specified in §15.209(a). And according to §15.33(a)(1), for an intentional radiator operates below 10GHz, the frequency range of measurements: to the tenth harmonic of the highest fundamental frequency or to 40GHz, whichever is lower.

According to RSS-210 issue 7, §A8.5, In any 100 kHz bandwidth outside the frequency band in which the spread spectrum or digitally modulated device is operating, the radio frequency power that is produced shall be at least 20 dB below that in the 100 kHz bandwidth within the band that contains the highest level of the desired power, based on either an RF conducted or a radiated measurement, provided the transmitter demonstrates compliance with the peak conducted power limits. If the transmitter complies with the conducted power limits based on the use of RMS averaging over a time interval, as permitted under section A8.4(4), the attenuation required shall be 30 dB instead of 20 dB. Attenuation below the general limits specified in Tables 2 and 3 is not required. In addition, radiated emissions which fall in the restricted bands of Table 1 must also comply with the radiated emission limits specified in Tables 2 and 3.

**Test Procedure:**

1. The EUT was placed on a turn table which is 0.8m above ground plane.
2. The turn table shall rotate 360 degrees to determine the position of maximum emission level.
3. EUT is set 3m away from the receiving antenna which varied from 1m to 4m to find out the highest emissions.
4. Maximum procedure was performed on the six highest emissions to ensure EUT compliance.
5. And also, each emission was to be maximized by changing the polarization of receiving antenna both horizontal and vertical.
6. Repeat above procedures until all frequency measured were complete.

The field strength is calculated by adding the Antenna Factor and Cable Factor and subtracting the Amplifier Gain and Duty Cycle Correction Factor(if any) from the measured reading. The basic equation with a sample calculation is as follows:

$$FS = RA + AF + CL - AG$$

Where FS = Field Strength	CL = Cable Attenuation Factor (Cable Loss)
RA = Reading Amplitude	AG = Amplifier Gain
AF = Antenna Factor	

Test Configuration Below 1 GHz:

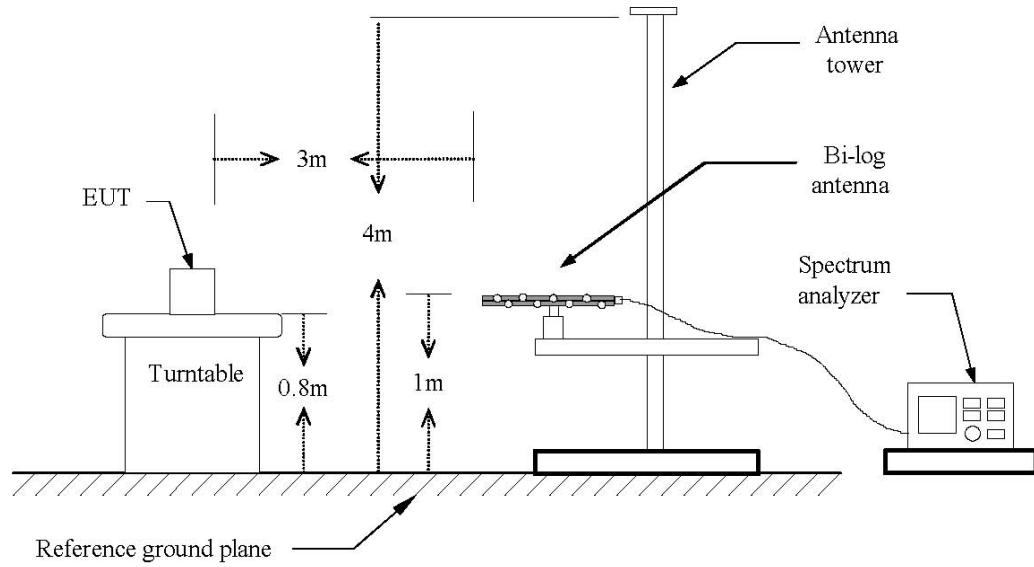

Test Configuration Above 1 GHz:

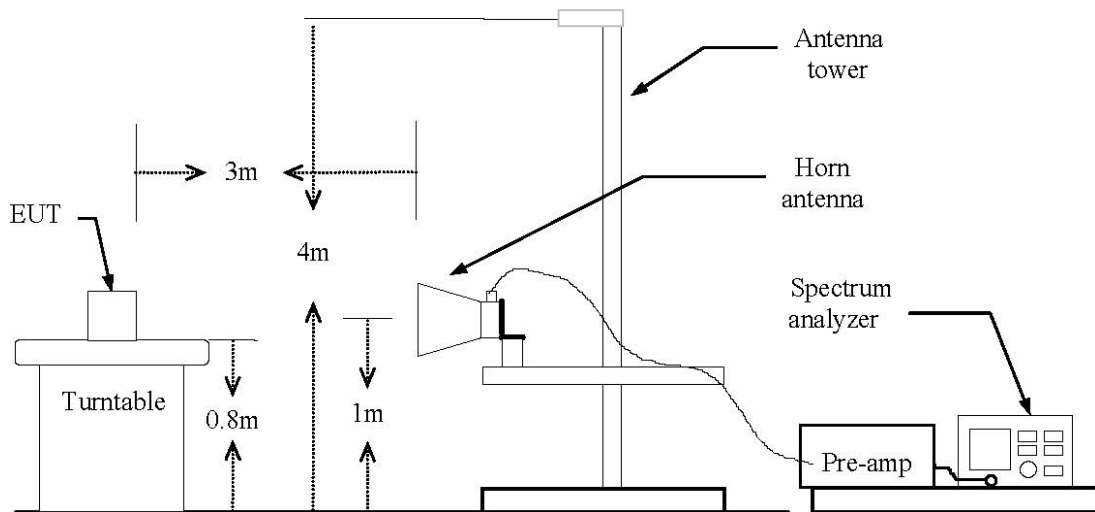

Test Results:

Temperature:	24°C
Humidity:	45%
EUT Operation:	Data Transmission (without hopping)
Test Date:	February 21, 2009

**Spurious Emission In the Frequency Rang Below 1GHz:**

Fc= 2403MHz Transmitting Operation

Freq. (MHz)	Ant.Pol. (H/V)	Detector Mode (PK/QP)	Reading (dBuV)	Ant./CL/ Amp.CF (dB)	Actual FS (dBuV/m)	Limit 3m (dBuV/m)	Margin (dB)
35.36	H	Peak	7.2	12.4	19.6	40.0	-20.4
628.00	H	Peak	17.4	19.3	36.7	46.0	-9.3
744.00	H	Peak	11.0	21.3	32.3	46.0	-13.7
170.00	V	Peak	27.2	11.4	38.6	43.5	-4.9
416.00	V	Peak	19.2	17.4	36.6	46.0	-9.4
600.00	V	Peak	13.5	19.3	32.8	46.0	-13.2

Fc= 2440MHz Transmitting Operation

Freq. (MHz)	Ant.Pol. (H/V)	Detector Mode (PK/QP)	Reading (dBuV)	Ant./CL/ Amp.CF (dB)	Actual FS (dBuV/m)	Limit 3m (dBuV/m)	Margin (dB)
30.72	H	Peak	7.1	12.6	19.7	40.0	-20.3
174.00	H	Peak	21.4	11.4	32.8	43.5	-10.7
600.00	H	Peak	13.2	19.3	32.5	46.0	-13.5
37.92	V	Peak	5.4	12.4	17.8	40.0	-22.2
174.00	V	Peak	27.4	11.4	38.8	43.5	-4.7
600.00	V	Peak	19.3	19.3	38.6	46.0	-7.4

Fc= 2478MHz Transmitting Operation

Freq. (MHz)	Ant.Pol. (H/V)	Detector Mode (PK/QP)	Reading (dBuV)	Ant./CL/ Amp.CF (dB)	Actual FS (dBuV/m)	Limit 3m (dBuV/m)	Margin (dB)
33.36	H	Peak	8.3	11.2	19.5	40.0	-20.5
210.00	H	Peak	19.6	8.8	28.4	43.5	-15.1
656.00	H	Peak	12.3	20.2	32.5	46.0	-13.5
37.04	V	Peak	4.7	12.4	17.1	40.0	-22.9
174.00	V	Peak	27.1	11.4	38.5	43.5	-5.0
600.00	V	Peak	15.1	19.3	34.4	46.0	-11.6

**Note:** For spurious emission measurement, the compliance tests were performed both of horizontally placed and vertically placed in EUT(X position, Y position, Z position). As a result, the data of operation mode that produce the maximum emission were reported. The other emissions are more than 20dB below the limit.



**Spurious Emission In the Frequency Rang above 1GHz:**

Fc= 2403MHz Transmitting Operation- Horizontal

Freq. (MHz)	Peak Reading (dBuV)	AV Reading (dBuV)	Ant./CL/ Amp.CF (dB)	Actual FS		Peak Limit (dBuV/m)	AV Limit (dBuV/m)	Margin
				Peak (dBuV/m)	AV (dBuV/m)			
4806.00	44.49	-	2.68	47.17	-	74.00	54.00	-26.83
7209.00	49.91	-	3.68	53.59	-	74.00	54.00	-20.41
9612.00	-	-	-	-	-	-	-	-
12015.00	-	-	-	-	-	-	-	-
14418.00	-	-	-	-	-	-	-	-
16821.00	-	-	-	-	-	-	-	-
19224.00	-	-	-	-	-	-	-	-
21627.00	-	-	-	-	-	-	-	-
24030.00	-	-	-	-	-	-	-	-

Fc= 2403MHz Transmitting Operation- Vertical

Freq. (MHz)	Peak Reading (dBuV)	AV Reading (dBuV)	Ant./CL/ Amp.CF (dB)	Actual FS		Peak Limit (dBuV/m)	AV Limit (dBuV/m)	Margin
				Peak (dBuV/m)	AV (dBuV/m)			
4806.00	44.84	-	2.68	47.52	-	74.00	54.00	-26.48
7209.00	48.67	-	3.68	52.35	-	74.00	54.00	-21.65
9623.00	-	-	-	-	-	-	-	-
12009.00	-	-	-	-	-	-	-	-
14432.00	-	-	-	-	-	-	-	-
16831.00	-	-	-	-	-	-	-	-
19229.00	-	-	-	-	-	-	-	-
21623.00	-	-	-	-	-	-	-	-
24017.00	-	-	-	-	-	-	-	-

**Note:** Data of measurement within this frequency range shown “---” in the table above means the reading of emissions are attenuated more than 20dB below the permissible limits or the field strength is too small to be measured. The other emissions are more than 20dB below the limit.

Fc= 2440MHz Transmitting Operation- Horizontal

Freq. (MHz)	Peak Reading (dBuV)	AV Reading (dBuV)	Ant./CL/ Amp.CF (dB)	Actual FS		Peak Limit (dBuV/m)	AV Limit (dBuV/m)	Margin
				Peak (dBuV/m)	AV (dBuV/m)			
4880.00	44.64	-	2.70	47.34	-	74.00	54.00	-26.66
7320.00	49.89	-	3.70	53.59	-	74.00	54.00	-20.41
9768.00	-	-	-	-	-	-	-	-
12210.00	-	-	-	-	-	-	-	-
14652.00	-	-	-	-	-	-	-	-
17094.00	-	-	-	-	-	-	-	-
19536.00	-	-	-	-	-	-	-	-
21978.00	-	-	-	-	-	-	-	-
24420.00	-	-	-	-	-	-	-	-

Fc= 2440MHz Transmitting Operation- Vertical

Freq. (MHz)	Peak Reading (dBuV)	AV Reading (dBuV)	Ant./CL/ Amp.CF (dB)	Actual FS		Peak Limit (dBuV/m)	AV Limit (dBuV/m)	Margin
				Peak (dBuV/m)	AV (dBuV/m)			
4880.00	46.22	-	2.70	47.34	-	74.00	54.00	-26.66
7320.00	50.54	-	3.70	53.59	-	74.00	54.00	-20.41
9768.00	-	-	-	-	-	-	-	-
12210.00	-	-	-	-	-	-	-	-
14652.00	-	-	-	-	-	-	-	-
17094.00	-	-	-	-	-	-	-	-
19536.00	-	-	-	-	-	-	-	-
21978.00	-	-	-	-	-	-	-	-
24420.00	-	-	-	-	-	-	-	-
24420.00	-	-	-	-	-	-	-	-

**Note:** Data of measurement within this frequency range shown “---” in the table above means the reading of emissions are attenuated more than 20dB below the permissible limits or the field strength is too small to be measured. The other emissions are more than 20dB below the limit.

Fc= 2478MHz Transmitting Operation- Horizontal

Freq. (MHz)	Peak Reading (dBuV)	AV Reading (dBuV)	Ant./CL/ Amp.CF (dB)	Actual FS		Peak Limit (dBuV/m)	AV Limit (dBuV/m)	Margin
				Peak (dBuV/m)	AV (dBuV/m)			
4956.00	49.78	-	2.70	52.48	-	74.00	54.00	-21.52
7437.00	55.01	-	3.90	58.91	-	74.00	54.00	-15.09
9860.00	-	-	-	-	-	-	-	-
12325.00	-	-	-	-	-	-	-	-
14870.00	-	-	-	-	-	-	-	-
17355.00	-	-	-	-	-	-	-	-
19850.00	-	-	-	-	-	-	-	-
22289.00	-	-	-	-	-	-	-	-
24750.00	-	-	-	-	-	-	-	-

Fc= 2478MHz Transmitting Operation- Vertical

Freq. (MHz)	Peak Reading (dBuV)	AV Reading (dBuV)	Ant./CL/ Amp.CF (dB)	Actual FS		Peak Limit (dBuV/m)	AV Limit (dBuV/m)	Margin
				Peak (dBuV/m)	AV (dBuV/m)			
4956.00	45.66	-	2.70	48.36	-	74.00	54.00	-25.64
7437.00	50.67	-	3.90	54.57	-	74.00	54.00	-19.43
9860.00	-	-	-	-	-	-	-	-
12325.00	-	-	-	-	-	-	-	-
14870.00	-	-	-	-	-	-	-	-
17355.00	-	-	-	-	-	-	-	-
19850.00	-	-	-	-	-	-	-	-
22289.00	-	-	-	-	-	-	-	-
24750.00	-	-	-	-	-	-	-	-
4956.00	-	-	-	-	-	-	-	-

**Note:** Data of measurement within this frequency range shown “---” in the table above means the reading of emissions are attenuated more than 20dB below the permissible limits or the field strength is too small to be measured. The other emissions are more than 20dB below the limit.

**6.7 99% Bandwidth Measurement**

**Standard Applicable:**

RSS-Gen §4.4.1, the transmitter shall be operated at its maximum carrier power measured under normal test conditions. The span of the analyzer shall be set to capture all products of the modulation process, including the emission skirts. The resolution bandwidth shall be set to as close to 1% of the selected span as is possible without being below 1%. The video bandwidth shall be set to 3 times the resolution bandwidth. Video averaging is not permitted. Where practical, a sampling detector shall be used since a peak or, peak hold, may produce a wider bandwidth than actual.

The trace data points are recovered and are directly summed in linear terms. The recovered amplitude data points, beginning at the lowest frequency, are placed in a running sum until 0.5% of the total is reached and that frequency recorded. The process is repeated for the highest frequency data points. This frequency is recorded. The span between the two recorded frequencies is the occupied bandwidth.

**Test Procedure:**

Use the following spectrum analyzer settings:

- Span = 2MHz
- Resolution Bandwidth = 30KHz
- Video Bandwidth = 100KHz
- Sweep = auto
- Detector function = peak
- Trace = max hold

**Test Results:**

Temperature:	24°C
Humidity:	49%
EUT Operation:	Data Transmission (without hopping)
Test Date:	February 21, 2009

Frequency (MHz )	99% Bandwidth (MHz)
2403	1.10
2441	1.09
2478	1.12

Note: Test plots see next page figures 11,12 and 13.

Figure 11- 99% bandwidth Measurement (fc=2403MHz)

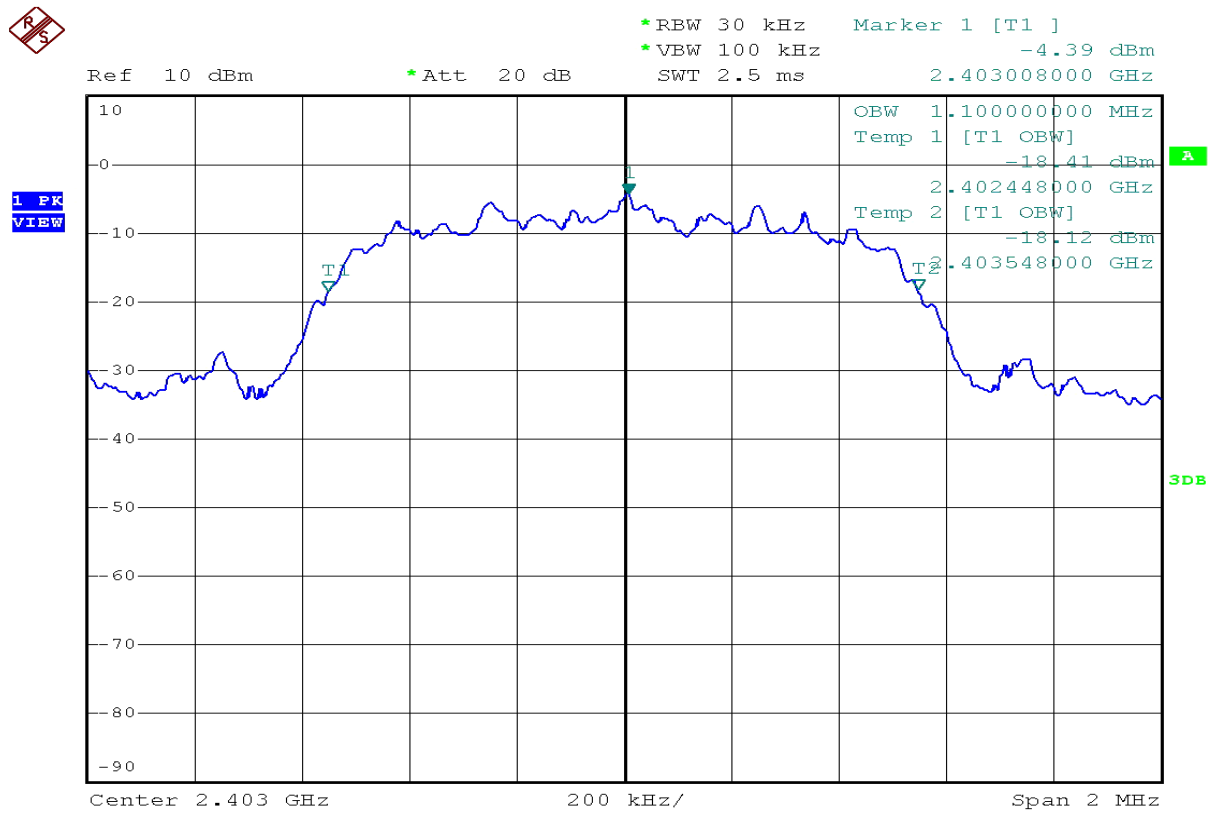

Figure 12- 99% bandwidth Measurement (fc=2441MHz)

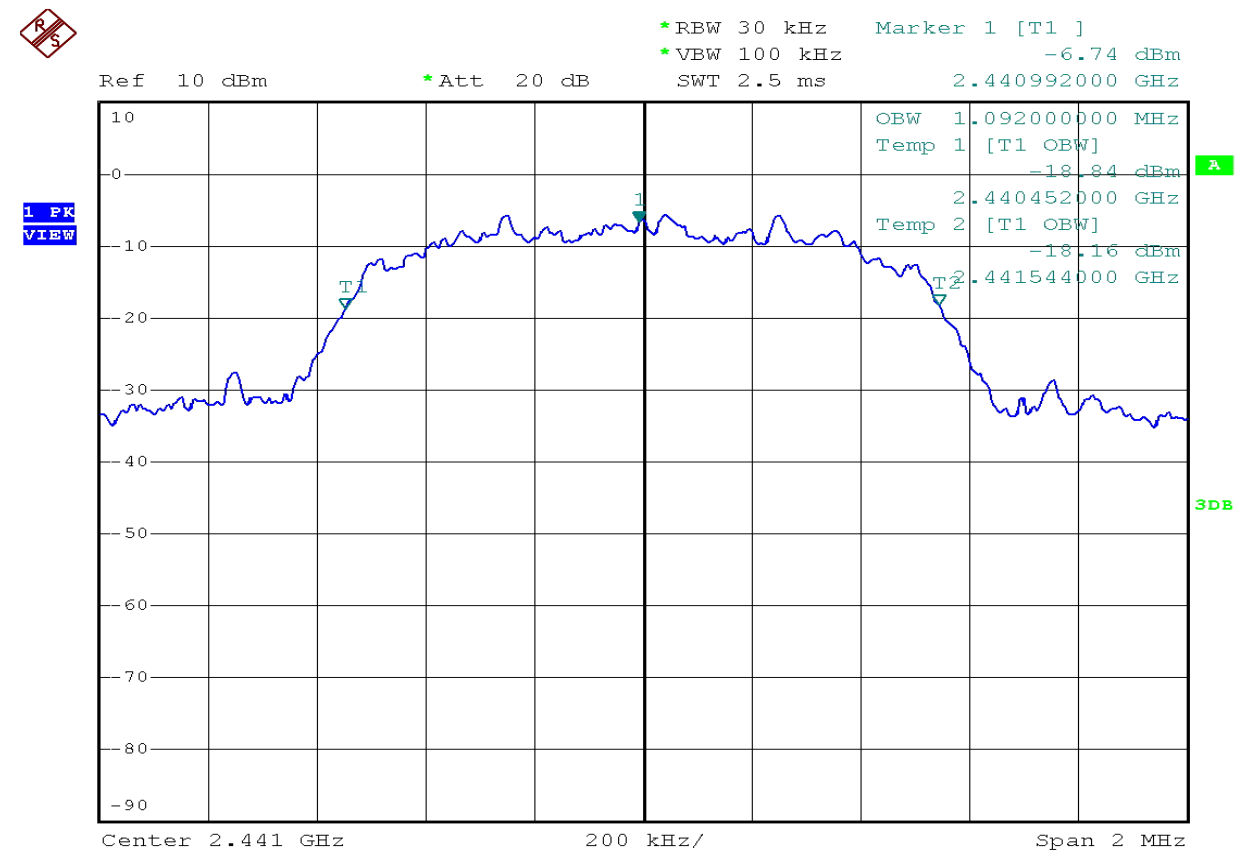
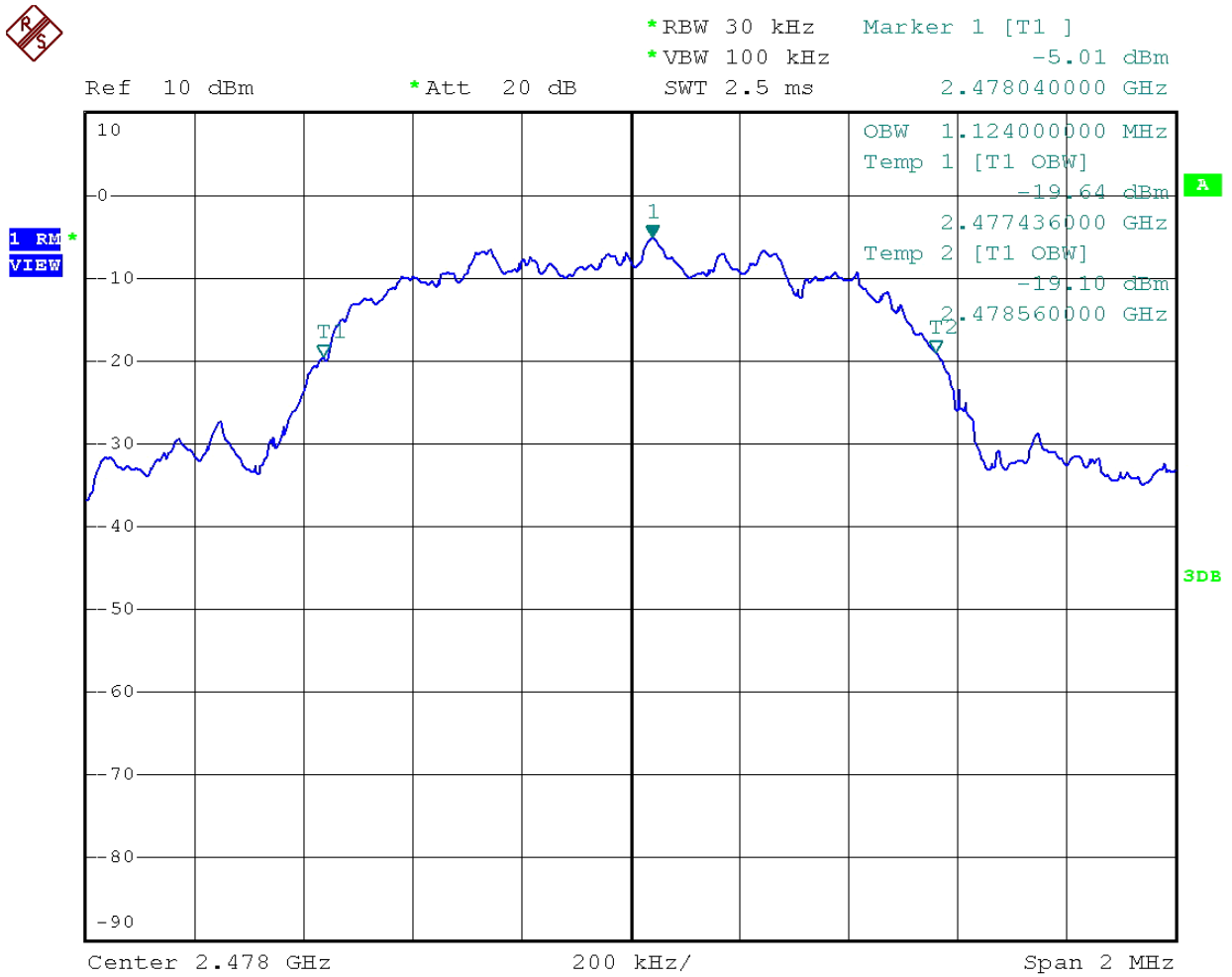

Figure 13- 99% bandwidth Measurement (fc=2478MHz)



## 6.8 RF Exposure

### Standard Applicable

According to 1.1307 (b)(1), systems operating under the provisions of this section shall be operated in a manner that ensure that the public is not exposed to radio frequency energy level in excess of the Commission's guideline.

This is a portable device.

### Measurement Result:

This is a portable device and the max peak output power is 4.58 dBm = (2.87mW). Lower than low threshold 60/f GHz mW = (24.21 mW), d <2.5 cm general population category.

The SAR/MPE measurement is not necessary.

## 6.9 Antenna Requirement

### Standard Applicable

According to §15.203, an intentional radiator shall be designed to ensure that no antenna other than furnished by the responsible party shall be used with the device. And according to §15.246(1), if transmitting antennas of directional gain greater than 6dBi are used the power shall be reduced by the amount in dB that the directional gain of the antenna exceeds 6 dBi.

According to RSS-GEN 7.1.4, a transmitter can only be sold or operated with antennas with which it was certified. A transmitter may be certified with multiple antenna types. An antenna type comprises antennas having similar in-band and out-of-band radiation patterns. Testing shall be performed using the highest-gain antenna of each combination of transmitter and antenna type for which certification is being sought, with the transmitter output power set at the maximum level. Any antenna of the same type and having equal or lesser gain as an antenna that had been successfully tested for certification with the transmitter, will also be considered certified with the transmitter, and may be used and marketed with the transmitter. The manufacturer shall include with the application for certification a list of acceptable antenna types to be used with the transmitter.

### Antenna Construction:

The directional gains of antenna used for transmitting is 1.3~1.5 dBi, and the antenna connector is designed with permanent attachment and no consideration of replacement. Please see EUT photo for details.

The unit does meet the requirement.

## Appendix 1 Photographs of Test Setup

### Radiated Emission (30MHz-1GHz)



### Radiated Emission (1GHz-25GHz)





## Appendix 2 Photographs of Constructional Details

### EUT- Front View



### EUT- Top View



EUT- Side View



EUT- Rear View



EUT- Internal View



EUT- PCB View

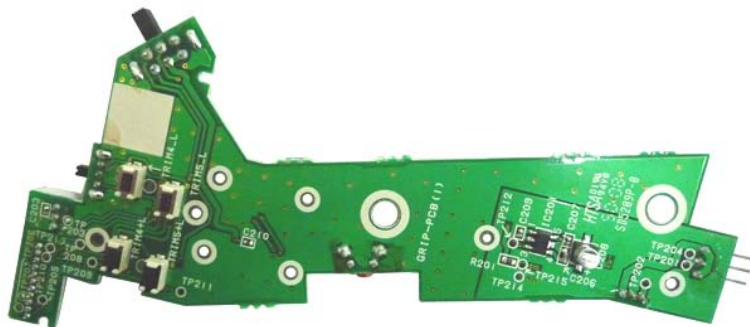
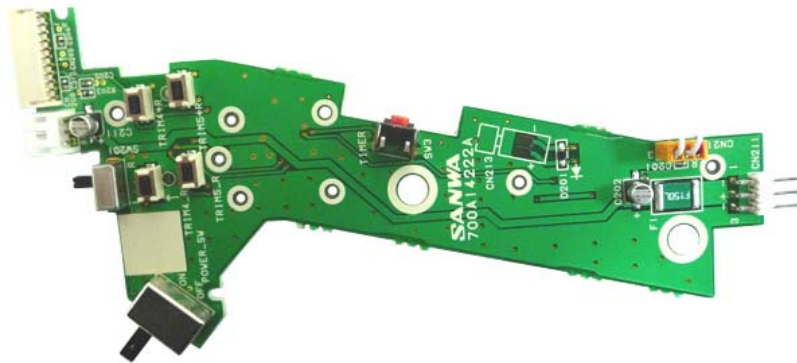
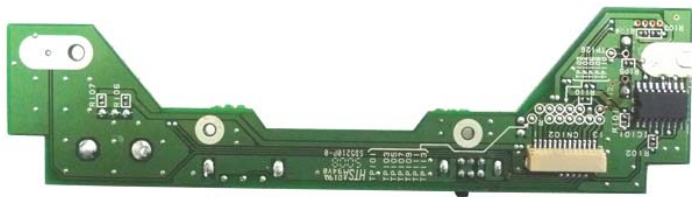

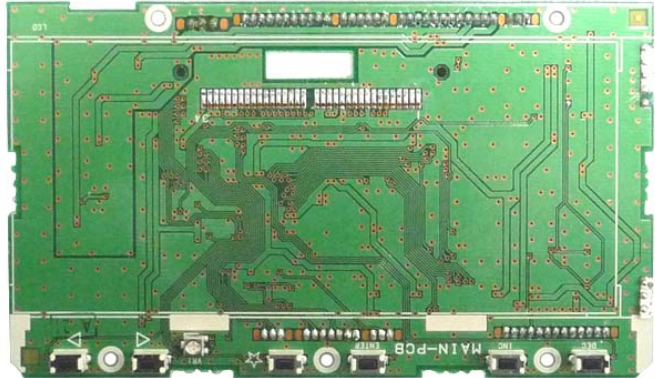
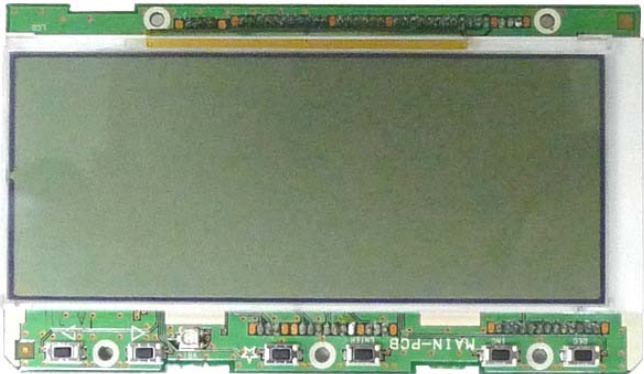

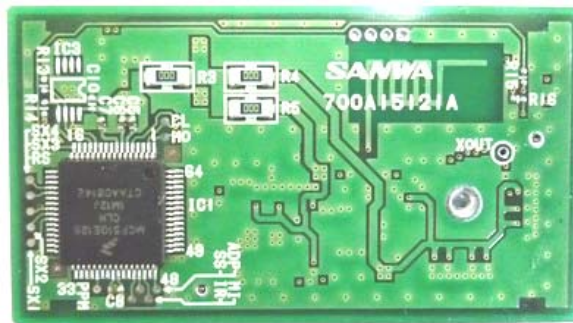
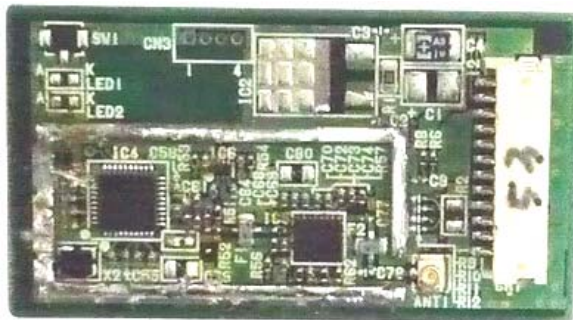

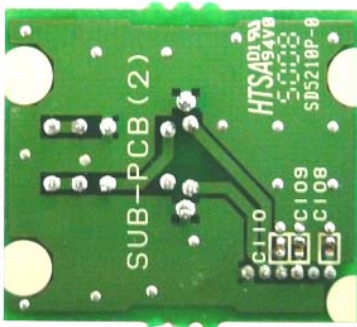
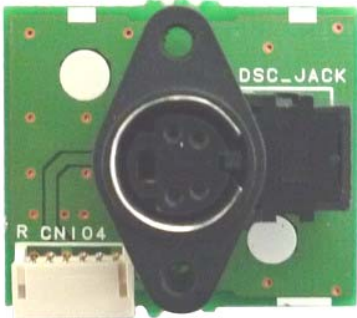



## Appendix 3 FCC/IC Label

**FCC ID: L73-90480**

**IC: 7377A-90480  
Model Number: 90480  
Sanwa Electronic Instrument Co., Ltd**

This device complies with Part 15 of the FCC Rules. Operation is subject to the following two conditions:

- (1) this device may not cause harmful interference, and
- (2) this device must accept any interference received, including interference that may cause undesired operation

The Label must not be a stick-on paper. The Label on these products must be permanently affixed to the product and readily visible at the time of purchase and must last the expected lifetime of the equipment not be readily detachable.

**Proposed FCC/IC Mark Location**

