

FCC Test Report

for

Radio Control

Trade Name : AIRTRONICS
Model Number : 90405
FCC ID : L73-90405
Report Number : RF- C450-0912-419
Date of Receipt : Jan. 26, 2010
Date of Report : July 30, 2010

Prepared for

Sanwa Electronic Instrument CO., LTD.

1-2-50, Yoshida Honmachi, Higashi-Osaka, Osaka 578-0982. Japan

Prepared by



Central Research Technology Co.
EMC Test Laboratory

No.11, Lane41, Fushuen St., Jungshan Chiu, Taipei, Taiwan, 104, R.O.C.



NVLAP LAB CODE 200575-0

This report shall not be reproduced, except in full, without the written approval of Central Research Technology Co.. It may be duplicated completely in its entirety for legal use with the permission of the applicant. It should not be used to claim product endorsement by NVLAP, NIST or any U.S. government agency. The test result in the report applies only to the sample tested.

Verification of Compliance

Equipment under Test : Radio Control
Trade Name : AIRTRONICS
Model No. : 90405
FCC ID : L73-90405
Manufacturer : Dongguan Dongkeng Sanwa Electro Device Factory
Applicant : Sanwa Electronic Instrument CO., LTD.
Address : 1-2-50, Yoshida Honmachi, Higashi-Osaka, Osaka 578-0982.
Japan
Applicable Standards : 47 CFR part 15, Subpart C
Date of Testing : Jan. 26 ~ 29, 2010
Deviation : N/A
Condition of Test Sample : Prototype

We, **Central Research Technology Co.**, hereby certify that one sample of the designated product was tested in our facility during the period mentioned above. The test records, data evaluation and Equipment Under Test (EUT) configurations shown in the present report are true and accurate representation of the measurements of the sample's RF characteristics under the conditions herein specified.

The test results show that the EUT as described in the present report is in compliance with the requirements set forth in the standards mentioned above and apply to the tested sample identified in the present report only. The test report shall not be reproduced, except in its entirety, without the written approval of Central Research Technology Co.

PREPARED BY : Cathy Chen, DATE : July 30, 2010
(Cathy Chen/ Technical Manager)

APPROVED BY : J. Y. Shih, DATE : July 30, 2010
(Tsun-Yu Shih/General Manager)

Contents

1	General Description	5
1.1	General Description of EUT.....	5
1.2	Test Methodology.....	5
1.3	Applied standards	6
1.4	The Support Units :	9
1.5	Layout of Setup	9
1.6	Test Capability	10
1.7	Measurement Uncertainty	12
2	Maximum Peak Output Power.....	13
2.1	Applied standard.....	13
2.2	Test Instruments	13
2.3	Measurement Procedure	14
2.4	Test configuration	14
2.5	Test Data	15
3	Band Edge	17
3.1	Applied standard.....	17
3.2	Test Instruments	17
3.3	Measurement Procedure	18
3.4	Test configuration	18
3.5	Test Data	19
4	Hopping Channel Carrier Frequencies Spacing	27
4.1	Applied standard.....	27
4.2	Test Instruments	27
4.3	Measurement Procedure	28
4.4	Test configuration	28
4.5	Test Data	29
5	Number of Hopping Channels.....	33
5.1	Applied standard.....	33
5.2	Test Instruments	33
5.3	Measurement Procedure	33
5.4	Test configuration	34
5.5	Test Data	34
6	Radiated Emission	35

6.1	Applied standard	35
6.2	Test Instruments	36
6.3	Measurement Procedure	37
6.4	Test configuration	38
6.5	Test Data	39
7	Dwell Time	51
7.1	Applied standard	51
7.2	Test Instruments	51
7.3	Measurement Procedure	52
7.4	Test configuration	52
7.5	Test Data	53
8	Antenna Requirement	54
8.1	Applied standard	54
8.2	Antenna Information	54
8.3	Result	54

Attachment 1 – Photographs of the Test Configurations

Attachment 2 –External Photographs of EUT

Attachment 3 –Internal Photographs of EUT

1 General Description

1.1 General Description of EUT

Equipment under Test : Radio Control
Model No. : 90405
Power in : 9Vdc by battery
Test Voltage : 9Vdc by battery
Manufacturer : Dongguan Dongkeng Sanwa Electro Device Factory
Channel Numbers : 51
Frequency Range : 2415~2465MHz
Chaneeel Bandwidth : 1MHz
Modulation : FHSS
Antenna Spec : Monopole type 1.1dBi
Function Description :

The EUT is used to transmit control command. Please refer to the user's manual for the details.

Perform the function of EUT continuously by executing the test program supplied by manufacturer.

1.2 Test Methodology

For this EUT, both conducted and radiated emissions were performed according to the procrdures illustrated in ANSI C63.4:2003 and other required measurements were illustrated in separate sections of this test report for detail.

Since the EUT is considered a potable unit, it was pre-tested on the positioned of each 3 axis. There for only the test data of the worse case- Z axiz was used for Radiated test.

1.3 Applied standards

(1) Conduction Emission Requirement

For intentional device, according to §15.207(a) line conduction emission limit is as below table.

Frequency of Emission (MHz)	Conducted Limit (dBuV)	
	Quasi-peak	Average
0.15 – 0.5	66 to 56*	56 to 46*
0.5 - 5	56	46
5 - 30	60	50

* Decreases with the logarithm of the frequency.

(2) Radiated Emission Requirement

For intentional device, according to §15.209, the general requirement of field strength of radiated emissions from intentional radiator at a distance of 3 meters shall not exceed the below table.

Frequency (MHz)	Measurement Distance (m)	Field Strength (uV/m)	Field Strength (dBuV/m)
30 – 88	3	100	40.0
88 – 216	3	150	43.5
216 – 960	3	200	46.0
960 – 1610	3	500	54.0
above 1610	3	500	54.0

Note 1- The lower limit shall apply at the transition frequency.

(3) Hopping Channel Carrier Frequencies Separation and 20dB Bandwidth

According to 15.247(a)(1), frequency hopping systems shall have hopping channel carrier frequencies separated by a minimum of 25 kHz or the 20 dB bandwidth of the hopping channel, whichever is greater.

(4) Dwell Time on Each Channel

According to 15.247(a)(1)(iii), frequency hopping systems in the 2400-2483.5 MHz band shall use at least 15 non-overlapping channels. The average time of occupancy on any channel shall not be greater than 0.4 seconds within a period of 0.4 seconds multiplied by the number of hopping channels employed.

(5) Maximun Peak Output Power

According to 15.247(b)(1), for frequency hopping systems operating in the 2400-2483.5 MHz band employing at least 75 hopping channels, and all frequency hopping systems in the 5725-5850 MHz band: 1 watt. For all other frequency hopping systems in the 2400-2483.5 MHz band: 0.125 watts.

(6) 100kHz Bandedge

According to 15.247(c), in any 100 kHz bandwidth outside the frequency band in which the spread spectrum or digitally modulated intentional radiator is operating, the radio frequency power that is produced by the intentional radiator shall be at least 20 dB below that in the 100 kHz bandwidth within the band that contains the highest level of the desired power, based on either an RF conducted or a radiated measurement. Attenuation below the general limits specified in Section 15.209(a) is not required. In addition, radiated emissions which fall in the restricted bands, as defined in Section 15.205(a), must also comply with the radiated emission limits specified in Section 15.209(a).

(7) Restricted Band

Frequency (MHz)	Frequency (MHz)	Frequency (MHz)	Frequency (MHz)
0.090 - 0.110	16.42 - 16.423	399.9 - 410	4.5 - 5.15
¹ 0.495 - 0.505	16.69475 - 16.69525	608 - 614	5.35 - 5.46
² 1735 - 2.1905	16.80425 - 16.80475	960 - 1240	7.25 - 7.75
4.125 - 4.128	25.5 - 25.67	1300 - 1427	8.025 - 8.5
4.17725 - 4.17775	37.5 - 38.25	1435 - 1626.5	9.0 - 9.2
4.20725 - 4.20775	73 - 74.6	1645.5 - 1646.5	9.3 - 9.5
6.215 - 6.218	74.8 - 75.2	1660 - 1710	10.6 - 12.7
6.26775 - 6.26825	108 - 121.94	1718.8 - 1722.2	13.25 - 13.4
6.31175 - 6.31225	123 - 138	2200 - 2300	14.47 - 14.5
8.291 - 8.294	149.9 - 150.05	2310 - 2390	15.35 - 16.2
8.362 - 8.366	156.52475 - 156.52525	2483.5 - 2500	17.7 - 21.4
8.37625 - 8.38675	156.7 - 156.9	2690 - 2900	22.01 - 23.12
8.41425 - 8.41475	162.0125 - 167.17	3260 - 3267	23.6 - 24.0
12.29 - 12.293	167.72 - 173.2	3332 - 3339	31.2 - 31.8
12.51975 - 12.52025	240 - 285	3345.8 - 3358	36.43 - 36.5
12.57675 - 12.57725	322 - 335.4	3600 - 4400	(2)
13.36 - 13.41			

¹ Until February 1, 1999, this restricted band shall be 0.490-0.510 MHz.

² Above 38.6

1.4 The Support Units :

No.	Unit	Model No./ Serial No.	Trade Name	Power Code	Supported by lab.
N/A	*	*	*	*	*

1.5 Layout of Setup



Connecting Cables :

No.	Cable	Length	Shielded	Core	Shielded Backshell	Supported by lab.	Note
N/A	*	*	*	*	*	*	*

1.6 Test Capability

Test Facility

The test facility used for evaluating the conformance of the EUT with each standard in the present report meets what required in CISPR16-1-4, CISPR16-2-3 and ANSI C63.4:2003.

Test Room	Type of Test Room	Descriptions
TR1	10m semi-anechoic chamber (23m×14m×9m)	Complying with the NSA requirements in documents CISPR 22 and ANSI C63.4:2003. For the radiated emission measurement.
TR11	3m semi-anechoic chamber (9m × 6m × 6m)	
TR13	Test Site	For the RF conducted emission measurement.
TR5	Shielding Room (8m×5m×4m)	For the conducted emission measurement.

Test Laboratory Competence Information

Central Research Technology Co. has been accredited / filed / authorized by the agencies listed in the following table.

Certificate	Nation	Agency	Code	Mark
Accreditation Certificate	USA	NVLAP	200575-0	ISO/IEC 17025
	R.O.C. (Taiwan)	TAF	0905	ISO/IEC 17025
	R.O.C. (Taiwan)	BSMI	SL2-IN-E-0033, SL2-IS-E-0033, SL2-R1/R2-E-0033, SL2-A1-E-0033	ISO/IEC 17025
Site Filing Document	USA	FCC	474046, TW1053	Test facility list & NSA Data
	Canada	IC	4699A-1,-3	Test facility list & NSA Data
	Japan	VCCI	R-1527,C-1609,T-131,T-1441, G-10	Test facility list & NSA Data
Authorization Certificate	Germany	TUV	10021687-2010	ISO/IEC 17025
	Norway	Nemko	ELA212	ISO/IEC 17025

The copy of each certificate can be downloaded from our web site: www.crc-lab.com

1.7 Measurement Uncertainty

The assessed measurement uncertainty with a suitable coverage factor K to ensure 95% confidence level for the normal distribution are shown as below, the values are less than U_{cispr} in table 1 of CISPR 16-4-2.

Test Item	Measurement Uncertainty	
Peak Output Power	1.1dB	
Radiated Emission: (30MHz~200MHz)	Horizontal 2.8dB ; Vertical 3.5 dB	
Radiated Emission: (200MHz~1GHz)	Horizontal 3.4dB ; Vertical 2.8dB	
Radiated Emission: (1GHz~18GHz)	Horizontal 2.5dB ; Vertical 2.4dB	
Radiated Emission: (18GHz~26.5GHz)	Horizontal 4.0dB ; Vertical 3.9dB	
Line Conducted Emission	ESH2-Z5	3.1dB
	ENV 4200	3.8dB

2 Maximum Peak Output Power

Result: Pass

2.1 Applied standard

According to 15.247(b)(1), for frequency hopping systems operating in the 2400-2483.5 MHz band employing at least 75 hopping channels, and all frequency hopping systems in the 5725-5850 MHz band: 1 watt. For all other frequency hopping systems in the 2400-2483.5 MHz band: 0.125 watts.

2.2 Test Instruments

Test Site and Equipment	Manufacturer	Model No./ Serial No.	Last Calibration Date	Calibration Due Date
Spectrum Analyzer	Agilent	E4405B/ MY45106706	2009/3/25	2010/3/24
Chamber	NA	TR13	NCR	NCR

Note:

1. The calibrations are traceable to NML/ROC.
2. NCR:No Calibration Required.

Instrument Setting

RBW	VBW	Detector	Trace	Comment
3MHz	3MHz	Peak	Maxhold	

Climatic Condition

Ambient Temperature : 24°C

Relative Humidity : 54%

2.3 Measurement Procedure

- a. The EUT was set up per the test configuration figured in the next section of this chapter to simulate the typical usage per the user's manual.
- b. A software provided by client enabled the EUT to transmit data at low, middle and high channel frequencies individually.
- c. According to FCC Public Notice DA00-705, Span = approximately 5 times the 20 dB bandwidth
 $RBW > \text{the } 20 \text{ dB bandwidth}$, $VBW \geq RBW$ to measure the peak output power and compare with the required limit.

2.4 Test configuration

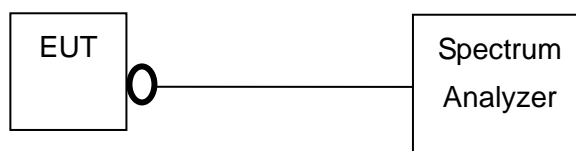

2.5 Test Data

Test Mode : Continuous Transmitting Tester : Bill

Operating Frequency (MHz)	Reading Data (dBm)	Correction Factor (dB)	Emission (dBm)	Limit (dBm)	Margin (dB)
2415	18.14	0.97	19.11	20.97	1.86
2442	18.73	0.98	19.71	20.97	1.26
2465	18.63	0.99	19.62	20.97	1.35

Note:

1. Correction Factor (dB) = Cable Loss
2. Emission (dBm) = Reading Data + Correction Factor
3. Margin (dB) = Limit – Emission

Low Channel (2415MHz)

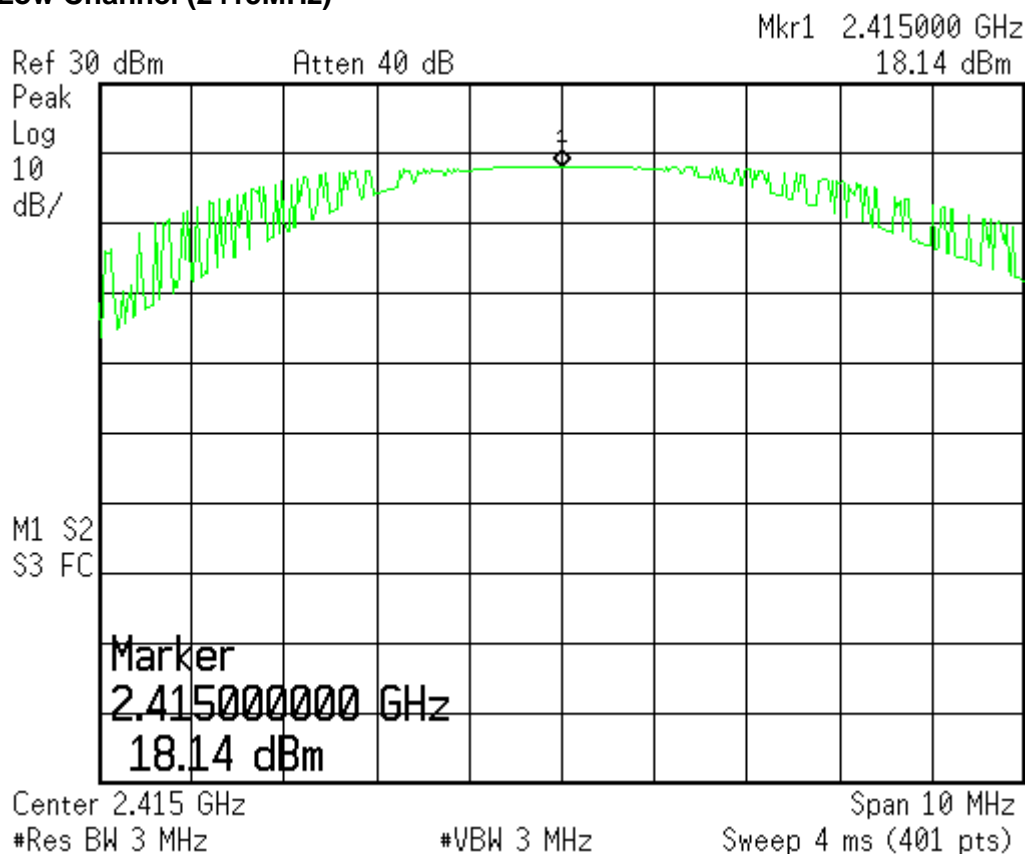

MiddleChannel (2442MHz)

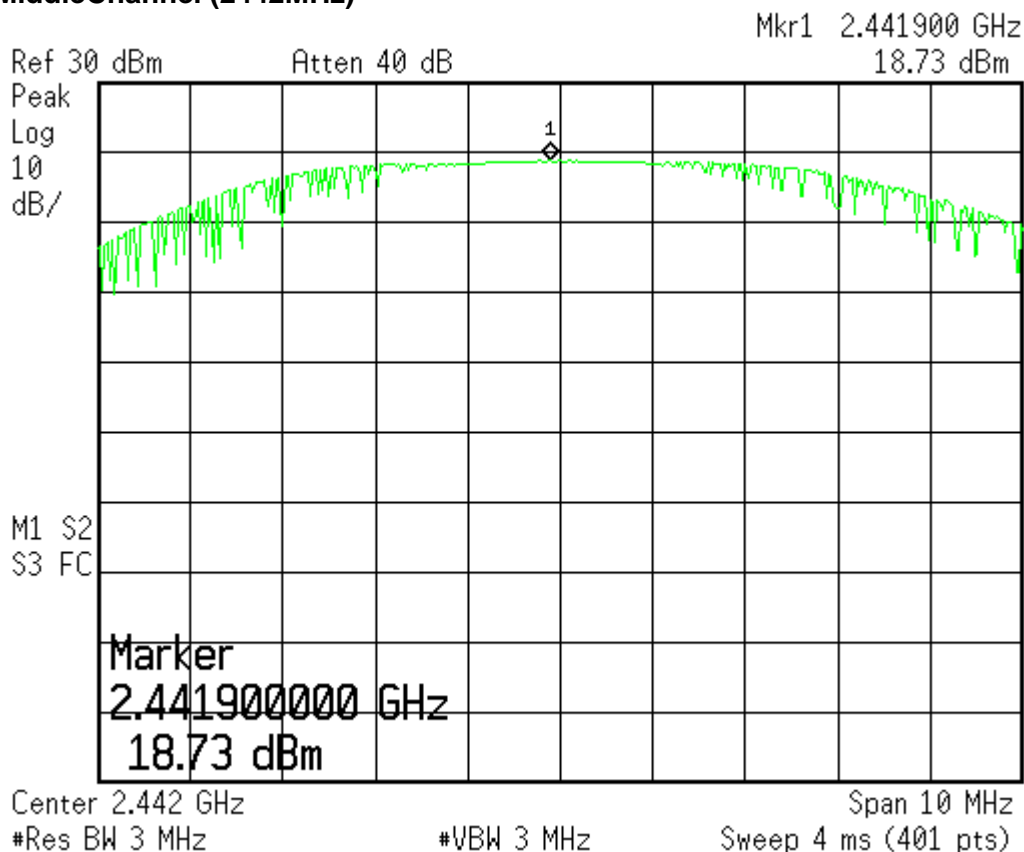

High Channel (2465MHz)

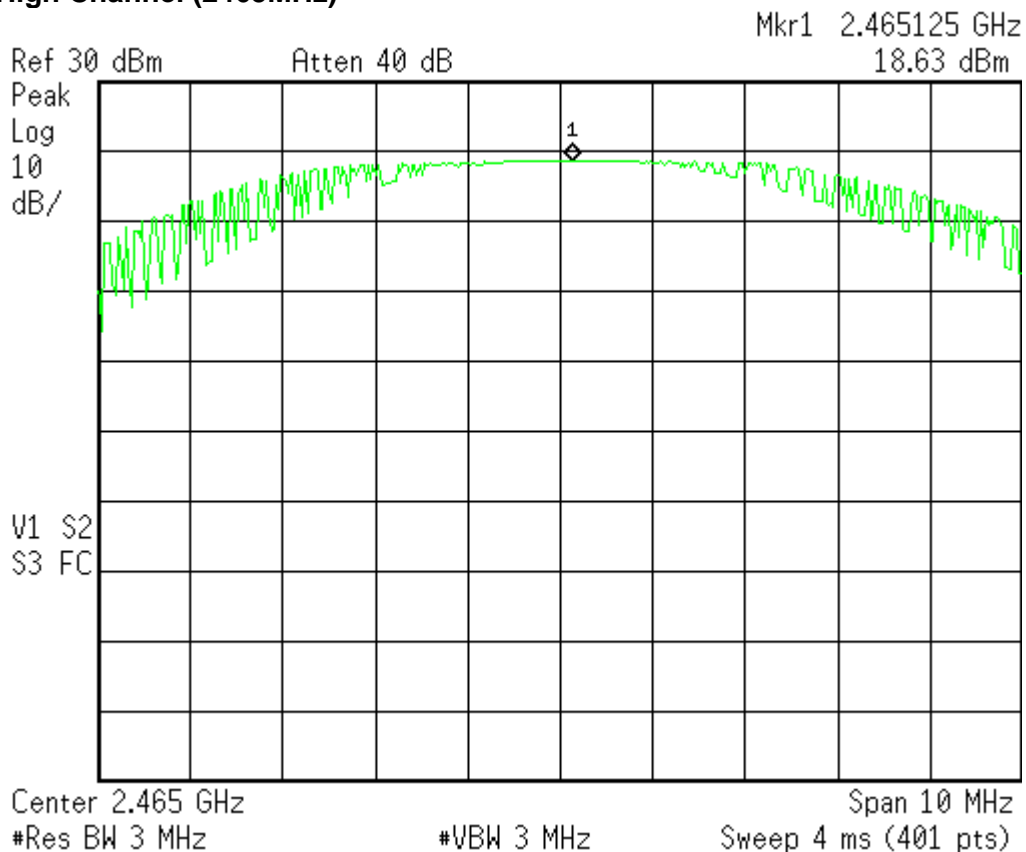

3 Band Edge

Result: Pass

3.1 Applied standard

According to 15.247(c), in any 100 kHz bandwidth outside the frequency band in which the spread spectrum or digitally modulated intentional radiator is operating, the radio frequency power that is produced by the intentional radiator shall be at least 20 dB below that in the 100 kHz bandwidth within the band that contains the highest level of the desired power, based on either an RF conducted or a radiated measurement. Attenuation below the general limits specified in Section 15.209(a) is not required. In addition, radiated emissions which fall in the restricted bands, as defined in Section 15.205(a), must also comply with the radiated emission limits specified in Section 15.209(a).

3.2 Test Instruments

Test Site and Equipment	Manufacturer	Model No./ Serial No.	Last Calibration Date	Calibration Due Date
Spectrum Analyzer	Agilent	E4407B/ MY45106795	2009/3/19	2010/3/18
Antenna	EMCO	3117/57416	2009/3/3	2010/3/2
Semi - anechoic Chamber	ETS. LINDGREN	TR11/ 906-A	2009/6/30	2010/6/29
PRE-AMPLIFIER	MITEQ	AFS6-02001800-35- 10P-6/949196	2009/9/11	2010/09/10

Note:

1. The calibrations are traceable to NML/ROC.
2. NCR:No Calibration Required.
3. The calibration date of the semi-anechoic chamber listed above is the date of NSA measurement.

Instrument Setting

RBW	VBW	Detector	Trace	Comment
100kHz	100kHz	Peak	Maxhold	100kHz Bandedge
1MHz	3MHz	Peak	Maxhold	Bandedge Peak
1MHz	10Hz	Peak	Maxhold	Bandedge Average

Climatic Condition

Ambient Temperature : 24°C

Relative Humidity : 54%

3.3 Measurement Procedure

- a. The EUT was set up per the test configuration figured in the next section of this chapter to simulate the typical usage per the user’s manual.
- b. A software provided by client enabled the EUT to transmit data at at lowest and highest channel frequencies individually.
- c. According FCC Public Notice DA00-705, Span = wide enough to capture the peak level of the emission operating on the channel closest to the bandedge, $RBW \geq 1\%$ of the span , $VBW \geq RBW$, to measure the band edge and compare with the required limit.

3.4 Test configuration

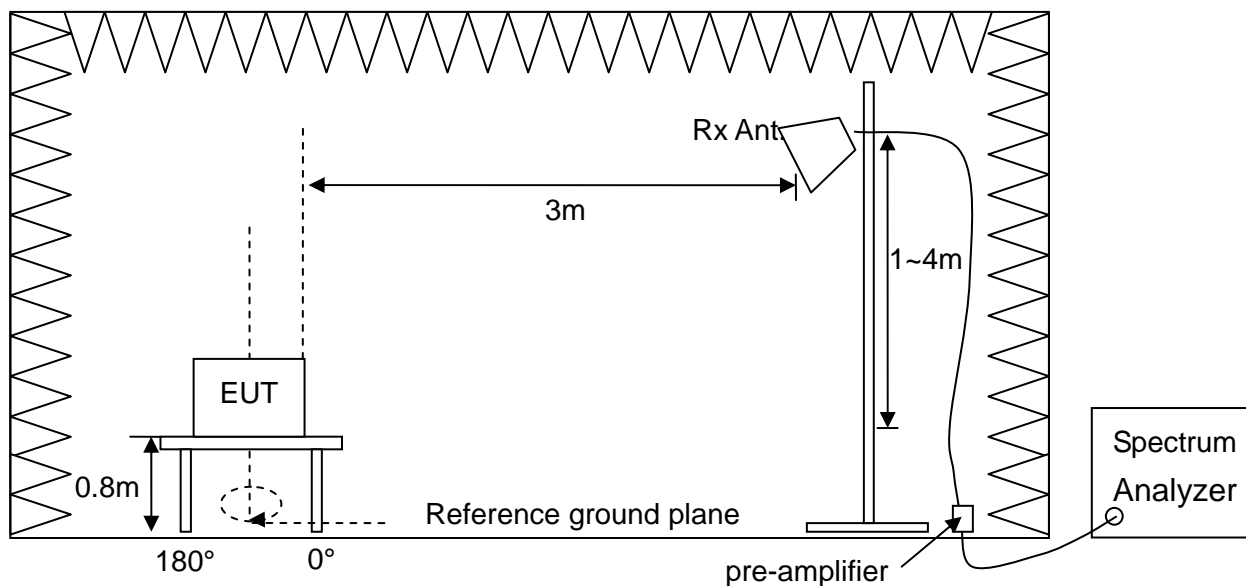

3.5 Test Data

100kHz Bandedge Measurement

Test Mode : Continuous Transmitting Tester : Bill

Operating Frequency (MHz)	Antenna Polarization	Frequency (MHz)	Main Frequency Emission Data (dBuV/m)	Bandedge Emission Data (dBuV/m)	attenuation (dB)	Limit (dB)	Margin (dB)
2415	V	2394.10	90.73	43.54	47.19	20	27.19
2415	H	2397.10	90.87	37.86	53.01	20	33.01
2465	V	2494.60	90.36	44.70	45.66	20	25.66
2465	H	2501.80	90.75	37.42	53.33	20	33.33

Note:

1. Attenuation (dB) = Main Frequency Emission Data –Bandedge Emission Data
2. Margin(dB) = Limit – Emission

Low Channel (2415MHz) - Vertical

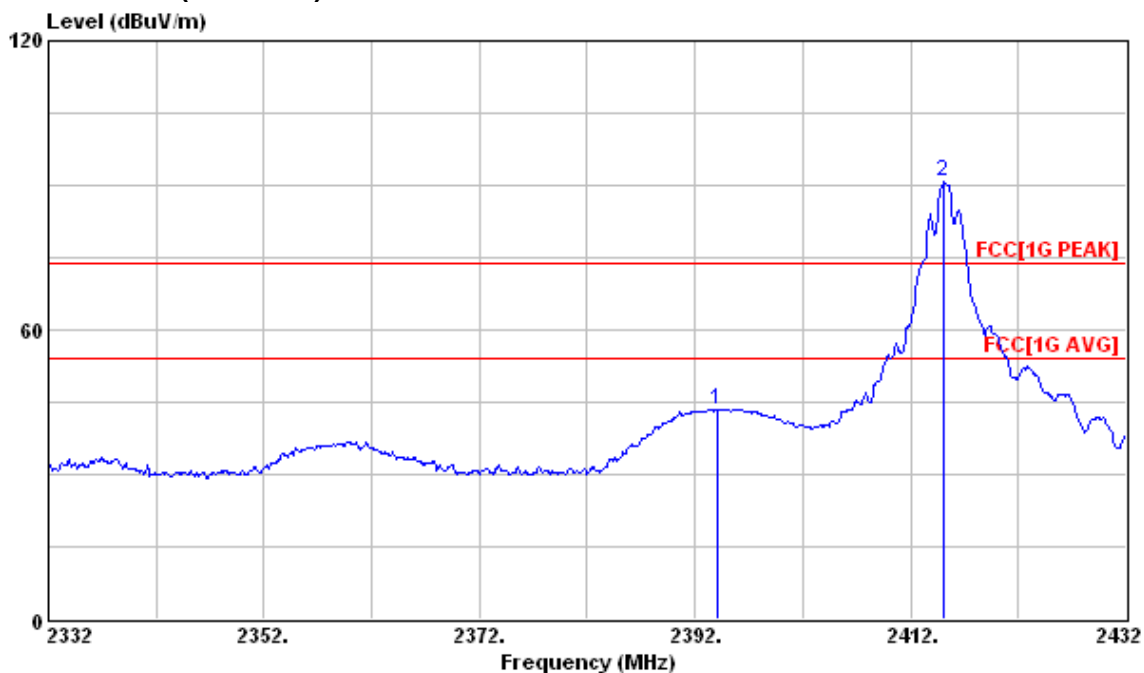

Low Channel (2415MHz) - Horizontal

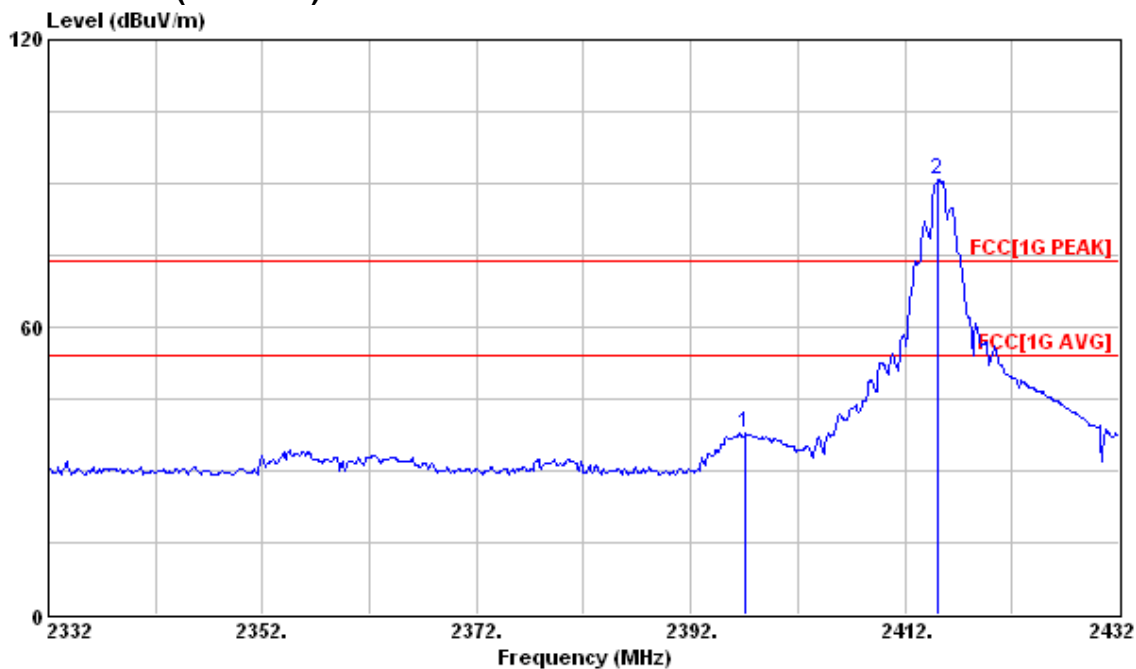

High Channel (2465MHz) - Vertical

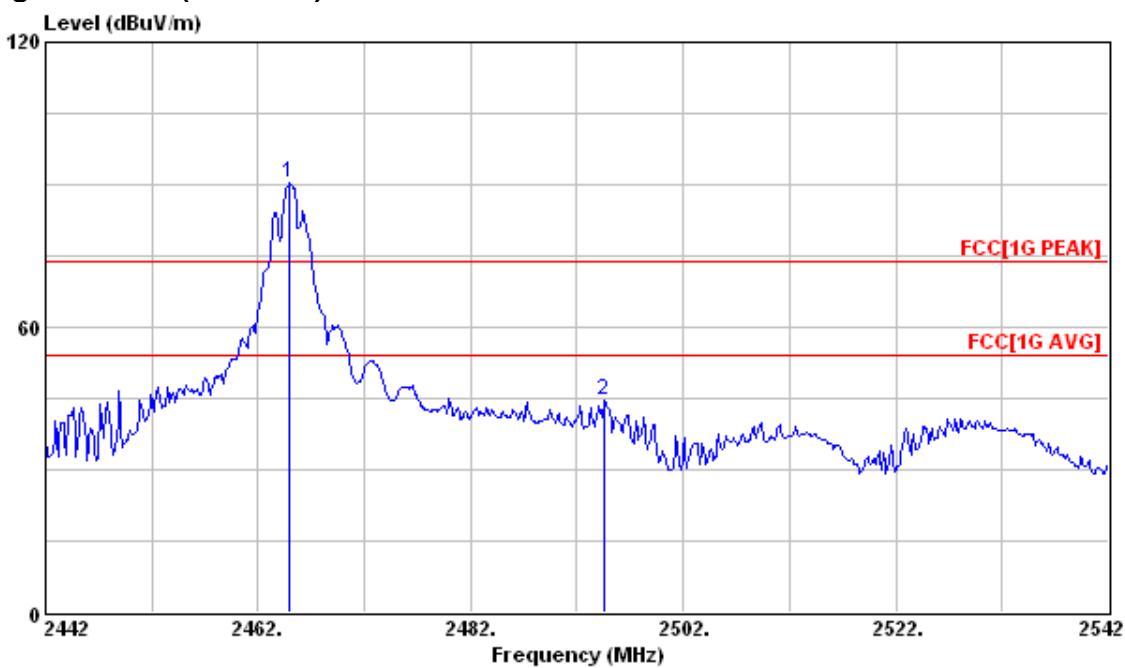

High Channel (2465MHz) - Horizontal

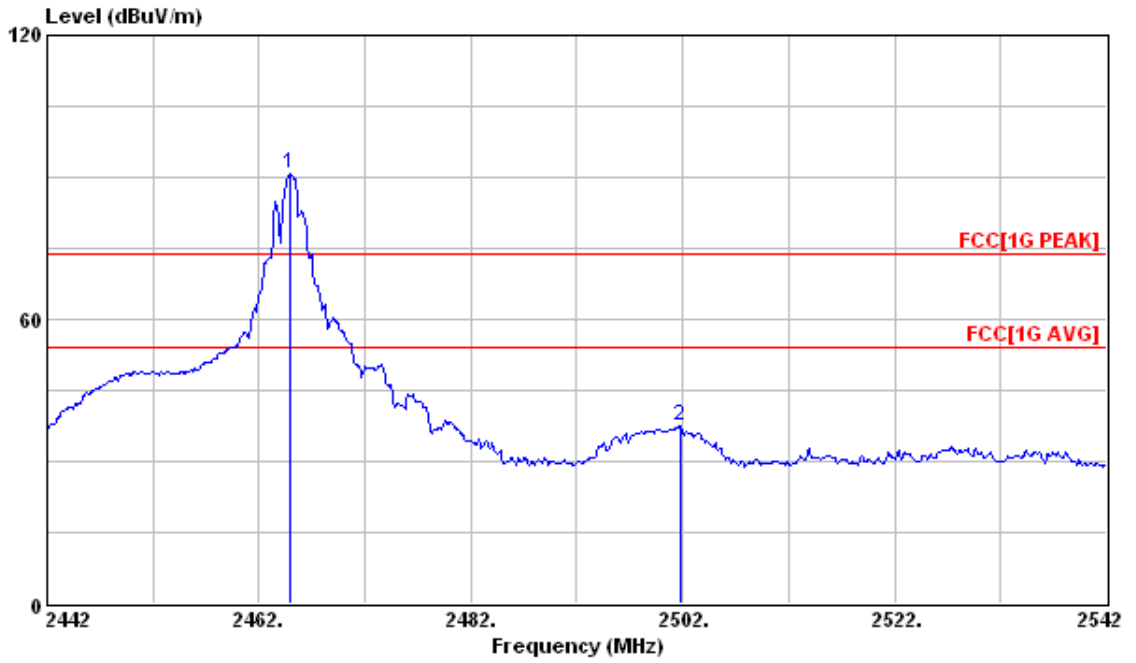

Radiated Measurement

Test Mode : Continuous Transmitting

Tester : Bill

Operating Frequency (MHz)	Antenna Polarization	Frequency (MHz)	Reading Data (dBuV)		Correction Factor (dB/m)	Emission (dBuV/m)		Limit (dBuV/m)		Margin (dB)	
			PK.	AV.		PK.	AV.	PK.	AV.	PK.	AV.
2415	V	2390.00	92.51	63.39	-28.40	64.11	34.99	74	54	9.89	19.01
2415	H	2378.50	84.38	63.51	-28.44	55.94	35.07	74	54	18.06	18.93
2465	V	2489.05	91.01	62.12	-28.40	62.61	33.72	74	54	11.39	20.28
2465	H	2486.65	88.25	62.13	-28.40	59.85	33.73	74	54	14.15	20.27

Note:

1. Correction Factor (dB/m) = Cable Loss + Antenna Factor – Gain of Pre-amplifier
2. Emission (dBuV/m) = Reading Data + Correction Factor
3. Margin(dB) = Limit – Emission

Low Channel (2415MHz), V Polarization – PK.



Low Channel (2415MHz), V Polarization – AV.

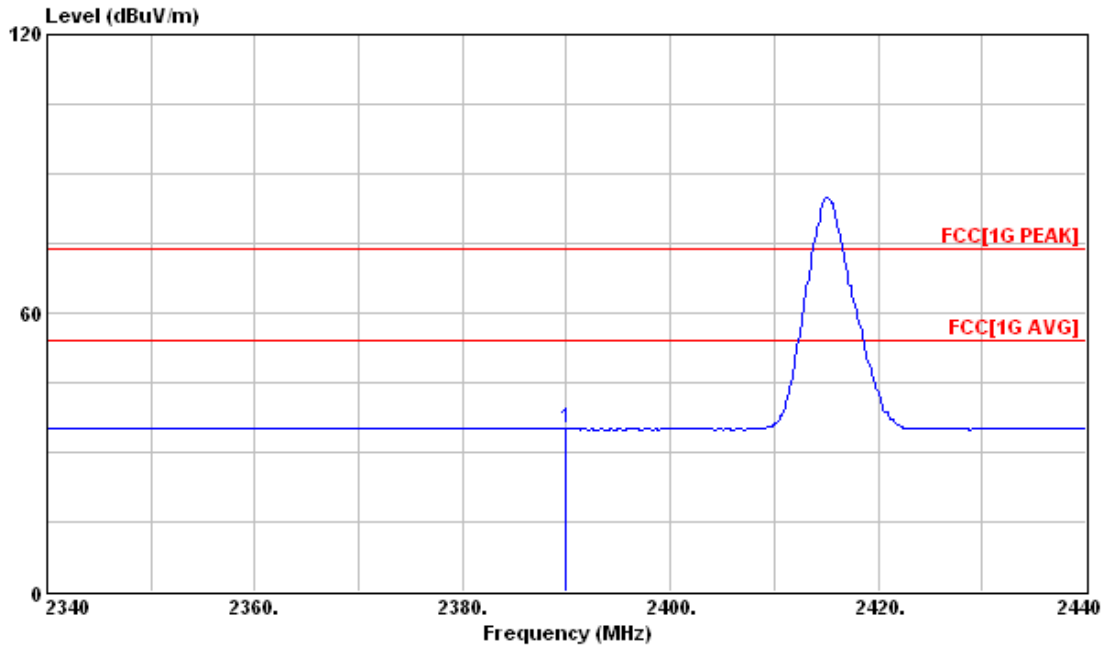

Low Channel (2415MHz), H Polarization – PK.

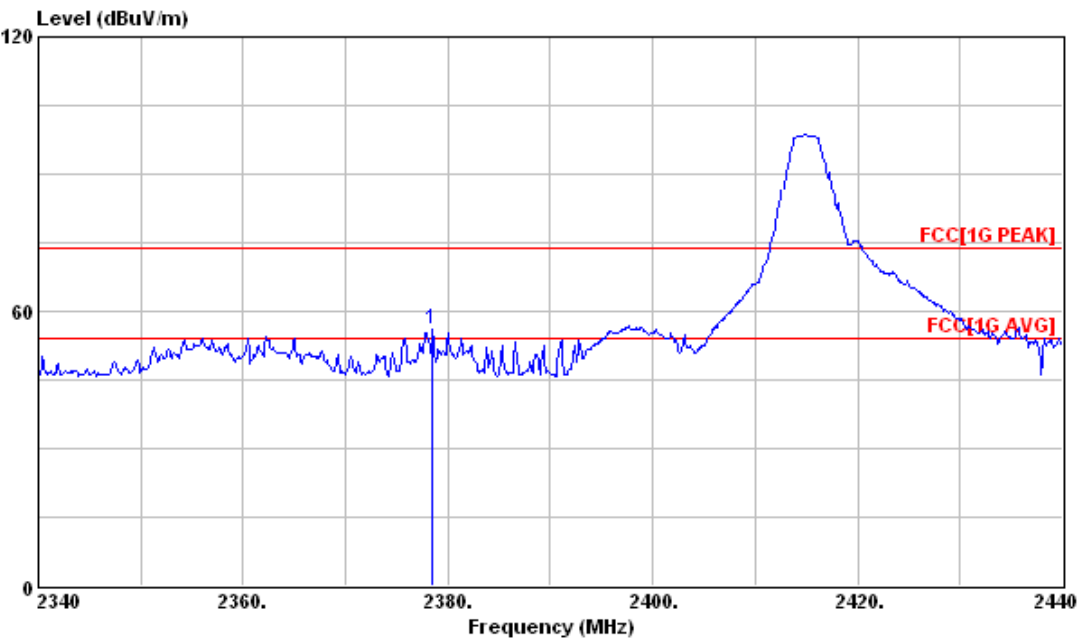

Low Channel (2415MHz), H Polarization – AV.

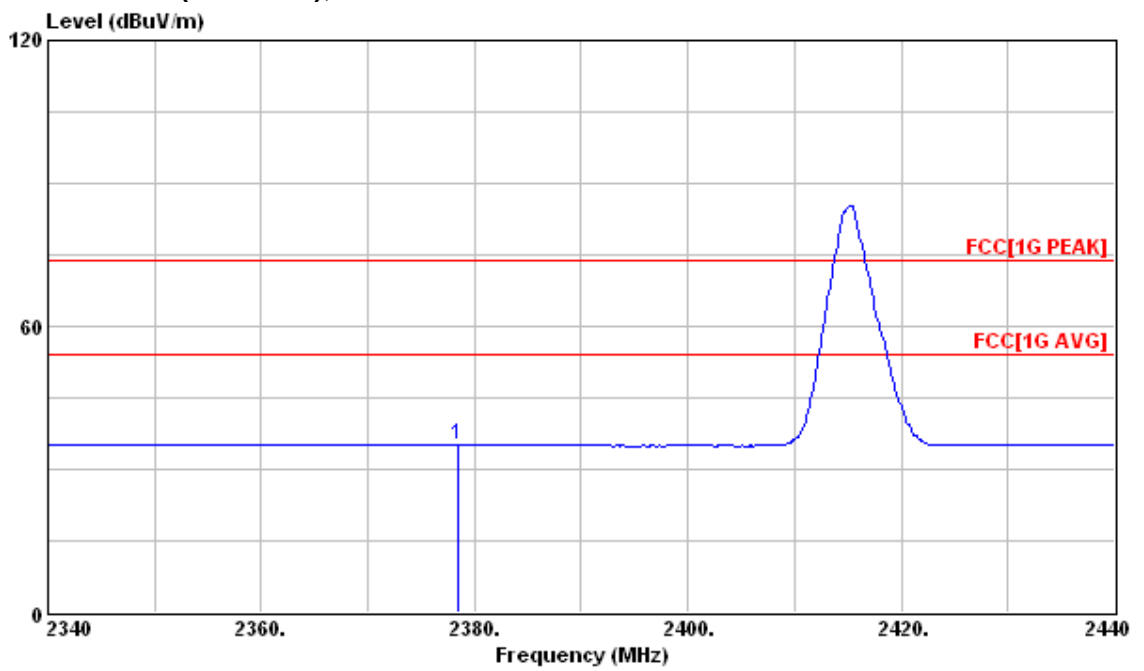

High Channel (2465MHz), V Polarization – PK.

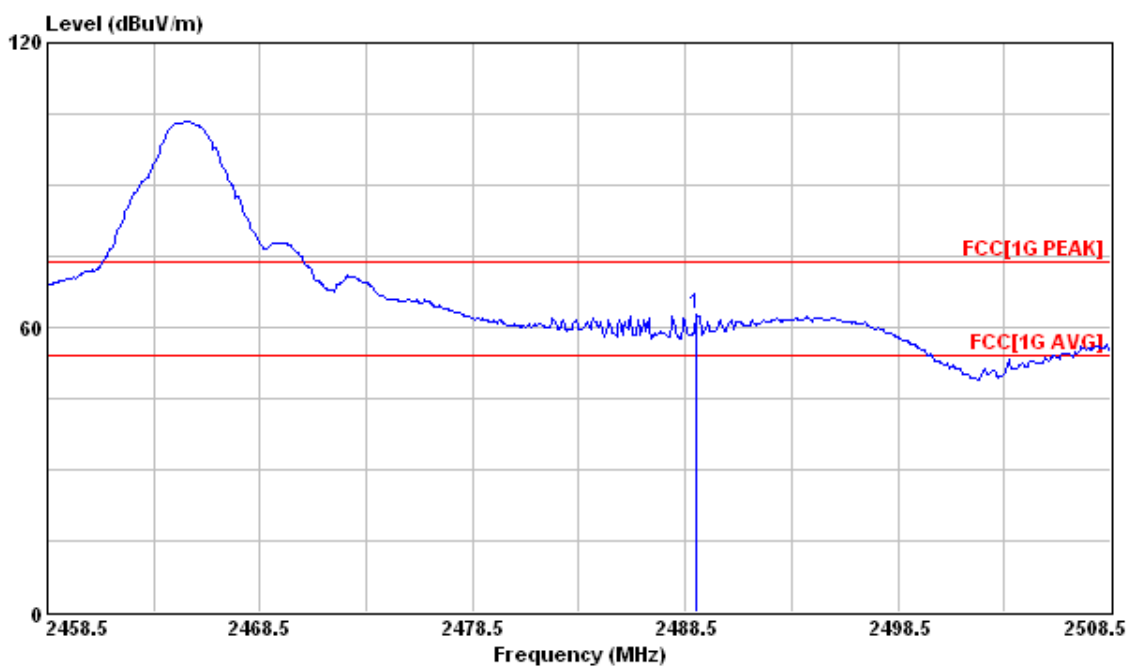

High Channel (2465MHz), V Polarization – AV.

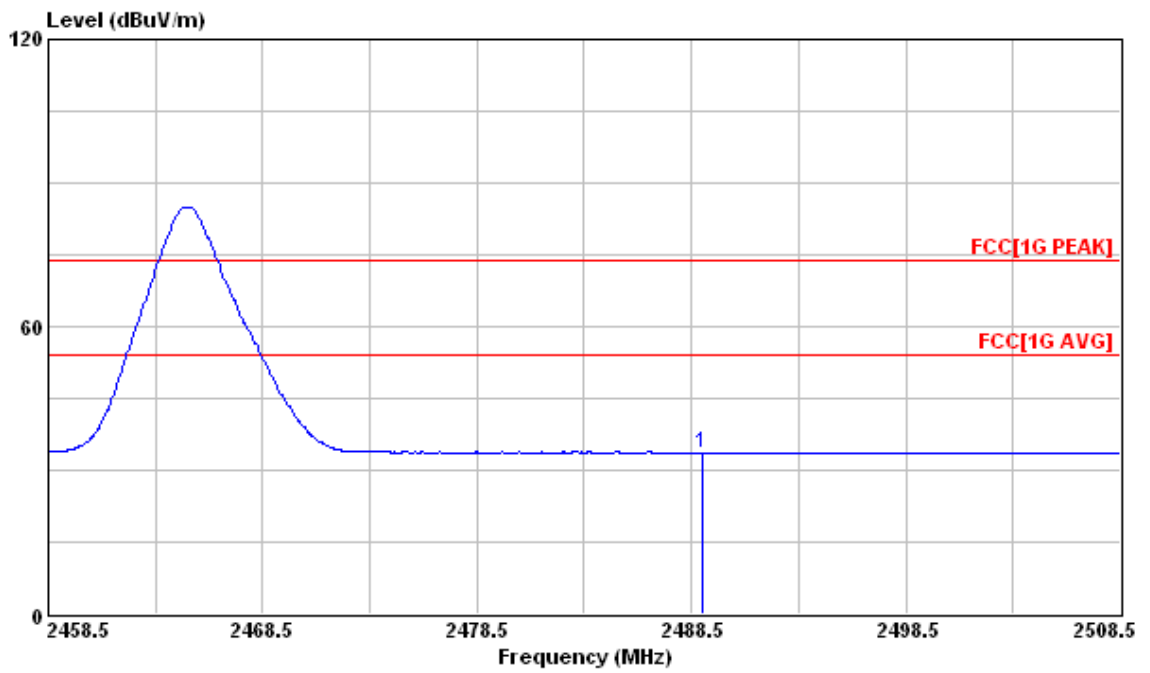

High Channel (2465MHz), H Polarization – PK.

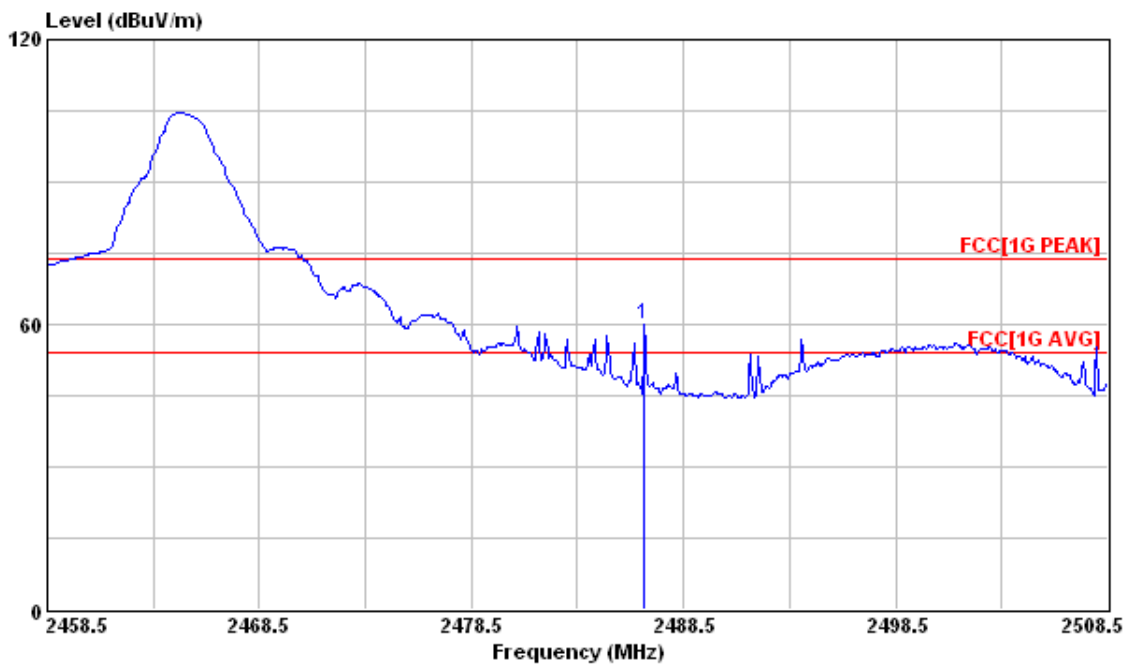

High Channel (2465MHz), H Polarization – AV.

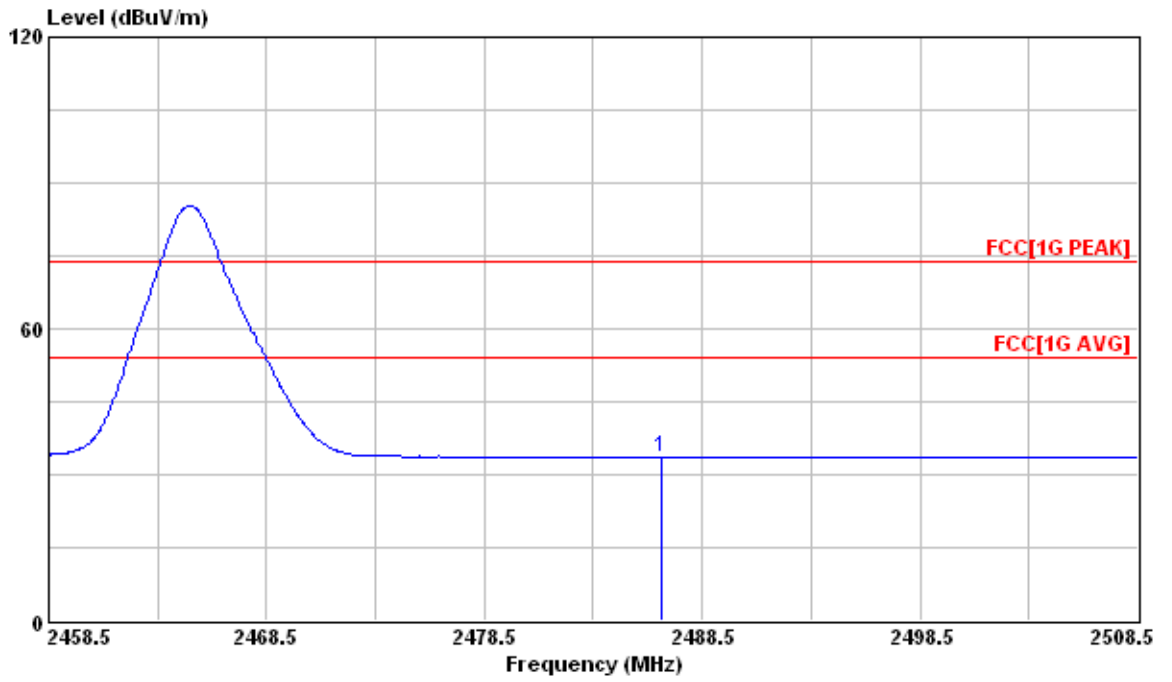

4 Hopping Channel Carrier Frequencies Spacing

Result: Pass

4.1 Applied standard

According to 15.247(a)(1), frequency hopping systems shall have hopping channel carrier frequencies separated by a minimum of 25 kHz or two-thirds of the 20 dB bandwidth of the hopping channel, whichever is greater.

4.2 Test Instruments

Test Site and Equipment	Manufacturer	Model No. /Serial No.	Last Calibration Date	Calibration Due Date
Spectrum Analyzer	Agilent	E4405B/ MY45106706	2009/3/25	2010/3/24
Chamber	NA	TR13	NCR	NCR

Note:

1. The calibrations are traceable to NML/ROC.
2. NCR:No Calibration Required.

Instrument Setting

RBW	VBW	Detector	Trace	Comment
100kHz	300kHz	Peak	Maxhold	20dB Bandwidth
100kHz	300kHz	Peak	Maxhold	Carrier Spacing

Climatic Condition

Ambient Temperature : 22°C

Relative Humidity :60%

4.3 Measurement Procedure

- a. The EUT was set up per the test configuration figured in the next section of this chapter to simulate the typical usage per the user's manual.
- b. A software provided by client enabled the EUT to transmit data at lowest, middle and highest channel frequencies individually.
- c. Measurement the 20dB bandwidth and compare with 25kHz to determine the required carrier frequency spacing.
- d. According to FCC Public Notice DA00-705, Span = approximately 2 to 3 times the 20 dB bandwidth, RBW \geq 1% of the 20 dB bandwidth, VBW \geq RBW to measure 20dB bandwidth
- e. According to FCC Public Notice DA00-705, Span = wide enough to capture the peaks of two adjacent channels , Resolution Bandwidth (RBW) \geq 1% of the span, Video Bandwidth (VBW) \geq RBW to measure frequency spacing and compare with the required limit.

4.4 Test configuration

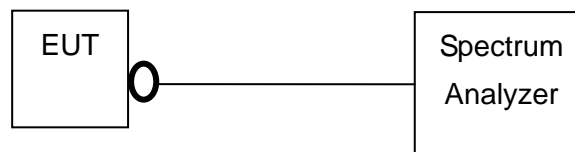

4.5 Test Data

20dB bandwidth

Test Mode : Continuous Transmitting Tester : Bill

Operating Frequency (MHz)	20dB Bandwidth (kHz)
2415	968
2442	980
2465	966

Measured 20dB bandwidth is 980 kHz. According to 15.247(a)(1), hopping channel carrier frequencies spacing should be greater than $2/3 \times 980 = 654\text{kHz}$.

Low Channel (2415MHz)

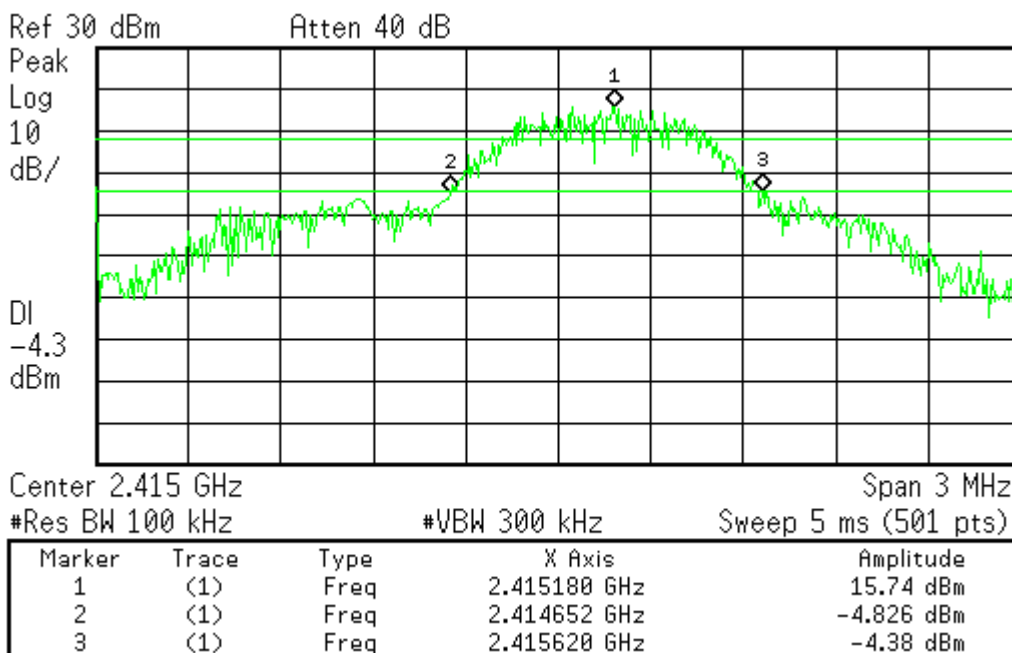

Middle Channel (2442MHz)

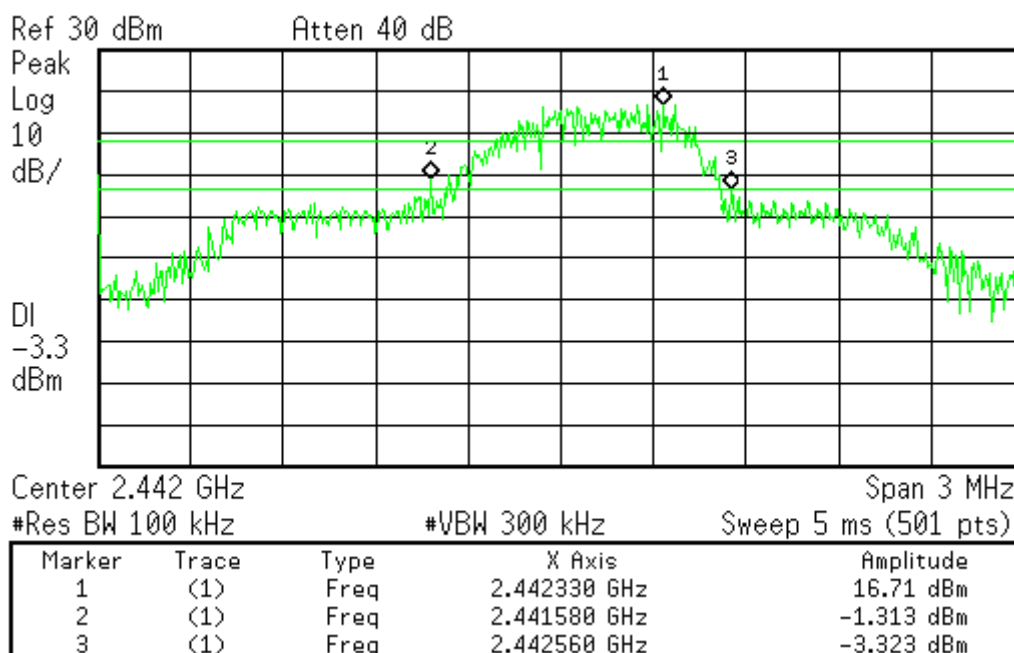

High Channel (2465MHz)

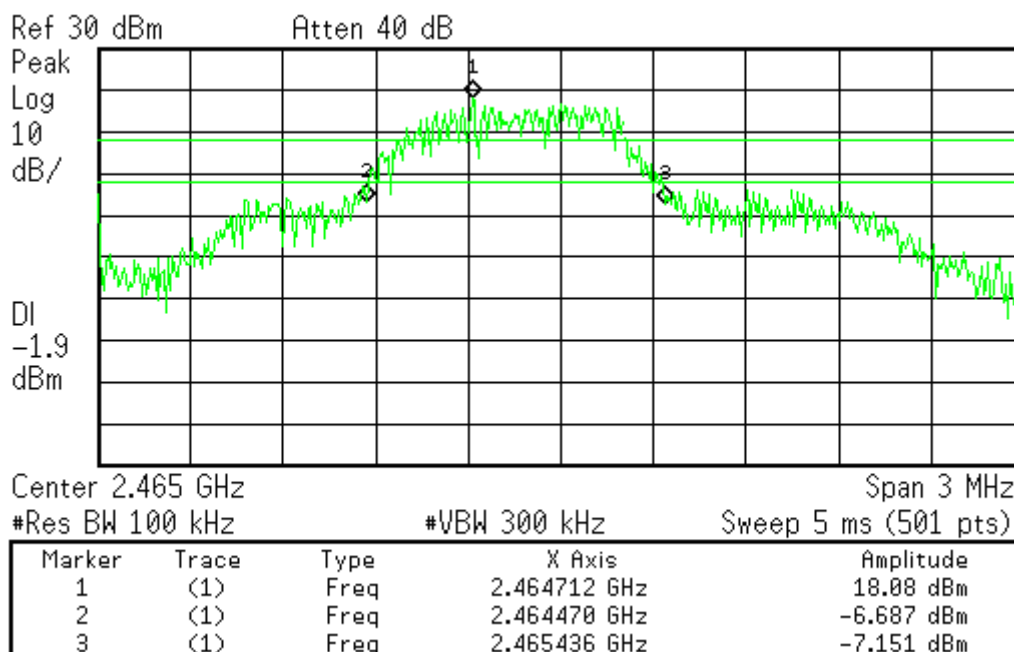

Hopping Channel Carrier Frequencies spacing

Test Mode : Continuous Transmitting

Tester : Bill

Operating Frequency (MHz)	Carrier Spacing (kHz)	Limit (kHz)	Margin (kHz)
2415	1000	654	346
2442	1000	654	346
2465	1000	654	346

Low Channel (2415MHz)

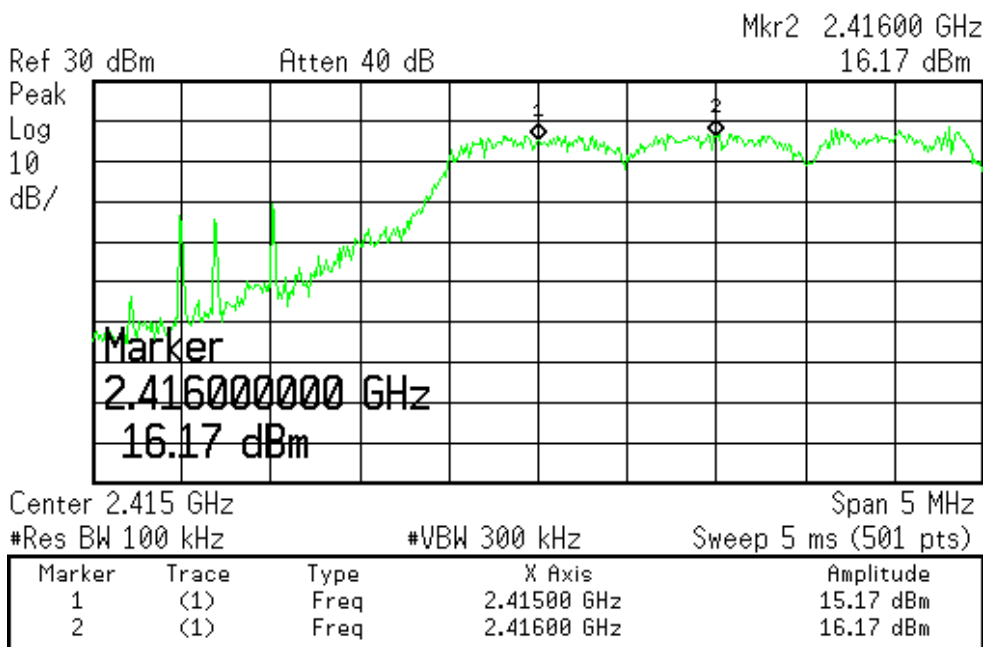

Middle Channel (2442MHz)

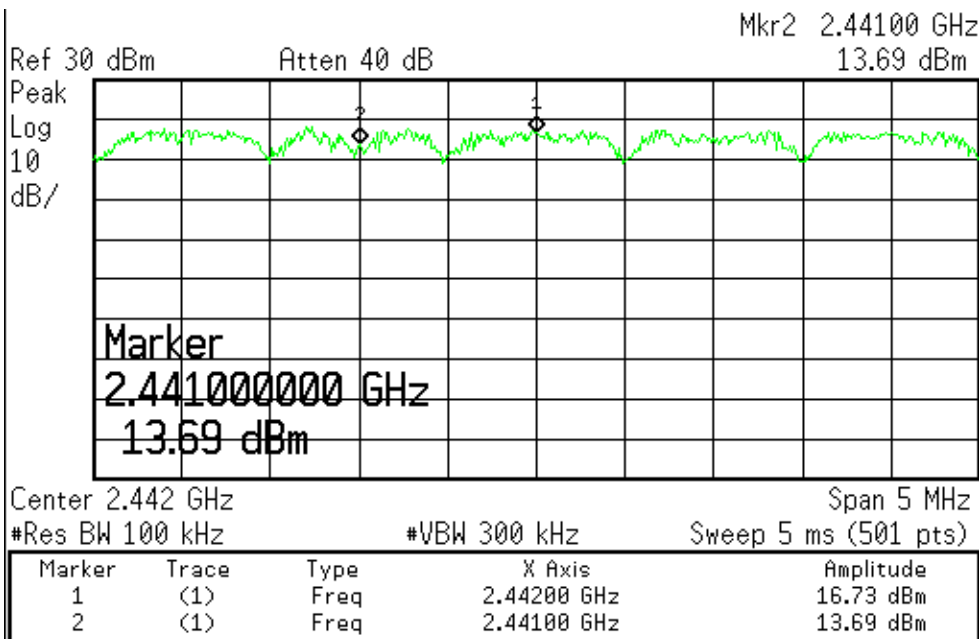

High Channel (2465MHz)

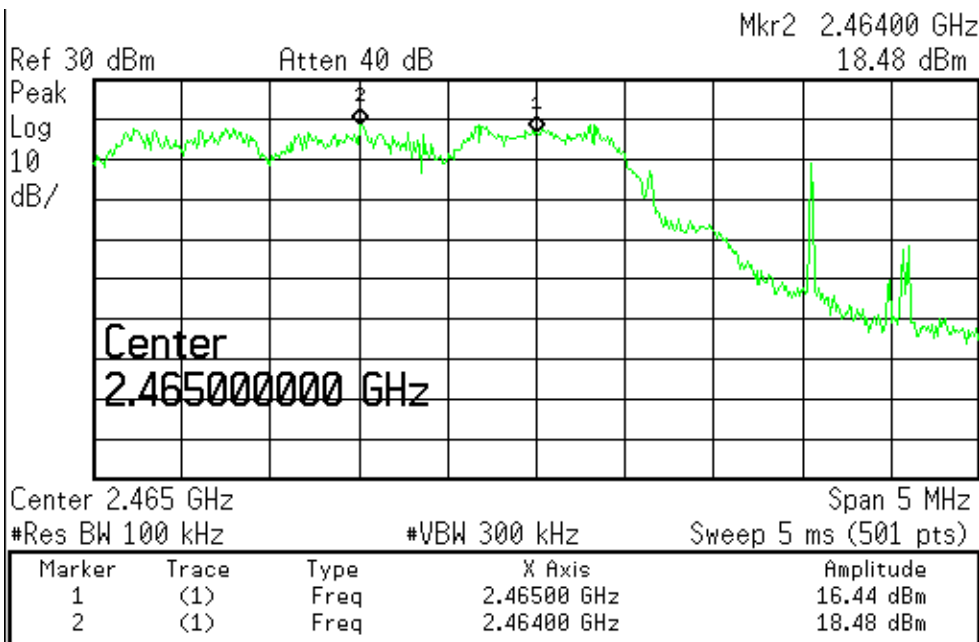

5 Number of Hopping Channels

Result: 51 Hopping Channels

5.1 Applied standard

According to 15.247(b)(1), for frequency hopping systems operating in the 2400-2483.5 MHz band employing at least 75 hopping channels, and all frequency hopping systems in the 5725-5850 MHz band: 1 watt. For all other frequency hopping systems in the 2400-2483.5 MHz band: 0.125 watts.

5.2 Test Instruments

See section 4.2

Instrument Setting

RBW	VBW	Detector	Trace	Comment
100kHz	300kHz	Peak	Maxhold	

Climatic Condition

Ambient Temperature : 22°C

Relative Humidity :60%

5.3 Measurement Procedure

- a. The EUT was set up per the test configuration figured in the next section of this chapter to simulate the typical usage per the user's manual.
- b. A software provided by client enabled the EUT to transmit data at all channels.
- c. According to FCC Public Notice DA00-705, Span = the frequency band of operation , $RBW \geq 1\%$ of the span , $VBW \geq RBW$ to measure number of hopping channels and compare with the required limit.

5.4 Test configuration

See section 4.4.

5.5 Test Data

Test Mode : Continuous Transmitting

Tester : Bill

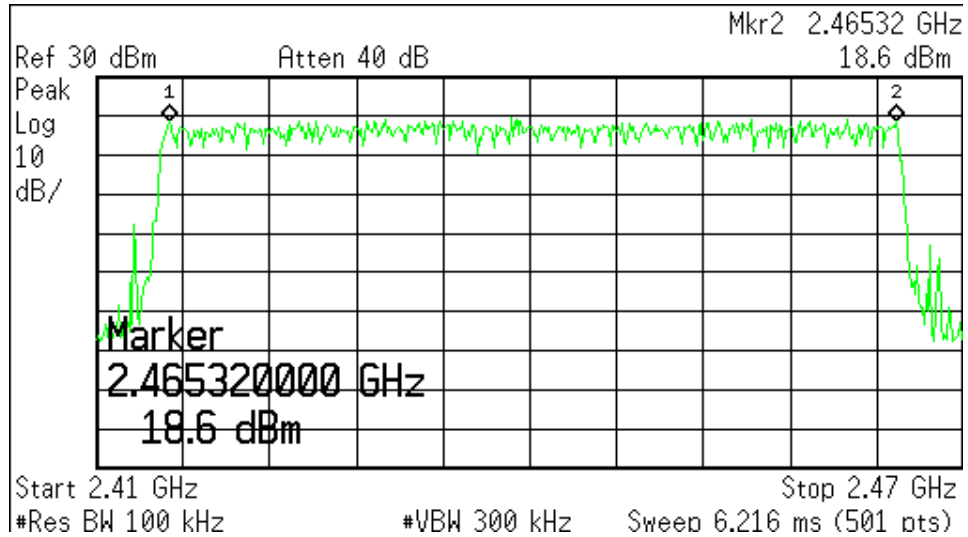

6 Radiated Emission

Result: Pass

6.1 Applied standard

According to 15.247(c), in any 100 kHz bandwidth outside the frequency band in which the spread spectrum or digitally modulated intentional radiator is operating, the radio frequency power that is produced by the intentional radiator shall be at least 20 dB below that in the 100 kHz bandwidth within the band that contains the highest level of the desired power, based on either an RF conducted or a radiated measurement. Attenuation below the general limits specified in Section 15.209(a) is not required. In addition, radiated emissions which fall in the restricted bands, as defined in Section 15.205(a), must also comply with the radiated emission limits specified in Section 15.209(a).

6.2 Test Instruments

Test Site and Equipment	Manufacturer	Model No./ Serial No.	Last Calibration Date	Calibration Due Date
Test Receiver	R&S	ESCI/100019	2009/11/30	2010/11/29
Spectrum Analyzer	Agilent	E4407B/ MY45106795	2009/3/19	2010/3/18
Broadband Antenna	EMCO	3142C/52088	2009/7/22	2010/7/21
Antenna	EMCO	3117/57408	2009/3/3	2010/3/2
Antenna	EMCO	3116/58959	2008/2/14	2010/2/2
PRE-AMPLIFIER	MITEQ	AFS6-02001800-35- 10P-6/949196	2009/9/11	2010/09/10
Pre-amplifier	MITEQ	JS4-00101800-28-1 0P/1498978	2009/11/9	2010/11/8
Pre-amplifier	Mini Circuit	ZKL-2/004	2009/2/10	2010/2/9
Semi - anechoic Chamber	ETS. LINDGREN	TR11/ 906-A	2009/6/30	2010/6/29

Note:

1. The calibrations are traceable to NML/ROC.
2. NCR : No Calibration Required.
3. The calibration date of the semi-anechoic chamber listed above is the date of NSA measurement.

Instrument Setting

RBW	VBW	Detector	Trace	Comment
120kHz	N/A	Quasi-Peak	Maxhold	Below 1GHz
1MHz	3MHz	Peak	Maxhold	Above 1GHz, Peak
1MHz	10Hz	Peak	Maxhold	Above 1GHz, Average

Climatic Condition

Ambient Temperature : 24°C

Relative Humidity :53%

6.3 Measurement Procedure

- a. The EUT was set up per the test configuration figured in the next section of this chapter to simulate the typical usage per the user's manual.
- b. A software provided by client enabled the EUT to transmit and receive data at lowest, middle and highest channel frequencies individually.
- c. If the EUT is tabletop equipment, it was placed on a wooden table with a height of 0.8 meters above the reference ground plane in the semi-anechoic chamber. If the EUT is floor-standing equipment, it was placed on a non-conducted support with a height of 12 millimeters above the reference ground plane in the semi-anechoic chamber.
- d. The EUT was set 3m away from the interference receiving antenna.
- e. Rapidly sweep the signal in the test frequency range by using the spectrum through the Maximum-peak detector.
- f. According to FCC Public Notice DA00-705 to set the spectrum analyzer.
- g. Rotate the EUT from 0° to 360° and position the receiving antenna at heights from 1 to 4 meters above the reference ground plane continuously to determine at least six frequencies associated with higher emission levels and record them.
- h. The beamwidth of receiving horn antenna should keep covering EUT when the receiving horn antenna height varied.
- i. Then measure each frequency found from step f. by using the spectrum with rotating the EUT and positioning the receiving antenna height to determine the maximum level.
- j. For measurement of frequency below 1000MHz, set the receiver detector to be Quasi-Peak per CISPR 16-1 to find out the maximum level occurred.
- k. For measurement of frequency above 1000MHz, set the spectrum detector to be Peak or Average to find out the maximum level occurred, if any.
- l. Record frequency, azimuth angle of the turntable, height, and polarization of the receiving antenna and compare the maximum level with the required limit.
- m. Change the receiving antenna to another polarization to measure radiated emission by following step e. to k. again.
- n. If the peak emission level below 1000MHz measured from step j. is 4dB lower than the limit specified, then the emission values presented will be the peak value only. Otherwise, accurate Q.P. value will be measured and presented.
- o. If the peak emission level above 1000MHz measured from step k. is 20dB lower than the limit specified, then the emission values presented will be the peak value only. Otherwise, accurate A.V. value will be measured and presented.

6.4 Test configuration

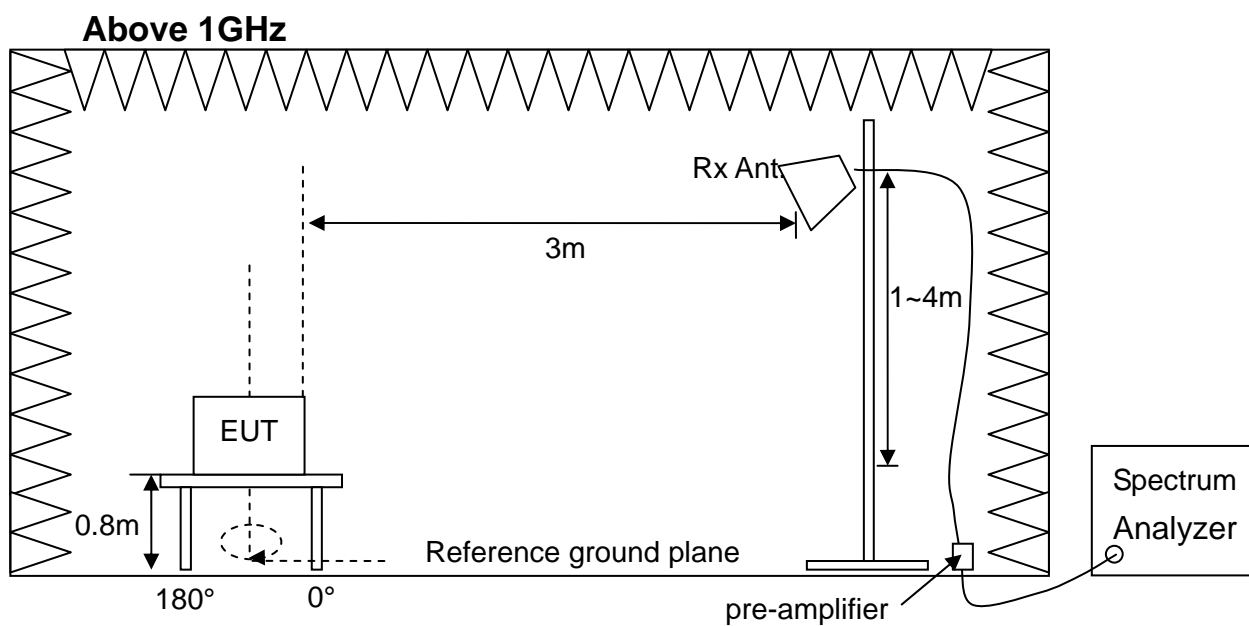
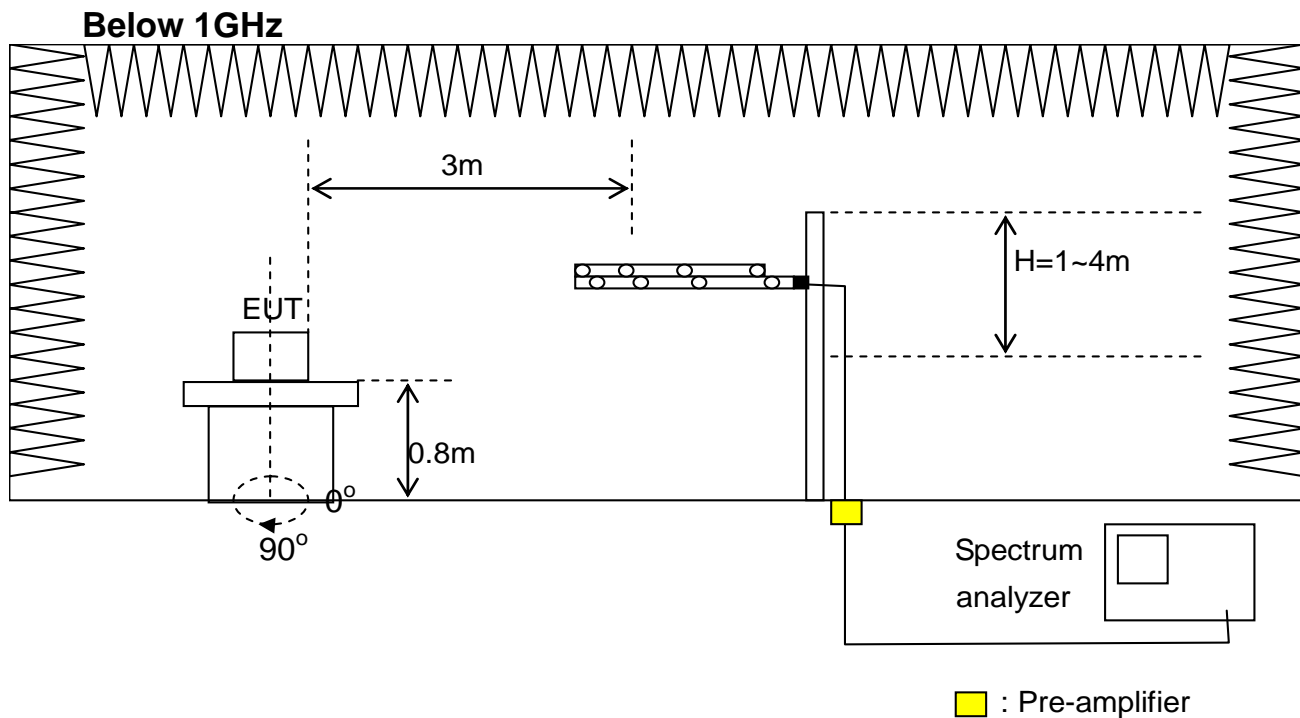

6.5 Test Data

Radiated Emission Measurement below 1000MHz

Test Mode : 2415MHz, Continuous Transmitting
 Test Distance : 3m Tester : Bill
 Polarization : Vertical Frequency Range : 30MHz~1000MHz

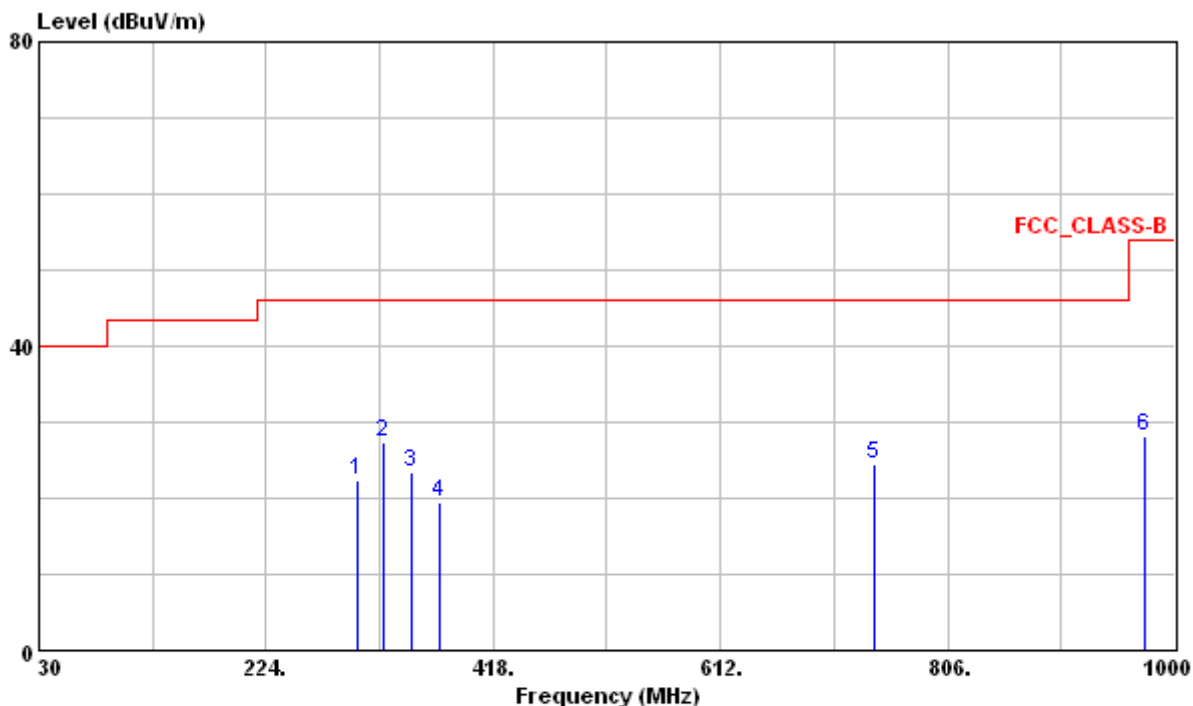

	Freq	Level	Factor	Read Level	Limit Line	Over Limit	Ant Pos	Table Pos	Pol/Phase	Remark
	MHz	dBuV/m	dB/m	dBuV	dBuV/m	dB	cm	deg		
1	301.600	22.42	-12.03	34.45	46.00	-23.58	---	---	VERTICAL	Peak
2	323.510	27.46	-11.28	38.74	46.00	-18.54	100	248	VERTICAL	QP
3	348.160	23.33	-10.44	33.77	46.00	-22.67	---	---	VERTICAL	Peak
4	372.410	19.55	-9.83	29.38	46.00	-26.45	---	---	VERTICAL	Peak
5	743.920	24.45	-2.73	27.18	46.00	-21.55	---	---	VERTICAL	Peak
6	974.780	28.11	-0.01	28.12	54.00	-25.89	---	---	VERTICAL	Peak

Note :

- Correction Factor (dB/m) = Cable Loss + Antenna Factor – Gain of Preamplifier
- Emission Level (dBuV/m) = Reading Data + Correction Factor

Test Mode : 2415MHz, Continuous Transmitting

Test Distance : 3m

Tester : Bill

Polarization : Horizontal

Frequency Range : 30MHz~1000MHz

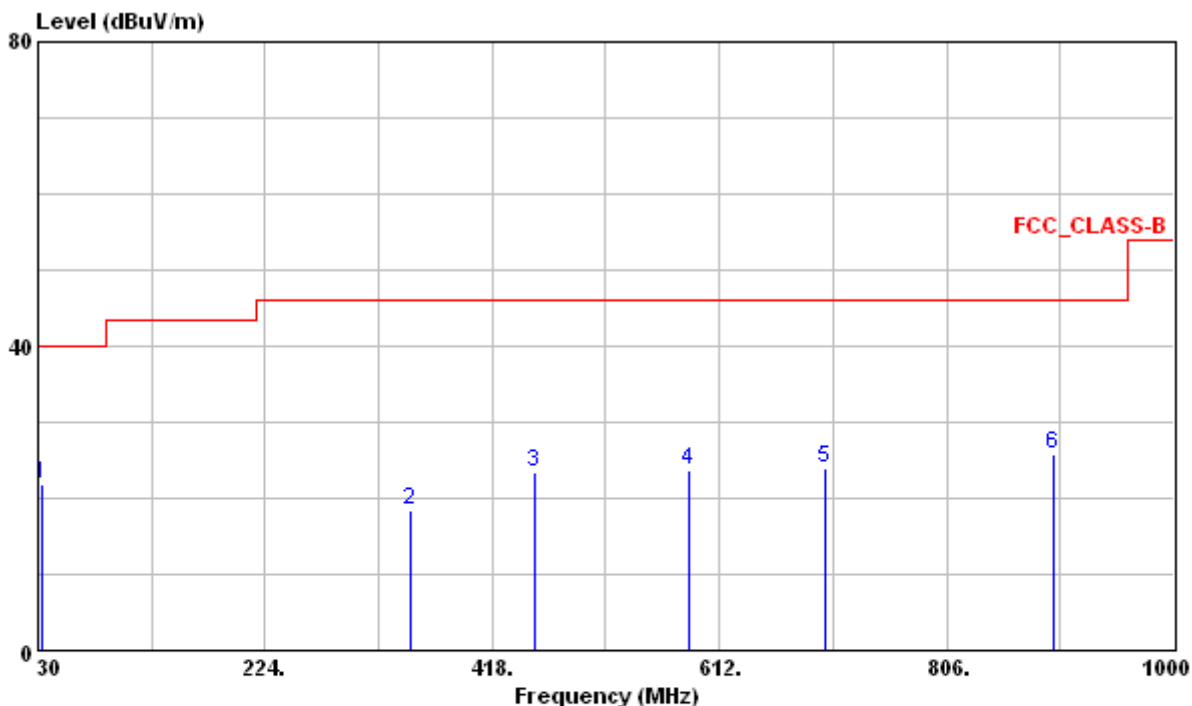

	Freq	Level	Factor	Read Level	Limit Line	Over Limit	Ant Pos	Table Pos	Pol/Phase	Remark
	MHz	dBuV/m	dB/m	dBuV	dBuV/m	dB	cm	deg		
1	33.880	21.81	-11.12	32.93	40.00	-18.19	---	---	HORIZONTAL	Peak
2	348.160	18.33	-10.44	28.77	46.00	-27.67	---	---	HORIZONTAL	Peak
3	454.860	23.36	-7.82	31.18	46.00	-22.64	111	21	HORIZONTAL	QP
4	585.810	23.66	-4.82	28.48	46.00	-22.34	---	---	HORIZONTAL	Peak
5	702.210	23.83	-2.91	26.74	46.00	-22.17	---	---	HORIZONTAL	Peak
6	897.180	25.70	-0.48	26.18	46.00	-20.30	---	---	HORIZONTAL	Peak

Note :

- Correction Factor (dB/m) = Cable Loss + Antenna Factor – Gain of Preamplifier
- Emission Level (dBuV/m) = Reading Data + Correction Factor

Test Mode : 2442MHz, Continuous Transmitting

Test Distance : 3m

Tester : Bill

Polarization : Vertical

Frequency Range : 30MHz~1000MHz

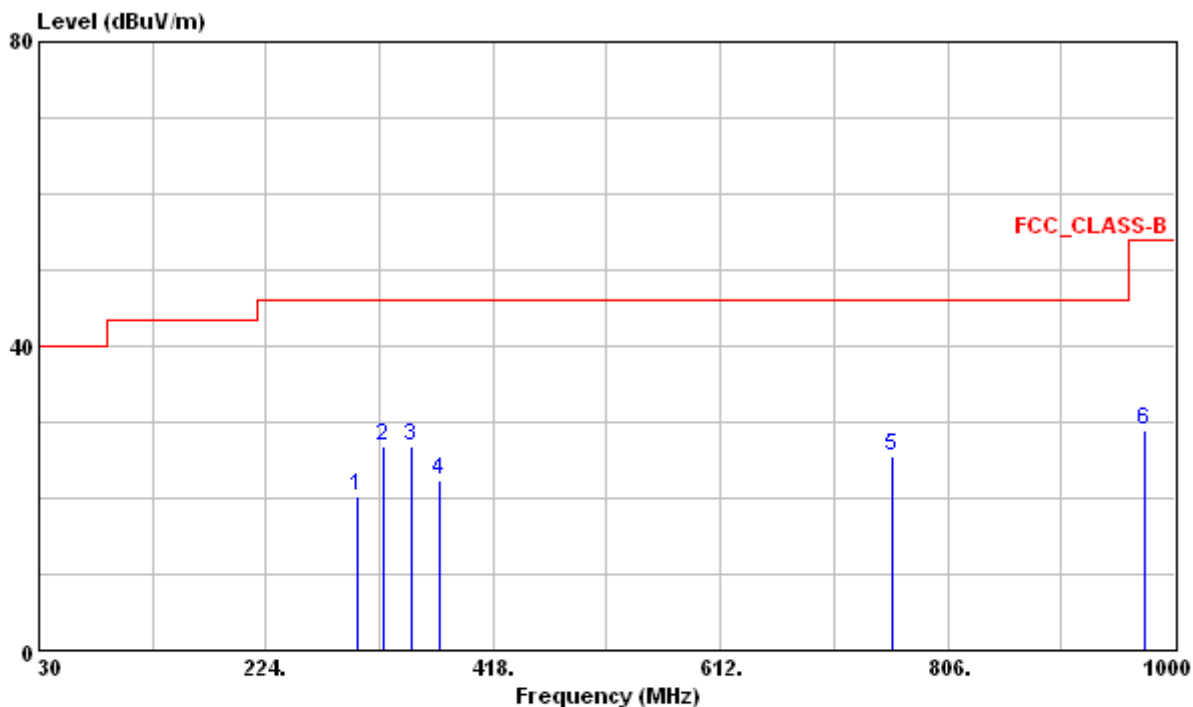

	Freq	Level	Factor	Read Level	Limit Line	Over Limit	Ant Pos	Table Pos	Pol/Phase	Remark
	MHz	dBuV/m	dB/m	dBuV	dBuV/m	dB	cm	deg		
1	301.600	20.23	-12.03	32.26	46.00	-25.77	---	---	VERTICAL	Peak
2	323.910	26.72	-11.26	37.98	46.00	-19.28	---	---	VERTICAL	Peak
3	347.958	26.85	-10.45	37.30	46.00	-19.15	100	72	VERTICAL	QP
4	372.410	22.43	-9.83	32.26	46.00	-23.57	---	---	VERTICAL	Peak
5	758.470	25.54	-2.60	28.14	46.00	-20.46	---	---	VERTICAL	Peak
6	974.780	28.89	-0.01	28.90	54.00	-25.11	---	---	VERTICAL	Peak

Note :

1. Correction Factor (dB/m) = Cable Loss + Antenna Factor – Gain of Preamplifier
2. Emission Level (dBuV/m) = Reading Data + Correction Factor

Test Mode : 2442MHz, Continuous Transmitting
Test Distance : 3m **Tester** : Bill
Polarization : Horizontal **Frequency Range** : 30MHz~1000MHz

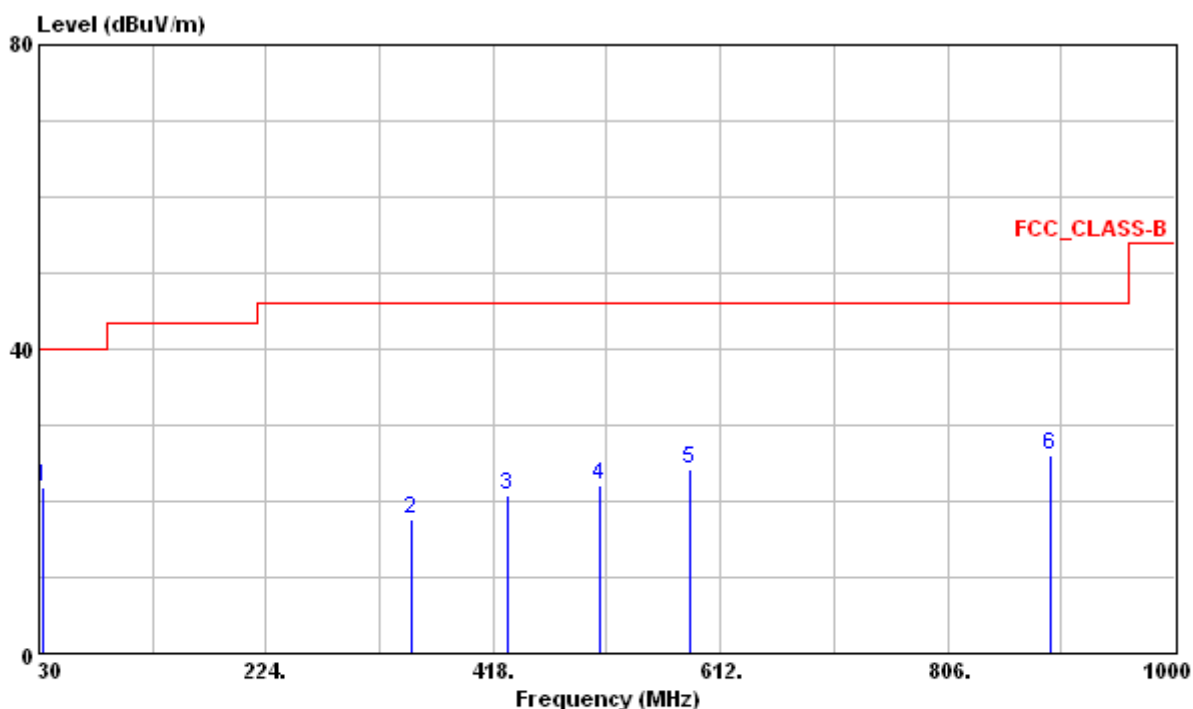

	Freq	Level	Factor	Read Level	Limit Line	Over Limit	Ant Pos	Table Pos	Pol/Phase	Remark
	MHz	dBuV/m	dB/m	dBuV	dBuV/m	dB	cm	deg		
1	33.880	21.89	-11.12	33.01	40.00	-18.11	---	---	HORIZONTAL	Peak
2	348.160	17.75	-10.44	28.19	46.00	-28.25	---	---	HORIZONTAL	Peak
3	430.610	20.80	-8.39	29.19	46.00	-25.20	---	---	HORIZONTAL	Peak
4	508.210	22.23	-6.81	29.04	46.00	-23.77	100	71	HORIZONTAL	QP
5	585.810	24.10	-4.82	28.92	46.00	-21.90	---	---	HORIZONTAL	Peak
6	894.270	26.00	-0.53	26.53	46.00	-20.00	---	---	HORIZONTAL	Peak

Note :

- Correction Factor (dB/m) = Cable Loss + Antenna Factor – Gain of Preamplifier
- Emission Level (dBuV/m) = Reading Data + Correction Factor

Test Model : 2465MHz, Continuous Transmitting
 Test Distance : 3m Tester : Bill
 Polarization : Vertical Frequency Range : 30MHz~1000MHz

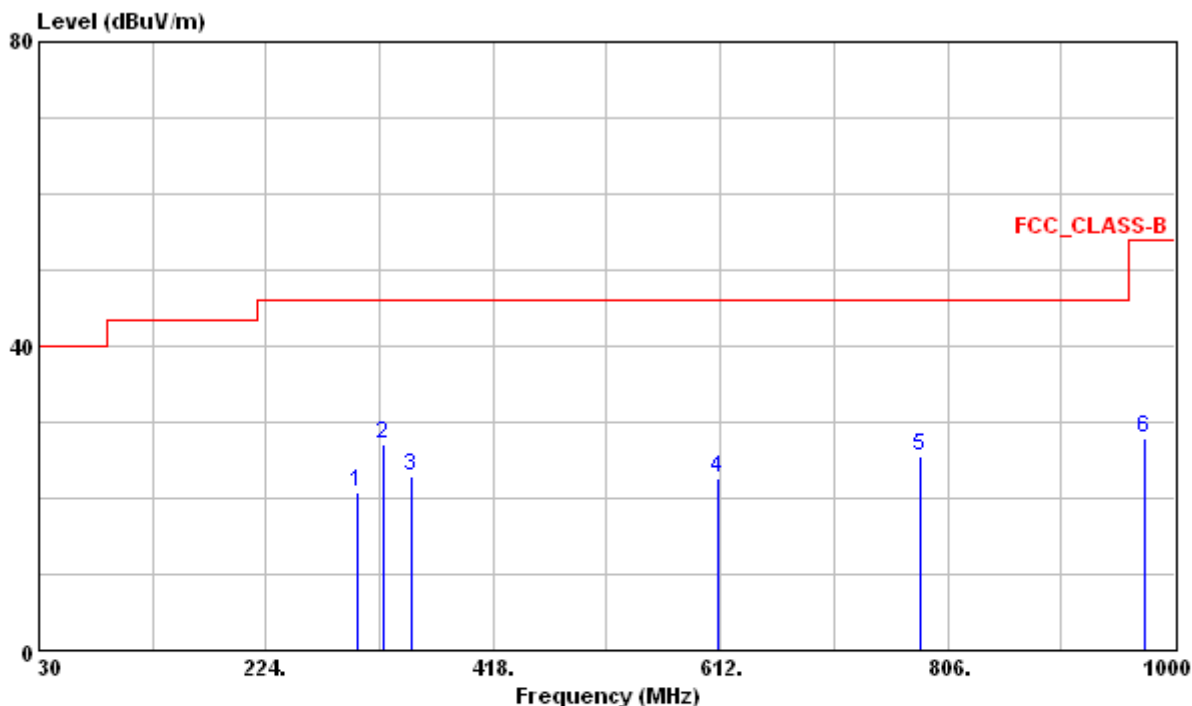

	Freq	Level	Factor	Read Level	Limit Line	Over Limit	Ant Pos	Table Pos	Pol/Phase	Remark
	MHz	dBuV/m	dB/m	dBuV	dBuV/m	dB	cm	deg		
1	301.600	20.88	-12.03	32.91	46.00	-25.12	---	---	VERTICAL	Peak
2	323.500	27.16	-11.28	38.44	46.00	-18.84	100	88	VERTICAL	QP
3	348.160	23.02	-10.44	33.46	46.00	-22.98	---	---	VERTICAL	Peak
4	610.060	22.58	-4.51	27.09	46.00	-23.42	---	---	VERTICAL	Peak
5	782.720	25.45	-2.34	27.79	46.00	-20.55	---	---	VERTICAL	Peak
6	974.780	28.00	-0.01	28.01	54.00	-26.00	---	---	VERTICAL	Peak

Note :

- Correction Factor (dB/m) = Cable Loss + Antenna Factor – Gain of Preamplifier
- Emission Level (dBuV/m) = Reading Data + Correction Factor

Test Model : 2465MHz, Continuous Transmitting
 Test Distance : 3m Tester : Bill
 Polarization : Horizontal Frequency Range : 30MHz~1000MHz

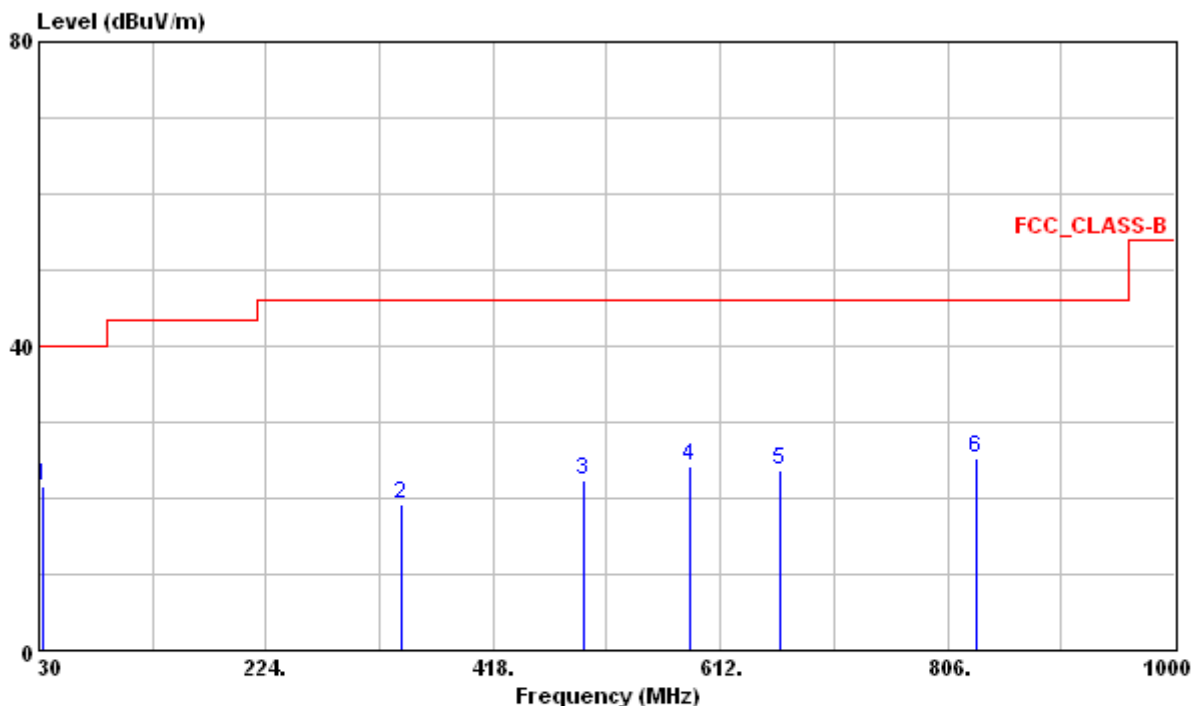

	Freq	Level	Factor	Read Level	Limit Line	Over Limit	Ant Pos	Table Pos	Pol/Phase	Remark
	MHz	dBuV/m	dB/m	dBuV	dBuV/m	dB	cm	deg		
1	33.880	21.53	-11.12	32.65	40.00	-18.47	---	---	HORIZONTAL	Peak
2	340.400	19.20	-10.70	29.90	46.00	-26.80	---	---	HORIZONTAL	Peak
3	495.600	22.36	-7.15	29.51	46.00	-23.64	120	45	HORIZONTAL	QP
4	585.810	24.11	-4.82	28.93	46.00	-21.89	---	---	HORIZONTAL	Peak
5	663.410	23.81	-3.95	27.76	46.00	-22.19	---	---	HORIZONTAL	Peak
6	831.220	25.25	-1.62	26.87	46.00	-20.75	---	---	HORIZONTAL	Peak

Note :

- Correction Factor (dB/m) = Cable Loss + Antenna Factor – Gain of Preamplifier
- Emission Level (dBuV/m) = Reading Data + Correction Factor

Radiated Emission Measurement above 1000MHz

Test Model : 2415MHz, Continuous Transmitting
 Test Distance : 3m Tester : Bill
 Antenna Polarization : Vertical Frequency Range :1GHz~25GHz

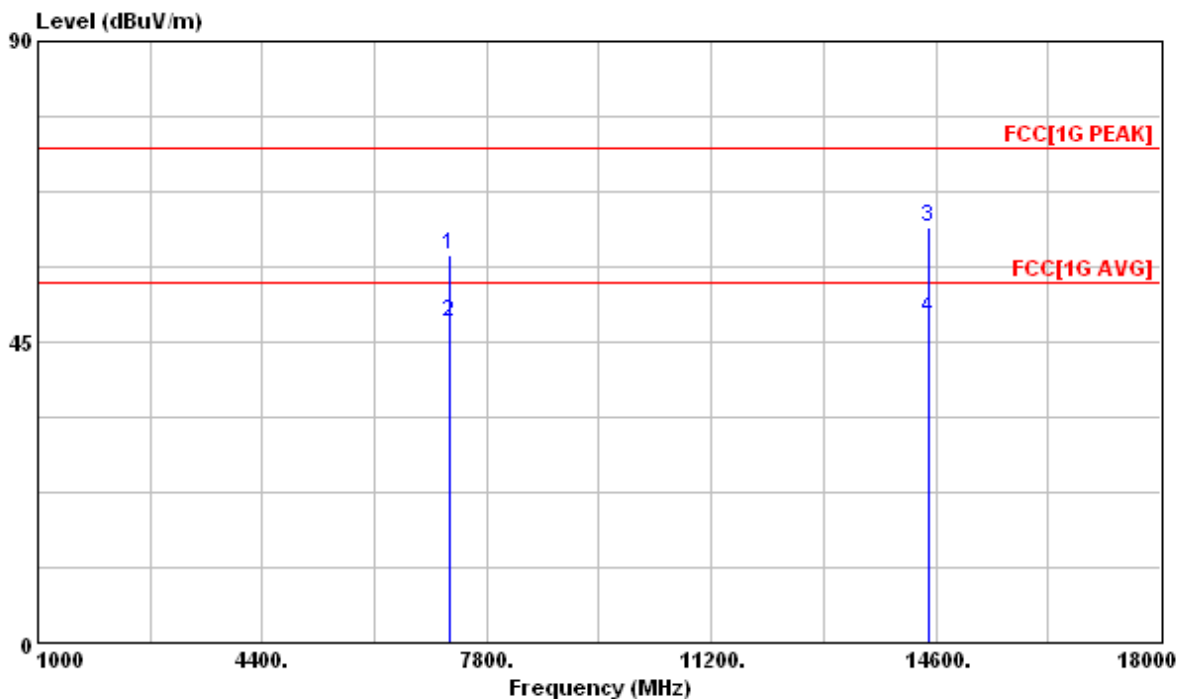

	Freq	Level	Factor	Read Level	Limit Line	Over Limit	Ant Pos	Table Pos	Pol/Phase	Remark
	MHz	dBuV/m	dB/m	dBuV	dBuV/m	dB	cm	deg		
1	7245.450	58.11	-22.10	80.21	74.00	-15.89	111	177	VERTICAL	Peak
2	7245.450	47.98	-22.10	70.08	54.00	-6.02	111	177	VERTICAL	Average
3	14491.530	62.05	-16.19	78.24	74.00	-11.95	100	204	VERTICAL	Peak
4	14491.530	48.45	-16.19	64.64	54.00	-5.55	100	204	VERTICAL	Average

Note:

1. Emission Level (dBuV/m) = Reading Value + Correction Factor.
2. Correction Factor (dB/m) = Cable Loss + Antenna Factor – Gain of Preamplifier.
3. PK. and AV. are abbreviation of peak and average respectively.

No signal can be detected from 18GHz to 25GHz, so the graphs are omitted above 18GHz.

Test Model : 2415MHz, Continuous Transmitting
 Test Distance : 3m Tester : Bill
 Antenna Polarization : Horizontal Frequency Range :1GHz~25GHz

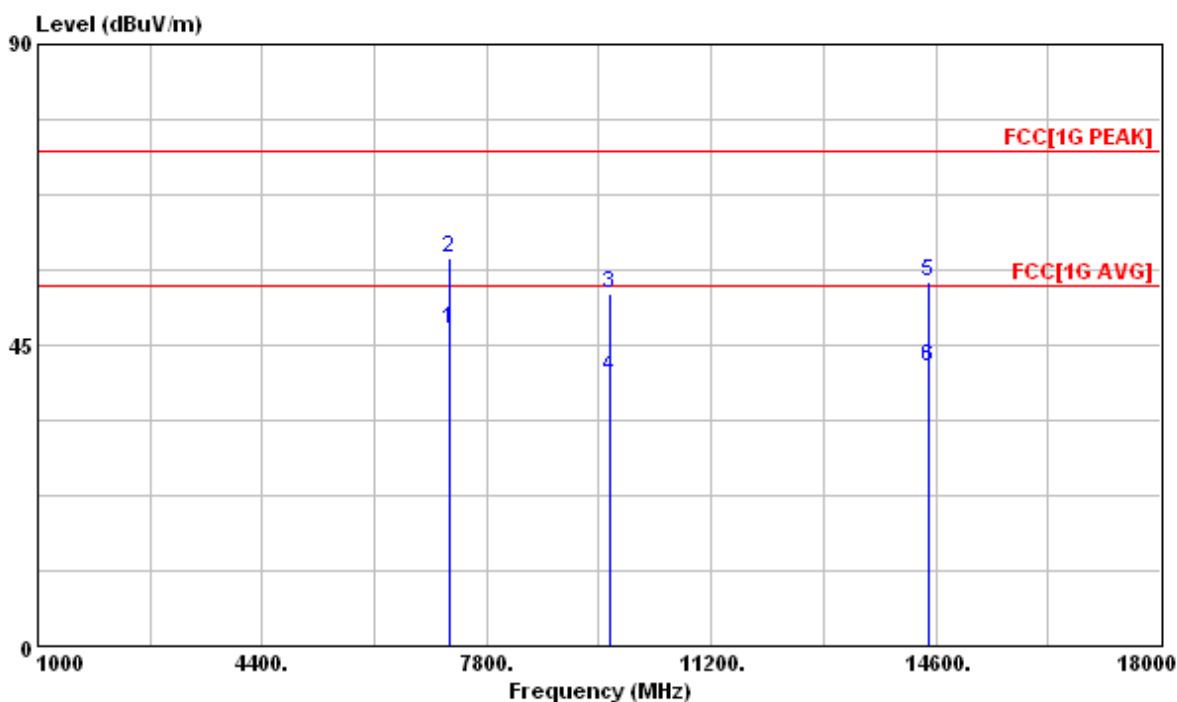

	Freq	Level	Factor	Read Level	Limit Line	Over Limit	Ant Pos	Table Pos	Pol/Phase	Remark
	MHz	dBuV/m	dB/m	dBuV	dBuV/m	dB	cm	deg		
1	7245.450	47.50	-22.10	69.60	54.00	-6.50	120	177	HORIZONTAL	Average
2	7245.450	57.91	-22.10	80.01	74.00	-16.09	120	177	HORIZONTAL	Peak
3	9658.800	52.64	-18.73	71.37	74.00	-21.36	132	208	HORIZONTAL	Peak
4	9658.800	40.20	-18.73	58.93	54.00	-13.80	132	208	HORIZONTAL	Average
5	14487.750	54.44	-16.20	70.64	74.00	-19.56	113	209	HORIZONTAL	Peak
6	14487.750	41.70	-16.20	57.90	54.00	-12.30	113	209	HORIZONTAL	Average

Note:

1. Emission Level (dBuV/m) = Reading Value + Correction Factor.
2. Correction Factor (dB/m) = Cable Loss + Antenna Factor – Gain of Preamplifier.
3. PK. and AV. are abbreviation of peak and average respectively.

No signal can be detected from 18GHz to 25GHz, so the graphs are omitted above 18GHz.

Test Model : 2442MHz, Continuous Transmitting
 Test Distance : 3m Tester : Bill
 Antenna Polarization : Vertical Frequency Range :1GHz~25GHz

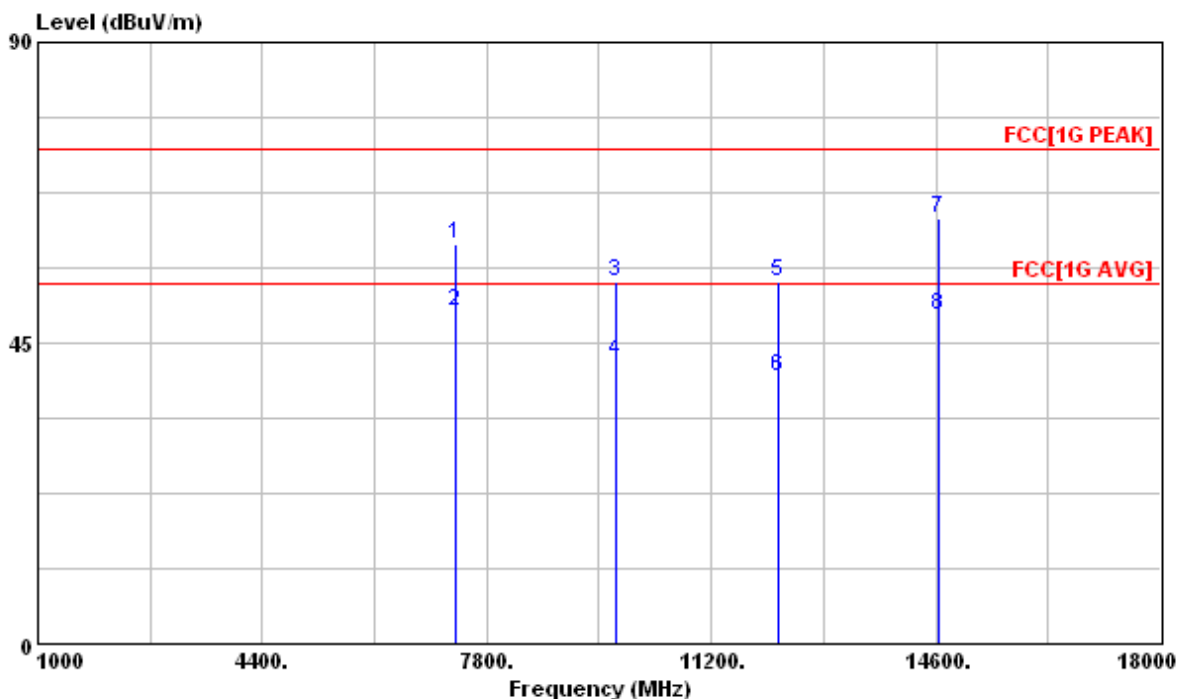

	Freq	Level	Factor	Read Level	Limit Line	Over Limit	Ant Pos	Table Pos	Pol/Phase	Remark
	MHz	dBuV/m	dB/m	dBuV	dBuV/m	dB	cm	deg		
1	7326.888	59.88	-22.11	81.99	74.00	-14.12	100	169	VERTICAL	Peak
2	7326.888	49.67	-22.11	71.78	54.00	-4.33	100	169	VERTICAL	Average
3	9769.325	54.22	-18.63	72.85	74.00	-19.78	169	221	VERTICAL	Peak
4	9769.325	42.30	-18.63	60.93	54.00	-11.70	169	221	VERTICAL	Average
5	12208.080	54.06	-15.19	69.25	74.00	-19.94	100	29	VERTICAL	Peak
6	12208.080	39.93	-15.19	55.12	54.00	-14.07	100	29	VERTICAL	Average
7	14654.000	63.56	-16.37	79.93	74.00	-10.44	100	188	VERTICAL	Peak
8	14654.000	49.17	-16.37	65.54	54.00	-4.83	100	188	VERTICAL	Average

Note:

1. Emission Level (dBuV/m) = Reading Value + Correction Factor.
2. Correction Factor (dB/m) = Cable Loss + Antenna Factor – Gain of Preamplifier.
3. PK. and AV. are abbreviation of peak and average respectively.

No signal can be detected from 18GHz to 25GHz, so the graphs are omitted above 18GHz.

Test Model : 2442MHz, Continuous Transmitting
Test Distance : 3m **Tester** : Bill
Antenna Polarization : Horizontal **Frequency Range** :1GHz~25GHz

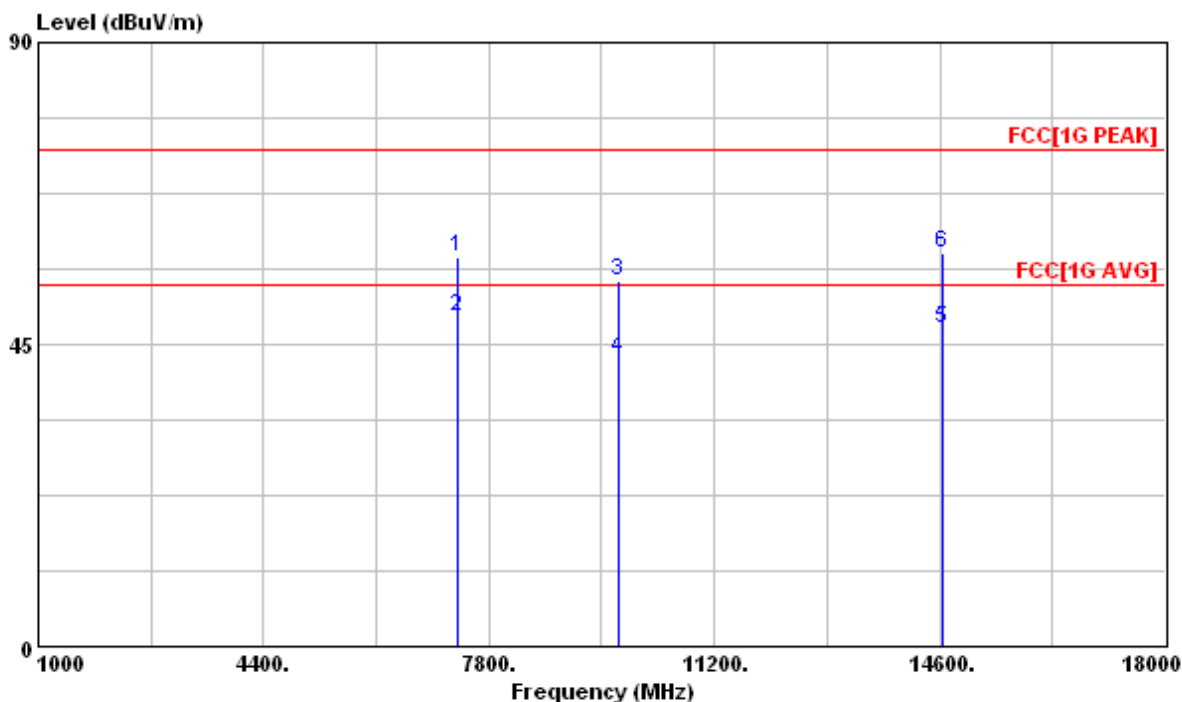

	Freq	Level	Factor	Read	Limit	Over	Ant	Table	Pol/Phase	Remark
				Level	Line	Limit				
	MHz	dBuV/m	dB/m	dBuV	dBuV/m	dB	cm	deg		
1	7327.000	58.03	-22.11	80.14	74.00	-15.97	100	170	HORIZONTAL	Peak
2	7327.000	49.23	-22.11	71.34	54.00	-4.77	100	170	HORIZONTAL	Average
3	9766.475	54.59	-18.64	73.23	74.00	-19.41	162	215	HORIZONTAL	Peak
4	9766.475	42.82	-18.64	61.46	54.00	-11.18	162	215	HORIZONTAL	Average
5	14653.750	47.29	-16.37	63.66	54.00	-6.71	100	193	HORIZONTAL	Average
6	14653.750	58.51	-16.37	74.88	74.00	-15.49	100	193	HORIZONTAL	Peak

Note:

1. Emission Level (dBuV/m) = Reading Value + Correction Factor.
2. Correction Factor (dB/m) = Cable Loss + Antenna Factor – Gain of Pre-amplifier.
3. PK. and AV. are abbreviation of peak and average respectively.

No signal can be detected from 18GHz to 25GHz, so the graphs are omitted above 18GHz.

Test Model : 2465MHz, Continuous Transmitting
 Test Distance : 3m Tester : Bill
 Antenna Polarization : Vertical Frequency Range :1GHz~25GHz

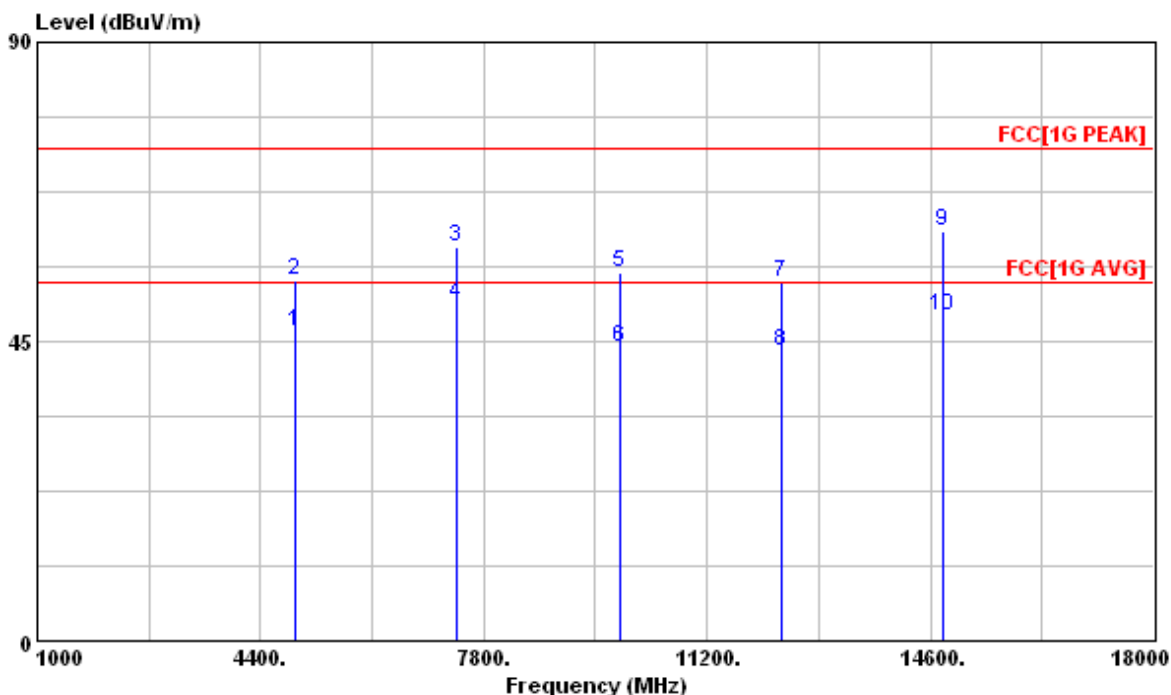

	Freq	Level	Factor	Read	Limit	Over	Ant	Table		
	MHz	dBuV/m	dB/m	Level	Line	Limit	Pos	Pos	Pol/Phase	Remark
				dBuV	dBuV/m	dB	cm	deg		
1	4929.250	46.60	-26.24	72.84	54.00	-7.40	141	320	VERTICAL	Average
2	4929.250	54.22	-26.24	80.46	74.00	-19.78	141	320	VERTICAL	Peak
3	7394.375	59.07	-22.27	81.34	74.00	-14.93	162	232	VERTICAL	Peak
4	7394.375	50.68	-22.27	72.95	54.00	-3.32	162	232	VERTICAL	Average
5	9861.450	55.36	-18.38	73.74	74.00	-18.64	110	341	VERTICAL	Peak
6	9861.450	44.00	-18.38	62.38	54.00	-10.00	110	341	VERTICAL	Average
7	12327.080	54.03	-15.23	69.26	74.00	-19.97	100	224	VERTICAL	Peak
8	12327.080	43.39	-15.23	58.62	54.00	-10.61	100	224	VERTICAL	Average
9	14791.250	61.54	-16.36	77.90	74.00	-12.46	121	190	VERTICAL	Peak
10	14791.250	48.92	-16.36	65.28	54.00	-5.08	121	190	VERTICAL	Average

Note:

1. Emission Level (dBuV/m) = Reading Value + Correction Factor.
2. Correction Factor (dB/m) = Cable Loss + Antenna Factor – Gain of Pre-amplifier.
3. PK. and AV. are abbreviation of peak and average respectively.

No signal can be detected from 18GHz to 25GHz, so the graphs are omitted above 18GHz.

Test Model : 2465MHz, Continuous Transmitting
Test Distance : 3m **Tester** : Bill
Antenna Polarization : Horizontal **Frequency Range** :1GHz~25GHz

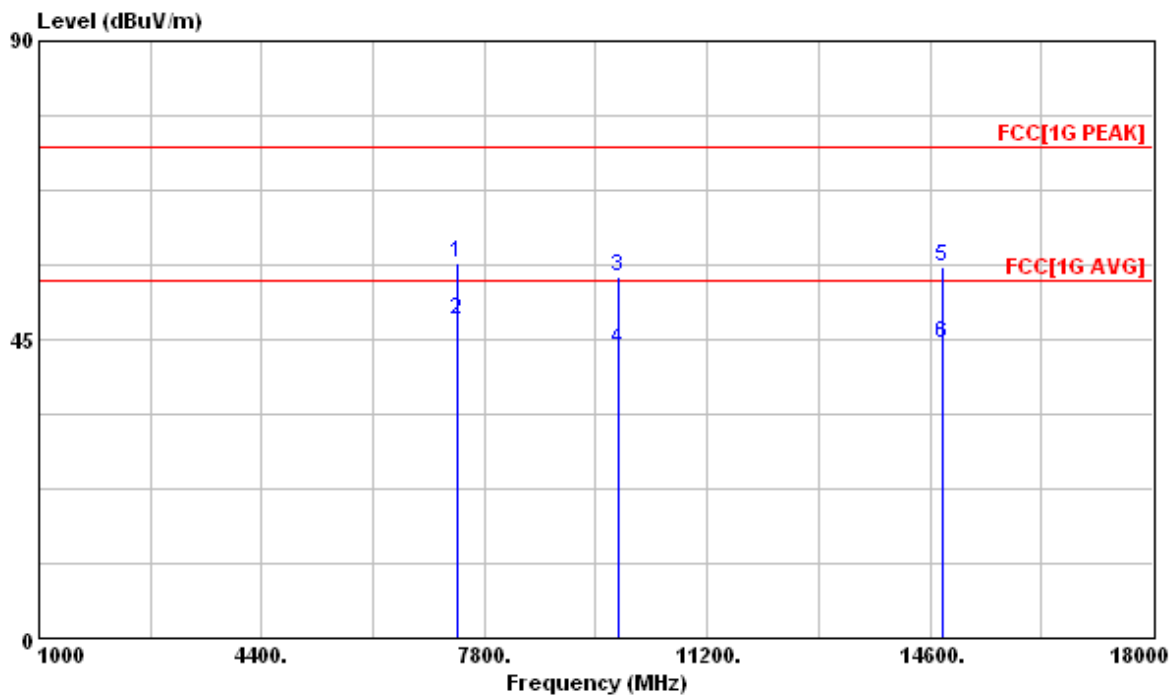

	Freq	Level	Factor	Read Level	Limit Line	Over Limit	Ant Pos	Table Pos	Pol/Phase	Remark
	MHz	dBuV/m	dB/m	dBuV	dBuV/m	dB	cm	deg		
1	7396.125	56.62	-22.27	78.89	74.00	-17.38	149	114	HORIZONTAL	Peak
2	7396.125	47.93	-22.27	70.20	54.00	-6.07	149	114	HORIZONTAL	Average
3	9858.375	54.60	-18.38	72.98	74.00	-19.40	119	215	HORIZONTAL	Peak
4	9858.375	43.53	-18.38	61.91	54.00	-10.47	119	215	HORIZONTAL	Average
5	14792.200	56.00	-16.36	72.36	74.00	-18.00	100	82	HORIZONTAL	Peak
6	14792.200	44.55	-16.36	60.91	54.00	-9.45	100	82	HORIZONTAL	Average

Note:

1. Emission Level (dBuV/m) = Reading Value + Correction Factor.
2. Correction Factor (dB/m) = Cable Loss + Antenna Factor – Gain of Preamplifier.
3. PK. and AV. are abbreviation of peak and average respectively.

No signal can be detected from 18GHz to 25GHz, so the graphs are omitted above 18GHz.

7 Dwell Time

Result: Pass

7.1 Applied standard

According to 15.247(a)(1)(iii), frequency hopping systems in the 2400-2483.5 MHz band shall use at least 15 non-overlapping channels. The average time of occupancy on any channel shall not be greater than 0.4 seconds within a period of 0.4 seconds multiplied by the number of hopping channels employed.

7.2 Test Instruments

Test Site and Equipment	Manufacturer	Model No./ Serial No.	Last Calibration Date	Calibration Due Date
Spectrum Analyzer	Agilent	E4405B/ MY45106706	2009/3/25	2010/3/24
Chamber	NA	TR13	NCR	NCR

Note:

1. The calibrations are traceable to NML/ROC.
2. NCR: No Calibration Required.

Instrument Setting

RBW	VBW	Span	Detector	Comment
1MHz	1MHz	0Hz	Peak	

Climatic Condition

Ambient Temperature : 22°C

Relative Humidity :60%

7.3 Measurement Procedure

- a. The EUT was set up per the test configuration figured in the next section of this chapter to simulate the typical usage per the user's manual.
- b. A software provided by client enabled the EUT to transmit data with the same packet type.
- c. According to FCC Public Notice DA00-705, Span = zero span, RBW = 1 MHz, VBW \geq RBW to measure the single packet duration time
- d. Change the transmitting packet type and repeat the step b.
- e. Calculate the dwell time and compare with the required limit.

7.4 Test configuration

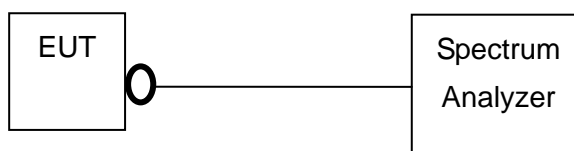

7.5 Test Data

Test Mode : Continuous Transmitting Tester : Bill

Operating Frequency (MHz)	Single Packet Duration Time (ms)	Dwell Time (ms)	Limit (ms)	Margin (ms)
2442	10.6	216.24	400	183.76

Note:

1. Hopping Cycle(second) = 51 X 0.4 = 20.4
2. Dwell Time (ms) = Single Packet Duration Time X Hopping Cycle
3. Margin (ms) = Limit – Dwell Time

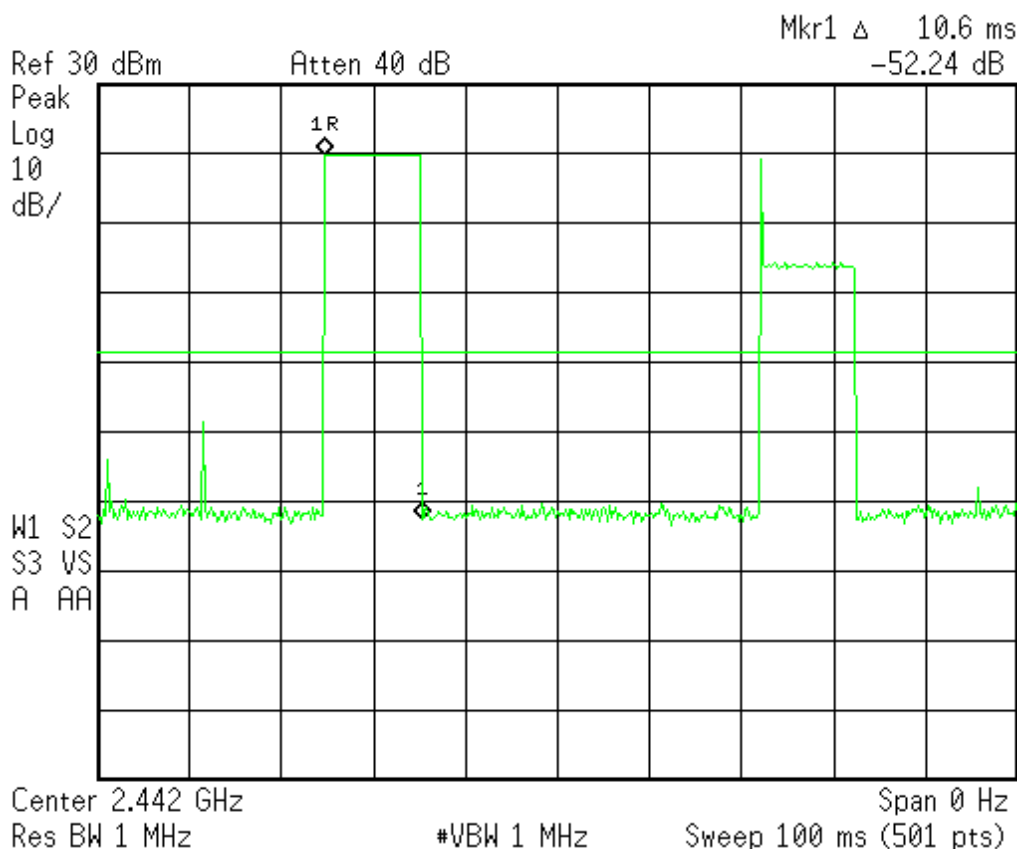

8 Antenna Requirement

8.1 Applied standard

According to 15.247(4), The conducted output power limit specified in paragraph (b) of this section is based on the use of antennas with directional gains that do not exceed 6 dBi. Except as shown in paragraph (c) of this section, if transmitting antennas of directional gain greater than 6 dBi are used, the conducted output power from the intentional radiator shall be reduced below the stated values in paragraphs (b)(1), (b)(2), and (b)(3) of this section, as appropriate, by the amount in dB that the directional gain of the antenna exceeds 6 dBi

8.2 Antenna Information

This antenna's relative information as follow:

Brand	Model	Frequency Range (MHz)	Gain (dBi)	Comment
SANWA	WINCAB-RF-032	2415 ~ 2465	1.1	



8.3 Result

Gain of the antenn is less than 6dBi.