

FCC Part 15 Subpart C Requirement
and Industry Canada RSS-210
Measurement and Test Report

For

Sanwa Electronic Instrument Co., Ltd

1-2-50, Yoshida Honmachi, Higashi-Osaka, Osaka 578-0982, Japan

FCC ID: L73-90214
IC: 7377A-90214

June 05, 2009

This Report Concerns: <input checked="" type="checkbox"/> Original Report	Equipment Type: 2.4GHz Radio Control System
Test Engineer:	Bossc He
Report Number:	SE09E-075FI
Test Date:	June 03-05, 2009
Reviewed By:	<i>Louis</i>
Prepared By:	S&E Technologies Laboratory Ltd Room 407, Block A Shennan Garden, Hi-Tech Industrial Park, Shenzhen 518057, P.R. China. Tel: 86-755-26636573, 26630631 Fax: 86-755-26630557

Note: This test report is limited to the above client company and the product model only. It may not be duplicated without prior written consent of S&E Technologies Laboratory Ltd.

Table of Contents

1-TEST RESULT CERTIFICATION	3
2- EUT DESCRIPTION	4
3-TEST SYSTEM	5
3.1 TEST MODE	5
3.2 TEST SETUP DIAGRAM	5
3.3 BLOCK DIAGRAM OF EUT SYSTEM	6
3.4 LIST OF CABLES	6
4- TEST EQUIPMENT AND CALIBRATION	7
5- LABORATORY ACCREDITATIONS AND MEASUREMENT UNCERTAINTY	8
5.1 LABORATORY ACCREDITATION	8
5.2 MEASUREMENT UNCERTAINTY	8
6- TECHNICAL REQUIREMENTS AND RESULTS	9
6.1 CARRIER FREQUENCY SEPARATION MEASUREMENT	9
6.2 NUMBER OF HOPPING FREQUENCIES MEASUREMENT	11
6.3 TIME OF OCCUPY (DWELL TIME) MEASUREMENT	13
6.4 PEAK OUTPUT POWER MEASUREMENT.....	16
6.5 BAND EDGE OF CONDUCTED EMISSION AND SPURIOUS RF CONDUCTED EMISSIONS	20
6.6 SPURIOUS RADIATED EMISSION MEASUREMENT	28
6.7 BAND EDGE AND RESTRICTED BAND OF RADIATED EMISSION MEASUREMENT.....	34
6.8 99% BANDWIDTH MEASUREMENT	38
6.9 RF EXPOSURE	42
6.10 ANTENNA REQUIREMENT.....	42

1-Test Result Certification

Applicant: Sanwa Electronic Instrument Co., Ltd
 1-2-50, Yoshida Honmachi, Higashi-Osaka,
 Osaka 578-0982, Japan

Equipment Under Test: 2.4GHz Radio Control System

Trade Name: SANWA

Model: 90214

Type of Modulation: FHSS

Number of Channels: 51

Channel Separation: 1MHz

Operation Frequency: 2415 ~2465MHz

Antenna Designation: Non-user replaceable (fixed)

Battery Voltage: DC12.0V [1.5V*8 "AA" batteries]

Date of Test: June 03-05, 2009

Applicable Standards	
Standard	Test Result
FCC 47 CFR Part 15 Subpart C, §15.247 Industry Canada: RSS-210 issue 7: 2007, Annex 8 Industry Canada: RSS-Gen issue 2: 2007	No non-compliance noted

We hereby certify that:

The above equipment was tested at ATC Lab Co., Ltd (Guangdong, China). The test data, data evaluation, test procedures, and equipment configurations shown in this report were made in accordance with the procedures given in ANSI C63.4-2003 and Public Notice DA 00-705. The energy emitted by the sample EUT tested as described in this report is in compliance with conducted and radiated emission limits of FCC Rules Part 15C: 2007, §15.247 and RSS-210 Issue 7, Annex 8.

The test results of this report relate only to the tested sample identified in this report.

2- EUT Description

Product	2.4GHz Radio Control System
Trade Name	SANWA
Model Number	90214
Model Difference	N/A
Type of Modulation:	FHSS
Number of Channels:	51
Channel Separation:	1MHz
Power Supply	12.0V DC power from 1.5V*8 "AA" batteries
Frequency Range	2415 ~2465 MHz
Antenna Designation	Non-user replaceable (fixed)

Remark: This submittal(s) test report is intended for FCC ID: L73-90214, IC: 7377A-90214 filing to comply with Section 15.247 of the FCC Part 15, Subpart C Rules and RSS-210 Issue 7, Annex 8.

3-Test System

3.1 Test Mode

The compliance test was performed under test modes:

Mode 1: Transmitting at 2415MHz without hopping.

Mode 2: Transmitting at 2442MHz without hopping.

Mode 3: Transmitting at 2465MHz without hopping.

Mode 4: Transmitting with hopping.

The EUT is designed both of horizontally placed and vertically place. In radiated emission measurement, each condition was conducted.

As a result, the emission that produce the maximum operation under were reported.

- a) Carrier Frequency Separation measurement ---Mode 4
- b) Number of Hopping Frequencies measurement --- Mode 4
- c) Time of Occupancy measurement --- Mode 4
- d) Peak Output Power measurement --- Mode 1, Mode 2, Mode 3
- e) Band Edge of RF Conducted measurement --- Mode 1, Mode 3 and Mode 4
- f) Radiated Emission measurement --- Mode 1, Mode 2, Mode 3
- g) Band Edge and Restricted Band of Radiated Emission Measurement --- Mode 1, Mode 3
- h) 99% Bandwidth measurement --- Mode 1, Mode 2, Mode 3

3.2 Test Setup Diagram

- . Carrier Frequency Separation
- . Number of Hopping Frequencies
- . Time of Occupancy (Dwell Time)
- . Peak Output Power
- . Band Edge of RF Conducted Emission
- . 99% Bandwidth

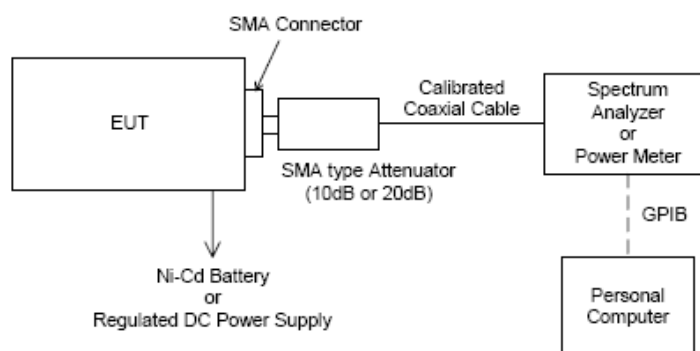

Note: Regulated DC power supply is not used in this report.

. Radiated Emisison

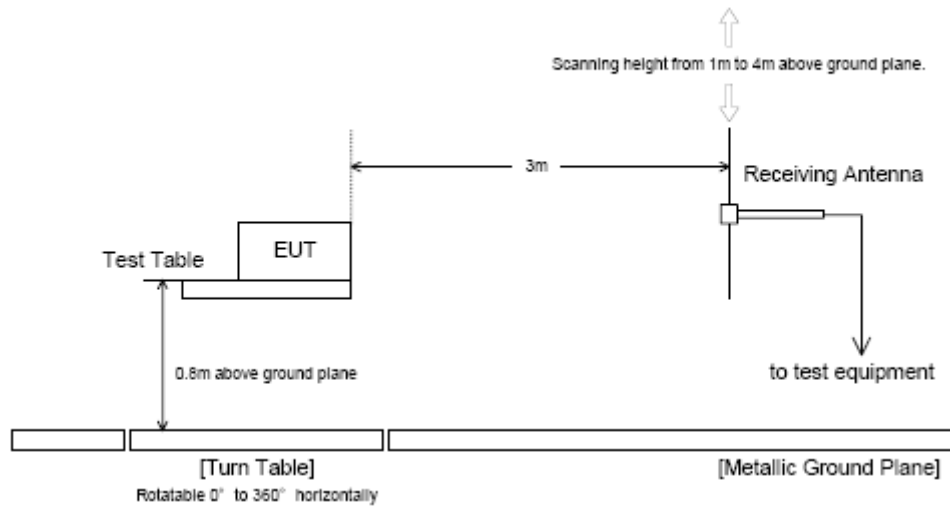

3.3 Block Diagram of EUT System

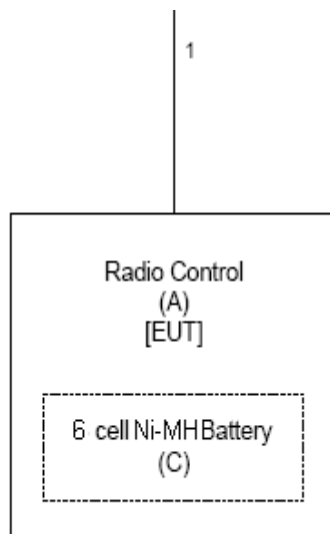

3.4 List of Cables

No	Cable Name	Shielded (Y/N)	Length (m)	Note	Remark
1	Antenna	Y	0.1		

4- Test Equipment and Calibration

Equipment type	Manufacturer	Model	Serial Number	Calibration Due
Biconilog Antenna	ETS	3142C	00042672	2009/09/26
Receiver	SCHAFFNER	SMR4503	11725	2009/07/08
Spectrum Analyzer	R/S	FSP30	100755	2009/11/26
Double-Ridged-Wave-guide Horn Antenna	ETS	3115	6587	2009/08/02
Amplifier	Agilent	83017A	MY39500438	2009/11/26

5- Laboratory Accreditations and Measurement Uncertainty

5.1 Laboratory Accreditation

FCC-Registration No.: 415467

ATC Lab Co., Ltd (Guangdong, China) EMC Laboratory has been registered and fully described in a report filed with the FCC (Federal Communications Commission). The acceptance letter from the FCC is maintained in our files. Registration 415467. Listing date October 10, 2008.

IC-Registration No.: 7949A

The 3m Alternate Test Site of ATC Lab Co., Ltd (Guangdong, China) has been registered by Certification and Engineering Bureau of Industry Canada for the performance of radiated measurements with Registration No. 7949A on Oct. 29th, 2008.

5.2 Measurement Uncertainty

of +/- 3×10^{-9} for Carrier Frequency Separation Measurement
of +/- 3×10^{-9} for Number of Hopping Frequencies Measurement
of +/- 3×10^{-9} for 20dB Bandwidth Measurement
of +/- 3×10^{-9} for Time of Occupancy (Dwell time) Measurement
of +/- 0.8 dB for Peak Output Power Measurement
of +/- 0.8 dB for Band Edge RF Conducted Measurement
of +/- 0.8 dB for Spurious RF Conducted Emission Measurement
of +/- 0.8 dB for Power Density
of +/- 4.8 dB for Radiated Emissions
of +/- 2.3 dB for Conducted Emissions

6- Technical Requirements and Results

6.1 Carrier Frequency Separation Measurement

Applicable Standard:

According to §15.247(a)(1), Frequency hopping systems shall have hopping channel carrier frequencies separated by a minimum of 25 kHz or the 20 dB bandwidth of the hopping channel, whichever is greater. Alternatively, frequency hopping systems operating in the 2400-2483.5 MHz band may have hopping channel carrier frequencies that are separated by 25 kHz or two-thirds of the 20 dB bandwidth of the hopping channel, whichever is greater

According to RSS 210 issue 7, A8.1(b), frequency hopping systems operating in the 2400-2483.5 MHz band may have hopping channel carrier frequencies that are separated by 25 kHz or two-thirds of the 20dB bandwidth of the hopping channel, whichever is greater.

Test Procedure:

1. Connect the EUT RF output port to spectrum analyzer via calibrated coaxial cable and suitable attenuator (if necessary).
2. Activates the EUT System and execute the software prepared for test, if necessary.
3. To find out the maximum emission condition, the transmitting data rate of EUT is set to maximum data rate.
4. The Spectrums are scanned and allow the trace stabilized.
5. The separation between the peaks of the peaks of adjacent channel were measured by using delta-maker function of the spectrum analyzer

Spectrum analyzer setup condition :

Frequency Span : 2MHz
 Resolution bandwidth : 100kHz
 Video bandwidth : \cong RBW
 Sweep : Auto
 Detector function : Peak
 Trace Mode : Max Hold

Test Result:

Temperature:	25 °C
Humidity:	55%
EUT Operation:	Data Transmission (hopping)
Test Date:	June 04, 2009

Carrier Frequency Separation [MHz]	[MHz] Limit
1.024	> 0.025
Note: Test plot shown in figure 1 on page 10.	

Figure 1: Channel Separation

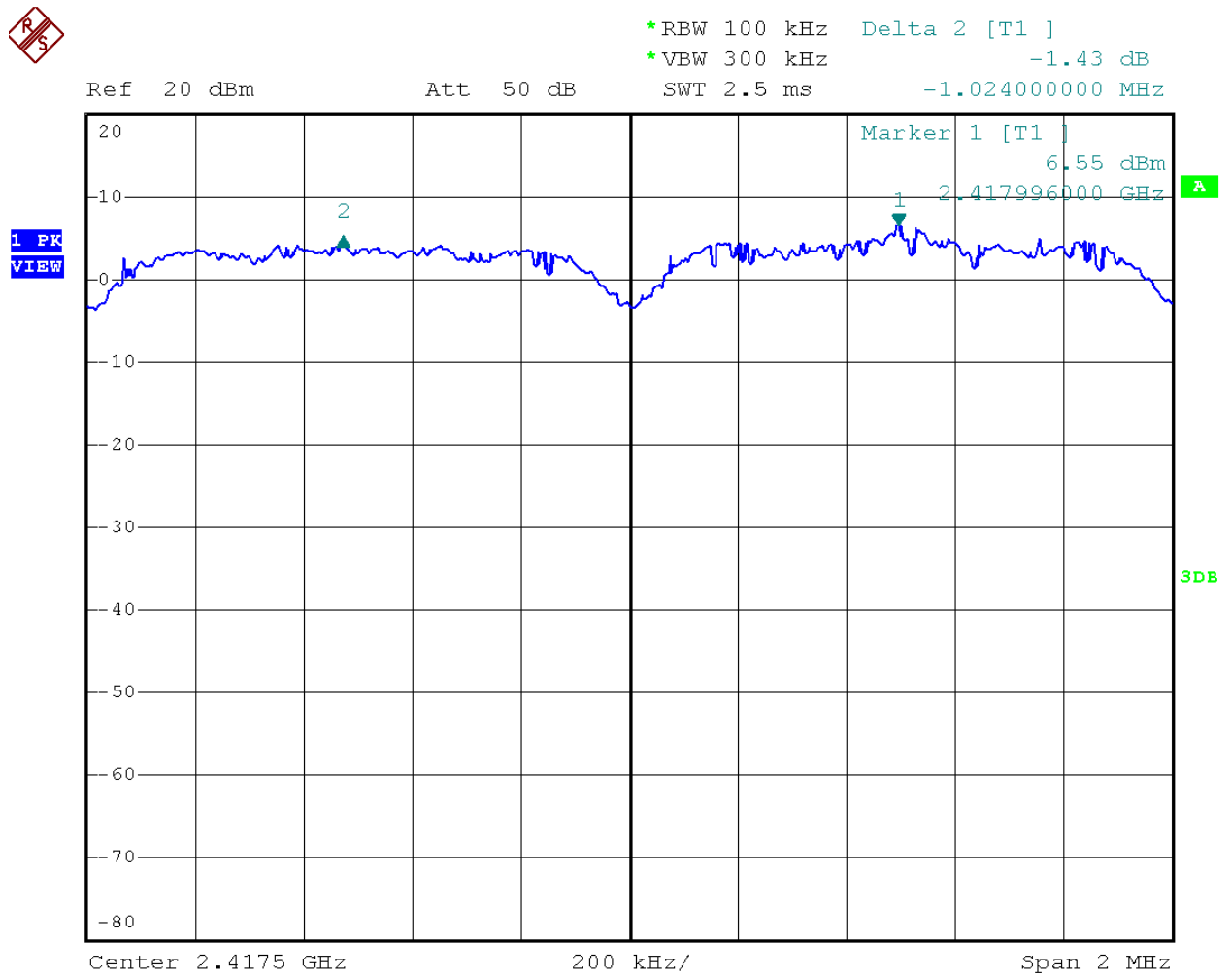

6.2 Number of Hopping Frequencies Measurement

Applicable Standard:

According to §15.247(a)(1)(iii), Frequency hopping systems operating in the 2400MHz-2483.5 MHz bands shall use at least 15 hopping frequencies.

According to RSS-210 issue 7, §A8.1(d), Frequency hopping systems operating in the 2400-2483.5MHz band shall use at least 15 hopping channels. The average time of occupancy on any channel shall not be greater than 0.4 seconds within a period of 0.4 seconds multiplied by the number of hopping channels employed. Transmissions on particular hopping frequencies may be avoided or suppressed provided that a minimum of 15 hopping channels are used.

Test Procedure:

1. Connect the EUT RF output port to spectrum analyzer via calibrated coaxial cable and suitable attenuator (if necessary).
2. Activates the EUT System and executes the software prepared for test, if necessary.
3. To find out the maximum emission condition, the transmitting data rate of EUT is set to maximum data rate.
4. The spectrums are scanned and allow the trace to stabilize.
5. The number of hopping frequencies were counted on the spectrum analyzer and recorded.

Spectrum analyzer setup condition :

Frequency Span : 60MHz
 Resolution bandwidth : 300KHz
 Sweep : Auto
 Detector function : Peak
 Trace Mode : Max Hold

Test Result:

Temperature:	25 °C
Humidity:	55%
EUT Operation:	Data Transmission (hopping)
Test Date:	June 04, 2009

Number of Hopping Frequencies	[MHz] Limit
51	> 15
Note: Test plot shown in figure 2 on page 12.	

Figure 2: Number of Hopping Frequencies

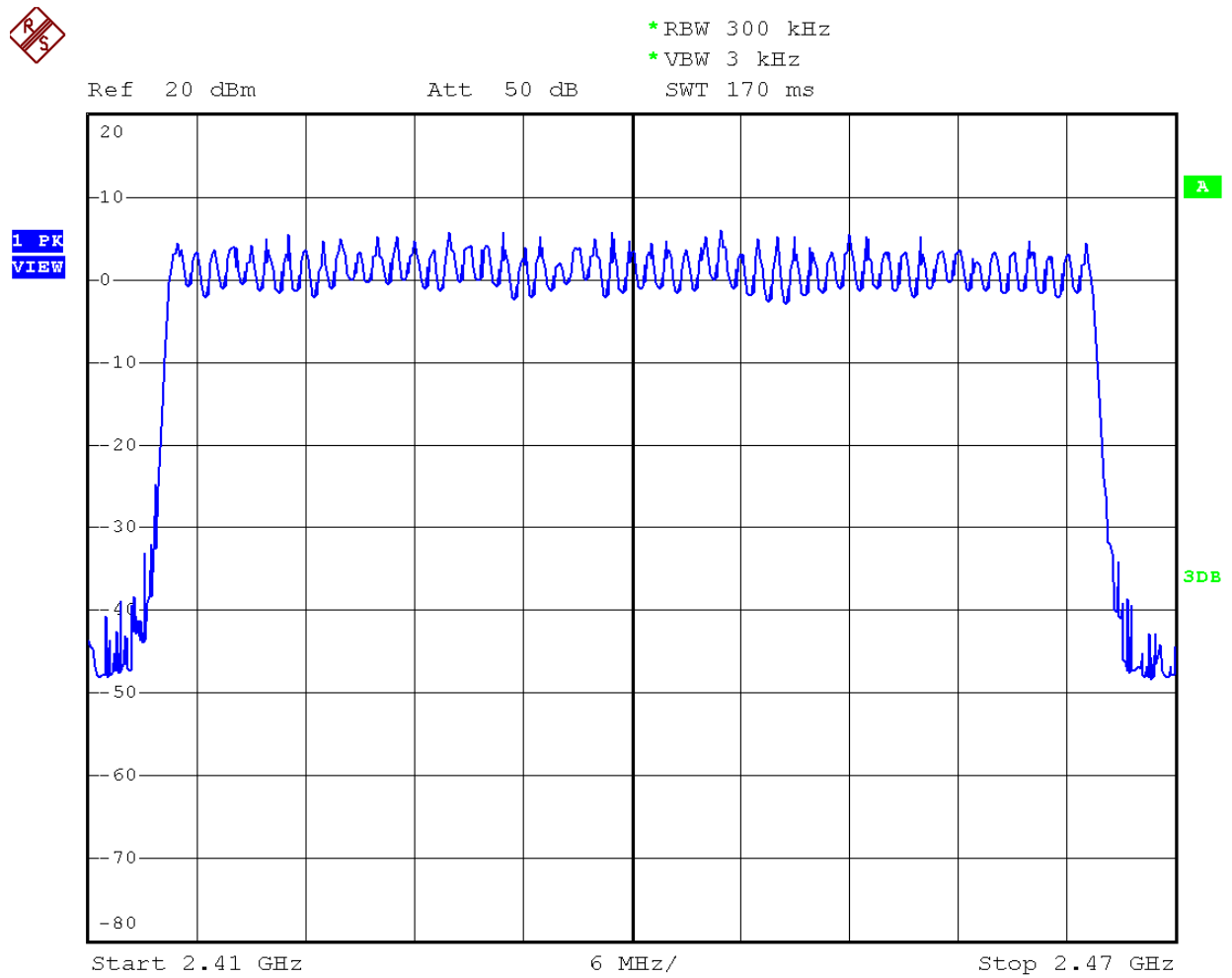

6.3 Time of Occupy (Dwell Time) Measurement

Applicable Standard:

According to §15.247(a)(1)(iii), Frequency hopping systems operating in the 2400MHz-2483.5 MHz. The average time of occupancy on any frequency shall not greater than 0.4 s within period of 0.4 seconds multiplied by the number of hopping channel employed.

According to RSS-210 issue 7, §A8.1 (d), Frequency hopping systems operating in the 2400-2483.5MHz bands shall use at least 15 hopping channels. The average time of occupancy on any channel shall not be greater than 0.4 seconds within a period of 0.4 seconds multiplied by the number of hopping channels employed. Transmissions on particular hopping frequencies may be avoided or suppressed provided that a minimum of 15 hopping channels are used.

Test Procedure:

1. Connect the EUT RF output port to spectrum analyzer via calibrated coaxial cable and suitable attenuator (if necessary).
2. Activates the EUT System and execute the software prepared for test, if necessary.
3. To find out the maximum emission condition, the transmitting data rate of EUT is set to maximum data rate.
4. The span of spectrum analyzer was set to zero (sweep time 30msec). The occupied time at center on a hopping frequency was observed and recorded as "Ton".
5. The spectrums are scanned by using the spectrum analyzer (*1). And the numbers of occupied channel per Nsec (period of 0.4 seconds multiplied by the number of hopping channels employed) were counted by using the delta-marker function of spectrum analyzer and recorded as "N".
6. The dwell time was calculated by $Ton \times N$.

Spectrum analyzer setup condition:

Frequency Span : Zero span

Resolution bandwidth : 1MHz

Video bandwidth : \geq RBW

Sweep : as necessary to capture the entire dwell time per hopping channel.

Detector function : Peak

Trace Mode : Max Hold

Test Result:

Temperature:	25 °C
Humidity:	55%
EUT Operation:	Data Transmission (hopping)
Test Date:	June 04, 2009

[ms]Dwell Time	[ms] Limit
5.24ms x 50 = 262	< 400
Note: Test plots shown in figures 3, 4 on pages 14, 15.	

Figure 3: Duration of one transmission

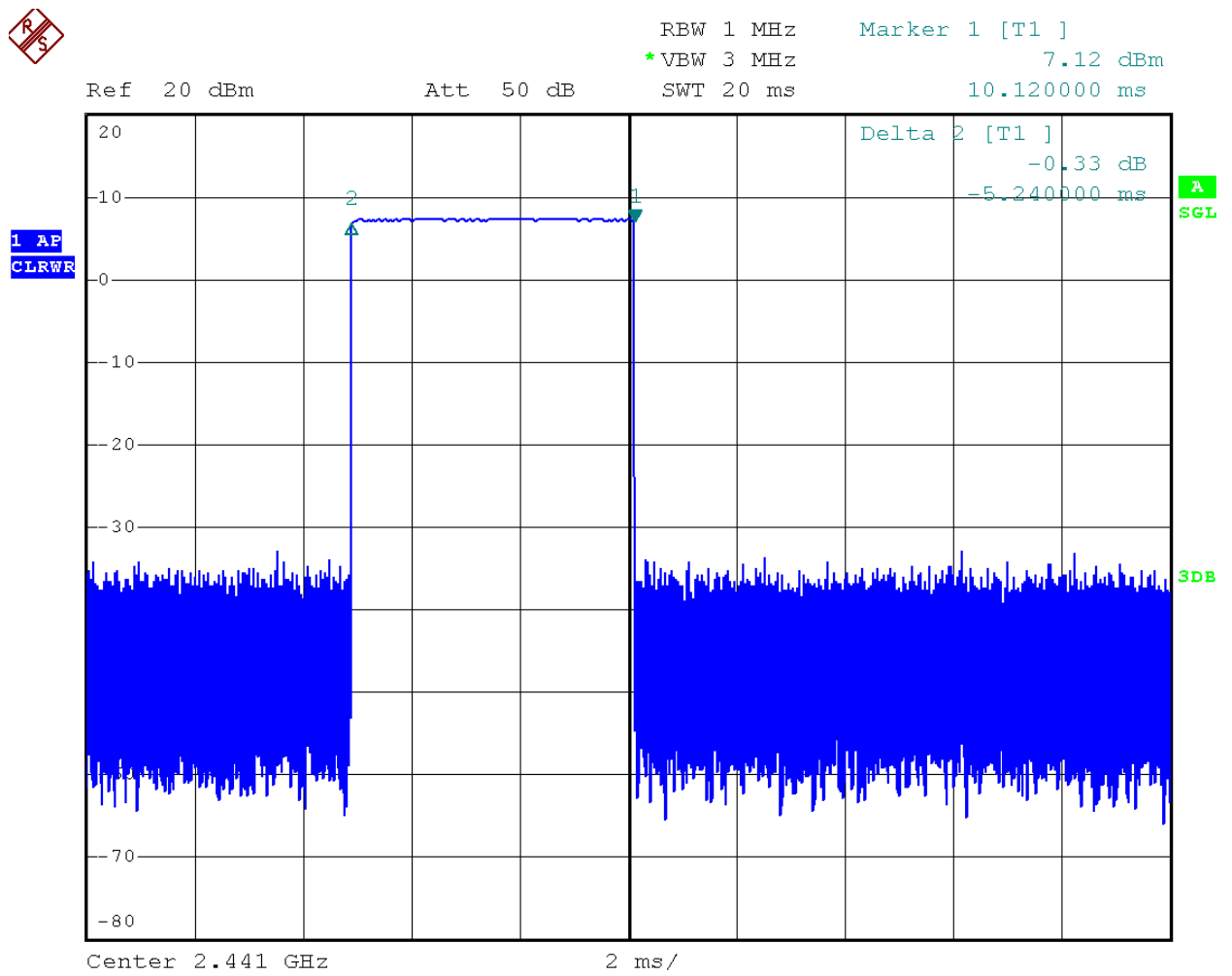
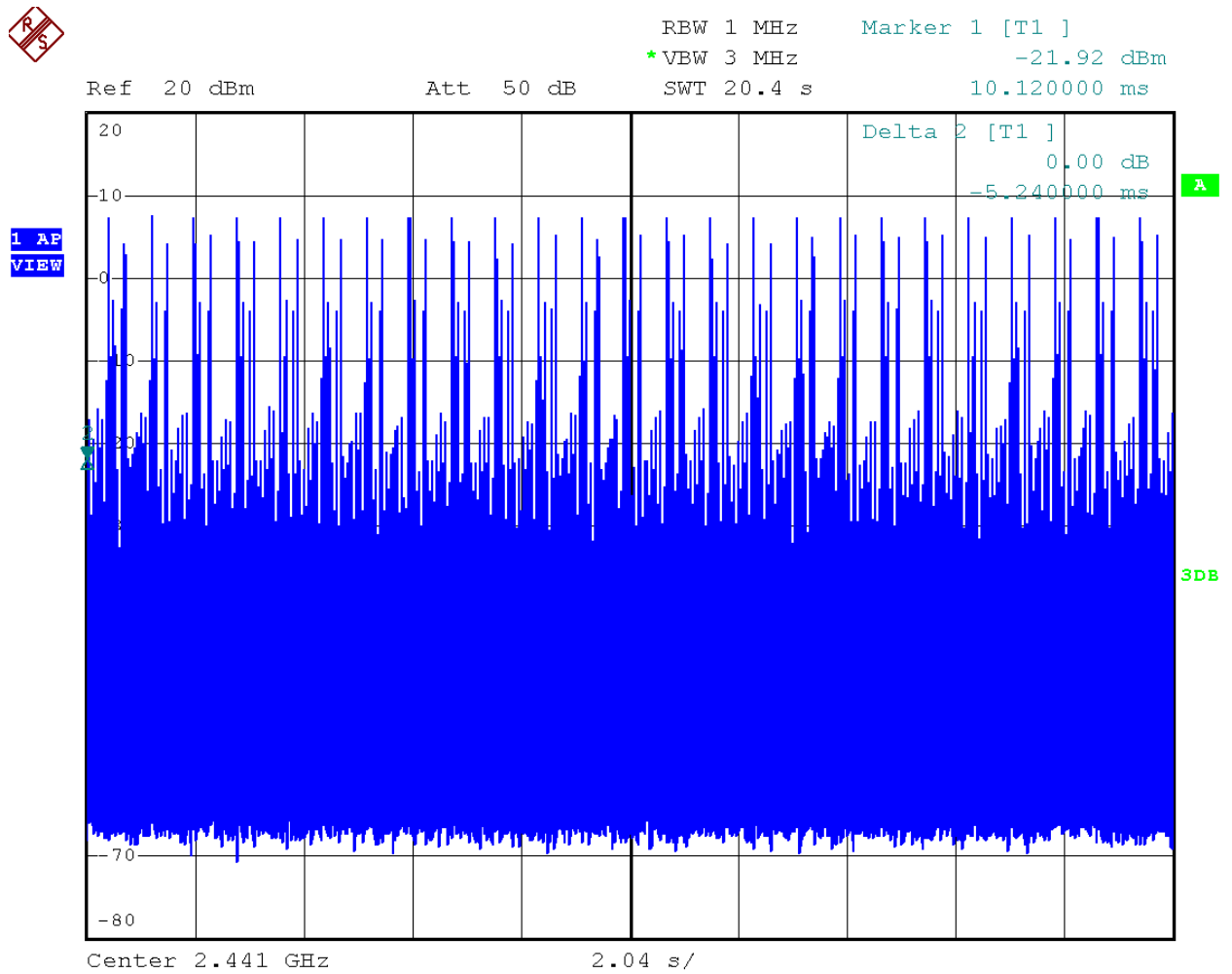

Figure 4: Number of Transmission at 20.4 s



6.4 Peak Output Power Measurement

Applicable Standard:

According to §15.247(b), For frequency hopping systems operating in the 2400-2483.5 MHz band employing at least 75 hopping channels, and all frequency hopping systems in the 5725-5850MHz band: 1Watt. For all other frequency hopping systems in the 2400 – 2483.5MHz band: 0.125 Watts.

According to RSS-210 issue 7, §A8.4 (2), For frequency hopping systems operating in the 2400-2483.5 MHz band employing at least 75 hopping channels, the maximum conducted output power shall not exceed 1 W. For all other frequency hopping systems, the maximum peak conducted output power shall not exceed 0.125 W.

Test Procedure:

1. Connect the EUT RF output port to spectrum analyzer via calibrated coaxial cable and suitable attenuator (if necessary).
2. Activates the EUT System and executes the software prepared for test, if necessary.
3. To find out the worst case, the transmitting data rate of EUT is varied with the different modes of operation. The final test condition is recorded in this report.
4. The spectrums are scanned and allow the trace to stabilize.
5. The peak output power was determined by using the marker-data function of spectrum analyzer or peak type power meter.

Spectrum Analyzer Set Up Conditions

Frequency Span : 5 times 20dB bandwidth of the emission being measured

Resolution bandwidth : 1MHz

Video bandwidth : \geq RBW

Sweep : Auto

Detector function : Peak

Trace Mode : Max Hold

Test Result:

Temperature:	25 °C
Humidity:	55%
EUT Operation:	Data Transmission (without hopping)
Test Date:	June 04, 2009

Frequency [MHz]	Factor [dB]	Reading [dBm]	Power [dBm]	Limit [dBm]	Margin [dB]
2415	1.0	9.44	10.44	20.97	10.53
2442	1.0	9.28	10.28	20.97	10.69
2465	1.0	9.84	10.84	20.97	10.13

Note: Test plots shown in figures 5, 6 and 7 on pages17, 18, 19.

Figure 5: Peak Output Power-low channel

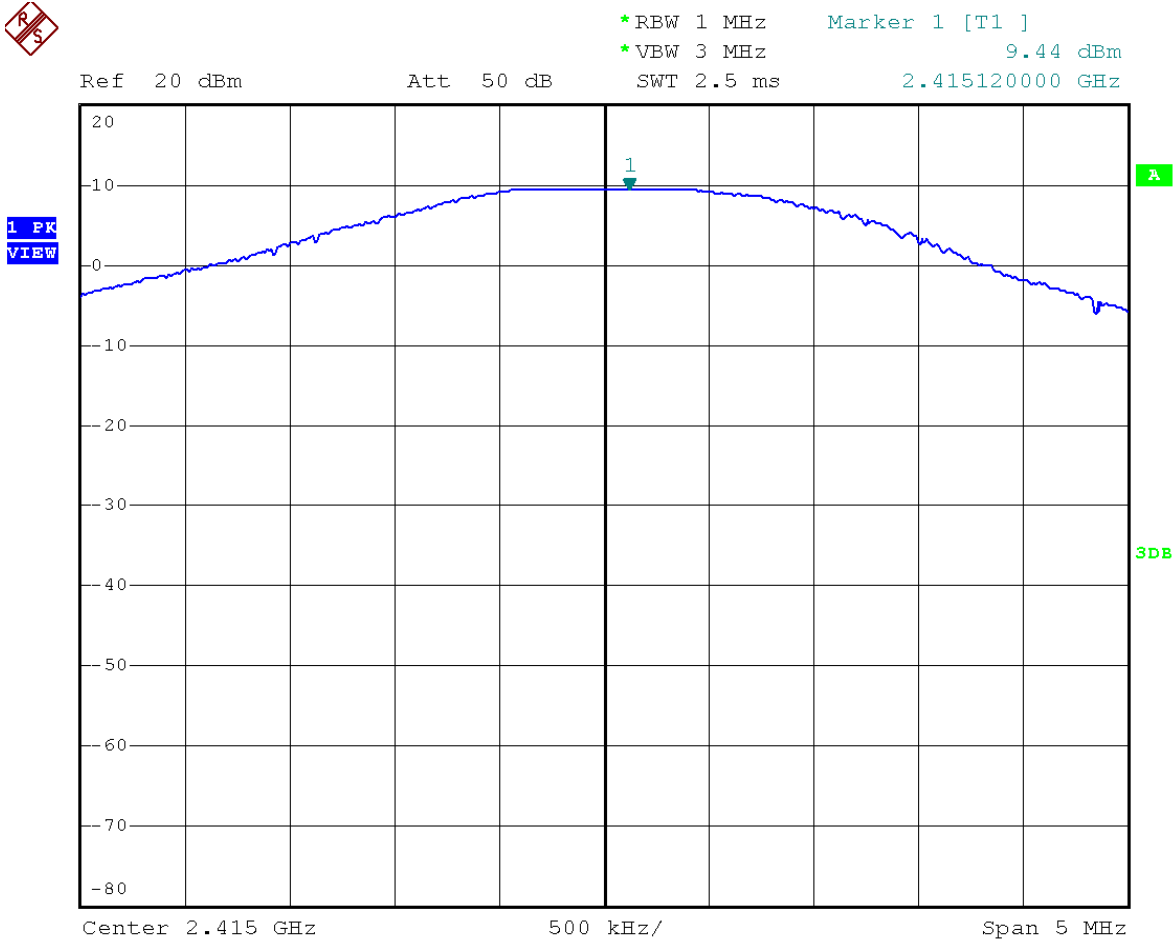

Figure 6: Peak Output Power-mid channel



*RBW 1 MHz Marker 1 [T1]
*VBW 1 MHz 9.28 dBm
SWT 2.5 ms 2.442120000 GHz

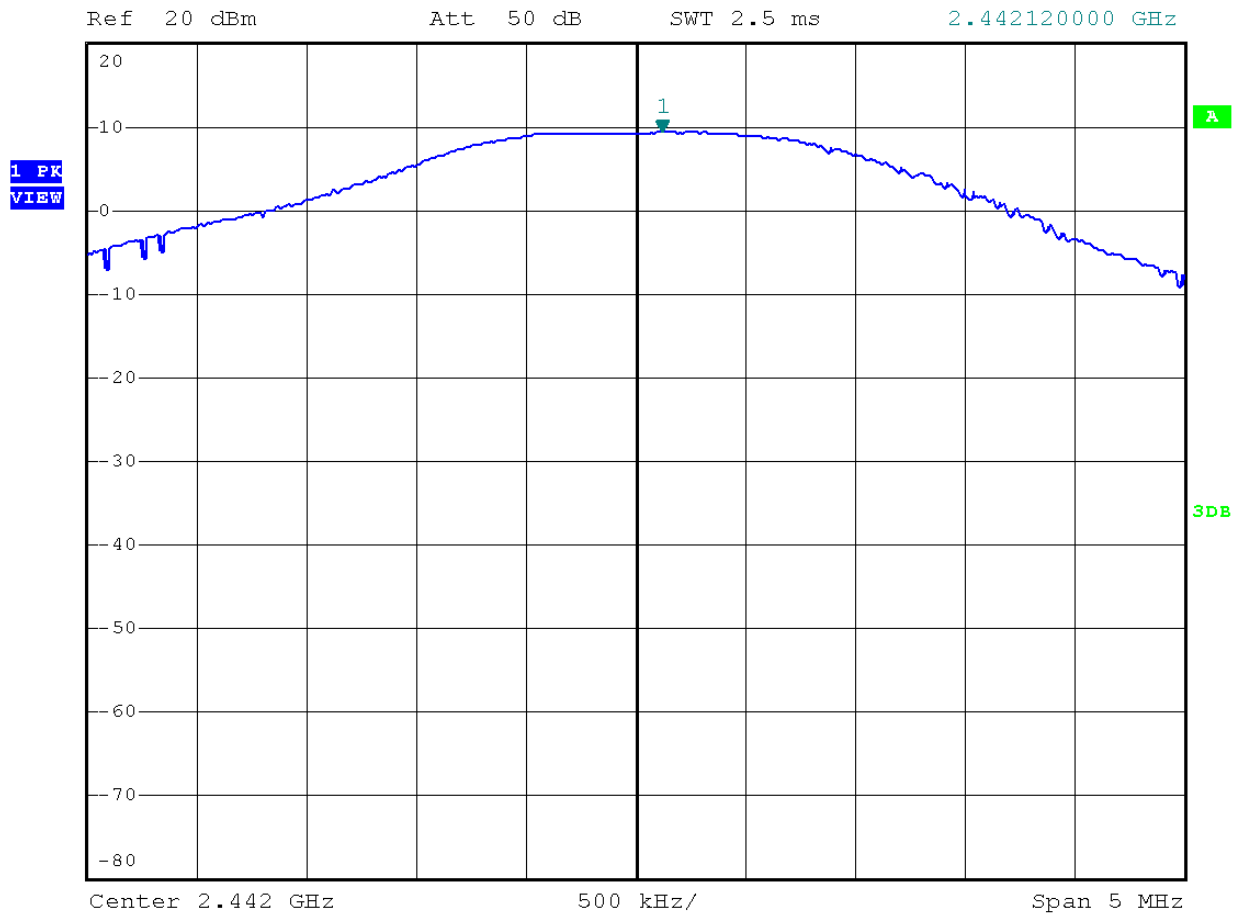
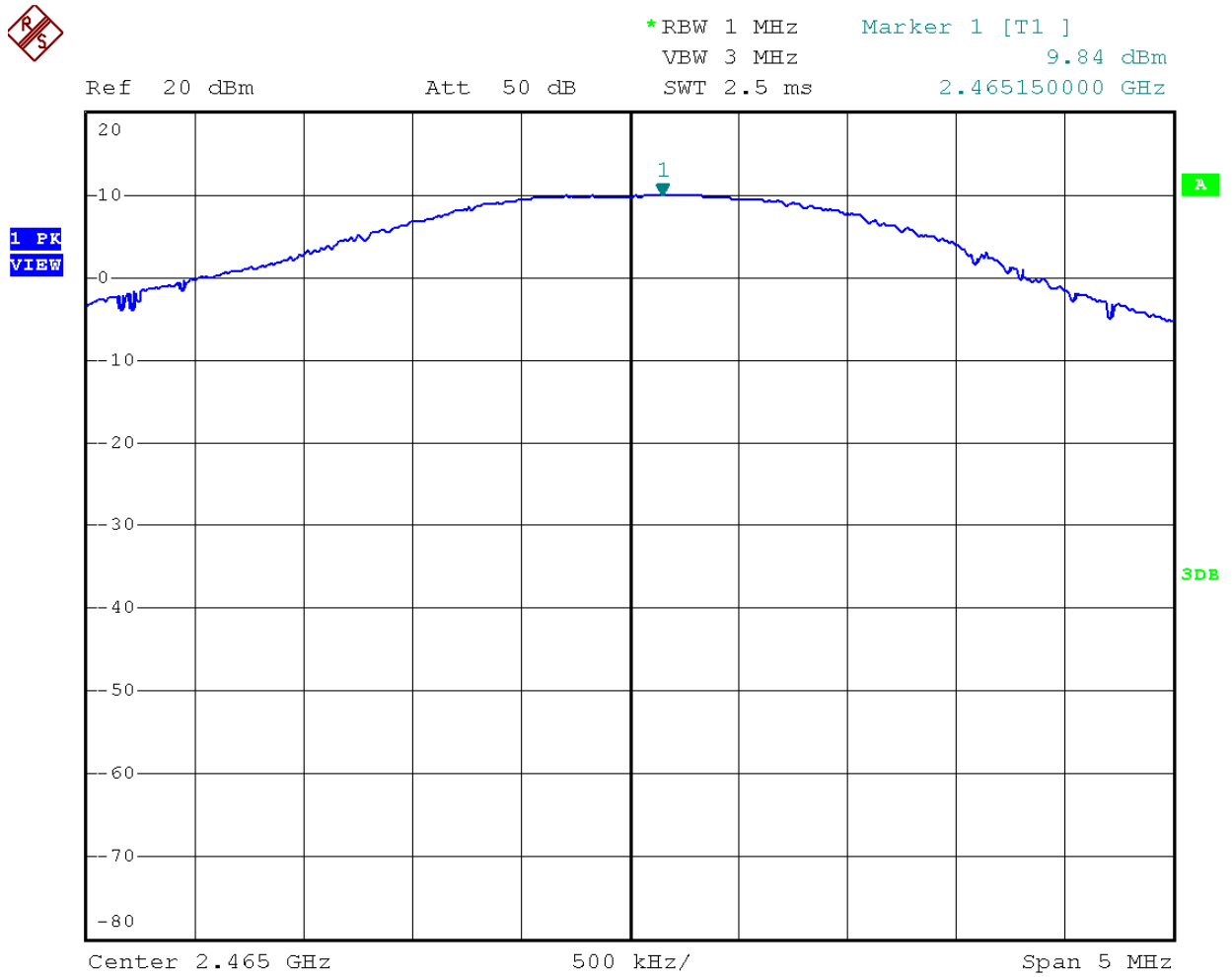

Figure 7: Peak Output Power-high channel



6.5 Band Edge of Conducted Emission and Spurious RF Conducted Emissions

Applicable Standard:

According to §15.247(d), in any 100 KHz bandwidth outside the frequency bands in which the spread spectrum intentional radiator is operating, the radio frequency power that is produced by the intentional radiator shall be at least 20dB below that in the 100KHz bandwidth within the band that contains the highest level of the desired power, In addition, radiated emissions which fall in the restricted bands, as defined in §15.205(a), must also comply with the radiated emission limits specified in 15.209(a).

According to RSS-210 issue 7, §A8.5, In any 100 kHz bandwidth outside the frequency band in which the spread spectrum or digitally modulated device is operating, the radio frequency power that is produced shall be at least 20 dB below that in the 100 kHz bandwidth within the band that contains the highest level of the desired power, based on either an RF conducted or a radiated measurement, provided the transmitter demonstrates compliance with the peak conducted power limits. If the transmitter complies with the conducted power limits based on the use of RMS averaging over a time interval, as permitted under section A8.4(4), the attenuation required shall be 30 dB instead of 20 dB. Attenuation below the general limits specified in Tables 2 and 3 is not required. In addition, radiated emissions which fall in the restricted bands of Table 1 must also comply with the radiated emission limits specified in Tables 2 and 3.

Test Procedure:

1. Connect the EUT RF output port to the spectrum analyzer via calibrated coaxial cable and suitable attenuator (if necessary).
2. Activates the EUT System and executes the software prepared for test, if necessary.
3. To find out the maximum emission condition, the transmitting data rate of EUT is set to maximum data rate.
4. The spectrum are scanned.
5. The emission at the band edge or the highest modulation product outside of band were measured by using the marker function of spectrum analyzer (*1).
6. The peak of the in-band emission were measured by using the marker to peak function of spectrum analyzer.
7. Above measurement were repeated at other side band edge.

Frequency Span : Wide enough to capture the peak level of emission on the band edge

Resolution bandwidth : 100kHz

Video bandwidth : \geq RBW

Sweep : Auto

Detector function : Peak

Trace Mode : Max Hold

Temperature:	25 °C
Humidity:	55%
EUT Operation:	Data Transmission (hopping and without hopping)
Test Date:	June 04, 2009

The unit does meet the requirements. Test data shown in figures 8,9,10,11,12,13,14,15,16,17,18,19,20 on pages 21,22,23,24,25,26 and 27.

Figure 8: Band Edge - low frequency side without hopping

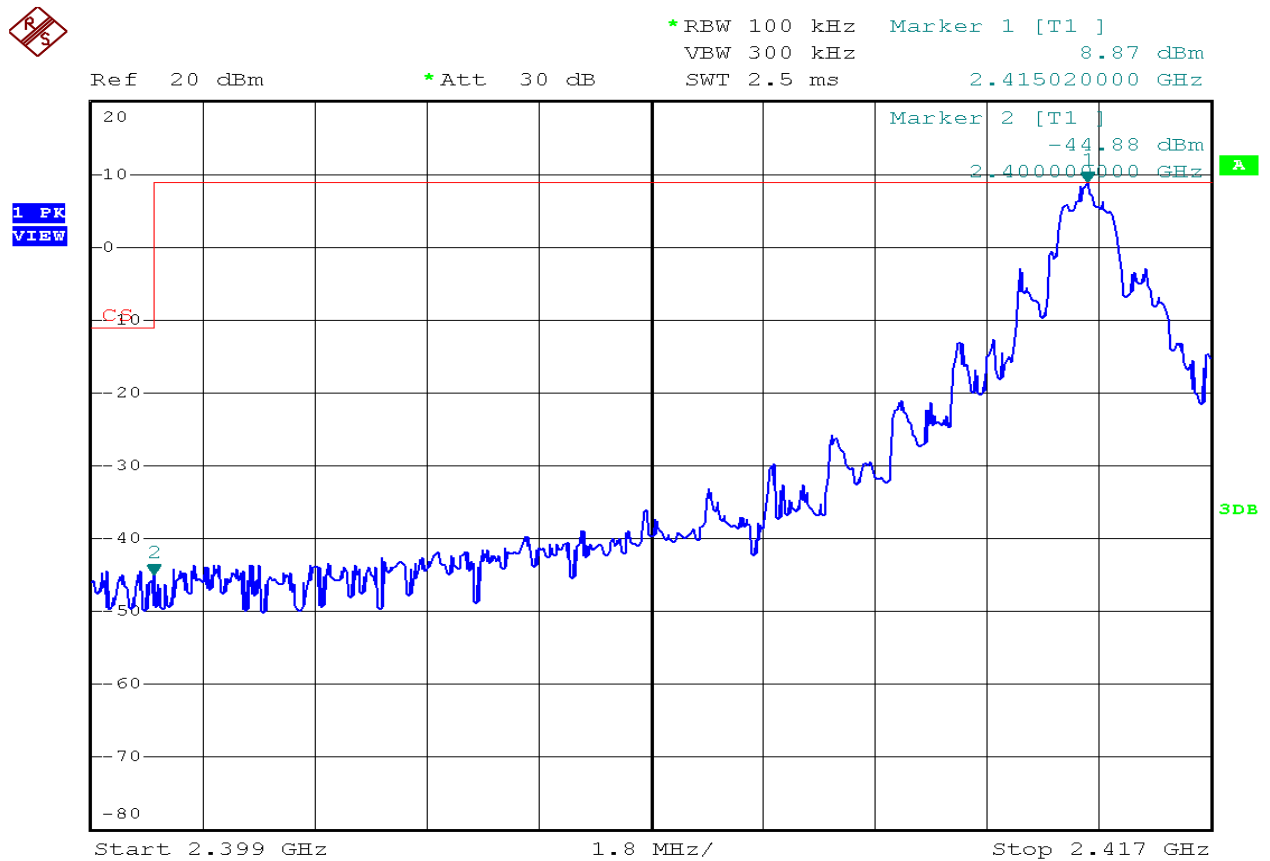

Figure 9: Band Edge – high frequency side without hopping

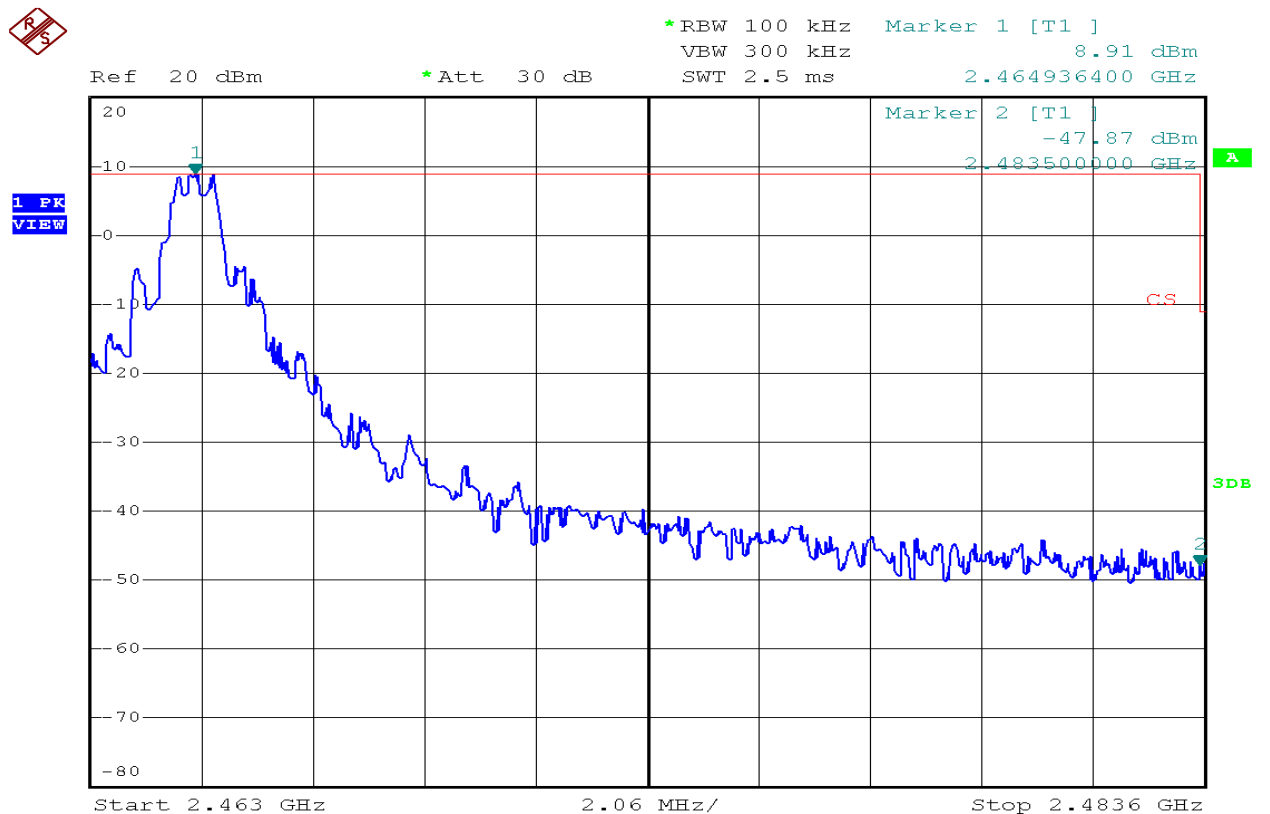

Figure 10: Band Edge – low frequency side with hopping

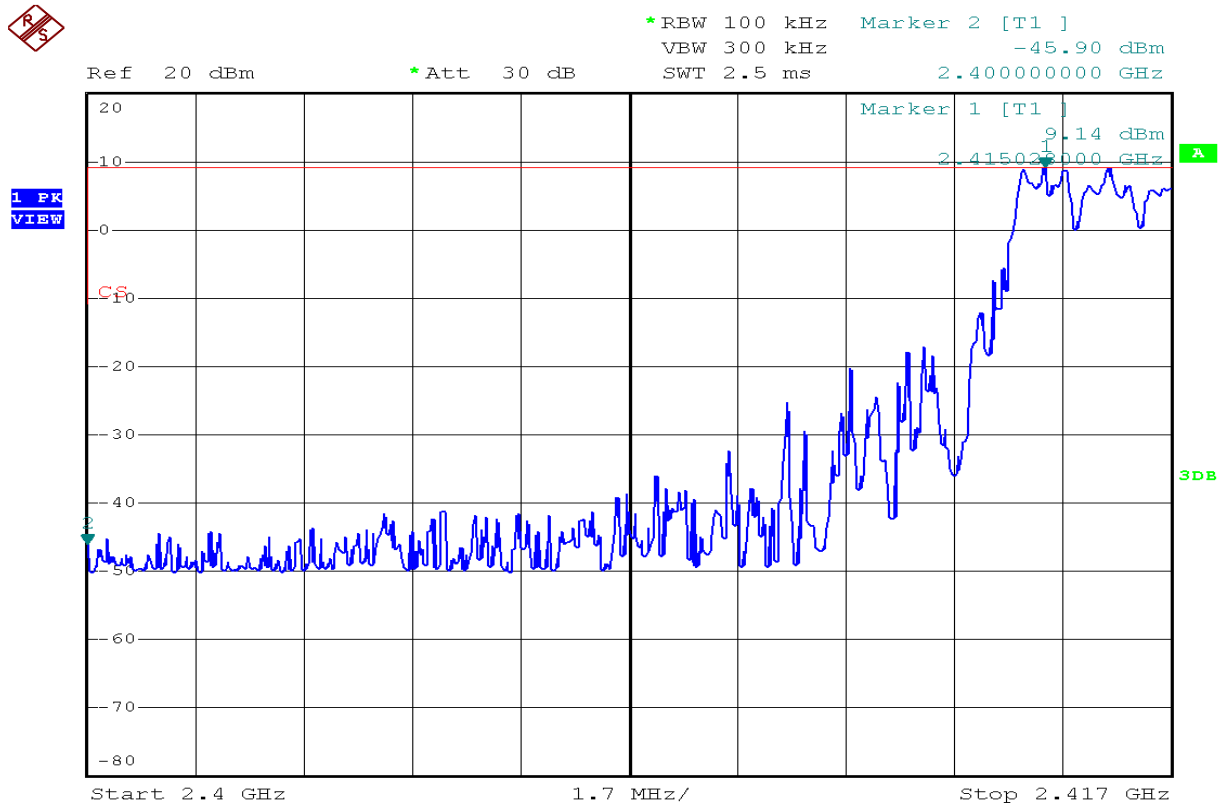

Figure 11: Band Edge – high frequency side with hopping

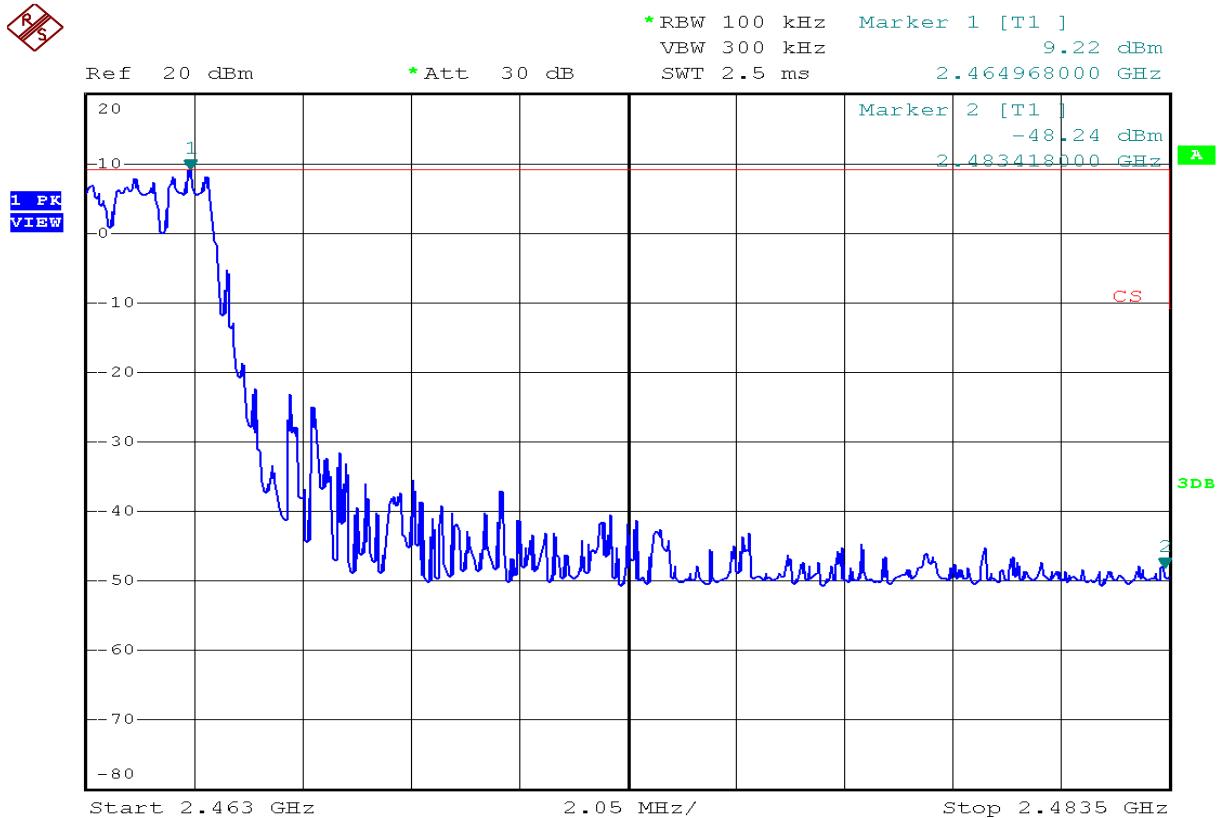

Figure 12: Conducted Spurious Emissions, low channel 30M-2.4GHz

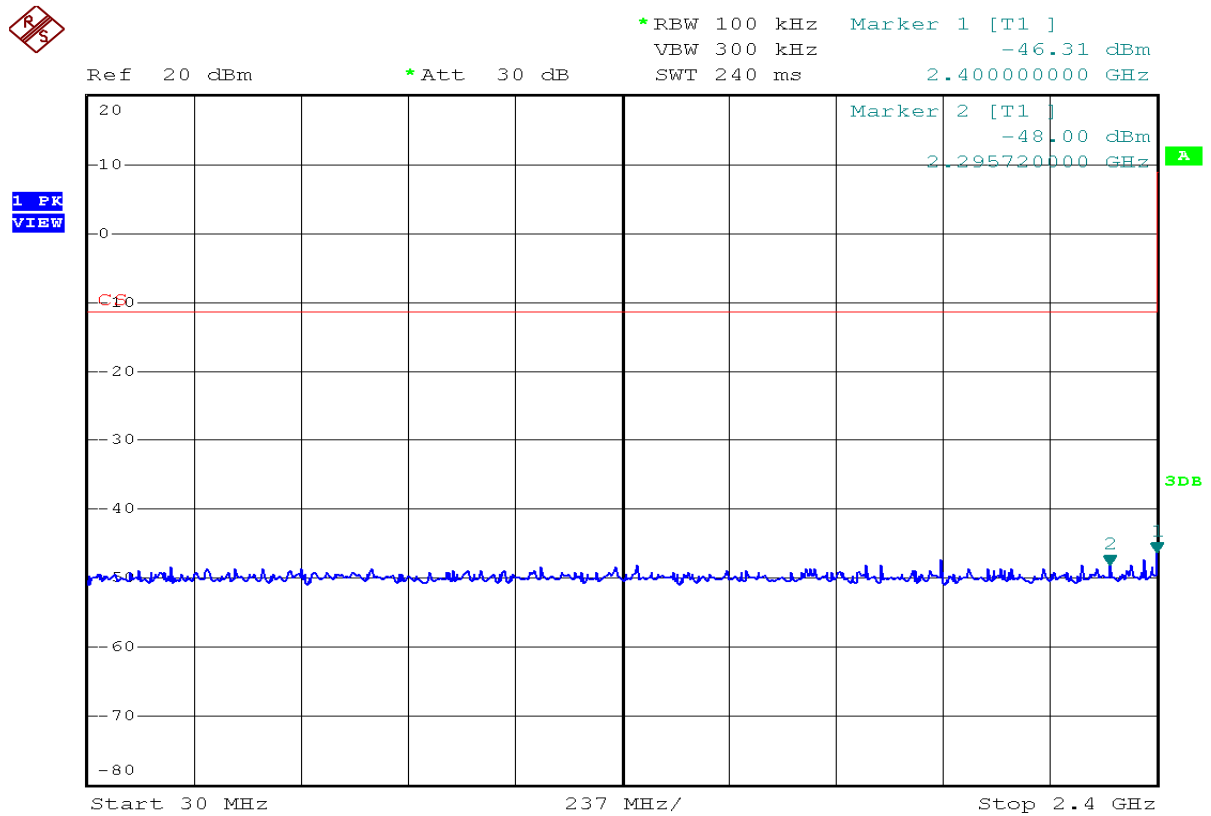

Figure 13: Conducted Spurious Emissions, low channel 2.4G-2.4835GHz

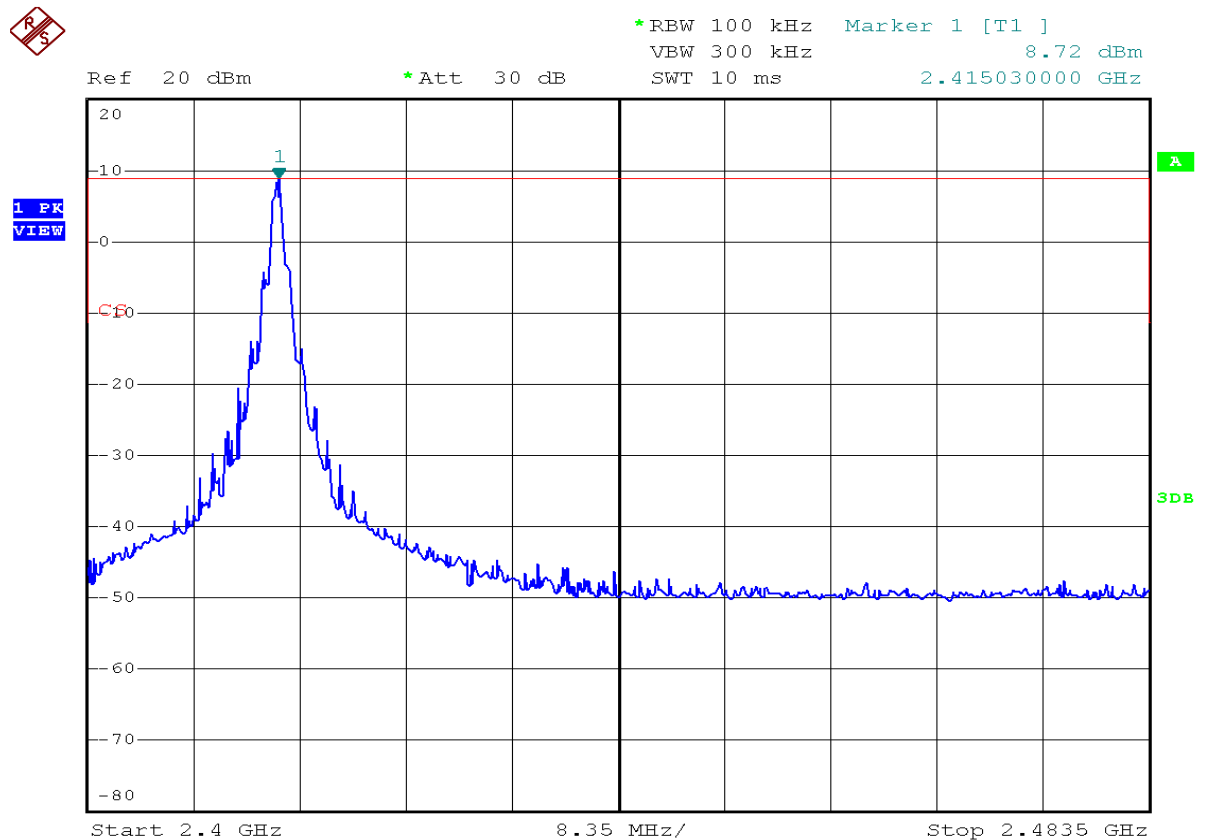

Figure 14: Conducted Spurious Emissions, low channel 2.4835G-25GHz

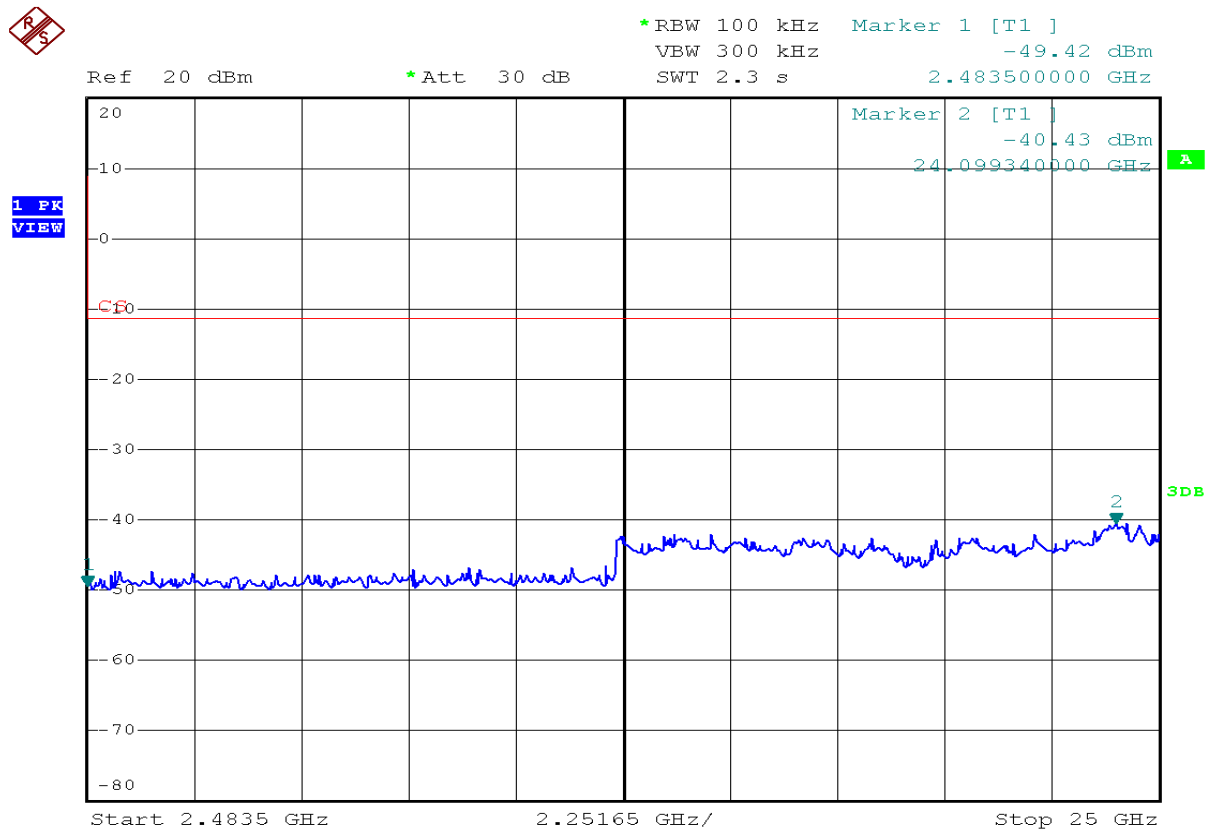

Figure 15: Conducted Spurious Emissions, middle channel 30M-2.4GHz

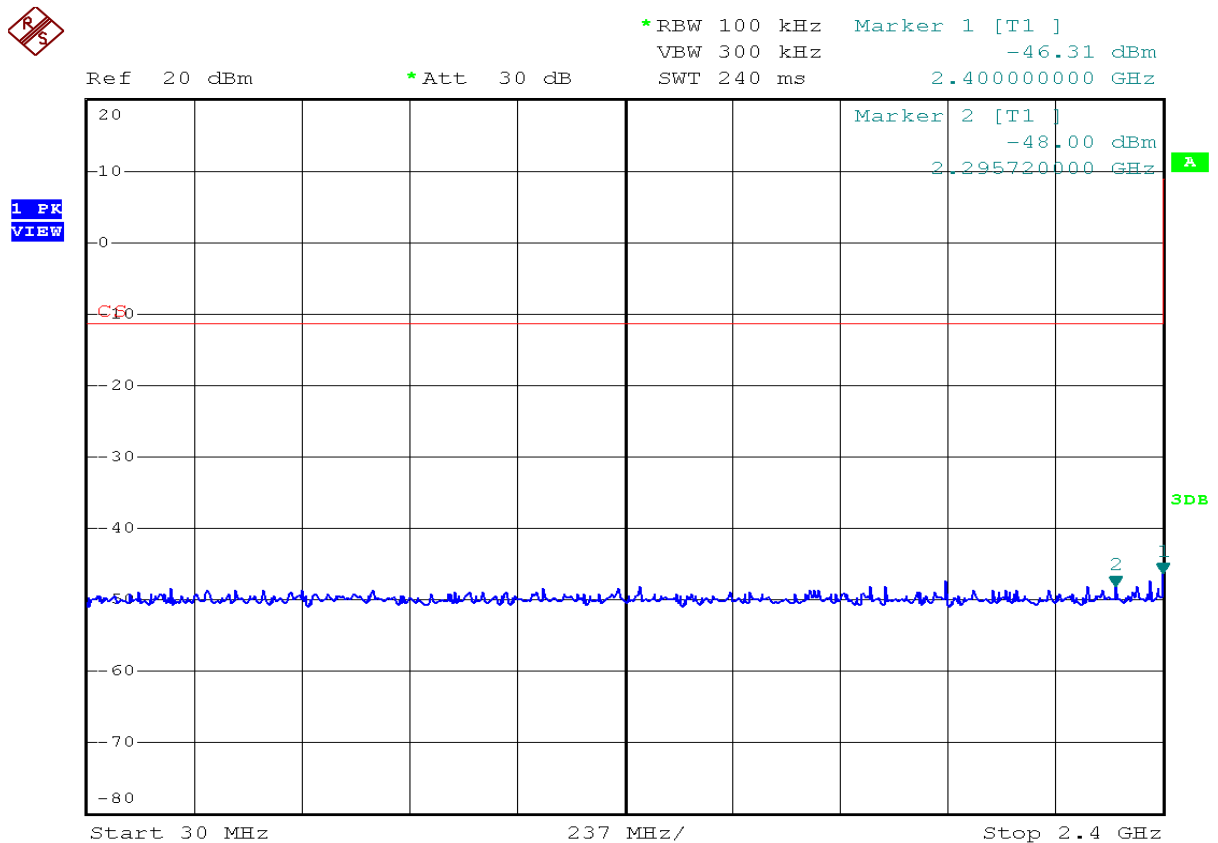

Figure 16: Conducted Spurious Emissions, middle channel 2.4G-2.4835GHz

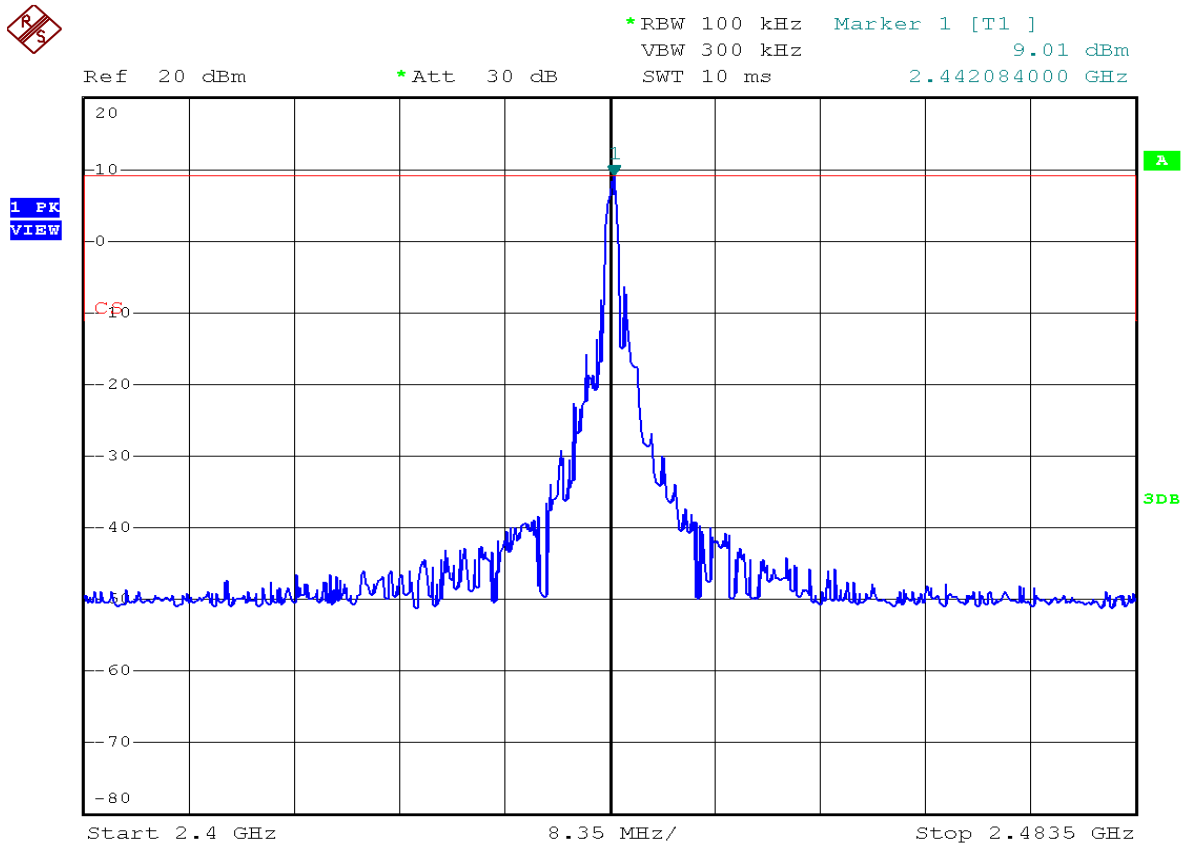

Figure 17: Conducted Spurious Emissions, middle channel 2.4835G-25GHz

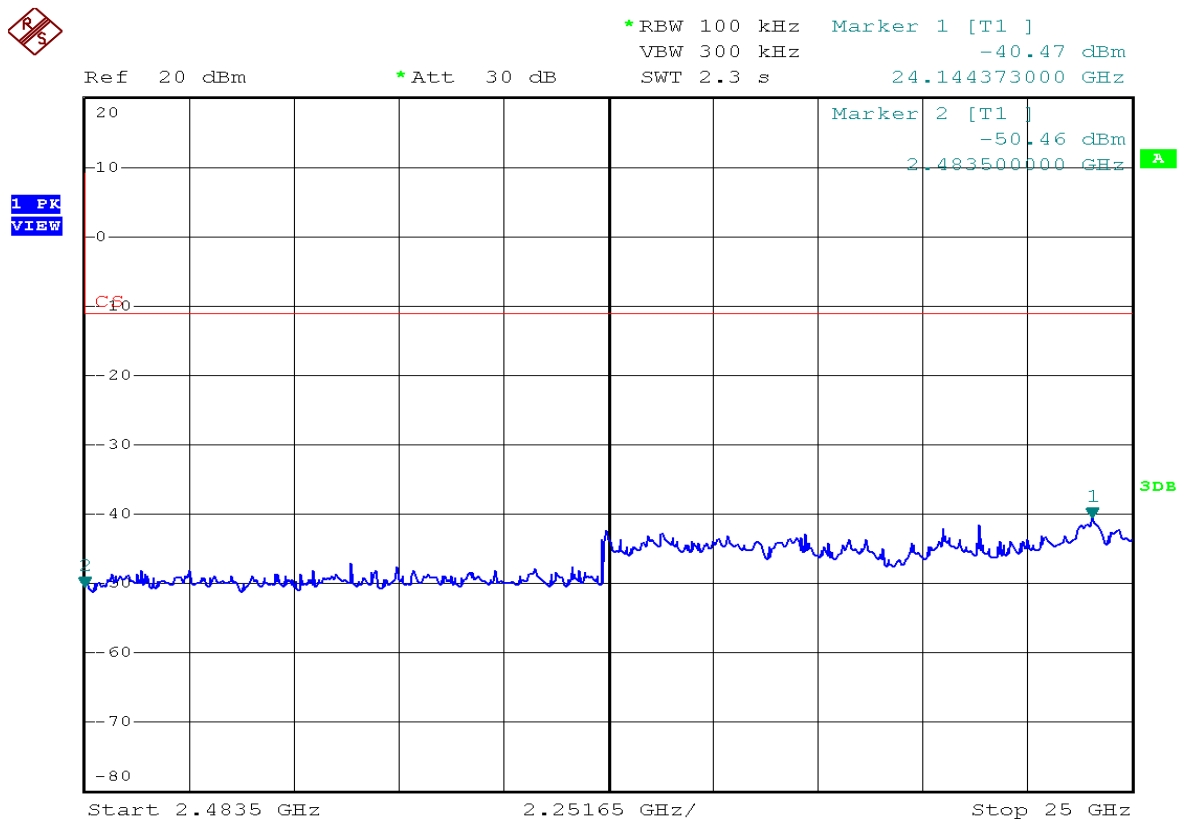

Figure 18: Conducted Spurious Emissions, high channel 30M-2.4GHz

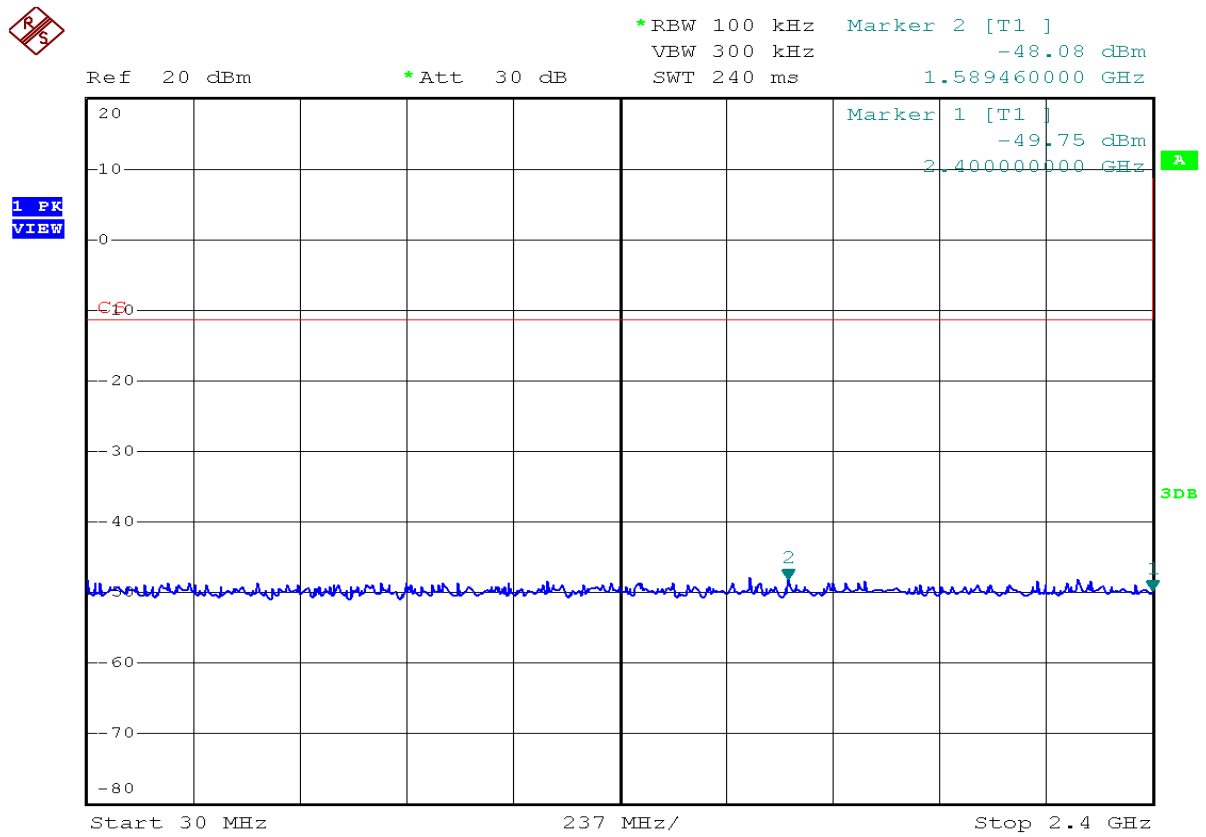

Figure 19: Conducted Spurious Emissions, high channel 2.4G-2.4835GHz

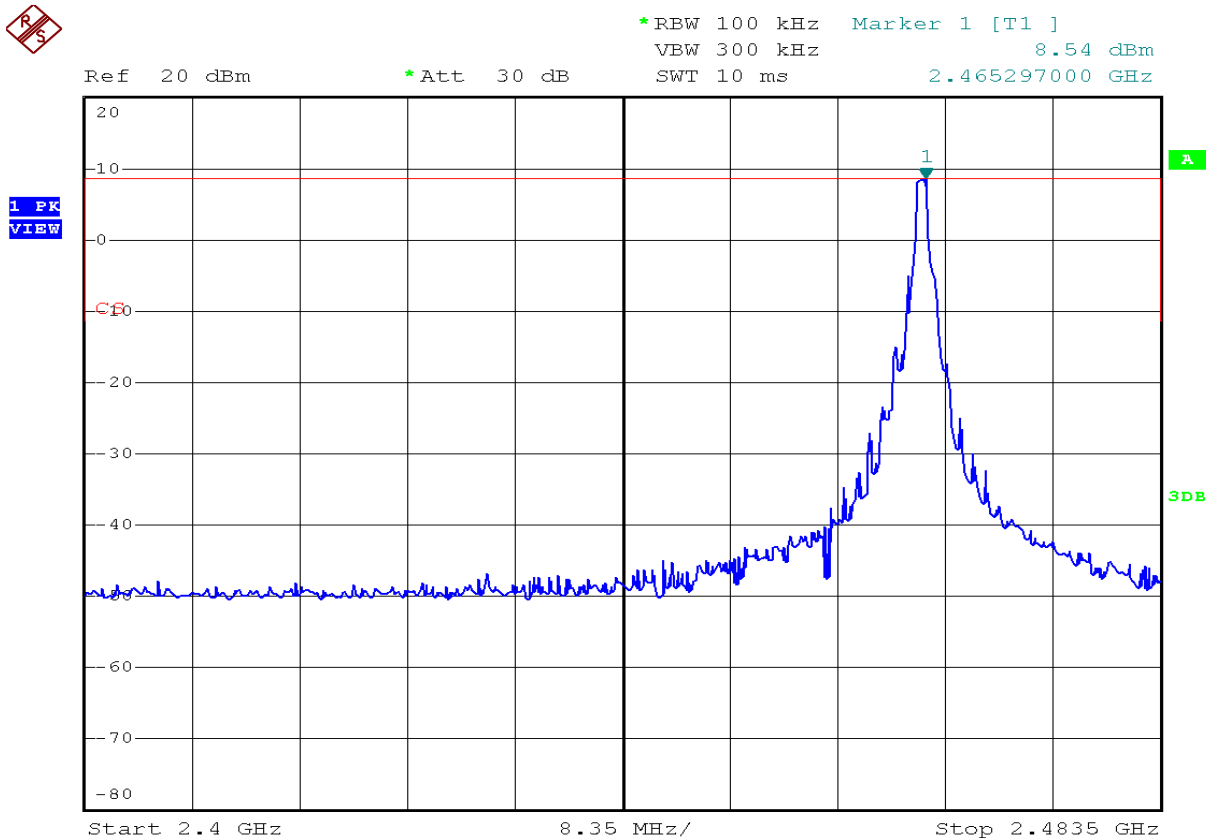
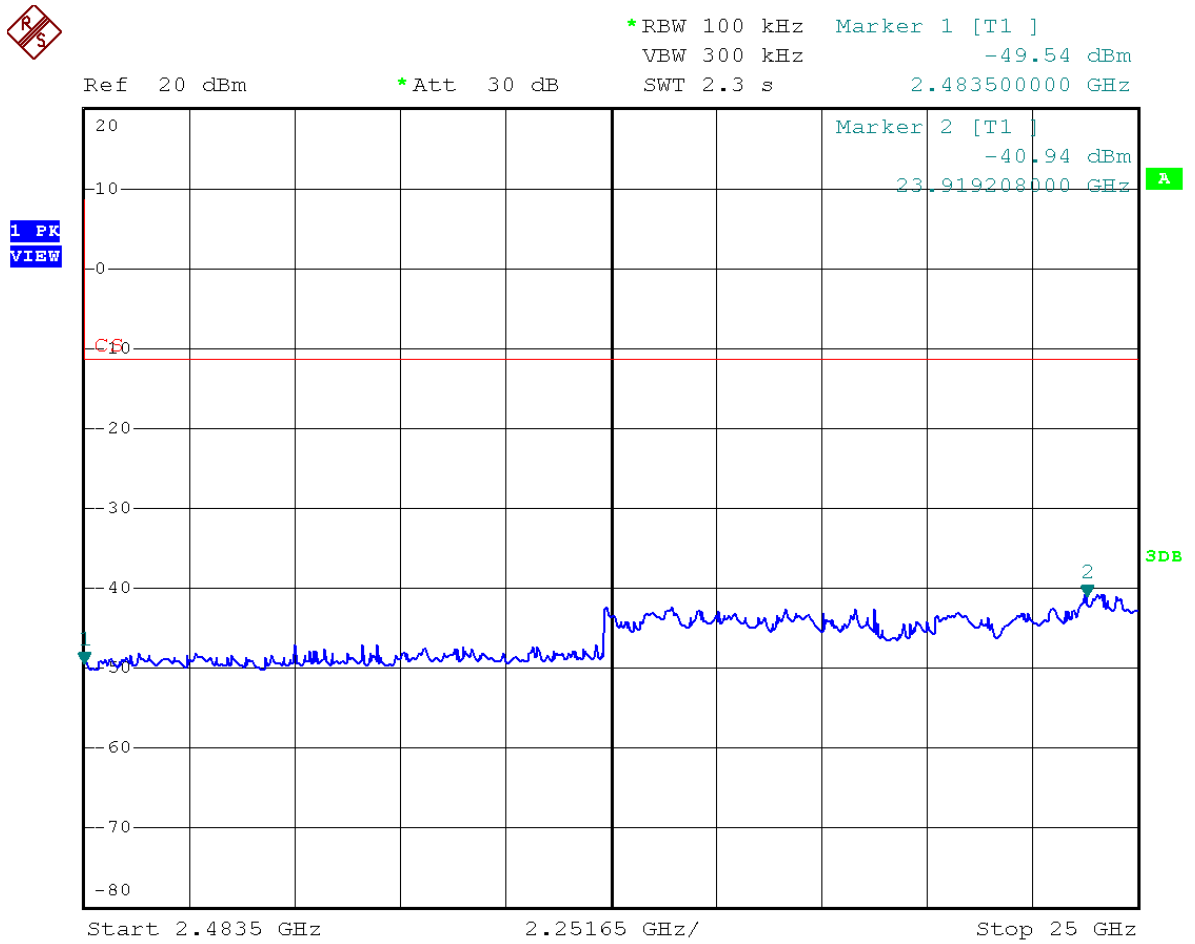

Figure 20: Conducted Spurious Emissions, high channel 2.4835G-25GHz



6.6 Spurious Radiated Emission Measurement

Applicable Standard:

According to §15.247(c), all other emissions outside these bands shall not exceed the general radiated emission limits specified in §15.209(a). And according to §15.33(a)(1), for an intentional radiator operates below 10GHz, the frequency range of measurements: to the tenth harmonic of the highest fundamental frequency or to 40GHz, whichever is lower.

According to RSS-210 issue 7, §A8.5, in any 100 kHz bandwidth outside the frequency band in which the spread spectrum or digitally modulated device is operating, the radio frequency power that is produced shall be at least 20 dB below that in the 100 kHz bandwidth within the band that contains the highest level of the desired power, based on either an RF conducted or a radiated measurement, provided the transmitter demonstrates compliance with the peak conducted power limits. If the transmitter complies with the conducted power limits based on the use of RMS averaging over a time interval, as permitted under section A8.4(4), the attenuation required shall be 30 dB instead of 20 dB. Attenuation below the general limits specified in Tables 2 and 3 is not required. In addition, radiated emissions which falls in the restricted bands of Table 1 must also comply with the radiated emission limits specified in Tables 2 and 3.

Test Procedure:

1. The EUT was placed on a turn table which is 0.8m above ground plane.
2. The turn table shall rotate 360 degrees to determine the position of maximum emission level.
3. EUT is set 3m away from the receiving antenna which varied from 1m to 4m to find out the highest emissions.
4. Maximum procedure was performed on the six highest emissions to ensure EUT compliance.
5. And also, each emission was to be maximized by changing the polarization of receiving antenna both horizontal and vertical.
6. Repeat above procedures until all frequency measured were complete.

The field strength is calculated by adding the Antenna Factor and Cable Factor and subtracting the Amplifier Gain and Duty Cycle Correction Factor(if any) from the measured reading. The basic equation with a sample calculation is as follows:

$$FS = RA + AF + CL - AG$$

Where FS = Field Strength	CL = Cable Attenuation Factor (Cable Loss)
RA = Reading Amplitude	AG = Amplifier Gain
AF = Antenna Factor	

Test Configuration Below 1 GHz:

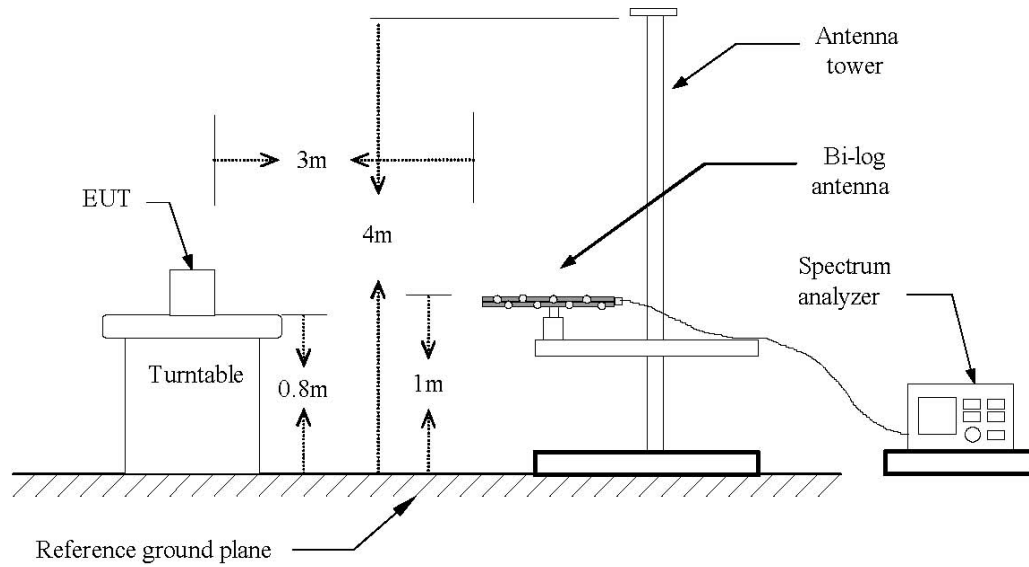

Test Configuration Above 1 GHz:

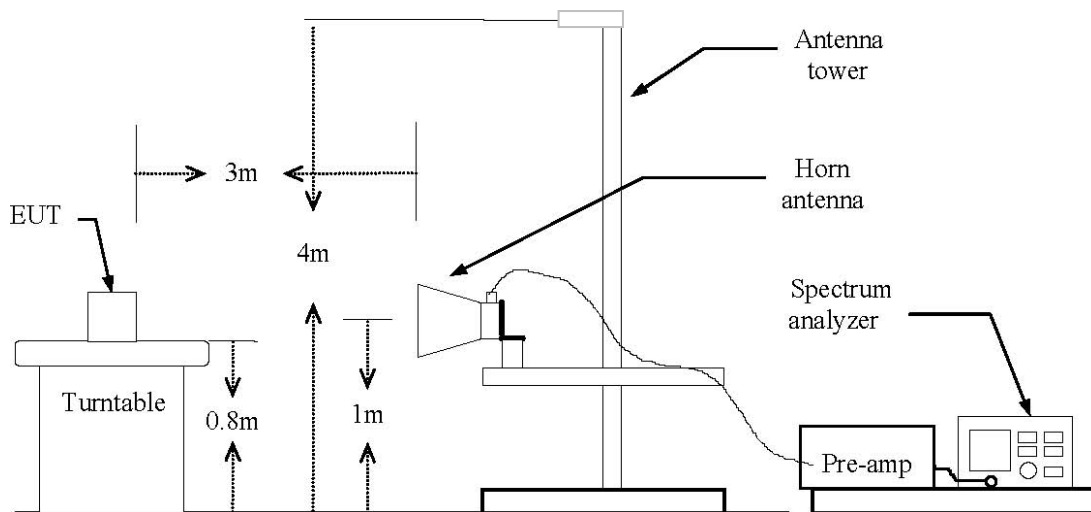

Test Results:

Temperature:	25°C
Humidity:	55%
EUT Operation:	Data Transmission (without hopping)
Test Date:	June 04, 2009

Spurious Emission In the Frequency Rang Below 1GHz:

Fc= 2415MHz Transmitting Operation

Freq. (MHz)	Ant.Pol. (H/V)	Detector Mode (PK/QP)	Reading (dBuV)	Ant./CL/ Amp.CF (dB)	Actual FS (dBuV/m)	Limit 3m (dBuV/m)	Margin (dB)
37.75	H	QP	1.6	12.4	14.0	40.0	-26.0
640.45	H	QP	-1.3	19.4	18.1	46.0	-27.9
934.65	H	QP	-2.4	23.5	21.1	46.0	-24.9
34.70	V	QP	-3.3	17.1	13.8	40.0	-26.2
617.70	V	QP	-1.2	19.4	18.2	46.0	-27.8

Fc= 2442MHz Transmitting Operation

Freq. (MHz)	Ant.Pol. (H/V)	Detector Mode (PK/QP)	Reading (dBuV)	Ant./CL/ Amp.CF (dB)	Actual FS (dBuV/m)	Limit 3m (dBuV/m)	Margin (dB)
37.75	H	QP	1.7	12.4	14.1	40.0	-25.9
43.40	H	QP	7.6	12.4	20.0	40.0	-20.0
632.45	H	QP	-1.2	19.4	18.2	46.0	-27.8
34.50	V	QP	-3.3	17.1	13.8	40.0	-26.2
44.10	V	QP	11.5	12.4	23.9	40.0	-16.1
694.30	V	QP	-3.3	21.3	18.0	46.0	-28.0
953.35	V	QP	-3.2	25.0	21.8	46.0	-24.2

Fc= 2465MHz Transmitting Operation

Freq. (MHz)	Ant.Pol. (H/V)	Detector Mode (PK/QP)	Reading (dBuV)	Ant./CL/ Amp.CF (dB)	Actual FS (dBuV/m)	Limit 3m (dBuV/m)	Margin (dB)
32.70	H	QP	-3.8	17.1	13.3	40.0	-26.7
43.40	H	QP	8.5	12.4	20.9	40.0	-19.1
679.30	H	QP	-3.6	21.3	17.7	46.0	-28.3
35.70	V	QP	1.5	12.4	13.9	40.0	-26.1
640.10	V	QP	-1.3	19.4	18.1	46.0	-27.9
958.00	V	QP	-3.3	25.0	21.7	46.0	-24.3

Note: For spurious emission measurement, the compliance tests were performed both of horizontally placed and vertically placed in EUT (X position, Y position, Z position). As a result, the data of operation mode that produce the maximum emission were reported. The other emissions are more than 30dB below the limit.

Spurious Emission In the Frequency Rang above 1GHz:

Fc= 2415MHz Transmitting Operation- Horizontal

Freq. (MHz)	Peak Reading (dBuV)	AV Reading (dBuV)	Ant./CL/ Amp.CF (dB)	Actual FS		Peak Limit (dBuV/m)	AV Limit (dBuV/m)	Margin
				Peak (dBuV/m)	AV (dBuV/m)			
4264.00	48.88	-	1.14	50.02	-	74.00	54.00	-23.98
5224.00	50.29	-	0.92	51.21	-	74.00	54.00	-22.79
9784.00	47.30	-	7.71	55.01	-	74.00	54.00	-18.99
-	-	-	-	-	-	-	-	-

Fc= 2415MHz Transmitting Operation- Vertical

Freq. (MHz)	Peak Reading (dBuV)	AV Reading (dBuV)	Ant./CL/ Amp.CF (dB)	Actual FS		Peak Limit (dBuV/m)	AV Limit (dBuV/m)	Margin
				Peak (dBuV/m)	AV (dBuV/m)			
7240.00	49.62	-	4.44	54.06	-	74.00	54.00	-19.94
9640.00	43.57	-	6.69	50.26	-	74.00	54.00	-23.74
17416.00	47.51	-	16.08	63.59	-	74.00	54.00	-10.41
-	-	-	-	-	-	-	-	-

Note: Data of measurement within this frequency range shown “---” in the table above means the reading of emissions are attenuated more than 30dB below the permissible limits or the field strength is too small to be measured.

Fc= 2442MHz Transmitting Operation- Horizontal

Freq. (MHz)	Peak Reading (dBuV)	AV Reading (dBuV)	Ant./CL/ Amp.CF (dB)	Actual FS		Peak Limit (dBuV/m)	AV Limit (dBuV/m)	Margin
				Peak (dBuV/m)	AV (dBuV/m)			
4888.00	48.51	-	0.92	49.43	-	74.00	54.00	-24.57
8008.00	46.47	-	4.14	50.61	-	74.00	54.00	-23.39
9784.00	47.21	-	7.71	54.92	-	74.00	54.00	-19.08
-	-	-	-	-	-	-	-	-

Fc= 2442MHz Transmitting Operation- Vertical

Freq. (MHz)	Peak Reading (dBuV)	AV Reading (dBuV)	Ant./CL/ Amp.CF (dB)	Actual FS		Peak Limit (dBuV/m)	AV Limit (dBuV/m)	Margin
				Peak (dBuV/m)	AV (dBuV/m)			
1720.00	53.79	-	-9.62	44.17	-	74.00	54.00	-29.83
2872.00	47.83	-	-1.38	46.45	-	74.00	54.00	-27.55
4888.00	66.38	-	0.92	67.30	-	74.00	54.00	-6.70
7336.00	56.95	-	4.22	61.17	-	74.00	54.00	-12.83
-	-	-	-	-	-	-	-	-

Note: Data of measurement within this frequency range shown “---” in the table above means the reading of emissions are attenuated more than 30dB below the permissible limits or the field strength is too small to be measured.

Fc= 2465MHz Transmitting Operation- Horizontal

Freq. (MHz)	Peak Reading (dBuV)	AV Reading (dBuV)	Ant./CL/ Amp.CF (dB)	Actual FS		Peak Limit (dBuV/m)	AV Limit (dBuV/m)	Margin
				Peak (dBuV/m)	AV (dBuV/m)			
2248.00	75.58	-	-7.25	68.33	-	74.00	54.00	-5.67
3208.00	56.26	-	-1.38	54.90	-	74.00	54.00	-19.10
4936.00	51.08	-	0.92	52.00	-	74.00	54.00	-22.00
5368.00	48.93	-	3.70	52.63	-	74.00	54.00	-21.37
-	-	-	-	-	-	-	-	-

Fc= 2465MHz Transmitting Operation- Vertical

Freq. (MHz)	Peak Reading (dBuV)	AV Reading (dBuV)	Ant./CL/ Amp.CF (dB)	Actual FS		Peak Limit (dBuV/m)	AV Limit (dBuV/m)	Margin
				Peak (dBuV/m)	AV (dBuV/m)			
1768.00	66.43	-	-7.25	59.18	-	74.00	54.00	-14.82
2872.00	56.63	-	-1.38	55.25	-	74.00	54.00	-18.75
4936.00	66.59	-	0.92	67.51	-	74.00	54.00	-6.49
7384.00	56.26	-	4.22	60.48	-	74.00	54.00	-13.52
-	-	-	-	-	-	-	-	-

Note: Data of measurement within this frequency range shown “---” in the table above means the reading of emissions are attenuated more than 30dB below the permissible limits or the field strength is too small to be measured.

6.7 Band Edge and Restricted Band of Radiated Emission Measurement

Applicable Standard:

According to §15.247(d), radiated emissions which fall in the restricted bands, as defined in §15.205(a), must also comply with the radiated emission limits specified in 15.209(a).

According to RSS-210 issue 7, §A8.5, radiated emissions which fall in the restricted bands of Table 1 must also comply with the radiated emission limits specified in Tables 2 and 3.

According to DA 00-705, in making radiated band-edge measurements, the following technique for determining band-edge compliance.

Step 1) Perform an in-band field strength measurement of the fundamental emission using the RBW and detector function required by C63.4 and our Rules for the frequency being measured. For transmitters operating above 1 GHz, use a 1 MHz RBW, a 1 MHz VBW, and a peak detector (as required by Section 15.35). Repeat the measurement with an average detector (i.e., 1 MHz RBW with 10 Hz VBW).

Step 2) Choose a spectrum analyzer span that encompasses both the peak of the fundamental emission and the band-edge emission under investigation. Set the analyzer RBW to 1% of the total span (but never less than 30 kHz) with a video bandwidth equal to or greater than the RBW. Record the peak levels of the fundamental emission and the relevant band-edge emission (i.e., run several sweeps in peak hold mode). Observe the stored trace and measure the amplitude delta between the peak of the fundamental and the peak of the band-edge emission. This is not a field strength measurement, it is only a relative measurement to determine the amount by which the emission drops at the band-edge relative to the highest fundamental emission level.

Step 3) Subtract the delta measured in step (2) from the field strengths measured in step (1). The resultant field strengths (CISPR QP, average, or peak, as appropriate) are then used to determine band-edge compliance as required by Section 15.205.

Step 4) The above "delta" measurement technique may be used for measuring emissions that are up to two "standard" bandwidths away from the band-edge, where a "standard" bandwidth is the bandwidth specified by C63.4 for the frequency being measured.

Test Procedure:

1. The EUT was placed on a turn table which is 0.8m above ground plane.
2. The turn table shall rotate 360 degrees to determine the position of maximum emission level.
3. EUT is set 3m away from the receiving antenna which varied from 1m to 4m to find out the highest emissions.
4. Maximum procedure was performed on the highest emissions in restricted band to ensure EUT compliance.

The field strength is calculated by adding the Antenna Factor and Cable Factor and subtracting the Amplifier Gain and Duty Cycle Correction Factor(if any) from the measured reading. The basic equation with a sample calculation is as follows:

$$FS = RA + AF + CL - AG$$

Where FS = Field Strength	CL = Cable Attenuation Factor (Cable Loss)
RA = Reading Amplitude	AG = Amplifier Gain
AF = Antenna Factor	

Test Results:

Temperature:	21°C
Humidity:	52%
EUT Operation:	Data Transmission (without hopping)
Test Date:	June 05, 2009

The unit does meet the requirements. Test plots shown in figures 21,22,23,24 on pages 36, 37..

The Peak Electric Field Strength at Low Channel and High Channel

Frequency (MHz)	Peak Reading (dBuV)	AV Reading (dBuV)	Ant./CL/ Amp.CF (dB)	Actual FS	
				Peak (dBuV/m)	AV (dBuV/m)
2415	106.24	-	-5.61	100.63	-
2465	110.16	-	-4.41	105.75	-

Note: Refer to figures 21, 22.

Band Edge of Radiated Emission – Low frequency side (2390 –2400MHz)

Refer to above table, the peak electric field strength at 2415 MHz is 100.63 dBuV/m. Because the signal at 2396.242 MHz is 38.92 dB down(Figure 23), its peak Field Strength is 61.71 dBuV/m. This is less than the peak limit of 74 dBuV/m at that frequency. Therefore the EUT passes this requirement.

Upper Restricted Band Passing Margin, Peak = 74 – 61.71 = 12.29 dB

Restricted Band of Radiated Emission – Low frequency side (2310 –2390MHz)

Refer to above table, the peak electric field strength at 2415 MHz is 100.63 dBuV/m. Because the signal at 2385.328 MHz is 43.65 dB down(Figure 23), its peak Field Strength is 55.57 dBuV/m. This is less than the peak limit of 74 dBuV/m at that frequency. Therefore the EUT passes this requirement.

Upper Restricted Band Passing Margin, Peak = 74 – 55.57= 18.43 dB

Band Edge and Restricted Band of Radiated Emission – High frequency side (2483.5 –2500MHz)

Refer to above table, the peak electric field strength at 2465 MHz is 105.75 dBuV/m. Because the signal at 2483.794 MHz is 50.18 dB down(Figure 24), its peak Field Strength is 55.65 dBuV/m. This is less than the peak limit of 74 dBuV/m at that frequency. Therefore the EUT passes this requirement.

Upper Restricted Band Passing Margin, Peak = 74 – 55.65 = 18.35 dB

Note: The average radiated value is too low to measurement.

Figure 21 Peak Electric Field Strength at Low Channel 2415MHz

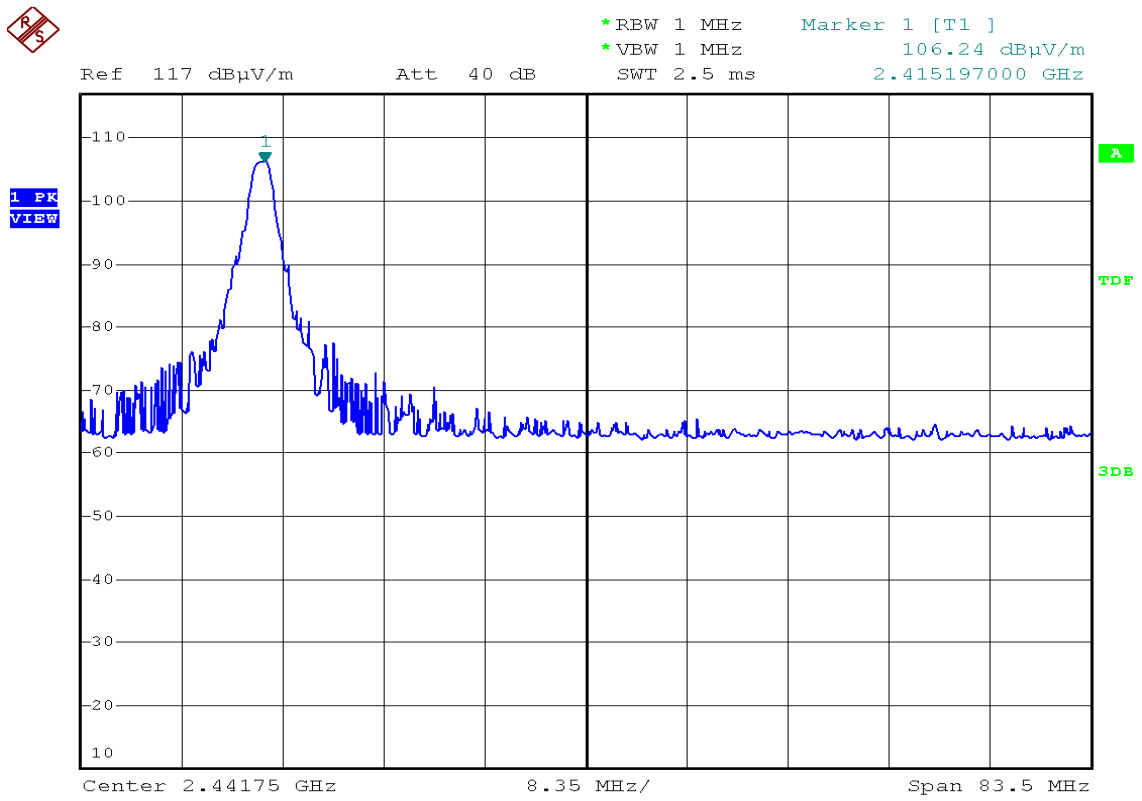

Figure 22 Peak Electric Field Strength at High Channel 2465MHz

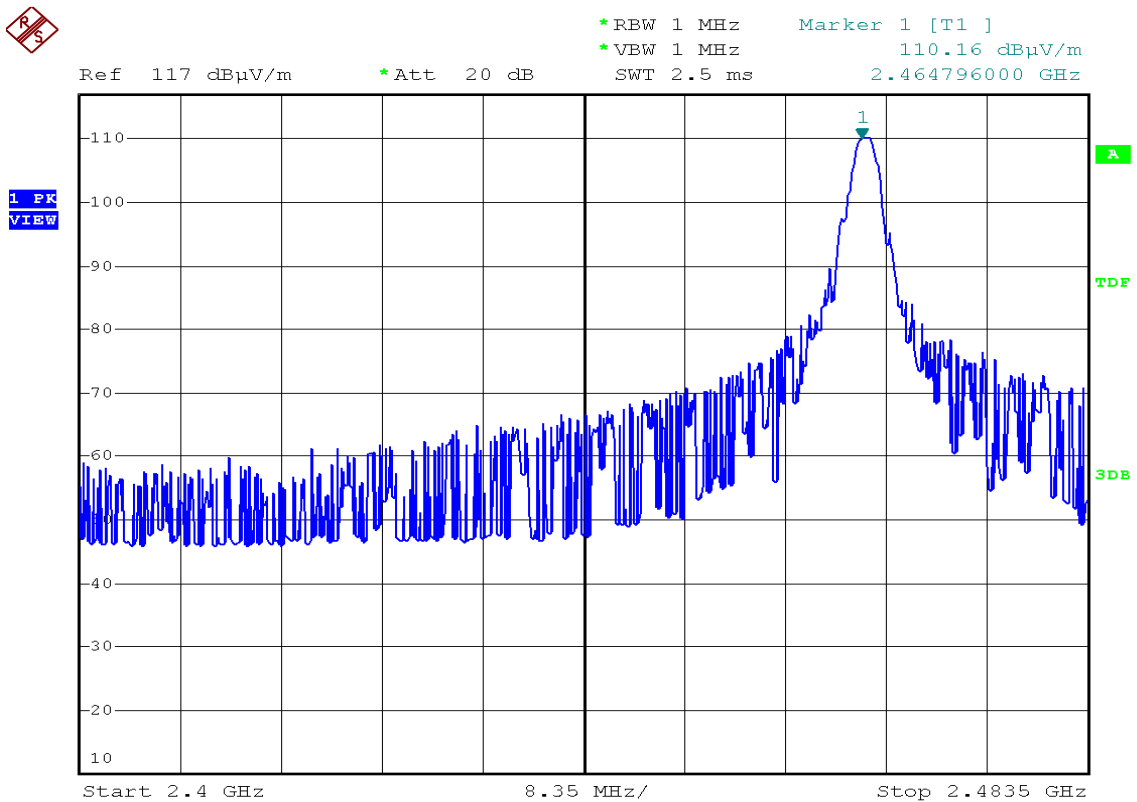

Figure 23 Band Edge of Radiated Emission – Low frequency side without hopping

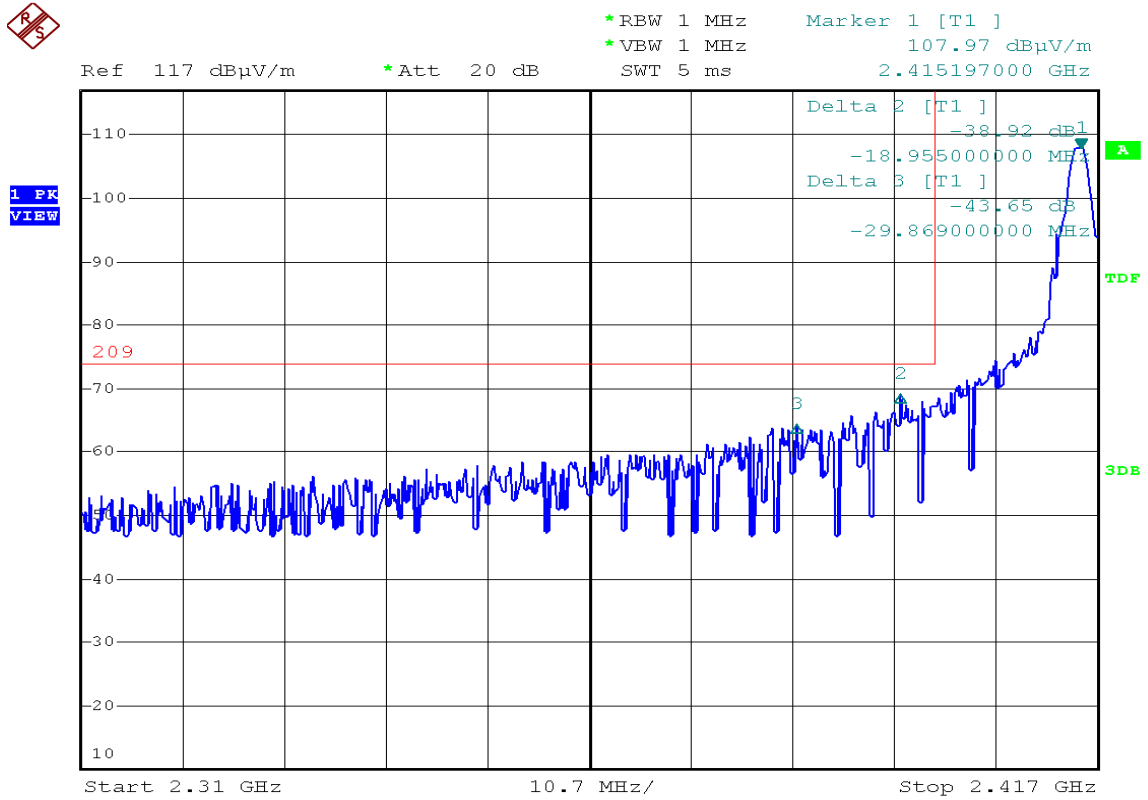
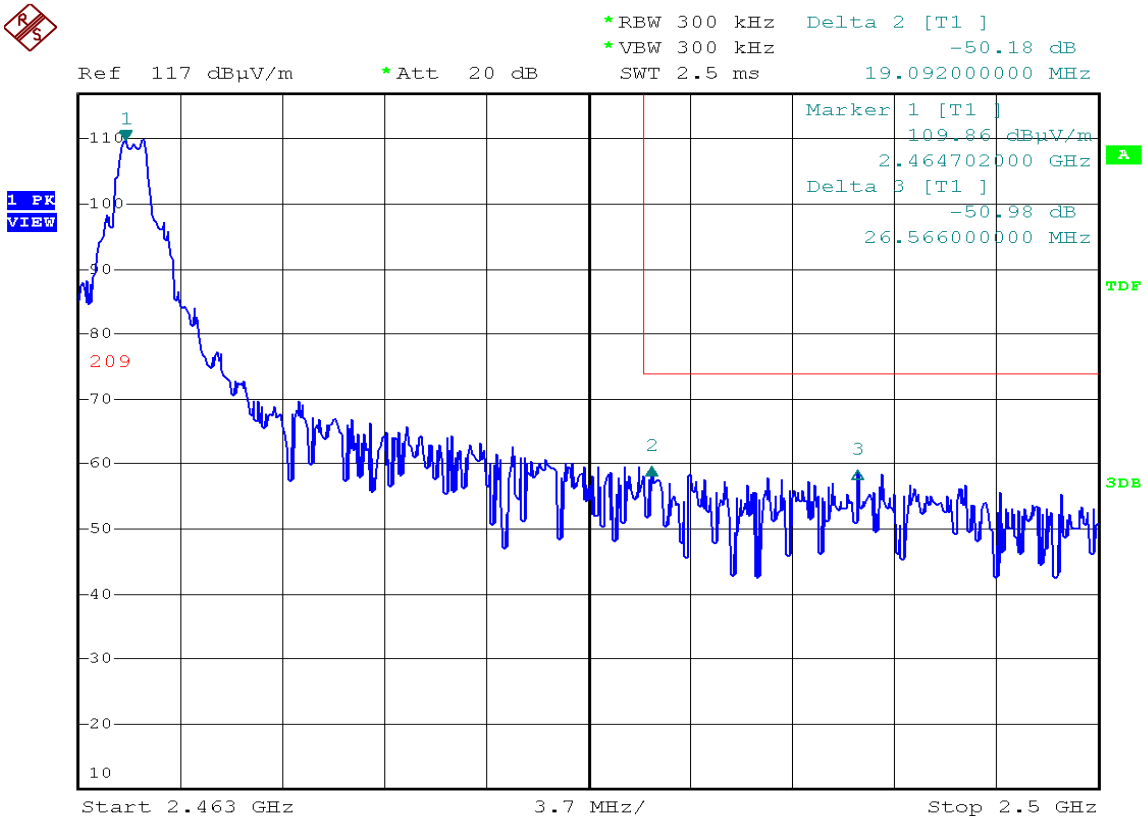

Figure 24 Band Edge of Radiated Emission – High frequency side without hopping



6.8 99% Bandwidth Measurement

Standard Applicable:

RSS-Gen §4.4.1, the transmitter shall be operated at its maximum carrier power measured under normal test conditions. The span of the analyzer shall be set to capture all products of the modulation process, including the emission skirts. The resolution bandwidth shall be set to as close to 1% of the selected span as is possible without being below 1%. The video bandwidth shall be set to 3 times the resolution bandwidth. Video averaging is not permitted. Where practical, a sampling detector shall be used since a peak or, peak hold, may produce a wider bandwidth than actual.

The trace data points are recovered and are directly summed in linear terms. The recovered amplitude data points, beginning at the lowest frequency, are placed in a running sum until 0.5% of the total is reached and that frequency recorded. The process is repeated for the highest frequency data points. This frequency is recorded. The span between the two recorded frequencies is the occupied bandwidth.

Test Procedure:

Use the following spectrum analyzer settings:

- Span = 3MHz
- Resolution Bandwidth = 100KHz
- Video Bandwidth = 300KHz
- Sweep = auto
- Detector function = peak
- Trace = max hold

Test Results:

Temperature:	24°C
Humidity:	49%
EUT Operation:	Data Transmission (without hopping)
Test Date:	February 21, 2009

Frequency (MHz)	99% Bandwidth (MHz)
2415	1.158
2442	1.134
2465	1.122

Note: Test plots shown in figures 25, 26, 27 on pages 39, 40, 41.

Figure 25- 99% bandwidth Measurement (fc=2415MHz)

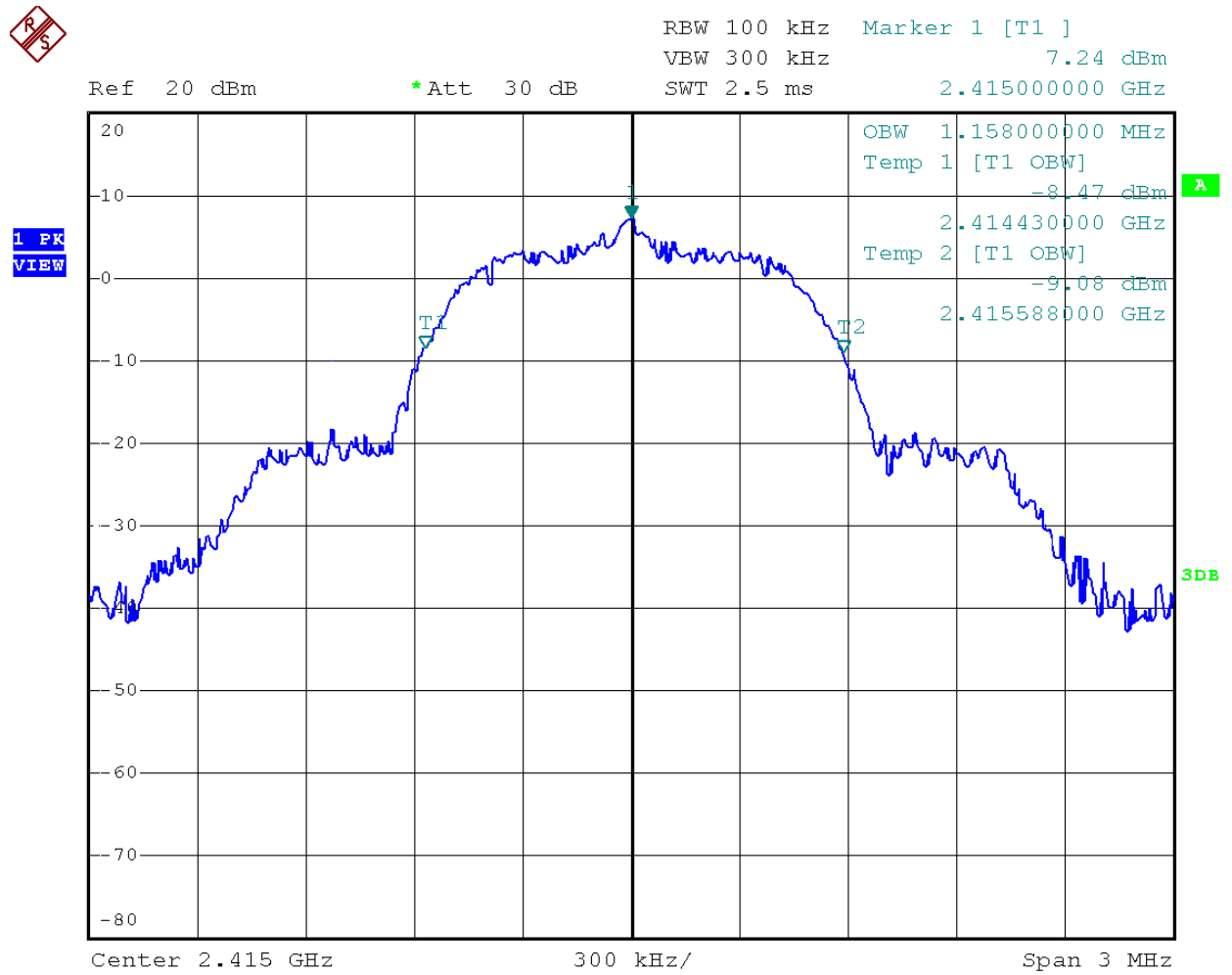

Figure 26- 99% bandwidth Measurement (fc=2442MHz)

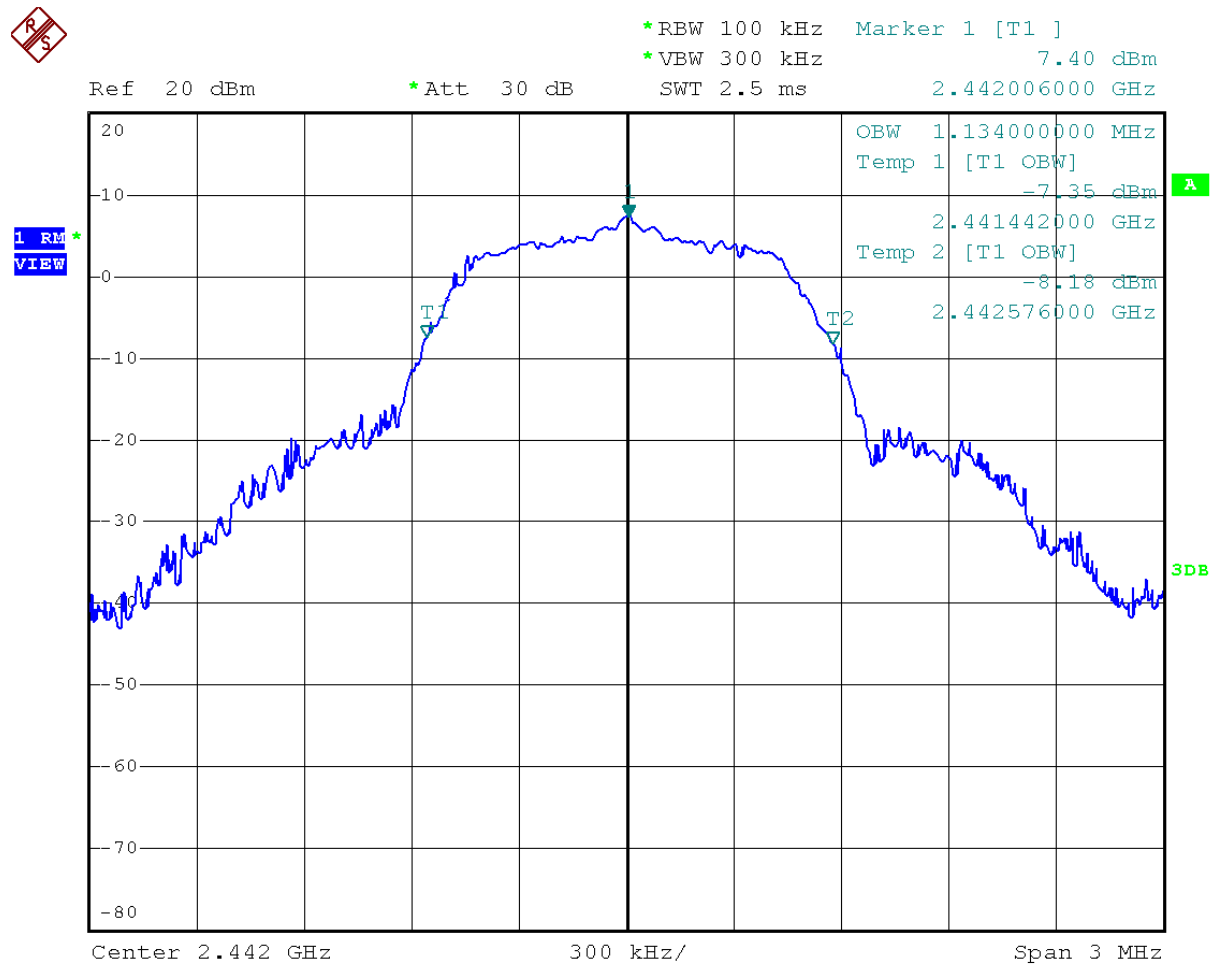
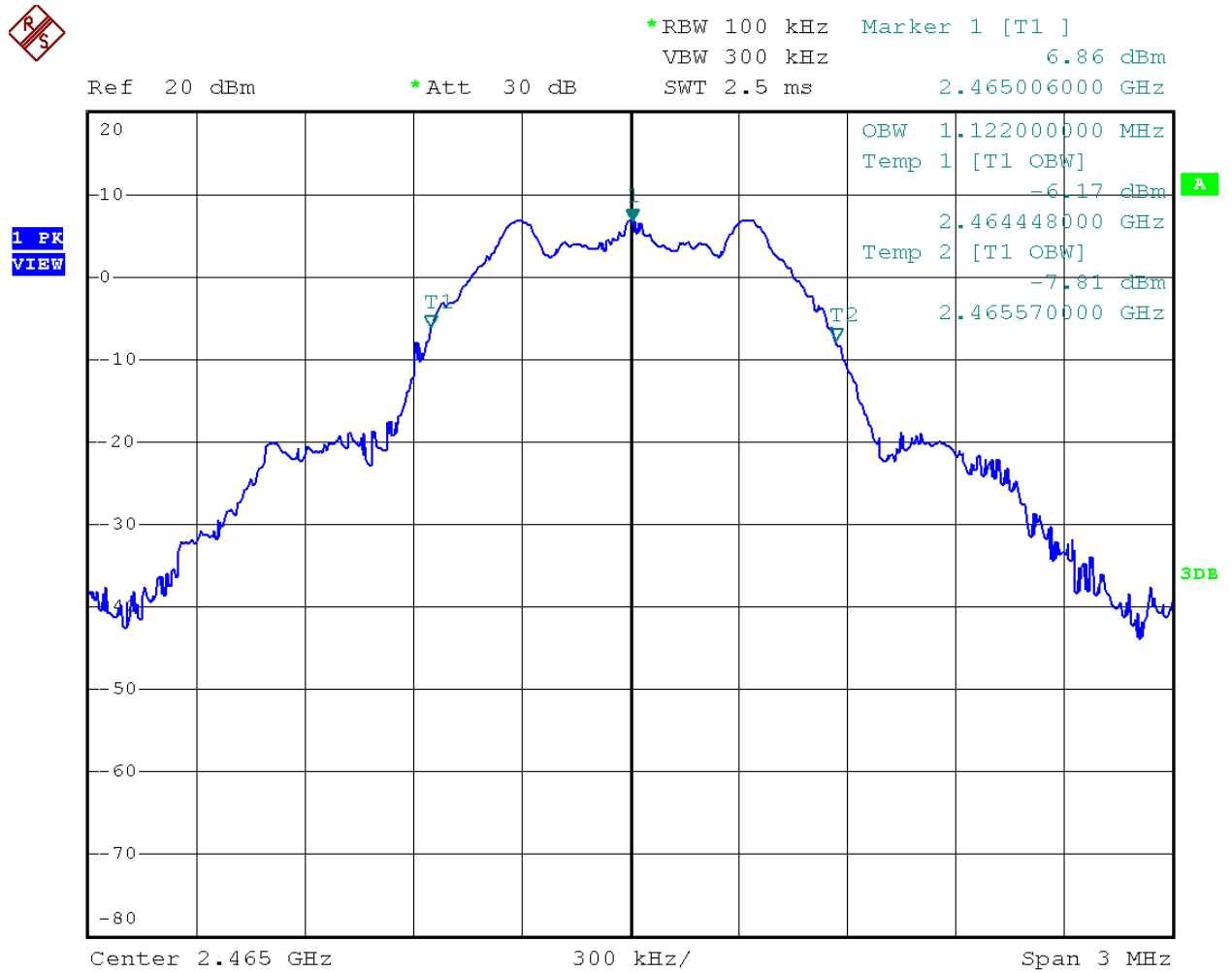

Figure 27 - 99% bandwidth Measurement (fc=2465MHz)



6.9 RF Exposure

Standard Applicable

According to 1.1307 (b)(1), systems operating under the provisions of this section shall be operated in a manner that ensure that the public is not exposed to radio frequency energy level in excess of the Commission's guideline.

This is a portable device.

Measurement Result:

This is a portable device and the max peak output power is 10.84dBm = (12.15mW), lower than low threshold 60/f GHz mW = (24.34mW), d <2.5 cm general population category.

The SAR/MPE measurement is not necessary.

6.10 Antenna Requirement

Standard Applicable

According to §15.203, an intentional radiator shall be designed to ensure that no antenna other than furnished by the responsible party shall be used with the device. And according to §15.246(1), if transmitting antennas of directional gain greater than 6dBi are used the power shall be reduced by the amount in dB that the directional gain of the antenna exceeds 6 dBi.

According to RSS-GEN 7.1.4, a transmitter can only be sold or operated with antennas with which it was certified. A transmitter may be certified with multiple antenna types. An antenna type comprises antennas having similar in-band and out-of-band radiation patterns. Testing shall be performed using the highest-gain antenna of each combination of transmitter and antenna type for which certification is being sought, with the transmitter output power set at the maximum level. Any antenna of the same type and having equal or lesser gain as an antenna that had been successfully tested for certification with the transmitter, will also be considered certified with the transmitter, and may be used and marketed with the transmitter. The manufacturer shall include with the application for certification a list of acceptable antenna types to be used with the transmitter.

Antenna Construction:

The directional gins of antenna used for transmitting is 1.1~1.9 dBi, and the antenna connector is designed with permanent attachment and no consideration of replacement. Please see EUT photo for details.

The unit does meet the requirement.