	Document		Page
	Annex B to Hearing Aid Compatibility RF Emissions Test Report for the BlackBerry® Smartphone model RHT181LW (STV100-2)		1(22)
Author Data	Dates of Test	Report No	FCC ID
Daoud Attayi	August 31- October 27, 2015	RTS-6066-1511-05	L6ARHT180LW

Annex B: Probe and dipole descriptions and calibration certificates

B.2 Dipole calibration certificate

Calibration Laboratory of Schmid & Partner Engineering AG
 Zeughausstrasse 43, 8004 Zurich, Switzerland



S Schweizerischer Kalibrierdienst
S Service suisse d'étalonnage
S Servizio svizzero di taratura
S Swiss Calibration Service

Accredited by the Swiss Accreditation Service (SAS)
 The Swiss Accreditation Service is one of the signatories to the EA
 Multilateral Agreement for the recognition of calibration certificates

Accreditation No.: **SCS 108**

Client **Blackberry Waterloo**

Certificate No: **CD835V3-1011_Nov13**

CALIBRATION CERTIFICATE

Object **CD835V3 - SN: 1011**

Calibration procedure(s) **QA CAL-20.v6
 Calibration procedure for dipoles in air**

Calibration date: **November 12, 2013**

This calibration certificate documents the traceability to national standards, which realize the physical units of measurements (SI). The measurements and the uncertainties with confidence probability are given on the following pages and are part of the certificate.

All calibrations have been conducted in the closed laboratory facility: environment temperature (22 ± 3)°C and humidity < 70%.

Calibration Equipment used (M&E critical for calibration)

Primary Standards	ID #	Cal Date (Certificate No.)	Scheduled Calibration
Power meter EPM-442A	GB37480704	09-Oct-13 (No. 217-01827)	Oct-14
Power sensor HP 8481A	US37292783	09-Oct-13 (No. 217-01827)	Oct-14
Power sensor HP 8481A	MY41092317	09-Oct-13 (No. 217-01828)	Oct-14
Reference 10 dB Attenuator	SN: 5047.2 (10g)	04-Apr-13 (No. 217-01731)	Apr-14
Probe ER3DV6	SN: 2936	28-Dec-12 (No. EP3-2336_Dec12)	Dec-13
Probe H3DV6	SN: 6065	28-Dec-12 (No. H3-6065_Dec12)	Dec-13
DAE4	SN: 781	13-Sep-13 (No. DAE4-781_Sep13)	Sep-14
Secondary Standards	ID #	Check Date (in house)	Scheduled Check
Power meter Agilent 4419B	SN: GB42420191	09-Oct-09 (in house check Oct-13)	In house check: Oct-15
Power sensor HP E4412A	SN: MY41495277	01-Apr-08 (in house check Oct-13)	In house check: Oct-15
Power sensor HP 8482A	SN: US37295597	09-Oct-09 (in house check Oct-13)	In house check: Oct-15
Network Analyzer HP B753E	SN: US37390585	18-Oct-01 (in house check Oct-13)	In house check: Oct-14
RF generator R&S SMT-06	SN: 832283/011	27-Aug-12 (in house check Oct-13)	In house check: Oct-15

Calibrated by: **Claudio Leubler** Laboratory Technician

Approved by: **Fin Bornholt** Deputy Technical Manager

Issued: November 13, 2013

This calibration certificate shall not be reproduced except in full without written approval of the laboratory.

	Document		Page
	Annex B to Hearing Aid Compatibility RF Emissions Test Report for the BlackBerry® Smartphone model RHT181LW (STV100-2)		3(22)
Author Data Daoud Attayi	Dates of Test August 31- October 27, 2015	Report No RTS-6066-1511-05	FCC ID L6ARHT180LW

Calibration Laboratory of Schmid & Partner Engineering AG
Zeughausstrasse 43, 8004 Zurich, Switzerland



S Schweizerischer Kalibrierdienst
C Service suisse d'étalonnage
S Servizio svizzero di taratura
S Swiss Calibration Service

Accredited by the Swiss Accreditation Service (SAS)
The Swiss Accreditation Service is one of the signatories to the EA Multilateral Agreement for the recognition of calibration certificates

Accreditation No.: **SCS 108**

References

- [1] ANSI-C63.19-2011
American National Standard, Methods of Measurement of Compatibility between Wireless Communications Devices and Hearing Aids.

Methods Applied and Interpretation of Parameters:

- **Coordinate System:** y-axis is in the direction of the dipole arms. z-axis is from the basis of the antenna (mounted on the table) towards its feed point between the two dipole arms. x-axis is normal to the other axes. In coincidence with the standards [1], the measurement planes (probe sensor center) are selected to be at a distance of 15 mm above the top metal edge of the dipole arms.
- **Measurement Conditions:** Further details are available from the hardcopies at the end of the certificate. All figures stated in the certificate are valid at the frequency indicated. The forward power to the dipole connector is set with a calibrated power meter connected and monitored with an auxiliary power meter connected to a directional coupler. While the dipole under test is connected, the forward power is adjusted to the same level.
- **Antenna Positioning:** The dipole is mounted on a HAC Test Arch phantom using the matching dipole positioner with the arms horizontal and the feeding cable coming from the floor. The measurements are performed in a shielded room with absorbers around the setup to reduce the reflections. It is verified before the mounting of the dipole under the Test Arch phantom, that its arms are perfectly in a line. It is installed on the HAC dipole positioner with its arms parallel below the dielectric reference wire and able to move elastically in vertical direction without changing its relative position to the top center of the Test Arch phantom. The vertical distance to the probe is adjusted after dipole mounting with a DASY5 Surface Check job. Before the measurement, the distance between phantom surface and probe tip is verified. The proper measurement distance is selected by choosing the matching section of the HAC Test Arch phantom with the proper device reference point (upper surface of the dipole) and the matching grid reference point (tip of the probe) considering the probe sensor offset. The vertical distance to the probe is essential for the accuracy.
- **Feed Point Impedance and Return Loss:** These parameters are measured using a HP 8753E Vector Network Analyzer. The impedance is specified at the SMA connector of the dipole. The influence of reflections was eliminating by applying the averaging function while moving the dipole in the air, at least 70cm away from any obstacles.
- **E-field distribution:** E field is measured in the x-y-plane with an isotropic ER3D-field probe with 100 mW forward power to the antenna feed point. In accordance with [1], the scan area is 20mm wide, its length exceeds the dipole arm length (180 or 90mm). The sensor center is 15 mm (in z) above the metal top of the dipole arms. Two 3D maxima are available near the end of the dipole arms. Assuming the dipole arms are perfectly in one line, the average of these two maxima (in subgrid 2 and subgrid 8) is determined to compensate for any non-parallelity to the measurement plane as well as the sensor displacement. The E-field value stated as calibration value represents the maximum of the interpolated 3D-E-field, in the plane above the dipole surface.

The reported uncertainty of measurement is stated as the standard uncertainty of measurement multiplied by the coverage factor k=2, which for a normal distribution corresponds to a coverage probability of approximately 95%.

Measurement Conditions

DASY system configuration, as far as not given on page 1.

DASY Version	DASY5	V52.8.7
Phantom	HAC Test Arch	
Distance Dipole Top - Probe Center	15mm	
Scan resolution	dx, dy = 5 mm	
Frequency	835 MHz ± 1 MHz	
Input power drift	< 0.05 dB	

Maximum Field values at 835 MHz

E-field 15 mm above dipole surface	condition	Interpolated maximum
Maximum measured above high end	100 mW input power	110.1 V / m
Maximum measured above low end	100 mW input power	104.5 V / m
Averaged maximum above arm	100 mW input power	107.3 V / m ± 12.8 % (k=2)

Appendix

Antenna Parameters

Frequency	Return Loss	Impedance
800 MHz	16.3 dB	42.8 Ω - 12.4 jΩ
835 MHz	29.4 dB	51.5 Ω + 3.1 jΩ
900 MHz	16.3 dB	55.5 Ω - 15.3 jΩ
950 MHz	19.6 dB	44.2 Ω + 8.1 jΩ
960 MHz	16.2 dB	50.8 Ω + 15.7 jΩ

3.2 Antenna Design and Handling

The calibration dipole has a symmetric geometry with a built-in two stub matching network, which leads to the enhanced bandwidth.

The dipole is built of standard semirigid coaxial cable. The internal matching line is open ended. The antenna is therefore open for DC signals.

Do not apply force to dipole arms, as they are liable to bend. The soldered connections near the feedpoint may be damaged. After excessive mechanical stress or overheating, check the impedance characteristics to ensure that the internal matching network is not affected.

After long term use with 40W radiated power, only a slight warming of the dipole near the feedpoint can be measured.

Impedance Measurement Plot

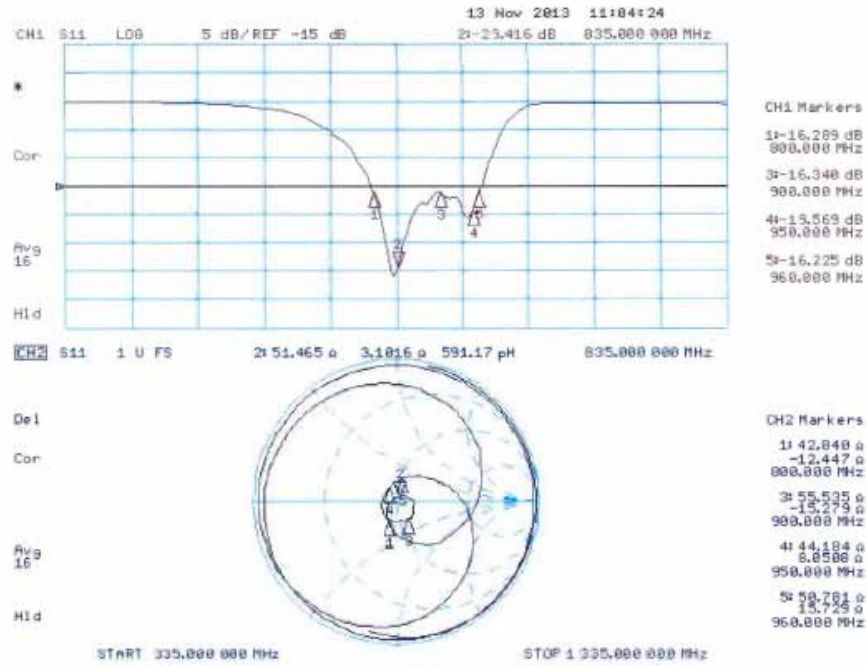

Impedance Measurement Plot

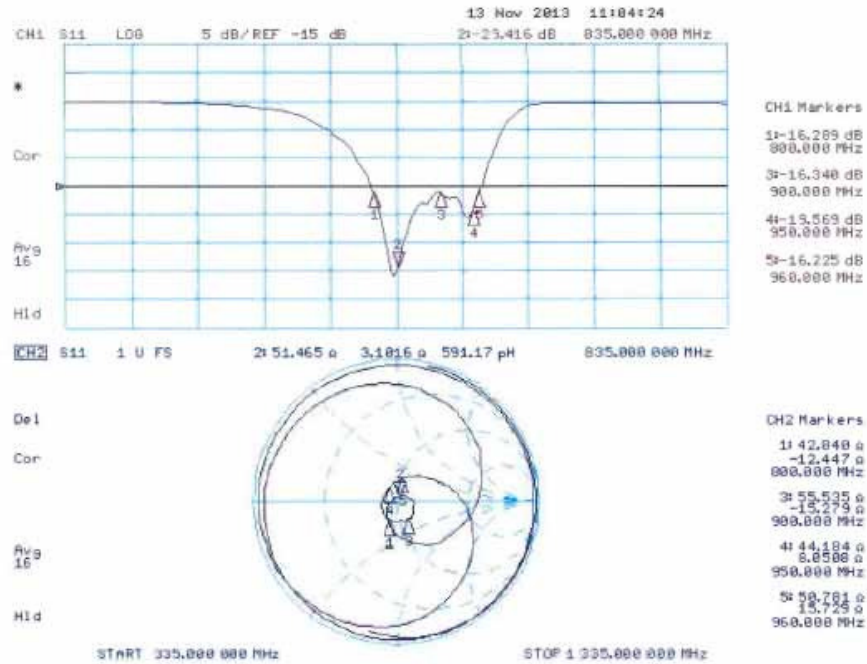

Calibration Laboratory of
Schmid & Partner
Engineering AG
Zeughausstrasse 43, 8004 Zurich, Switzerland





SSCS
Schweizerischer Kalibrierdienst
Service suisse d'étalonnage
Servizio svizzero di taratura
Swiss Calibration Service

Accredited by the Swiss Accreditation Service (SA5)
The Swiss Accreditation Service is one of the signatories to the EA
Multilateral Agreement for the recognition of calibration certificates

Accreditation No.: SCS 108

Client **Blackberry Waterloo**

Certificate No: CD1880V3-1008_Nov13

CALIBRATION CERTIFICATE																																																											
Object	CD1880V3 - SN: 1008																																																										
Calibration procedure(s)	QA CAL-20.v6 Calibration procedure for dipoles in air																																																										
Calibration date:	November 12, 2013																																																										
<p>This calibration certificate documents the traceability to national standards, which realize the physical units of measurements (SI). The measurements and the uncertainties with confidence probability are given on the following pages and are part of the certificate.</p> <p>All calibrations have been conducted in the closed laboratory facility: environment temperature (22 ± 3)°C and humidity < 70%.</p> <p>Calibration Equipment used (M&TE critical for calibration)</p> <table border="1"> <thead> <tr> <th>Primary Standards</th> <th>ID #</th> <th>Cal Date (Certificate No.)</th> <th>Scheduled Calibration</th> </tr> </thead> <tbody> <tr> <td>Power meter EPM-442A</td> <td>G837480704</td> <td>09-Oct-13 (No. 217-01827)</td> <td>Oct-14</td> </tr> <tr> <td>Power sensor HP 8481A</td> <td>US37292783</td> <td>09-Oct-13 (No. 217-01827)</td> <td>Oct-14</td> </tr> <tr> <td>Power sensor HP 8481A</td> <td>MY41082317</td> <td>09-Oct-13 (No. 217-01828)</td> <td>Oct-14</td> </tr> <tr> <td>Reference 10 dB Attenuator</td> <td>SN: 5047.2 (10g)</td> <td>04-Apr-13 (No. 217-01731)</td> <td>Apr-14</td> </tr> <tr> <td>Probe ER3DV6</td> <td>SN: 2336</td> <td>28-Dec-12 (No. ER3-2336_Dec12)</td> <td>Dec-13</td> </tr> <tr> <td>Probe H3DV6</td> <td>SN: 8065</td> <td>28-Dec-12 (No. H3-6065_Dec12)</td> <td>Dec-13</td> </tr> <tr> <td>DAE4</td> <td>SN: 781</td> <td>13-Sep-13 (No. DAE4-781_Sep13)</td> <td>Sep-14</td> </tr> </tbody> </table> <table border="1"> <thead> <tr> <th>Secondary Standards</th> <th>ID #</th> <th>Check Date (in house)</th> <th>Scheduled Check</th> </tr> </thead> <tbody> <tr> <td>Power meter Agilent 44198</td> <td>SN: 0842420191</td> <td>09-Oct-09 (in house check Oct-13)</td> <td>In house check: Oct-15</td> </tr> <tr> <td>Power sensor HP E4412A</td> <td>SN: MY41495277</td> <td>01-Apr-08 (in house check Oct-13)</td> <td>In house check: Oct-15</td> </tr> <tr> <td>Power sensor HP 8482A</td> <td>SN: US37295597</td> <td>09-Oct-09 (in house check Oct-13)</td> <td>In house check: Oct-15</td> </tr> <tr> <td>Network Analyzer HP 8753E</td> <td>US37390585</td> <td>18-Oct-01 (in house check Oct-13)</td> <td>In house check: Oct-14</td> </tr> <tr> <td>RF generator R&S SMT-05</td> <td>SN: 832283011</td> <td>27-Aug-12 (in house check Oct-13)</td> <td>In house check: Oct-15</td> </tr> </tbody> </table>				Primary Standards	ID #	Cal Date (Certificate No.)	Scheduled Calibration	Power meter EPM-442A	G837480704	09-Oct-13 (No. 217-01827)	Oct-14	Power sensor HP 8481A	US37292783	09-Oct-13 (No. 217-01827)	Oct-14	Power sensor HP 8481A	MY41082317	09-Oct-13 (No. 217-01828)	Oct-14	Reference 10 dB Attenuator	SN: 5047.2 (10g)	04-Apr-13 (No. 217-01731)	Apr-14	Probe ER3DV6	SN: 2336	28-Dec-12 (No. ER3-2336_Dec12)	Dec-13	Probe H3DV6	SN: 8065	28-Dec-12 (No. H3-6065_Dec12)	Dec-13	DAE4	SN: 781	13-Sep-13 (No. DAE4-781_Sep13)	Sep-14	Secondary Standards	ID #	Check Date (in house)	Scheduled Check	Power meter Agilent 44198	SN: 0842420191	09-Oct-09 (in house check Oct-13)	In house check: Oct-15	Power sensor HP E4412A	SN: MY41495277	01-Apr-08 (in house check Oct-13)	In house check: Oct-15	Power sensor HP 8482A	SN: US37295597	09-Oct-09 (in house check Oct-13)	In house check: Oct-15	Network Analyzer HP 8753E	US37390585	18-Oct-01 (in house check Oct-13)	In house check: Oct-14	RF generator R&S SMT-05	SN: 832283011	27-Aug-12 (in house check Oct-13)	In house check: Oct-15
Primary Standards	ID #	Cal Date (Certificate No.)	Scheduled Calibration																																																								
Power meter EPM-442A	G837480704	09-Oct-13 (No. 217-01827)	Oct-14																																																								
Power sensor HP 8481A	US37292783	09-Oct-13 (No. 217-01827)	Oct-14																																																								
Power sensor HP 8481A	MY41082317	09-Oct-13 (No. 217-01828)	Oct-14																																																								
Reference 10 dB Attenuator	SN: 5047.2 (10g)	04-Apr-13 (No. 217-01731)	Apr-14																																																								
Probe ER3DV6	SN: 2336	28-Dec-12 (No. ER3-2336_Dec12)	Dec-13																																																								
Probe H3DV6	SN: 8065	28-Dec-12 (No. H3-6065_Dec12)	Dec-13																																																								
DAE4	SN: 781	13-Sep-13 (No. DAE4-781_Sep13)	Sep-14																																																								
Secondary Standards	ID #	Check Date (in house)	Scheduled Check																																																								
Power meter Agilent 44198	SN: 0842420191	09-Oct-09 (in house check Oct-13)	In house check: Oct-15																																																								
Power sensor HP E4412A	SN: MY41495277	01-Apr-08 (in house check Oct-13)	In house check: Oct-15																																																								
Power sensor HP 8482A	SN: US37295597	09-Oct-09 (in house check Oct-13)	In house check: Oct-15																																																								
Network Analyzer HP 8753E	US37390585	18-Oct-01 (in house check Oct-13)	In house check: Oct-14																																																								
RF generator R&S SMT-05	SN: 832283011	27-Aug-12 (in house check Oct-13)	In house check: Oct-15																																																								
Calibrated by:	Name Claudio Leubler	Function Laboratory Technician	Signature 																																																								
Approved by:	Name Fin Bornholt	Function Deputy Technical Manager	Signature 																																																								
Issued: November 13, 2013																																																											
This calibration certificate shall not be reproduced except in full without written approval of the laboratory.																																																											

Certificate No: CD1880V3-1008_Nov13

Page 1 of 5

	Document Annex B to Hearing Aid Compatibility RF Emissions Test Report for the BlackBerry® Smartphone model RHT181LW (STV100-2)		Page 8(22)
	Author Data Daoud Attayi	Dates of Test August 31- October 27, 2015	Report No RTS-6066-1511-05

Calibration Laboratory of Schmid & Partner Engineering AG
 Zeughausstrasse 43, 8004 Zurich, Switzerland



S Schweizerischer Kalibrierdienst
 S Service suisse d'étalonnage
 S Servizio svizzero di taratura
 S Swiss Calibration Service

Accredited by the Swiss Accreditation Service (SAS)
 The Swiss Accreditation Service is one of the signatories to the EA Multilateral Agreement for the recognition of calibration certificates

Accreditation No.: **SCS 108**

References

- [1] ANSI-C63.19-2011
American National Standard, Methods of Measurement of Compatibility between Wireless Communications Devices and Hearing Aids.

Methods Applied and Interpretation of Parameters:

- **Coordinate System:** y-axis is in the direction of the dipole arms. z-axis is from the basis of the antenna (mounted on the table) towards its feed point between the two dipole arms. x-axis is normal to the other axes. In coincidence with the standards [1], the measurement planes (probe sensor center) are selected to be at a distance of 15 mm above the top metal edge of the dipole arms.
- **Measurement Conditions:** Further details are available from the hardcopies at the end of the certificate. All figures stated in the certificate are valid at the frequency indicated. The forward power to the dipole connector is set with a calibrated power meter connected and monitored with an auxiliary power meter connected to a directional coupler. While the dipole under test is connected, the forward power is adjusted to the same level.
- **Antenna Positioning:** The dipole is mounted on a HAC Test Arch phantom using the matching dipole positioner with the arms horizontal and the feeding cable coming from the floor. The measurements are performed in a shielded room with absorbers around the setup to reduce the reflections. It is verified before the mounting of the dipole under the Test Arch phantom, that its arms are perfectly in a line. It is installed on the HAC dipole positioner with its arms parallel below the dielectric reference wire and able to move elastically in vertical direction without changing its relative position to the top center of the Test Arch phantom. The vertical distance to the probe is adjusted after dipole mounting with a DASY5 Surface Check job. Before the measurement, the distance between phantom surface and probe tip is verified. The proper measurement distance is selected by choosing the matching section of the HAC Test Arch phantom with the proper device reference point (upper surface of the dipole) and the matching grid reference point (tip of the probe) considering the probe sensor offset. The vertical distance to the probe is essential for the accuracy.
- **Feed Point Impedance and Return Loss:** These parameters are measured using a HP 8753E Vector Network Analyzer. The impedance is specified at the SMA connector of the dipole. The influence of reflections was eliminated by applying the averaging function while moving the dipole in the air, at least 70cm away from any obstacles.
- **E-field distribution:** E field is measured in the x-y plane with an isotropic ER3D-field probe with 100 mW forward power to the antenna feed point. In accordance with [1], the scan area is 20mm wide, its length exceeds the dipole arm length (180 or 90mm). The sensor center is 15 mm (in z) above the metal top of the dipole arms. Two 3D maxima are available near the end of the dipole arms. Assuming the dipole arms are perfectly in one line, the average of these two maxima (in subgrid 2 and subgrid 8) is determined to compensate for any non-parallelity to the measurement plane as well as the sensor displacement. The E-field value stated as calibration value represents the maximum of the interpolated 3D-E-field, in the plane above the dipole surface.

The reported uncertainty of measurement is stated as the standard uncertainty of measurement multiplied by the coverage factor k=2, which for a normal distribution corresponds to a coverage probability of approximately 95%.

Measurement Conditions

DASY system configuration, as far as not given on page 1.

DASY Version	DASY5	V52.8.7
Phantom	HAC Test Arch	
Distance Dipole Top - Probe Center	15mm	
Scan resolution	dx, dy = 5 mm	
Frequency	835 MHz ± 1 MHz	
Input power drift	< 0.05 dB	

Maximum Field values at 835 MHz

E-field 15 mm above dipole surface	condition	Interpolated maximum
Maximum measured above high end	100 mW input power	110.1 V / m
Maximum measured above low end	100 mW input power	104.5 V / m
Averaged maximum above arm	100 mW input power	107.3 V / m ± 12.8 % (k=2)

Appendix

Antenna Parameters

Frequency	Return Loss	Impedance
800 MHz	16.3 dB	42.8 Ω - 12.4 jΩ
835 MHz	29.4 dB	51.5 Ω + 3.1 jΩ
900 MHz	16.3 dB	55.5 Ω - 15.3 jΩ
950 MHz	19.6 dB	44.2 Ω + 8.1 jΩ
960 MHz	16.2 dB	50.8 Ω + 15.7 jΩ

3.2 Antenna Design and Handling

The calibration dipole has a symmetric geometry with a built-in two stub matching network, which leads to the enhanced bandwidth.

The dipole is built of standard semirigid coaxial cable. The internal matching line is open ended. The antenna is therefore open for DC signals.

Do not apply force to dipole arms, as they are liable to bend. The soldered connections near the feedpoint may be damaged. After excessive mechanical stress or overheating, check the impedance characteristics to ensure that the internal matching network is not affected.

After long term use with 40W radiated power, only a slight warming of the dipole near the feedpoint can be measured.

Impedance Measurement Plot

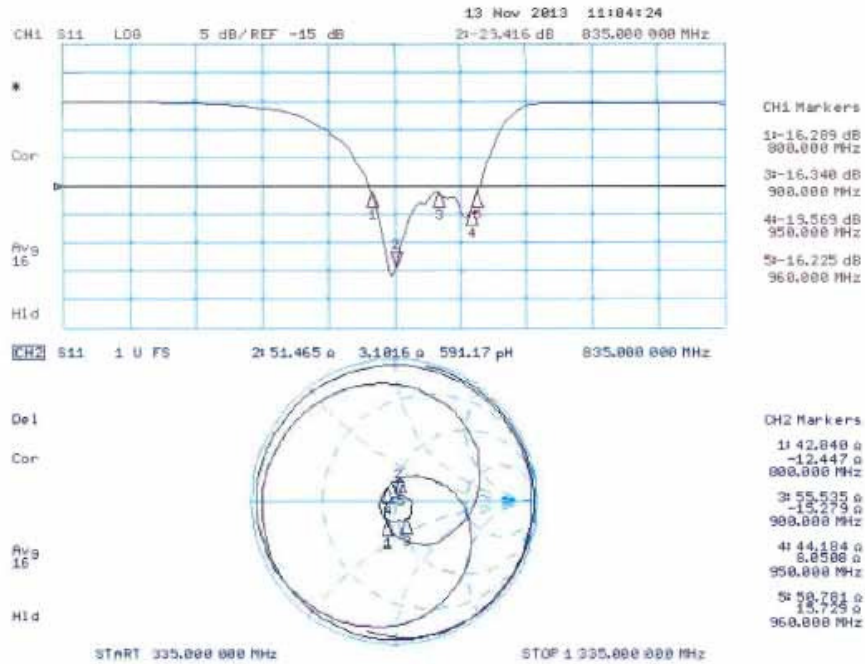

DASY5 E-field Result

Date: 12.11.2013

Test Laboratory: SPEAG Lab2

DUT: HAC-Dipole 835 MHz; Type: CD835V3; Serial: CD835V3 - SN: 1011

Communication System: UID 0 - CW ; Frequency: 835 MHz
 Medium parameters used: $\sigma = 0 \text{ S/m}$, $\epsilon_r = 1$; $\rho = 1000 \text{ kg/m}^3$
 Phantom section: RF Section
 Measurement Standard: DASY5 (IEEE/IEC/ANSI C63.19-2007)

DASY52 Configuration:

- Probe: ER3DV6 - SN2336; ConvF(1, 1, 1); Calibrated: 28.12.2012;
- Sensor-Surface: (Fix Surface)
- Electronics: DAE4 Sn781; Calibrated: 13.09.2013
- Phantom: HAC Test Arch with AMCC; Type: SD HAC P01 BA; Serial: 1070
- DASY52 52.8.7(1137); SEMCAD X 14.6.10(7164)

Dipole E-Field measurement @ 835MHz/E-Scan - 835MHz d=15mm/Hearing Aid Compatibility Test (41x361x1):

Interpolated grid: dx=0.5000 mm, dy=0.5000 mm
 Device Reference Point: 0, 0, -6.3 mm
 Reference Value = 111.2 V/m; Power Drift = 0.01 dB
 PMR not calibrated. PMF = 1.000 is applied.
 E-field emissions = 110.1 V/m
 Near-field category: M4 (AWF 0 dB)

PMF scaled E-field

Grid 1 M4	Grid 2 M4	Grid 3 M4
102.6 V/m	104.5 V/m	103.0 V/m
Grid 4 M4	Grid 5 M4	Grid 6 M4
62.00 V/m	62.75 V/m	61.79 V/m
Grid 7 M4	Grid 8 M4	Grid 9 M4
108.2 V/m	110.1 V/m	107.9 V/m

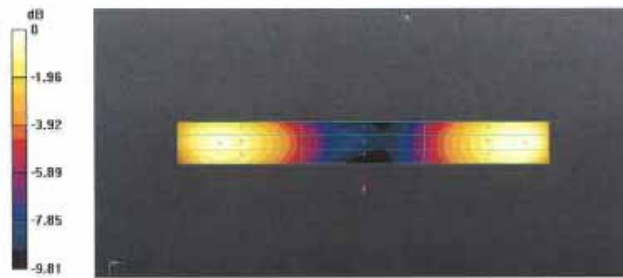

0 dB = 110.1 V/m = 40.84 dBV/m

Calibration Laboratory of
Schmid & Partner
Engineering AG
Zeughausstrasse 43, 8004 Zurich, Switzerland



S
C
S
Schweizerischer Kalibrierdienst
Service suisse d'étalonnage
Servizio svizzero di taratura
Swiss Calibration Service

Accredited by the Swiss Accreditation Service (SAS)
The Swiss Accreditation Service is one of the signatories to the EA
Multilateral Agreement for the recognition of calibration certificates

Accreditation No.: **SCS 108**

Client **Blackberry Waterloo**

Certificate No: **CD1880V3-1008_Nov13**

CALIBRATION CERTIFICATE			
Object	CD1880V3 - SN: 1008		
Calibration procedure(s)	QA CAL-20.v6 Calibration procedure for dipoles in air		
Calibration date:	November 12, 2013		
This calibration certificate documents the traceability to national standards, which realize the physical units of measurements (SI). The measurements and the uncertainties with confidence probability are given on the following pages and are part of the certificate.			
All calibrations have been conducted in the closed laboratory facility; environment temperature (22 ± 3)°C and humidity < 70%.			
Calibration Equipment used (M&TE critical for calibration)			
Primary Standards	ID #	Cal Date (Certificate No.)	Scheduled Calibration
Power meter EPM-442A	GB37480704	09-Oct-13 (No. 217-01827)	Oct-14
Power sensor HP 8481A	US37292783	09-Oct-13 (No. 217-01827)	Oct-14
Power sensor HP 8481A	MY41092317	09-Oct-13 (No. 217-01828)	Oct-14
Reference 10 dB Attenuator	SN: 5047.2 (10g)	04-Apr-13 (No. 217-01731)	Apr-14
Probe ER3DV6	SN: 2396	28-Dec-12 (No. ER3-2396_Dec12)	Dec-13
Probe H3DV6	SN: 8085	28-Dec-12 (No. H3-8085_Dec12)	Dec-13
DAE4	SN: 781	13-Sep-13 (No. DAE4-781_Sep13)	Sep-14
Secondary Standards	ID #	Check Date (in house)	Scheduled Check
Power meter Agilent 4419B	SN: GB42420191	09-Oct-09 (in house check Oct-13)	In house check: Oct-15
Power sensor HP E4412A	SN: MY41495277	01-Apr-08 (in house check Oct-13)	In house check: Oct-15
Power sensor HP 8482A	SN: US37295597	09-Oct-09 (in house check Oct-13)	In house check: Oct-15
Network Analyzer HP B753E	US37390585	18-Oct-01 (in house check Oct-13)	In house check: Oct-14
RF generator R&S SMT-06	SN: 832283011	27-Aug-12 (in house check Oct-13)	In house check: Oct-15
Calibrated by:	Name Claudio Loubler	Function Laboratory Technician	Signature
Approved by:	Name Fin Bornholt	Deputy Technical Manager	Signature
			Issued: November 13, 2013
This calibration certificate shall not be reproduced except in full without written approval of the laboratory.			

Certificate No: CD1880V3-1008_Nov13

Page 1 of 5

	Document Annex B to Hearing Aid Compatibility RF Emissions Test Report for the BlackBerry® Smartphone model RHT181LW (STV100-2)		Page 13(22)
	Author Data Daoud Attayi	Dates of Test August 31- October 27, 2015	Report No RTS-6066-1511-05

Calibration Laboratory of Schmid & Partner Engineering AG
 Zeughausstrasse 43, 8004 Zurich, Switzerland



S Schweizerischer Kalibrierdienst
S Service suisse d'étalonnage
S Servizio svizzero di taratura
S Swiss Calibration Service

Accredited by the Swiss Accreditation Service (SAS)
 The Swiss Accreditation Service is one of the signatories to the EA Multilateral Agreement for the recognition of calibration certificates

Accreditation No.: **SCS 108**

References

- [1] ANSI-C63.19-2011
American National Standard, Methods of Measurement of Compatibility between Wireless Communications Devices and Hearing Aids.

Methods Applied and Interpretation of Parameters:

- **Coordinate System:** y-axis is in the direction of the dipole arms. z-axis is from the basis of the antenna (mounted on the table) towards its feed point between the two dipole arms. x-axis is normal to the other axes. In coincidence with the standards [1], the measurement planes (probe sensor center) are selected to be at a distance of 15 mm above the top metal edge of the dipole arms.
- **Measurement Conditions:** Further details are available from the hardcopies at the end of the certificate. All figures stated in the certificate are valid at the frequency indicated. The forward power to the dipole connector is set with a calibrated power meter connected and monitored with an auxiliary power meter connected to a directional coupler. While the dipole under test is connected, the forward power is adjusted to the same level.
- **Antenna Positioning:** The dipole is mounted on a HAC Test Arch phantom using the matching dipole positioner with the arms horizontal and the feeding cable coming from the floor. The measurements are performed in a shielded room with absorbers around the setup to reduce the reflections. It is verified before the mounting of the dipole under the Test Arch phantom, that its arms are perfectly in a line. It is installed on the HAC dipole positioner with its arms parallel below the dielectric reference wire and able to move elastically in vertical direction without changing its relative position to the top center of the Test Arch phantom. The vertical distance to the probe is adjusted after dipole mounting with a DASY5 Surface Check job. Before the measurement, the distance between phantom surface and probe tip is verified. The proper measurement distance is selected by choosing the matching section of the HAC Test Arch phantom with the proper device reference point (upper surface of the dipole) and the matching grid reference point (tip of the probe) considering the probe sensor offset. The vertical distance to the probe is essential for the accuracy.
- **Feed Point Impedance and Return Loss:** These parameters are measured using a HP 8753E Vector Network Analyzer. The impedance is specified at the SMA connector of the dipole. The influence of reflections was eliminating by applying the averaging function while moving the dipole in the air, at least 70cm away from any obstacles.
- **E-field distribution:** E field is measured in the x-y plane with an isotropic ER3D-field probe with 100 mW forward power to the antenna feed point. In accordance with [1], the scan area is 20mm wide, its length exceeds the dipole arm length (180 or 90mm). The sensor center is 15 mm (in z) above the metal top of the dipole arms. Two 3D maxima are available near the end of the dipole arms. Assuming the dipole arms are perfectly in one line, the average of these two maxima (in subgrid 2 and subgrid 8) is determined to compensate for any non-parallelity to the measurement plane as well as the sensor displacement. The E-field value stated as calibration value represents the maximum of the interpolated 3D-E-field, in the plane above the dipole surface.

The reported uncertainty of measurement is stated as the standard uncertainty of measurement multiplied by the coverage factor k=2, which for a normal distribution corresponds to a coverage probability of approximately 95%.

	Document	Page	
	Annex B to Hearing Aid Compatibility RF Emissions Test Report for the BlackBerry® Smartphone model RHT181LW (STV100-2)	14(22)	
Author Data	Dates of Test	Report No	FCC ID
Daoud Attayi	August 31- October 27, 2015	RTS-6066-1511-05	L6ARHT180LW

Calibration Laboratory of
Schmid & Partner
Engineering AG
Zeughausstrasse 43, 8004 Zurich, Switzerland



S Schweizerischer Kalibrierdienst
S Service suisse d'étalonnage
S Servizio svizzero di taratura
S Swiss Calibration Service

Accredited by the Swiss Accreditation Service (SAS)
The Swiss Accreditation Service is one of the signatories to the EA
Multilateral Agreement for the recognition of calibration certificates

Accreditation No.: **SCS 108**

References

- [1] ANSI-C63.19-2011
American National Standard, Methods of Measurement of Compatibility between Wireless Communications Devices and Hearing Aids.

Methods Applied and Interpretation of Parameters:

- **Coordinate System:** y-axis is in the direction of the dipole arms. z-axis is from the basis of the antenna (mounted on the table) towards its feed point between the two dipole arms. x-axis is normal to the other axes. In coincidence with the standards [1], the measurement planes (probe sensor center) are selected to be at a distance of 15 mm above the top metal edge of the dipole arms.
- **Measurement Conditions:** Further details are available from the hardcopies at the end of the certificate. All figures stated in the certificate are valid at the frequency indicated. The forward power to the dipole connector is set with a calibrated power meter connected and monitored with an auxiliary power meter connected to a directional coupler. While the dipole under test is connected, the forward power is adjusted to the same level.
- **Antenna Positioning:** The dipole is mounted on a HAC Test Arch phantom using the matching dipole positioner with the arms horizontal and the feeding cable coming from the floor. The measurements are performed in a shielded room with absorbers around the setup to reduce the reflections. It is verified before the mounting of the dipole under the Test Arch phantom, that its arms are perfectly in a line. It is installed on the HAC dipole positioner with its arms parallel below the dielectric reference wire and able to move elastically in vertical direction without changing its relative position to the top center of the Test Arch phantom. The vertical distance to the probe is adjusted after dipole mounting with a DASY5 Surface Check job. Before the measurement, the distance between phantom surface and probe tip is verified. The proper measurement distance is selected by choosing the matching section of the HAC Test Arch phantom with the proper device reference point (upper surface of the dipole) and the matching grid reference point (tip of the probe) considering the probe sensor offset. The vertical distance to the probe is essential for the accuracy.
- **Feed Point Impedance and Return Loss:** These parameters are measured using a HP 8753E Vector Network Analyzer. The impedance is specified at the SMA connector of the dipole. The influence of reflections was eliminating by applying the averaging function while moving the dipole in the air, at least 70cm away from any obstacles.
- **E-field distribution:** E field is measured in the x-y plane with an isotropic ER3D-field probe with 100 mW forward power to the antenna feed point. In accordance with [1], the scan area is 20mm wide, its length exceeds the dipole arm length (180 or 90mm). The sensor center is 15 mm (in z) above the metal top of the dipole arms. Two 3D maxima are available near the end of the dipole arms. Assuming the dipole arms are perfectly in one line, the average of these two maxima (in subgrid 2 and subgrid 8) is determined to compensate for any non-parallelity to the measurement plane as well as the sensor displacement. The E-field value stated as calibration value represents the maximum of the interpolated 3D-E-field, in the plane above the dipole surface.

The reported uncertainty of measurement is stated as the standard uncertainty of measurement multiplied by the coverage factor k=2, which for a normal distribution corresponds to a coverage probability of approximately 95%.

Measurement Conditions

DASY system configuration, as far as not given on page 1.

DASY Version	DASY5	V52.8.7
Phantom	HAC Test Arch	
Distance Dipole Top - Probe Center	15mm	
Scan resolution	dx, dy = 5 mm	
Frequency	1880 MHz ± 1 MHz	
Input power drift	< 0.05 dB	

Maximum Field values at 1880 MHz

E-field 15 mm above dipole surface	condition	Interpolated maximum
Maximum measured above high end	100 mW input power	90.8 V / m
Maximum measured above low end	100 mW input power	87.3 V / m
Averaged maximum above arm	100 mW input power	89.0 V / m ± 12.8 % (k=2)

Appendix

Antenna Parameters

Frequency	Return Loss	Impedance
1730 MHz	27.3 dB	52.4 Ω + 3.7 jΩ
1880 MHz	20.3 dB	50.2 Ω + 9.7 jΩ
1900 MHz	20.8 dB	52.5 Ω + 9.0 jΩ
1950 MHz	28.5 dB	52.5 Ω + 2.9 jΩ
2000 MHz	18.5 dB	43.0 Ω + 8.7 jΩ

3.2 Antenna Design and Handling

The calibration dipole has a symmetric geometry with a built-in two stub matching network, which leads to the enhanced bandwidth.

The dipole is built of standard semirigid coaxial cable. The internal matching line is open ended. The antenna is therefore open for DC signals.

Do not apply force to dipole arms, as they are liable to bend. The soldered connections near the feedpoint may be damaged. After excessive mechanical stress or overheating, check the impedance characteristics to ensure that the internal matching network is not affected.

After long term use with 40W radiated power, only a slight warming of the dipole near the feedpoint can be measured.



Document

Annex B to Hearing Aid Compatibility RF Emissions Test Report for the BlackBerry® Smartphone model RHT181LW (STV100-2)

Page

16(22)

Author Data

Daoud Attayi

Dates of Test

August 31- October 27, 2015

Report No

RTS-6066-1511-05

FCC ID

L6ARHT180LW

Impedance Measurement Plot

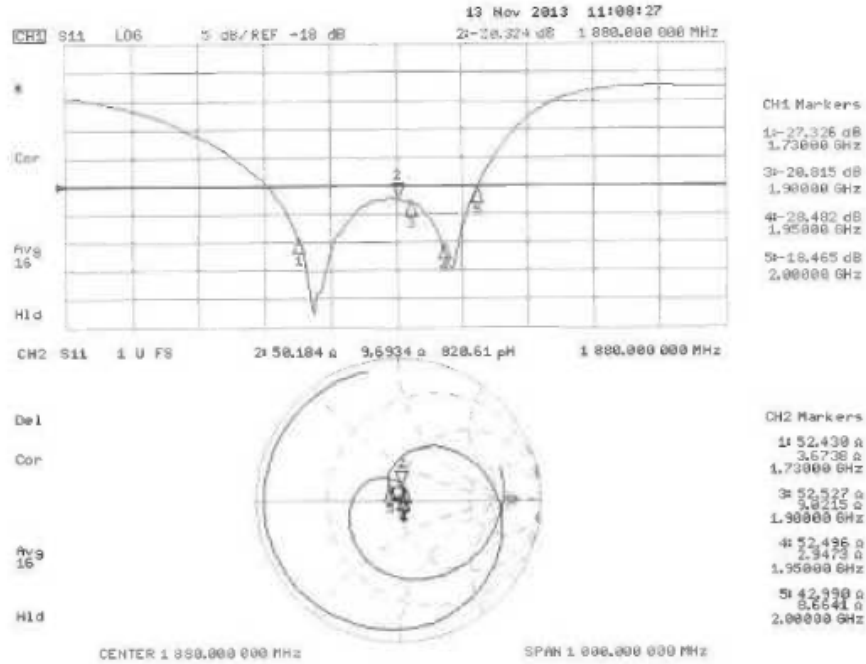

DASY5 E-field Result

Date: 12.11.2013

Test Laboratory: SPFAG Lab2

DUT: HAC Dipole 1880 MHz; Type: CD1880V3; Serial: CD1880V3 - SN: 1008

Communication System: UTD 0 - CW ; Frequency: 1880 MHz
 Medium parameters used: $\sigma = 0 \text{ S/m}$, $\epsilon_r = 1$; $\rho = 1000 \text{ kg/m}^3$
 Phantom section: RF Section
 Measurement Standard: DASY5 (IEEE/IEC/ANSI C63.19-2007)

DASY52 Configuration:

- Probe: ER3DV6 - SN2336; ConvF(1, 1, 1); Calibrated: 28.12.2012;
- Sensor Surface: (Fix Surface)
- Electronics: DAE4 Sn781; Calibrated: 13.09.2013
- Phantom: HAC Test Arch with AMCC; Type: SD HAC P01 BA; Serial: 1070
- DASY52 52.8.7(1137); SEMCAD X 14.6.10(7164)

Dipole E-Field measurement @ 1880MHz/E-Scan - 1880MHz d=15mm/Hearing Aid Compatibility Test (41x181x1):

Interpolated grid: $dx=0.5000 \text{ mm}$, $dy=0.5000 \text{ mm}$
 Device Reference Point: 0, 0, -6.3 mm
 Reference Value = 149.9 V/m; Power Drift = 0.00 dB
 PMR not calibrated. PMF = 1.000 is applied.
 E-field emissions = 90.79 V/m
 Near-field category: M3 (AWE 0 dB)

PMF scaled E-field

Grid 1 M3 87.94 V/m	Grid 2 M3 90.79 V/m	Grid 3 M3 90.11 V/m
Grid 4 M3 69.20 V/m	Grid 5 M3 70.42 V/m	Grid 6 M3 69.58 V/m
Grid 7 M3 84.92 V/m	Grid 8 M3 87.31 V/m	Grid 9 M3 86.78 V/m

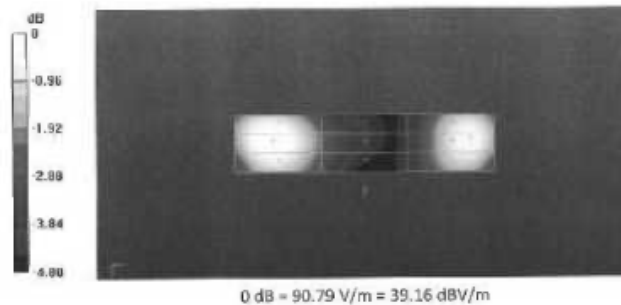

Calibration Laboratory of
Schnitzler & Partner
Engineering AG
 Zeughausstrasse 43, 8004 Zurich, Switzerland





S Schweizerischer Kalibrierdienst
C Service suisse d'étalonnage
S Servizio svizzero di taratura
S Swiss Calibration Service

Accredited by the Swiss Accreditation Service (SAS)
 The Swiss Accreditation Service is one of the signatories to the EA
 Multilateral Agreement for the recognition of calibration certificates

Accreditation No.: **SCS 0108**

Client **Blackberry Waterloo**

Certificate No: **CD2450V3-1011_Mar15**

CALIBRATION CERTIFICATE			
Object	CD2450V3 - SN: 1011		
Calibration procedure(s)	QA CAL-20.v6 Calibration procedure for dipoles in air		
Calibration date:	March 11, 2015		
<p>This calibration certificate documents the traceability to national standards, which realize the physical units of measurements (SI). The measurements and the uncertainties with confidence probability are given on the following pages and are part of the certificate.</p> <p>All calibrations have been conducted in the closed laboratory facility: environment temperature (22 ± 3)°C and humidity < 70%.</p>			
Calibration Equipment used (M&TE critical for calibration)			
Primary Standards	ID #	Cal Date (Certificate No.)	Scheduled Calibration
Power meter EPM-442A	GB37480704	07-Oct-14 (No. 217-02020)	Oct-15
Power sensor HP 8481A	US37292783	07-Oct-14 (No. 217-02020)	Oct-15
Power sensor HP 8481A	MY41092317	07-Oct-14 (No. 217-02021)	Oct-15
Reference 10 dB Attenuator	SN: 5047.2 / 06327	03-Apr-14 (No. 217-01921)	Apr-15
Probe ER3DV6	SN: 2336	31-Dec-14 (No. ER3-2336_Doc14)	Dec-15
Probe H3DV6	SN: 6065	31-Dec-14 (No. H3-6065_Dec14)	Dec-15
DAE4	SN: 781	12-Sep-14 (No. DAE4-781_Sep14)	Sep-15
Secondary Standards	ID #	Check Date (in house)	Scheduled Check
Power meter Agilent 4419B	SN: GB42420191	09-Oct-09 (in house check Sep-14)	in house check: Sep-16
Power sensor HP E4412A	SN: US38485102	05-Jan-10 (in house check Sep-14)	in house check: Sep-16
Power sensor HP 8482A	SN: US37295597	09-Oct-09 (in house check Sep-14)	in house check: Sep-16
Network Analyzer HP 8753E	US37390585	18-Oct-01 (in house check Oct-14)	in house check: Oct-15
RF generator R&S SMT-06	SN: 832283/011	27-Aug-12 (in house check Oct-13)	in house check: Oct-16
Calibrated by:	Name Claudio Leubler	Function Laboratory Technician	Signature 
Approved by:	Name Katja Pokovic	Function Technical Manager	Signature 
			Issued: March 11, 2015
This calibration certificate shall not be reproduced except in full without written approval of the laboratory.			

Certificate No: CD2450V3-1011_Mar15

Page 1 of 5

	Document	Page	
	Annex B to Hearing Aid Compatibility RF Emissions Test Report for the BlackBerry® Smartphone model RHT181LW (STV100-2)	19(22)	
Author Data	Dates of Test	Report No	FCC ID
Daoud Attayi	August 31- October 27, 2015	RTS-6066-1511-05	L6ARHT180LW

Calibration Laboratory of
Schnitzli & Partner
Engineering AG
 Zeughausstrasse 43, 8004 Zurich, Switzerland



S Schweizerischer Kalibrierdienst
C Service suisse d'étalonnage
S Servizio svizzero di taratura
S Swiss Calibration Service

Accredited by the Swiss Accreditation Service (SAS)
 The Swiss Accreditation Service is one of the signatories to the EA
 Multilateral Agreement for the recognition of calibration certificates

Accreditation No.: **SCS 0108**

References

- [1] ANSI-C63.19-2011
 American National Standard, Methods of Measurement of Compatibility between Wireless Communications Devices and Hearing Aids.

Methods Applied and Interpretation of Parameters:

- Coordinate System:** y-axis is in the direction of the dipole arms. z-axis is from the basis of the antenna (mounted on the table) towards its feed point between the two dipole arms. x-axis is normal to the other axes. In coincidence with the standards [1], the measurement planes (probe sensor center) are selected to be at a distance of 15 mm above the top metal edge of the dipole arms.
- Measurement Conditions:** Further details are available from the hardcopies at the end of the certificate. All figures stated in the certificate are valid at the frequency indicated. The forward power to the dipole connector is set with a calibrated power meter connected and monitored with an auxiliary power meter connected to a directional coupler. While the dipole under test is connected, the forward power is adjusted to the same level.
- Antenna Positioning:** The dipole is mounted on a HAC Test Arch phantom using the matching dipole positioner with the arms horizontal and the feeding cable coming from the floor. The measurements are performed in a shielded room with absorbers around the setup to reduce the reflections. It is verified before the mounting of the dipole under the Test Arch phantom, that its arms are perfectly in a line. It is installed on the HAC dipole positioner with its arms parallel below the dielectric reference wire and able to move elastically in vertical direction without changing its relative position to the top center of the Test Arch phantom. The vertical distance to the probe is adjusted after dipole mounting with a DASY5 Surface Check job. Before the measurement, the distance between phantom surface and probe tip is verified. The proper measurement distance is selected by choosing the matching section of the HAC Test Arch phantom with the proper device reference point (upper surface of the dipole) and the matching grid reference point (tip of the probe) considering the probe sensor offset. The vertical distance to the probe is essential for the accuracy.
- Feed Point Impedance and Return Loss:** These parameters are measured using a HP 8753E Vector Network Analyzer. The impedance is specified at the SMA connector of the dipole. The influence of reflections was eliminated by applying the averaging function while moving the dipole in the air, at least 70cm away from any obstacles.
- E-field distribution:** E field is measured in the x-y-plane with an isotropic ER3D-field probe with 100 mW forward power to the antenna feed point. In accordance with [1], the scan area is 20mm wide, its length exceeds the dipole arm length (180 or 90mm). The sensor center is 15 mm (in z) above the metal top of the dipole arms. Two 3D maxima are available near the end of the dipole arms. Assuming the dipole arms are perfectly in one line, the average of these two maxima (in subgrid 2 and subgrid 8) is determined to compensate for any non-parallelity to the measurement plane as well as the sensor displacement. The E-field value stated as calibration value represents the maximum of the interpolated 3D-E-field, in the plane above the dipole surface.

The reported uncertainty of measurement is stated as the standard uncertainty of measurement multiplied by the coverage factor k=2, which for a normal distribution corresponds to a coverage probability of approximately 95%.

Measurement Conditions

ASYS system configuration, as far as not given on page 1.

DASY Version	DASY5	V52.8.8
Phantom	HAC Test Arch	
Distance Dipole Top - Probe Center	15 mm	
Scan resolution	dx, dy = 5 mm	
Frequency	2450 MHz ± 1 MHz	
Input power drift	< 0.05 dB	

Maximum Field values at 2450 MHz

E-field 15 mm above dipole surface	condition	Interpolated maximum
Maximum measured above high end	100mW input power	88.6V/m = 38.94 dBV/m
Maximum measured above low end	100mW input power	84.4V/m = 38.52 dBV/m
Averaged maximum above arm	100mW input power	86.5V/m ± 12.8 % (k=2)

Appendix (Additional assessments outside the scope of SCS 0108)

Antenna Parameters

Frequency	Return Loss	Impedance
2250 MHz	17.2 dB	54.5 Ω + 13.9 jΩ
2350 MHz	29.4 dB	53.4 Ω + 0.7 jΩ
2450 MHz	28.1 dB	52.9 Ω + 2.8 jΩ
2550 MHz	36.3 dB	51.5 Ω - 0.4 jΩ
2650 MHz	18.0 dB	61.5 Ω + 8.0 jΩ

3.2 Antenna Design and Handling

The calibration dipole has a symmetric geometry with a built-in two stub matching network, which leads to the enhanced bandwidth.

The dipole is built of standard semirigid coaxial cable. The internal matching line is open ended. The antenna is therefore open for DC signals.

Do not apply force to dipole arms, as they are liable to bend. The soldered connections near the feedpoint may be damaged. After excessive mechanical stress or overheating, check the impedance characteristics to ensure that the internal matching network is not affected.

After long term use with 40W radiated power, only a slight warming of the dipole near the feedpoint can be measured.

Impedance Measurement Plot

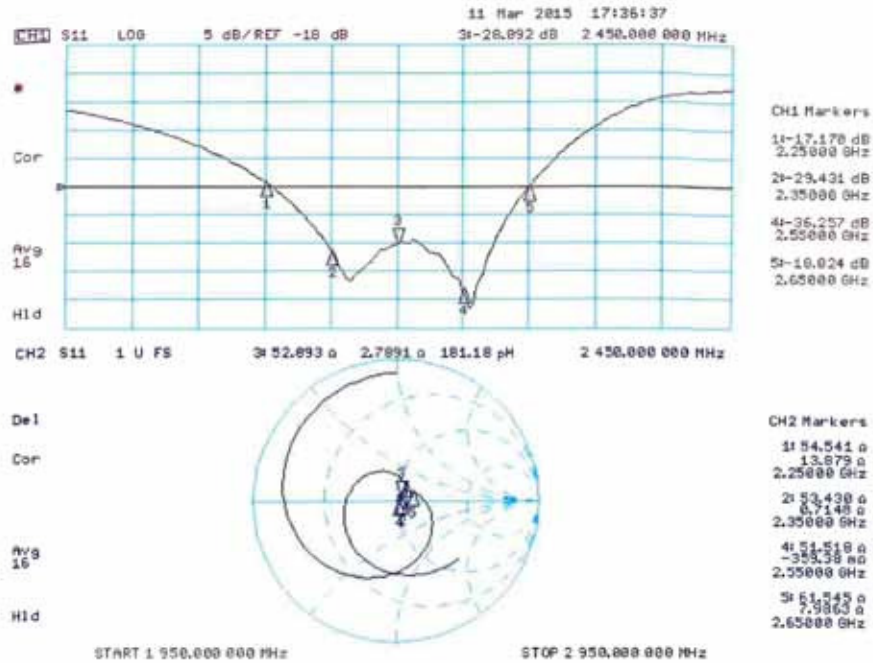

DASY5 E-field Result

Date: 11.03.2015

Test Laboratory: SPEAG Lab2

DUT: H1C Dipole 2450 MHz; Type: CD2450V3; Serial: CD2450V3 - SN: 1011

Communication System: UID 0 - CW ; Frequency: 2450 MHz
Medium parameters used: $\sigma = 0 \text{ S/m}$, $\epsilon_r = 1$; $\rho = 1000 \text{ kg/m}^3$
Phantom location: RF Section
Measurement Standard: DASY5 (IEEE/IEC/ANSI C63.19-2011)

DASY5 Configuration:

- Probe: ER3DV6 - SN2336; ConvF(1, 1, 1); Calibrated: 31.12.2014;
- Sensor-Surface: (Fix Surface)
- Electronics: DAE4 Sn781; Calibrated: 12.09.2014
- Phantom: HAC Test Arch with AMCC; Type: SD HAC P01 BA; Serial: 1070
- DASY52 52.8.8(1222); SEMCAD X 14.6.10(7331)

Dipole E-Field measurement @ 2450MHz/E-Scan - 2450MHz d=15mm/Hearing Aid Compatibility Test (41x181x1):

Interpolated grid: dx=0.5000 mm, dy=0.5000 mm
Device Reference Point: 0, 0, -6.3 mm
Reference Value = 79.66 V/m; Power Drift = -0.00 dB
Applied MIF = 0.00 dB
RF audio interference level = 38.94 dBV/m
Emission category: M2

MIF scaled E-field

Grid 1 M2 38.23 dBV/m	Grid 2 M2 38.52 dBV/m	Grid 3 M2 38.45 dBV/m
Grid 4 M2 38.15 dBV/m	Grid 5 M2 38.44 dBV/m	Grid 6 M2 38.4 dBV/m
Grid 7 M2 38.7 dBV/m	Grid 8 M2 38.94 dBV/m	Grid 9 M2 38.87 dBV/m

