	Document		Page
	Hearing Aid Compatibility RF Emissions Test Report for the BlackBerry® Smartphone model RHT181LW (STV100-2)		1(29)
Author Data	Dates of Test	Report No	FCC ID
Daoud Attayi	August 31- October 27, 2015	RTS-6066-1511-05	L6ARHT180LW

Hearing Aid Compatibility RF Emissions Test Report

Testing Lab:	BlackBerry RTS 440 Phillip Street Waterloo, Ontario Canada N2L 5R9 Phone: 519-888-7465 Fax: 519-746-0189	Applicant:	BlackBerry Limited 2200 University Ave. East Waterloo, Ontario Canada N2L 3W8 Phone: 519-888-7465 Fax: 519-888-6906 Web site: www.blackberry.com
---------------------	---	-------------------	--

Statement of Compliance: BlackBerry RTS declares that the product was tested in accordance with the appropriate measurement standards, guidelines and recommended practices.

This BlackBerry® Smartphone is a wireless portable device and has been shown to be in compliance with FCC 20.19 (2014-10-1), Hearing Aid-Compatible Mobile Handset and FCC Guidance KDB 285076 D01, V04, October 2013 and has been tested as per ANSI C63.19-2011.

Daoud Attayi, P.Eng.
Sr. Technical Lead, SAR/HAC
Product Compliance & Certification
(Author of the Test report)

Andrew Becker
Compliance Specialist I (SAR/HAC)
Product Compliance & Certification
(Verification of the Test Report)

Masud S. Attayi, P.Eng.
Sr. Manager, Regulatory Compliance & Certification
(Approval of the Test Report)

**RTS is accredited
according to
EN ISO/IEC 17025 by:**



592

	Document		Page
	Hearing Aid Compatibility RF Emissions Test Report for the BlackBerry® Smartphone model RHT181LW (STV100-2)		2(29)
Author Data	Dates of Test	Report No	FCC ID
Daoud Attayi	August 31- October 27, 2015	RTS-6066-1511-05	L6ARHT180LW

Revision History		
Rev. Number	Date	Changes
Initial	Nov 12, 2015	

		Document Hearing Aid Compatibility RF Emissions Test Report for the BlackBerry® Smartphone model RHT181LW (STV100-2)	Page 3(29)
Author Data Daoud Attayi	Dates of Test August 31- October 27, 2015	Report No RTS-6066-1511-05	FCC ID L6ARHT180LW

CONTENTS

1.0 Introduction 4

2.0 Applicable references 5

3.0 Equipment unit tested 6

 3.1 Picture of device 6

 3.2 Device description 6

 3.3 Battery 10

 3.4 Antenna description 10

4.0 List of test equipment 10

5.0 Measurement procedures and measurement system 11

 5.1 System/Dipole Validation 11

 5.2 Modulation interference factor (MIF) 13

 5.3 Evaluation of Interference Potential 13

 5.4 AIA Audio Interference Analyzer 14

 5.5 MIF Measurement using AIA 14

 5.6 Near-Field RF Emission 18

6.0 Summary of results 21

 6.1 Conclusion 27

7.0 Measurement uncertainty 28

 7.1 Site-Specific Uncertainty 29

Annex A: Measurement plots and data

- A.1 MIF validation plots
- A.2 Dipole validation plots
- A.3 RF emission field plots

Annex B: Probe and dipole descriptions and calibration certificates

- B.1 Probe and measurement chain description and specifications
- B.2 Probe and dipole calibration certificates

Annex C: Test set up photos

		Document Hearing Aid Compatibility RF Emissions Test Report for the BlackBerry® Smartphone model RHT181LW (STV100-2)	Page 4(29)
Author Data Daoud Attayi	Dates of Test August 31- October 27, 2015	Report No RTS-6066-1511-05	FCC ID L6ARHT180LW

1.0 Introduction

This test report documents the measurements of the near electric/ RF Audio Interference Level generated by a wireless communication device in the region where a hearing aid would be used. The measurement procedures of ANSI C63.19-2011 were followed along with the guidance provided by the FCC.

The electric field from a wireless device is measured using a SPEAG DASY5 automated system with HAC extension and free-space probes (ER3DVx) in a 5cm x 5cm area, 15mm above the wireless device's acoustic output and the centre point of the probe element. The area is divided into 9 sub-grids and the maximum values of the electrical field scans are evaluated automatically according to the rules defined in the standard and the device is assigned a certain category. Should the wireless device's maximum T-Coil output occur in a location other than the centre of acoustic output, then the RF field scans are repeated with the measurement area centered on the maximum T-Coil output location.

The DASY5 HAC Extension consists of the following parts: the Test Arch phantom, three validation dipoles, dipole and DUT holders, electric field probes and DASY5 software. The field probes and measurement electronics are described in Annex B.1.

The specially designed Test Arch allows high precision positioning of both the device and any of the validation dipoles. The broadband dipoles are calibrated at a single frequency and are used for system performance checks.

In order to correlate the usability of a hearing aid with a wireless device (WD), the WD's radio frequency (RF) and audio band emissions are measured. ANSI C63.19 requires:

- Radio frequency (RF) measurements of the near-field electric and magnetic fields emitted by a WD in the vicinity of the audio output to categorize these emissions for correlation with the RF immunity of the microphone mode of operation of a hearing aid.
- Audio frequency magnetic field measurements of a WD emitted in the vicinity of the audio output to categorize these emissions for correlation with the T-Coil mode of operation of a hearing aid.

Hence, the following measurements are made for the WDs:

1. RF E-Field emissions.
2. T-Coil mode, magnetic signal strength in the audio band.
3. T-Coil mode, magnetic signal and noise articulation index.
4. T-Coil mode, magnetic signal frequency response through the audio band.
5. RF T-Coil environment: The worst case M rating from E-field 5x5 cm scan centered at the axial T-coil highest peak location.

		Document Hearing Aid Compatibility RF Emissions Test Report for the BlackBerry® Smartphone model RHT181LW (STV100-2)	Page 5(29)
Author Data Daoud Attayi	Dates of Test August 31- October 27, 2015	Report No RTS-6066-1511-05	FCC ID L6ARHT180LW

2.0 Applicable references

[1] ANSI C63.19-2011, American National Standard for Methods of Measurement of Compatibility between Wireless Communication Devices and Hearing Aids.

[2] FCC 47CFR § 20.19, Hearing Aid-Compatible Mobile Handsets, October, 2014.

[3] SPEAG DASY52 user manual, March 2013.

[4] Equipment Authorization Guidance on Hearing Aid Compatibility, KDB 285076 D01 HAC Guidance v04, October, 2013.

		Document Hearing Aid Compatibility RF Emissions Test Report for the BlackBerry® Smartphone model RHT181LW (STV100-2)	Page 6(29)
Author Data Daoud Attayi	Dates of Test August 31- October 27, 2015	Report No RTS-6066-1511-05	FCC ID L6ARHT180LW

3.0 Equipment unit tested

3.1 Picture of device

Please refer to Annex C.

Figure 3.1-1. BlackBerry® smartphone

3.2 Device description

Device Model		RHT181LW (STV100-2)			
FCC ID		L6ARHT180LW			
Serial Number	Radiated	Rev1-x08-00/01: 1161791688, 1161791942			
	Conducted	Rev1-x08-00/01: 1161792315			
Hardware Rev		CER-62544-001-Rev1-x08-00/001			
Software Build Number		AAC684, AAC698			
Prototype or Production Unit		Production			
Mode(s) of Operation		1-slot GSM 850 GSM 1900	2-slots EDGE/GPRS 850/1900	3-slots EDGE/GPRS 850/1900	4-slots EDGE/GPRS 850/1900
Target nominal maximum conducted RF output power (dBm)		32.5 29.5	30.5 28.5	29.0 26.0	27.5 25.5
Tolerance in power setting on centre channel (dB)		+2.0/-1.5	+2.0/-1.5	+2.0/-1.5	+2.0/-1.5
Duty cycle		1:8	2:8	3:8	4:8
Transmitting frequency range (MHz)		824.2 – 848.8 1850.2 – 1909.8	824.2 – 848.8 1850.2 – 1909.8	824.2 – 848.8 1850.2 – 1909.8	824.2 – 848.8 1850.2 – 1909.8
Mode(s) of Operation		802.11b	802.11g	802.11n	Bluetooth
Target nominal maximum conducted RF output power (dBm)		17.0	16.0	16.0	8.0
Tolerance in power setting on centre channel (dB)		±1.5	±1.5	±1.5	±1.0
Duty cycle		1:1	1:1	1:1	N/A
Transmitting frequency range (MHz)		2412-2462	2412-2462	2412-2462	2402-2483
Mode(s) of Operation		802.11 a/n/ac (U-NII-1)	802.11 a/n/ac (U-NII-2A)	802.11 a/n/ac (U-NII-2C)	802.11 a/n/ac (U-NII-3)
Target nominal maximum conducted RF output power (dBm)		15.5	15.5	15.5	15.5
Tolerance in power setting on centre channel (dB)		±1.5	±1.5	±1.5	±1.5
Duty cycle		1:1	1:1	1:1	1:1
Transmitting frequency range (MHz)		5180-5240	5260-5320	5520-5700	5745-5825
Mode(s) of Operation		HSPA ⁺ / WCDMA / UMTS FDD V (850)	HSPA ⁺ / WCDMA / UMTS FDD IV (1800)	HSPA ⁺ / WCDMA / UMTS FDD II (1900)	NFC
Target nominal maximum conducted RF output power (dBm)		24.0	24.0	24.0	----
Tolerance in power setting on centre channel (dB)		±1.0	±1.0	±1.0	N/A

	Document Hearing Aid Compatibility RF Emissions Test Report for the BlackBerry® Smartphone model RHT181LW (STV100-2)			Page 7(29)
	Author Data Daoud Attayi	Dates of Test August 31- October 27, 2015	Report No RTS-6066-1511-05	FCC ID L6ARHT180LW

Duty cycle	1:1	1:1	1:1	N/A
Transmitting frequency range (MHz)	826.4 – 846.6	1712.4 – 1752.6	1852.4 – 1907.6	13.56
Mode(s) of Operation	CDMA/EvDO BC0 (850)	CDMA/EvDO BC1 (1900)		
Target nominal maximum conducted RF output power (dBm)	24.0	24.0		
Tolerance in power setting on centre channel (dB)	±1.0	±1.0		
Duty cycle	1:1	1:1		
Transmitting frequency range (MHz)	824.7 – 848.31	1851.25-1908.75		

Table 3.2-1 Test device characterization for U.S. wireless operating modes/bands

Note 1: BT and NFC are not activated during test because are not held-to-ear service.

Device Model		RHT181LW (STV100-2)				
FCC ID		L6ARHK210LW				
Serial Number	Radiated	Rev1-x08-00/01: 1161791688, 1161791942				
	Conducted	Rev1-x08-00/01: 1161792315				
Hardware Rev		CER-62544-001-Rev1-x08-00/001				
Software Build Number		AAC684, AAC698				
Prototype or Production Unit		Production				
Transmission channel bandwidth		Band 2: 1.4 MHz, 3 MHz, 5 MHz, 10 MHz, 15 MHz, 20 MHz Band 4: 1.4 MHz, 3 MHz, 5 MHz, 10 MHz, 15 MHz, 20 MHz Band 5: 1.4 MHz, 3 MHz, 5 MHz, 10 MHz Band 13: 5 MHz, 10 MHz				
Transmission channel number and frequencies at highest bandwidth						
	LTE band 2		LTE band 4		LTE band 5	
	f (MHz)	Chan.	f (MHz)	Chan.	f (MHz)	Chan.
L	1860.0	18700	1720.0	20050	829.0	20450
M	1880.0	18900	1732.5	20175	836.5	20525
H	1900.0	19100	1745.0	20300	844.0	20600
	LTE band 13					
	f (MHz)	Chan.				
L						
M	782.0	23230				
H						
UE Category			Category 3, Category 6 (LTE CA)			
Modulation supported in uplink			QPSK, 16QAM			
Description of LTE antenna			1 Tx/Rx Ant sharing with GSM/UMTS, and 1 Rx ant			
LTE voice available/supported			Yes			
Hotspot with LTE+Wi-Fi			Yes			
Hotspot with LTE+Wi-Fi active with GSM/UMTS voice			No			
LTE MPR permanently built-in by design			Yes			
LTE A-MPR			Disabled during testing , by setting NV value to NV_01 on the CMW500			
Target nominal maximum conducted RF Output Power (dBm) +/- Tolerance in Power Setting on centre channel (dB)			Band 2: 23.0 ± 1.0 Band 4: 23.0 ± 1.0 Band 5: 23.0 ± 1.0 Band 13: 23.0 ± 1.0			

Other non-LTE U.S. wireless operating modes/bands	GSM//WCDMA/HSPA/CDMA/ EvDO	GSM 850 MHz GSM 1900 MHz UMTS/WCDMA 850 MHz UMTS/WCDMA 1800 MHz UMTS/WCDMA 1900 MHz CDMA BC0 850 MHz CDMA BC1 1900 MHz
	802.11 a/b/g/n/ac	2.45 GHz Wi-Fi 2.45 GHz BT 5.0 GHz Wi-Fi

Table 3.2-2 Test device characterization all North American wireless operating modes/bands

Air Interface	Band (MHz)	Type	C63.19 Tested	Simultaneous Transmitter	OTT	Power Reduction
GSM	850	VO	Yes	BT and WLAN	N/A	N/A
	1900					No
	GPRS/EDGE	DT	N/A			N/A
WCDMA (UMTS)	850	VO	Yes	BT and WLAN	N/A	N/A
	1900					
	HSPA	DT	N/A			
CDMA	850	VO	Yes	BT and WLAN	N/A	N/A
	1900					
	EvDO	DT	N/A			
LTE	700	VD	Yes	BT and WLAN	Yes	N/A
	850					
	1700					
	1900					
WLAN	2450	VD	Yes	GSM, WCDMA, and LTE	Yes	N/A
	5200					
	5500					
	5800					
BT	2450	DT	N/A	GSM, WCDMA, and LTE	N/A	N/A
VO = CMRS Voice Service DT = Digital Transport VD = CMRS IP Voice Service and Digital Transport						

Table 3.2-3 Information regarding all air interferences and bands supported by the device

		Document Hearing Aid Compatibility RF Emissions Test Report for the BlackBerry® Smartphone model RHT181LW (STV100-2)	Page 9(29)
Author Data Daoud Attayi	Dates of Test August 31- October 27, 2015	Report No RTS-6066-1511-05	FCC ID L6ARHT180LW

Device Model		RHK211LW (STV100-1)
FCC ID		L6ARHK210LW
IC ID		2503A-RHK210LW
Serial Number	Radiated	Rev3-x06-01/02: 1161463503, 1161462755 Rev4-x06-01: 1161504665, 1161507560
	Conducted	Rev2-x06-00/01/02: 1161340110
Hardware Rev		CER-62541-001- Rev2-x06-00/01/02, Rev3-x06-01/02, Rev4-x06-01
Software Build Number		AAC056, AAC251, AAC273
Prototype or Production Unit		Production

Table 3.2-4 Test device characterization for model: RHK211LW

Note 1: According to the hardware similarity document, BlackBerry model: RHT181LW and RHK211LW have the identical PCB, conducted power and circuitry for all the common bands, except LTE band 13 and CDMA bands. Therefore, conducted tests were re-used from RHK211LW for the common bands.

3.3 Battery

BAT-60122-003 (non-removable)

3.4 Antenna description

Type	Internal fixed antenna
Location	Bottom back
Configuration	Internal fixed antenna

Table 3.4-1. Antenna description

4.0 List of test equipment

Manufacturer	Test Equipment	Model Number	Serial Number	Calibration Due Date (MM/DD/YY)
SCHMID & Partner Engineering AG	Data Acquisition Electronics (DAE4)	DAE3 V1	881	01/13/2016
SCHMID & Partner Engineering AG	3-Dimensional E-Field Probe for Near-Field	ER3DV6	2285	11/03/2015
SCHMID & Partner Engineering AG	3-Dimensional E-Field Probe for Near-Field	ER3DV6	2286	01/19/2016
SCHMID & Partner Engineering AG	Audio Interference Analyzer AIA	SE UMS 170 CA	1016	CNR
Rohde & Schwarz	Base Station Simulator	CMU200	109747	11/27/2015
Rohde & Schwarz	Base Station Simulator	CMW500	136298	11/28/2016
Agilent Technologies	Signal generator	8648C	4037U03155	10/06/2017
Agilent Technologies	Power meter	E4419B	GB40202821	10/07/2017
Agilent Technologies	Power sensor	8481A	MY41095417	10/09/2016
Agilent Technologies	Power sensor	8481A	MY41095233	10/09/2016
Agilent Technologies	Power meter	N1911A	MY45100905	06/09/2017
Agilent Technologies	Power sensor	N1921A	SG45240281	02/03/2016
Amplifier Research	Amplifier	5S1G4M3	300986	CNR
SCHMID & Partner Engineering AG	Validation Dipole	CD835V3	1011	11/12/2015
SCHMID & Partner Engineering AG	Validation Dipole	CD1880V3	1008	11/12/2015
SCHMID & Partner Engineering AG	Validation Dipole	CD2450V3	1011	03/11/2017

Table 4.0-1 List of test equipment

		Document Hearing Aid Compatibility RF Emissions Test Report for the BlackBerry® Smartphone model RHT181LW (STV100-2)	Page 11(29)
Author Data Daoud Attayi	Dates of Test August 31- October 27, 2015	Report No RTS-6066-1511-05	FCC ID L6ARHT180LW

5.0 Measurement procedures and measurement system

5.1 System/Dipole Validation

The test setup should be validated when first configured and verified periodically thereafter to ensure proper function.

The HAC validation dipole antenna serves as a known source for an electrical and magnetic RF output.

1. The dipole antenna was placed in the position normally occupied by the WD.
2. The dipole was energized with a 20 dBm un-modulated continuous-wave signal.
3. The center point of the probe element(s) are 15 mm from the closest surface of the dipole elements.
4. The length of the dipole was scanned with E-field probe and the maximum value was recorded.
5. The readings were compared with the values provided by the probe manufacturer and were found to agree within tolerance of +/- 10%. Please refer to Annex A.2 for Dipole Validation Plots.

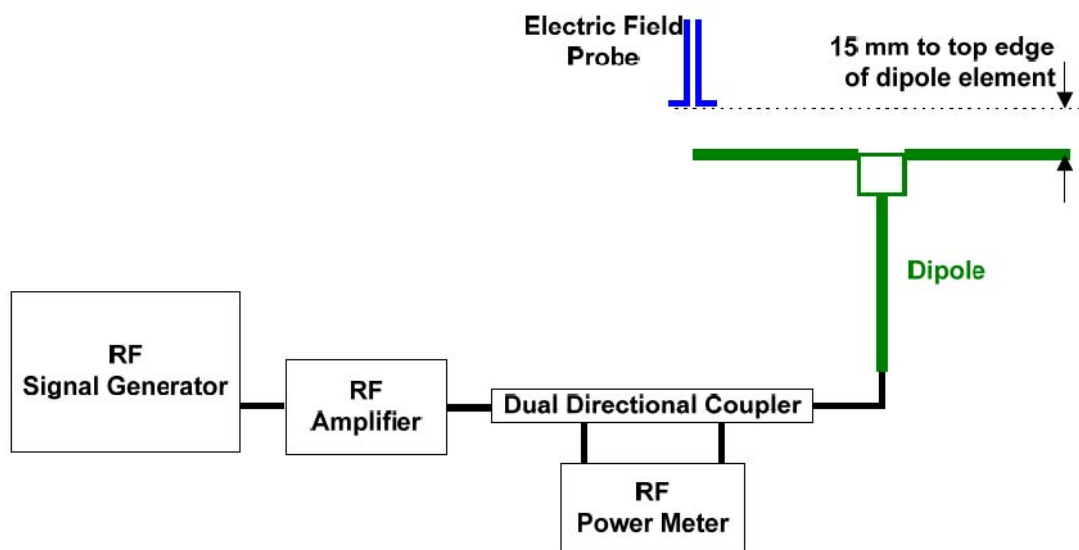

Figure 5.1-1: Dipole validation procedure

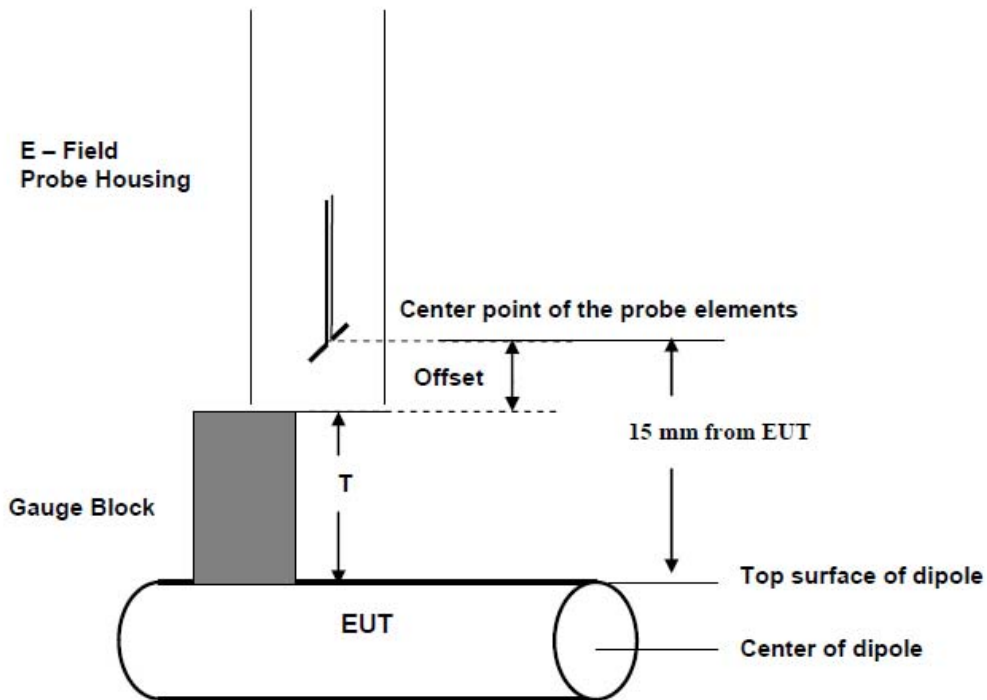



Figure 5.1-2: Gauge Block with E-Field probe

f (MHz)	Signal Type	Peak Power (dBm)	Measured E-Field (V/m)	Target E-Field (V/m)	Delta (%)
835	CW	20.00	109.7	107.3	+2.24
1880	CW	20.00	85.31	89.0	-4.15
2300	CW	20.00	91.28	N/A	N/A

Table 5.1-1: Dipole Validation measurement data

Please refer to Annex A.2 for the plots.

		Document		Page
		Hearing Aid Compatibility RF Emissions Test Report for the BlackBerry® Smartphone model RHT181LW (STV100-2)		13(29)
Author Data	Dates of Test	Report No	FCC ID	
Daoud Attayi	August 31- October 27, 2015	RTS-6066-1511-05	L6ARHT180LW	

5.2 Modulation interference factor (MIF)

For a modulated signal, the difference, in dB, determined by subtracting the signal's steady-state level, in dB, from its radio-frequency (RF) audio interference level, in dB.

MIF is the weighted envelope of a square law detector, relative to its carrier. The weighting consists of a spectral part (extracting the audible parts with a weighting similar to an A-weighting curve) followed by a quasi peak detector. Because it is used to scale the power-averaged field, the weighted quantity is relative to the carrier signal. The unmodulated carrier would not pass the spectral _filter; therefore the reference signal is defined for the carrier when the amplitude is modulated with 1 kHz and 80% AM depth.

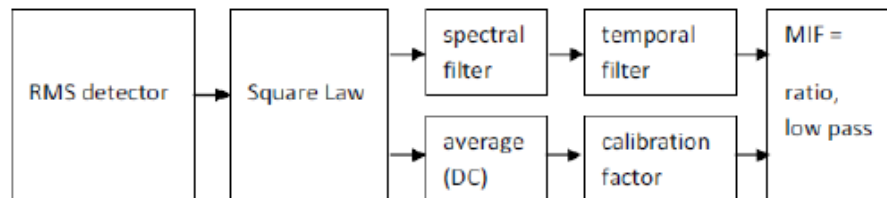

5.2-1 RF interference level measurement

For any specific fixed and repeatable modulated signal, a modulation interference factor (MIF, expressed in dB) may be developed that relates its interference potential to its steady-state rms signal level or average power level. This factor is a function only of the audio-frequency amplitude modulation characteristics of the signal and is the same for field-strength and conducted power measurements.

A Wireless Device's interference potential is a function both of the WD's average near-field field strength and of the signal's audio-frequency amplitude modulation characteristics. The portion of the interference potential attributable to the modulation characteristic can be evaluated independently of any particular WD. This evaluation of this interference potential relative to a signal's average field strength is described , and it is called its modulation interference factor (MIF).

5.3 Evaluation of Interference Potential

A WD's interference potential is a function both of the WD's average near-field field strength and of the signal's audio-frequency amplitude modulation characteristics. The portion of the interference potential attributable to the modulation characteristic can be evaluated independently of any particular WD. This evaluation of this interference potential relative to a signal's average field strength and its modulation interference factor (MIF). The MIF may be determined through analysis and simulation, allowing evaluation of an RF technology's RF interference potential in advance of actual product development.

		Document Hearing Aid Compatibility RF Emissions Test Report for the BlackBerry® Smartphone model RHT181LW (STV100-2)	Page 14(29)
Author Data Daoud Attayi	Dates of Test August 31- October 27, 2015	Report No RTS-6066-1511-05	FCC ID L6ARHT180LW

5.4 AIA Audio Interference Analyzer

The AIA is an USB powered electronic sensor to evaluate signals in the frequency range 698 MHz - 6 GHz. It contains RMS detector and audio frequency circuits for sampling of the RF envelope. In addition to the measurement circuits, the AIA contains calibration circuits which are activated immediately before the measurement for system verification. After the calibration interval is completed, the applied signal is evaluated. All filtering and evaluation is applied to the digitized raw signal with digital IIR_filters in the DASY52 software.

The RF input signal can be directly connected to the RF. The resulting coupling factor (CF) can be compensated for in the software settings to obtain the averaged power reading for evaluation of the RF Audio Interference Potential (RFAIP).

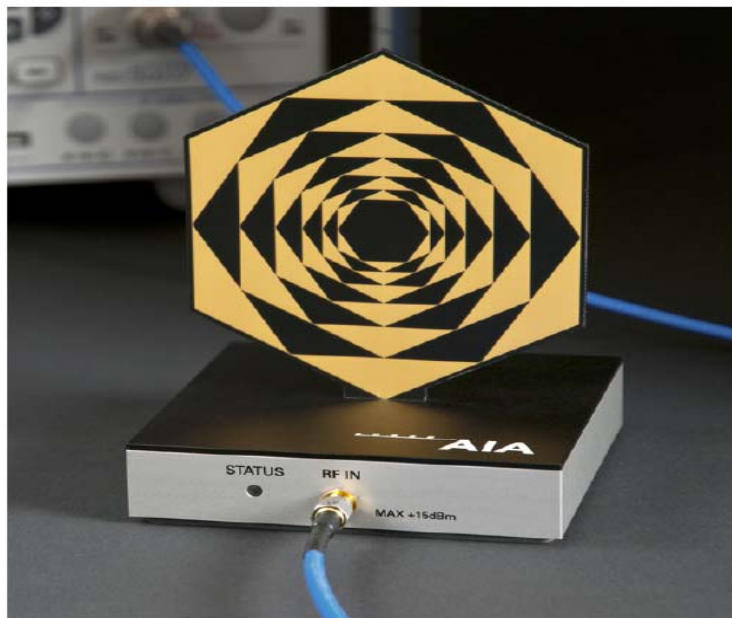

Figure 5.4-1: Audio Interference Analyzer

5.5 MIF Measurement using AIA

The DASY52 MIF measurement job and Audio Interference Analyzer (AIA) manufactured by SPEAG, part number: **SE UMS 170 CA**, serial number: **1016** were used to evaluate the MIF, PMF, RF level at the internal detector and RF Audio Interference Potential (RFAIP) of RF signals.

MIF measurement is done as follows:

- AIA is connected to the DASY5 via USB.
- RF signal is connected conducted with enough attenuation to be evaluated to an AIA via cable.
- Prepare and run a MIF measurement job with correct measurement port and timing.
- Report results via post processor.



Signal Type	Settings	Measured MIF (dB)	Target MIF (dB)	Delta (dB)
AM 80%	1 kHz	-1.29	-1.2	-0.09
AM 10%	1 kHz	-9.26	-9.1	-0.16
AM 1%	1 kHz	-19.22	-19.1	-0.08
GSM	Full-Rate Version 2, Speech Codec/ Handset Low	3.44	3.5	-0.06
WCDMA	Speech Codec Low, AMR 12.2 kbps	-25.78	-20.0	-5.78
CDMA	Speech Service SO3, RC3 FR	-19.97	-19.0	-0.97
CDMA	Speech Service SO3, RC1 1/8 th Rate	2.79	+3.3	-0.51
AM 80%	1 kHz	-1.30	-1.2	-0.10
AM 10%	1 kHz	-9.30	-9.1	-0.20
AM 1%	1 kHz	-19.26	-19.1	-0.16
WiFi	802.11b, 1 Mbps	-13.06		
WiFi	802.11b, 2 Mbps	-12.26		
WiFi	802.11b, 5.5 Mbps	-9.76		
WiFi	802.11b, 11 Mbps	-8.99		
WiFi	802.11g, 6 Mbps	-10.07		
WiFi	802.11g, 9 Mbps	-9.40		
WiFi	802.11g, 18 Mbps	-8.13		
WiFi	802.11g, 54 Mbps	-8.62		
WiFi	802.11n, 6.5 Mbps	-10.94		
WiFi	802.11n, 39 Mbps	-7.94		
WiFi	802.11n, 65 Mbps	-7.91		
WiFi	802.11a, 6 Mbps	-10.19		
WiFi	802.11a, 24 Mbps	-7.98		
WiFi	802.11a, 54 Mbps	-8.92		
WiFi	802.11n, 6.5 Mbps	-11.07		
WiFi	802.11n, 39 Mbps	-8.14		
WiFi	802.11n, 65 Mbps	-8.11		
WiFi	802.11ac, 6.5 Mbps	-10.21		
WiFi	802.11ac, 39 Mbps	-8.23		
WiFi	802.11ac, 54 Mbps	-8.80		

Table 5.5-1: MIF measurement data for GSM and UMTS/WCDMA on model: RHT181LW and RHK211LW

Please refer to Annex A.2 for MIF measurement data.

Justification for lower measured MIF than the target values:

Delta between measured and target MIF values for GSM signal is -0.06 dB which is insignificant and expected within measurement uncertainty.

		Document Hearing Aid Compatibility RF Emissions Test Report for the BlackBerry® Smartphone model RHT181LW (STV100-2)	Page 16(29)
Author Data Daoud Attayi	Dates of Test August 31- October 27, 2015	Report No RTS-6066-1511-05	FCC ID L6ARHT180LW

Delta between measured and target MIF values for WCDMA signal is -5.91 dB due to different equipment, software and system being used. Worst case HAC RF rating is M4 with large margin of > 17 dB from the limit.

Delta between measured and target MIF values for CDMA FR signal is -0.97 dB and 1/8th rate is -0.51 dB due to different equipment, software and system being used. Worst case HAC RF rating is M3 with a margin of ~ 4-5 dB from the limit.

	Document		Page
	Hearing Aid Compatibility RF Emissions Test Report for the BlackBerry® Smartphone model RHT181LW (STV100-2)		17(29)
Author Data	Dates of Test	Report No	FCC ID
Daoud Attayi	August 31- October 27, 2015	RTS-6066-1511-05	L6ARHT180LW

MIF measured data for VoLTE:

A Rohde & Schwarz CMW500 with the Data Application Unit (DAU) software/internal IP Multimedia Subsystem (IMS), internal Audio board/ Speech Codec hardware/software options were used and a VoLTE setup file was side loaded on a BlackBerry device to establish IMS registration and VoLTE call.

Signal Type	Settings	Measured MIF (dB)	Target MIF (dB)	Delta (%)
VoLTE_FDD	20 MHz BW, QPSK, RB 1, Offset 0	-14.84		
VoLTE_FDD	20 MHz BW, QPSK, RB 1, Offset 50	-14.74		
VoLTE_FDD	20 MHz BW, QPSK, RB 1, Offset 99	-14.68		
VoLTE_FDD	20 MHz BW, QPSK, RB 50, Offset 0	-21.24		
VoLTE_FDD	20 MHz BW, QPSK, RB 50, Offset 50	-21.23		
VoLTE_FDD	20 MHz BW, QPSK, RB 100, Offset 0	-21.88		
VoLTE_FDD	20 MHz BW, 16QAM, RB 1, Offset 0	-10.42		
VoLTE_FDD	20 MHz BW, 16QAM, RB 1, Offset 50	-10.41		
VoLTE_FDD	20 MHz BW, 16QAM, RB 1, Offset 99	-10.32		
VoLTE_FDD	20 MHz BW, 16QAM, RB 24, Offset 0	-16.54		
VoLTE_FDD	20 MHz BW, 16QAM, RB 24, Offset 76	-16.38		
VoLTE_FDD	20 MHz BW, 16QAM, RB 100, Offset 0	-17.69		
VoLTE_FDD	15 MHz BW, 16QAM, RB 1, Offset 74	-10.07		
VoLTE_FDD	10 MHz BW, 16QAM, RB 1, Offset 49	-10.10		
VoLTE_FDD	5 MHz BW, 16QAM, RB 1, Offset 24	-10.74		
VoLTE_FDD	3 MHz BW, 16QAM, RB 1, Offset 14	-10.22		
VoLTE_FDD	1.4 MHz BW, 16QAM, RB 1, Offset 5	-14.89		
VoLTE_FDD	AMR Codec 4.75 kbps, 15 MHz BW, 16QAM, RB 1, Offset 74	-10.06		
VoLTE_FDD	AMR Codec 7.95 kbps, 15 MHz BW, 16QAM, RB 1, Offset 74	-10.06		
VoLTE_FDD	AMR Codec 12.2 kbps, 15 MHz BW, 16QAM, RB 1, Offset 74	-10.09		
VoLTE_FDD	AMR Codec 6.60 kbps, 15 MHz BW, 16QAM, RB 1, Offset 74	-10.07		
VoLTE_FDD	AMR Codec 15.85 kbps, 15 MHz BW, 16QAM, RB 1, Offset 74	-10.04		
VoLTE_FDD	AMR Codec 23.85 kbps, 15 MHz BW, 16QAM, RB 1, Offset 74	-10.05		

Table 5.5-2: MIF measurement data for VoLTE on model RHK211LW

Please refer to Annex A.2 for MIF measurement data.

		Document Hearing Aid Compatibility RF Emissions Test Report for the BlackBerry® Smartphone model RHT181LW (STV100-2)	Page 18(29)
Author Data Daoud Attayi	Dates of Test August 31- October 27, 2015	Report No RTS-6066-1511-05	FCC ID L6ARHT180LW

5.6 Near-Field RF Emission

The following procedure was used to measure RF near E-field emission:

1. Proper operation of the field probe, probe measurement system, other instrumentation, and the positioning system was confirmed.
 2. The WD was oriented in its intended test position with the reference plane in the horizontal plane and was secured in the device holder to maintain position accuracy.
 3. A CMU 200 Base Station Simulator was used to place a normal voice call to the WD on the desired channel and to transmit at maximum power.
 4. The DASY5 system measures power drift as part of each scan. If the power during a scan drifted by more than 0.20 dB, the scan was repeated. Power drift measurements for the worst-case scans are included in Annex A.3. A fully charged battery was used for each test.
 5. The 5cm x 5cm measurement grid was centered on the center of the acoustic output or the T-Coil output, as appropriate. The field probe was located at the initial position at the center of the measurement grid.
 6. A surface verification was performed before each setup change to ensure repeatable spacing and proper maintenance of the measurement plane.
 7. The electric field probe was used to measure the highest field strength in the 5cm x 5cm reference plane. The center point of the probe measurement element(s) shall be held 15 mm from the WD reference plane.
 8. The entire 5cm x 5cm region was scanned with a 5mm step size. The reading was recorded at each measurement location. Justification of the step size and interpolation used is provided at the end of Annex A.2.
 9. Around the center sub-grid, five contiguous sub-grids were identified with the lowest maximum field strength readings. Please note that a maximum of five sub-grids can be excluded.
 10. The highest field reading was identified within the non-excluded sub-grids
 11. The highest field reading was converted from average to **RF Audio Interference Level dB (V/m)**, as appropriate. This conversion was done by the DASY5 SEMCAD processor after inputting measured MIF.
 12. The highest reading was compared to the categories defined in C63.19.
- If a WD has more than one antenna position, it is necessary to test the WD only in the condition of maximum antenna efficiency, i.e. antenna extended.
 - The WD's backlight shuts off automatically a short time after a call is established.

Emission categories	<960 MHz	
	E-field emissions	
Category M1	50 to 55	dB (V/m)
Category M2	45 to 50	dB (V/m)
Category M3	40 to 45	dB (V/m)
Category M4	<40	dB (V/m)

Emission categories	>960 MHz	
	E-field emissions	
Category M1	40 to 45	dB (V/m)
Category M2	35 to 40	dB (V/m)
Category M3	30 to 35	dB (V/m)
Category M4	<30	dB (V/m)

Table 5.6-1: Wireless Device near-field categories



Figure 5.6-1: WD reference plane for RF emission measurement

	Document		Page
	Hearing Aid Compatibility RF Emissions Test Report for the BlackBerry® Smartphone model RHT181LW (STV100-2)		20(29)
Author Data Daoud Attayi	Dates of Test August 31- October 27, 2015	Report No RTS-6066-1511-05	FCC ID L6ARHT180LW

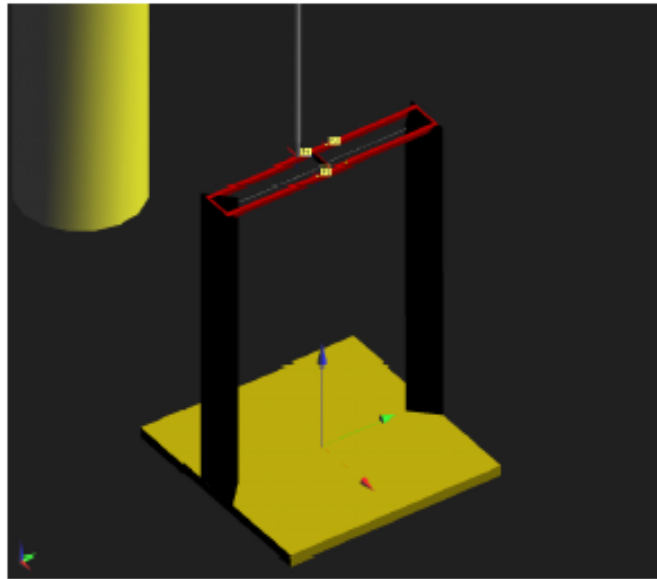

Figure 5.6-2: HAC Measurement Test Arch

6.0 Summary of results

RF Emissions Test, Slider Closed								
Mode	f (MHz)	Maximum Nominal Cond. Output Pwr. (dBm)	RF Audio Interference Level (dB V/m)	FCC Limit (dB V/m)	FCC Margin (dB)	Measured MIF	Center of Speaker or Telecoil	M-Rating
GSM 850	824.2	32.5	36.55	40	-3.45	3.44	Speaker	4
	836.8	32.7	37.47	40	-2.53	3.44	Speaker	4
	848.8	32.8	38.06	40	-1.94	3.44	Speaker	4
	848.8	32.8	38.09	40	-1.91	3.44	Telecoil	4
GSM 1900	1850.2	29.5	31.14	35	-3.86	3.44	Speaker	3
	1880	29.6	32.52	35	-2.48	3.44	Speaker	3
	1909.8	30.1	32.19	35	-2.81	3.44	Speaker	3
	1880	29.6	33.70	35	-1.30	3.44	Telecoil	3
RF Emissions Test, Slider Open								
Mode	f (MHz)	Maximum Nominal Cond. Output Pwr. (dBm)	RF Audio Interference Level (dB V/m)	FCC Limit (dB V/m)	FCC Margin (dB)	Measured MIF	Center of Speaker or Telecoil	M-Rating
GSM 850	824.2	32.5	35.5	40	-4.5	3.44	Speaker	4
	836.8	32.7	36.13	40	-3.87	3.44	Speaker	4
	848.8	32.8	37.37	40	-2.63	3.44	Speaker	4
	848.8	32.8	37.46	40	-2.54	3.44	Telecoil	4
GSM 1900	1850.2	29.5	33.98	35	-1.02	3.44	Speaker	3
	1880	29.6	34.09	35	-0.91	3.44	Speaker	3
	1909.8	30.1	33.62	35	-1.38	3.44	Speaker	3
	1880	29.6	34.39	35	-0.61	3.44	Telecoil	3
Overall M-Rating:								3

Table 6.0-1–E-Field Data Summary, model RHT181LW

RF Emissions Test					
Mode	f (MHz)	Maximum Nominal Cond. Output Pwr. (dBm)	Measured MIF (dB)	Cond. Power + MIF (dBm)	M-Rating
WCDMA band V 850	826.4	24.40	-25.78	-1.38	4
	836.4	24.35	-25.78	-1.43	4
	846.6	24.37	-25.78	-1.41	4
WCDMA band IV 1800	1712.4	24.10	-25.78	-1.68	4
	1732.6	24.27	-25.78	-1.51	4
	1752.6	24.41	-25.78	-1.37	4
WCDMA band II 1900	1852.4	24.08	-25.78	-1.70	4
	1880	24.34	-25.78	-1.44	4
	1907.6	23.90	-25.78	-1.88	4
Overall M-Rating:					4

Table 6.0-2–E-Field Data Summary, model RHK211LW

Note 1: As per C63.19-2011: RF air interface technologies that have low power have been found to produce sufficiently low RF interference potential, so that it is possible to exempt them from the product testing. Evaluation of the MIF for the worst-case operating mode. An RF air interface technology of a device is exempt from testing when its average antenna input power plus its MIF is ≤ 17 dBm for any of its operating modes. An RF air interface technology that is exempted from testing by either method shall be rated as M4.

	Document Hearing Aid Compatibility RF Emissions Test Report for the BlackBerry® Smartphone model RHT181LW (STV100-2)			Page 23(29)
	Author Data Daoud Attayi	Dates of Test August 31- October 27, 2015	Report No RTS-6066-1511-05	FCC ID L6ARHT180LW

RF Interference Potential Calculation						
Mode	f (MHz)	Maximum Nominal Cond. Output Pwr. (dBm)	Measured MIF (dB)	Cond. Power + MIF (dBm)	M-Rating	Data Rate
CDMA BC0 850	824.70	24.05	-19.97	4.08	4	Full Rate, SO3, RC3
	836.52	24.22	-19.97	4.25	4	Full Rate, SO3, RC3
	848.31	24.42	-19.97	4.45	4	Full Rate, SO3, RC3
CDMA BC1 1900	1851.25	22.75	-19.97	2.78	4	Full Rate, SO3, RC3
	1880.00	23.90	-19.97	3.93	4	Full Rate, SO3, RC3
	1908.75	23.07	-19.97	3.10	4	Full Rate, SO3, RC3
Overall M-Rating:					4	

Table 6.0-3–E-Field Data Summary, model RHT181LW

Note 1: As per C63.19-2011: RF air interface technologies that have low power have been found to produce sufficiently low RF interference potential, so that it is possible to exempt them from the product testing. Evaluation of the MIF for the worst-case operating mode. An RF air interface technology of a device is exempt from testing when its average antenna input power plus its MIF is ≤ 17 dBm for any of its operating modes. An RF air interface technology that is exempted from testing by either method shall be rated as M4.



Document

Hearing Aid Compatibility RF Emissions Test Report for the BlackBerry® Smartphone model RHT181LW (STV100-2)

Page

24(29)

Author Data

Daoud Attayi

Dates of Test

August 31- October 27, 2015

Report No

RTS-6066-1511-05

FCC ID

L6ARHT180LW

RF Interference/Emissions Test, Slider Closed									
Mode	f (MHz)	Maximum Nominal Cond. Output Pwr. (dBm)	RF Audio Interference Level (dB V/m)	FCC Limit (dB V/m)	FCC Margin (dB)	Measured MIF	Center of Speaker or Telecoil	M-Rating	Data Rate
CDMA BC0 850	824.70	24.10	36.49	40	-3.51	2.79	Speaker	4	1/8 th , SO3, RC1
	836.52	24.22	35.89	40	-4.11	2.79	Speaker	4	1/8 th , SO3, RC1
	848.31	24.45	37.88	40	-2.12	2.79	Speaker	4	1/8 th , SO3, RC1
	848.31	24.45	36.33	40	-3.67	2.79	Telecoil	4	1/8 th , SO3, RC1
CDMA BC1 1900	1851.25	22.82	31.41	35	-3.59	2.79	Speaker	3	1/8 th , SO3, RC1
	1880.00	23.91	29.92	35	-5.08	2.79	Speaker	3	1/8 th , SO3, RC1
	1908.75	23.10	30.82	35	-4.18	2.79	Speaker	3	1/8 th , SO3, RC1
	1851.25	22.82	30.88	35	-4.12	2.79	Telecoil	3	1/8 th , SO3, RC1
RF Interference/Emissions Test, Slider Open									
Mode	f (MHz)	Maximum Nominal Cond. Output Pwr. (dBm)	RF Audio Interference Level (dB V/m)	FCC Limit (dB V/m)	FCC Margin (dB)	Measured MIF	Center of Speaker or Telecoil	M-Rating	Data Rate
CDMA BC0 850	824.70	24.10	34.25	40	-5.75	2.79	Speaker	4	1/8 th , SO3, RC1
	836.52	24.22	34.55	40	-5.45	2.79	Speaker	4	1/8 th , SO3, RC1
	848.31	24.45	30.17	40	-9.83	2.79	Speaker	4	1/8 th , SO3, RC1
	836.52	24.22	29.39	40	-10.61	2.79	Telecoil	4	1/8 th , SO3, RC1
CDMA BC1 1900	1851.25	22.82	28.15	30	-1.85	2.79	Speaker	4	1/8 th , SO3, RC1
	1880.00	23.91	28.60	30	-1.40	2.79	Speaker	4	1/8 th , SO3, RC1
	1908.75	23.10	28.19	30	-1.81	2.79	Speaker	4	1/8 th , SO3, RC1
	1880.00	23.91	28.62	30	-1.38	2.79	Telecoil	4	1/8 th , SO3, RC1
Overall M-Rating:								3	

Table 6.0-4–E-Field Data Summary, model RHT181LW

	Document			Page
	Hearing Aid Compatibility RF Emissions Test Report for the BlackBerry® Smartphone model RHT181LW (STV100-2)			25(29)
Author Data	Dates of Test	Report No	FCC ID	
Daoud Attayi	August 31- October 27, 2015	RTS-6066-1511-05	L6ARHT180LW	

Mode	Band, data rate	Maximum Nominal Cond. Output Pwr. (dBm)	Measured MIF(dB)	Cond. Power + MIF (dBm)	M-Rating
WiFi	802.11b, 1 Mbps	17.9	-13.06	4.84	4
WiFi	802.11b, 2 Mbps	18.1	-12.28	5.82	4
WiFi	802.11b, 5.5 Mbps	18.0	-9.76	8.24	4
WiFi	802.11b, 11 Mbps	18.0	-8.99	9.01	4
WiFi	802.11g, 6 Mbps	16.8	-10.07	6.73	4
WiFi	802.11g, 9 Mbps	16.8	-9.4	7.4	4
WiFi	802.11g, 18 Mbps	16.8	-8.13	8.67	4
WiFi	802.11g, 54 Mbps	15.6	-8.62	6.98	4
WiFi	802.11n, 6.5 Mbps	16.8	-10.94	5.86	4
WiFi	802.11n, 39 Mbps	16.1	-7.94	8.16	4
WiFi	802.11n, 65 Mbps	15.6	-7.91	7.69	4
WiFi	802.11a, 6 Mbps	15.9	-10.19	5.71	4
WiFi	802.11a, 24 Mbps	14.7	-7.98	6.72	4
WiFi	802.11a, 54 Mbps	14.7	-8.92	5.78	4
WiFi	802.11ac, 6 Mbps	16.6	-10.21	6.39	4
WiFi	802.11ac, 9 Mbps	14.5	-9.59	4.91	4
WiFi	802.11ac, 18 Mbps	13.6	-8.23	5.37	4
WiFi	802.11ac, 54 Mbps	7.9	-8.8	-0.90	4
Overall M-rating:					4

Table 6.0-5–E-Field Data Summary, model RHK211LW

Note 2: As per C63.19-2011: RF air interface technologies that have low power have been found to produce sufficiently low RF interference potential, so that it is possible to exempt them from the product testing. Evaluation of the MIF for the worst-case operating mode. An RF air interface technology of a device is exempt from testing when its average antenna input power plus its MIF is ≤ 17 dBm for any of its operating modes. An RF air interface technology that is exempted from testing by either method shall be rated as M4.



Author Data
Daoud Attayi

Dates of Test
August 31- October 27, 2015

Report No
RTS-6066-1511-05

FCC ID
L6ARHT180LW

Mode	RF/Audio Settings	Measured MIF (dB)	Maximum Nominal Cond. Output Pwr. (dBm)	MIF + Maximum Nominal Cond. Output Pwr. (dBm)	M-Rating
VoLTE_FDD	20 MHz BW, QPSK, RB 1, Offset 0	-14.84	24	9.16	4
VoLTE_FDD	20 MHz BW, QPSK, RB 1, Offset 50	-14.74	24	9.26	4
VoLTE_FDD	20 MHz BW, QPSK, RB 1, Offset 99	-14.68	24	9.32	4
VoLTE_FDD	20 MHz BW, QPSK, RB 50, Offset 0	-21.24	23	1.76	4
VoLTE_FDD	20 MHz BW, QPSK, RB 50, Offset 50	-21.23	23	1.77	4
VoLTE_FDD	20 MHz BW, QPSK, RB 100, Offset 0	-21.88	23	1.12	4
VoLTE_FDD	20 MHz BW, 16QAM, RB 1, Offset 0	-10.42	23	12.58	4
VoLTE_FDD	20 MHz BW, 16QAM, RB 1, Offset 50	-10.41	23	12.59	4
VoLTE_FDD	20 MHz BW, 16QAM, RB 1, Offset 99	-10.32	23	12.68	4
VoLTE_FDD	20 MHz BW, 16QAM, RB 24, Offset 0	-16.54	23	6.46	4
VoLTE_FDD	20 MHz BW, 16QAM, RB 24, Offset 76	-16.38	23	6.62	4
VoLTE_FDD	20 MHz BW, 16QAM, RB 100, Offset 0	-17.69	23	5.31	4
VoLTE_FDD	15 MHz BW, 16QAM, RB 1, Offset 74	-10.07	23	12.93	4
VoLTE_FDD	10 MHz BW, 16QAM, RB 1, Offset 49	-10.10	23	12.90	4
VoLTE_FDD	5 MHz BW, 16QAM, RB 1, Offset 24	-10.74	23	12.26	4
VoLTE_FDD	3 MHz BW, 16QAM, RB 1, Offset 14	-10.22	23	12.78	4
VoLTE_FDD	1.4 MHz BW, 16QAM, RB 1, Offset 5	-14.89	23	8.11	4
VoLTE_FDD	AMR Codec 4.75 kbps, 15 MHz BW, 16QAM, RB 1, Offset 74	-10.06	23	12.94	4
VoLTE_FDD	AMR Codec 7.95 kbps, 15 MHz BW, 16QAM, RB 1, Offset 74	-10.06	23	12.94	4
VoLTE_FDD	AMR Codec 12.2 kbps, 15 MHz BW, 16QAM, RB 1, Offset 74	-10.09	23	12.91	4
VoLTE_FDD	AMR Codec 6.60 kbps, 15 MHz BW, 16QAM, RB 1, Offset 74	-10.07	23	12.93	4
VoLTE_FDD	AMR Codec 15.85 kbps, 15 MHz BW, 16QAM, RB 1, Offset 74	-10.04	23	12.96	4
VoLTE_FDD	AMR Codec 23.85 kbps, 15 MHz BW, 16QAM, RB 1, Offset 74	-10.05	23	12.95	4
Overall M-rating:					4

Table 6.0-6–E-Field Data Summary, model RHK211LW

Note 3: A Rohde & Schwarz CMW500 with the Data Application Unit (DAU) software/internal IP Multimedia Subsystem (IMS), internal Audio board/ Speech Codec hardware/software options were used and a VoLTE setup file was side loaded on a BlackBerry device to establish IMS registration and VoLTE call.

Note 4: As per C63.19-2011: RF air interface technologies that have low power have been found to produce sufficiently low RF interference potential, so that it is possible to exempt them from the product testing. Evaluation of the MIF for the worst-case operating mode. An RF air interface technology of a device is exempt from testing when its average antenna input power plus its MIF is ≤ 17 dBm for any of its operating modes. An RF air interface technology that is exempted from testing by either method shall be rated as M4.

		Document Hearing Aid Compatibility RF Emissions Test Report for the BlackBerry® Smartphone model RHT181LW (STV100-2)	Page 27(29)
Author Data Daoud Attayi	Dates of Test August 31- October 27, 2015	Report No RTS-6066-1511-05	FCC ID L6ARHT180LW

6.1 Conclusion

The BlackBerry® Smartphone Model: **RHT181LW (STV100-2)** is categorized to be **M3T4** based on HAC RF Emission and ABM HAC T-Coil performance in accordance with ANSI C63.19-2011: American National Standard for Methods of Measurement of Compatibility between Wireless Communication Devices and Hearing Aids.

Therefore, the device is found to be in compliance with the requirements of FCC 47 CFR 20.19 (2014-10-01) Hearing Aid-Compatible Mobile Handsets.

7.0 Measurement uncertainty

HAC Uncertainty Budget According to ANSI C63.19 [1], [2]							
Error Description	Uncert. value	Prob. Dist.	Div.	(c_i) E	(c_i) H	Std. Unc. E	Std. Unc. H
Measurement System							
Probe Calibration	±5.1 %	N	1	1	1	±5.1 %	±5.1 %
Axial Isotropy	±4.7 %	R	$\sqrt{3}$	1	1	±2.7 %	±2.7 %
Sensor Displacement	±16.5 %	R	$\sqrt{3}$	1	0.145	±9.5 %	±1.4 %
Boundary Effects	±2.4 %	R	$\sqrt{3}$	1	1	±1.4 %	±1.4 %
Phantom Boundary Effect	±7.2 %	R	$\sqrt{3}$	1	0	±4.1 %	±0.0 %
Linearity	±4.7 %	R	$\sqrt{3}$	1	1	±2.7 %	±2.7 %
Scaling with PMR calibration	±10.0 %	R	$\sqrt{3}$	1	1	±5.8 %	±5.8 %
System Detection Limit	±1.0 %	R	$\sqrt{3}$	1	1	±0.6 %	±0.6 %
Readout Electronics	±0.3 %	N	1	1	1	±0.3 %	±0.3 %
Response Time	±0.8 %	R	$\sqrt{3}$	1	1	±0.5 %	±0.5 %
Integration Time	±2.6 %	R	$\sqrt{3}$	1	1	±1.5 %	±1.5 %
RF Ambient Conditions	±3.0 %	R	$\sqrt{3}$	1	1	±1.7 %	±1.7 %
RF Reflections	±12.0 %	R	$\sqrt{3}$	1	1	±6.9 %	±6.9 %
Probe Positioner	±1.2 %	R	$\sqrt{3}$	1	0.67	±0.7 %	±0.5 %
Probe Positioning	±4.7 %	R	$\sqrt{3}$	1	0.67	±2.7 %	±1.8 %
Extrap. and Interpolation	±1.0 %	R	$\sqrt{3}$	1	1	±0.6 %	±0.6 %
Test Sample Related							
Device Positioning Vertical	±4.7 %	R	$\sqrt{3}$	1	0.67	±2.7 %	±1.8 %
Device Positioning Lateral	±1.0 %	R	$\sqrt{3}$	1	1	±0.6 %	±0.6 %
Device Holder and Phantom	±2.4 %	R	$\sqrt{3}$	1	1	±1.4 %	±1.4 %
Power Drift	±5.0 %	R	$\sqrt{3}$	1	1	±2.9 %	±2.9 %
Phantom and Setup Related							
Phantom Thickness	±2.4 %	R	$\sqrt{3}$	1	0.67	±1.4 %	±0.9 %
Combined Std. Uncertainty						±16.3 %	±12.3 %
Expanded Std. Uncertainty on Power						±32.6 %	±24.6 %
Expanded Std. Uncertainty on Field						±16.3 %	±12.3 %

Table 7.0-1. Worst-Case uncertainty budget for HAC free field assessment according to ANSI C63.19 [1], [2]. The budget is valid for the frequency range 700 MHz - 3 GHz and represents a worstcase analysis.

	Document		Page
	Hearing Aid Compatibility RF Emissions Test Report for the BlackBerry® Smartphone model RHT181LW (STV100-2)		29(29)
Author Data	Dates of Test	Report No	FCC ID
Daoud Attayi	August 31- October 27, 2015	RTS-6066-1511-05	L6ARHT180LW

7.1 Site-Specific Uncertainty

RF Reflections

Section 4.2 of ANSI C63.19 requires that any RF reflecting objects are a minimum distance of 2 wavelengths away from the WD under test. For this WD, the longest wavelength occurs when the WD is transmitting at 824.7MHz. The wavelength is:

$$\lambda = \frac{c}{f} = \frac{3 \cdot 10^8 \text{ m/s}}{824.7 \text{ MHz}} = 0.364 \text{ m}$$

Therefore, 2 wavelengths result in a distance of 0.73m. Tests are performed in an RF shielded chamber. The distance to the nearest wall is > 1m and the distance to the robot's safety guardrail is ~1.0m, both satisfying the requirement. In addition, RF absorbing cones are placed at the base of the robot to further reduce reflections. The HAC phantom arch is made of low dielectric constant plastic and should not be a source of reflections.

Environmental Conditions

During measurements, the temperature of the test lab was kept between 21°C and 25°C and relative humidity was maintained between 20% and 55%.

Ambient Noise

ANSI C63.19 standard requires RF ambient noise to be at least 20dB below the measurement level. Scans of RF ambient noise fields were previously performed for verification and was determined to be < 20 dB than the measured WD RF field levels.