

FCC/IC DFS Test Report

Tested in accordance with
Federal Communications Commission (FCC)
Personal Communications Services
CFR 47, Parts 15.407
&
Industry Canada (IC), RSS-247



REPORT NO.: RTS-6066-1509-14

PRODUCT MODEL NO.: RHK211LW (STV100-1)
TYPE NAME: BlackBerry® smartphone
FCC ID: L6ARHK210LW
IC: 2503A-RHK210LW

DATE: September 15, 2015

RTS is accredited
according to
EN ISO/IEC 17025 by:



592

 BlackBerry.	DFS Test Report for the BlackBerry® smartphone Model RHK211LW (STV100-1)	
Test Report No. RTS-6066-1509-14	Date of Test August 24, 2015	FCC ID: L6ARHK210LW IC: 2503A-RHK210LW

Statement of Performance:

The BlackBerry® smartphone, model RHK211LW (STV100-1) part number CER-62541-001 Rev4-x06-01 and accessories when configured and operated per BlackBerry’s operation instructions performs within the requirements of the test standards.

Declaration:

We hereby certify that:

The test data reported herein is an accurate record of the performance of the sample(s) tested.

The test results are valid for the tested unit (s) only.

The test equipment used was suitable for the tests performed and within manufacturer’s published specifications and operating parameters.

The test methods were consistent with the methods described in the relevant standards.

Documented by:

Reviewed by:

Kevin Guo
Compliance Specialist I

Savtej S. Sandhu
Compliance Specialist II

Reviewed and Approved by:

Masud S. Attayi, P.Eng.
Sr. Manager, Regulatory Certification & Compliance



	DFS Test Report for the BlackBerry® smartphone Model RHK211LW (STV100-1)	
Test Report No. RTS-6066-1509-14	Date of Test August 24, 2015	FCC ID: L6ARHK210LW IC: 2503A-RHK210LW

Table of Contents

A.	Scope	4
B.	Associated Documents.....	4
C.	Product Identification	4
D.	Support Equipment Used for the Testing of the EUT	5
E.	Test Results Chart – FCC Part 15, Client Device.....	6
F.	Summary of Result.....	6
G.	Compliance Test Equipment Used	7
APPENDIX 1 - DFS TEST PLOTS and DATA		8

 BlackBerry	DFS Test Report for the BlackBerry® smartphone Model RHK211LW (STV100-1)	
Test Report No. RTS-6066-1509-14	Date of Test August 24, 2015	FCC ID: L6ARHK210LW IC: 2503A-RHK210LW

A. Scope

This report details the results of compliance tests that were performed in accordance with the requirements of:

- FCC CFR 47 Part 15.407 General Technical Requirements , October, 2014
- KDB 905462 D02 UNII DFS Compliance Procedures v01r02
- KDB 848637 D01 DFS Client Devices v01
- Industry Canada, RSS-247, Issue 1, May, 2015, Digital Transmission Systems (DTSS), Frequency Hopping Systems (FHSs) and Licence-Exempt Local Area Network (LE-LAN) Devices

B. Associated Documents

None

C. Product Identification

Manufactured by BlackBerry Limited whose headquarters is located at:

295 Phillip Street
Waterloo, Ontario
Canada, N2L 3W8
Phone: 519 888 7465
Fax: 519 888 6906

The equipment under test (EUT) was tested at the following BlackBerry RTS EMC location:

RTS Test Facility
440 Phillip Street
Waterloo, Ontario
Canada, N2L 5R9
Phone: 519 888 7465
Fax: 519 888 6906

The testing was performed on August 24, 2015.

 BlackBerry.	DFS Test Report for the BlackBerry® smartphone Model RHK211LW (STV100-1)	
Test Report No. RTS-6066-1509-14	Date of Test August 24, 2015	FCC ID: L6ARHK210LW IC: 2503A-RHK210LW

BlackBerry® smartphone Samples Tested

SAMPLE	MODEL	CER NUMBER	IMEI	SOFTWARE
1	RHK211LW	CER-62541-001 Rev4-x06-01	004402243068065	Software Build: AAC273

DFS testing was performed on sample 1.

The manufacturer declared modes for the EUT operational characteristics that affect DFS are as follows:

Operating Modes (5250 -5350 MHz, 5470-5725MHz)

- Master Device
- Client Device (no In-Service Monitoring, no Ad – Hoc mode)
- Client Device with In-Service Monitoring

Channel Protocol

- IP Based
- Frame Based
- Other _____

D. Support Equipment Used for the Testing of the EUT

Manufacturer	Description	Model	Serial Number	FCC ID and IC
Cisco	Wireless Controller	2504	PSJ162904G5	-
Cisco	Access Point	AIR-CAP3702E-A-K9	FTX181077V8	LDK102087 2461B-102087
D-Link	Router	WBR-1310	P10317B010096	KA2WBR1310 4216A-WBR1310
Lenovo	Laptop	4236-D84	R8-A1XXN 11/05	-

	DFS Test Report for the BlackBerry® smartphone Model RHK211LW (STV100-1)	
Test Report No. RTS-6066-1509-14	Date of Test August 24, 2015	FCC ID: L6ARHK210LW IC: 2503A-RHK210LW

E. Test Results Chart – FCC Part 15, Client Device

SPECIFICATION		TEST TYPE	Meets Requirement	Test Data APPENDIX
FCC CFR 47	IC			
Part 15.407	RSS-247, 6.3	Transmission Closing Time	Yes	1
Part 15.407	RSS-247, 6.3	Channel move time	Yes	1
Part 15.407	RSS-247, 6.3	Non-Occupancy time	Yes	1

F. Summary of Result

- a). The BlackBerry® smartphone met the requirement of the Transmission Closing Time, Channel Move time and Non-occupancy period requirement as per FCC 15.407. The measurement was performed on Channel 60 and 106 of the DFS band with 80MHz bandwidth, and Channel 58 and 100 of the DFS band with 20 MHz bandwidth. Radar Type 1 of the Short Pulse Test waveform was used for tests.

See APPENDIX 1 for the test data.

Measurement Uncertainties:

Measurement	Measurement Unit	Expanded Uncertainty
DFS Threshold (Conducted)	dBm	1.2

 BlackBerry	DFS Test Report for the BlackBerry® smartphone Model RHK211LW (STV100-1)	
Test Report No. RTS-6066-1509-14	Date of Test August 24, 2015	FCC ID: L6ARHK210LW IC: 2503A-RHK210LW

G. Compliance Test Equipment Used

<u>UNIT</u>	<u>MANUFACTURER</u>	<u>MODEL</u>	<u>SERIAL NUMBER</u>	<u>CAL DUE DATE (YY MM DD)</u>	<u>USE</u>
Spectrum Analyzer	Rohde & Schwarz	FSV	101820	15-11-25	DFS
DFS RF Modulator	National Instruments	PXIe-5611	EC157C	16-03-17	DFS
DFS I/Q Signal Generator	National Instruments	PXIe-5450	EC6BB1	16-03-17	DFS
DFS RF Signal Generator	National Instruments	PXIe-5620	ED2167	16-03-17	DFS
T/RH Meter	OMEGA	iTHX-SD	0380564	16-11-14	DFS

H. Test Software used

<u>SOFTWARE</u>	<u>COMPANY</u>	<u>VERSION</u>	<u>USE</u>
iDFTest	Redwolf	2.5	DFS

APPENDIX 1 - DFS TEST PLOTS and DATA

BlackBerry	DFS Test Report for the BlackBerry® smartphone Model RHK211LW (STV100-1) APPENDIX 1	
Test Report No. RTS-6066-1509-14	Date of Test August 24, 2015	FCC ID: L6ARHK210LW IC: 2503A-RHK210LW

DFS Conducted Test Results

DFS Test Methods

Conducted Test Method

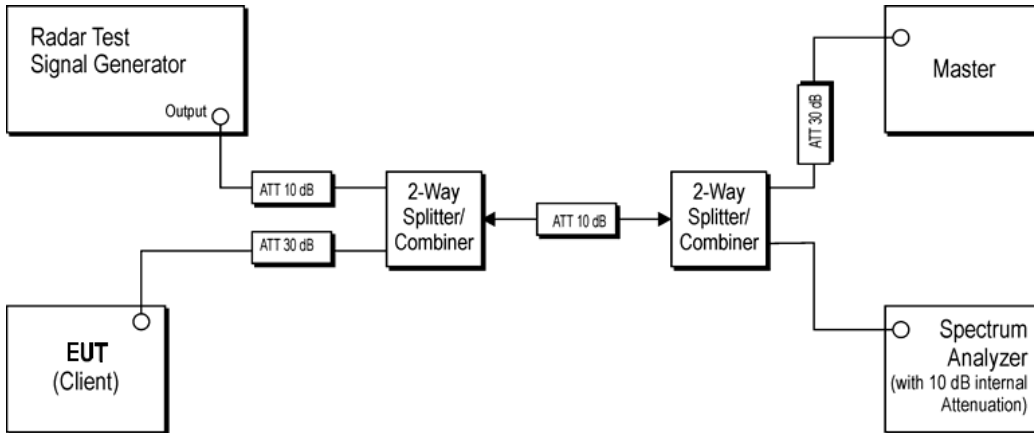

<u>UNIT</u>	<u>MANUFACTURER</u>	<u>MODEL</u>	<u>SERIAL NUMBER</u>
10dB Attenuator	Aeroflex Weinschel	3330A-10	-
30dB Attenuator	Aeroflex Weinschel	3330A-30	-
2-Way Splitter	Weinschel	1515	QC170
2-Way Splitter	Weinschel	1534	221

A spectrum analyzer is used as a monitor to verify that the EUT has vacated the Channel within the Transmission Closing Time and Channel Move Time.

 BlackBerry	DFS Test Report for the BlackBerry® smartphone Model RHK211LW (STV100-1) APPENDIX 1	
Test Report No. RTS-6066-1509-14	Date of Test August 24, 2015	FCC ID: L6ARHK210LW IC: 2503A-RHK210LW

DFS Conducted Test Results Cont'd

Radar Waveforms

FCC Short Pulse Radar Test Waveforms					
Radar Type	Pulse Width (µsec)	PRI (µsec)	Number of Pulses	Minimum Detection Percentage	Minimum Number of Trials
1	1	1428	18	60%	30
2	1-5	150-230	23-29	60%	30
3	6-10	200-500	16-18	60%	30
4	11-20	200-500	12-16	60%	30
Aggregate (Radar Types 1-4)				80%	120

FCC Long Pulse Radar Test Waveforms							
Radar Type	Pulse Width (µsec)	Chirp Width (MHz)	PRI (µs)	Number of Pulses per Burst	Number of Bursts	Minimum Detection Percentage	Minimum Number of Trials
5	50-100	5-20	1000-2000	1-3	8-20	80%	30

Frequency Hopping Radar Test Waveforms							
Radar Type	Pulse Width (µsec)	PRI (µsec)	Pulses per Hop	Hopping Rate (kHz)	Hopping Sequence Length (msec)	Minimum Detection Percentage	Minimum Number of Trials
6	1	333	9	0.333	300	70%	30

	DFS Test Report for the BlackBerry® smartphone Model RHK211LW (STV100-1) APPENDIX 1	
Test Report No. RTS-6066-1509-14	Date of Test August 24, 2015	FCC ID: L6ARHK210LW IC: 2503A-RHK210LW

DFS Conducted Test Results Cont'd

The following tests were performed by Kevin Guo

Date of the test: August 24, 2015

The environmental conditions were: Temperature: 24.7 °C
Humidity: 49.5 %

Channel Bandwidth (80MHz)

Channel 60

Wave form Type	Transmission Closing Time		Channel Move Time		Non-Occupancy Period		Result
	Measured	Limit	Measured	Limit	Measured	Limit	Limit
Radar Type 1	64 ms	260 ms	512 ms	10 s	1860 s	1800 s	PASS

Transmission Closing Time

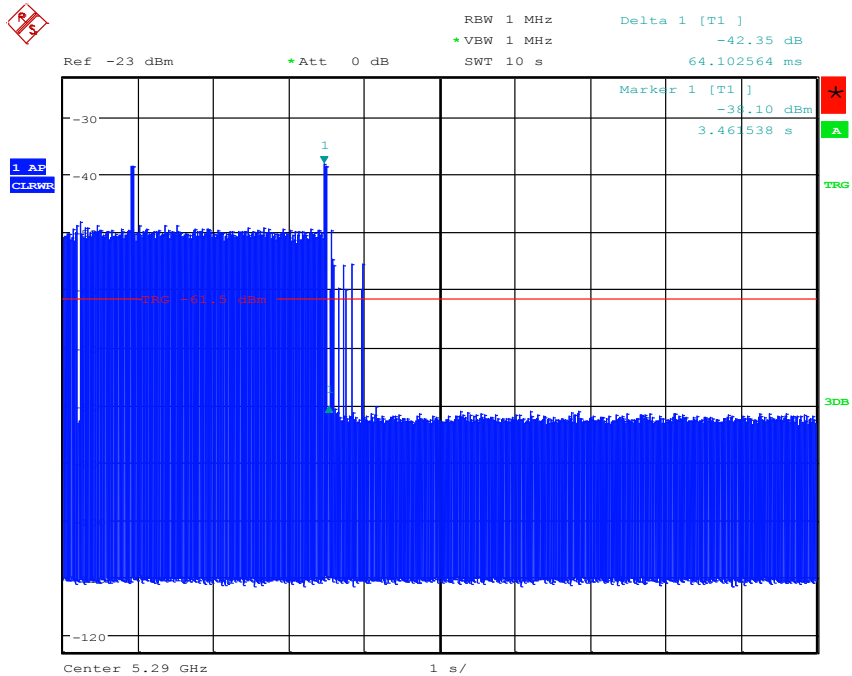

Date: 24.AUG.2015 13:00:30

	DFS Test Report for the BlackBerry® smartphone Model RHK211LW (STV100-1) APPENDIX 1	
Test Report No. RTS-6066-1509-14	Date of Test August 24, 2015	FCC ID: L6ARHK210LW IC: 2503A-RHK210LW

DFS Conducted Test Results Cont'd

Channel Move Time

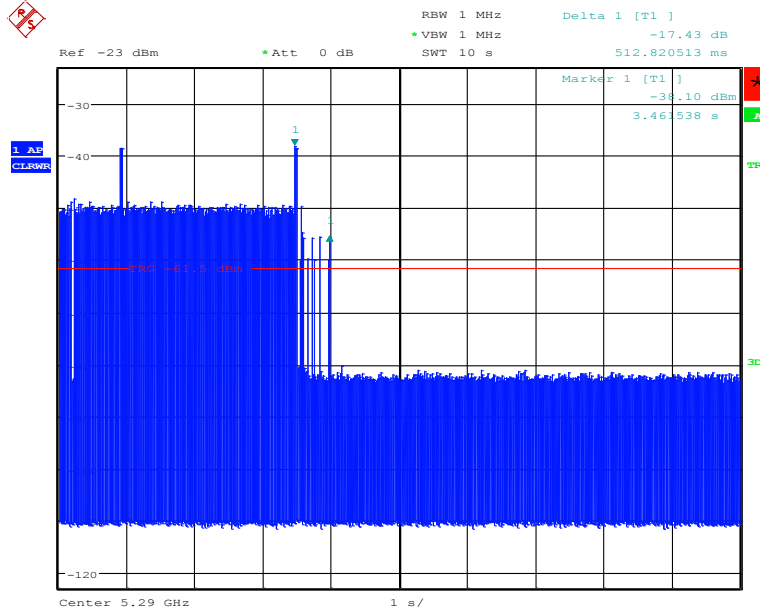

Date: 24.AUG.2015 13:01:43

Non-Occupancy Time

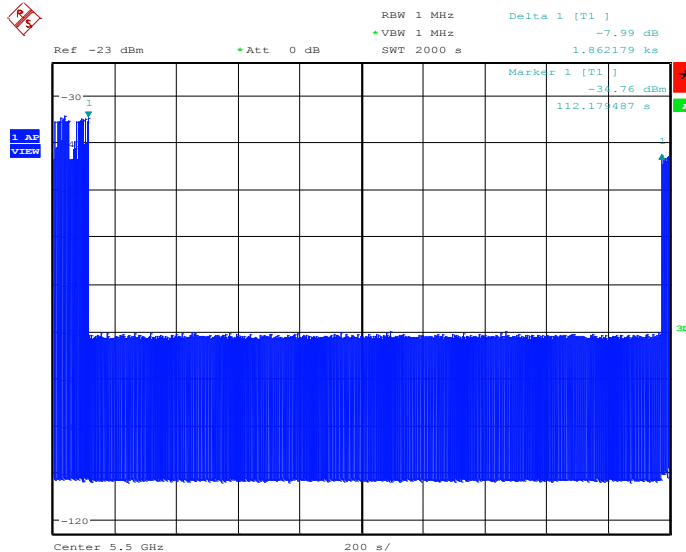

Date: 24.AUG.2015 17:48:58

	DFS Test Report for the BlackBerry® smartphone Model RHK211LW (STV100-1) APPENDIX 1	
Test Report No. RTS-6066-1509-14	Date of Test August 24, 2015	FCC ID: L6ARHK210LW IC: 2503A-RHK210LW

DFS Conducted Test Results Cont'd

The following tests were performed by Kevin Guo

Date of the test: August 24, 2015

The environmental conditions were: Temperature: 24.7 °C
Humidity: 49.5 %

Channel Bandwidth (80MHz)

Channel 106

Wave form Type	Transmission Closing Time		Channel Move Time		Non-Occupancy Period		Result
	Measured	Limit	Measured	Limit	Measured	Limit	Limit
Radar Type 1	64 ms	260 ms	72 ms	10 s	1862 s	1800 s	PASS

Transmission Closing Time

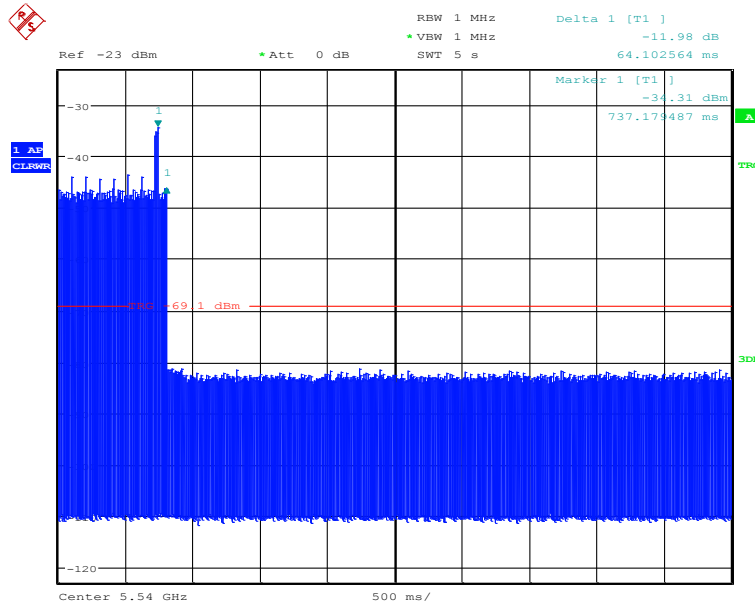

Date: 24.AUG.2015 15:11:34

BlackBerry	DFS Test Report for the BlackBerry® smartphone Model RHK211LW (STV100-1) APPENDIX 1	
Test Report No. RTS-6066-1509-14	Date of Test August 24, 2015	FCC ID: L6ARHK210LW IC: 2503A-RHK210LW

DFS Conducted Test Results Cont'd

Channel Move Time

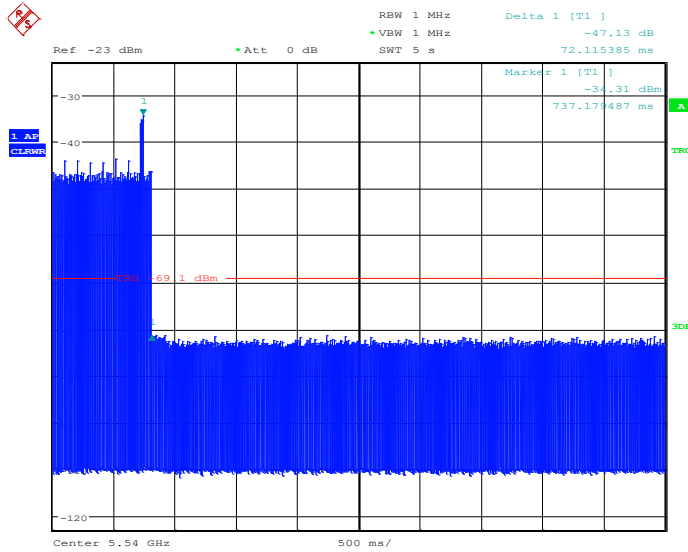

Date: 24.AUG.2015 15:12:16

Non-Occupancy Time

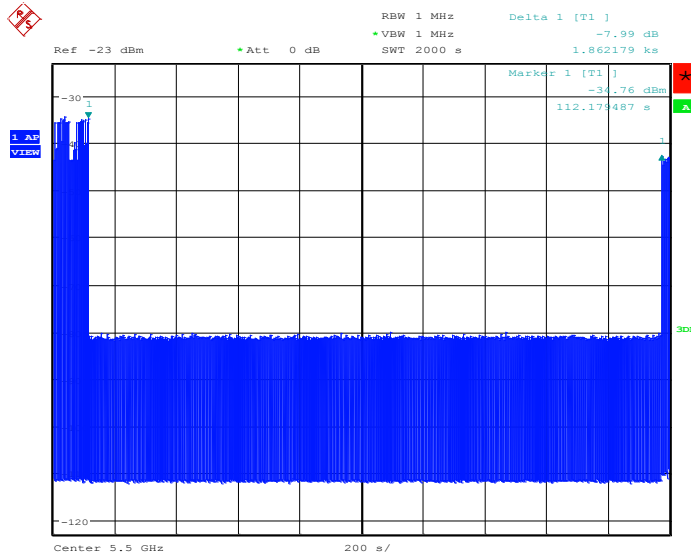

Date: 24.AUG.2015 17:48:58

BlackBerry	DFS Test Report for the BlackBerry® smartphone Model RHK211LW (STV100-1) APPENDIX 1	
Test Report No. RTS-6066-1509-14	Date of Test August 24, 2015	FCC ID: L6ARHK210LW IC: 2503A-RHK210LW

DFS Conducted Test Results Cont'd

The following tests were performed by Kevin Guo

Date of the test: August 24, 2015

The environmental conditions were: Temperature: 24.7 °C
Humidity: 49.5 %

Channel Bandwidth (20MHz)

Channel 58

Wave form Type	Transmission Closing Time		Channel Move Time		Non-Occupancy Period		Result
	Measured	Limit	Measured	Limit	Measured	Limit	Limit
Radar Type 1	48 ms	260 ms	160 ms	10 s	1863 s	1800 s	PASS

Transmission Closing Time

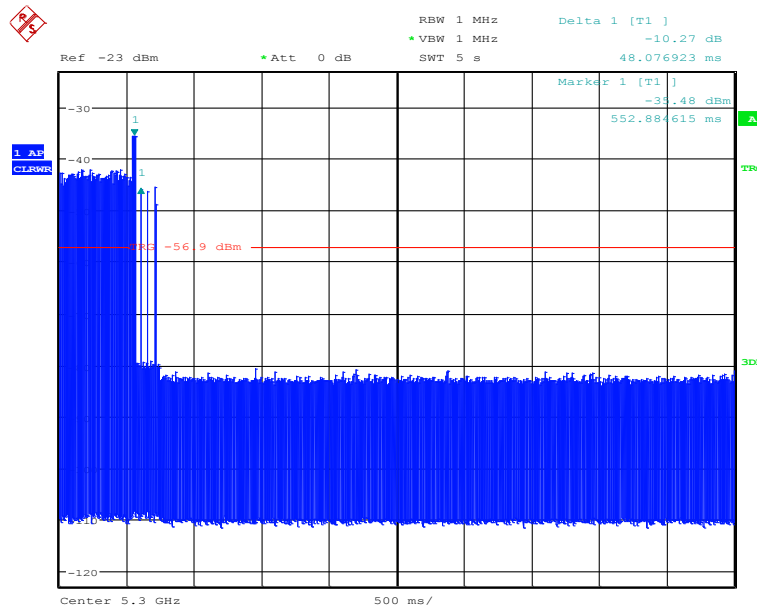

Date: 24.AUG.2015 14:45:27

BlackBerry	DFS Test Report for the BlackBerry® smartphone Model RHK211LW (STV100-1) APPENDIX 1	
Test Report No. RTS-6066-1509-14	Date of Test August 24, 2015	FCC ID: L6ARHK210LW IC: 2503A-RHK210LW

DFS Conducted Test Results Cont'd

Channel Move Time

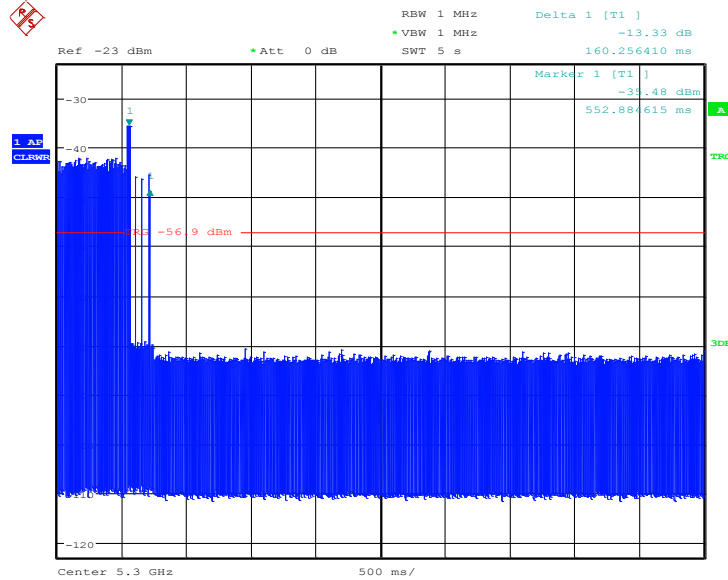

Date: 24.AUG.2015 14:46:12

Non-Occupancy Time

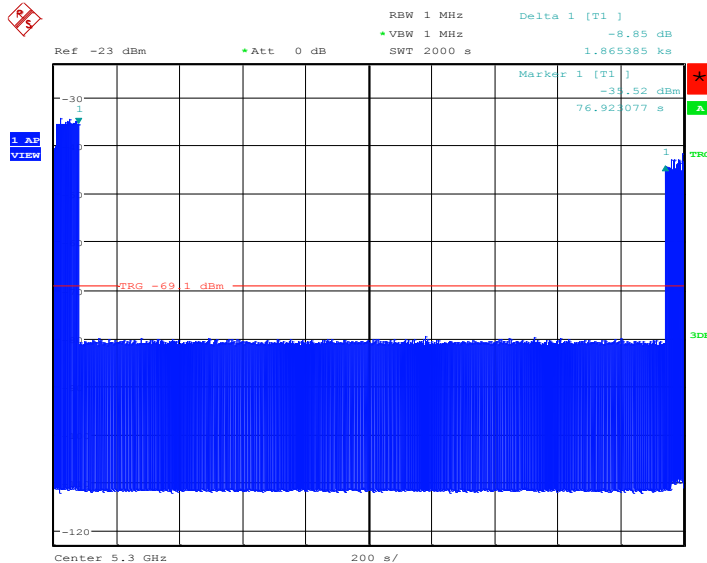

Date: 24.AUG.2015 17:11:54

	DFS Test Report for the BlackBerry® smartphone Model RHK211LW (STV100-1) APPENDIX 1	
Test Report No. RTS-6066-1509-14	Date of Test August 24, 2015	FCC ID: L6ARHK210LW IC: 2503A-RHK210LW

DFS Conducted Test Results Cont'd

The following tests were performed by Kevin Guo

Date of the test: August 24, 2015

The environmental conditions were: Temperature: 24.7 °C
Humidity: 49.5 %

Channel Bandwidth (20MHz)

Channel 100

Wave form Type	Transmission Closing Time		Channel Move Time		Non-Occupancy Period		Result
	Measured	Limit	Measured	Limit	Measured	Limit	Limit
Radar Type 1	40 ms	260 ms	128 ms	10 s	1862 s	1800 s	PASS

Transmission Closing Time

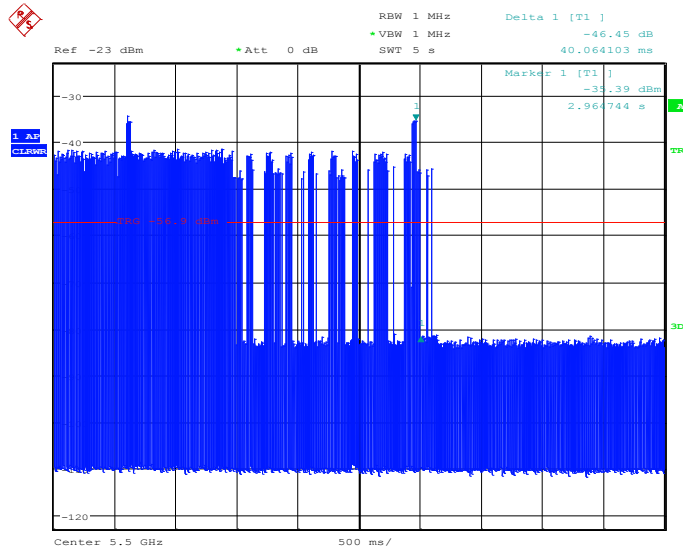

Date: 24.AUG.2015 13:19:06

	DFS Test Report for the BlackBerry® smartphone Model RHK211LW (STV100-1) APPENDIX 1	
Test Report No. RTS-6066-1509-14	Date of Test August 24, 2015	FCC ID: L6ARHK210LW IC: 2503A-RHK210LW

DFS Conducted Test Results Cont'd

Channel Move Time

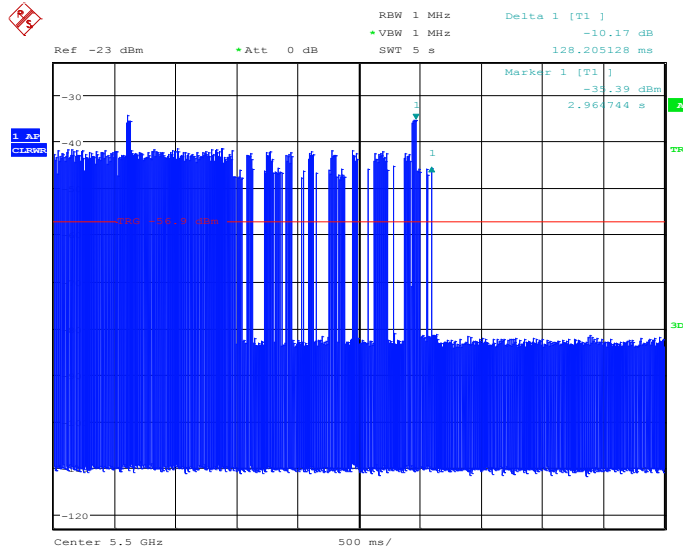

Non-Occupancy Time

