



FCC/IC RF Test Report

APPLICANT : BlackBerry Limited
EQUIPMENT : Smartphone
BRAND NAME : BlackBerry
MODEL NAME : RHG161LW
MARKETING NAME : SQC100-4
FCC ID : L6ARHG160LW
IC : 2503A-RHG160LW
STANDARD : FCC Part 15 Subpart C §15.225 ; IC RSS-210 issue 8
CLASSIFICATION : (DXX) Low Power Communication Device Transmitter

The testing was completed on Sep. 10, 2014. We, SPORTON INTERNATIONAL INC., would like to declare that the tested sample has been evaluated in accordance with the test procedures and has been in compliance with the applicable technical standards.

The test results in this report apply exclusively to the tested model / sample. Without written approval of SPORTON INTERNATIONAL INC., the test report shall not be reproduced except in full.

Reviewed by: Joseph Lin / Supervisor

Approved by: Jones Tsai / Manager



SPORTON INTERNATIONAL INC.

No. 52, Hwa Ya 1st Rd., Hwa Ya Technology Park, Kwei-Shan Hsiang, Tao Yuan Hsien, Taiwan, R.O.C.

SPORTON INTERNATIONAL INC.

TEL : 886-3-327-3456

FAX : 886-3-328-4978

FCC ID : L6ARHG160LW

IC : 2503A-RHG160LW

Page Number : 1 of 17

Report Issued Date : Oct. 20, 2014

Report Version : Rev. 01

Report Template No.: BU5-FR15CNFC Version 1.0

Report Template No.: BU5-CR210NFC Version 1.0



Table of Contents

SUMMARY OF THE TEST RESULT4
1. GENERAL INFORMATION.....5
1.1 Applicant 5
1.2 Manufacturer..... 5
1.3 Product Details..... 5
1.4 Modification of EUT..... 5
1.5 Testing Location 6
1.6 Applicable Standards 6
1.7 Test Modes..... 6
1.8 Test Configurations..... 7
1.9 Table for Supporting Units 8
2. CONDUCTED EMISSION TEST.....9
2.1 Measuring Instruments 9
2.2 Test setup 9
2.3 Test Result of Conducted Emission Test..... 9
2.4 AC Power Line Conducted Emissions Measurement 10
3. CONDUCTED TEST ITEMS11
3.1 Measuring Instruments 11
3.2 Test Setup 11
3.3 Test Result of Conducted Test Items..... 11
3.4 20dB Spectrum Bandwidth Measurement 12
3.5 Frequency Stability Measurement 12
4. RADIATED TEST ITEMS.....13
4.1 Measuring Instruments 13
4.2 Test Setup 13
4.3 Test Result of Radiated Test Items 13
4.4 Field Strength of Fundamental Emissions and Mask Measurement 14
4.5 Radiated Emissions Measurement 15
5. LIST OF MEASURING EQUIPMENT17
APPENDIX A. TEST RESULTS OF CONDUCTED EMISSION TEST
APPENDIX B. TEST RESULTS OF CONDUCTED TEST ITEMS
B.1. Test Result of 20dB Spectrum Bandwidth
B.2 Test Result of Frequency Stability
APPENDIX C. TEST RESULTS OF RADIATED TEST ITEMS
C.1 Test Result of Field Strength of Fundamental Emissions
C.2 Results of Radiated Emissions (9 kHz~30MHz)
C.3 Results of Radiated Emissions (30MHz~1GHz)
APPENDIX D. SETUP PHOTOGRAPHS



REVISION HISTORY

REPORT NO.	VERSION	DESCRIPTION	ISSUED DATE
FR471420D	Rev. 01	Initial issue of report	Oct. 20, 2014



SUMMARY OF THE TEST RESULT

Applied Standard: 47 CFR FCC Part 15 Subpart C				
Part	FCC Rule	Description of Test	Result	Under Limit
3.1	15.207	AC Power Line Conducted Emissions	Complies	6.30 dB at 13.558MHz
3.2	15.225(a)(b)(c)	Field Strength of Fundamental Emissions	Complies	62.43 dB at 13.560 MHz
3.3	2.1049	20dB Spectrum Bandwidth	Complies	-
3.4	15.225(d) 15.209	Radiated Emissions	Complies	24.14 dB at 1.309 MHz for Quasi-Peak
3.5	15.225(e)	Frequency Stability	Complies	-
3.6	15.203	Antenna Requirements	Complies	-

Test Items	Uncertainty	Remark
AC Power Line Conducted Emissions	±2.26dB	Confidence levels of 95%
Radiated Emissions (30MHz~1000MHz)	±4.70dB	Confidence levels of 95%



1. GENERAL INFORMATION

1.1 Applicant

BlackBerry Limited

2300 University Street East, Waterloo, ON., CAN, N2K1A0

1.2 Manufacturer

FIH Mobile Limited

No. 4, Mingsheng St., Tu-Cheng Dist., New Taipei City 23679, Taiwan

1.3 Product Details

Items	Description
Tx/Rx Frequency Range	13.553 ~ 13.567MHz
Channel Number	1
20dBW	2.640KHz
99%OBW	2.240KHz
IMEI Code	004402242681074 for Conducted Emission 0044022426829571 for Radiated Emission
HW Version	PVT 2
SW Version	BlackBerry 10.3.1.565/566
Antenna Type	Loop Antenna
Type of Modulation	ASK

Remark: The above EUT's information was declared by manufacturer. Please refer to the specifications or user's manual for more detailed description.

1.4 Modification of EUT

No modifications are made to the EUT during all test items.

1.5 Testing Location

Sporton Lab is accredited to ISO 17025 by Taiwan Accreditation Foundation (TAF code : 1190) and the FCC designation No. TW1022 under the FCC 2.948(e) by Mutual Recognition Agreement (MRA) in FCC Test.

Test Site	SPORTON INTERNATIONAL INC.			
Test Site Location	No. 52, Hwa Ya 1 st Rd., Hwa Ya Technology Park, Kwei-Shan Hsiang, Tao Yuan Hsien, Taiwan, R.O.C. TEL: +886-3-3273456 / FAX: +886-3-3284978			
Test Site No.	Sporton Site No.			IC Registration No.
	TH02-HY	CO05-HY	03CH07-HY	
Test Engineer	Danny Chen	Kai-Chun Chu	Eric Shih	4086B-1
Temperature	22~24°C	20~22°C	21~23°C	
Relative Humidity	53~55%	46~48%	47~49%	

1.6 Applicable Standards

According to the specifications of the manufacturer, the EUT must comply with the requirements of the following standards:

- FCC Part 15 Subpart C §15.225
- ANSI C63.4-2003

1.7 Test Modes

Investigation has been done on all the possible configurations for searching the worst cases. The following table is a list of the test modes shown in this test report.

Test Items	
AC Power Line Conducted Emissions	Field Strength of Fundamental Emissions
20dB Spectrum Bandwidth	Frequency Stability
Radiated Emissions 9kHz~30MHz	Radiated Emissions 30MHz~1GHz
Note:	
1. The EUT was programmed to be in continuously transmitting mode.	
2. The ancillary equipment, NFC card, is used to make the EUT (NFC) continuously transmit at 13.56MHz and is placed around 3 cm gap to the EUT.	

1.8 Test Configurations

<AC Conducted Emissions>

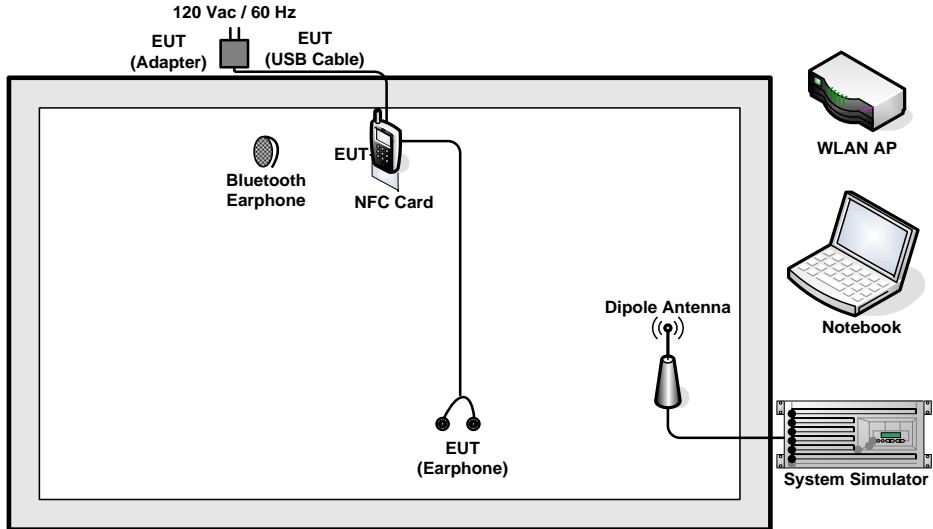

< For Fundamental Emissions and Mask and Radiated Emissions Measurement >

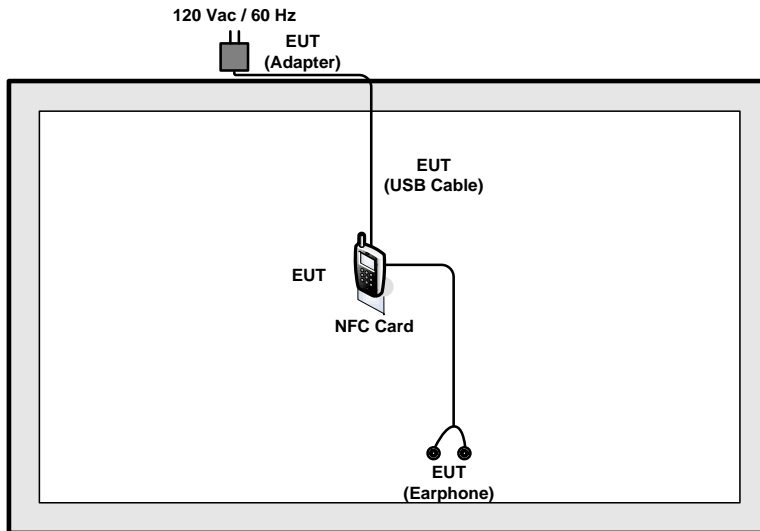



1.9 Table for Supporting Units

Support Unit	Manufacturer	Model	FCC ID
System Simulator	R&S	CMU 200	N/A
WLAN AP	D-Link	DIR-865L	KA2IR865LA1
Bluetooth Earphone	Sony Ericsson	MW600	PY70DA2029
NFC Card	Metro Taipei	Easy Card	N/A
SD Card	SanDisk	MicroSD HC	FCC DoC
Notebook	DELL	Latitude E6320	FCC DoC/ Contains FCC ID: QDS-BRCM1054

2. CONDUCTED EMISSION TEST

2.1 Measuring Instruments

See list of measuring instruments of this test report.

2.2 Test setup

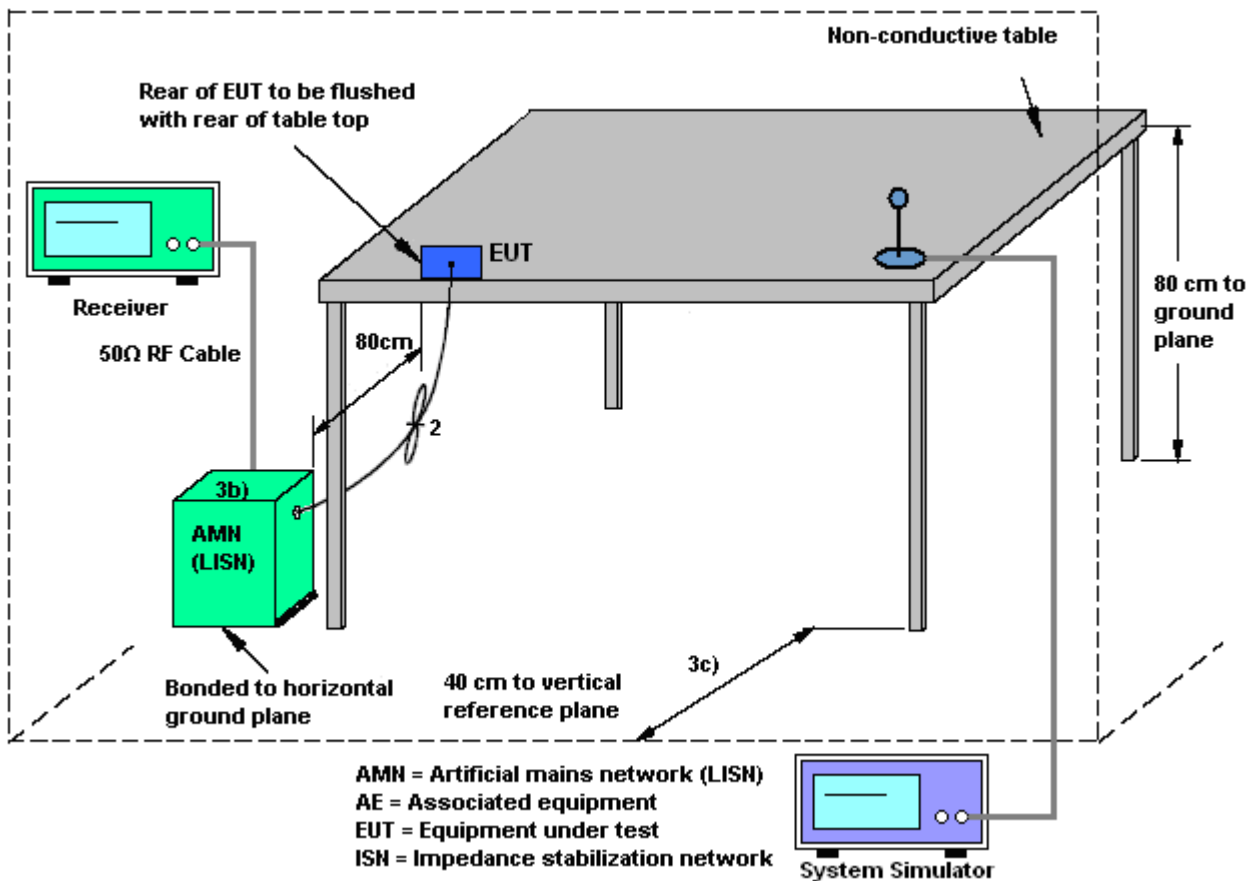

2.3 Test Result of Conducted Emission Test

Please refer to Appendix B.

2.4 AC Power Line Conducted Emissions Measurement

2.4.1 Limit

For equipment that is designed to be connected to the public utility (AC) power line, the radio frequency voltage that is conducted back onto the AC power line on any frequency or frequencies within the band 150 kHz to 30 MHz shall not exceed the limits in the following table.

Frequency of Emission (MHz)	Conducted Limit (dB μ V)	
	Quasi-Peak	Average
0.15-0.5	66 to 56*	56 to 46*
0.5-5	56	46
5-30	60	50

*Decreases with the logarithm of the frequency.

2.4.2 Test Procedures

1. The EUT was placed 0.4 meter from the conducting wall of the shielding room, and it was kept at least 80 centimeters from any other grounded conducting surface.
2. Connect EUT to the power mains through a line impedance stabilization network (LISN).
3. All the support units are connecting to the other LISN.
4. The LISN provides 50 ohm coupling impedance for the measuring instrument.
5. The FCC states that a 50 ohm, 50 microhenry LISN should be used.
6. Both sides of AC line were checked for maximum conducted interference.
7. The frequency range from 150 kHz to 30 MHz was searched.
8. Set the test-receiver system to Peak Detect Function and specified bandwidth (IF Bandwidth = 9kHz) with Maximum Hold Mode. Then measurement is also conducted by Average Detector and Quasi-Peak Detector Function respectively.

3. CONDUCTED TEST ITEMS

3.1 Measuring Instruments

See list of measuring instruments of this test report.

3.2 Test Setup

3.2.1 20dB Spectrum Bandwidth

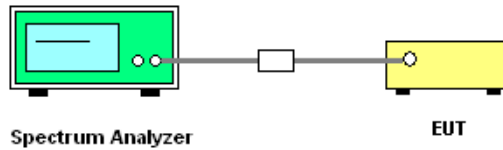

3.2.2 Frequency Stability

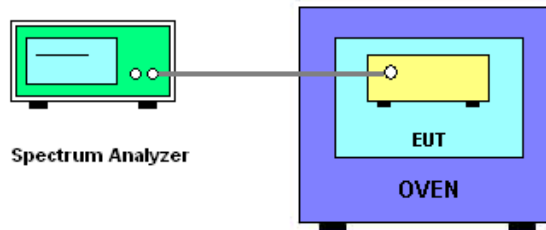

3.3 Test Result of Conducted Test Items

Please refer to Appendix C.



3.4 20dB Spectrum Bandwidth Measurement

3.4.1 Limit

Intentional radiators must be designed to ensure that the 20 dB bandwidth of the emissions in the specific band 13.553~13.567MHz

3.4.2 Test Procedures

1. The transmitter output (antenna port) was connected to the spectrum analyzer in peak Max hold mode.
2. The resolution bandwidth of 1 kHz and the video bandwidth of 3 kHz were used.
3. Measured the spectrum width with power higher than 20dB below carrier.

3.5 Frequency Stability Measurement

3.5.1 Limit

The frequency tolerance of the carrier signal shall be maintained within +/- 0.01% (100ppm) of the operating frequency over a temperature variation of -20 degrees to +50 degrees C at normal supply voltage, and for a variation in the primary supply voltage from 85% to 115% of the rated supply voltage at a temperature of 20 degrees C. For battery operated equipment, the equipment tests shall be performed using a new battery.

3.5.2 Test Procedures

1. The transmitter output (antenna port) was connected to the spectrum analyzer.
2. EUT have transmitted signal and fixed channelize.
3. Set the spectrum analyzer span to view the entire emissions bandwidth.
4. Set RBW = 1 kHz, VBW = 3 kHz with peak detector and maxhold settings.
5. The fc is declaring of channel frequency. Then the frequency error formula is $(f_c - f) / f_c \times 10^6$ ppm and the limit is less than ± 100 ppm.
6. Extreme temperature rule is -20°C~50°C.

4. RADIATED TEST ITEMS

4.1 Measuring Instruments

See list of measuring instruments of this test report.

4.2 Test Setup

4.2.1 For radiated emissions below 30MHz

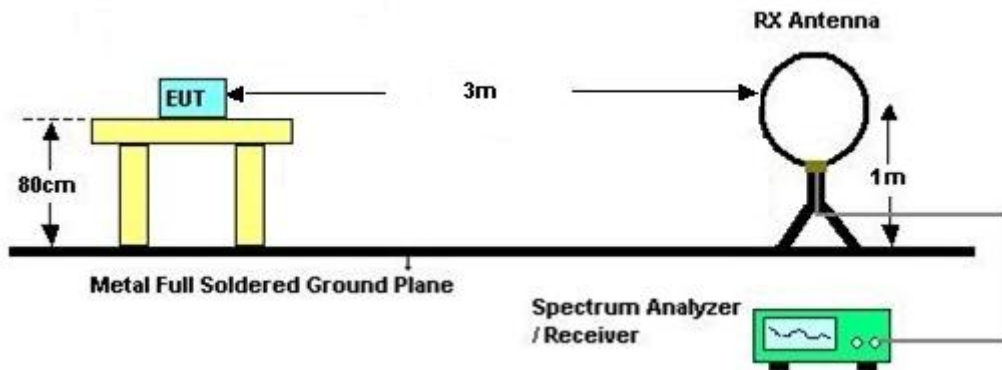

4.2.2 For radiated emissions above 30MHz

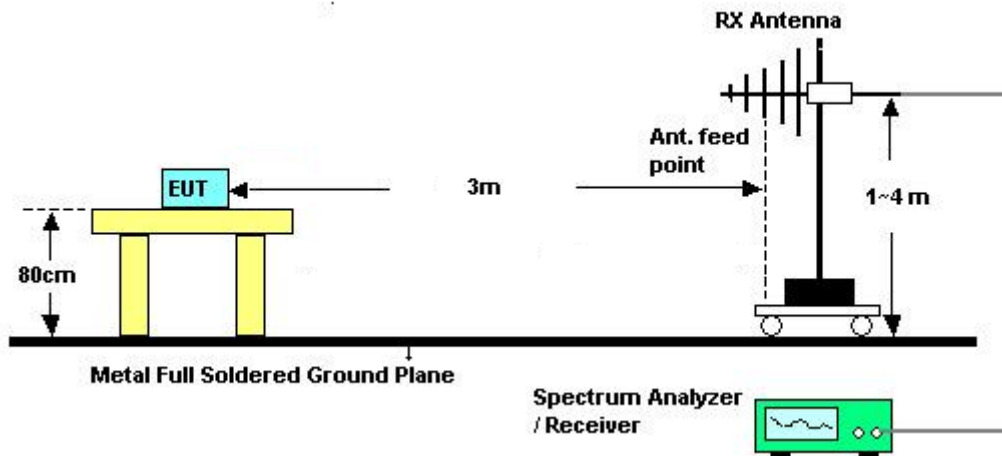

4.3 Test Result of Radiated Test Items

Please refer to Appendix D.

4.4 Field Strength of Fundamental Emissions and Mask Measurement

4.4.1 Limit

Rules and specifications	CFR 47 Part 15 section 15.225(a)-(d)			
Description	Compliance with the spectrum mask is tested using a spectrum analyzer with RBW set to a 9kHz for the band 13.553~13.567MHz			
Freq. of Emission (MHz)	Field Strength (μV/m) at 30m	Field Strength (dBμV/m) at 30m	Field Strength (dBμV/m) at 10m	Field Strength (dBμV/m) at 3m
1.705~13.110	30	29.5	48.58	69.5
13.110~13.410	106	40.5	59.58	80.5
13.410~13.553	334	50.5	69.58	90.5
13.553~13.567	15848	84.0	103.08	124.0
13.567~13.710	334	50.5	69.58	90.5
13.710~14.010	106	40.5	59.58	80.5
14.010~30.000	30	29.5	48.58	69.5

4.4.2 Test Procedures

1. Configure the EUT according to ANSI C63.4. The EUT was placed on the top of the turntable 0.8 meter above ground. The phase center of the loop receiving antenna mounted antenna tower was placed 3 meters far away from the turntable.
2. Power on the EUT and all the supporting units. The turntable was rotated by 360 degrees to determine the position of the highest radiation.
3. The height of the receiving antenna was fixed at one meter above ground to find the maximum emissions field strength.
4. For Fundamental emissions, use the receiver to measure QP reading.
5. When the radiated emissions limits are expressed in terms of the average value of the emissions, and pulsed operation is employed, the measurement field strength shall be determined by averaging over one complete pulse train, including blanking intervals, as long as the pulse train does not exceed 0.1 seconds. As an alternative (provided the transmitter operates for longer than 0.1 seconds) or in cases where the pulse train exceeds 0.1 seconds, the measured field strength shall be determined from the average absolute voltage during a 0.1 second interval during which the field strength is at its maximum value.
6. Compliance with the spectrum mask is tested using a spectrum analyzer with RBW set to a 9kHz for the band 13.553~13.567MHz.

Note: Emission level (dBμV/m) = 20 log Emission level (μV/m).



4.5 Radiated Emissions Measurement

4.5.1 Limit

The field strength of any emissions which appear outside of 13.553~13.567MHz band shall not exceed the general radiated emissions limits.

Frequencies (MHz)	Field Strength (µV/m)	Measurement Distance (meters)
0.009~0.490	2400/F(kHz)	300
0.490~1.705	24000/F(kHz)	30
1.705~30.0	30	30
30~88	100	3
88~216	150	3
216~960	200	3
Above 960	500	3

4.5.2 Measuring Instrument Setting

The following table is the setting of receiver.

Receiver Parameter	Setting
Attenuation	Auto
Frequency Range: 9kHz~150kHz	RBW 200Hz for QP
Frequency Range: 150kHz~30MHz	RBW 9kHz for QP
Frequency Range: 30MHz~1000MHz	RBW 120kHz for Peak

Note: The emission limits shown in the above table are based on measurements employing a CISPR quasi-peak detector except for the frequency bands 9-90 kHz, 110-490 kHz. Radiated emission limits in these two bands are based on measurements employing an average detector.



4.5.3 Test Procedures

1. Configure the EUT according to ANSI C63.4. The EUT was placed on the top of the turntable 0.8 meter above ground. The phase center of the receiving antenna mounted on the top of a height-variable antenna tower was placed 3 meters far away from the turntable.
2. Power on the EUT and all the supporting units. The turntable was rotated by 360 degrees to determine the position of the highest radiation.
3. The height of the broadband receiving antenna was varied between one meter and four meters above ground to find the maximum emissions field strength of both horizontal and vertical polarization.
4. For each suspected emissions, the antenna tower was scan (from 1 M to 4 M) and then the turntable was rotated (from 0 degree to 360 degrees) to find the maximum reading.
5. Set the test-receiver system to Peak or CISPR quasi-peak Detect Function with specified bandwidth under Maximum Hold Mode.
6. When the radiated emissions limits are expressed in terms of the average value of the emissions, and pulsed operation is employed, the measurement field strength shall be determined by averaging over one complete pulse train, including blanking intervals, as long as the pulse train does not exceed 0.1 seconds. As an alternative (provided the transmitter operates for longer than 0.1 seconds) or in cases where the pulse train exceeds 0.1 seconds, the measured field strength shall be determined from the average absolute voltage during a 0.1 second interval during which the field strength is at its maximum value.
7. In case the emission is lower than 30MHz, loop antenna has to be used for measurement and the recorded data should be QP measured by receiver. Antenna Requirements

4.5.4 Limit

Except for special regulations, the Low-power Radio-frequency Devices must not be equipped with any jacket for installing an antenna with extension cable. An intentional radiator shall be designed to ensure that no antenna other than that furnished by the responsible party shall be used with the device. The use of a permanently attached antenna or of an antenna that uses a unique coupling to the intentional radiator shall be considered sufficient to comply with the provisions of this Section. The manufacturer may design the unit so that the user can replace a broken antenna, but the use of a standard antenna jack or electrical connector is prohibited.

4.5.5 Antenna Anti-Replacement Construction

An embedded-in antenna design is used.



5. LIST OF MEASURING EQUIPMENT

Instrument	Manufacturer	Model No.	Serial No.	Characteristics	Calibration Date	Test Date	Due Date	Remark
Spectrum Analyzer	Rohde & Schwarz	FSP40	100055	9kHz~40GHz	Jun. 09, 2014	Aug. 27, 2014	Jun. 08, 2015	Conducted (TH02-HY)
Thermal Chamber	Ten Billion	TTH-D3SP	TBN-930701	N/A	Jul. 17, 2014	Aug. 27, 2014	Jul. 16, 2015	Conducted (TH02-HY)
EMI Test Receiver	Rohde & Schwarz	ESCS 30	100356	9kHz ~ 2.75GHz	Nov. 15, 2013	Aug. 21, 2014	Nov. 14, 2014	Conduction (CO05-HY)
LISN (for auxiliary equipment)	Rohde & Schwarz	ENV216	100081	9kHz ~ 30MHz	Dec. 12, 2013	Aug. 21, 2014	Dec. 11, 2014	Conduction (CO05-HY)
LISN	Rohde & Schwarz	ENV216	100080	9kHz ~ 30MHz	Dec. 04, 2013	Aug. 21, 2014	Dec. 03, 2014	Conduction (CO05-HY)
AC Power Source	ChainTek	APC-1000W	N/A	N/A	N/A	Aug. 21, 2014	N/A	Conduction (CO05-HY)
EMI Test Receiver	Rohde & Schwarz	ESCI 7	100724	9 kHz~7 GHz	Aug. 30, 2014	Sep. 10, 2014	Aug. 29, 2015	Radiation (03CH07-HY)
Loop Antenna	Rohde & Schwarz	HFH2-Z2	100315	9 kHz~30 MHz	Jul. 28, 2014	Sep. 10, 2014	Jul. 27, 2015	Radiation (03CH07-HY)
Bilog Antenna	Schaffner	CBL6111C	2726	30MHz ~ 1GHz	Oct. 10, 2013	Sep. 10, 2014	Oct. 09, 2014	Radiation (03CH07-HY)
Preamplifier	COM-POWER	PA-103A	161241	10 MHz ~ 1000MHz	Mar. 17, 2014	Sep. 10, 2014	Mar. 16, 2015	Radiation (03CH07-HY)
Turn Table	ChainTek	ChainTek 3000	N/A	0 ~ 360 degree	N/A	Sep. 10, 2014	N/A	Radiation (03CH07-HY)
Antenna Mast	ChainTek	ChainTek 3000	N/A	N/A	N/A	Sep. 10, 2014	N/A	Radiation (03CH07-HY)

Appendix A. Test Results of Conducted Emission Test

Test Mode :	NFC Tx	Test Voltage :	120Vac / 60Hz
Function Type :	GSM850 Idle + Bluetooth Link + WLAN (2.4GHz) Link + USB Cable 1 (Charging from Adapter 1) + NFC Tx + Earphone 1		

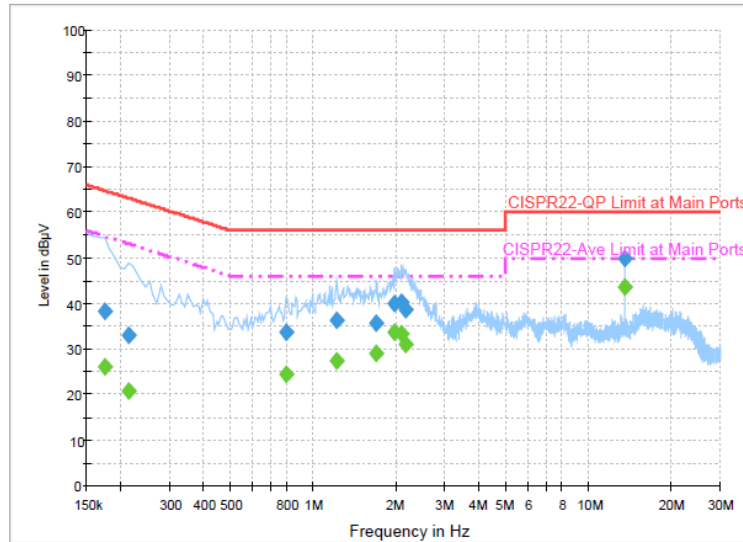

Final Result : Quasi-Peak

Frequency (MHz)	Quasi-Peak (dBµV)	Filter	Line	Corr. (dB)	Margin (dB)	Limit (dBµV)
0.174000	38.2	Off	L1	19.3	26.6	64.8
0.214000	32.8	Off	L1	19.4	30.2	63.0
0.798000	33.7	Off	L1	19.5	22.3	56.0
1.214000	36.3	Off	L1	19.5	19.7	56.0
1.694000	35.8	Off	L1	19.6	20.2	56.0
1.974000	39.9	Off	L1	19.5	16.1	56.0
2.086000	40.1	Off	L1	19.5	15.9	56.0
2.166000	38.7	Off	L1	19.5	17.3	56.0
13.558000	49.7	Off	L1	19.8	10.3	60.0

Final Result : Average

Frequency (MHz)	Average (dBµV)	Filter	Line	Corr. (dB)	Margin (dB)	Limit (dBµV)
0.174000	26.0	Off	L1	19.3	28.8	54.8
0.214000	20.9	Off	L1	19.4	32.1	53.0
0.798000	24.3	Off	L1	19.5	21.7	46.0
1.214000	27.5	Off	L1	19.5	18.5	46.0
1.694000	29.2	Off	L1	19.6	16.8	46.0
1.974000	33.7	Off	L1	19.5	12.3	46.0
2.086000	33.3	Off	L1	19.5	12.7	46.0
2.166000	31.2	Off	L1	19.5	14.8	46.0
13.558000	43.7	Off	L1	19.8	6.3	50.0



Test Mode :	NFC Tx	Test Voltage :	120Vac / 60Hz
Function Type :	GSM850 Idle + Bluetooth Link + WLAN (2.4GHz) Link + USB Cable 1 (Charging from Adapter 1) + NFC Tx + Earphone 1		

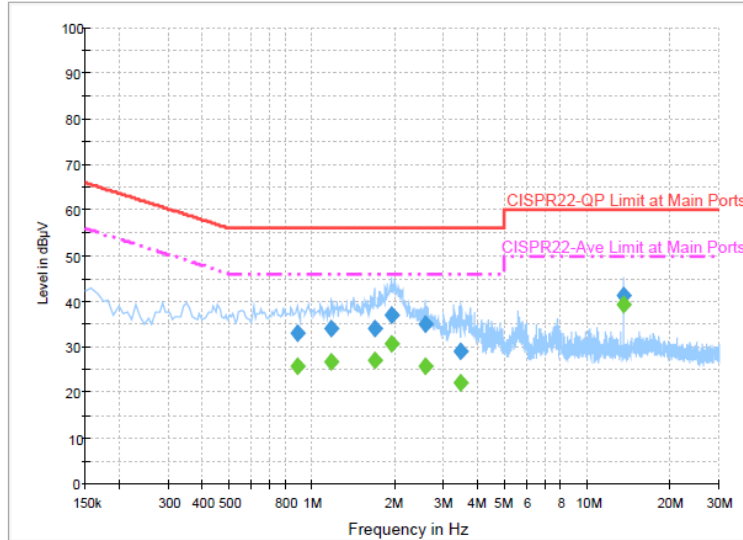

Final Result : Quasi-Peak

Frequency (MHz)	Quasi-Peak (dBµV)	Filter	Line	Corr. (dB)	Margin (dB)	Limit (dBµV)
0.886000	33.1	Off	N	19.5	22.9	56.0
1.174000	33.9	Off	N	19.5	22.1	56.0
1.678000	33.8	Off	N	19.6	22.2	56.0
1.934000	36.9	Off	N	19.5	19.1	56.0
2.566000	34.8	Off	N	19.5	21.2	56.0
3.470000	29.2	Off	N	19.6	26.8	56.0
13.558000	41.2	Off	N	19.8	18.8	60.0

Final Result : Average

Frequency (MHz)	Average (dBµV)	Filter	Line	Corr. (dB)	Margin (dB)	Limit (dBµV)
0.886000	25.6	Off	N	19.5	20.4	46.0
1.174000	26.8	Off	N	19.5	19.2	46.0
1.678000	27.2	Off	N	19.6	18.8	46.0
1.934000	30.8	Off	N	19.5	15.2	46.0
2.566000	25.7	Off	N	19.5	20.3	46.0
3.470000	22.0	Off	N	19.6	24.0	46.0
13.558000	39.3	Off	N	19.8	10.7	50.0



Appendix B. Test Results of Conducted Test Items

B.1 Test Result of 20dB Spectrum Bandwidth

Test mode	NFC Tx	Test Frequency (MHz)	13.56
Date: 27.AUG.2014 21:24:17		Date: 27.AUG.2014 21:35:39	
20dB Bandwidth (kHz)	2.640	99% OccupiedBW(kHz)	2.240
Frequency range (MHz)	$f_L > 13.553$	13.55858	Test Result
	$f_H < 13.567$	13.56122	Complies



B.2 Test Result of Frequency Stability

Voltage vs. Frequency Stability		Temperature vs. Frequency Stability	
Voltage (Vac)	Measurement Frequency (MHz)	Temperature (°C)	Measurement Frequency (MHz)
3.8	13.559900	-20	13.559960
3.6	13.559900	-10	13.559960
4.2	13.559900	0	13.559960
		10	13.559960
		20	13.559940
		30	13.559900
		40	13.559880
		50	13.559860
Max.Deviation (MHz)	-0.000100	Max.Deviation (MHz)	-0.000140
Max.Deviation (ppm)	-7.3746	Max.Deviation (ppm)	-10.3245
Limit	FS < ±100 ppm	Limit	FS < ±100 ppm
Test Result	PASS	Test Result	PASS



Appendix C. Test Results of Radiated Test Items

C.1 Test Result of Field Strength of Fundamental Emissions

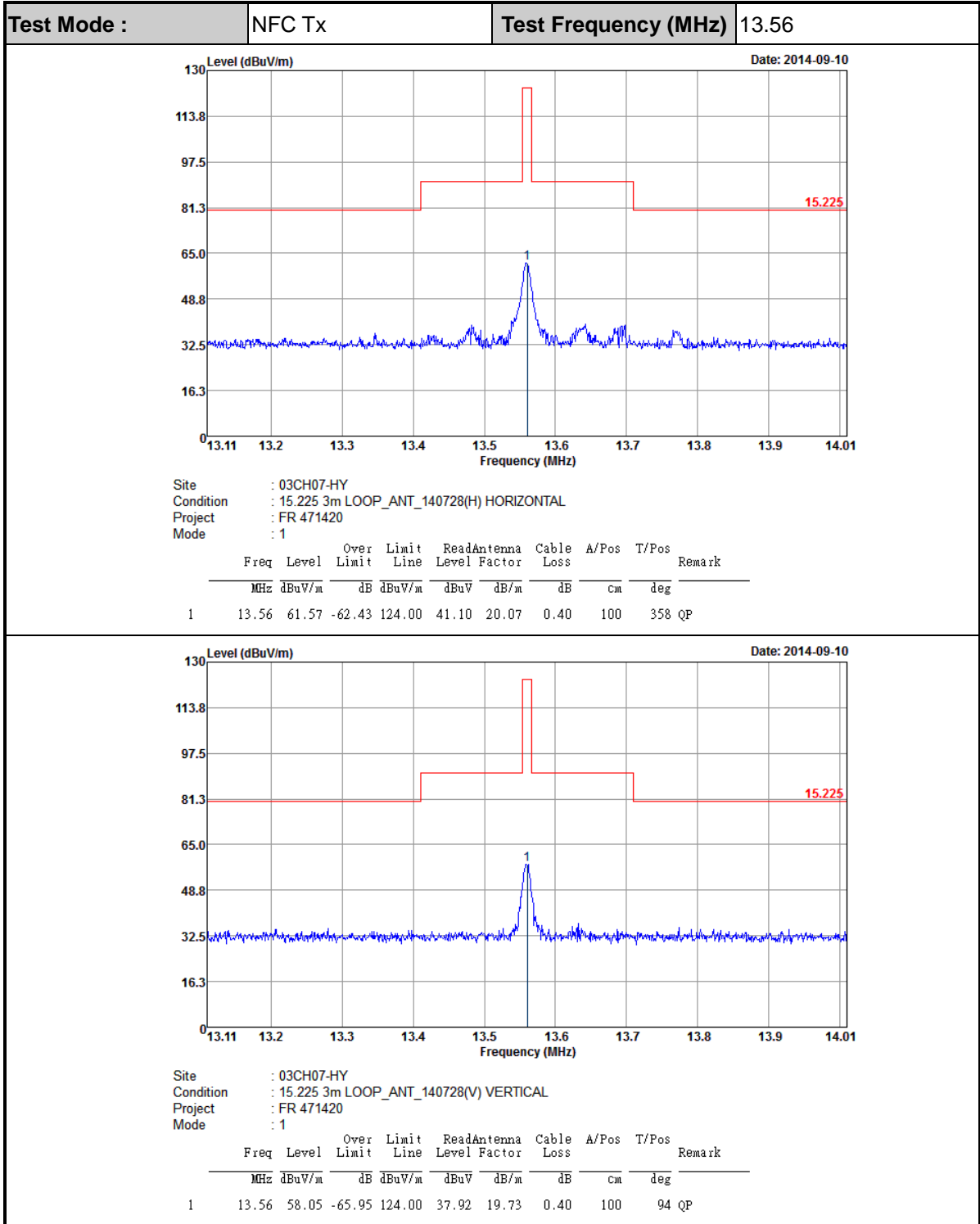

Note: All NFC's spurious emissions are below 20dB of limits.



C.2 Results of Radiated Emissions (9 kHz~30MHz)

Test Mode :		NFC Tx			Polarization :		Horizontal		
Frequency (MHz)	Level (dB μ V/m)	Over Limit (dB)	Limit Line (dB μ V/m)	Read Level (dB μ V)	Antenna Factor (dB)	Cable Loss (dB)	Ant Pos (cm)	Table Pos (deg)	Remark
0.01369	36.92	-87.96	124.88	16.39	20.24	0.29	-	-	Average
0.06828	24.78	-86.14	110.92	4.48	20.01	0.29	-	-	Average
0.0967	23.37	-84.53	107.9	3.12	19.96	0.29	-	-	QP
0.14892	21.58	-82.57	104.15	1.37	19.92	0.29	-	-	Average
0.4203	43.97	-51.16	95.13	23.8	19.88	0.29	-	-	Average
1.211	40.54	-25.4	65.94	20.33	19.9	0.31	100	293	QP
10.96	35.68	-34.32	70	15.24	20.05	0.39	-	-	QP
13.56	59.73	-	-	39.26	20.07	0.4	-	-	QP
20.194	37.12	-32.88	70	16.24	20.45	0.43	-	-	QP
27.985	36.39	-33.61	70	15.23	20.66	0.5	-	-	QP



Test Mode :	NFC Tx			Polarization :	Vertical				
Frequency (MHz)	Level (dBμV/m)	Over Limit (dB)	Limit Line (dBμV/m)	Read Level (dBμV)	Antenna Factor (dB)	Cable Loss (dB)	Ant Pos (cm)	Table Pos (deg)	Remark
0.01798	35.11	-87.4	122.51	14.56	20.26	0.29	-	-	Average
0.06819	23.54	-87.39	110.93	3.22	20.03	0.29	-	-	Average
0.09666	23.34	-84.56	107.9	3.06	19.99	0.29	-	-	QP
0.12908	22.2	-83.19	105.39	1.95	19.96	0.29	-	-	Average
0.4186	45.07	-50.1	95.17	24.88	19.9	0.29	-	-	Average
1.309	41.13	-24.14	65.27	20.9	19.92	0.31	100	47	QP
13.56	54.55	-	-	34.42	19.73	0.4	-	-	QP
15.056	34.7	-35.3	70	14.62	19.67	0.41	-	-	QP
24.001	34.6	-35.4	70	14.09	20.06	0.45	-	-	QP
29.275	35.21	-34.79	70	14.79	19.91	0.51	-	-	QP

Note:

1. 13.56 MHz is fundamental signal which can be ignored.
2. The amplitude of spurious emissions which are attenuated by more than 20dB below the permissible value has no need to be reported.
3. Distance extrapolation factor = $40 \log (\text{specific distance} / \text{test distance})$ (dB);
4. Limit line = specific limits (dBμV) + distance extrapolation factor.



C.3 Results of Radiated Emissions (30MHz~1GHz)

Test Mode :	NFC Tx	Polarization :	Horizontal
-------------	--------	----------------	------------

Frequency (MHz)	Level (dBμV/m)	Over Limit (dB)	Limit Line (dBμV/m)	Read Level (dBμV)	Antenna Factor (dB)	Cable Loss (dB)	Preamp Factor (dB)	Ant Pos (cm)	Table Pos (deg)	Remark
111.54	25.17	-18.33	43.5	44.38	10.91	1.06	31.18	-	-	Peak
214.41	23.2	-20.3	43.5	43.64	9.24	1.38	31.06	-	-	Peak
297.84	30.88	-15.12	46	46.97	13.18	1.75	31.02	-	-	Peak
309.8	32.16	-13.84	46	48.08	13.29	1.79	31	114	96	Peak
550.6	21.54	-24.46	46	29.97	19.82	2.55	30.8	-	-	Peak
845.3	27.55	-18.45	46	31.42	23.26	3.26	30.39	-	-	Peak

Test Mode :	NFC Tx	Polarization :	Vertical
-------------	--------	----------------	----------

Frequency (MHz)	Level (dBμV/m)	Over Limit (dB)	Limit Line (dBμV/m)	Read Level (dBμV)	Antenna Factor (dB)	Cable Loss (dB)	Preamp Factor (dB)	Ant Pos (cm)	Table Pos (deg)	Remark
41.61	33.12	-6.88	40	51.09	12.6	0.63	31.2	139	23	Peak
106.95	19.5	-24	43.5	39.02	10.62	1.03	31.17	-	-	Peak
297.84	25.81	-20.19	46	41.9	13.18	1.75	31.02	-	-	Peak
309.8	28.03	-17.97	46	43.95	13.29	1.79	31	-	-	Peak
476.4	19.36	-26.64	46	30.23	17.56	2.37	30.8	-	-	Peak
843.2	25.9	-20.1	46	29.81	23.23	3.25	30.39	-	-	Peak

Note:

1. The amplitude of spurious emissions which are attenuated by more than 20dB below the permissible value has no need to be reported.
2. Emission level (dBμV/m) = 20 log Emission level (μV/m).
3. Corrected Reading: Antenna Factor + Cable Loss + Read Level - Preamp Factor= Level.