



FCC RF Test Report

APPLICANT : BlackBerry Limited
EQUIPMENT : Smartphone
BRAND NAME : BlackBerry
MODEL NAME : RHF141LW
MARKETING NAME : SQC100-3
FCC ID : L6ARHF140LW
STANDARD : FCC 47 CFR Part 2, 22(H), 24(E)
CLASSIFICATION : PCS Licensed Transmitter Held to Ear (PCE)

The product was received on Jul. 15, 2014 and testing was completed on Nov. 05, 2014. We, SPORTON INTERNATIONAL INC., would like to declare that the tested sample has been evaluated in accordance with the test procedures given in ANSI / TIA / EIA-603-C-2004 and has been in compliance with the applicable technical standards.

The test results in this report apply exclusively to the tested model / sample. Without written approval of SPORTON INTERNATIONAL INC., the test report shall not be reproduced except in full.

Reviewed by: Joseph Lin / Supervisor

Approved by: Jones Tsai / Manager



SPORTON INTERNATIONAL INC.

No. 52, Hwa Ya 1st Rd., Hwa Ya Technology Park, Kwei-Shan Hsiang, Tao Yuan Hsien, Taiwan, R.O.C.



TABLE OF CONTENTS

REVISION HISTORY.....3

SUMMARY OF TEST RESULT4

1 GENERAL DESCRIPTION.....5

1.1 Applicant.....5

1.2 Manufacturer5

1.3 Product Feature of Equipment Under Test5

1.4 Product Specification subjective to this standard.....6

1.5 Modification of EUT6

1.6 Maximum ERP/EIRP Power, Frequency Tolerance, and Emission Designator7

1.7 Testing Location7

1.8 Applicable Standards8

2 TEST CONFIGURATION OF EQUIPMENT UNDER TEST.....9

2.1 Test Mode.....9

2.2 Connection Diagram of Test System12

2.3 Support Unit used in test configuration13

2.4 Measurement Results Explanation Example13

3 TEST RESULT.....14

3.1 Conducted Output Power Measurement.....14

3.2 Peak-to-Average Ratio16

3.3 Effective Radiated Power and Effective Isotropic Radiated Power Measurement34

3.4 99% Occupied Bandwidth and 26dB Bandwidth Measurement.....40

3.5 Band Edge Measurement.....67

3.6 Conducted Spurious Emission Measurement.....76

3.7 Field Strength of Spurious Radiation Measurement137

3.8 Frequency Stability Measurement.....169

4 LIST OF MEASURING EQUIPMENT.....175

5 UNCERTAINTY OF EVALUATION.....176

APPENDIX A. SETUP PHOTOGRAPHS



SUMMARY OF TEST RESULT

Report Section	FCC Rule	IC Rule	Description	Limit	Result	Remark
3.1	§2.1046	RSS-132 (5.4) RSS-133 (6.4)	Conducted Output Power	N/A	PASS	-
3.2	§24.232(d)	RSS-132 (5.4) RSS-133(6.4)	Peak-to-Average Ratio	<13 dB	PASS	-
3.3	§22.913(a)(2)	RSS-132(5.4) SRSP-503(5.1.3)	Effective Radiated Power	< 7 Watts	PASS	-
	§24.232(c)	RSS-133 (6.4) SRSP-510(5.1.2)	Equivalent Isotropic Radiated Power	< 2 Watts	PASS	-
3.4	§2.1049 §22.917(b) §24.238(b)	RSS-GEN(4.6.1) RSS-133(2.3)	Occupied Bandwidth	N/A	PASS	-
3.5	§2.1051 §22.917(a) §24.238(a)	RSS-132 (5.5) RSS-133 (6.5)	Band Edge Measurement	< 43+10log ₁₀ (P[Watts])	PASS	-
3.6	§2.1051 §22.917(a) §24.238(a)	RSS-132 (5.5) RSS-133 (6.5)	Conducted Spurious Emission	< 43+10log ₁₀ (P[Watts])	PASS	-
3.7	§2.1053 §22.917(a) §24.238(a)	RSS-132 (5.5) RSS-133 (6.5)	Field Strength of Spurious Radiation	< 43+10log ₁₀ (P[Watts])	PASS	Under limit 15.71 dB at 7639.200 MHz
3.8	§2.1055 §22.355	RSS-132(5.3)	Frequency Stability for Temperature & Voltage	< 2.5 ppm for Part 22 Within Authorized Band	PASS	-
	§2.1055 §24.235	RSS-133(6.3)				



1 General Description

1.1 Applicant

BlackBerry Limited
2300 University Street East, Waterloo, ON., CAN, N2K1A0

1.2 Manufacturer

FIH Mobile Limited
No. 4, Mingsheng St., Tu-Cheng Dist., New Taipei City 23679, Taiwan

1.3 Product Feature of Equipment Under Test

Product Feature	
Equipment	Smartphone
Brand Name	BlackBerry
Model Name	RHF141LW
Marketing Name	SQC100-3
FCC ID	L6ARHF140LW
EUT supports Radios application	CDMA/EV-DO/GSM/EGPRS/WCDMA/HSPA/LTE/NFC WLAN 11b/g/n HT20 WLAN 11a/n HT20/HT40 Bluetooth v4.0 EDR/LE
HW Version	PVT 2
SW Version	BlackBerry 10.3.1.565/566
EUT Stage	Identical Prototype

Remark: The above EUT's information was declared by manufacturer. Please refer to the specifications or user's manual for more detailed description.



1.4 Product Specification subjective to this standard

Product Specification subjective to this standard	
Tx Frequency	GSM850: 824.2 MHz ~ 848.8 MHz GSM1900: 1850.2 MHz ~ 1909.8MHz WCDMA Band V: 826.4 MHz ~ 846.6 MHz WCDMA Band II: 1852.4 MHz ~ 1907.6 MHz CDMA2000 BC0: 824.70 MHz ~ 848.31 MHz CDMA2000 BC1: 1851.25 MHz ~ 1908.75 MHz
Rx Frequency	GSM850: 869.2 MHz ~ 893.8 MHz GSM1900: 1930.2 MHz ~ 1989.8 MHz WCDMA Band V: 871.4 MHz ~ 891.6 MHz WCDMA Band II: 1932.4 MHz ~ 1987.6 MHz CDMA2000 BC0: 869.70 MHz ~ 893.31 MHz CDMA2000 BC1: 1931.25 MHz ~ 1988.75 MHz
Maximum Output Power to Antenna	GSM850 : 32.72 dBm GSM1900 : 29.74 dBm WCDMA Band V : 23.22 dBm WCDMA Band II : 23.71 dBm CDMA2000 BC0 : 23.60 dBm CDMA2000 BC1 : 24.25 dBm
Antenna Type	Coupling type (LDS) Antenna
Type of Modulation	GSM: GMSK GPRS: GMSK EDGE: GMSK / 8PSK WCDMA: QPSK (Uplink) HSDPA: 64QAM (Downlink) HSUPA: QPSK (Uplink) CDMA2000 : QPSK CDMA2000 1xEV-DO : QPSK/8PSK

1.5 Modification of EUT

No modifications are made to the EUT during all test items.



1.6 Maximum ERP/EIRP Power, Frequency Tolerance, and Emission Designator

FCC Rule	System	Type of Modulation	Maximum ERP/EIRP (W)	Frequency Tolerance (ppm)	Emission Designator
Part 22	GSM850 GPRS class 8	GMSK	0.7194	0.0143 ppm	246KGXW
Part 22	GSM850 EDGE class 8	8PSK	0.1486	0.0084 ppm	246KG7W
Part 22	WCDMA Band V RMC 12.2Kbps	QPSK	0.0918	0.0143 ppm	4M20F9W
Part 22	CDMA2000 BC0 1xRTT	QPSK	0.0780	0.0311 ppm	1M28F9W
Part 24	GSM1900 GPRS class 8	GMSK	0.9226	0.0207 ppm	248KGXW
Part 24	GSM1900 EDGE class 8	8PSK	0.3097	0.0213 ppm	248KG7W
Part 24	WCDMA Band II RMC 12.2Kbps	QPSK	0.2112	0.0032 ppm	4M20F9W
Part 24	CDMA2000 BC1 1xRTT	QPSK	0.1950	0.0021 ppm	1M28F9W

1.7 Testing Location

Sporton Lab is accredited to ISO 17025 by Taiwan Accreditation Foundation (TAF code : 1190) and the FCC designation No. TW1022 under the FCC 2.948(e) by Mutual Recognition Agreement (MRA) in FCC Test.

Test Site	SPORTON INTERNATIONAL INC.	
Test Site Location	No. 52, Hwa Ya 1 st Rd., Hwa Ya Technology Park, Kwei-Shan Hsiang, Tao Yuan Hsien, Taiwan, R.O.C. TEL: +886-3-327-3456 FAX: +886-3-328-4978	
Test Site No.	Sporton Site No.	
	TH02-HY	03CH07-HY



1.8 Applicable Standards

According to the specifications of the manufacturer, the EUT must comply with the requirements of the following standards:

- ♦ FCC 47 CFR Part 2, 22(H), 24(E)
- ♦ ANSI / TIA / EIA-603-C-2004
- ♦ FCC KDB 971168 D01 Power Meas. License Digital Systems v02r02

Remark:

1. All test items were verified and recorded according to the standards and without any deviation during the test.
2. This EUT has also been tested and complied with the requirements of FCC Part 15, Subpart B, recorded in a separate test report.



2 Test Configuration of Equipment Under Test

2.1 Test Mode

Antenna port conducted and radiated test items were performed according to KDB 971168 D01 Power Meas. License Digital Systems v02r02 with maximum output power.

Radiated measurements were performed with rotating EUT in different three orthogonal test planes to find the maximum emission.

Radiated emissions were investigated as following frequency range:

1. 30 MHz to 9000 MHz for GSM850, WCDMA Band V, and CDMA2000 BC0.
2. 30 MHz to 19000 MHz for GSM1900, WCDMA Band II, and CDMA2000 BC1.

All modes and data rates and positions were investigated.

Test modes are chosen to be reported as the worst case configuration below:

Test Modes		
Band	Radiated TCs	Conducted TCs
GSM 850	<ul style="list-style-type: none"> ■ GPRS class 8 Link + USB Cable 1 (Charging from Adapter 1) + Earphone 1 ■ EDGE class 8 Link + USB Cable 1 (Charging from Adapter 1) + Earphone 1 	<ul style="list-style-type: none"> ■ GPRS class 8 Link ■ EDGE class 8 Link
GSM 1900	<ul style="list-style-type: none"> ■ GPRS class 8 Link + USB Cable 1 (Charging from Adapter 1) + Earphone 1 ■ GPRS class 8 Link + PMA Charger + Earphone 1 ■ GPRS class 8 Link + WPC Charger + Earphone 1 ■ EDGE class 8 Link + USB Cable 1 (Charging from Adapter 1) + Earphone 1 	<ul style="list-style-type: none"> ■ GPRS class 8 Link ■ EDGE class 8 Link
WCDMA Band V	<ul style="list-style-type: none"> ■ RMC 12.2Kbps Link + USB Cable 1 (Charging from Adapter 1) + Earphone 1 	<ul style="list-style-type: none"> ■ RMC 12.2Kbps Link
WCDMA Band II	<ul style="list-style-type: none"> ■ RMC 12.2Kbps Link + USB Cable 1 (Charging from Adapter 1) + Earphone 1 	<ul style="list-style-type: none"> ■ RMC 12.2Kbps Link
CDMA2000 BC0	<ul style="list-style-type: none"> ■ 1xRTT Link + USB Cable 1 (Charging from Adapter 1) + Earphone 1 	<ul style="list-style-type: none"> ■ 1xRTT Link Mode
CDMA2000 BC1	<ul style="list-style-type: none"> ■ 1xRTT Link + USB Cable 1 (Charging from Adapter 1) + Earphone 1 	<ul style="list-style-type: none"> ■ 1xRTT Link Mode

Note: The maximum power levels are chosen to test as the worst case configuration as follows:

- GPRS multi-slot class 8 mode for GMSK modulation,
- EDGE multi-slot class 8 mode for 8PSK modulation,
- RMC 12.2Kbps mode for WCDMA band V and WCDMA band II,



1xRTT RC3 SO32 (+F-SCH) mode for CDMA2000 BC0 and CDMA2000 BC1,
only these modes were used for all tests.



Conducted Power Measurement Results:

Conducted Power (*Unit: dBm)						
Band	GSM850			GSM1900		
Channel	128	189	251	512	661	810
Frequency	824.2	836.4	848.8	1850.2	1880.0	1909.8
GSM	32.70	32.66	32.48	29.65	29.48	29.72
GPRS class 8	32.72	32.67	32.50	29.68	29.51	29.74
GPRS class 10	29.35	29.30	29.22	28.59	28.47	28.62
GPRS class 11	28.57	28.47	28.39	25.94	25.88	26.00
GPRS class 12	26.44	26.39	26.33	25.45	25.39	25.49
EGPRS class 8	25.75	25.72	25.66	25.38	25.33	25.41
EGPRS class 10	25.70	25.69	25.64	24.89	24.83	24.92
EGPRS class 11	24.09	24.07	24.05	23.92	23.85	23.98
EGPRS class 12	23.19	23.16	23.14	22.94	22.90	23.05

Conducted Power (*Unit: dBm)						
Band	WCDMA Band V			WCDMA Band II		
Channel	4132	4182	4233	9262	9400	9538
Frequency	826.4	836.4	846.6	1852.4	1880.0	1907.6
RMC 12.2K	23.21	23.22	23.15	23.71	23.65	23.43
HSDPA Subtest-1	22.24	22.13	22.12	22.66	22.49	22.40
HSDPA Subtest-2	22.23	22.10	22.03	22.60	22.47	22.39
HSDPA Subtest-3	21.74	21.61	21.55	22.14	21.99	21.89
HSDPA Subtest-4	21.60	21.61	21.54	22.13	22.02	21.89
HSUPA Subtest-1	22.10	22.05	22.01	22.03	22.14	22.08
HSUPA Subtest-2	21.15	21.04	21.06	21.46	21.52	21.31
HSUPA Subtest-3	21.11	21.01	21.03	21.29	21.11	21.05
HSUPA Subtest-4	21.62	21.00	21.01	21.86	21.52	21.31
HSUPA Subtest-5	22.30	22.20	22.02	22.70	22.80	22.40

Conducted Power (*Unit: dBm)						
Band	CDMA2000 BC0			CDMA2000 BC1		
Channel	1013	384	777	25	600	1175
Frequency	824.7	836.52	848.31	1851.25	1880	1908.75
1xRTT RC1 SO55	23.20	23.43	23.49	24.14	23.95	23.76
1xRTT RC3 SO55	23.33	23.58	23.59	24.22	24.05	23.84
1xRTT RC3 SO32(+ F-SCH)	23.28	23.56	23.60	24.25	24.04	23.80
1xRTT RC3 SO32(+SCH)	23.22	23.42	23.46	24.13	23.93	23.69
1xEV-DO RTAP 153.6kbps	23.26	23.53	23.58	24.20	24.04	23.81
1xEV-DO RETAP 4096Bits	23.25	23.52	23.56	24.18	24.03	23.79

2.2 Connection Diagram of Test System

<EUT with Adapter Mode>

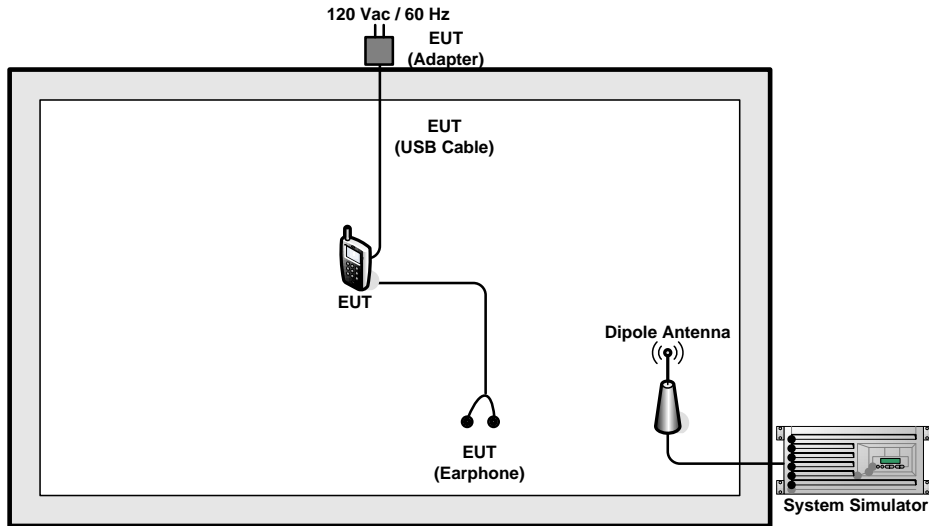

<EUT with WPC Charger>

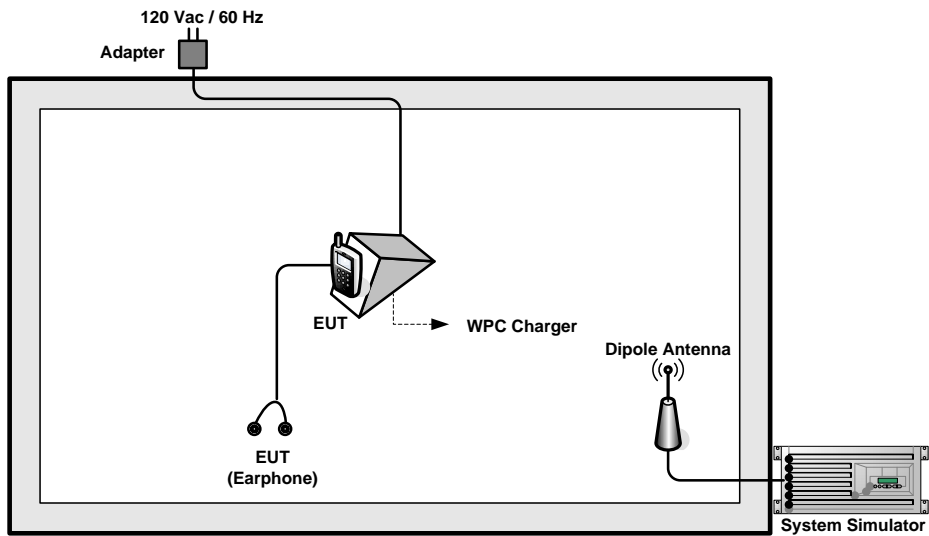

<EUT with PMA Charger>

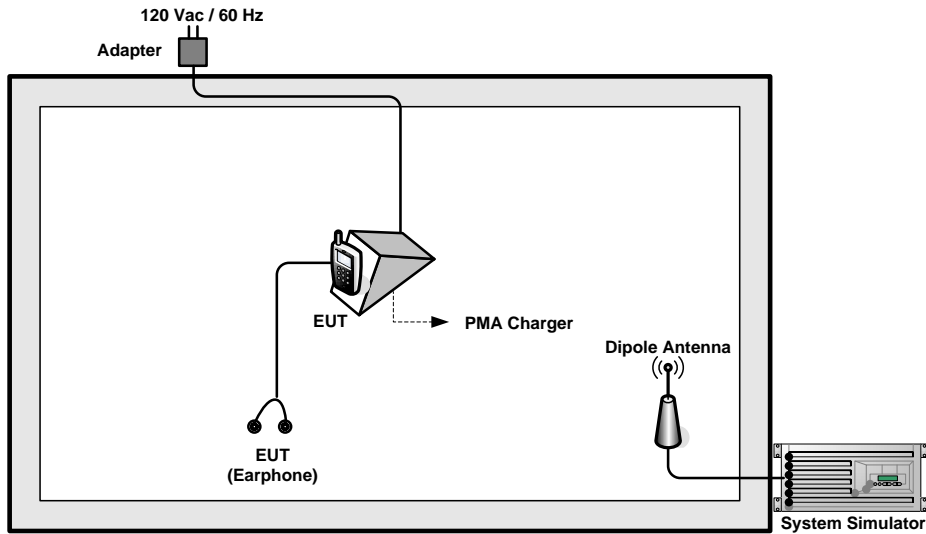

2.3 Support Unit used in test configuration

Item	Equipment	Trade Name	Model No.	FCC ID	Data Cable	Power Cord
1.	System Simulator	R&S	CMU 200	N/A	N/A	Unshielded, 1.8 m
2.	WPC Charger	LG	WPC-700	BEJWCP700	N/A	Unshielded, 1.5 m
3.	PMA Charger	DURACELL	POWERMAT	FCC DOC	N/A	Unshielded, 1.5 m

2.4 Measurement Results Explanation Example

For all conducted test items:

The offset level is set in the spectrum analyzer to compensate the RF cable loss and attenuator factor between RF conducted output port and spectrum analyzer. With the offset compensation, the spectrum analyzer reading level will be exactly the RF output level.

The spectrum analyzer offset is derived from RF cable loss and attenuator factor.

Offset = RF cable loss + attenuator factor.

The following shows an offset computation example with RF cable loss 4.2 dB and a 10dB attenuator.

Example :

$$\begin{aligned} \text{Offset(dB)} &= \text{RF cable loss(dB)} + \text{attenuator factor(dB)}. \\ &= 4.2 + 10 = 14.2 \text{ (dB)} \end{aligned}$$

3 Test Result

3.1 Conducted Output Power Measurement

3.1.1 Description of the Conducted Output Power Measurement

A system simulator was used to establish communication with the EUT. Its parameters were set to enforce EUT transmitting at the maximum power. The measured power in the radio frequency on the transmitter output terminals shall be reported.

3.1.2 Measuring Instruments

The measuring equipment is listed in the section 4 of this test report.

3.1.3 Test Procedures

1. The transmitter output port was connected to the system simulator.
2. Set EUT at maximum power through system simulator.
3. Select lowest, middle, and highest channels for each band and different modulation.
4. Measure the maximum burst average power for GSM and maximum average power for other modulation signal.

3.1.4 Test Setup

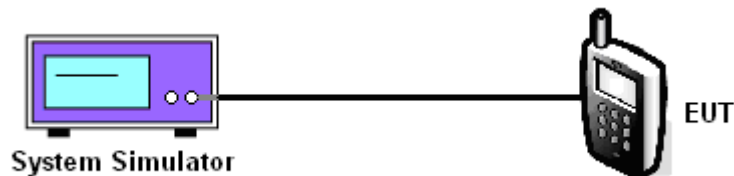



3.1.5 Test Result of Conducted Output Power

Cellular Band									
Modes	GSM850 (GPRS class 8)			GSM850 (EDGE class 8)			WCDMA Band V (RMC 12.2Kbps)		
Channel	128 (Low)	189 (Mid)	251 (High)	128 (Low)	189 (Mid)	251 (High)	4132 (Low)	4182 (Mid)	4233 (High)
Frequency (MHz)	824.2	836.4	848.8	824.2	836.4	848.8	826.4	836.4	846.6
Conducted Power (dBm)	32.72	32.67	32.50	25.75	25.72	25.66	23.21	23.22	23.15

PCS Band									
Modes	GSM1900 (GPRS class 8)			GSM1900 (EDGE class 8)			WCDMA Band II (RMC 12.2Kbps)		
Channel	512 (Low)	661 (Mid)	810 (High)	512 (Low)	661 (Mid)	810 (High)	9262 (Low)	9400 (Mid)	9538 (High)
Frequency (MHz)	1850.2	1880	1909.8	1850.2	1880	1909.8	1852.4	1880	1907.6
Conducted Power (dBm)	29.68	29.51	29.74	25.38	25.33	25.41	23.71	23.65	23.43

CDMA2000 BC0			
Test Mode	CDMA 2000 1xRTT		
Test Status	RC3+SO32		
Channel	1013 (Low)	384 (Mid)	777 (High)
Frequency (MHz)	824.70	836.52	848.31
Conducted Power (dBm)	23.28	23.56	23.60

CDMA2000 BC1			
Test Mode	CDMA 2000 1xRTT		
Test Status	RC3+SO32		
Channel	25 (Low)	600 (Mid)	1175 (High)
Frequency (MHz)	1851.25	1880.00	1908.75
Conducted Power (dBm)	24.25	24.04	23.80

Note: maximum burst average power for GSM, and maximum average power for WCDMA and CDMA2000.

3.2 Peak-to-Average Ratio

3.2.1 Description of the PAR Measurement

The peak-to-average ratio (PAR) of the transmission may not exceed 13 dB.

3.2.2 Measuring Instruments

The measuring equipment is listed in the section 4 of this test report.

3.2.3 Test Procedures

1. The EUT was connected to spectrum analyzer and system simulator via a power divider.
2. Set EUT to transmit at maximum output power.
3. When the duty cycle is less than 98%, then signal gating will be implemented on the spectrum analyzer by triggering from the system simulator.
4. Set the CCDF (Complementary Cumulative Distribution Function) option of the spectrum analyzer.
Record the maximum PAPR level associated with a probability of 0.1%.

3.2.4 Test Setup

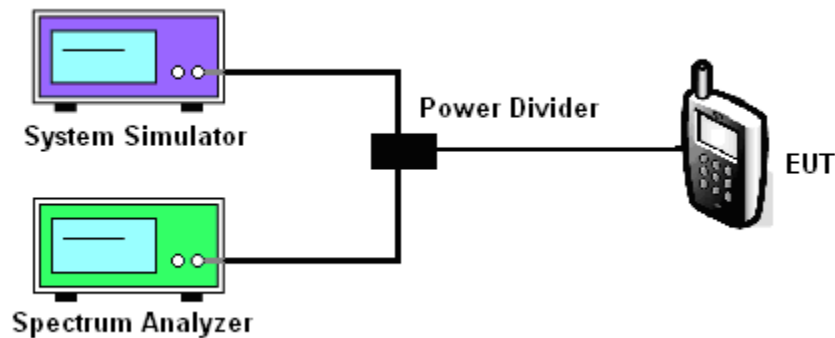



3.2.5 Test Result of Peak-to-Average Ratio

Cellular Band									
Modes	GSM850 (GPRS class 8)			GSM850 (EDGE class 8)			WCDMA Band V (RMC 12.2Kbps)		
Channel	128 (Low)	189 (Mid)	251 (High)	128 (Low)	189 (Mid)	251 (High)	4132 (Low)	4182 (Mid)	4233 (High)
Frequency (MHz)	824.2	836.4	848.8	824.2	836.4	848.8	826.4	836.4	846.6
Peak-to-Average Ratio (dB)	0.32	0.28	0.28	3.52	3.28	3.12	2.68	2.88	2.84

PCS Band									
Modes	GSM1900 (GPRS class 8)			GSM1900 (EDGE class 8)			WCDMA Band II (RMC 12.2Kbps)		
Channel	512 (Low)	661 (Mid)	810 (High)	512 (Low)	661 (Mid)	810 (High)	9262 (Low)	9400 (Mid)	9538 (High)
Frequency (MHz)	1850.2	1880	1909.8	1850.2	1880	1909.8	1852.4	1880	1907.6
Peak-to-Average Ratio (dB)	0.20	0.28	0.24	3.44	3.44	3.44	2.68	2.72	2.80

CDMA2000 BC0			
Modes	CDMA 2000 1xRTT		
Test Status	RC3+SO32		
Channel	1013 (Low)	384 (Mid)	777 (High)
Frequency (MHz)	824.70	836.52	848.31
Peak-to-Average Ratio (dB)	4.00	4.32	3.56

CDMA2000 BC1			
Modes	CDMA 2000 1xRTT		
Test Status	RC3+SO32		
Channel	25 (Low)	600 (Mid)	1175 (High)
Frequency (MHz)	1851.25	1880	1908.75
Peak-to-Average Ratio (dB)	4.28	4.48	4.08



3.2.6 Test Result (Plots) of Peak-to-Average Ratio

Band :	GSM 850	Test Mode :	GPRS class 8 Link (GMSK)
---------------	---------	--------------------	--------------------------

Peak-to-Average Ratio on Channel 128 (824.2 MHz)

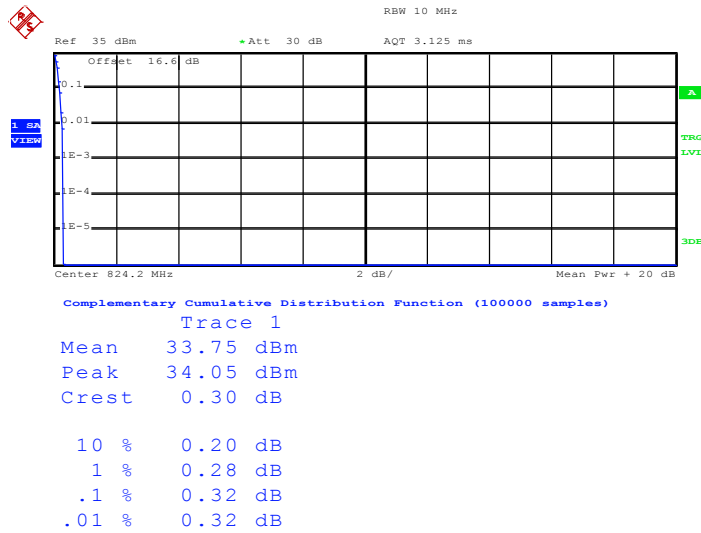

Date: 4.AUG.2014 17:28:51

Peak-to-Average Ratio on Channel 189 (836.4 MHz)

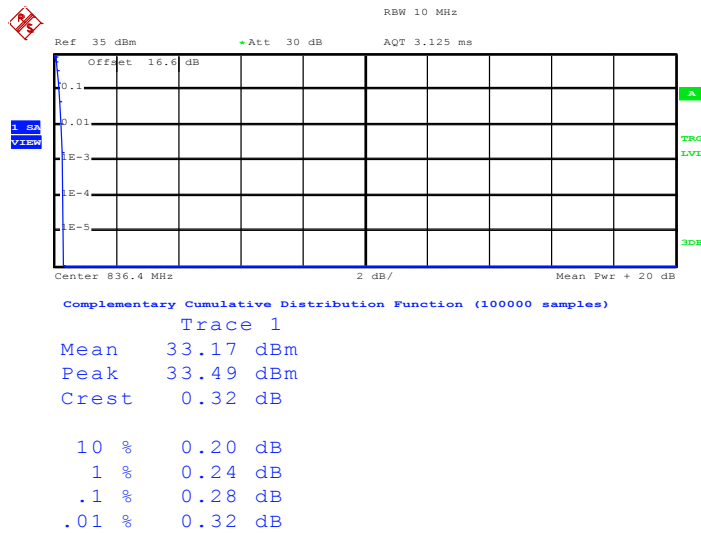

Date: 4.AUG.2014 17:29:44



Peak-to-Average Ratio on Channel 251 (848.8 MHz)

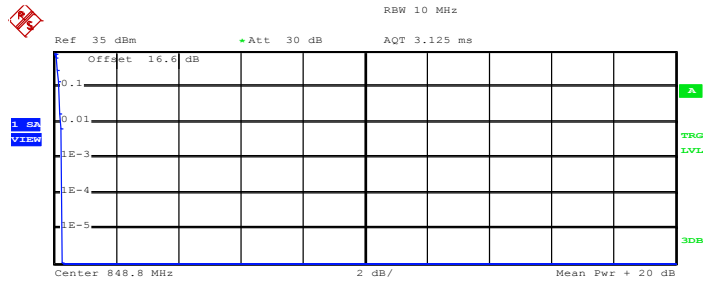

Complementary Cumulative Distribution Function (100000 samples)

Trace 1

Mean	32.73 dBm
Peak	33.00 dBm
Crest	0.27 dB
10 %	0.16 dB
1 %	0.24 dB
.1 %	0.28 dB
.01 %	0.28 dB

Date: 4.AUG.2014 17:30:16



Band :	GSM 850	Test Mode :	EDGE class 8 Link (8PSK)
---------------	---------	--------------------	--------------------------

Peak-to-Average Ratio on Channel 128 (824.2 MHz)

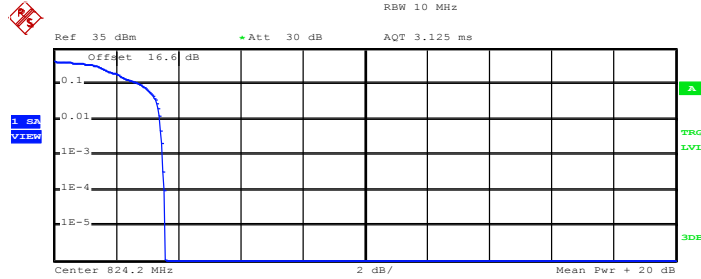

Complementary Cumulative Distribution Function (100000 samples)

Trace 1

Mean	27.94 dBm
Peak	31.51 dBm
Crest	3.57 dB
10 %	2.80 dB
1 %	3.40 dB
.1 %	3.52 dB
.01 %	3.56 dB

Date: 5.AUG.2014 09:14:21

Peak-to-Average Ratio on Channel 189 (836.4 MHz)

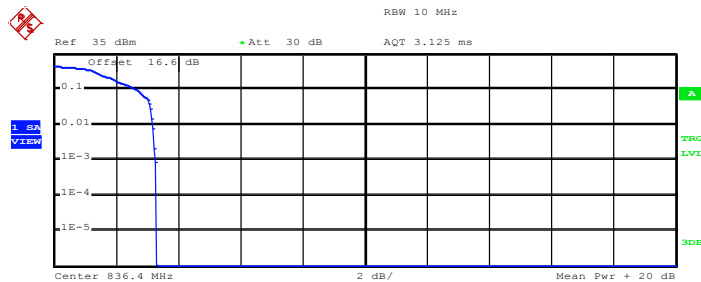

Complementary Cumulative Distribution Function (100000 samples)

Trace 1

Mean	27.57 dBm
Peak	30.88 dBm
Crest	3.31 dB
10 %	2.68 dB
1 %	3.20 dB
.1 %	3.28 dB
.01 %	3.32 dB

Date: 5.AUG.2014 09:15:26



Peak-to-Average Ratio on Channel 251 (848.8 MHz)

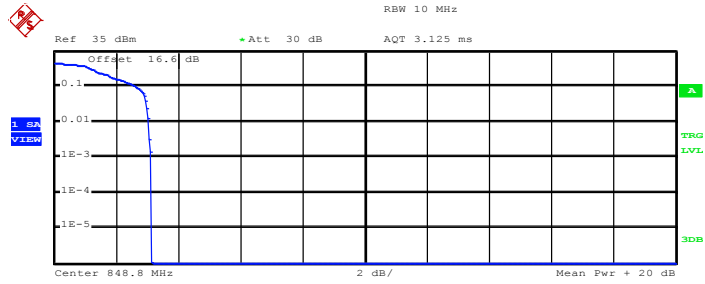

Complementary Cumulative Distribution Function (100000 samples)

Trace 1	
Mean	27.03 dBm
Peak	30.17 dBm
Crest	3.14 dB
10 %	2.64 dB
1 %	3.04 dB
.1 %	3.12 dB
.01 %	3.16 dB

Date: 5.AUG.2014 09:15:54



Band :	GSM 1900	Test Mode :	GPRS class 8 Link (GMSK)
---------------	----------	--------------------	--------------------------

Peak-to-Average Ratio on Channel 512 (1850.2 MHz)

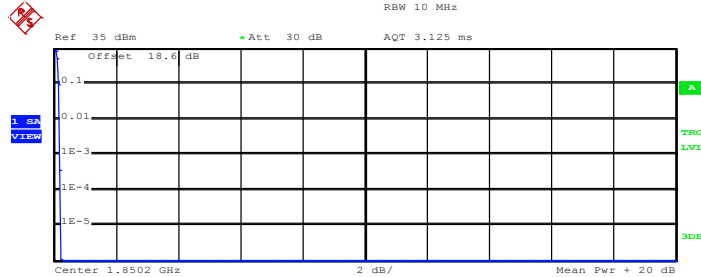

Complementary Cumulative Distribution Function (100000 samples)

Trace 1
Mean 30.71 dBm
Peak 30.95 dBm
Crest 0.24 dB

10 %	0.16 dB
1 %	0.20 dB
.1 %	0.20 dB
.01 %	0.24 dB

Date: 5.AUG.2014 10:10:11

Peak-to-Average Ratio on Channel 661 (1880.0 MHz)

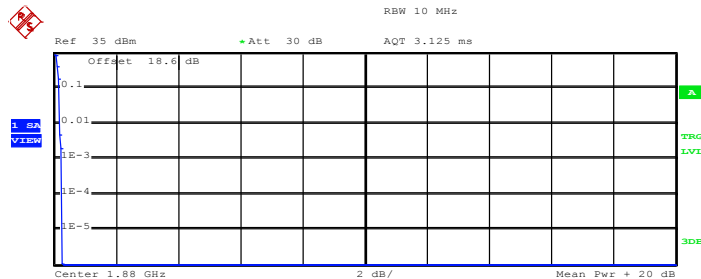

Complementary Cumulative Distribution Function (100000 samples)

Trace 1
Mean 30.82 dBm
Peak 31.09 dBm
Crest 0.27 dB

10 %	0.16 dB
1 %	0.20 dB
.1 %	0.28 dB
.01 %	0.28 dB

Date: 5.AUG.2014 10:10:36



Peak-to-Average Ratio on Channel 810 (1909.8 MHz)

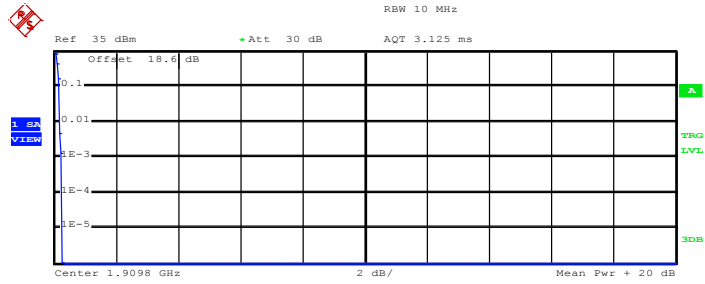

Complementary Cumulative Distribution Function (100000 samples)

Trace 1	
Mean	30.83 dBm
Peak	31.09 dBm
Crest	0.26 dB
10 %	0.16 dB
1 %	0.20 dB
.1 %	0.24 dB
.01 %	0.28 dB

Date: 5.AUG.2014 10:11:01



Band :	GSM 1900	Test Mode :	EDGE class 8 Link (8PSK)
---------------	----------	--------------------	--------------------------

Peak-to-Average Ratio on Channel 512 (1850.2 MHz)

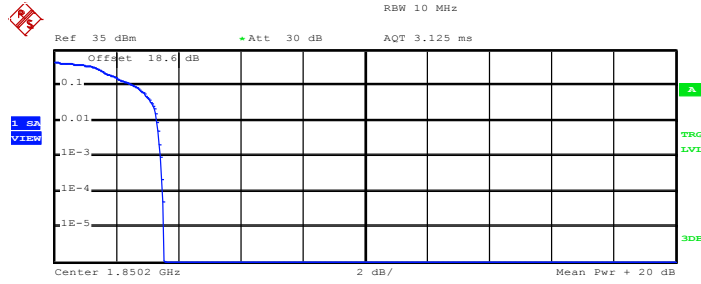

Complementary Cumulative Distribution Function (100000 samples)

Trace 1

Mean	26.72 dBm
Peak	30.24 dBm
Crest	3.52 dB
10 %	2.60 dB
1 %	3.32 dB
.1 %	3.44 dB
.01 %	3.52 dB

Date: 5.AUG.2014 11:00:32

Peak-to-Average Ratio on Channel 661 (1880.0 MHz)

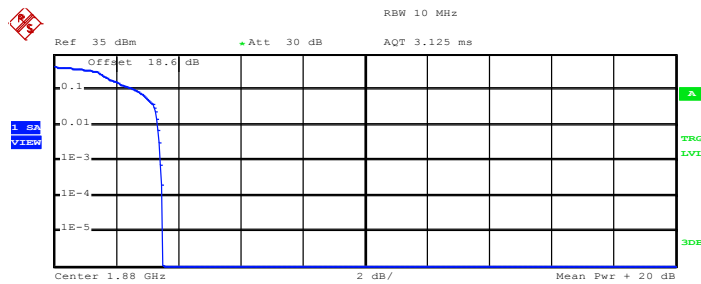

Complementary Cumulative Distribution Function (100000 samples)

Trace 1

Mean	26.76 dBm
Peak	30.24 dBm
Crest	3.49 dB
10 %	2.68 dB
1 %	3.36 dB
.1 %	3.44 dB
.01 %	3.52 dB

Date: 5.AUG.2014 11:01:00



Peak-to-Average Ratio on Channel 810 (1909.8 MHz)

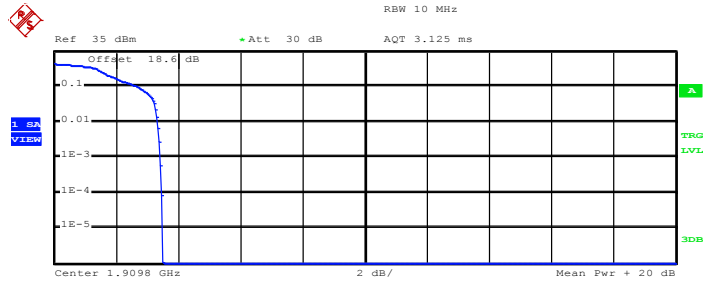

Complementary Cumulative Distribution Function (100000 samples)

Trace 1	
Mean	26.94 dBm
Peak	30.46 dBm
Crest	3.51 dB
10 %	2.72 dB
1 %	3.36 dB
.1 %	3.44 dB
.01 %	3.48 dB

Date: 5.AUG.2014 11:01:51



Band :	WCDMA Band V	Test Mode :	RMC 12.2Kbps Link (QPSK)
---------------	--------------	--------------------	--------------------------

Peak-to-Average Ratio on Channel 4132 (826.4 MHz)

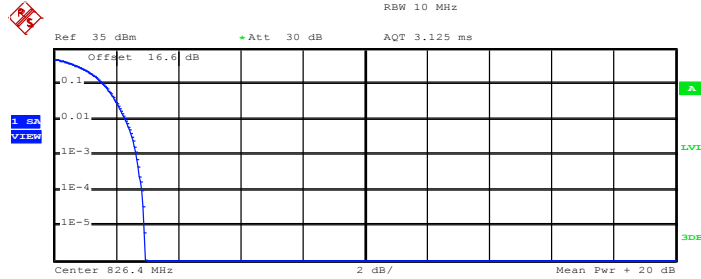

Complementary Cumulative Distribution Function (100000 samples)

Trace 1
 Mean 23.61 dBm
 Peak 26.57 dBm
 Crest 2.96 dB

10 % 1.60 dB
 1 % 2.32 dB
 .1 % 2.68 dB
 .01 % 2.84 dB

Date: 5.AUG.2014 12:57:15

Peak-to-Average Ratio on Channel 4182 (836.4 MHz)

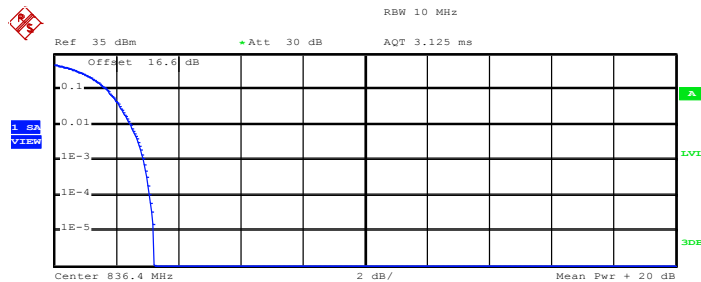

Complementary Cumulative Distribution Function (100000 samples)

Trace 1
 Mean 23.63 dBm
 Peak 26.86 dBm
 Crest 3.23 dB

10 % 1.72 dB
 1 % 2.48 dB
 .1 % 2.88 dB
 .01 % 3.08 dB

Date: 5.AUG.2014 12:57:45



Peak-to-Average Ratio on Channel 4233 (846.6 MHz)

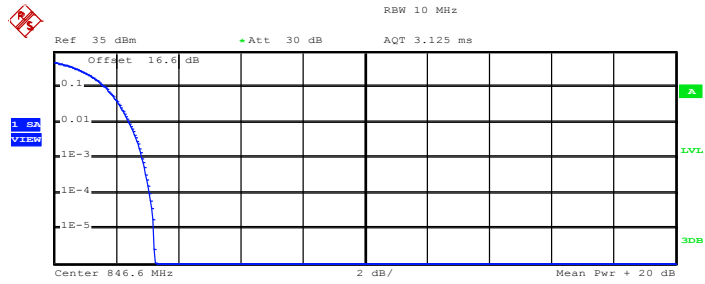

Complementary Cumulative Distribution Function (100000 samples)

Trace 1

Mean	24.11 dBm
Peak	27.35 dBm
Crest	3.24 dB
10 %	1.68 dB
1 %	2.44 dB
.1 %	2.84 dB
.01 %	3.08 dB

Date: 5.AUG.2014 12:58:24



Band :	WCDMA Band II	Test Mode :	RMC 12.2Kbps Link (QPSK)
---------------	---------------	--------------------	--------------------------

Peak-to-Average Ratio on Channel 9262 (1852.4 MHz)

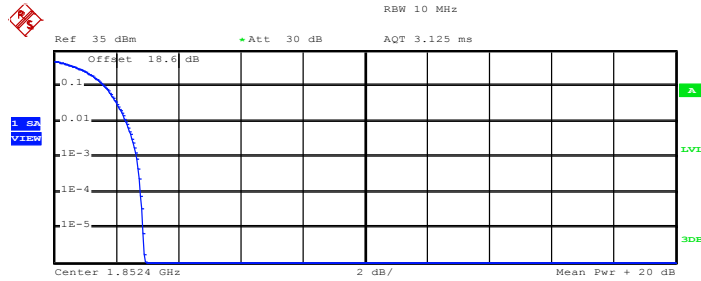

Complementary Cumulative Distribution Function (100000 samples)

Trace 1

Mean	24.78 dBm
Peak	27.70 dBm
Crest	2.93 dB
10 %	1.64 dB
1 %	2.32 dB
.1 %	2.68 dB
.01 %	2.80 dB

Date: 5.AUG.2014 11:43:21

Peak-to-Average Ratio on Channel 9400 (1880.0 MHz)

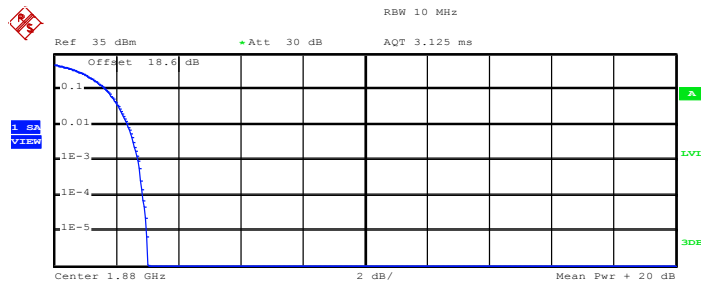

Complementary Cumulative Distribution Function (100000 samples)

Trace 1

Mean	24.90 dBm
Peak	27.92 dBm
Crest	3.01 dB
10 %	1.68 dB
1 %	2.36 dB
.1 %	2.72 dB
.01 %	2.88 dB

Date: 5.AUG.2014 11:54:06



Peak-to-Average Ratio on Channel 9538 (1907.6 MHz)

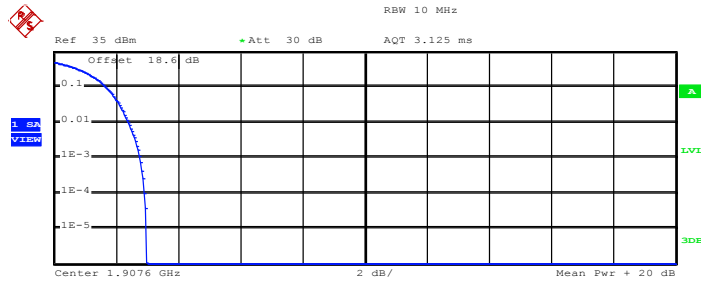

Complementary Cumulative Distribution Function (100000 samples)

Trace 1

Mean	24.51 dBm
Peak	27.49 dBm
Crest	2.98 dB
10 %	1.68 dB
1 %	2.40 dB
.1 %	2.80 dB
.01 %	2.92 dB

Date: 5.AUG.2014 11:55:05



Band :	CDMA2000 BC0	Test Mode :	1xRTT Link (QPSK)
---------------	--------------	--------------------	-------------------

Peak-to-Average Ratio on Channel 1013 (824.70 MHz)

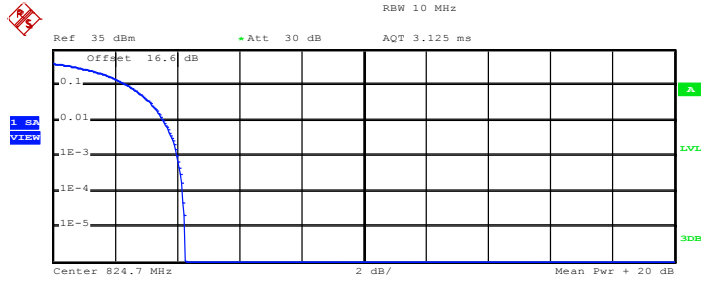

Complementary Cumulative Distribution Function (100000 samples)

Trace 1

Mean 23.86 dBm
 Peak 28.13 dBm
 Crest 4.26 dB

10 % 2.44 dB
 1 % 3.56 dB
 .1 % 4.00 dB
 .01 % 4.20 dB

Date: 10.AUG.2014 15:45:54

Peak-to-Average Ratio on Channel 384 (836.52 MHz)

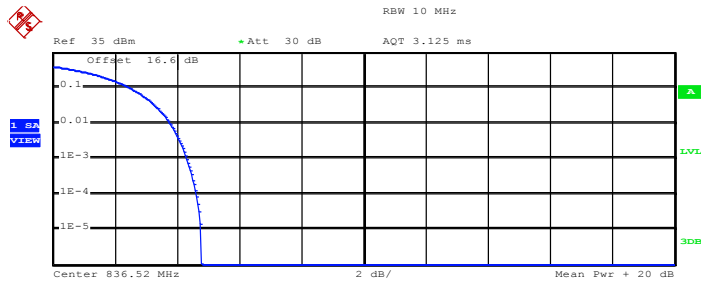

Complementary Cumulative Distribution Function (100000 samples)

Trace 1

Mean 23.91 dBm
 Peak 28.69 dBm
 Crest 4.79 dB

10 % 2.52 dB
 1 % 3.80 dB
 .1 % 4.32 dB
 .01 % 4.64 dB

Date: 10.AUG.2014 15:46:23



Peak-to-Average Ratio on Channel 777 (848.31 MHz)

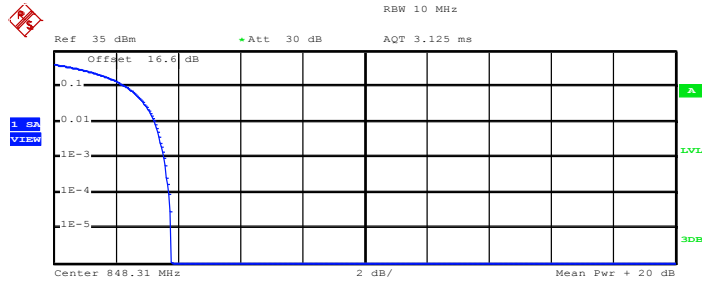

Complementary Cumulative Distribution Function (100000 samples)

Trace 1	
Mean	24.00 dBm
Peak	27.77 dBm
Crest	3.77 dB
10 %	2.36 dB
1 %	3.28 dB
.1 %	3.56 dB
.01 %	3.72 dB

Date: 10.AUG.2014 15:46:59



Band :	CDMA2000 BC1	Test Mode :	1xRTT Link (QPSK)
---------------	--------------	--------------------	-------------------

Peak-to-Average Ratio on Channel 25 (1851.25 MHz)

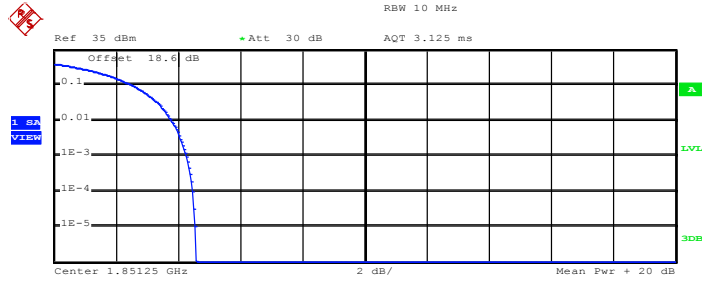

Complementary Cumulative Distribution Function (100000 samples)

Trace 1

Mean 23.91 dBm
 Peak 28.48 dBm
 Crest 4.57 dB

10 %	2.56 dB
1 %	3.80 dB
.1 %	4.28 dB
.01 %	4.48 dB

Date: 10.AUG.2014 14:57:56

Peak-to-Average Ratio on Channel 600 (1880 MHz)

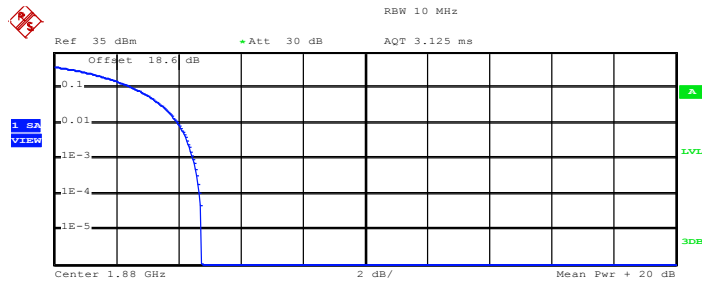

Complementary Cumulative Distribution Function (100000 samples)

Trace 1

Mean 24.44 dBm
 Peak 29.18 dBm
 Crest 4.75 dB

10 %	2.60 dB
1 %	4.00 dB
.1 %	4.48 dB
.01 %	4.68 dB

Date: 10.AUG.2014 14:58:43



Peak-to-Average Ratio on Channel 1175 (1908.75 MHz)

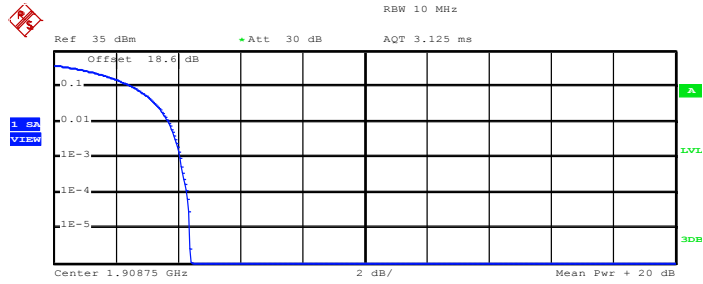

Complementary Cumulative Distribution Function (100000 samples)

Trace 1

Mean	24.15 dBm
Peak	28.55 dBm
Crest	4.40 dB
10 %	2.56 dB
1 %	3.72 dB
.1 %	4.08 dB
.01 %	4.28 dB

Date: 10.AUG.2014 14:59:13



3.3 Effective Radiated Power and Effective Isotropic Radiated Power Measurement

3.3.1 Description of the ERP/EIRP Measurement

The substitution method, in ANSI / TIA / EIA-603-C-2004, was used for ERP/EIRP measurement, and the spectrum analyzer configuration follows KDB 971168 D01 Power Meas. License Digital Systems v02r02. The ERP of mobile transmitters must not exceed 7 Watts and the EIRP of mobile transmitters are limited to 2 Watts.

3.3.2 Measuring Instruments

The measuring equipment is listed in the section 4 of this test report.

3.3.3 Test Procedures

1. The testing follows FCC KDB 971168 v02r02 Section 5.2.1. (for CDMA/WCDMA), Section 5.2.2.2 (for GSM/GPRS/EDGE) and ANSI / TIA-603-C-2004 Section 2.2.17.
2. The EUT was placed on a turntable 1.5 meters high in a fully anechoic chamber.
3. The EUT was placed 3 meters from the receiving antenna, which was mounted on the antenna tower.
4. GSM operating modes: Set RBW= 1MHz, VBW= 3MHz, RMS detector over burst;
UMTS operating modes: Set RBW= 100 kHz, VBW= 300 kHz, RMS detector over frame, and use channel power option with bandwidth=5MHz, per KDB 971168 D01.
5. The table was rotated 360 degrees to determine the position of the highest radiated power.
6. The height of the receiving antenna is adjusted to look for the maximum ERP/EIRP.
7. Taking the record of maximum ERP/EIRP.
8. A dipole antenna was substituted in place of the EUT and was driven by a signal generator.
9. The conducted power at the terminal of the dipole antenna is measured.
10. Repeat step 3 to step 5 to get the maximum ERP/EIRP of the substitution antenna.
11. $ERP/EIRP = P_s + E_t - E_s + G_s = P_s + R_t - R_s + G_s$
 P_s (dBm) : Input power to substitution antenna.
 G_s (dBi or dBd) : Substitution antenna Gain.
 $E_t = R_t + AF$
 $E_s = R_s + AF$
 AF (dB/m) : Receive antenna factor
 R_t : The highest received signal in spectrum analyzer for EUT.
 R_s : The highest received signal in spectrum analyzer for substitution antenna.

	GSM/GPRS/EDGE	CDMA2000/EV-DO	WCDMA/HSPA
SPAN	500kHz	3MHz	10MHz
RBW	10kHz	30kHz	100kHz
VBW	30kHz	100kHz	300kHz
Detector	RMS	RMS	RMS
Trace	Average	Average	Average
Average Type	Power	Power	Power
Sweep Count	100	100	100

3.3.4 Test Setup

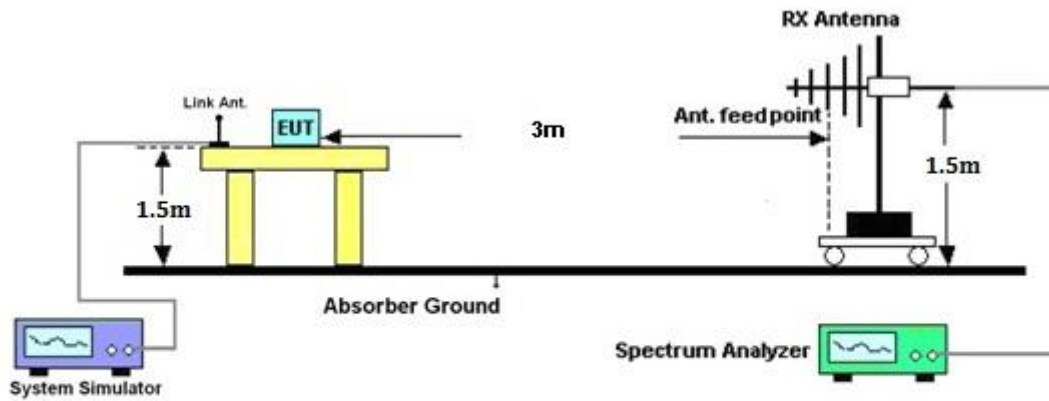



3.3.5 Test Result of ERP

GSM850 (GPRS class 8) Radiated Power ERP						
Horizontal Polarization						
Frequency (MHz)	Rt (dBm)	Rs (dBm)	Ps (dBm)	Gs (dBd)	ERP (dBm)	ERP (W)
824.20	-18.62	-48.12	0.00	-1.08	28.42	0.6950
836.40	-18.99	-48.28	0.00	-0.93	28.36	0.6855
848.80	-19.02	-48.35	0.00	-0.76	28.57	0.7194
Vertical Polarization						
Frequency (MHz)	Rt (dBm)	Rs (dBm)	Ps (dBm)	Gs (dBd)	ERP (dBm)	ERP (W)
824.20	-27.37	-47.97	0.00	-1.08	19.52	0.0895
836.40	-28.28	-48.01	0.00	-0.93	18.80	0.0759
848.80	-28.96	-48.05	0.00	-0.76	18.33	0.0681

GSM850 (EDGE class 8) Radiated Power ERP						
Horizontal Polarization						
Frequency (MHz)	Rt (dBm)	Rs (dBm)	Ps (dBm)	Gs (dBd)	ERP (dBm)	ERP (W)
824.20	-25.49	-48.12	0.00	-1.08	21.55	0.1429
836.40	-25.97	-48.28	0.00	-0.93	21.38	0.1374
848.80	-25.87	-48.35	0.00	-0.76	21.72	0.1486
Vertical Polarization						
Frequency (MHz)	Rt (dBm)	Rs (dBm)	Ps (dBm)	Gs (dBd)	ERP (dBm)	ERP (W)
824.20	-33.45	-47.97	0.00	-1.08	13.44	0.0221
836.40	-33.99	-48.01	0.00	-0.93	13.09	0.0204
848.80	-34.65	-48.05	0.00	-0.76	12.64	0.0184



WCDMA Band V (RMC 12.2Kbps) Radiated Power ERP						
Horizontal Polarization						
Frequency (MHz)	Rt (dBm)	Rs (dBm)	Ps (dBm)	Gs (dBd)	ERP (dBm)	ERP (W)
826.40	-28.92	-48.12	0.00	-1.08	18.12	0.0649
836.40	-28.21	-48.28	0.00	-0.93	19.14	0.0820
846.60	-27.96	-48.35	0.00	-0.76	19.63	0.0918
Vertical Polarization						
Frequency (MHz)	Rt (dBm)	Rs (dBm)	Ps (dBm)	Gs (dBd)	ERP (dBm)	ERP (W)
826.40	-35.85	-47.97	0.00	-1.08	11.04	0.0127
836.40	-36.20	-48.01	0.00	-0.93	10.88	0.0122
846.60	-36.73	-48.05	0.00	-0.76	10.56	0.0114

CDMA2000 BC0 1xRTT_RC3+SO32 Radiated Power ERP						
Horizontal Polarization						
Frequency (MHz)	Rt (dBm)	Rs (dBm)	Ps (dBm)	Gs (dBd)	ERP (dBm)	ERP (W)
824.70	-28.29	-48.12	0.00	-1.08	18.75	0.0750
836.52	-29.57	-48.28	0.00	-0.93	17.78	0.0600
848.31	-28.67	-48.35	0.00	-0.76	18.92	0.0780
Vertical Polarization						
Frequency (MHz)	Rt (dBm)	Rs (dBm)	Ps (dBm)	Gs (dBd)	ERP (dBm)	ERP (W)
824.70	-35.18	-47.97	0.00	-1.08	11.71	0.0148
836.52	-34.73	-48.01	0.00	-0.93	12.35	0.0172
848.31	-35.33	-48.05	0.00	-0.76	11.96	0.0157



3.3.6 Test Result of EIRP

GSM1900 (GPRS class 8) Radiated Power EIRP						
Horizontal Polarization						
Frequency (MHz)	Rt (dBm)	Rs (dBm)	Ps (dBm)	Gs (dBi)	EIRP (dBm)	EIRP (W)
1850.20	-25.81	-51.88	0.00	1.96	28.03	0.6353
1880.00	-26.26	-52.99	0.00	2.00	28.73	0.7464
1909.80	-26.61	-54.28	0.00	1.98	29.65	0.9226
Vertical Polarization						
Frequency (MHz)	Rt (dBm)	Rs (dBm)	Ps (dBm)	Gs (dBi)	EIRP (dBm)	EIRP (W)
1850.20	-26.17	-52.13	0.00	1.96	27.92	0.6194
1880.00	-27.10	-53.17	0.00	2.00	28.07	0.6412
1909.80	-26.99	-54.13	0.00	1.98	29.12	0.8166

GSM1900 (EDGE class 8) Radiated Power EIRP						
Horizontal Polarization						
Frequency (MHz)	Rt (dBm)	Rs (dBm)	Ps (dBm)	Gs (dBi)	EIRP (dBm)	EIRP (W)
1850.20	-30.13	-51.88	0.00	1.96	23.71	0.2350
1880.00	-30.51	-52.99	0.00	2.00	24.48	0.2805
1909.80	-31.35	-54.28	0.00	1.98	24.91	0.3097
Vertical Polarization						
Frequency (MHz)	Rt (dBm)	Rs (dBm)	Ps (dBm)	Gs (dBi)	EIRP (dBm)	EIRP (W)
1850.20	-30.67	-52.13	0.00	1.96	23.42	0.2198
1880.00	-31.66	-53.17	0.00	2.00	23.51	0.2244
1909.80	-31.69	-54.13	0.00	1.98	24.42	0.2767



WCDMA Band II (RMC 12.2Kbps) Radiated Power EIRP						
Horizontal Polarization						
Frequency (MHz)	Rt (dBm)	Rs (dBm)	Ps (dBm)	Gs (dBi)	EIRP (dBm)	EIRP (W)
1852.40	-31.39	-51.88	0.00	1.96	22.45	0.1758
1880.00	-31.86	-52.99	0.00	2.00	23.13	0.2056
1907.60	-33.01	-54.28	0.00	1.98	23.25	0.2113
Vertical Polarization						
Frequency (MHz)	Rt (dBm)	Rs (dBm)	Ps (dBm)	Gs (dBi)	EIRP (dBm)	EIRP (W)
1852.40	-31.66	-52.13	0.00	1.96	22.43	0.1748
1880.00	-32.50	-53.17	0.00	2.00	22.67	0.1848
1907.60	-33.50	-54.13	0.00	1.98	22.61	0.1826

CDMA2000 BC1 1xRTT_RC3+S032 Radiated Power EIRP						
Horizontal Polarization						
Frequency (MHz)	Rt (dBm)	Rs (dBm)	Ps (dBm)	Gs (dBi)	EIRP (dBm)	EIRP (W)
1851.25	-31.46	-51.88	0.00	1.96	22.38	0.1730
1880.00	-32.09	-52.99	0.00	2.00	22.90	0.1950
1908.75	-33.61	-54.28	0.00	1.98	22.65	0.1841
Vertical Polarization						
Frequency (MHz)	Rt (dBm)	Rs (dBm)	Ps (dBm)	Gs (dBi)	EIRP (dBm)	EIRP (W)
1851.25	-32.51	-52.13	0.00	1.96	21.58	0.1439
1880.00	-34.41	-53.17	0.00	2.00	20.76	0.1191
1908.75	-35.78	-54.13	0.00	1.98	20.33	0.1079

3.4 99% Occupied Bandwidth and 26dB Bandwidth Measurement

3.4.1 Description of 99% Occupied Bandwidth and 26dB Bandwidth Measurement

The 99% occupied bandwidth is the width of a frequency band such that, below the lower and above the upper frequency limits, the mean powers emitted are each equal to a specified percentage 0.5% of the total mean transmitted power.

The emission bandwidth is defined as the width of the signal between two points, located at the 2 sides of the carrier frequency, outside of which all emissions are attenuated at least 26 dB below the transmitter power.

3.4.2 Measuring Instruments

The measuring equipment is listed in the section 4 of this test report.

3.4.3 Test Procedures

1. The testing follows FCC KDB 971168 v02r02 Section 4.2.
2. The EUT was connected to the spectrum analyzer and system simulator via a power divider.
3. The RF output of the EUT was connected to the spectrum analyzer by RF cable and attenuator. The path loss was compensated to the results for each measurement.
4. The 99% occupied bandwidth were measured, set RBW= 1% of span, VBW= 3*RBW, sample detector, trace maximum hold.
5. The 26dB bandwidth were measured, set RBW= 1% of EBW, VBW= 3*RBW, peak detector, trace maximum hold.

3.4.4 Test Setup

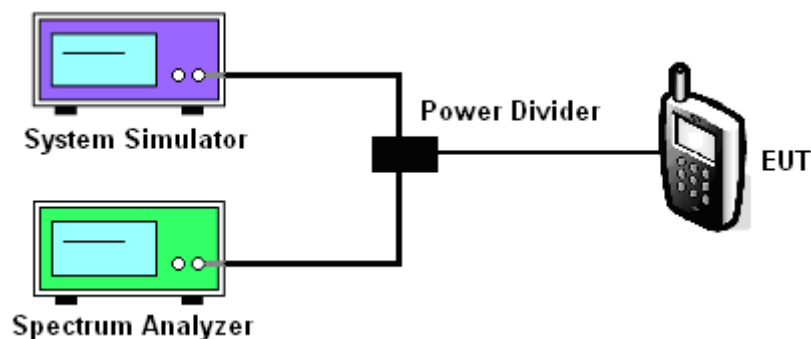



3.4.5 Test Result of Occupied Bandwidth and 26dB Bandwidth

Cellular Band						
Modes	GSM850 (GPRS class 8)			GSM850 (EDGE class 8)		
Channel	128 (Low)	189 (Mid)	251 (High)	128 (Low)	189 (Mid)	251 (High)
Frequency (MHz)	824.2	836.4	848.8	824.2	836.4	848.8
99% OBW (kHz)	246.00	242.00	244.00	244.00	246.00	246.00
26dB BW (kHz)	306.00	314.00	318.00	304.00	308.00	312.00

PCS Band						
Modes	GSM1900 (GPRS class 8)			GSM1900 (EDGE class 8)		
Channel	512 (Low)	661 (Mid)	810 (High)	512 (Low)	661 (Mid)	810 (High)
Frequency (MHz)	1850.2	1880	1909.8	1850.2	1880	1909.8
99% OBW (kHz)	248.00	248.00	246.00	246.00	246.00	248.00
26dB BW (kHz)	310.00	310.00	312.00	310.00	296.00	302.00

Cellular Band			
Modes	WCDMA Band V (RMC 12.2Kbps)		
Channel	4132 (Low)	4182 (Mid)	4233 (High)
Frequency (MHz)	826.4	836.4	846.6
99% OBW (MHz)	4.18	4.20	4.16
26dB BW (MHz)	4.68	4.68	4.68

PCS Band			
Modes	WCDMA Band II (RMC 12.2Kbps)		
Channel	9262 (Low)	9400 (Mid)	9538 (High)
Frequency (MHz)	1852.4	1880	1907.6
99% OBW (MHz)	4.16	4.20	4.16
26dB BW (MHz)	4.68	4.68	4.66



CDMA2000 BC0			
Test Mode	CDMA 2000 1xRTT		
Test Status	RC3+SO32		
Channel	1013 (Low)	384 (Mid)	777 (High)
Frequency (MHz)	824.70	836.52	848.31
99% OBW (MHz)	1.28	1.27	1.28
26dB BW (MHz)	1.42	1.42	1.42

CDMA2000 BC1			
Test Mode	CDMA 2000 1xRTT		
Test Status	RC3+SO32		
Channel	25 (Low)	600 (Mid)	1175 (High)
Frequency (MHz)	1851.25	1880.00	1908.75
99% OBW (MHz)	1.28	1.28	1.28
26dB BW (MHz)	1.41	1.42	1.42



3.4.6 Test Result (Plots) of Occupied Bandwidth and 26dB Bandwidth

Band :	GSM 850	Test Mode :	GPRS class 8 Link (GMSK)
--------	---------	-------------	--------------------------

99% Occupied Bandwidth Plot on Channel 128 (824.2 MHz)

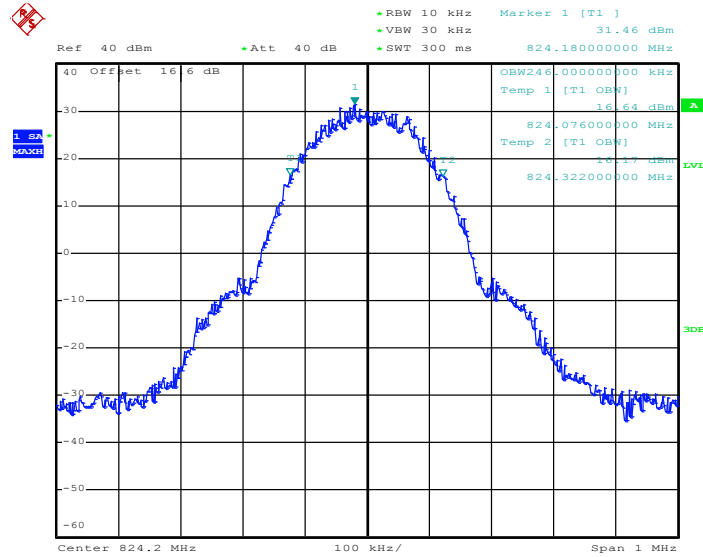

Date: 4.AUG.2014 18:08:31

26dB Bandwidth Plot on Channel 128 (824.2 MHz)

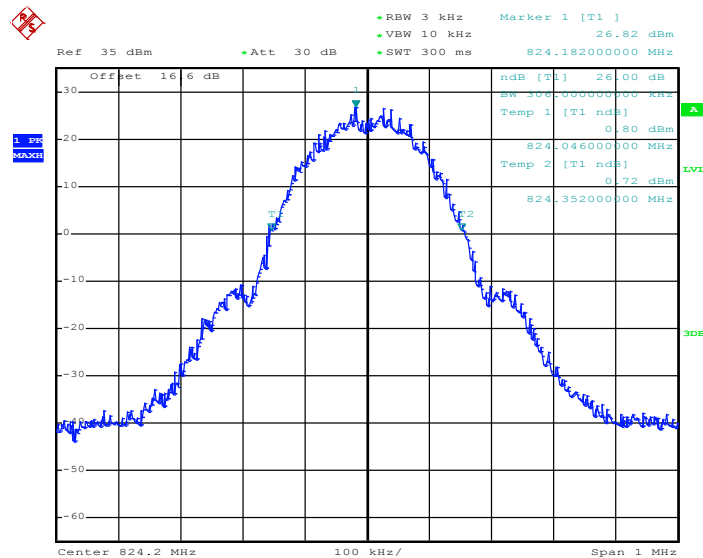

Date: 4.AUG.2014 17:54:50



99% Occupied Bandwidth Plot on Channel 189 (836.4 MHz)

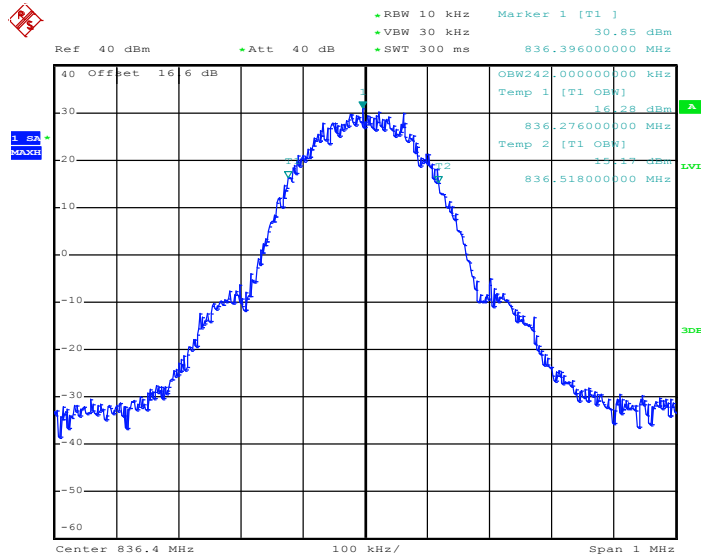

Date: 4.AUG.2014 18:05:43

26dB Bandwidth Plot on Channel 189 (836.4 MHz)

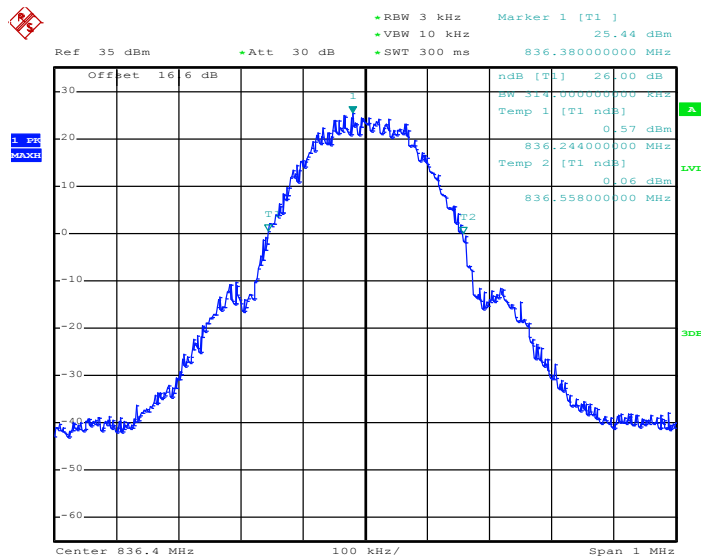

Date: 4.AUG.2014 17:55:28



99% Occupied Bandwidth Plot on Channel 251 (848.8 MHz)

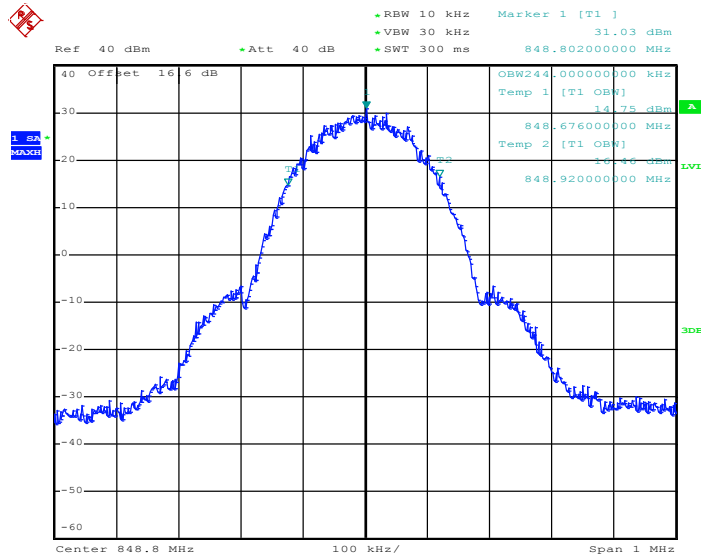

Date: 4.AUG.2014 18:03:37

26dB Bandwidth Plot on Channel 251 (848.8 MHz)

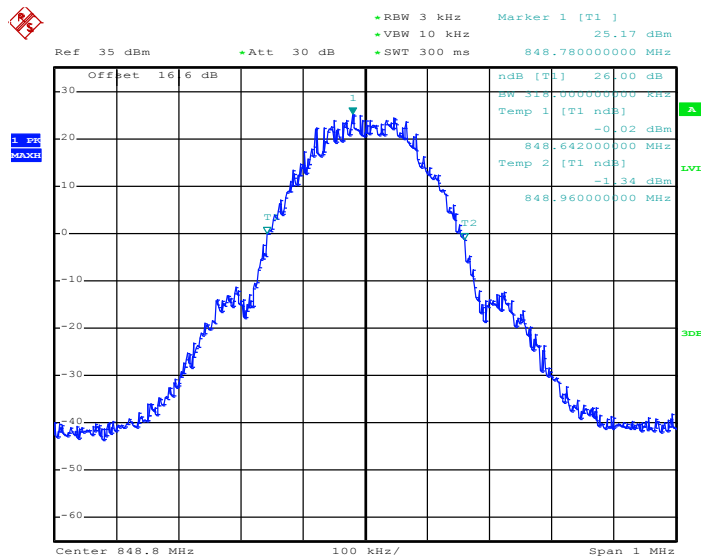

Date: 4.AUG.2014 17:56:06



Band :	GSM 850	Test Mode :	EDGE class 8 Link (8PSK)
---------------	---------	--------------------	--------------------------

99% Occupied Bandwidth Plot on Channel 128 (824.2 MHz)

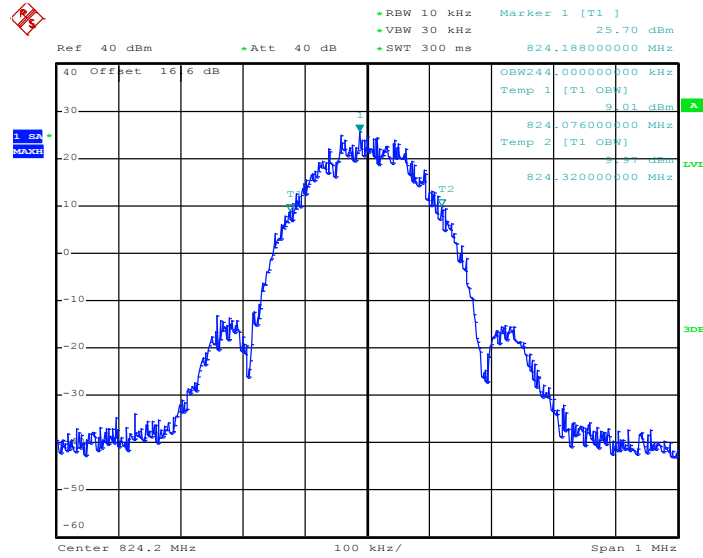

Date: 5.AUG.2014 09:34:07

26dB Bandwidth Plot on Channel 128 (824.2 MHz)

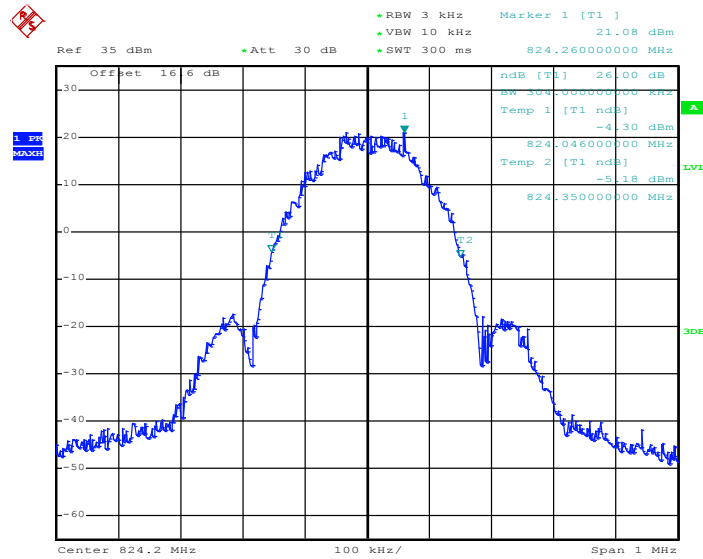

Date: 5.AUG.2014 09:20:32



99% Occupied Bandwidth Plot on Channel 189 (836.4 MHz)

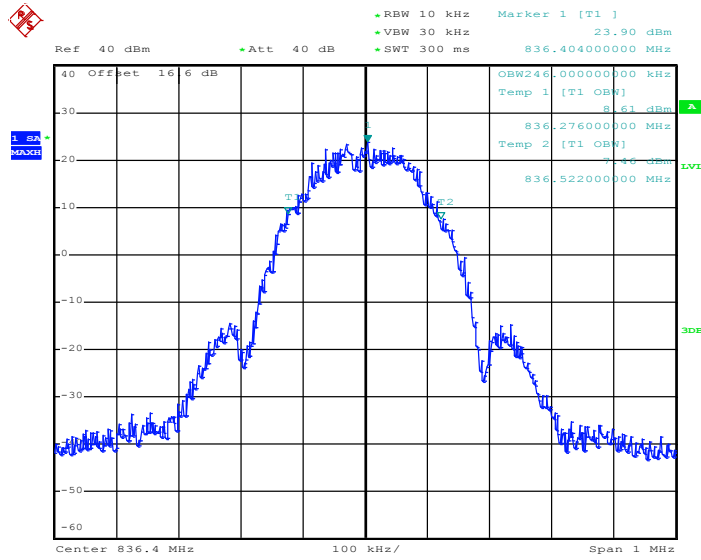

Date: 5.AUG.2014 09:34:43

26dB Bandwidth Plot on Channel 189 (836.4 MHz)

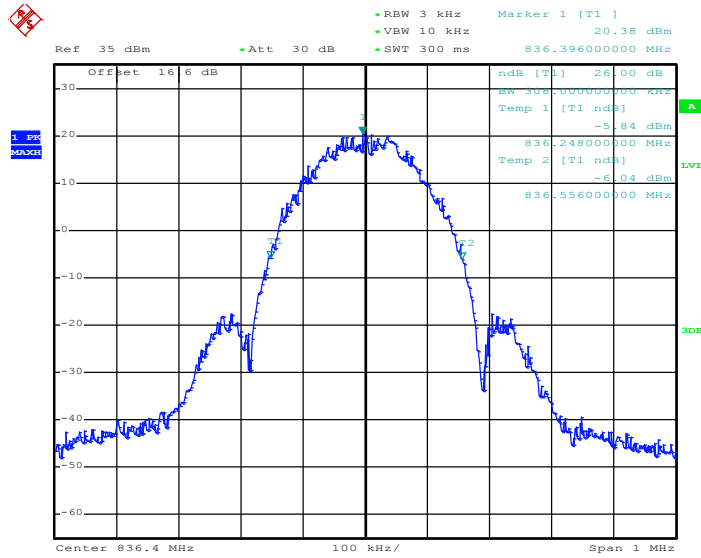

Date: 5.AUG.2014 09:21:06



99% Occupied Bandwidth Plot on Channel 251 (848.8 MHz)

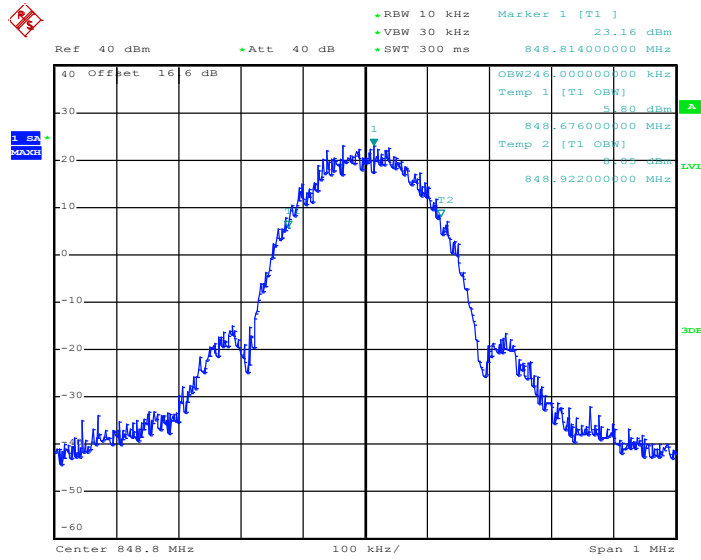

Date: 5.AUG.2014 09:35:17

26dB Bandwidth Plot on Channel 251 (848.8 MHz)

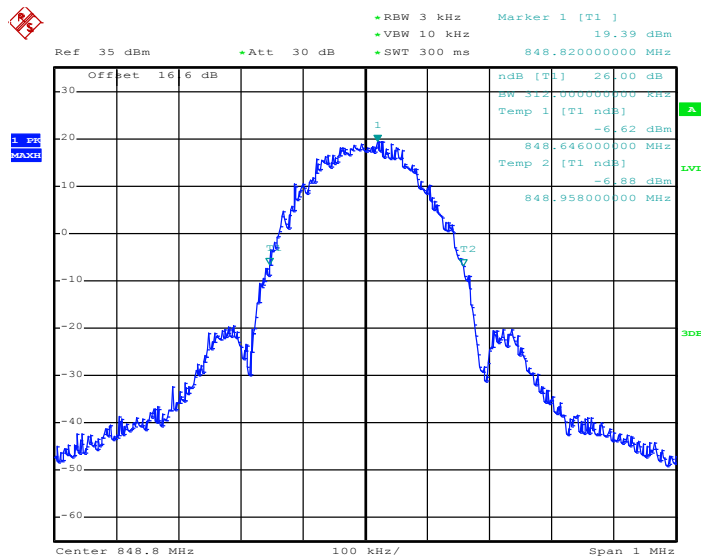

Date: 5.AUG.2014 09:21:39



Band :	GSM 1900	Test Mode :	GPRS class 8 Link (GMSK)
---------------	----------	--------------------	--------------------------

99% Occupied Bandwidth Plot on Channel 512 (1850.2 MHz)

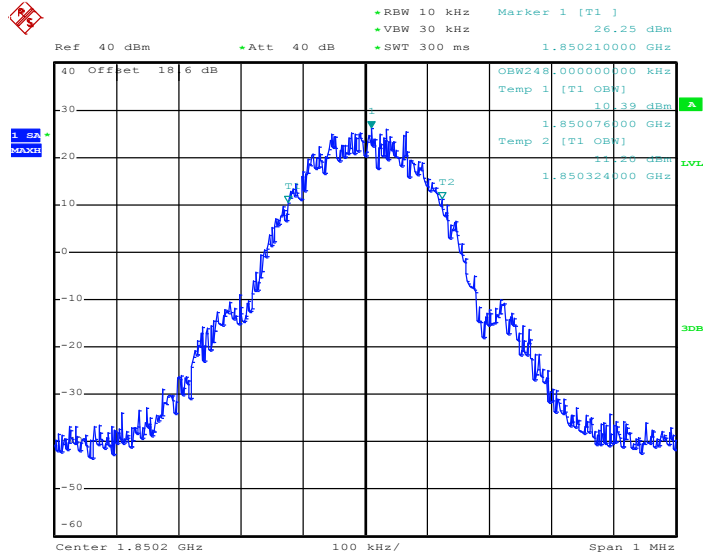

Date: 5.AUG.2014 10:31:40

26dB Bandwidth Plot on Channel 512 (1850.2 MHz)

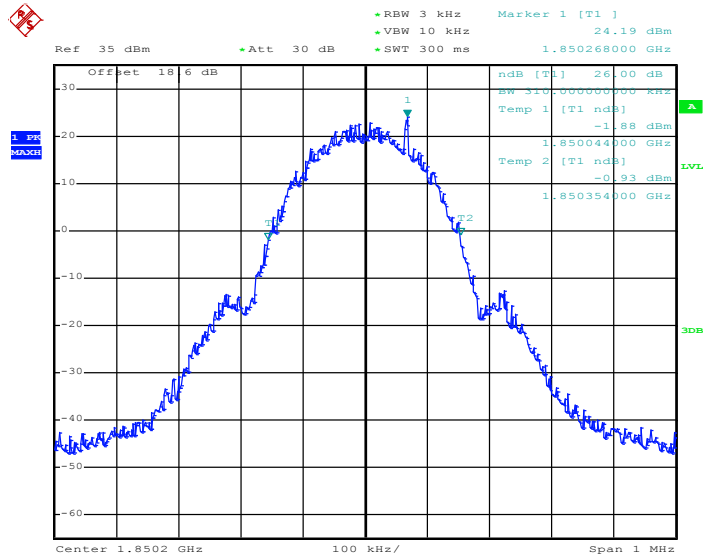

Date: 5.AUG.2014 10:15:34



99% Occupied Bandwidth Plot on Channel 661 (1880.0 MHz)

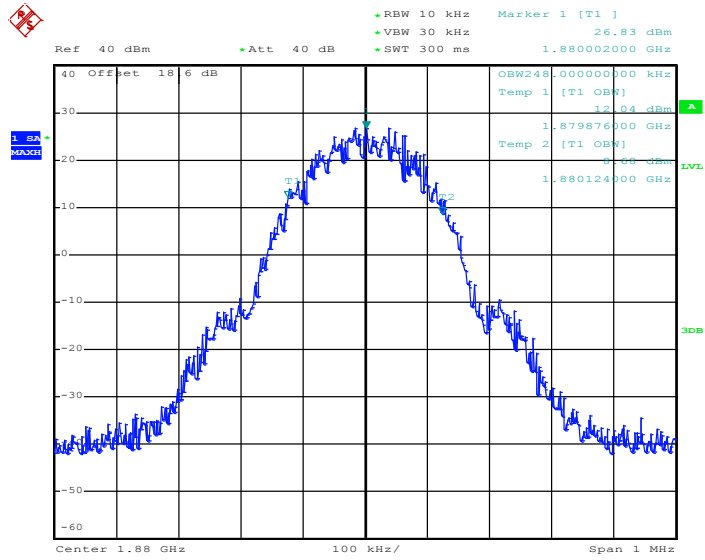

Date: 5.AUG.2014 10:32:08

26dB Bandwidth Plot on Channel 661 (1880.0 MHz)

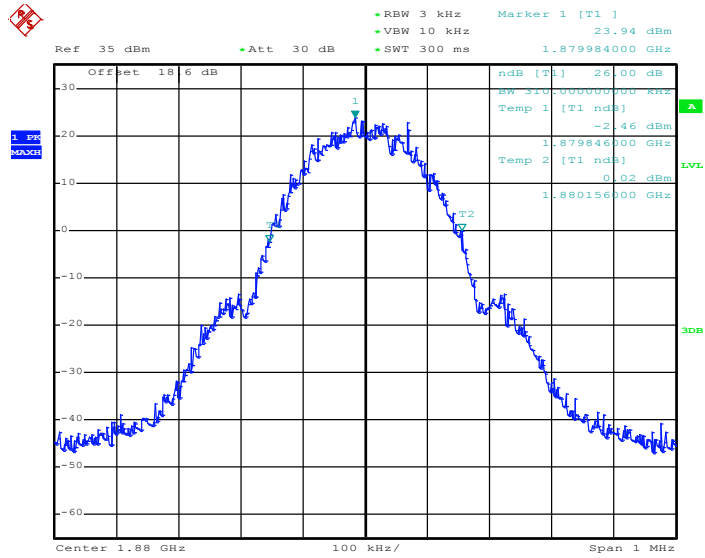

Date: 5.AUG.2014 10:16:03



99% Occupied Bandwidth Plot on Channel 810 (1909.8 MHz)

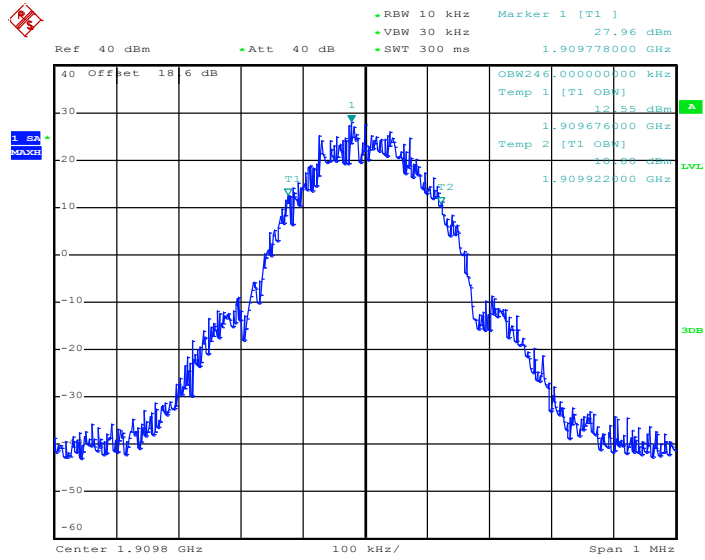

Date: 5.AUG.2014 10:32:37

26dB Bandwidth Plot on Channel 810 (1909.8 MHz)

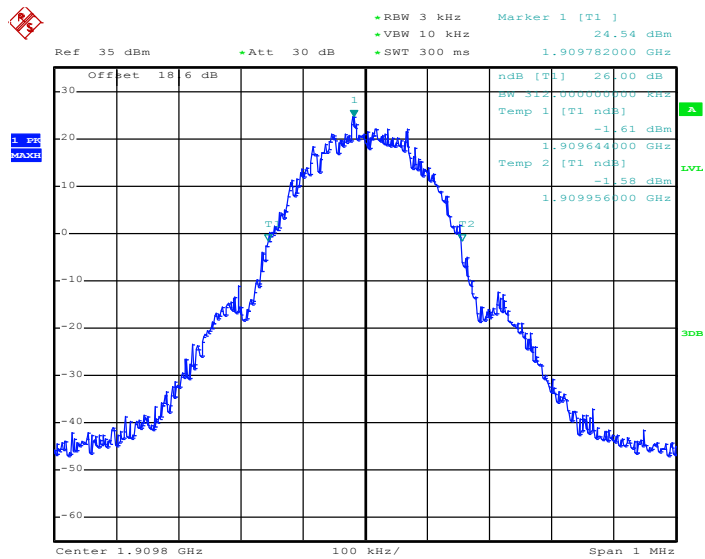

Date: 5.AUG.2014 10:16:32



Band :	GSM 1900	Test Mode :	EDGE class 8 Link (8PSK)
---------------	----------	--------------------	--------------------------

99% Occupied Bandwidth Plot on Channel 512 (1850.2 MHz)

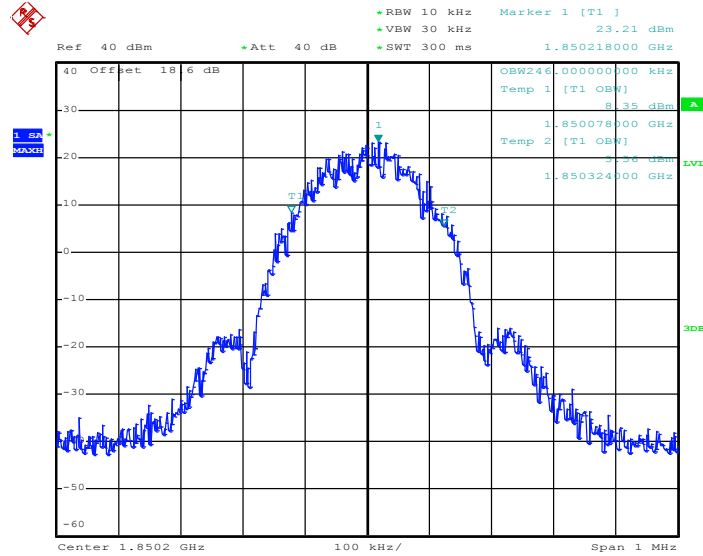

Date: 5.AUG.2014 11:15:38

26dB Bandwidth Plot on Channel 512 (1850.2 MHz)

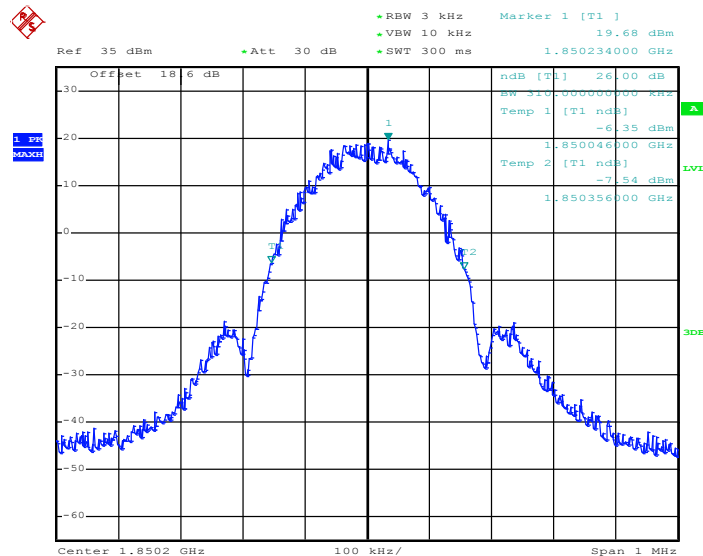

Date: 5.AUG.2014 11:13:15



99% Occupied Bandwidth Plot on Channel 661 (1880.0 MHz)

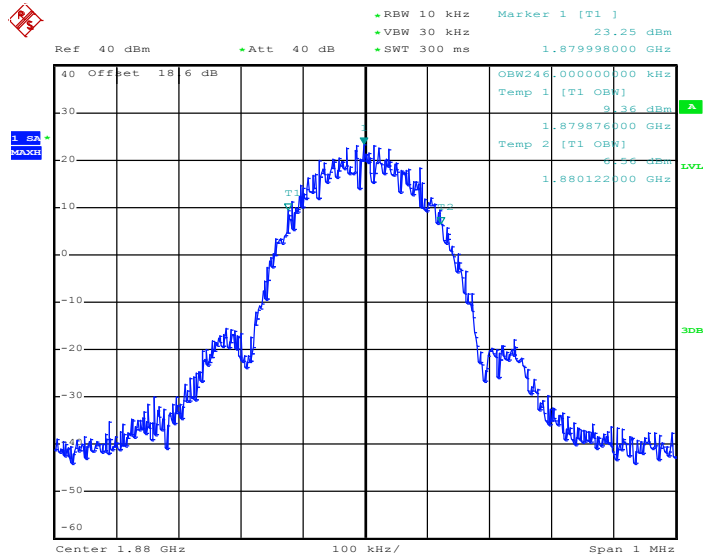

Date: 5.AUG.2014 11:16:15

26dB Bandwidth Plot on Channel 661 (1880.0 MHz)

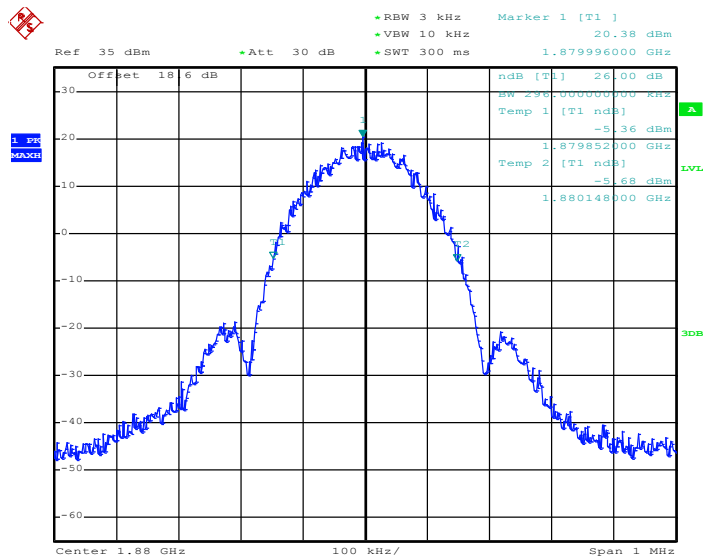

Date: 5.AUG.2014 11:13:56



99% Occupied Bandwidth Plot on Channel 810 (1909.8 MHz)

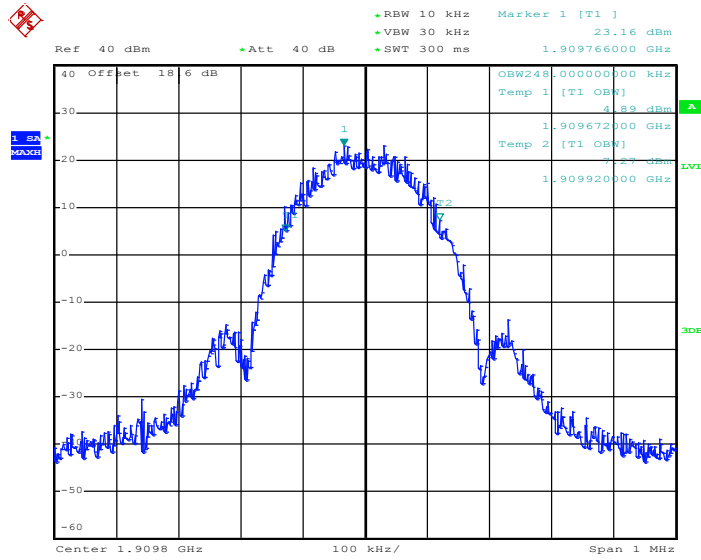

Date: 5.AUG.2014 11:18:58

26dB Bandwidth Plot on Channel 810 (1909.8 MHz)

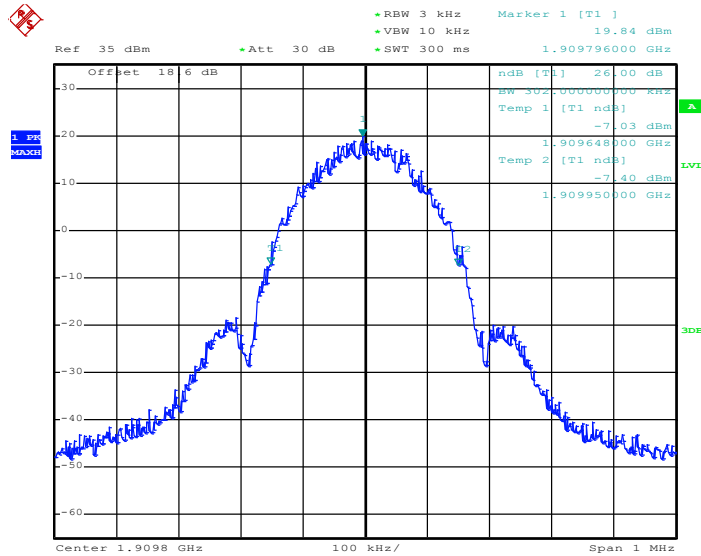

Date: 5.AUG.2014 11:14:31



Band :	WCDMA Band V	Test Mode :	RMC 12.2Kbps Link (QPSK)
---------------	--------------	--------------------	--------------------------

99% Occupied Bandwidth Plot on Channel 4132 (826.4 MHz)

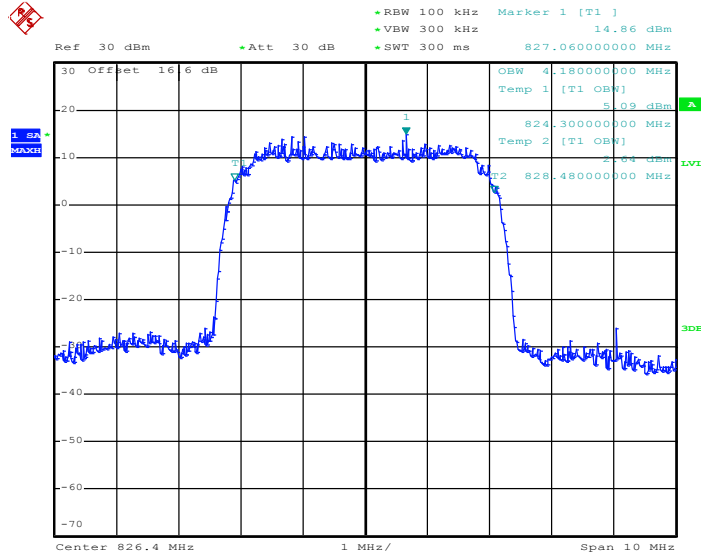

Date: 5.AUG.2014 13:17:18

26dB Bandwidth Plot on Channel 4132 (826.4 MHz)

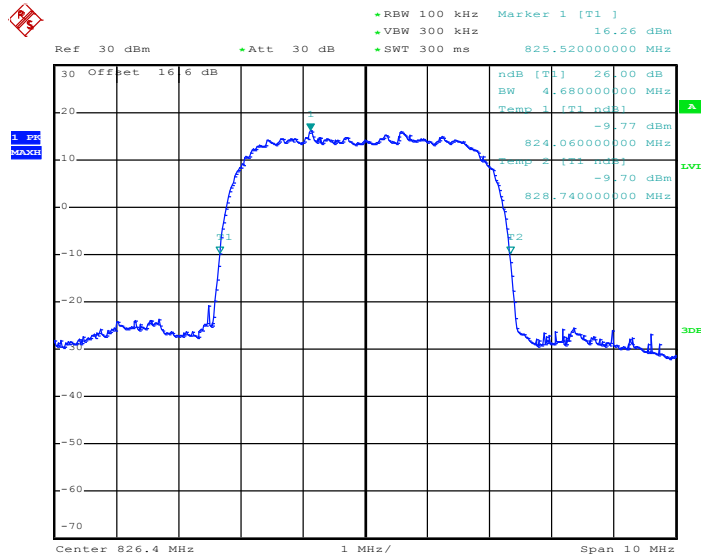

Date: 5.AUG.2014 13:08:13



99% Occupied Bandwidth Plot on Channel 4182 (836.4 MHz)

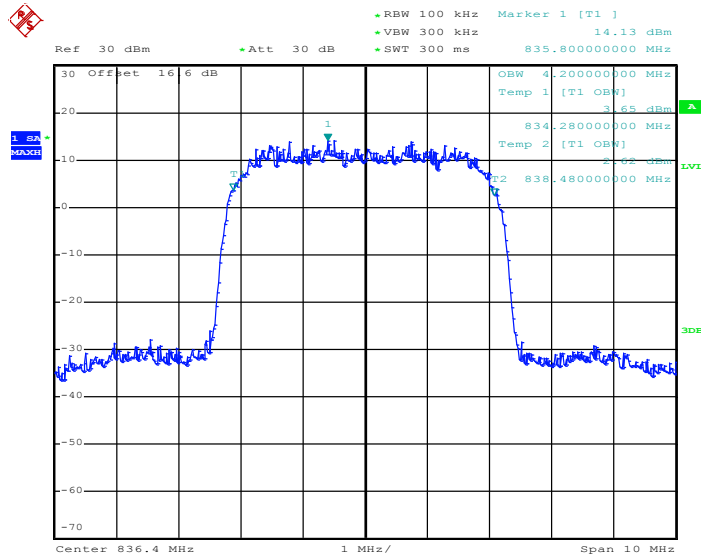

Date: 5.AUG.2014 13:17:46

26dB Bandwidth Plot on Channel 4182 (836.4 MHz)

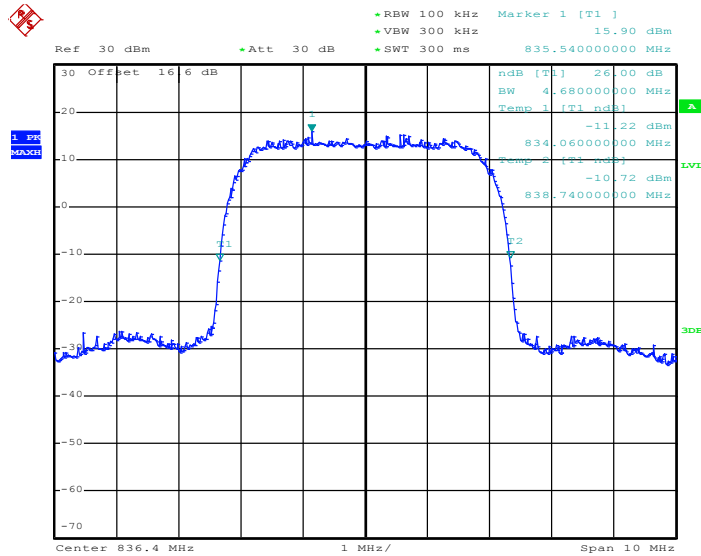

Date: 5.AUG.2014 13:12:53



99% Occupied Bandwidth Plot on Channel 4233 (846.6 MHz)

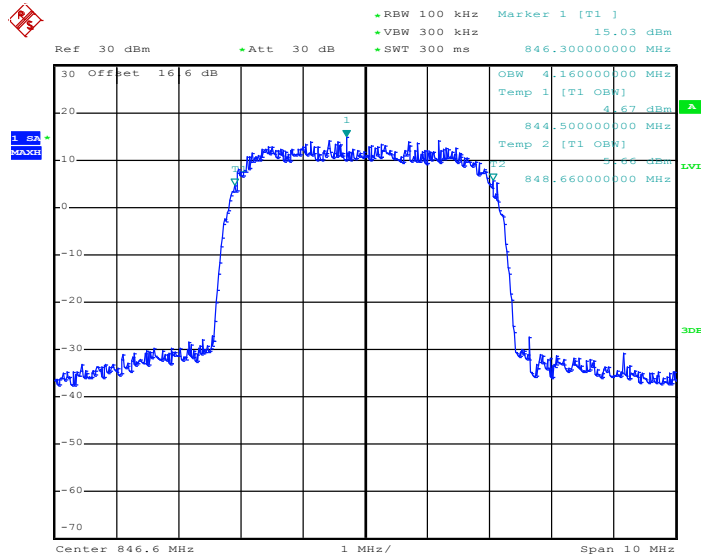

Date: 5.AUG.2014 13:18:15

26dB Bandwidth Plot on Channel 4233 (846.6 MHz)

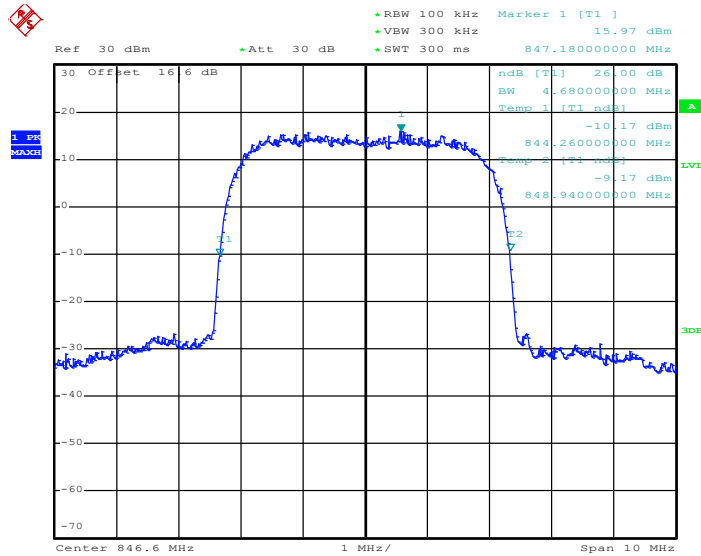

Date: 5.AUG.2014 13:12:22



Band :	WCDMA Band II	Test Mode :	RMC 12.2Kbps Link (QPSK)
---------------	---------------	--------------------	--------------------------

99% Occupied Bandwidth Plot on Channel 9262 (1852.4 MHz)

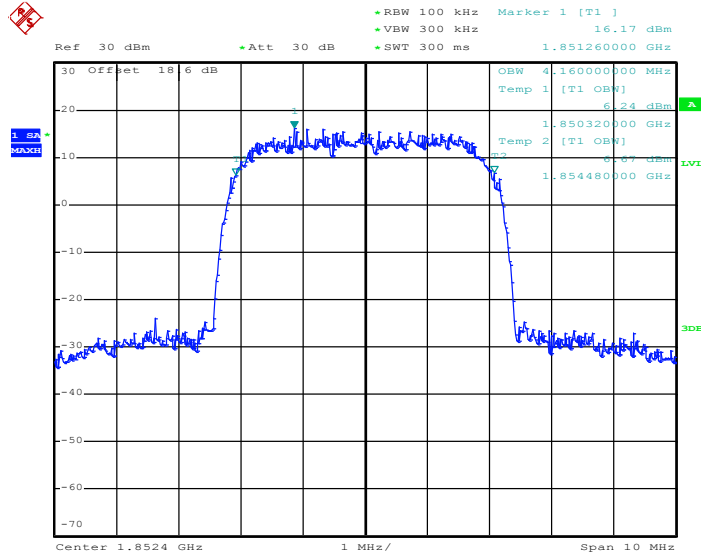

Date: 5.AUG.2014 12:40:34

26dB Bandwidth Plot on Channel 9262 (1852.4 MHz)

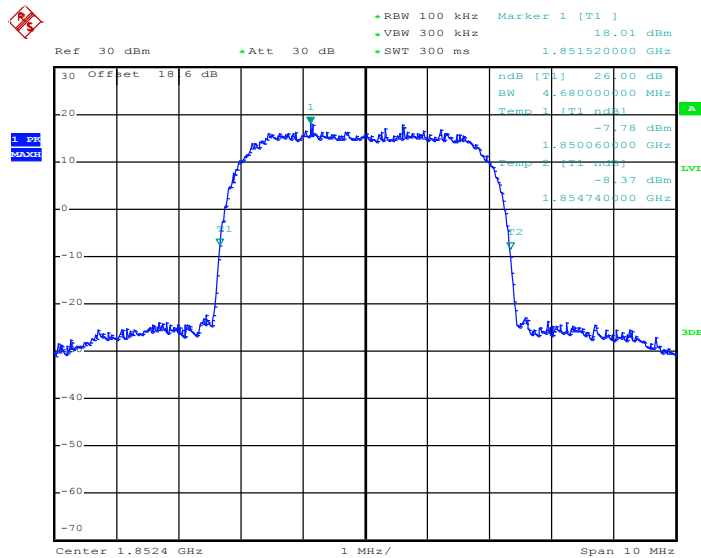

Date: 5.AUG.2014 12:34:06



99% Occupied Bandwidth Plot on Channel 9400 (1880.0 MHz)

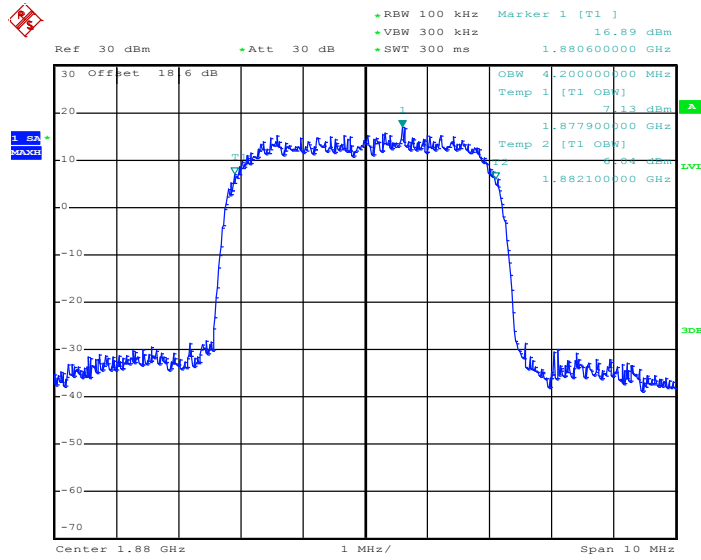

Date: 5.AUG.2014 12:41:02

26dB Bandwidth Plot on Channel 9400 (1880.0 MHz)

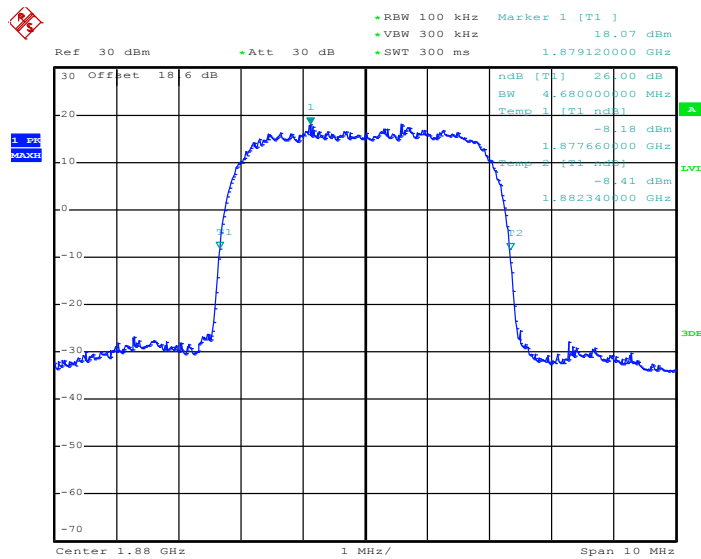

Date: 5.AUG.2014 12:33:45



99% Occupied Bandwidth Plot on Channel 9538 (1907.6 MHz)

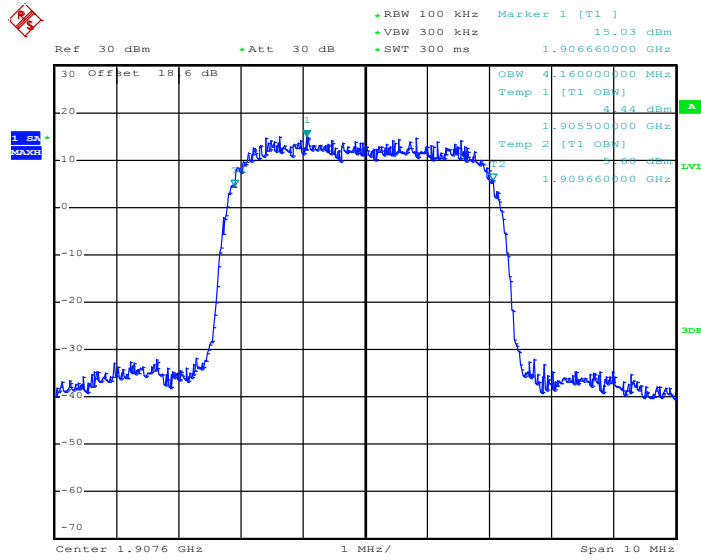

Date: 5.AUG.2014 12:41:31

26dB Bandwidth Plot on Channel 9538 (1907.6 MHz)

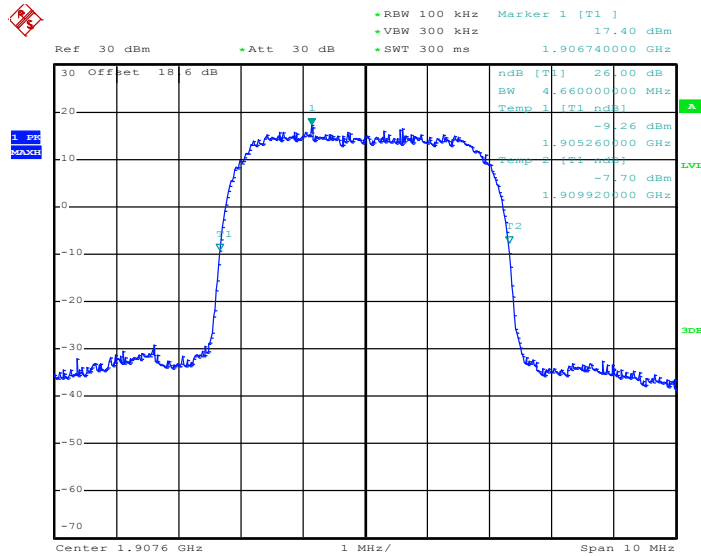

Date: 5.AUG.2014 12:32:56



99% Occupied Bandwidth Plot on Channel 384 (836.52 MHz)

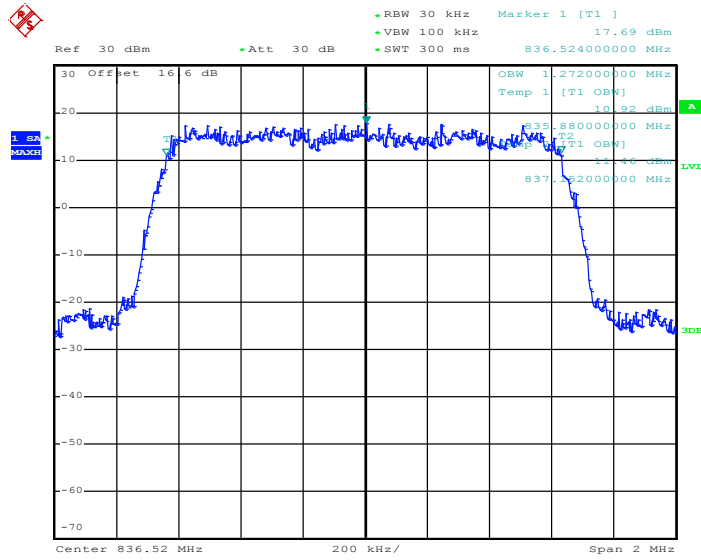

Date: 10.AUG.2014 16:12:26

26dB Bandwidth Plot on Channel 384 (836.52 MHz)

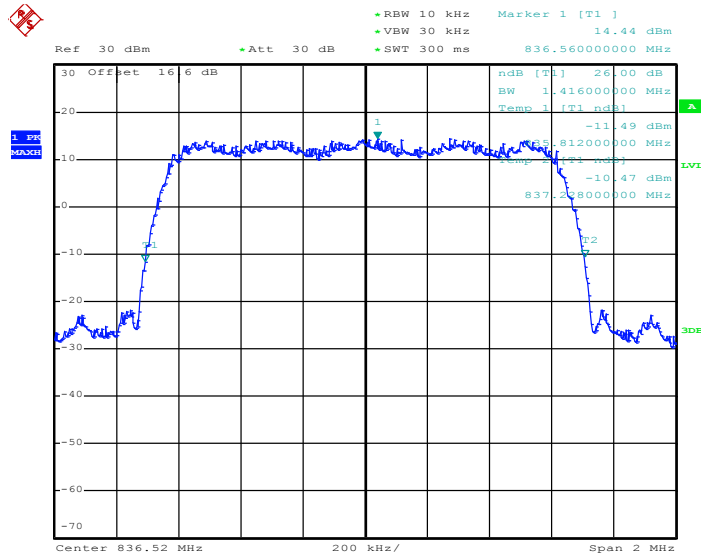

Date: 10.AUG.2014 16:10:25



99% Occupied Bandwidth Plot on Channel 777 (848.31 MHz)

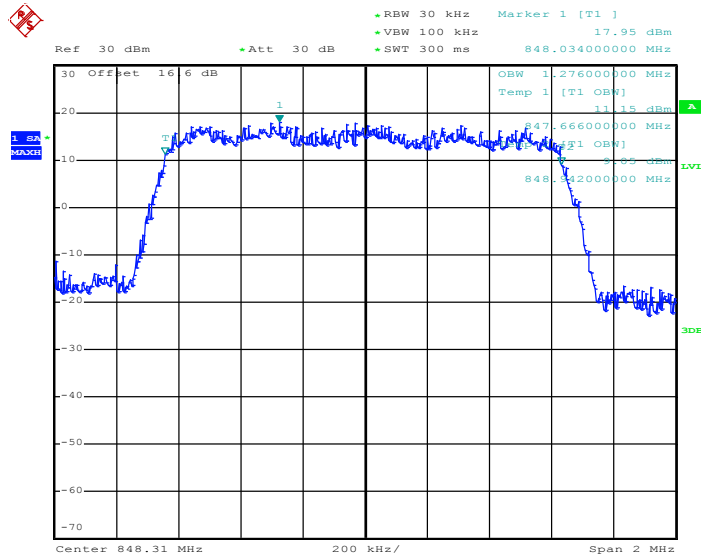

Date: 10.AUG.2014 16:13:00

26dB Bandwidth Plot on Channel 777 (848.31 MHz)

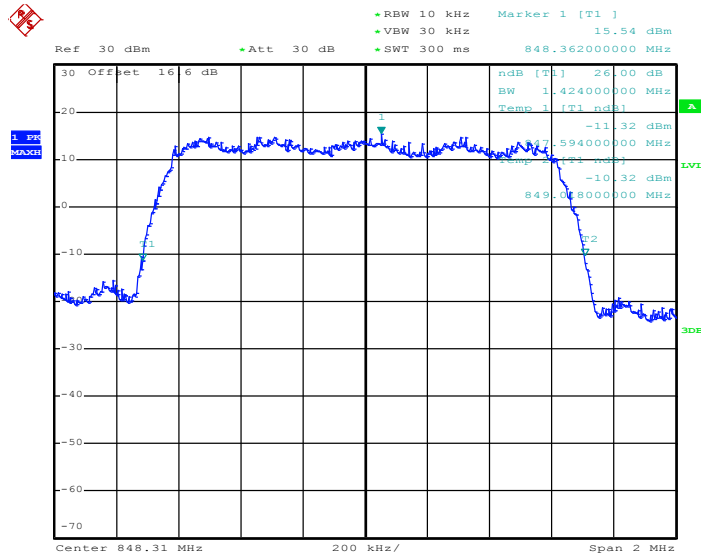

Date: 10.AUG.2014 16:11:02



Band :	CDMA2000 BC1	Test Mode :	1xRTT_RC3+SO32 (QPSK)
---------------	--------------	--------------------	-----------------------

99% Occupied Bandwidth Plot on Channel 25 (1851.25 MHz)

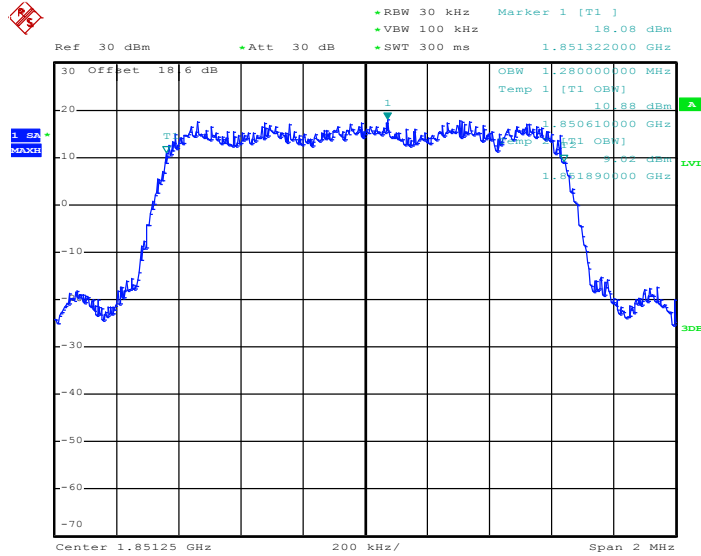

Date: 10.AUG.2014 15:34:56

26dB Bandwidth Plot on Channel 25 (1851.25 MHz)

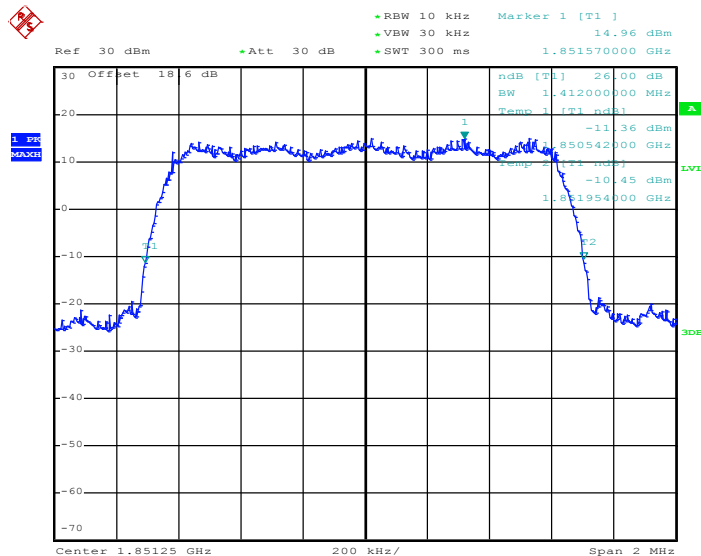

Date: 10.AUG.2014 15:32:59



99% Occupied Bandwidth Plot on Channel 600 (1880.0 MHz)

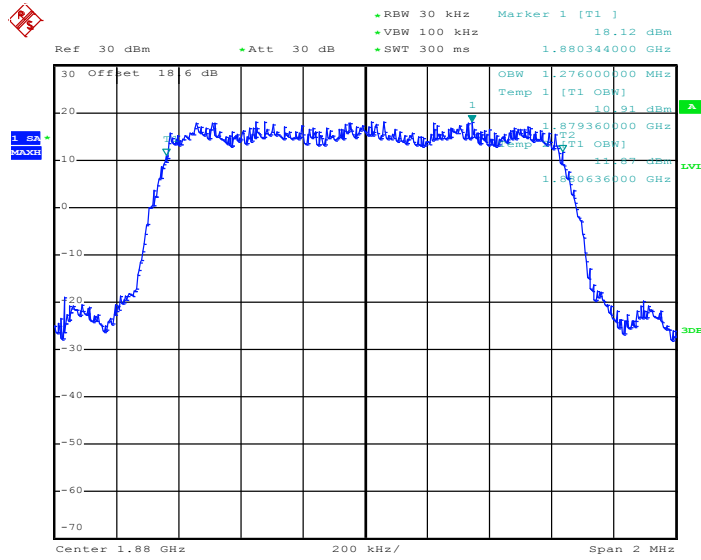

Date: 10.AUG.2014 15:35:28

26dB Bandwidth Plot on Channel 600 (1880.0 MHz)

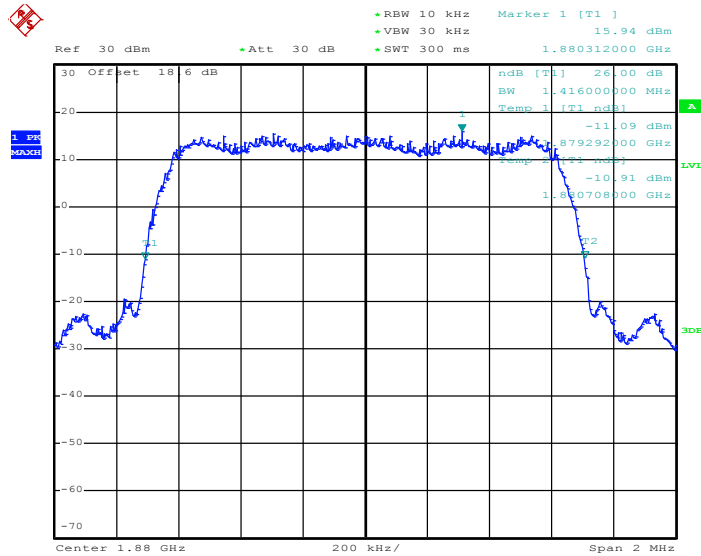

Date: 10.AUG.2014 15:33:33



99% Occupied Bandwidth Plot on Channel 1175 (1908.75 MHz)

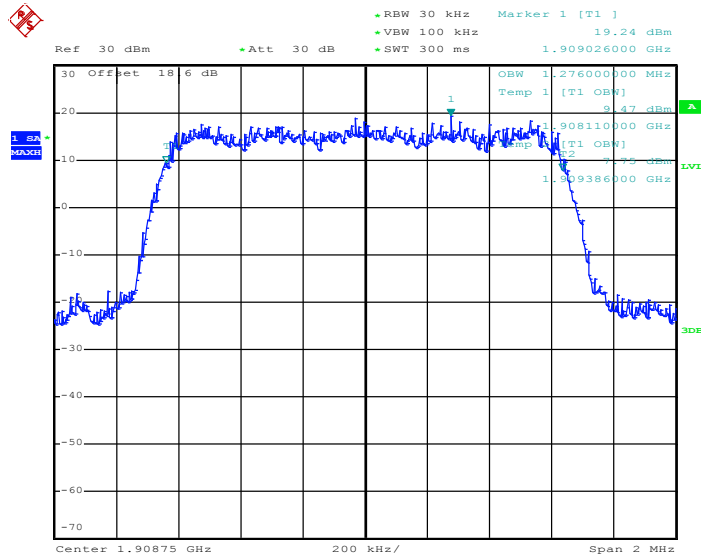

Date: 10.AUG.2014 15:36:02

26dB Bandwidth Plot on Channel 1175 (1908.75 MHz)

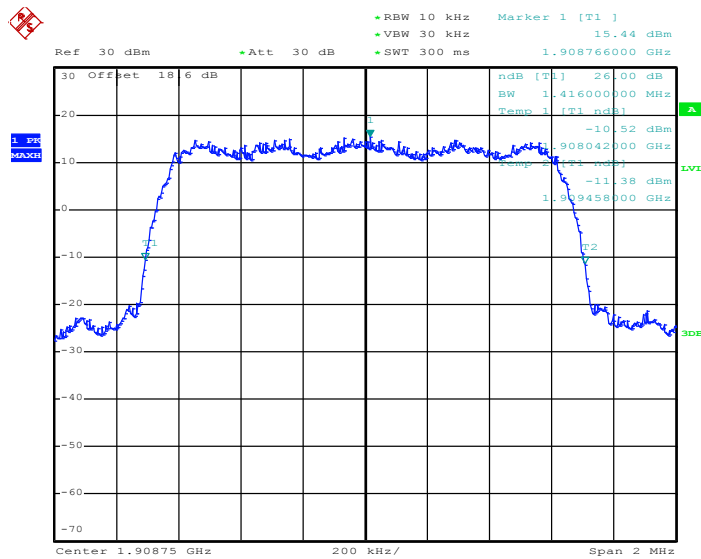

Date: 10.AUG.2014 15:34:06

3.5 Band Edge Measurement

3.5.1 Description of Band Edge Measurement

The power of any emission outside of the authorized operating frequency ranges must be lower than the transmitter power (P) by a factor of at least $43 + 10 \log (P)$ dB.

3.5.2 Measuring Instruments

The measuring equipment is listed in the section 4 of this test report.

3.5.3 Test Procedures

1. The testing follows FCC KDB 971168 v02r02 Section 6.0.
2. The EUT was connected to the spectrum analyzer and system simulator via a power divider.
3. The RF output of EUT was connected to the spectrum analyzer by an RF cable and attenuator. The path loss was compensated to the results for each measurement.
4. The band edges of low and high channels for the highest RF powers were measured.
5. The RF fundamental frequency should be excluded against the limit line in the operating frequency band.
6. The limit line is derived from $43 + 10\log(P)$ dB below the transmitter power P(Watts)
 $= P(W) - [43 + 10\log(P)] \text{ (dB)}$
 $= [30 + 10\log(P)] \text{ (dBm)} - [43 + 10\log(P)] \text{ (dB)}$
 $= -13\text{dBm}.$

3.5.4 Test Setup

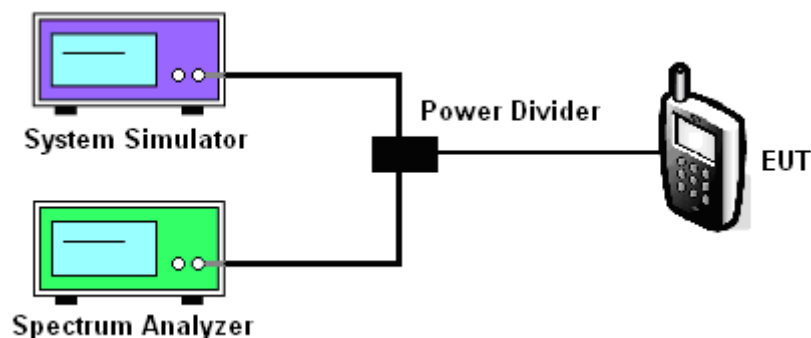



3.5.5 Test Result (Plots) of Conducted Band Edge

Band :	GSM850	Test Mode :	GPRS class 8 Link (GMSK)
--------	--------	-------------	--------------------------

Lower Band Edge Plot on Channel 128 (824.2 MHz)

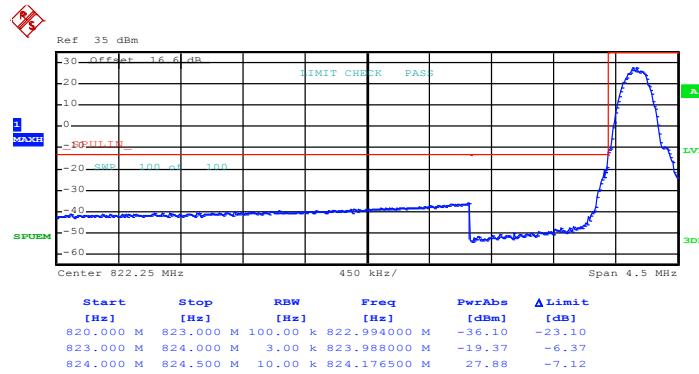

Date: 4.AUG.2014 17:21:14

Higher Band Edge Plot on Channel 251 (848.8 MHz)

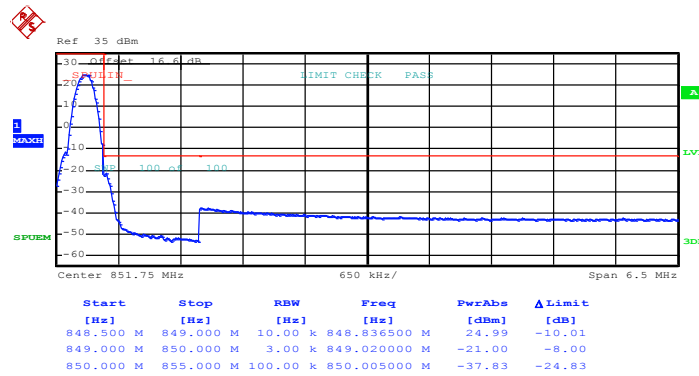

Date: 4.AUG.2014 17:24:47



Band :	GSM850	Test Mode :	EDGE class 8 Link (8PSK)
--------	--------	-------------	--------------------------

Lower Band Edge Plot on Channel 128 (824.2 MHz)

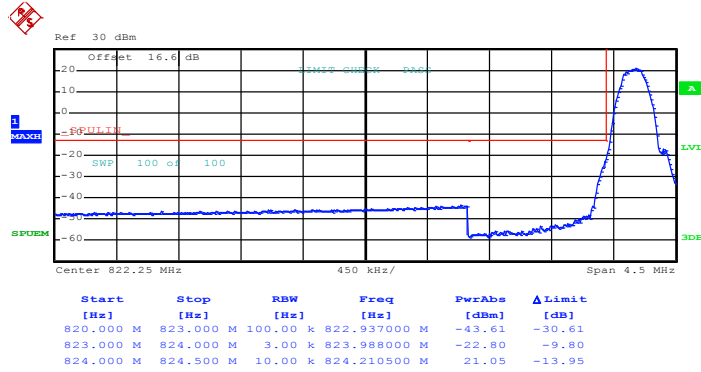

Date: 4.AUG.2014 20:26:48

Higher Band Edge Plot on Channel 251 (848.8 MHz)

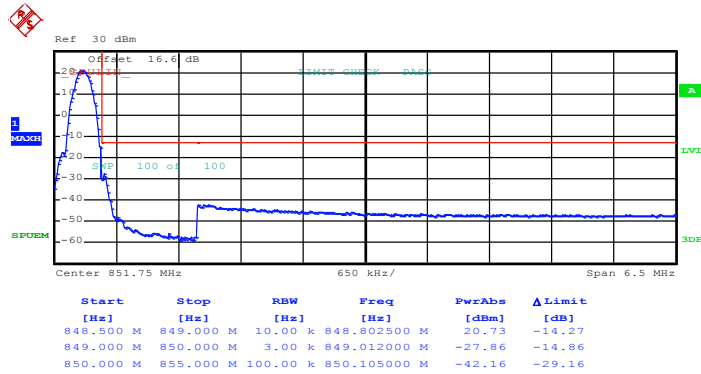

Date: 5.AUG.2014 09:10:36



Band :	GSM1900	Test Mode :	GPRS class 8 Link (GMSK)
--------	---------	-------------	--------------------------

Lower Band Edge Plot on Channel 512 (1850.2 MHz)

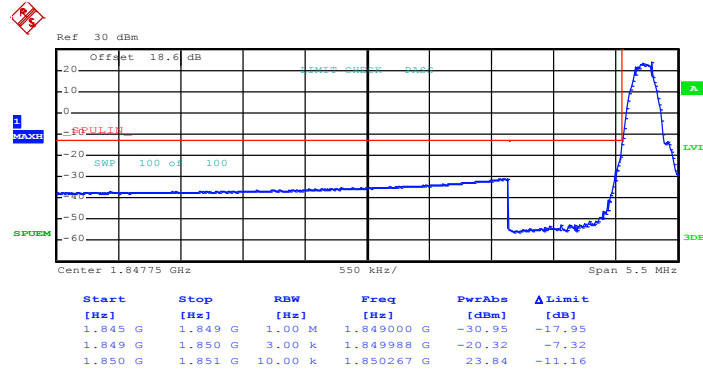

Date: 5.AUG.2014 10:07:50

Higher Band Edge Plot on Channel 810 (1909.8 MHz)

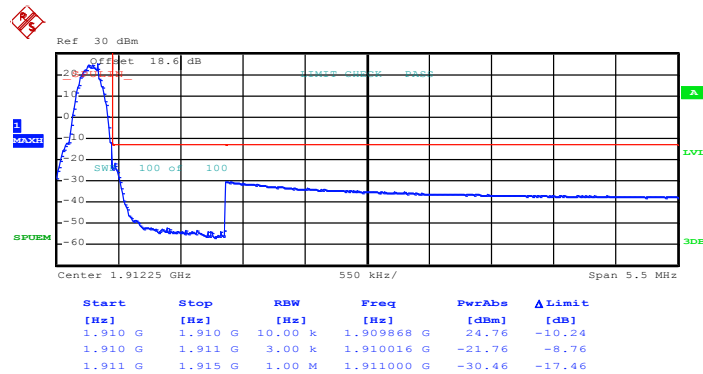

Date: 5.AUG.2014 10:03:24



Band :	GSM1900	Test Mode :	EDGE class 8 Link (8PSK)
--------	---------	-------------	--------------------------

Lower Band Edge Plot on Channel 512 (1850.2 MHz)

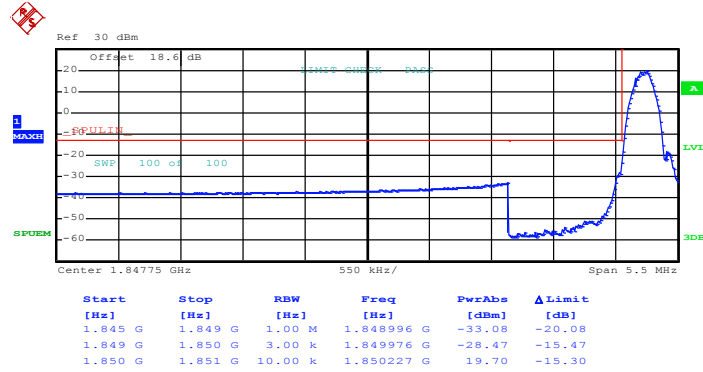

Date: 5.AUG.2014 11:10:32

Higher Band Edge Plot on Channel 810 (1909.8 MHz)

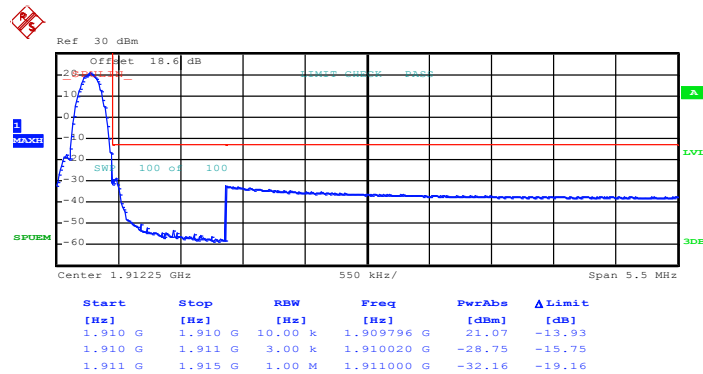

Date: 5.AUG.2014 11:05:23



Band :	WCDMA Band V	Test Mode :	RMC 12.2Kbps Link (QPSK)
--------	--------------	-------------	--------------------------

Lower Band Edge Plot on Channel 4132 (826.4 MHz)

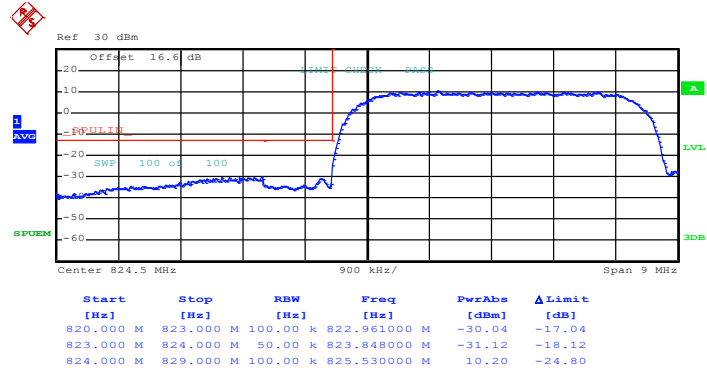

Date: 5.AUG.2014 13:05:19

Higher Band Edge Plot on Channel 4233 (846.6 MHz)

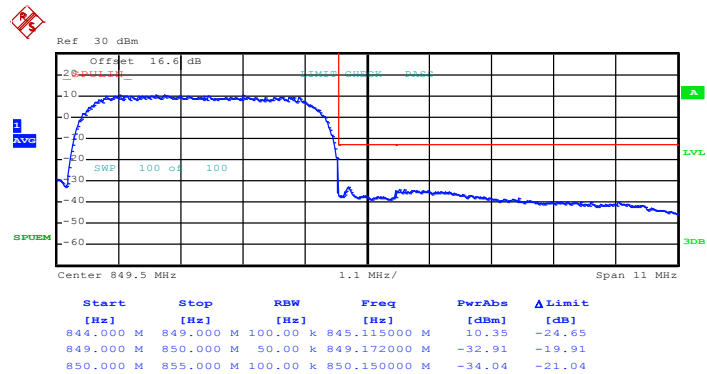

Date: 5.AUG.2014 13:02:28



Band :	WCDMA Band II	Test Mode :	RMC 12.2Kbps Link (QPSK)
---------------	---------------	--------------------	--------------------------

Lower Band Edge Plot on Channel 9262 (1852.4 MHz)

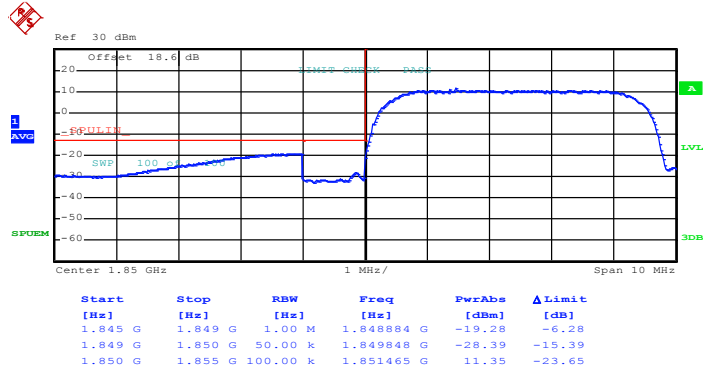

Date: 5.AUG.2014 12:25:34

Higher Band Edge Plot on Channel 9538 (1907.6 MHz)

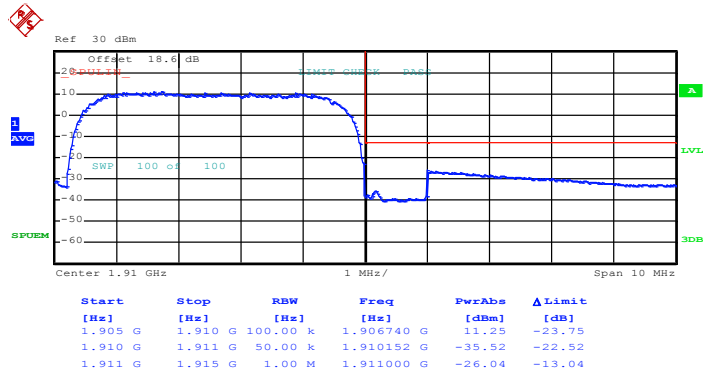

Date: 5.AUG.2014 12:00:45



Band :	CDMA2000 BC0	Test Mode :	1xRTT_RC3+SO32 (QPSK)
--------	--------------	-------------	-----------------------

Lower Band Edge Plot on Channel 1013 (824.7 MHz)

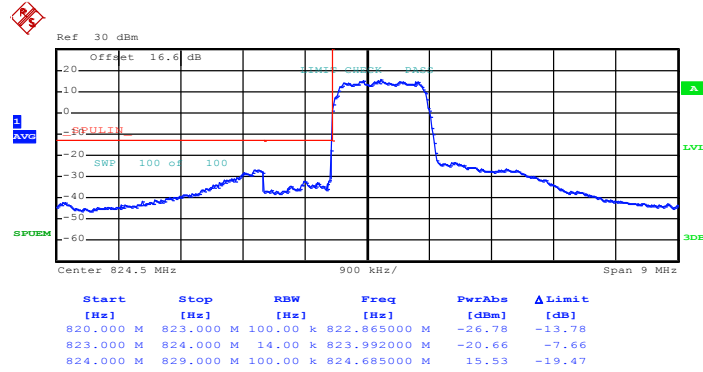

Date: 10.AUG.2014 16:01:38

Higher Band Edge Plot on Channel 777 (848.31 MHz)

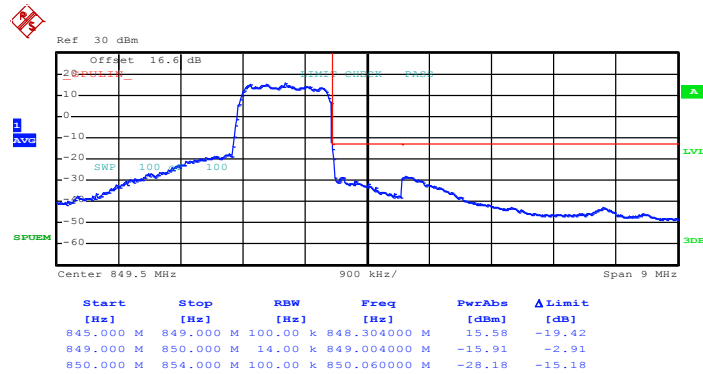

Date: 10.AUG.2014 15:50:17



Band :	CDMA2000 BC1	Test Mode :	1xRTT_RC3+SO32 (QPSK)
---------------	--------------	--------------------	-----------------------

Lower Band Edge Plot on Channel 25 (1851.25 MHz)

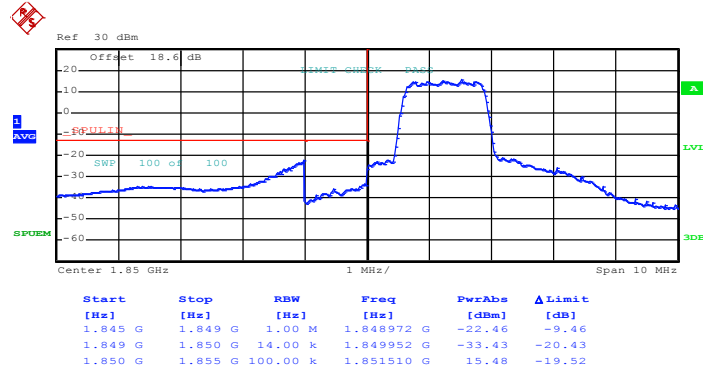

Date: 10.AUG.2014 15:12:41

Higher Band Edge Plot on Channel 1175 (1908.75 MHz)

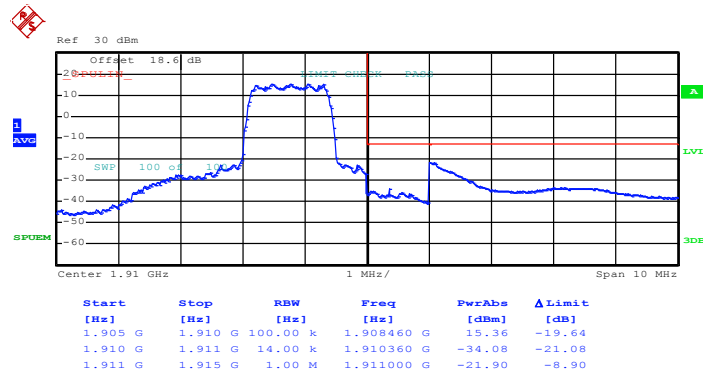

Date: 10.AUG.2014 15:01:59

3.6 Conducted Spurious Emission Measurement

3.6.1 Description of Conducted Spurious Emission Measurement

The power of any emission outside of the authorized operating frequency ranges must be lower than the transmitter power (P) by a factor of at least $43 + 10 \log (P)$ dB.

It is measured by means of a calibrated spectrum analyzer and scanned from 30 MHz up to a frequency including its 10th harmonic.

3.6.2 Measuring Instruments

The measuring equipment is listed in the section 4 of this test report.

3.6.3 Test Procedures

1. The testing follows FCC KDB 971168 v02r02 Section 6.0.
2. The EUT was connected to the spectrum analyzer and system simulator via a power divider.
3. The RF output of EUT was connected to the spectrum analyzer by an RF cable and attenuator. The path loss was compensated to the results for each measurement.
4. The middle channel for the highest RF power within the transmitting frequency was measured.
5. The conducted spurious emission for the whole frequency range was taken.
6. The RF fundamental frequency should be excluded against the limit line in the operating frequency band.
7. The limit line is derived from $43 + 10\log(P)$ dB below the transmitter power P(Watts)
 $= P(W) - [43 + 10\log(P)]$ (dB)
 $= [30 + 10\log(P)]$ (dBm) - $[43 + 10\log(P)]$ (dB)
 $= -13\text{dBm}$.

3.6.4 Test Setup

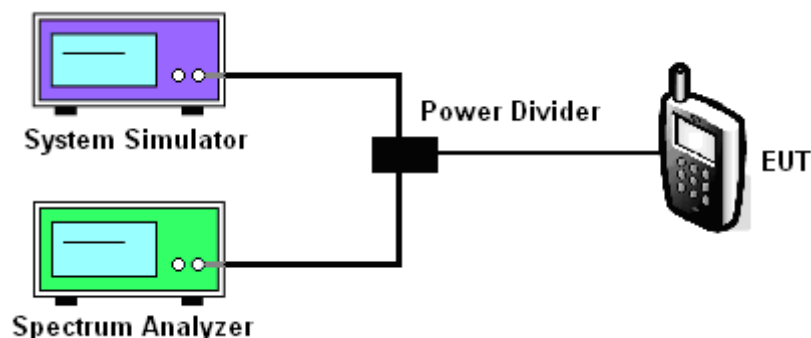



3.6.5 Test Result (Plots) of Conducted Spurious Emission

Band :	GSM850	Channel :	CH128
Test Mode :	GPRS class 8 Link (GMSK)	Frequency :	824.2 MHz

Conducted Spurious Emission Plot between 30MHz ~ 1GHz

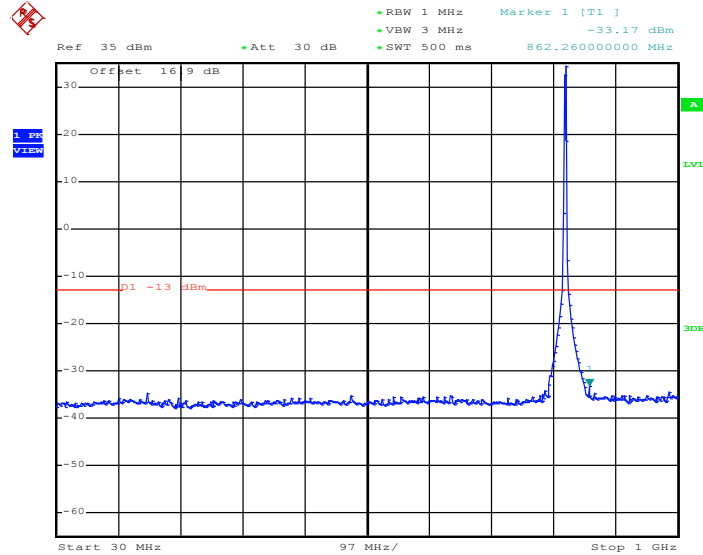

Date: 4.AUG.2014 19:52:15

Conducted Spurious Emission Plot between 1GHz ~ 3GHz

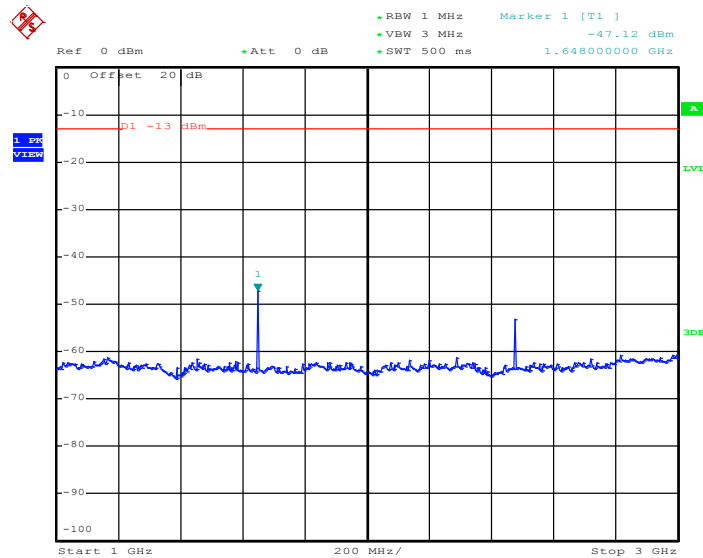

Date: 4.AUG.2014 19:53:02



Conducted Spurious Emission Plot between 3GHz ~ 7GHz

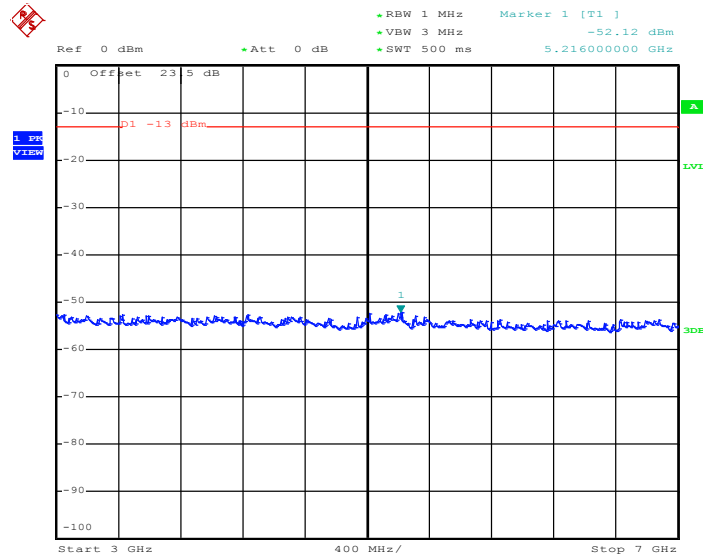

Date: 4.AUG.2014 19:53:11

Conducted Spurious Emission Plot between 7GHz ~ 9GHz

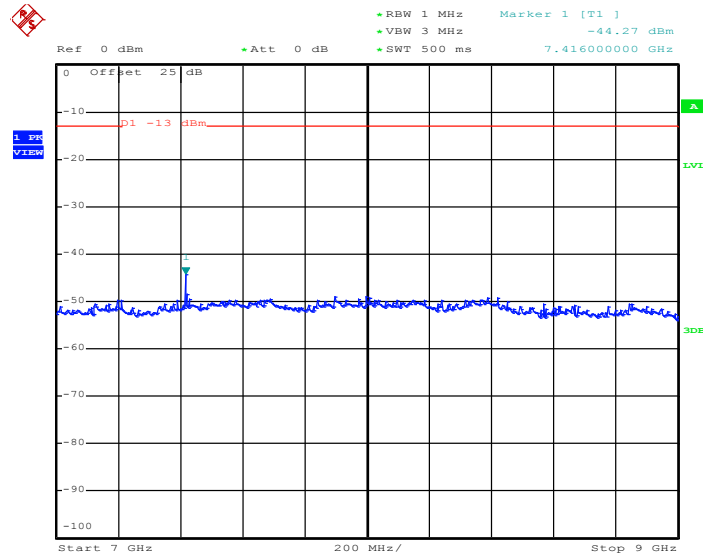

Date: 4.AUG.2014 19:53:19



Band :	GSM850	Channel :	CH189
Test Mode :	GPRS class 8 Link (GMSK)	Frequency :	836.4 MHz

Conducted Spurious Emission Plot between 30MHz ~ 1GHz

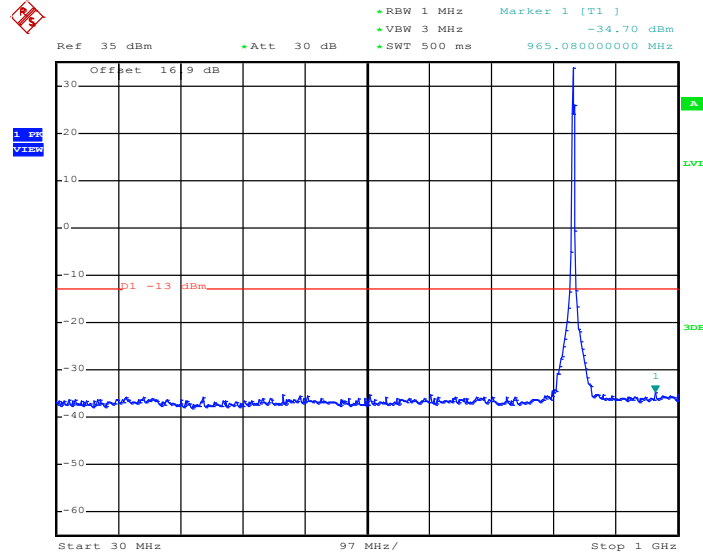

Date: 4.AUG.2014 19:56:01

Conducted Spurious Emission Plot between 1GHz ~ 3GHz

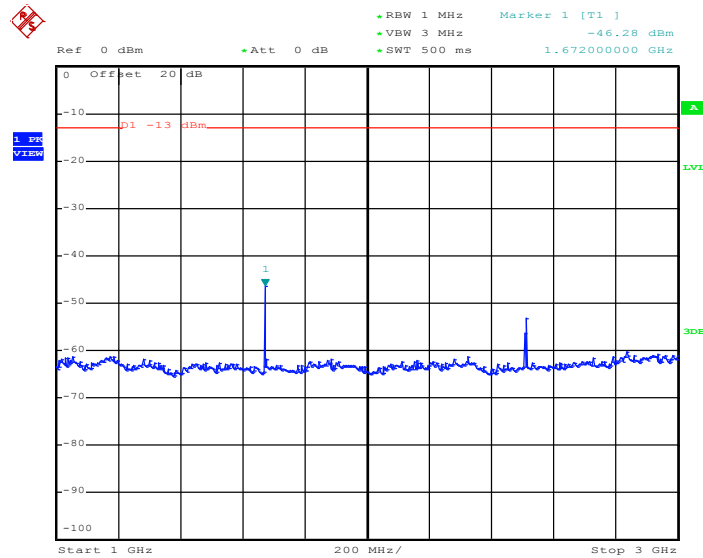

Date: 4.AUG.2014 19:55:50



Conducted Spurious Emission Plot between 3GHz ~ 7GHz

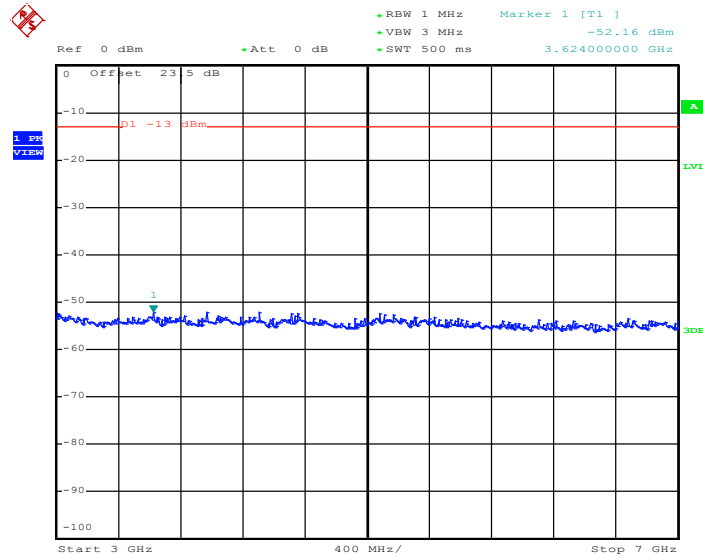

Date: 4.AUG.2014 19:55:59

Conducted Spurious Emission Plot between 7GHz ~ 9GHz

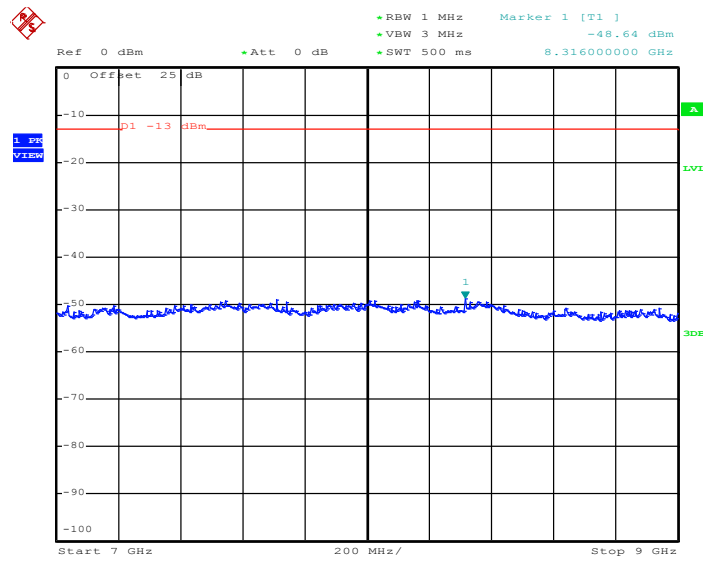

Date: 4.AUG.2014 19:56:07



Band :	GSM850	Channel :	CH251
Test Mode :	GPRS class 8 Link (GMSK)	Frequency :	848.8 MHz

Conducted Spurious Emission Plot between 30MHz ~ 1GHz

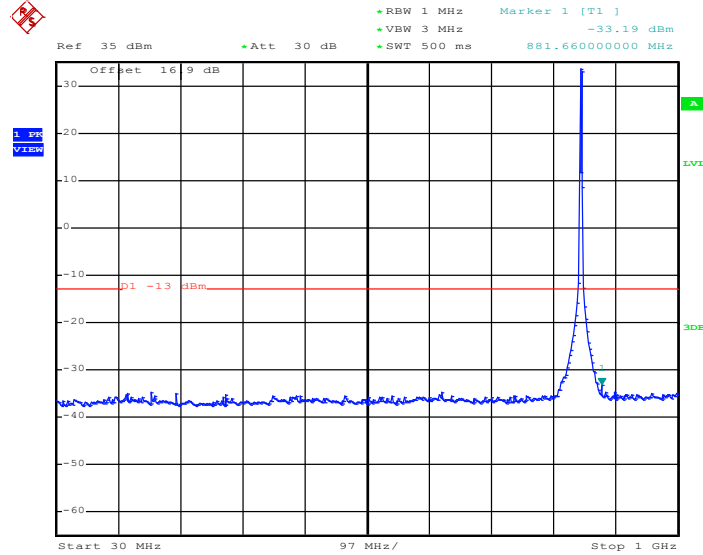

Date: 4.AUG.2014 19:59:21

Conducted Spurious Emission Plot between 1GHz ~ 3GHz

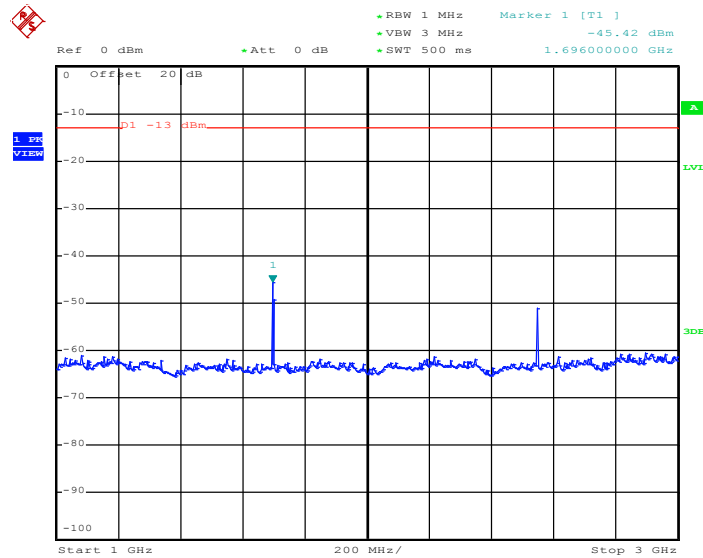

Date: 4.AUG.2014 19:59:57



Conducted Spurious Emission Plot between 3GHz ~ 7GHz

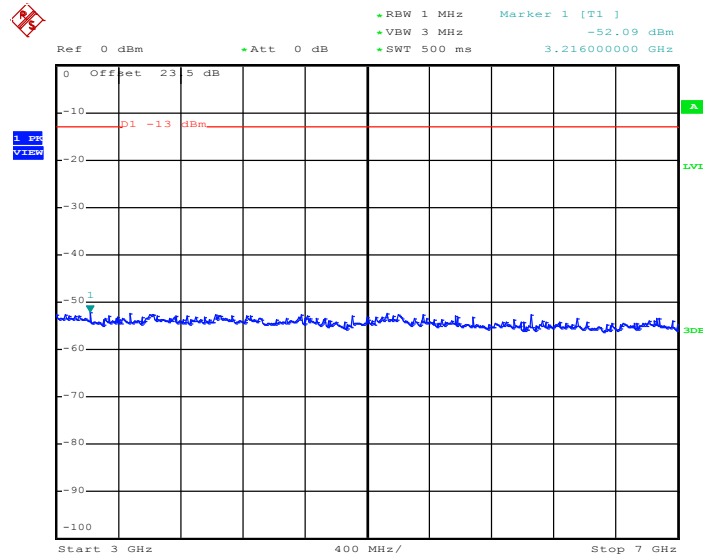

Date: 4.AUG.2014 20:00:06

Conducted Spurious Emission Plot between 7GHz ~ 9GHz

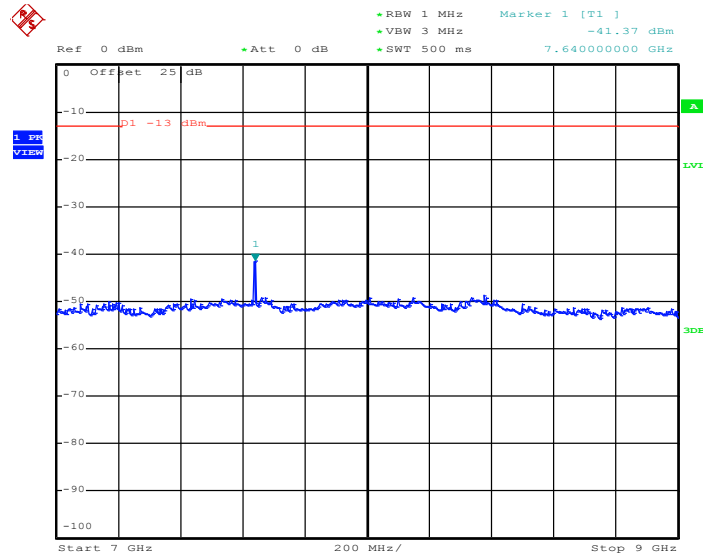

Date: 4.AUG.2014 20:00:14



Band :	GSM850	Channel :	CH128
Test Mode :	EDGE class 8 Link (8PSK)	Frequency :	824.2 MHz

Conducted Spurious Emission Plot between 30MHz ~ 1GHz

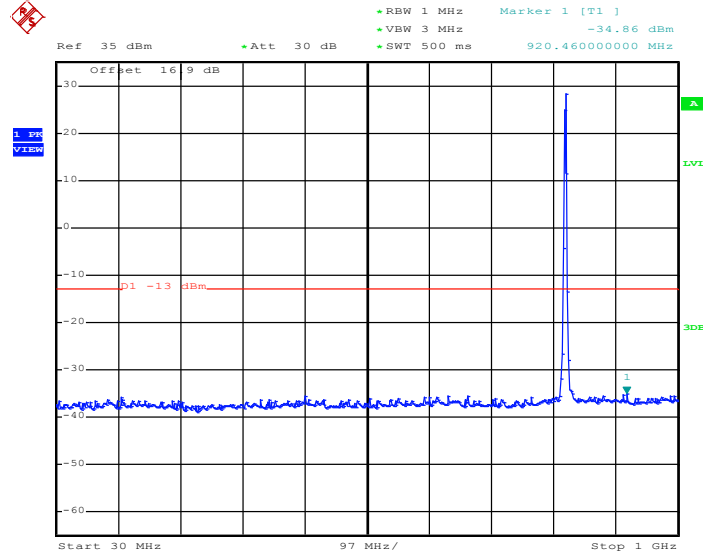

Date: 5.AUG.2014 09:39:38

Conducted Spurious Emission Plot between 1GHz ~ 3GHz

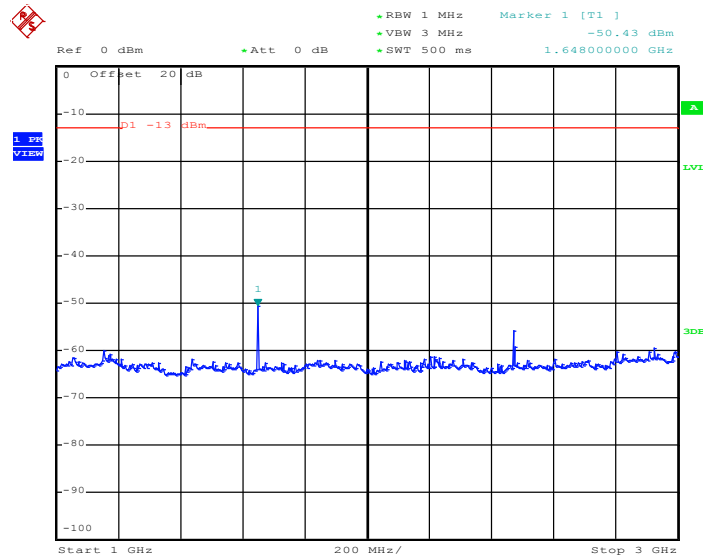

Date: 5.AUG.2014 09:39:50



Conducted Spurious Emission Plot between 3GHz ~ 7GHz

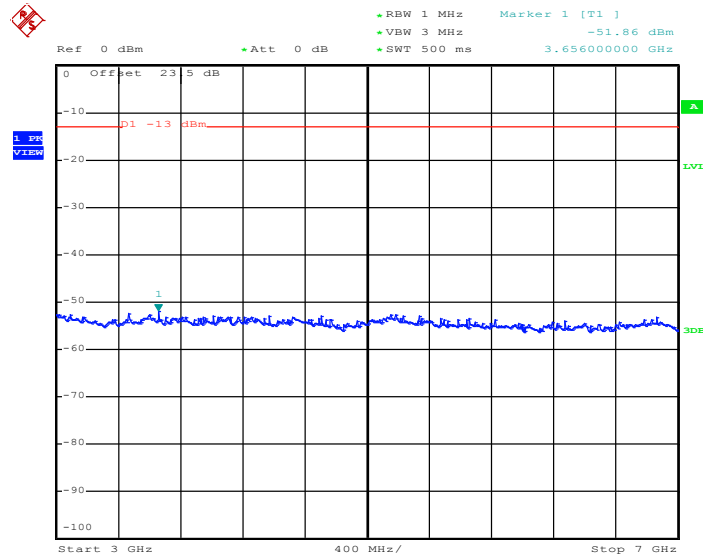

Date: 5.AUG.2014 09:39:58

Conducted Spurious Emission Plot between 7GHz ~ 9GHz

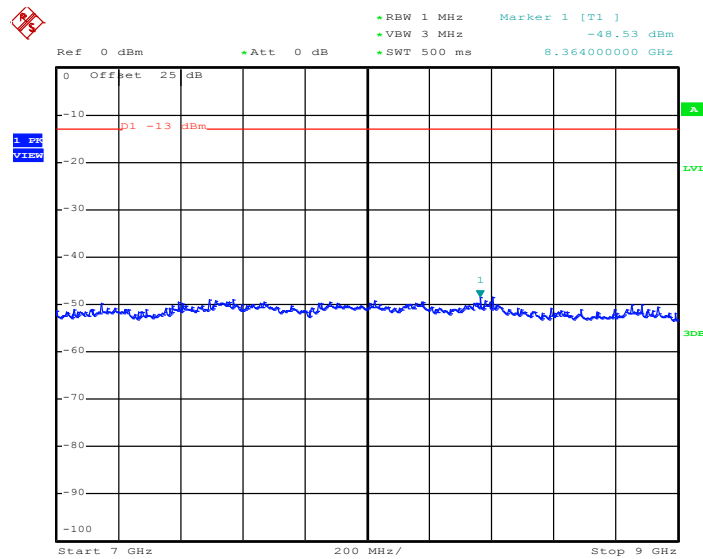

Date: 5.AUG.2014 09:40:07



Band :	GSM850	Channel :	CH189
Test Mode :	EDGE class 8 Link (8PSK)	Frequency :	836.4 MHz

Conducted Spurious Emission Plot between 30MHz ~ 1GHz

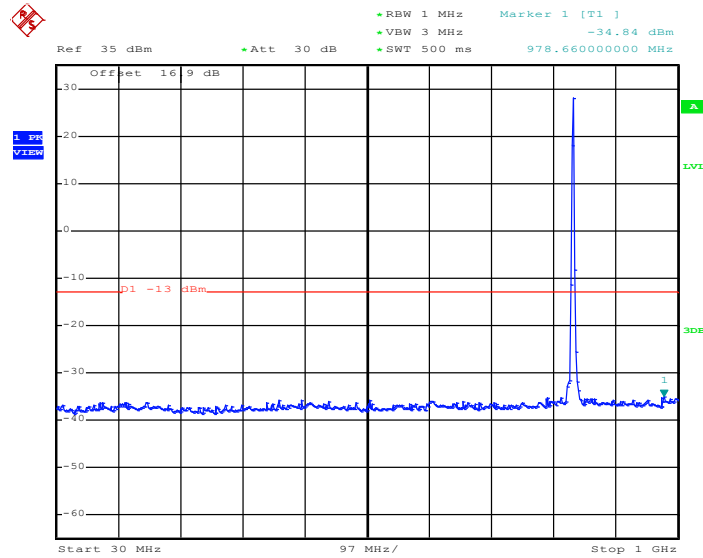

Date: 5.AUG.2014 09:40:58

Conducted Spurious Emission Plot between 1GHz ~ 3GHz

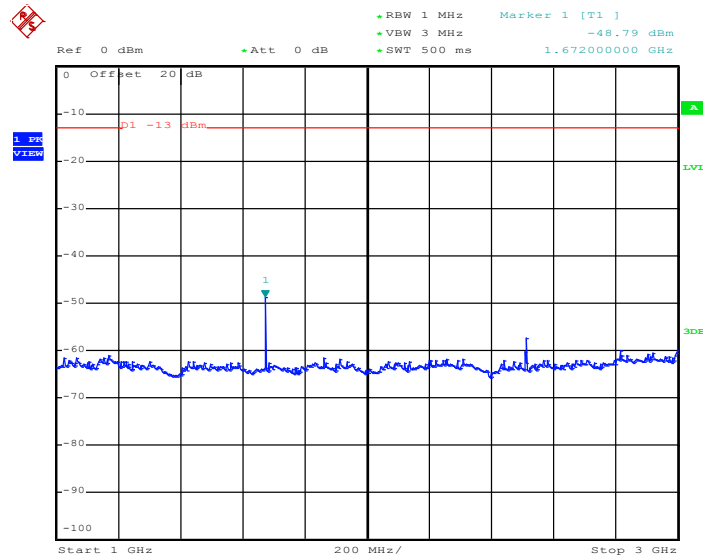

Date: 5.AUG.2014 09:41:10



Conducted Spurious Emission Plot between 3GHz ~ 7GHz

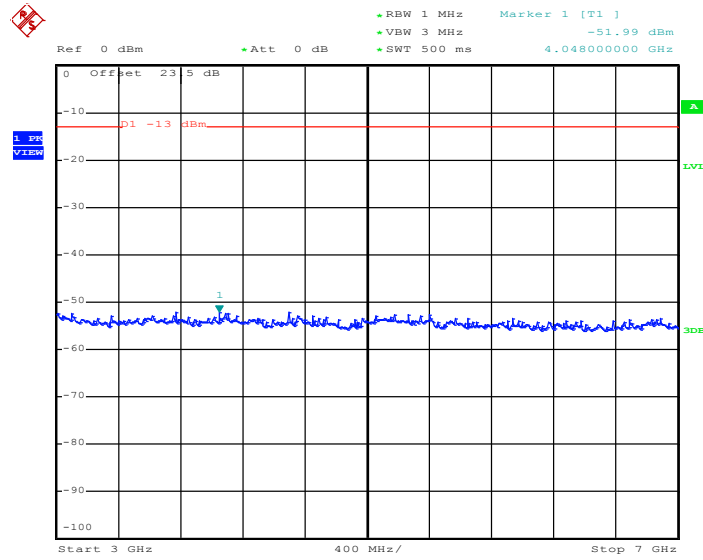

Date: 5.AUG.2014 09:41:18

Conducted Spurious Emission Plot between 7GHz ~ 9GHz

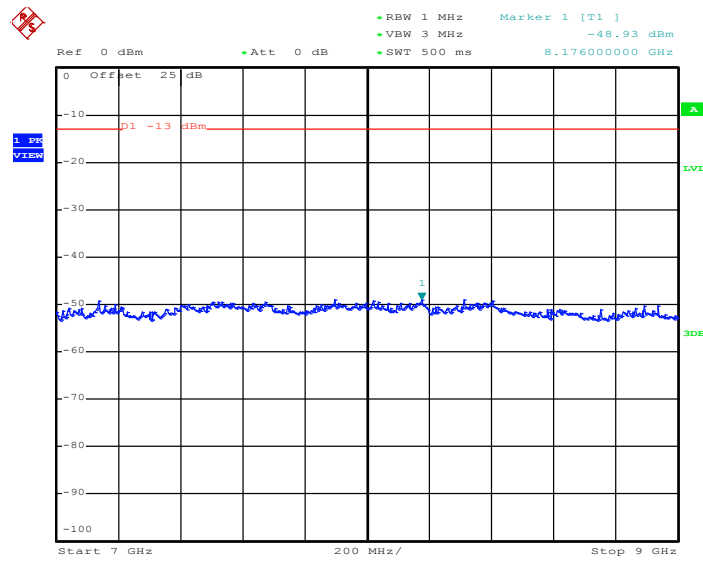

Date: 5.AUG.2014 09:41:26



Band :	GSM850	Channel :	CH251
Test Mode :	EDGE class 8 Link (8PSK)	Frequency :	848.8 MHz

Conducted Spurious Emission Plot between 30MHz ~ 1GHz

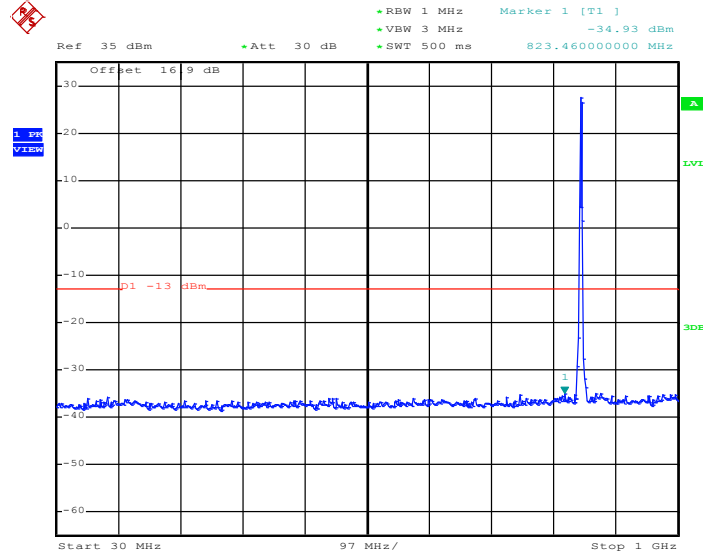

Date: 5.AUG.2014 09:46:43

Conducted Spurious Emission Plot between 1GHz ~ 3GHz

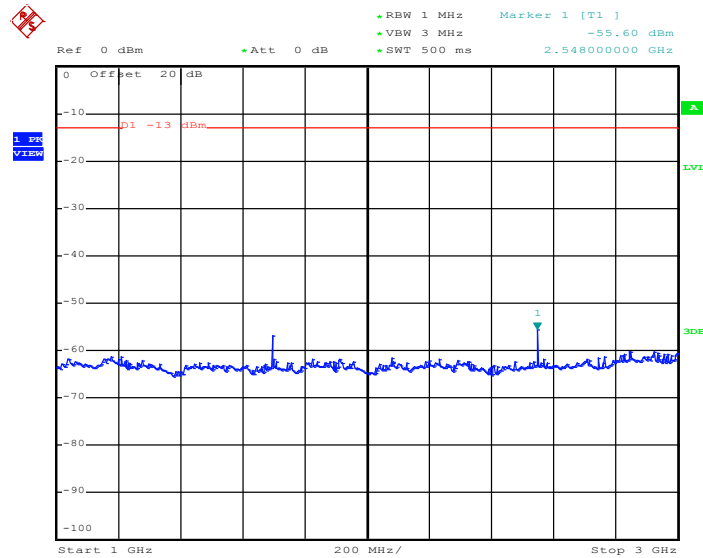

Date: 5.AUG.2014 09:46:54



Conducted Spurious Emission Plot between 3GHz ~ 7GHz

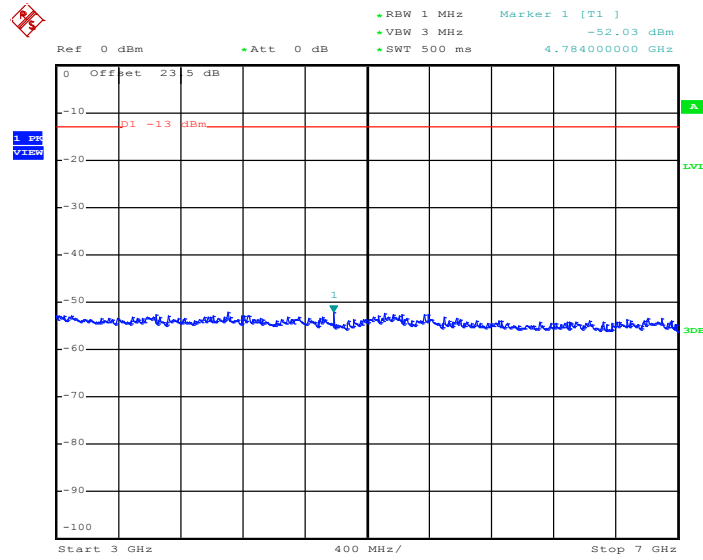

Date: 5.AUG.2014 09:47:02

Conducted Spurious Emission Plot between 7GHz ~ 9GHz

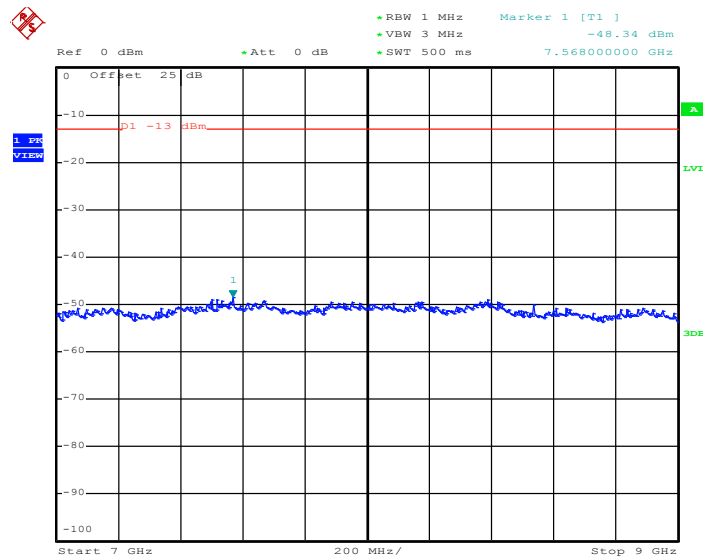

Date: 5.AUG.2014 09:47:10



Band :	GSM1900	Channel :	CH512
Test Mode :	GPRS class 8 Link (GMSK)	Frequency :	11850.2 MHz

Conducted Spurious Emission Plot between 30MHz ~ 1GHz

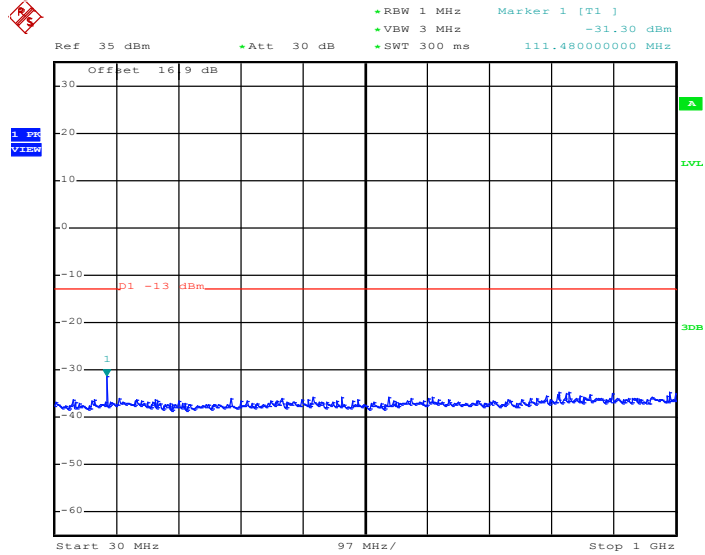

Date: 5.AUG.2014 10:40:36

Conducted Spurious Emission Plot between 1GHz ~ 3GHz

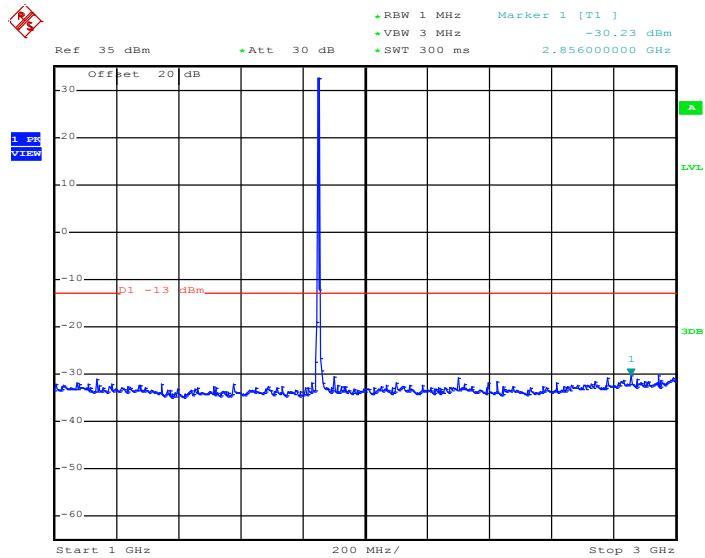

Date: 5.AUG.2014 10:40:44



Conducted Spurious Emission Plot between 3GHz ~ 7GHz

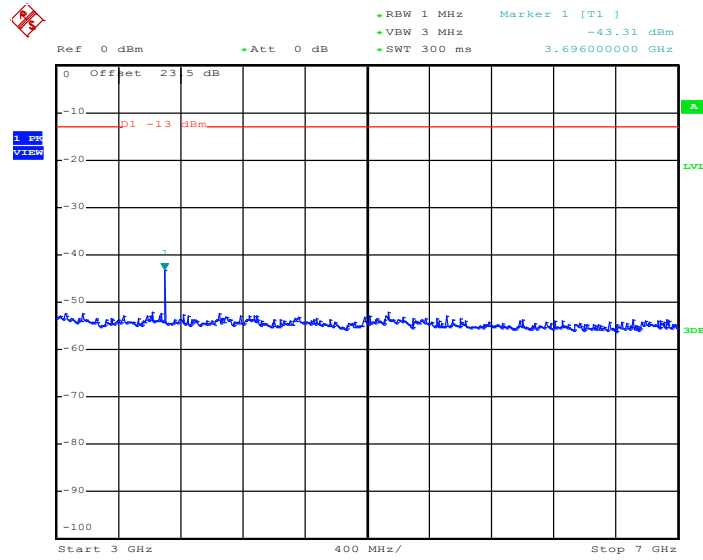

Date: 5.AUG.2014 10:40:54

Conducted Spurious Emission Plot between 7GHz ~ 13.6GHz

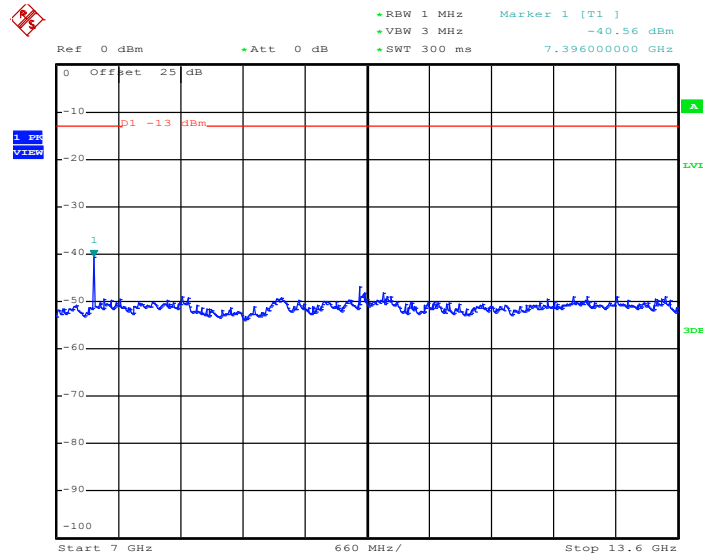

Date: 5.AUG.2014 10:41:03



Conducted Spurious Emission Plot between 13.6GHz ~ 19.1GHz

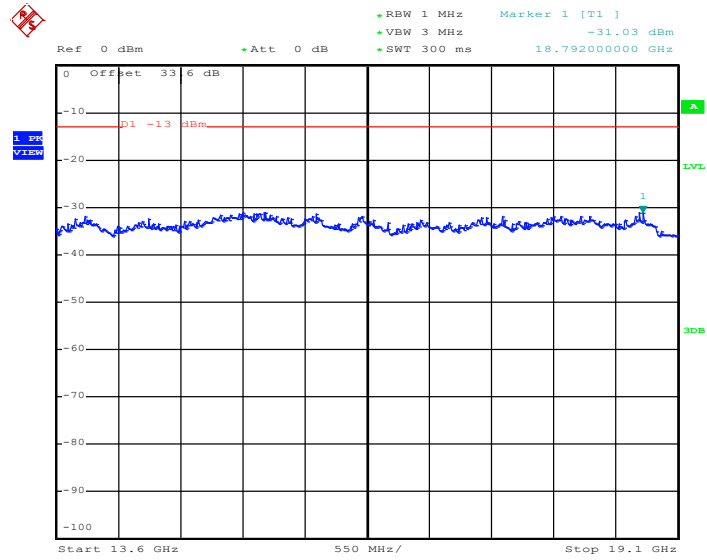

Date: 5.AUG.2014 10:41:11



Band :	GSM1900	Channel :	CH661
Test Mode :	GPRS class 8 Link (GMSK)	Frequency :	1880.0 MHz

Conducted Spurious Emission Plot between 30MHz ~ 1GHz

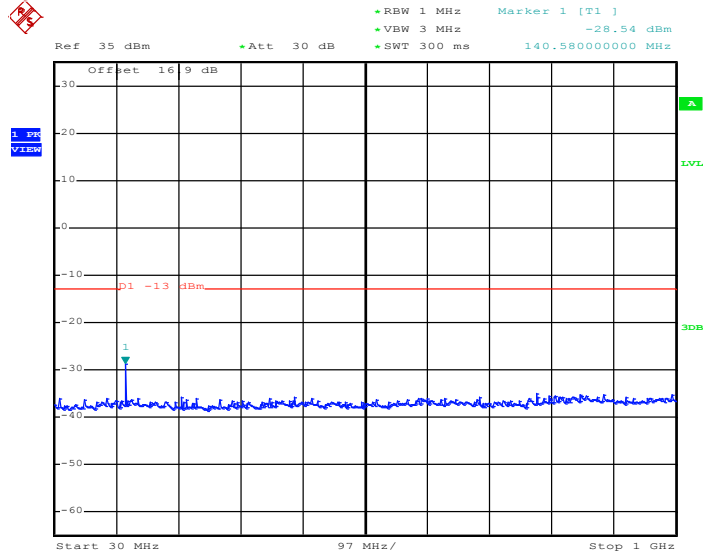

Date: 5.AUG.2014 10:35:54

Conducted Spurious Emission Plot between 1GHz ~ 3GHz

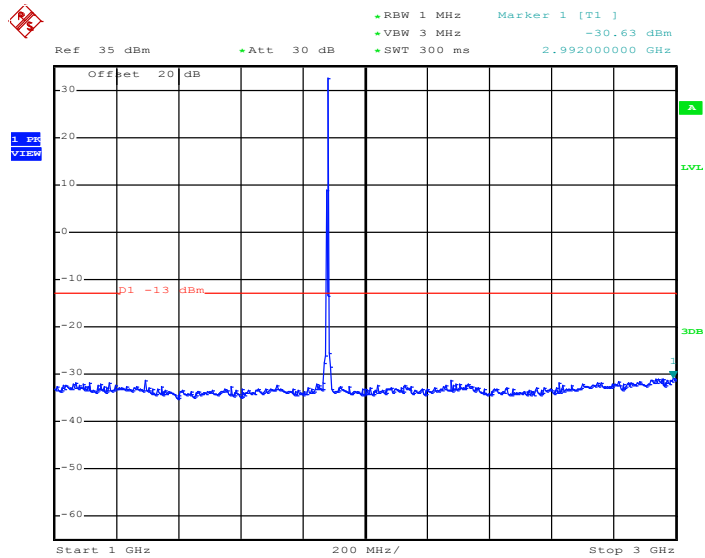

Date: 5.AUG.2014 10:36:02



Conducted Spurious Emission Plot between 3GHz ~ 7GHz

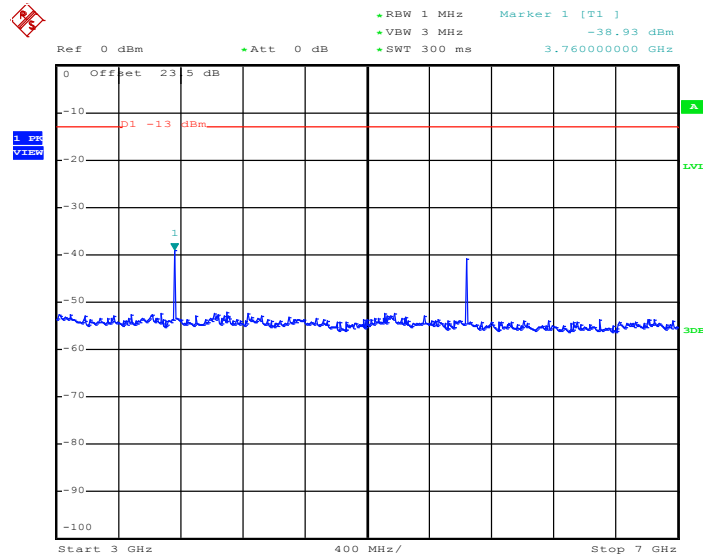

Date: 5.AUG.2014 10:36:13

Conducted Spurious Emission Plot between 7GHz ~ 13.6GHz

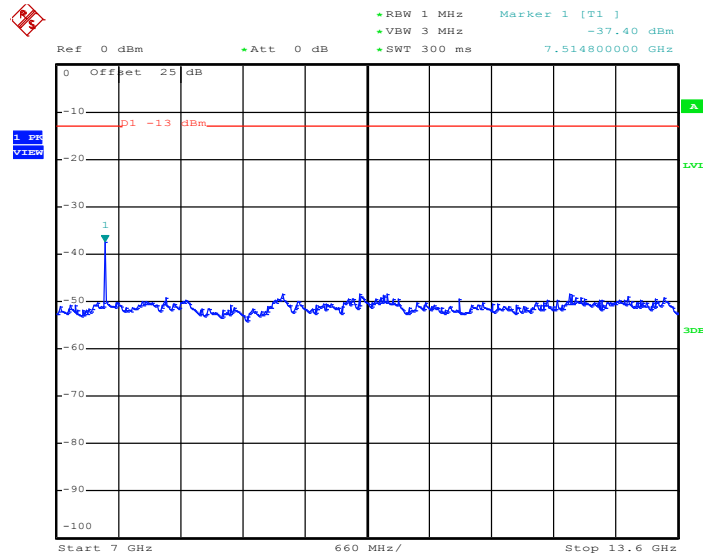

Date: 5.AUG.2014 10:36:21



Conducted Spurious Emission Plot between 13.6GHz ~ 19.1GHz

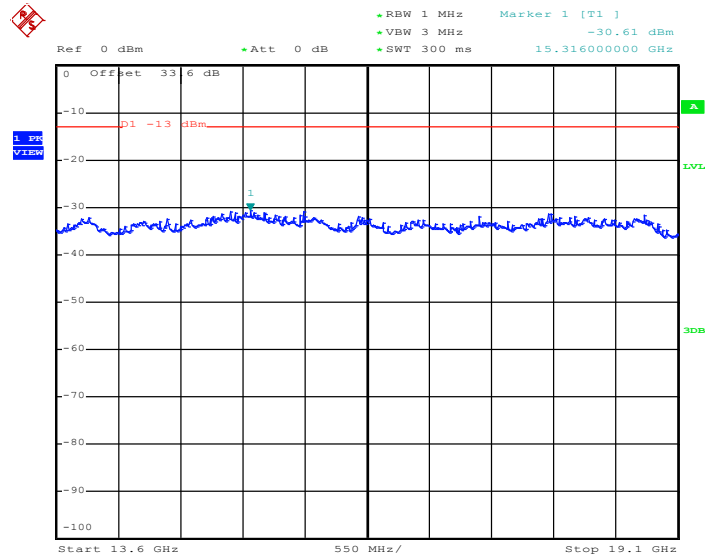

Date: 5.AUG.2014 10:36:30



Band :	GSM1900	Channel :	CH810
Test Mode :	GPRS class 8 Link (GMSK)	Frequency :	1909.8 MHz

Conducted Spurious Emission Plot between 30MHz ~ 1GHz

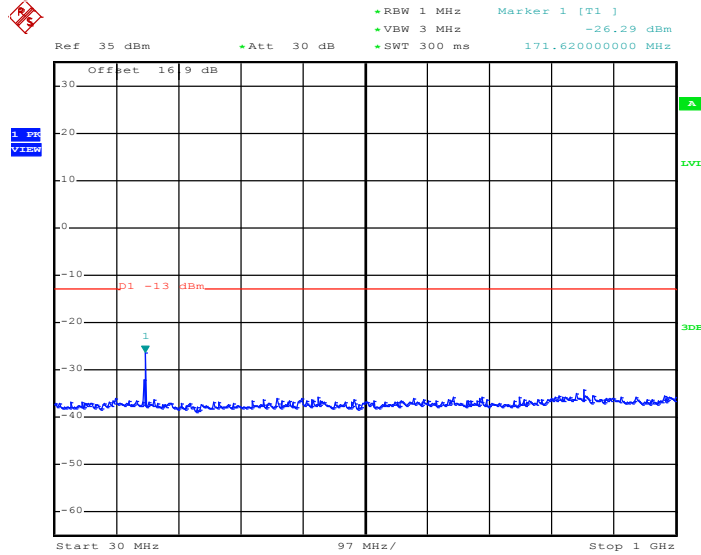

Date: 5.AUG.2014 10:44:38

Conducted Spurious Emission Plot between 1GHz ~ 3GHz

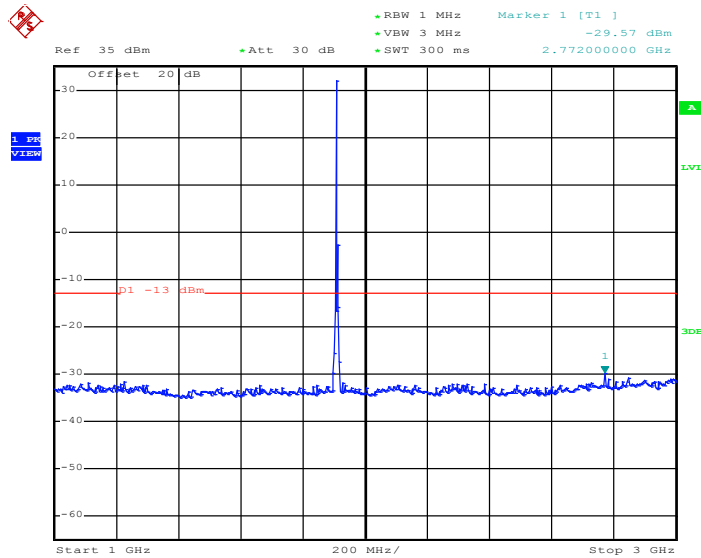

Date: 5.AUG.2014 10:44:47



Conducted Spurious Emission Plot between 3GHz ~ 7GHz

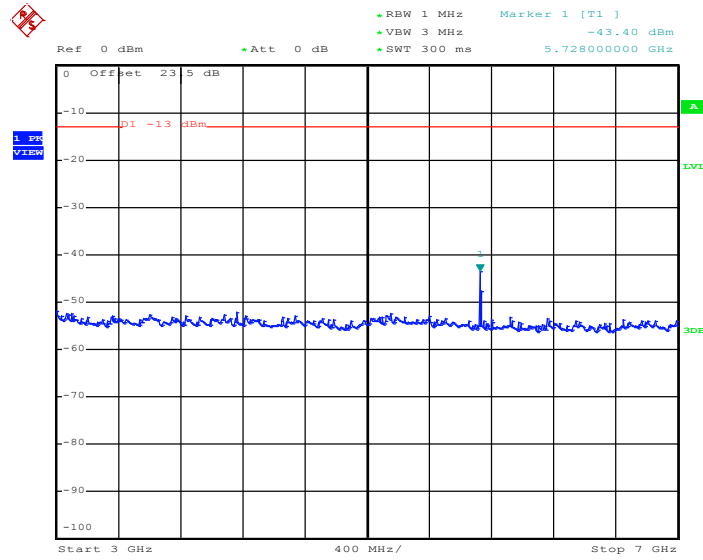

Date: 5.AUG.2014 10:44:57

Conducted Spurious Emission Plot between 7GHz ~ 13.6GHz

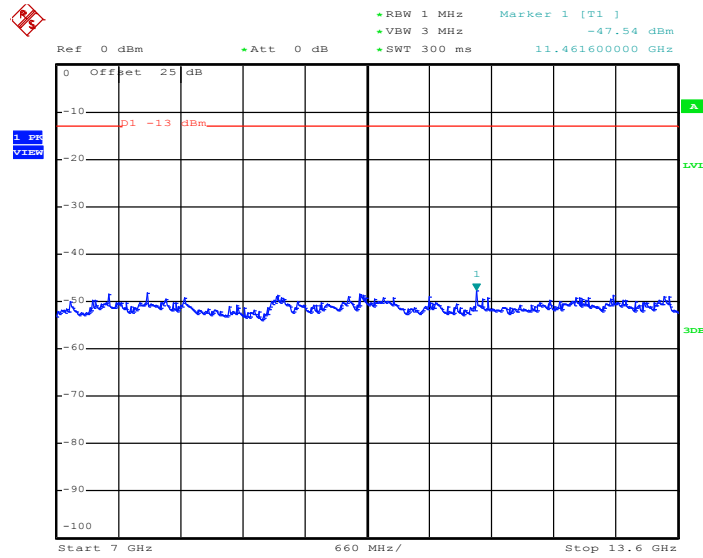

Date: 5.AUG.2014 10:45:05



Conducted Spurious Emission Plot between 13.6GHz ~ 19.1GHz

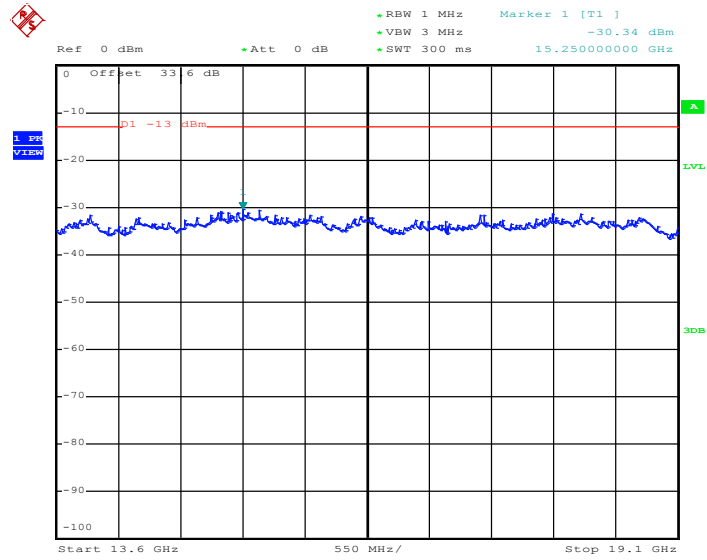

Date: 5.AUG.2014 10:45:14



Band :	GSM1900	Channel :	CH512
Test Mode :	EDGE class 8 Link (GMSK)	Frequency :	1850.2 MHz

Conducted Spurious Emission Plot between 30MHz ~ 1GHz

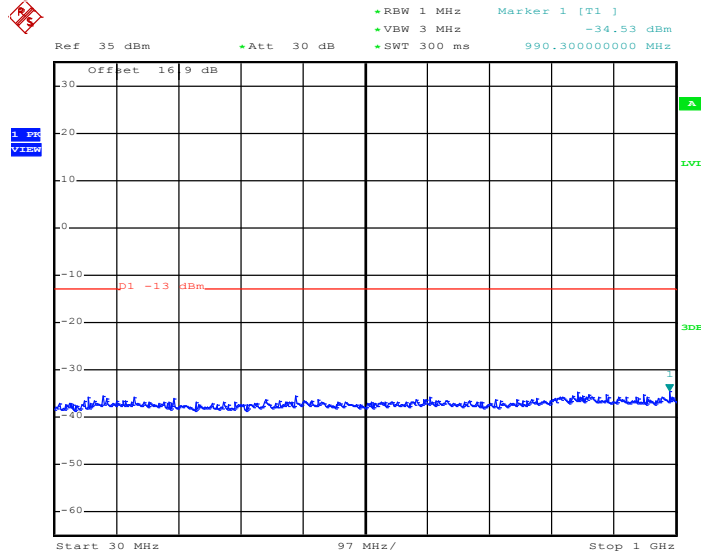

Date: 5.AUG.2014 11:21:09

Conducted Spurious Emission Plot between 1GHz ~ 3GHz

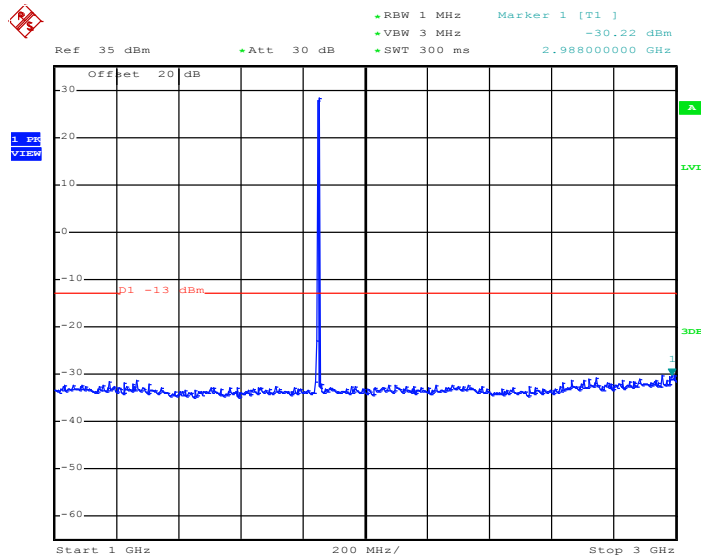

Date: 5.AUG.2014 11:21:17



Conducted Spurious Emission Plot between 3GHz ~ 7GHz

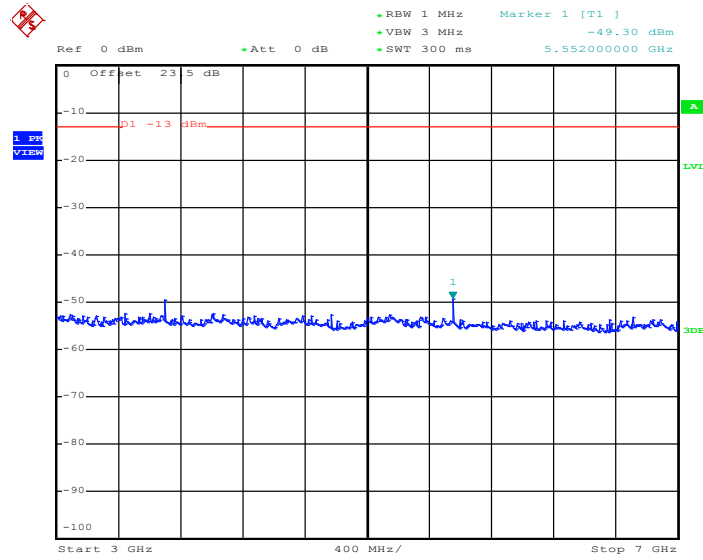

Date: 5.AUG.2014 11:21:28

Conducted Spurious Emission Plot between 7GHz ~ 13.6GHz

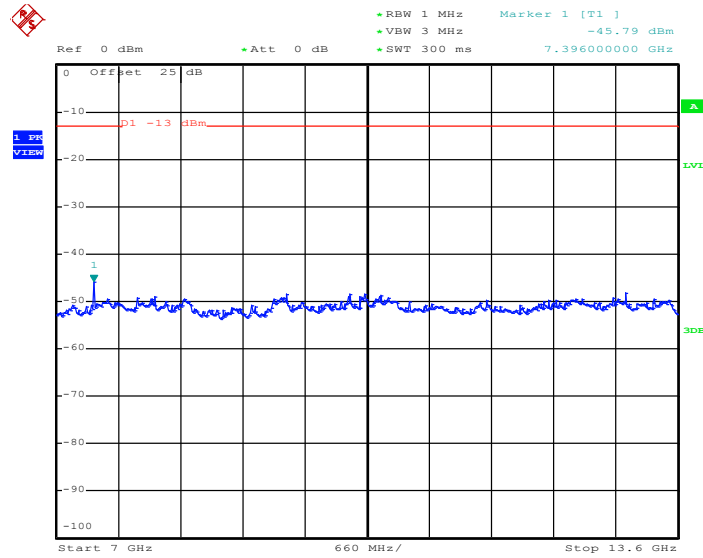

Date: 5.AUG.2014 11:21:36



Conducted Spurious Emission Plot between 13.6GHz ~ 19.1GHz

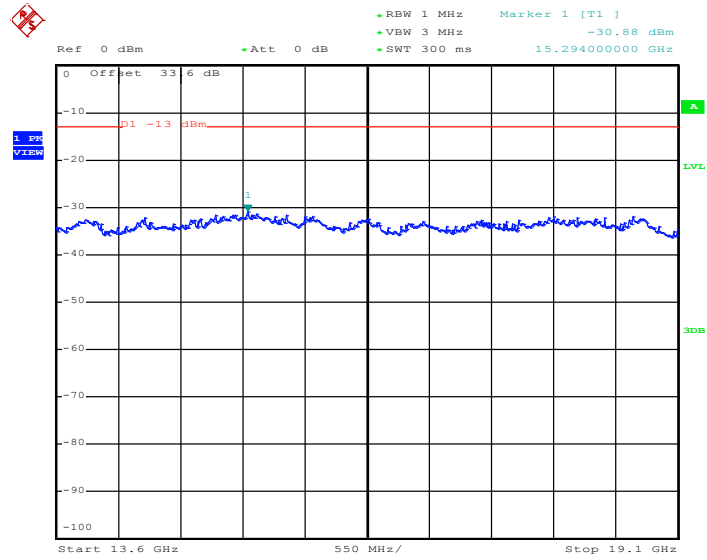

Date: 5.AUG.2014 11:21:44



Band :	GSM1900	Channel :	CH661
Test Mode :	GPRS class 8 Link (GMSK)	Frequency :	1880.0 MHz

Conducted Spurious Emission Plot between 30MHz ~ 1GHz

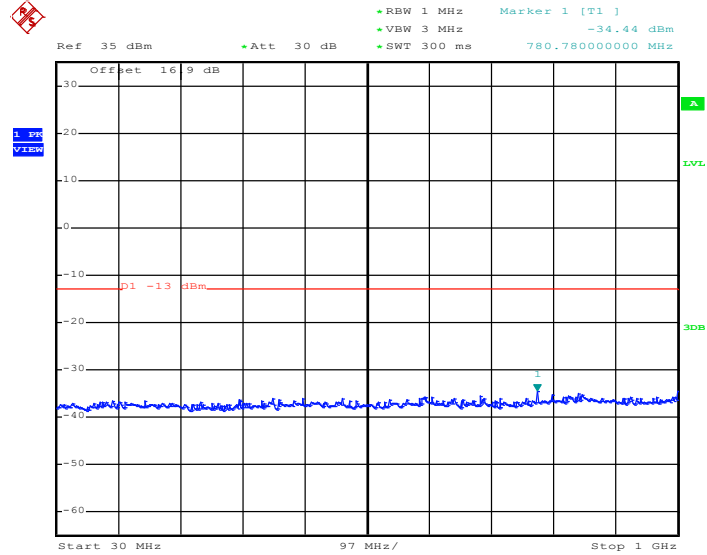

Date: 5.AUG.2014 11:23:23

Conducted Spurious Emission Plot between 1GHz ~ 3GHz

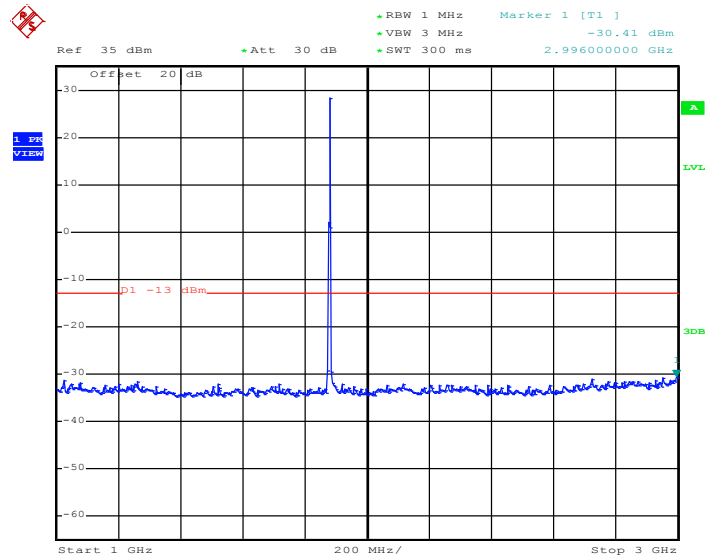

Date: 5.AUG.2014 11:23:32



Conducted Spurious Emission Plot between 3GHz ~ 7GHz

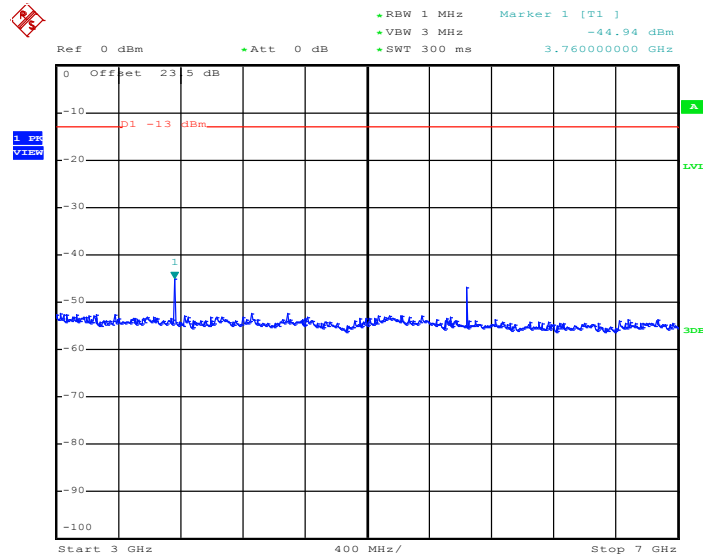

Date: 5.AUG.2014 11:23:44

Conducted Spurious Emission Plot between 7GHz ~ 13.6GHz

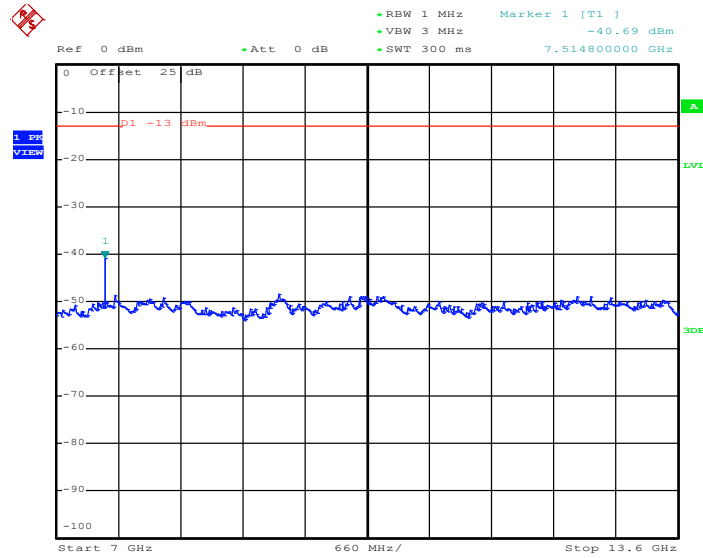

Date: 5.AUG.2014 11:23:52



Conducted Spurious Emission Plot between 13.6GHz ~ 19.1GHz

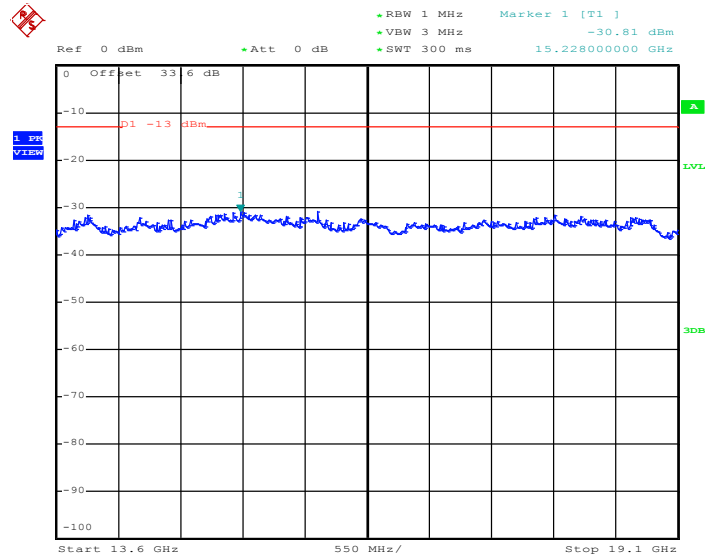

Date: 5.AUG.2014 11:24:00



Band :	GSM1900	Channel :	CH810
Test Mode :	GPRS class 8 Link (GMSK)	Frequency :	1909.8 MHz

Conducted Spurious Emission Plot between 30MHz ~ 1GHz

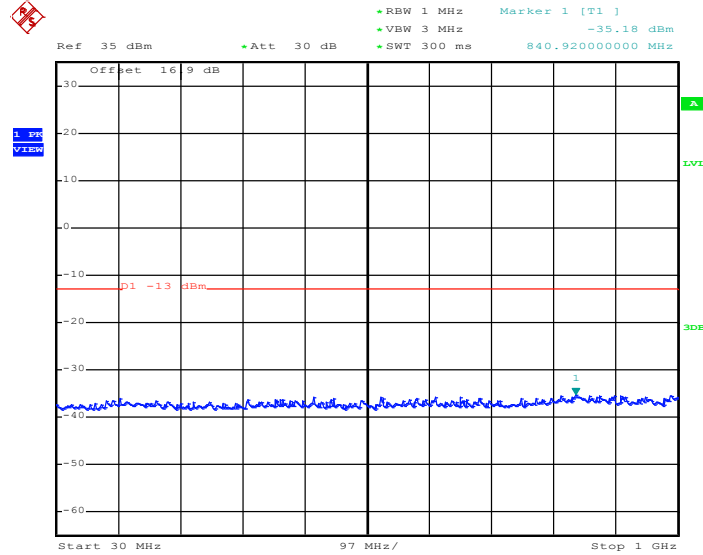

Date: 5.AUG.2014 11:25:49

Conducted Spurious Emission Plot between 1GHz ~ 3GHz

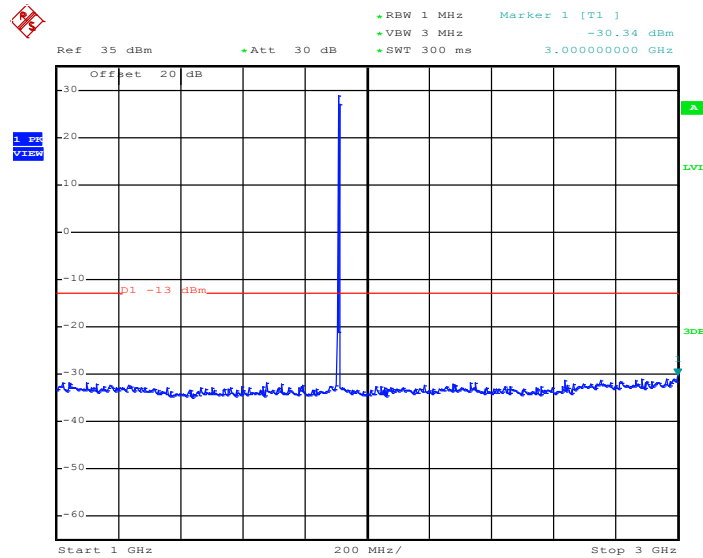

Date: 5.AUG.2014 11:25:58



Conducted Spurious Emission Plot between 3GHz ~ 7GHz

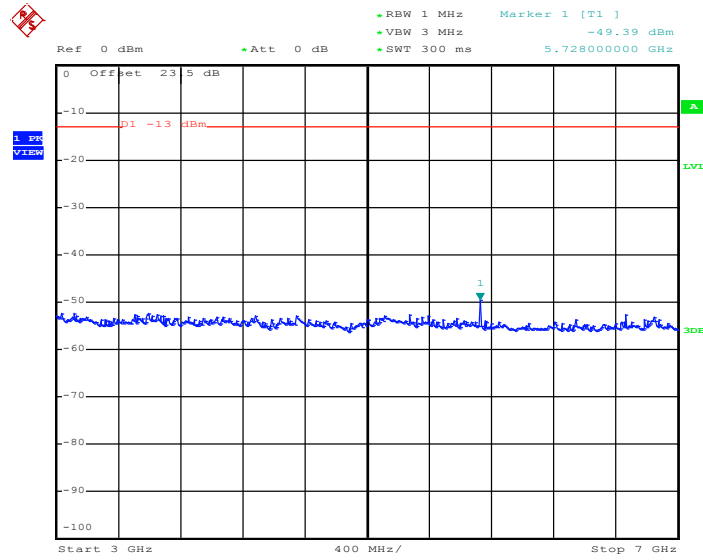

Date: 5.AUG.2014 11:26:08

Conducted Spurious Emission Plot between 7GHz ~ 13.6GHz

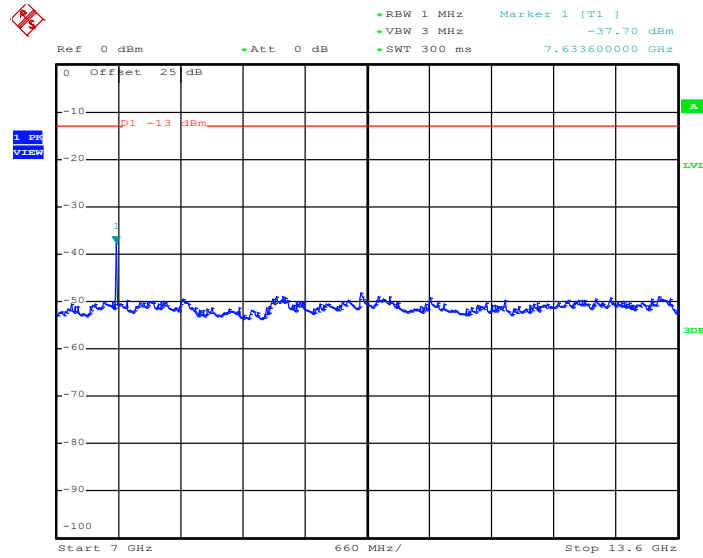

Date: 5.AUG.2014 11:26:17



Conducted Spurious Emission Plot between 13.6GHz ~ 19.1GHz

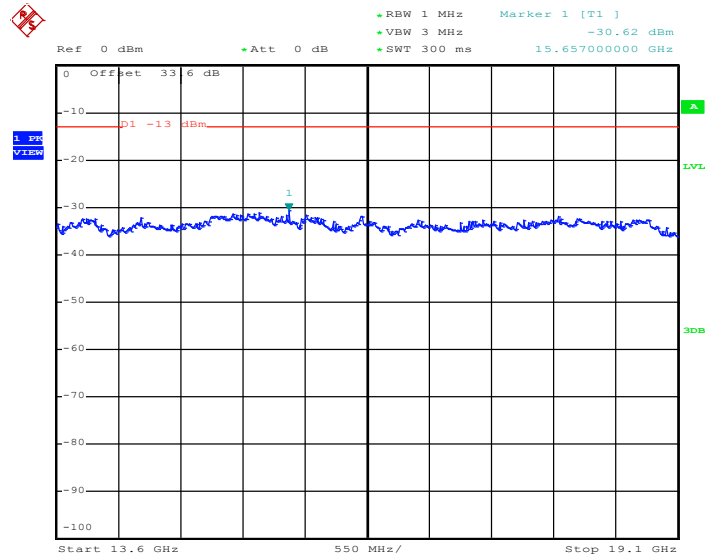

Date: 5.AUG.2014 11:26:25



Band :	WCDMA Band V	Channel :	CH4132
Test Mode :	RMC 12.2Kbps Link (QPSK)	Frequency :	826.4 MHz

Conducted Spurious Emission Plot between 30MHz ~ 1GHz

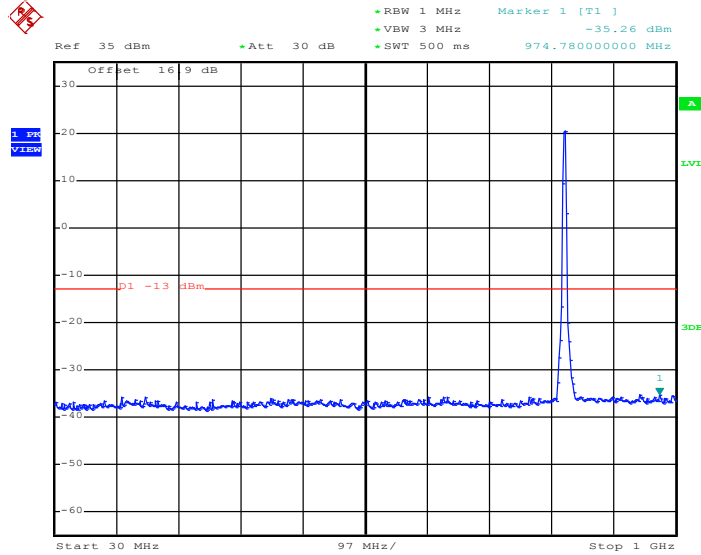

Date: 5.AUG.2014 13:33:48

Conducted Spurious Emission Plot between 1GHz ~ 3GHz

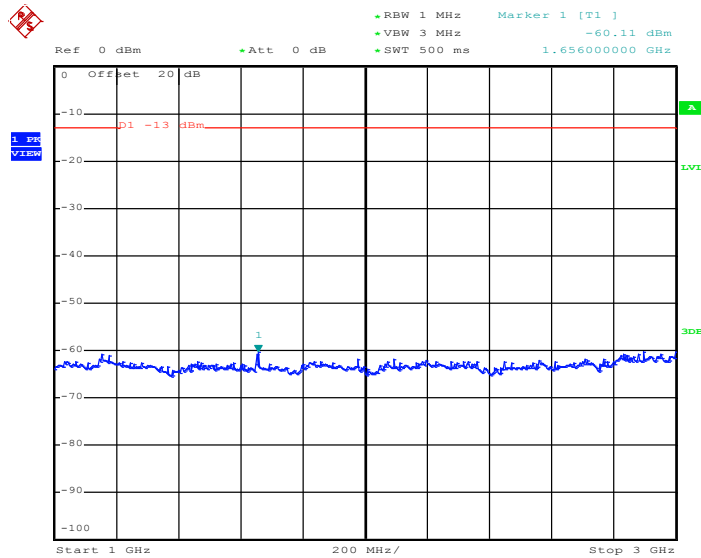

Date: 5.AUG.2014 13:33:59



Conducted Spurious Emission Plot between 3GHz ~ 7GHz

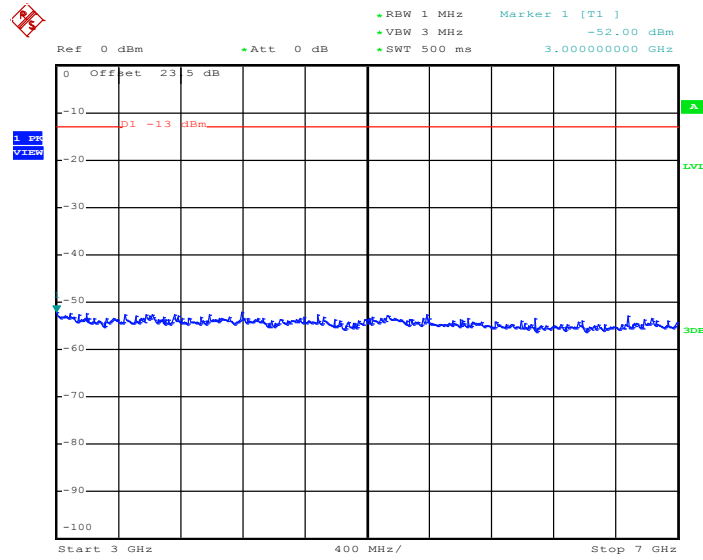

Date: 5.AUG.2014 13:34:07

Conducted Spurious Emission Plot between 7GHz ~ 9GHz

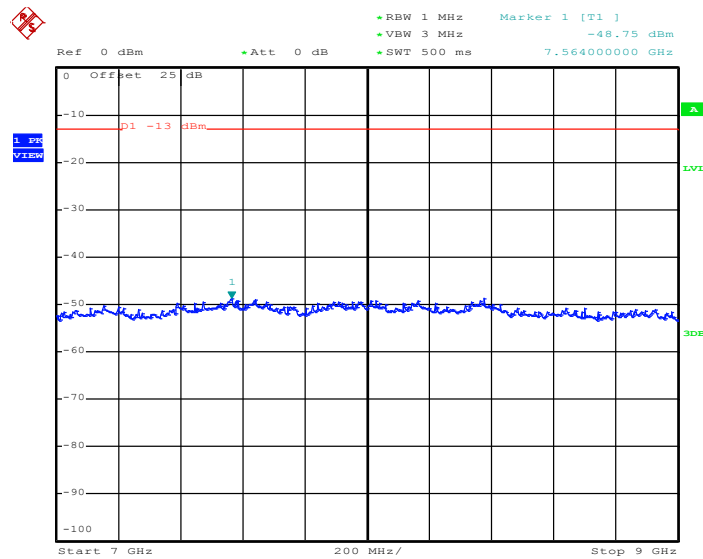

Date: 5.AUG.2014 13:34:16



Band :	WCDMA Band V	Channel :	CH4182
Test Mode :	RMC 12.2Kbps Link (QPSK)	Frequency :	836.4 MHz

Conducted Spurious Emission Plot between 30MHz ~ 1GHz

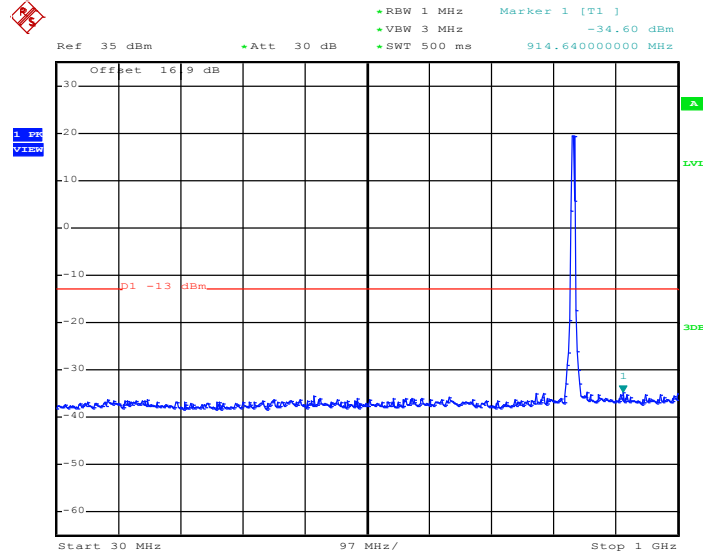

Date: 5.AUG.2014 13:32:46

Conducted Spurious Emission Plot between 1GHz ~ 3GHz

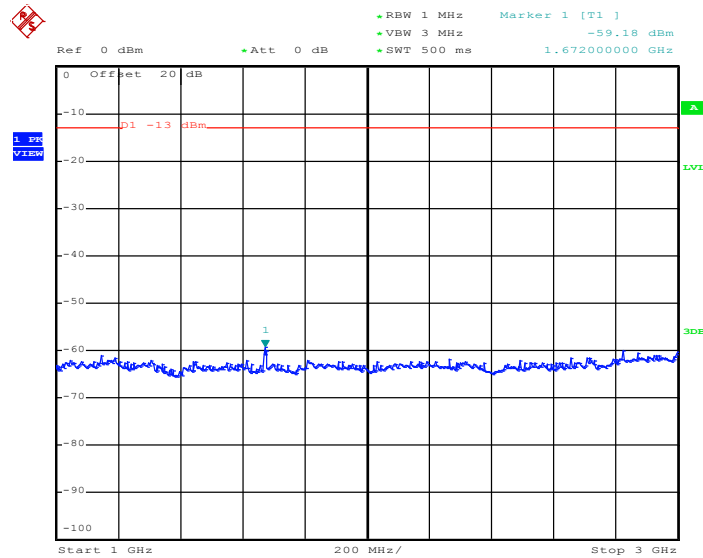

Date: 5.AUG.2014 13:32:57



Conducted Spurious Emission Plot between 3GHz ~ 7GHz

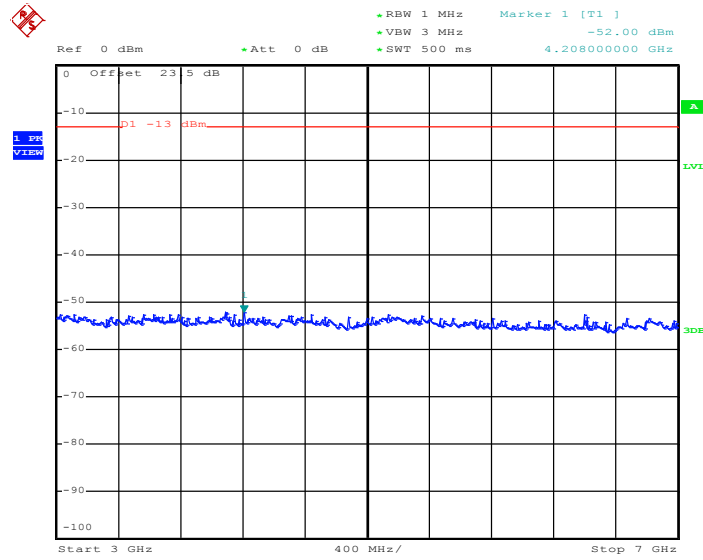

Date: 5.AUG.2014 13:33:05

Conducted Spurious Emission Plot between 7GHz ~ 9GHz

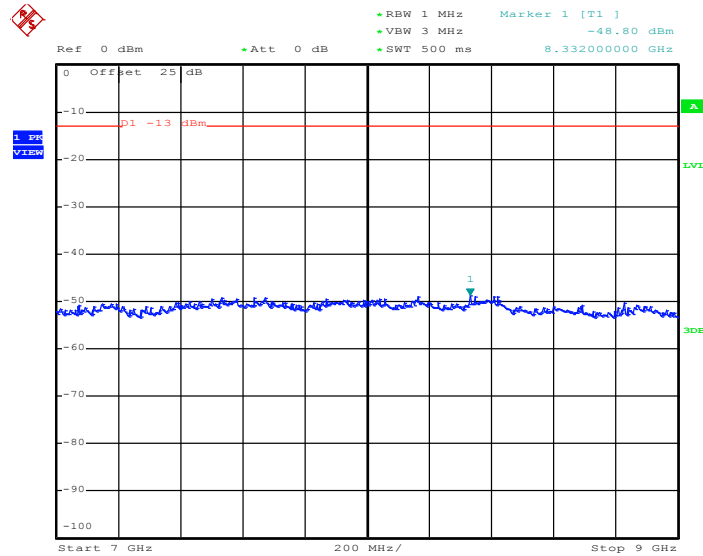

Date: 5.AUG.2014 13:33:13



Band :	WCDMA Band V	Channel :	CH4233
Test Mode :	RMC 12.2Kbps Link (QPSK)	Frequency :	846.6 MHz

Conducted Spurious Emission Plot between 30MHz ~ 1GHz

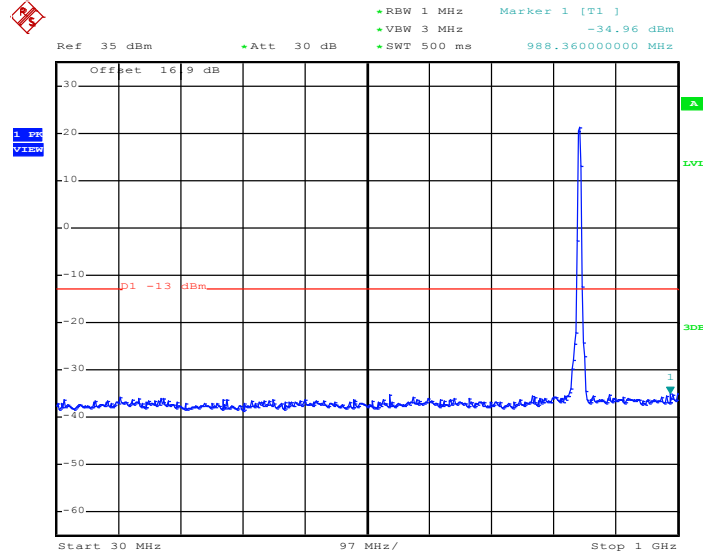

Date: 5.AUG.2014 13:35:03

Conducted Spurious Emission Plot between 1GHz ~ 3GHz

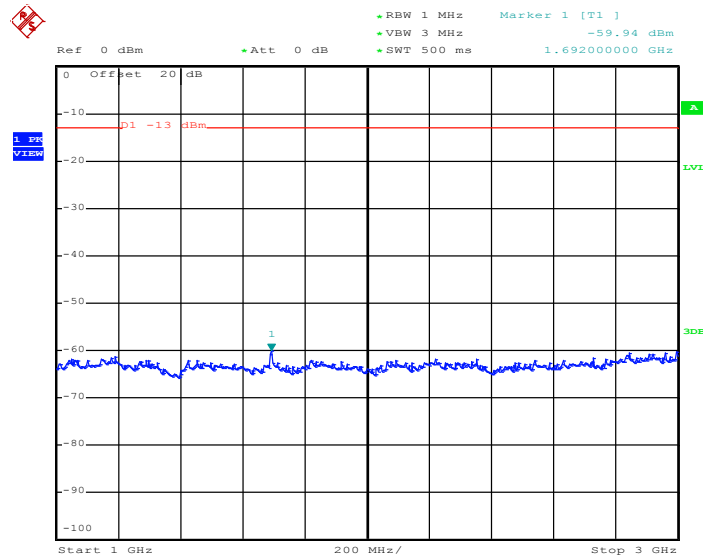

Date: 5.AUG.2014 13:35:13



Conducted Spurious Emission Plot between 3GHz ~ 7GHz

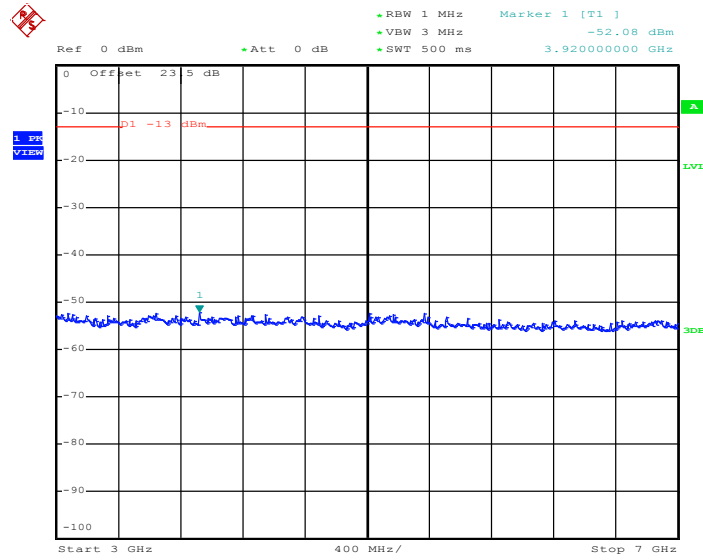

Date: 5.AUG.2014 13:35:22

Conducted Spurious Emission Plot between 7GHz ~ 9GHz

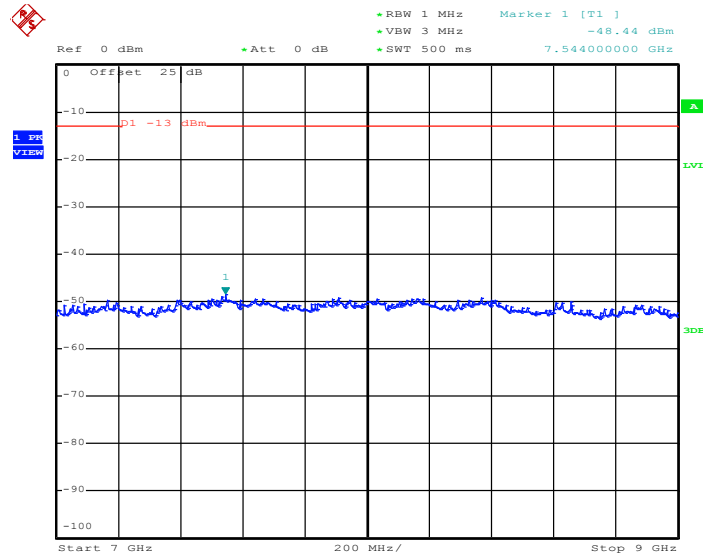

Date: 5.AUG.2014 13:35:30



Band :	WCDMA Band II	Channel :	CH9262
Test Mode :	RMC 12.2Kbps Link (QPSK)	Frequency :	1852.4 MHz

Conducted Spurious Emission Plot between 30MHz ~ 1GHz

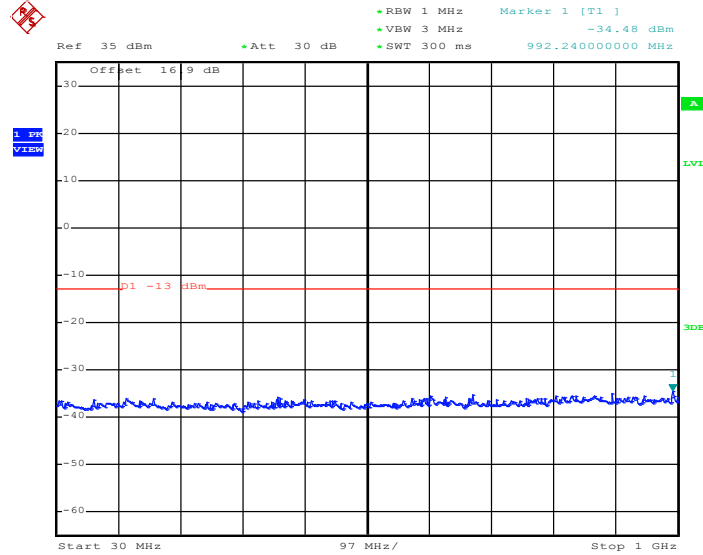

Date: 5.AUG.2014 12:43:31

Conducted Spurious Emission Plot between 1GHz ~ 3GHz

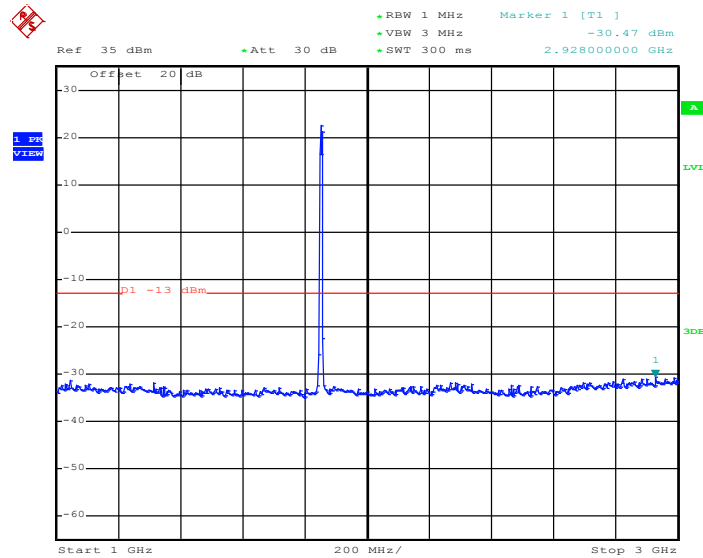

Date: 5.AUG.2014 12:43:39



Conducted Spurious Emission Plot between 3GHz ~ 7GHz

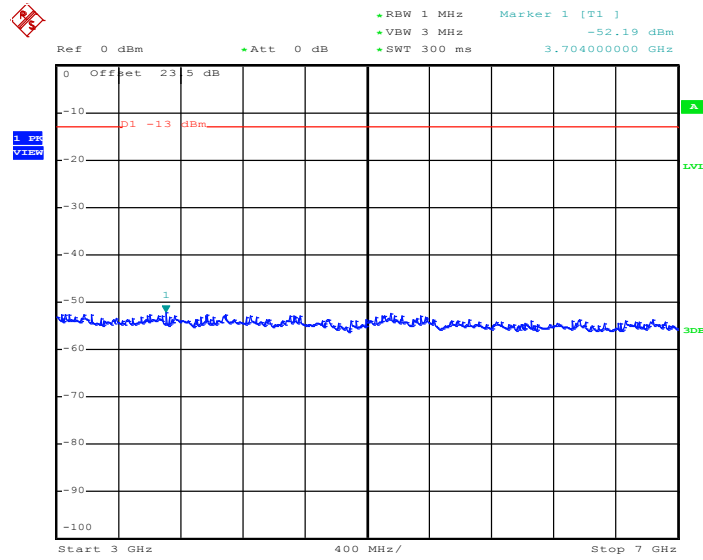

Date: 5.AUG.2014 12:43:52

Conducted Spurious Emission Plot between 7GHz ~ 13.6GHz

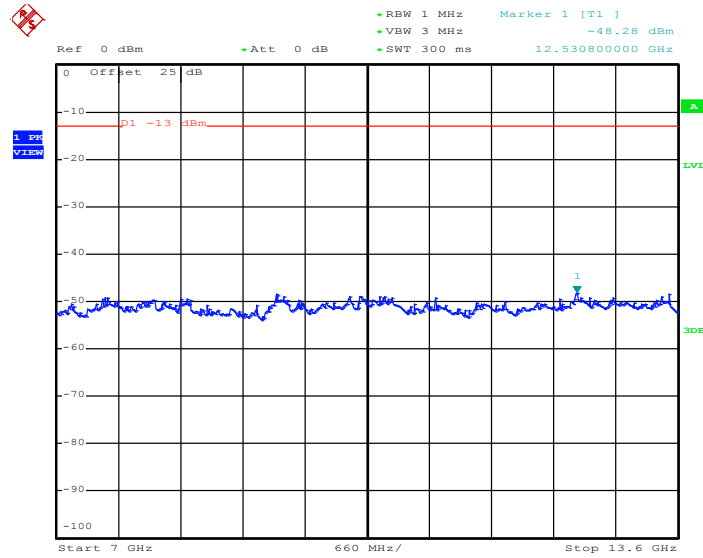

Date: 5.AUG.2014 12:44:01



Conducted Spurious Emission Plot between 13.6GHz ~ 19.1GHz

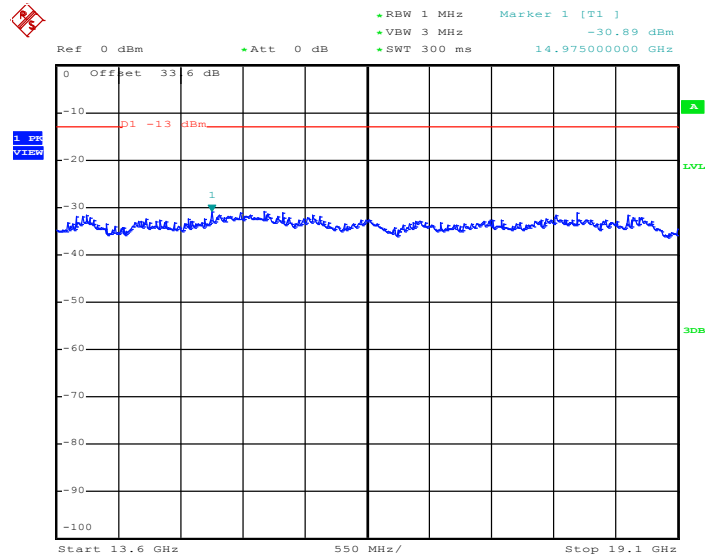

Date: 5.AUG.2014 12:44:09



Band :	WCDMA Band II	Channel :	CH9400
Test Mode :	RMC 12.2Kbps Link (QPSK)	Frequency :	1880.0 MHz

Conducted Spurious Emission Plot between 30MHz ~ 1GHz

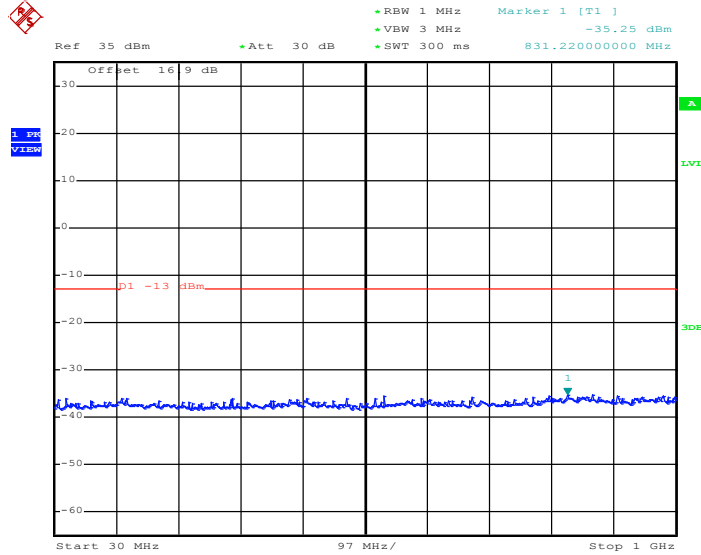

Date: 5.AUG.2014 12:42:19

Conducted Spurious Emission Plot between 1GHz ~ 3GHz

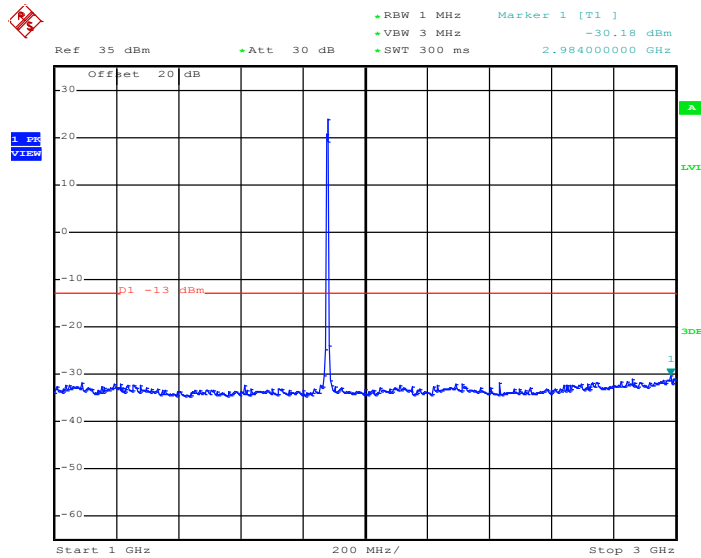

Date: 5.AUG.2014 12:42:27



Conducted Spurious Emission Plot between 3GHz ~ 7GHz

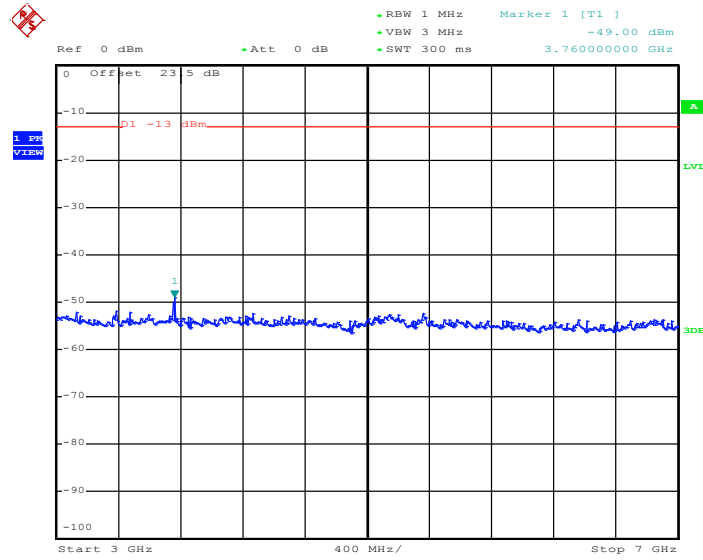

Date: 5.AUG.2014 12:42:39

Conducted Spurious Emission Plot between 7GHz ~ 13.6GHz

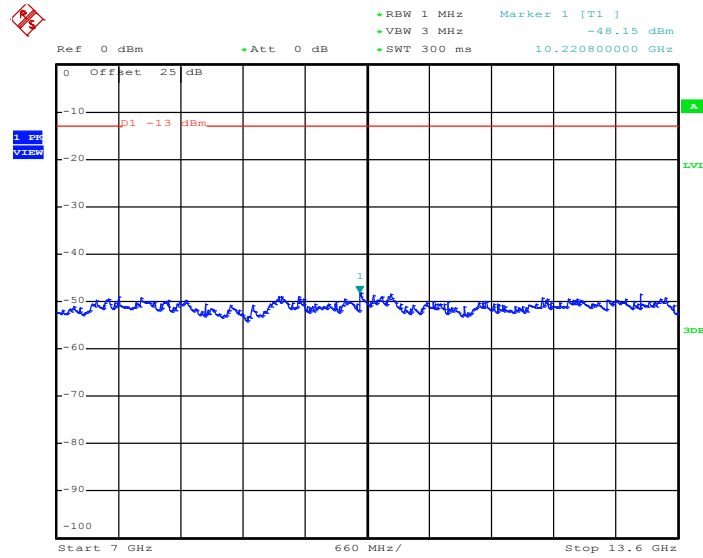

Date: 5.AUG.2014 12:42:47



Conducted Spurious Emission Plot between 13.6GHz ~ 19.1GHz

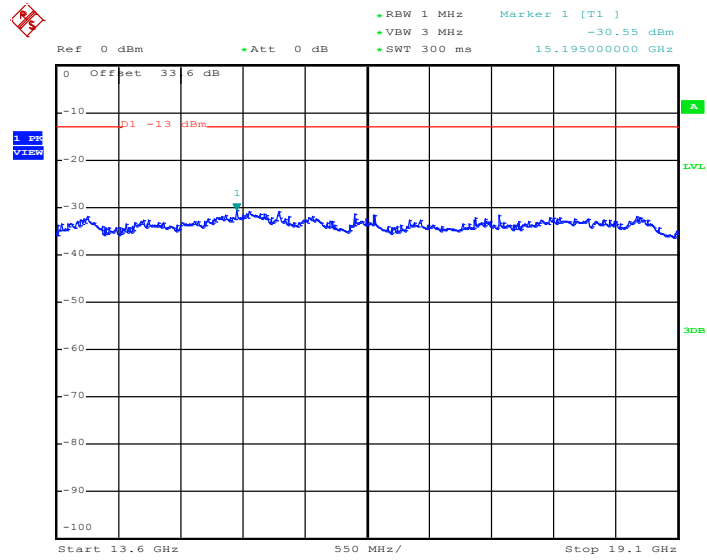

Date: 5.AUG.2014 12:42:55



Band :	WCDMA Band II	Channel :	CH9538
Test Mode :	RMC 12.2Kbps Link (QPSK)	Frequency :	1907.6 MHz

Conducted Spurious Emission Plot between 30MHz ~ 1GHz

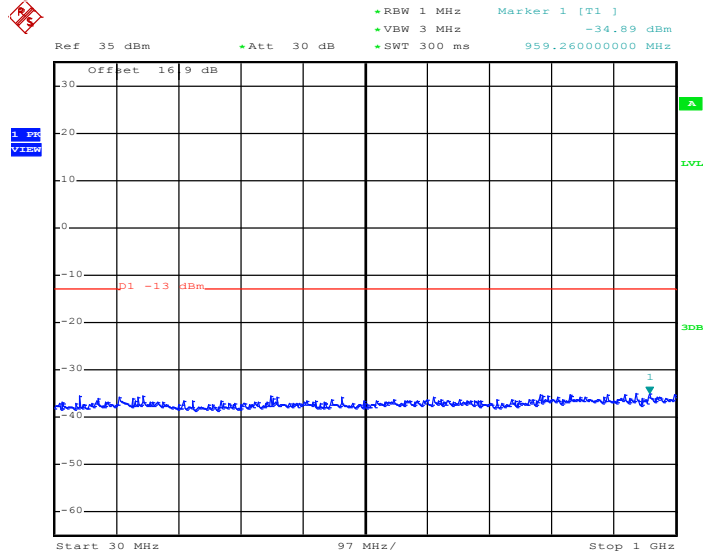

Date: 5.AUG.2014 12:45:23

Conducted Spurious Emission Plot between 1GHz ~ 3GHz

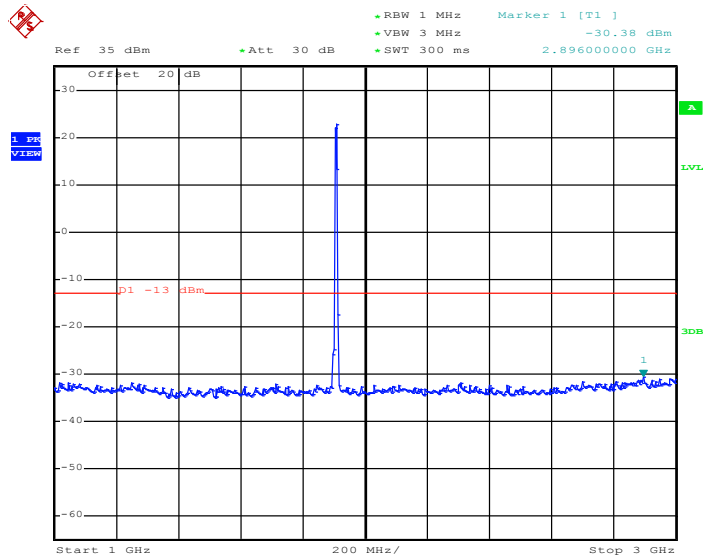

Date: 5.AUG.2014 12:45:31



Conducted Spurious Emission Plot between 3GHz ~ 7GHz

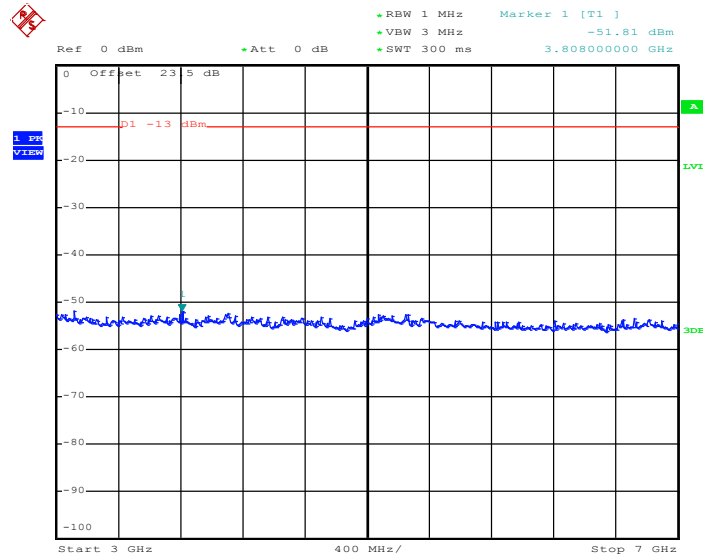

Date: 5.AUG.2014 12:45:44

Conducted Spurious Emission Plot between 7GHz ~ 13.6GHz

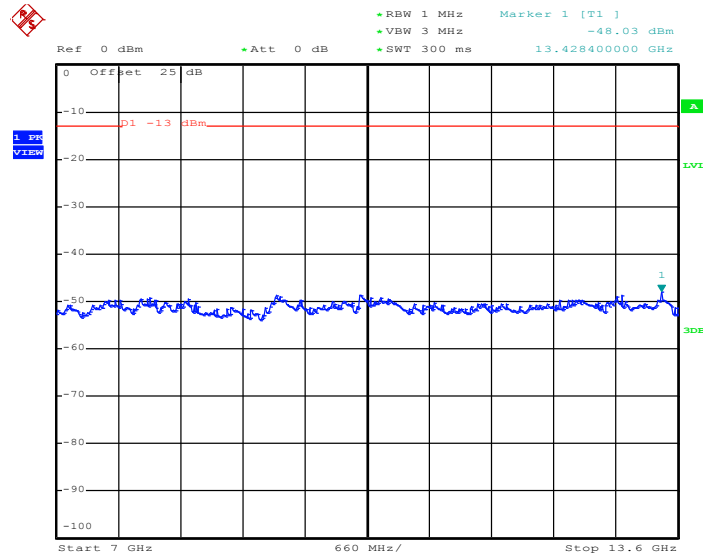

Date: 5.AUG.2014 12:45:52



Conducted Spurious Emission Plot between 13.6GHz ~ 19.1GHz

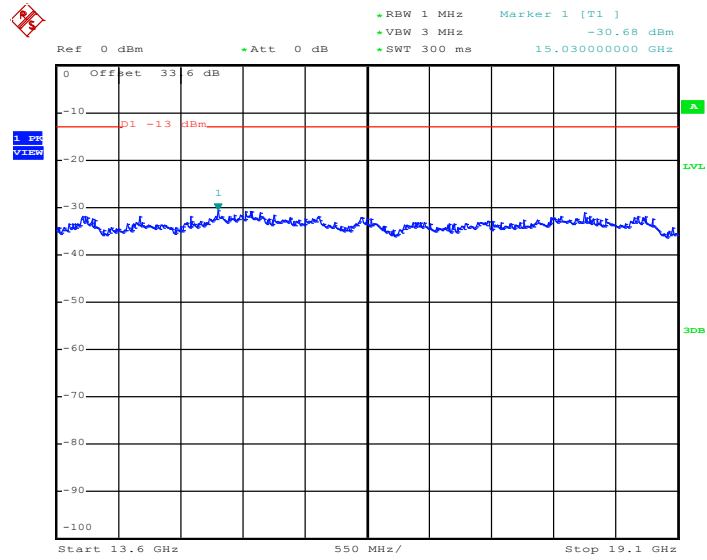

Date: 5.AUG.2014 12:46:01



Band :	CDMA2000 BC0	Channel :	CH1013
Test Mode :	1xRTT_RC3+SO32 (QPSK)	Frequency :	824.7 MHz

Conducted Spurious Emission Plot between 30MHz ~ 1GHz

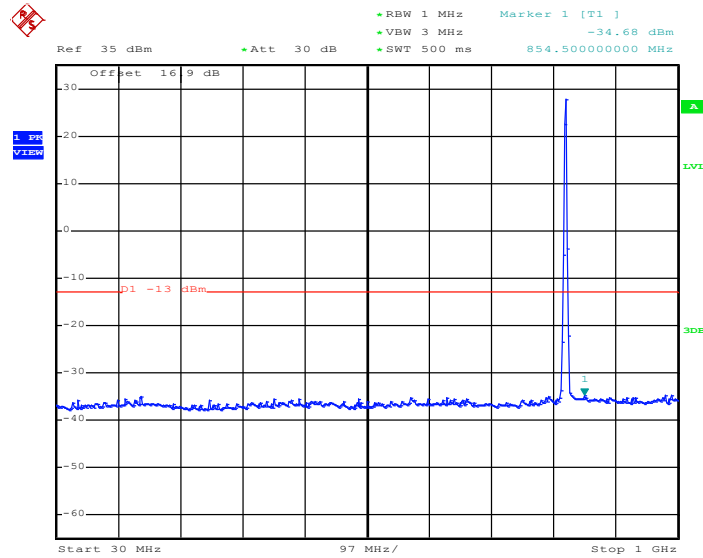

Date: 10.AUG.2014 16:13:14

Conducted Spurious Emission Plot between 1GHz ~ 3GHz

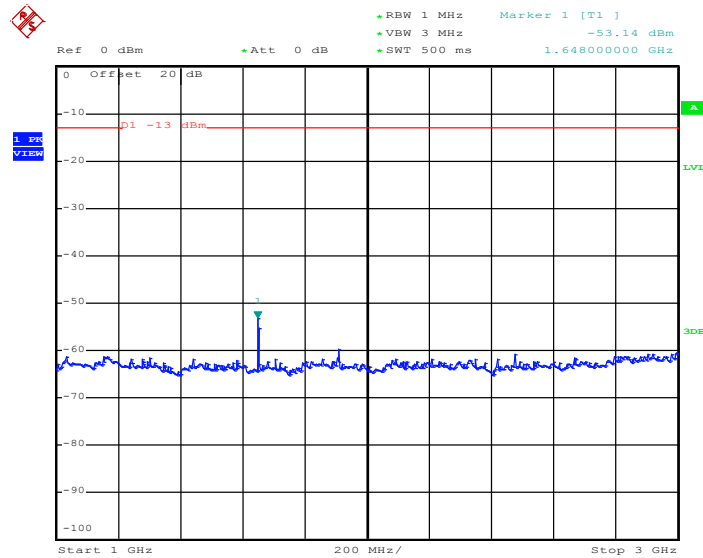

Date: 10.AUG.2014 16:14:04



Conducted Spurious Emission Plot between 3GHz ~ 7GHz

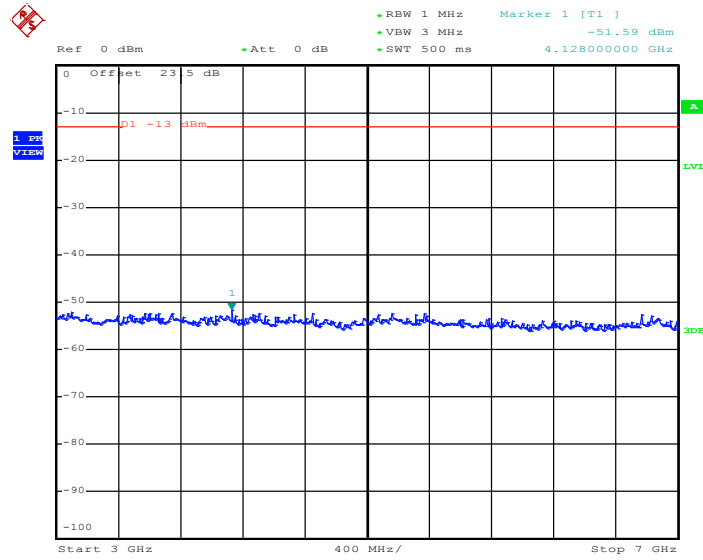

Date: 10.AUG.2014 16:14:12

Conducted Spurious Emission Plot between 7GHz ~ 9GHz

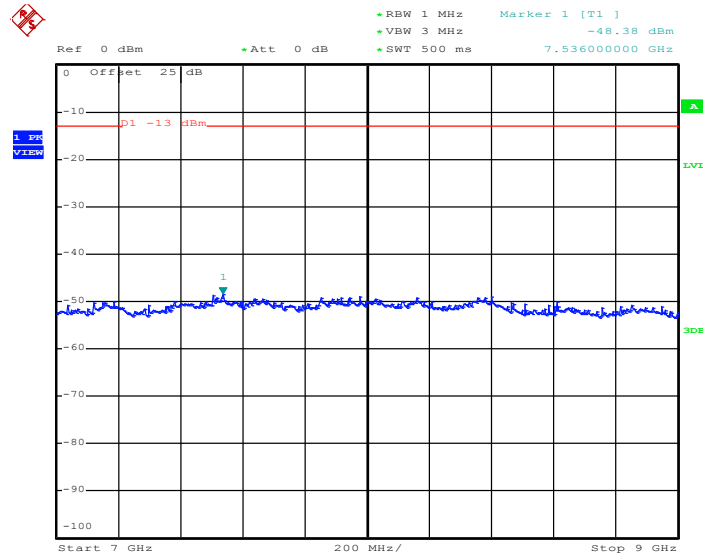

Date: 10.AUG.2014 16:14:20



Band :	CDMA2000 BC0	Channel :	CH384
Test Mode :	1xRTT_RC3+SO32 (QPSK)	Frequency :	836.52 MHz

Conducted Spurious Emission Plot between 30MHz ~ 1GHz

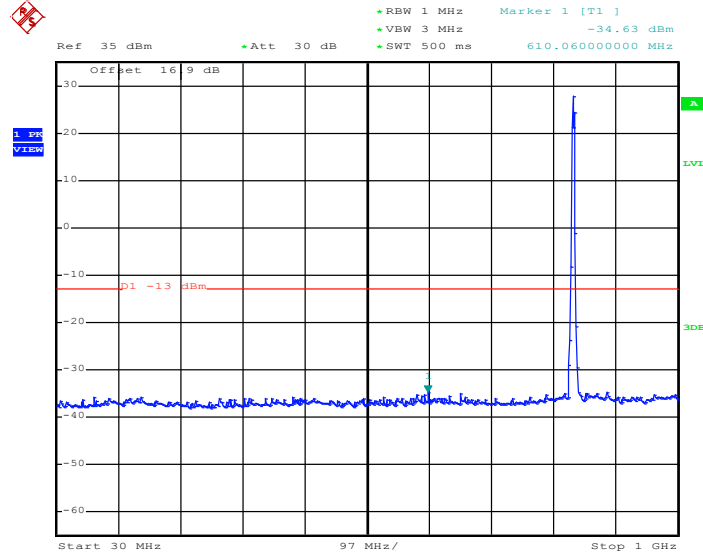

Date: 10.AUG.2014 16:16:41

Conducted Spurious Emission Plot between 1GHz ~ 3GHz

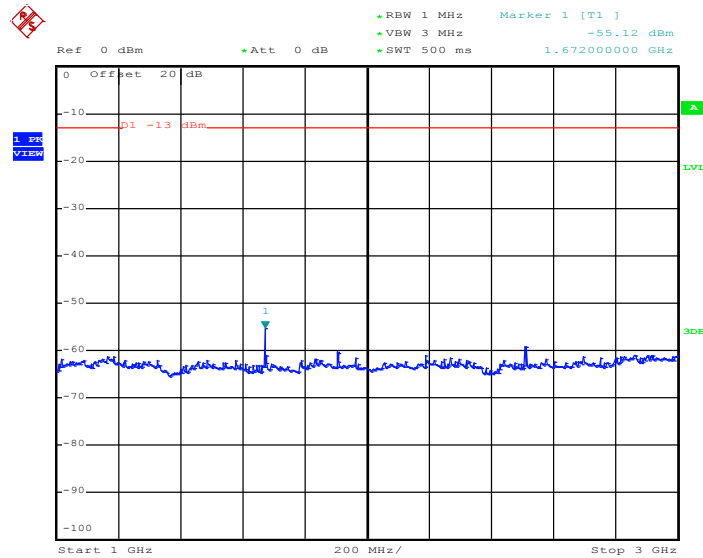

Date: 10.AUG.2014 16:16:36



Conducted Spurious Emission Plot between 3GHz ~ 7GHz

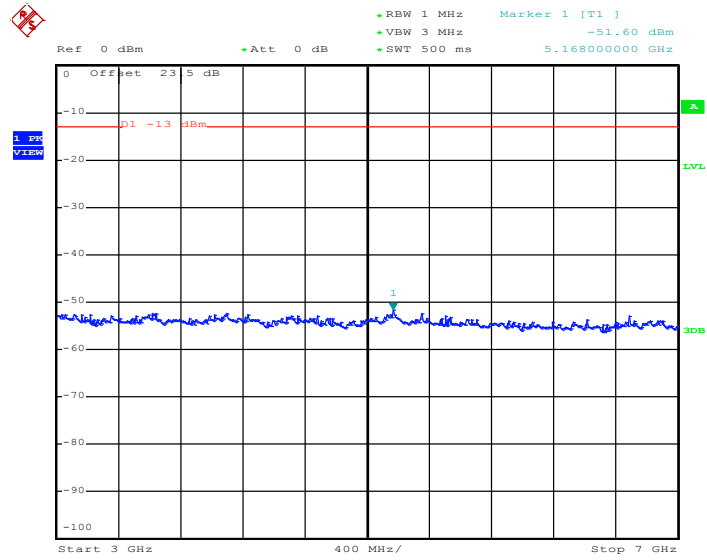

Date: 10.AUG.2014 16:16:44

Conducted Spurious Emission Plot between 7GHz ~ 9GHz

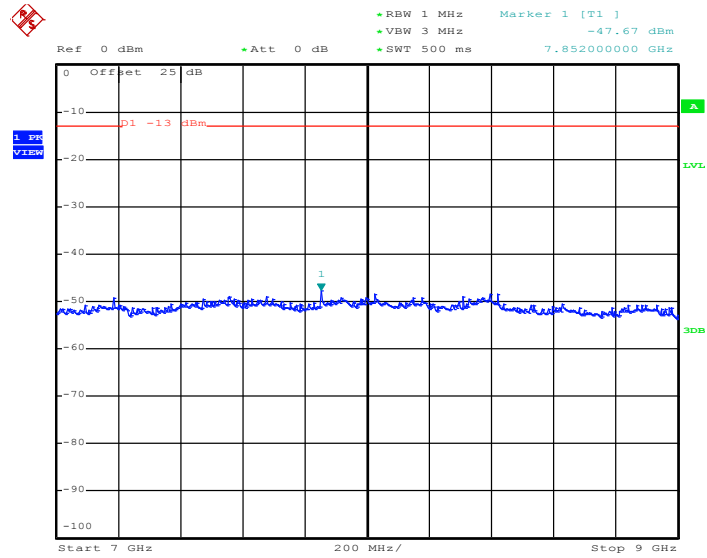

Date: 10.AUG.2014 16:16:52



Band :	CDMA2000 BC0	Channel :	CH777
Test Mode :	1xRTT_RC3+SO32 (QPSK)	Frequency :	848.31 MHz

Conducted Spurious Emission Plot between 30MHz ~ 1GHz

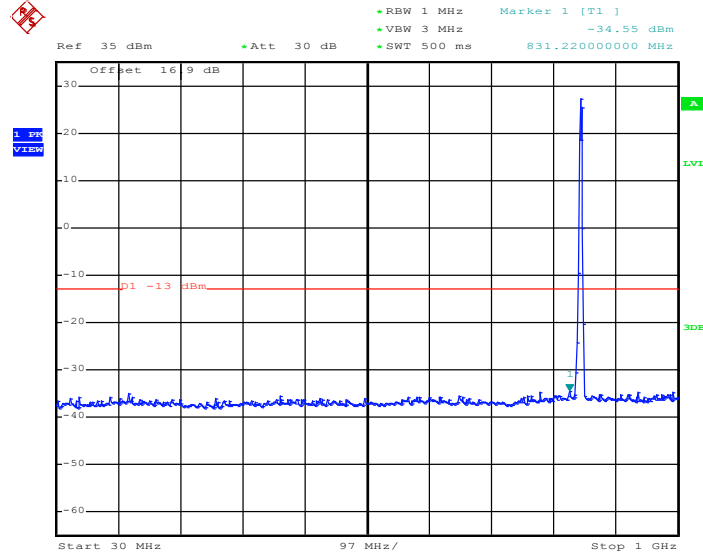

Date: 10.AUG.2014 16:17:52

Conducted Spurious Emission Plot between 1GHz ~ 3GHz

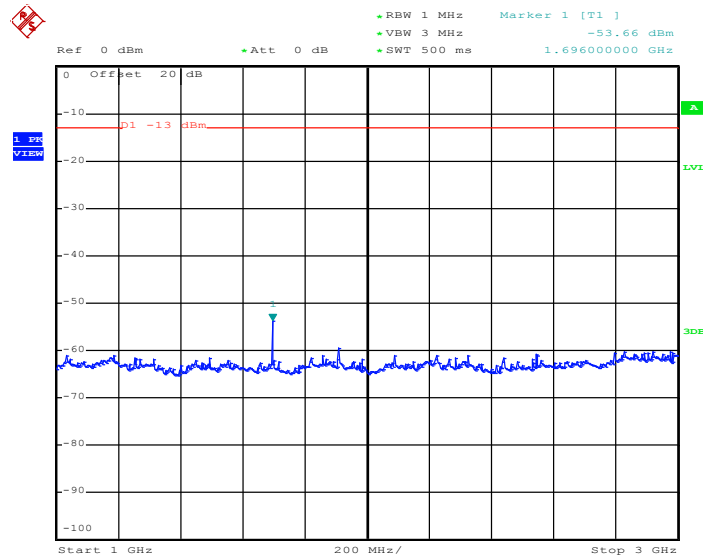

Date: 10.AUG.2014 16:17:50



Conducted Spurious Emission Plot between 3GHz ~ 7GHz

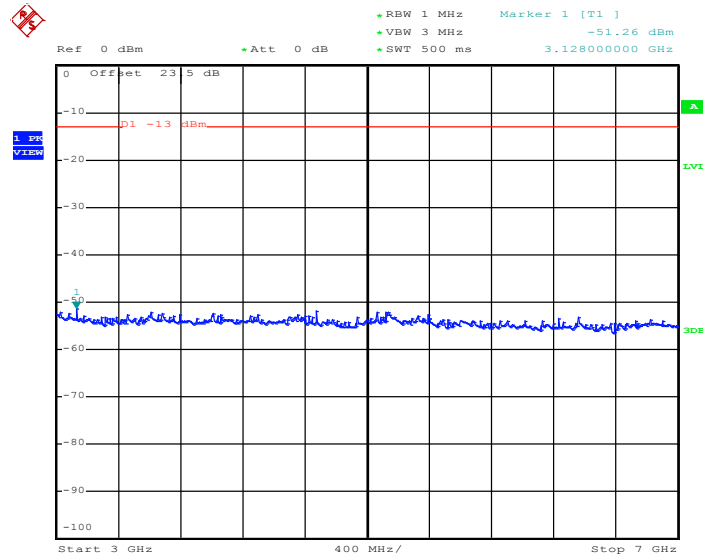

Date: 10.AUG.2014 16:17:59

Conducted Spurious Emission Plot between 7GHz ~ 9GHz

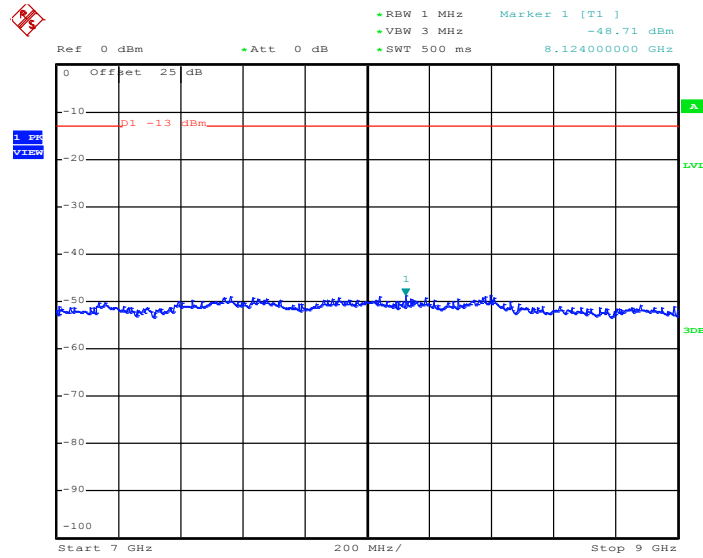

Date: 10.AUG.2014 16:18:07



Band :	CDMA2000 BC1	Channel :	CH25
Test Mode :	1xRTT_RC3+SO32 (QPSK)	Frequency :	1851.25 MHz

Conducted Spurious Emission Plot between 30MHz ~ 1GHz

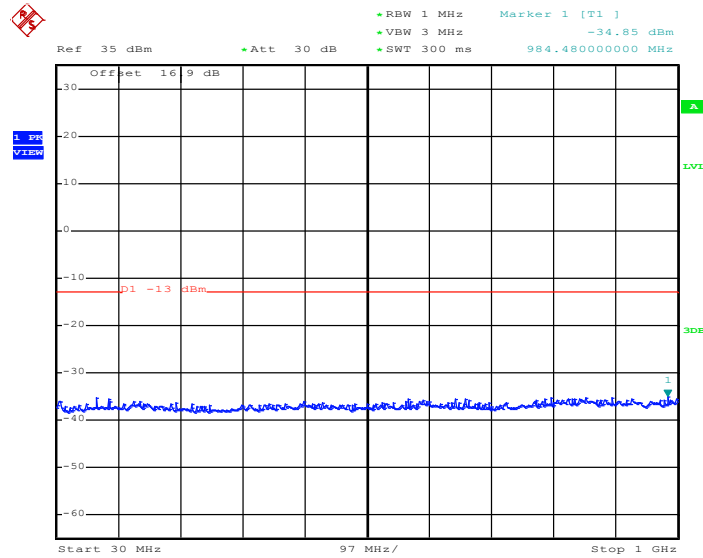

Date: 10.AUG.2014 15:36:26

Conducted Spurious Emission Plot between 1GHz ~ 3GHz

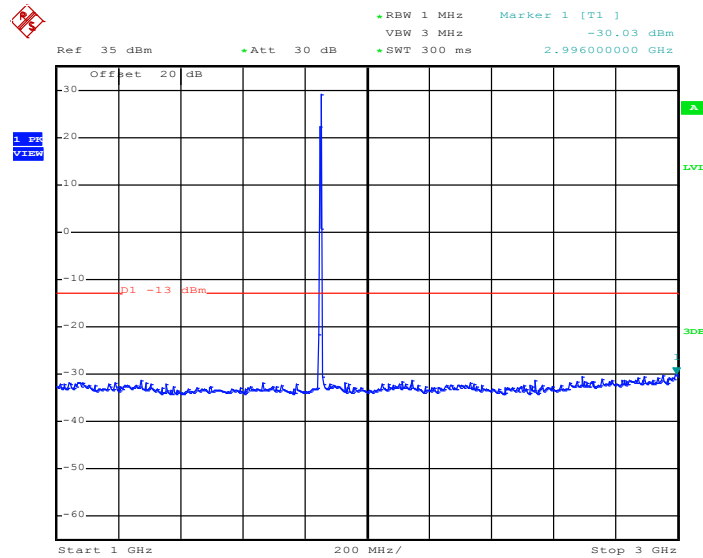

Date: 10.AUG.2014 15:36:41



Conducted Spurious Emission Plot between 3GHz ~ 7GHz

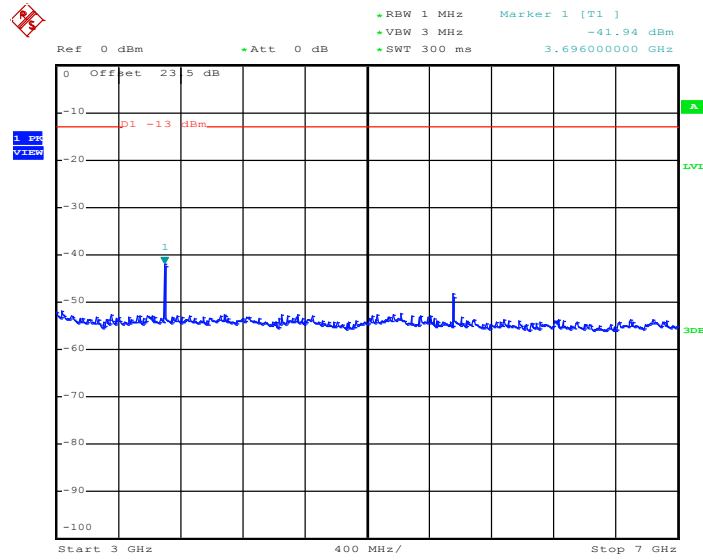

Date: 10.AUG.2014 15:36:45

Conducted Spurious Emission Plot between 7GHz ~ 13.6GHz

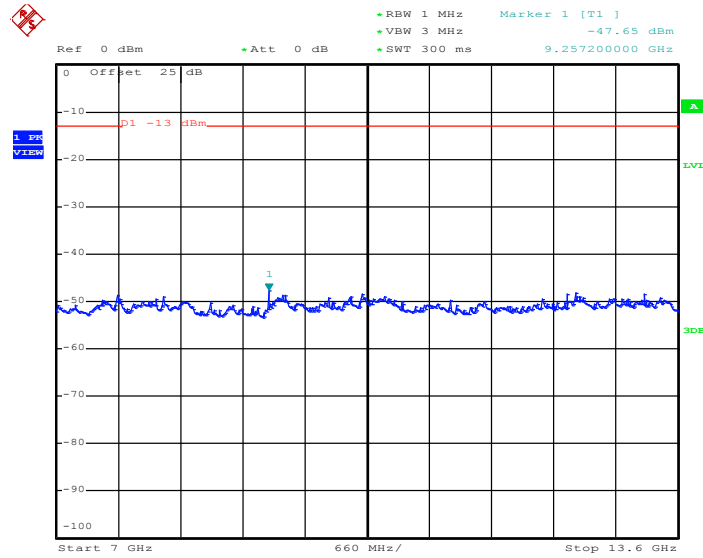

Date: 10.AUG.2014 15:36:53



Conducted Spurious Emission Plot between 13.6GHz ~ 19.1GHz

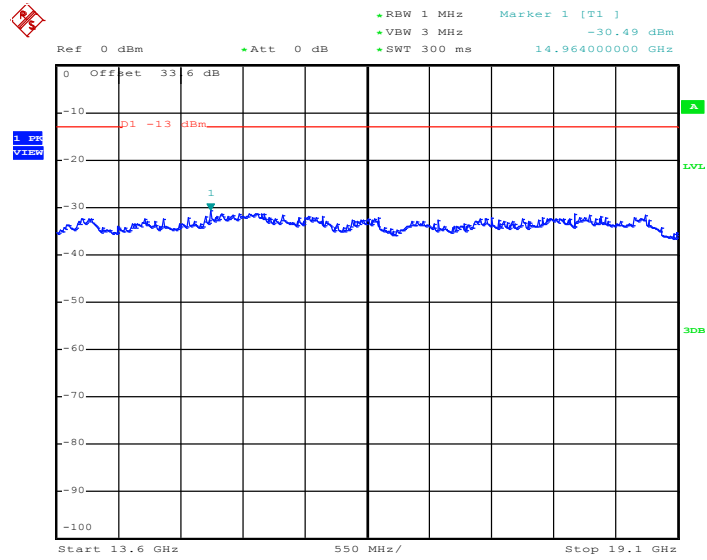

Date: 10.AUG.2014 15:37:01



Band :	CDMA2000 BC1	Channel :	CH600
Test Mode :	1xRTT_RC3+SO32 (QPSK)	Frequency :	1880.0 MHz

Conducted Spurious Emission Plot between 30MHz ~ 1GHz

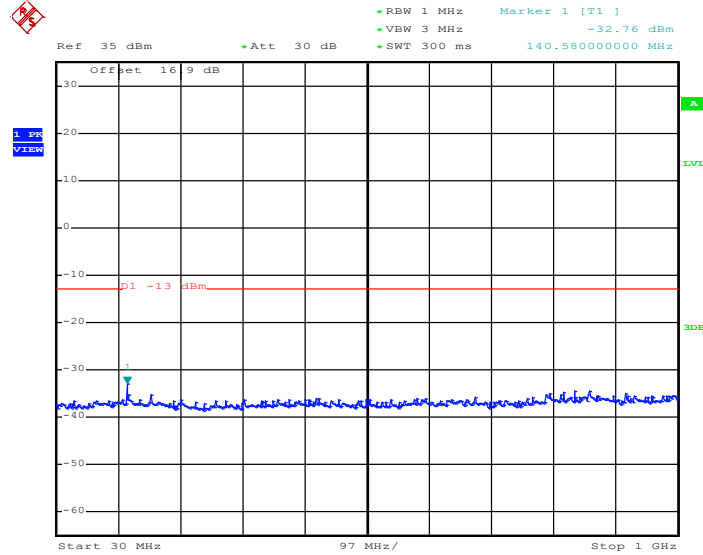

Date: 10.AUG.2014 15:38:19

Conducted Spurious Emission Plot between 1GHz ~ 3GHz

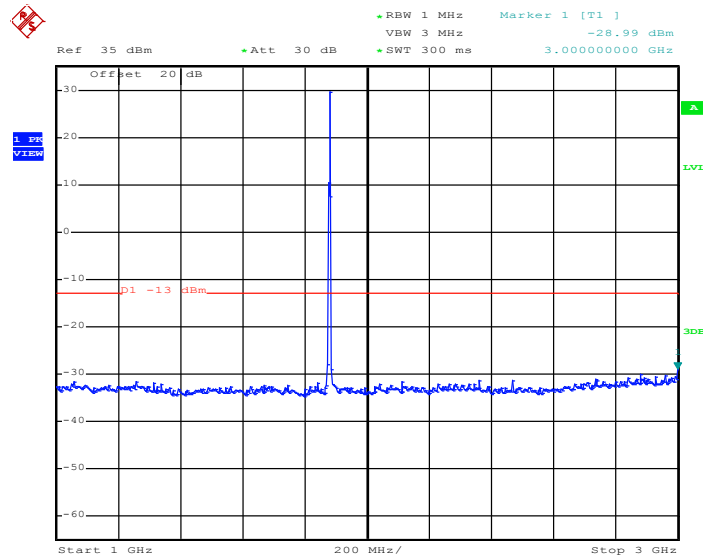

Date: 10.AUG.2014 15:38:36



Conducted Spurious Emission Plot between 3GHz ~ 7GHz

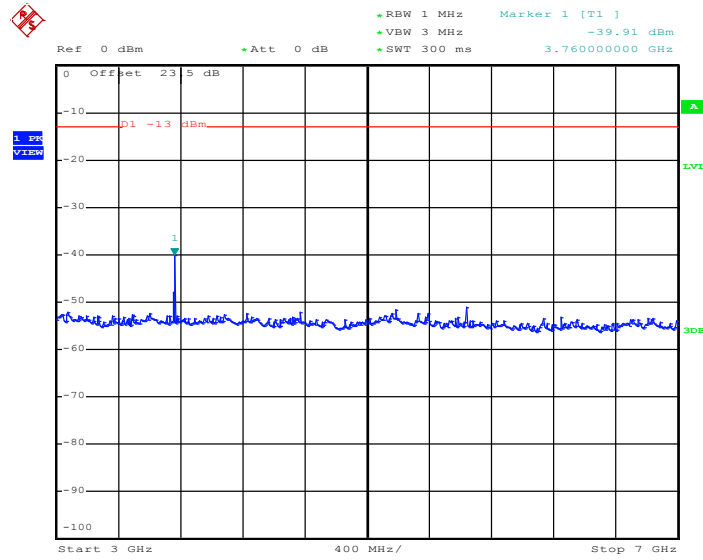

Date: 10.AUG.2014 15:38:38

Conducted Spurious Emission Plot between 7GHz ~ 13.6GHz

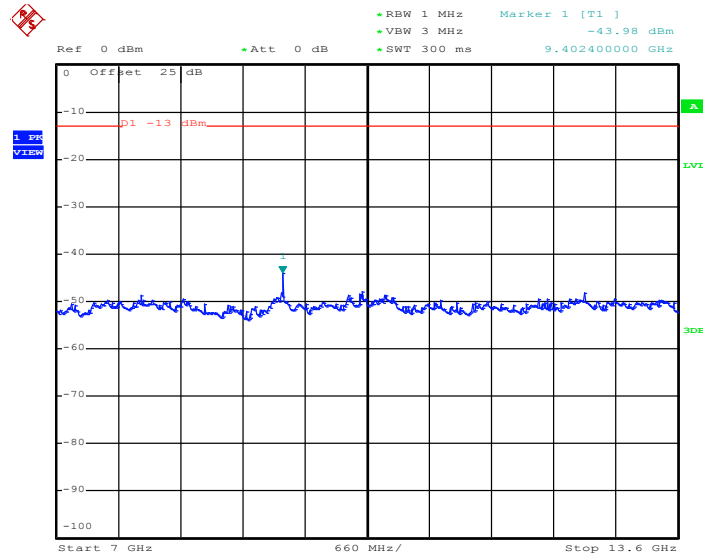

Date: 10.AUG.2014 15:38:46



Conducted Spurious Emission Plot between 13.6GHz ~ 19.1GHz

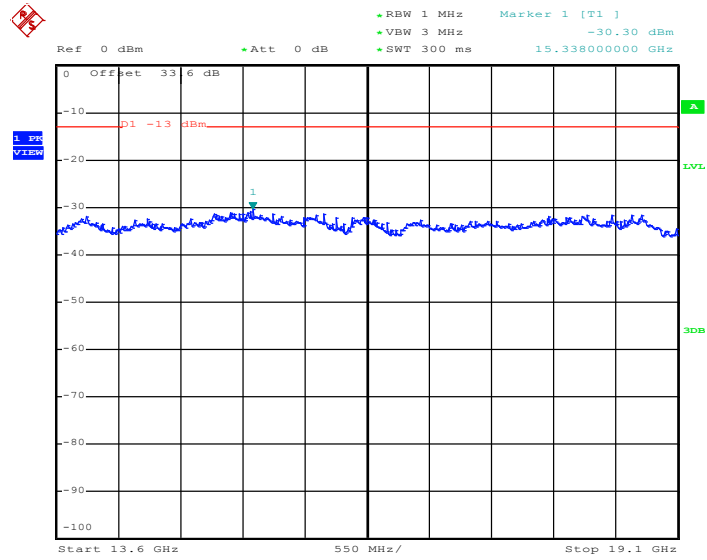

Date: 10.AUG.2014 15:38:55



Band :	CDMA2000 BC1	Channel :	CH1175
Test Mode :	1xRTT_RC3+SO32 (QPSK)	Frequency :	1908.75MHz

Conducted Spurious Emission Plot between 30MHz ~ 1GHz

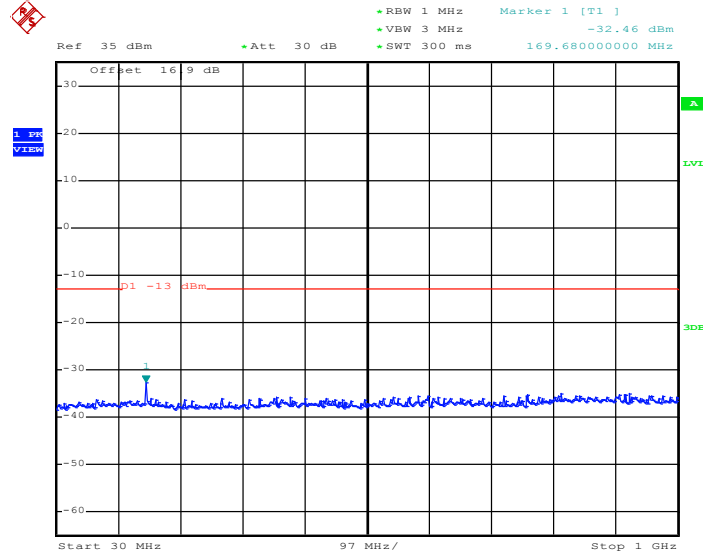

Date: 10.AUG.2014 15:40:35

Conducted Spurious Emission Plot between 1GHz ~ 3GHz

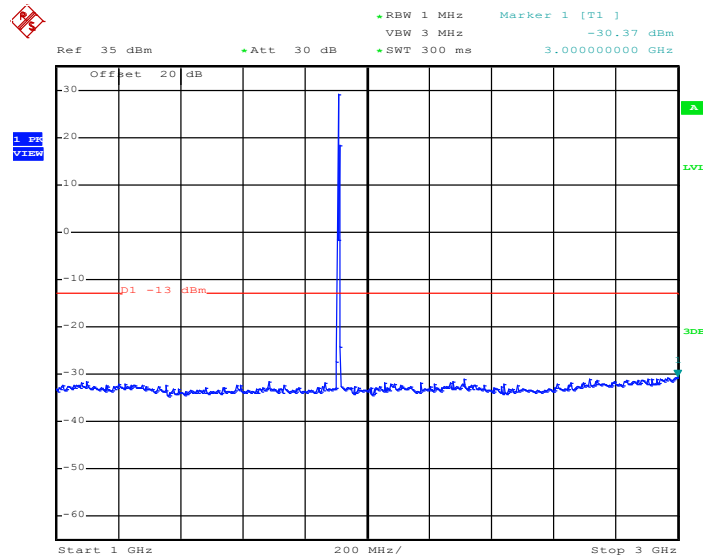

Date: 10.AUG.2014 15:39:33



Conducted Spurious Emission Plot between 3GHz ~ 7GHz

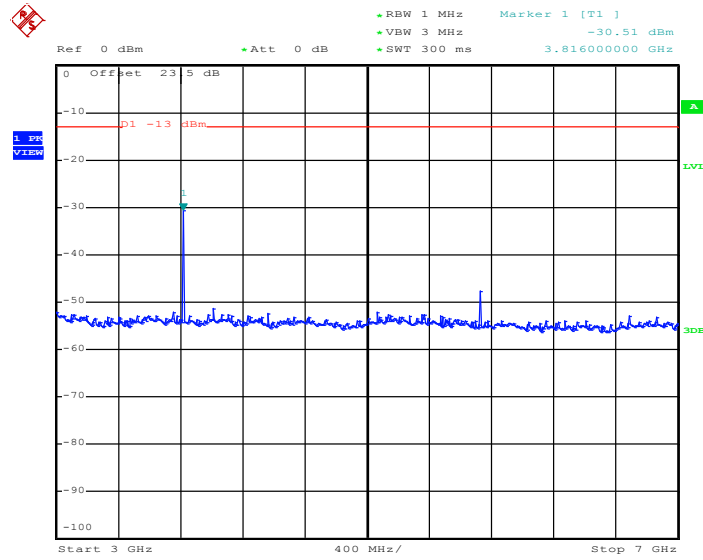

Date: 10.AUG.2014 15:40:55

Conducted Spurious Emission Plot between 7GHz ~ 13.6GHz

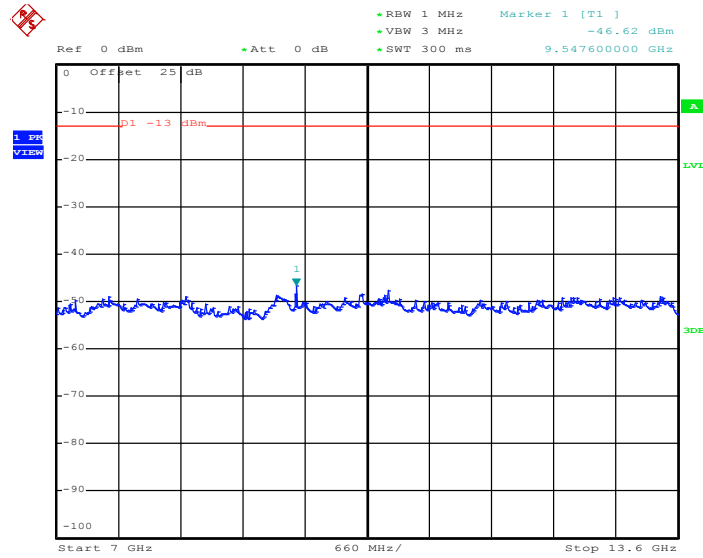

Date: 10.AUG.2014 15:41:03



Conducted Spurious Emission Plot between 13.6GHz ~ 19.1GHz

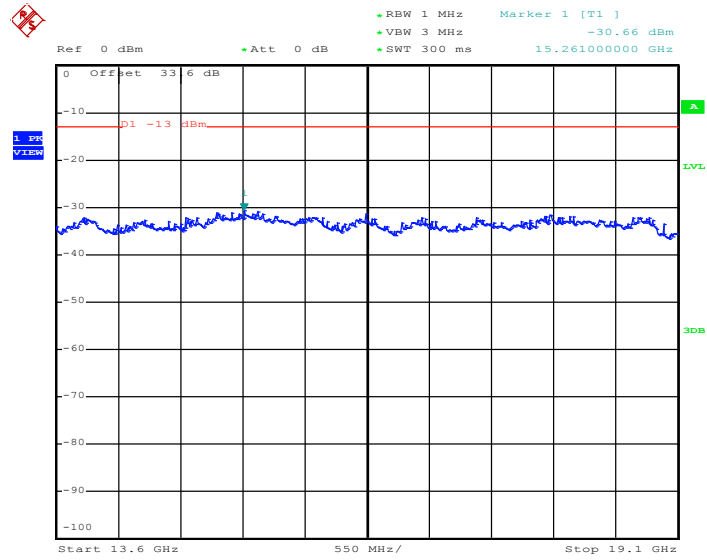

Date: 10.AUG.2014 15:41:12



3.7 Field Strength of Spurious Radiation Measurement

3.7.1 Description of Field Strength of Spurious Radiated Measurement

The power of any emission outside of the authorized operating frequency ranges must be attenuated below the transmitter power (P) by a factor of at least $43 + 10 \log (P)$ dB. The spectrum is scanned from 30 MHz up to a frequency including its 10th harmonic.

3.7.2 Measuring Instruments

The measuring equipment is listed in the section 4 of this test report.

3.7.3 Test Procedures

1. The testing follows FCC KDB 971168 v02r02 Section 5.8 and ANSI / TIA-603-C-2004 Section 2.2.12.
2. The EUT was placed on a rotatable wooden table 0.8 meters above the ground.
3. The EUT was set 3 meters from the receiving antenna, which was mounted on the antenna tower.
4. The table was rotated 360 degrees to determine the position of the highest spurious emission.
5. The height of the receiving antenna is varied between one meter and four meters to search for the maximum spurious emission for both horizontal and vertical polarizations.
6. Make the measurement with the spectrum analyzer's RBW = 1MHz, VBW = 3MHz, taking record of maximum spurious emission.
7. A horn antenna was substituted in place of the EUT and was driven by a signal generator.
8. Tune the output power of signal generator to the same emission level with EUT maximum spurious emission.
9. Taking the record of output power at antenna port.
10. Repeat step 7 to step 8 for another polarization.
11. $EIRP \text{ (dBm)} = S.G. \text{ Power} - Tx \text{ Cable Loss} + Tx \text{ Antenna Gain}$
12. $ERP \text{ (dBm)} = EIRP - 2.15$
13. The RF fundamental frequency should be excluded against the limit line in the operating frequency band.
14. The limit line is derived from $43 + 10\log(P)$ dB below the transmitter power P(Watts)
 $= P(W) - [43 + 10\log(P)] \text{ (dB)}$
 $= [30 + 10\log(P)] \text{ (dBm)} - [43 + 10\log(P)] \text{ (dB)}$
 $= -13dBm.$

3.7.4 Test Setup

For radiated emissions from 30MHz to 1GHz

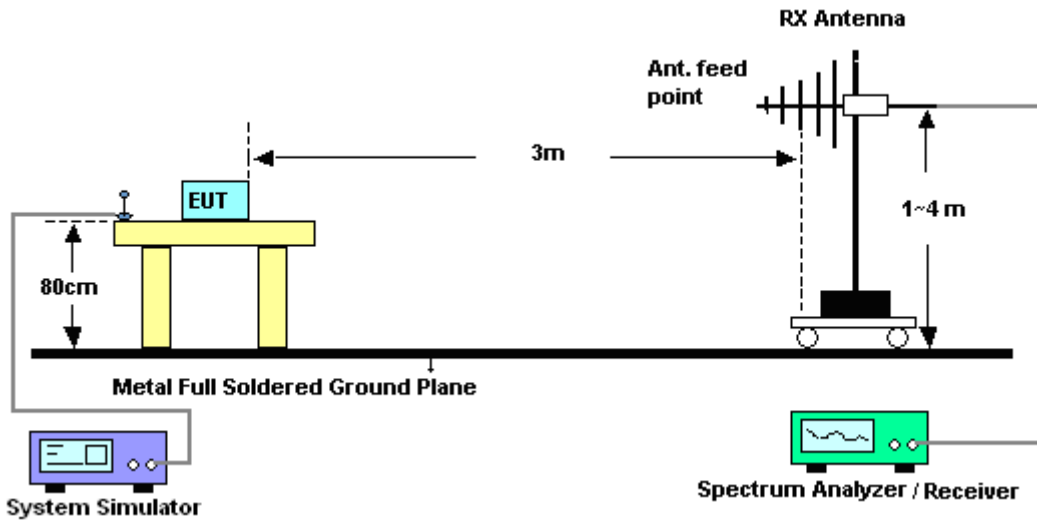

For radiated emissions above 1GHz

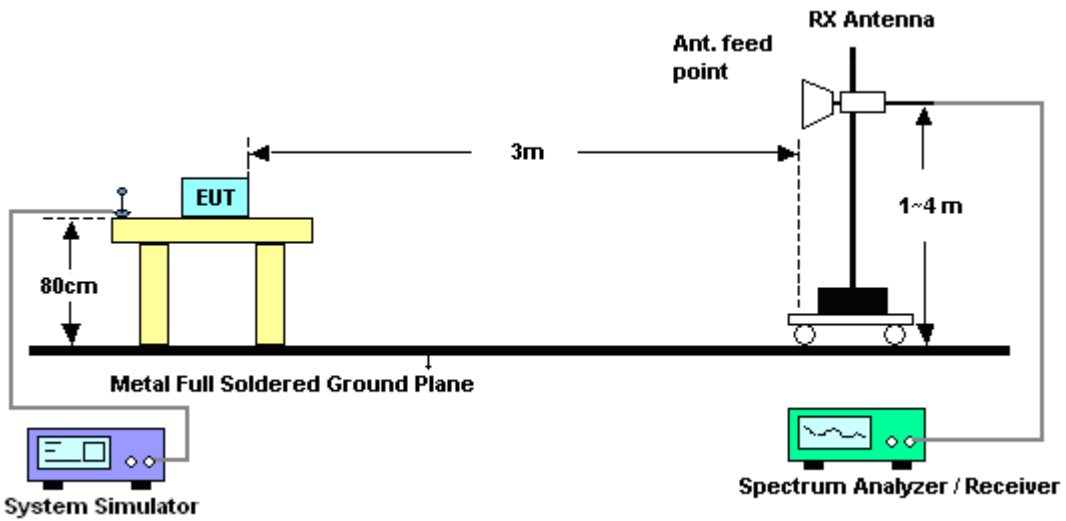



3.7.5 Test Result of Field Strength of Spurious Radiated

<Low Channel>

Band :	GSM850						Temperature :	23~25°C		
Test Mode :	GPRS class 8 Link (GMSK) + USB Cable 1 (Charging from Adapter 1) + Earphone 1						Relative Humidity :	46~48%		
Test Engineer :	Eric Shih, Stan Hsieh, Ken Wu and Derreck Chen						Polarization :	Horizontal		
Remark :	Spurious emissions within 30-1000MHz were found more than 20dB below limit line.									
Frequency (MHz)	ERP (dBm)	Limit (dBm)	Over Limit (dB)	SPA Reading (dBm)	S.G. Power (dBm)	TX Cable loss (dB)	TX Antenna Gain (dBi)	Polarization (H/V)	Result	
1648	-43.94	-13	-30.94	-55.29	-45.7	0.98	4.89	H	Pass	
2472	-41.42	-13	-28.42	-57.29	-43.3	1.28	5.32	H	Pass	
3298	-48.98	-13	-35.98	-66.1	-52.4	1.54	7.11	H	Pass	

Band :	GSM850						Temperature :	23~25°C		
Test Mode :	GPRS class 8 Link (GMSK) + USB Cable 1 (Charging from Adapter 1) + Earphone 1						Relative Humidity :	46~48%		
Test Engineer :	Eric Shih, Stan Hsieh, Ken Wu and Derreck Chen						Polarization :	Vertical		
Remark :	Spurious emissions within 30-1000MHz were found more than 20dB below limit line.									
Frequency (MHz)	ERP (dBm)	Limit (dBm)	Over Limit (dB)	SPA Reading (dBm)	S.G. Power (dBm)	TX Cable loss (dB)	TX Antenna Gain (dBi)	Polarization (H/V)	Result	
1648	-41.84	-13	-28.84	-55.32	-43.6	0.98	4.89	V	Pass	
2472	-41.72	-13	-28.72	-57.66	-43.6	1.28	5.32	V	Pass	
3298	-47.28	-13	-34.28	-65.57	-50.7	1.54	7.11	V	Pass	



<Middle Channel>

Band :	GSM850						Temperature :	23~25°C		
Test Mode :	GPRS class 8 Link (GMSK) + USB Cable 1 (Charging from Adapter 1) + Earphone 1						Relative Humidity :	46~48%		
Test Engineer :	Eric Shih, Stan Hsieh, Ken Wu and Derreck Chen						Polarization :	Horizontal		
Remark :	Spurious emissions within 30-1000MHz were found more than 20dB below limit line.									
Frequency (MHz)	ERP (dBm)	Limit (dBm)	Over Limit (dB)	SPA Reading (dBm)	S.G. Power (dBm)	TX Cable loss (dB)	TX Antenna Gain (dBi)	Polarization (H/V)	Result	
1672	-43.12	-13	-30.12	-54.59	-44.8	0.99	4.82	H	Pass	
2512	-43.63	-13	-30.63	-59.73	-45.6	1.29	5.41	H	Pass	
3345	-49.59	-13	-36.59	-66.42	-53.2	1.56	7.32	H	Pass	

Band :	GSM850						Temperature :	23~25°C		
Test Mode :	GPRS class 8 Link (GMSK) + USB Cable 1 (Charging from Adapter 1) + Earphone 1						Relative Humidity :	46~48%		
Test Engineer :	Eric Shih, Stan Hsieh, Ken Wu and Derreck Chen						Polarization :	Vertical		
Remark :	Spurious emissions within 30-1000MHz were found more than 20dB below limit line.									
Frequency (MHz)	ERP (dBm)	Limit (dBm)	Over Limit (dB)	SPA Reading (dBm)	S.G. Power (dBm)	TX Cable loss (dB)	TX Antenna Gain (dBi)	Polarization (H/V)	Result	
1672	-42.22	-13	-29.22	-56.07	-43.9	0.99	4.82	V	Pass	
2512	-41.83	-13	-28.83	-58.55	-43.8	1.29	5.41	V	Pass	
3345	-47.79	-13	-34.79	-65.79	-51.4	1.56	7.32	V	Pass	



<High Channel>

Band :	GSM850	Temperature :	23~25°C						
Test Mode :	GPRS class 8 Link (GMSK) + USB Cable 1 (Charging from Adapter 1) + Earphone 1	Relative Humidity :	46~48%						
Test Engineer :	Eric Shih, Stan Hsieh, Ken Wu and Derreck Chen	Polarization :	Horizontal						
Remark :	Spurious emissions within 30-1000MHz were found more than 20dB below limit line.								
Frequency (MHz)	ERP (dBm)	Limit (dBm)	Over Limit (dB)	SPA Reading (dBm)	S.G. Power (dBm)	TX Cable loss (dB)	TX Antenna Gain (dBi)	Polarization (H/V)	Result
1696	-44.50	-13	-31.50	-56.04	-46.1	1.00	4.75	H	Pass
2544	-47.62	-13	-34.62	-63.41	-49.6	1.30	5.44	H	Pass
3393	-49.79	-13	-36.79	-66.46	-53.6	1.57	7.53	H	Pass

Band :	GSM850	Temperature :	23~25°C						
Test Mode :	GPRS class 8 Link (GMSK) + USB Cable 1 (Charging from Adapter 1) + Earphone 1	Relative Humidity :	46~48%						
Test Engineer :	Eric Shih, Stan Hsieh, Ken Wu and Derreck Chen	Polarization :	Vertical						
Remark :	Spurious emissions within 30-1000MHz were found more than 20dB below limit line.								
Frequency (MHz)	ERP (dBm)	Limit (dBm)	Over Limit (dB)	SPA Reading (dBm)	S.G. Power (dBm)	TX Cable loss (dB)	TX Antenna Gain (dBi)	Polarization (H/V)	Result
1696	-43.70	-13	-30.70	-57.59	-45.3	1.00	4.75	V	Pass
2544	-46.12	-13	-33.12	-62.5	-48.1	1.30	5.44	V	Pass
3393	-46.19	-13	-33.19	-66.01	-50	1.57	7.53	V	Pass



<Low Channel>

Band :	GSM850						Temperature :	23~25°C		
Test Mode :	EDGE class 8 Link (8PSK) + USB Cable 1 (Charging from Adapter 1) + Earphone 1						Relative Humidity :	46~48%		
Test Engineer :	Eric Shih, Stan Hsieh, Ken Wu and Derreck Chen						Polarization :	Horizontal		
Remark :	Spurious emissions within 30-1000MHz were found more than 20dB below limit line.									
Frequency (MHz)	ERP (dBm)	Limit (dBm)	Over Limit (dB)	SPA Reading (dBm)	S.G. Power (dBm)	TX Cable loss (dB)	TX Antenna Gain (dBi)	Polarization (H/V)	Result	
1648	-53.04	-13	-40.04	-64.32	-54.8	0.98	4.89	H	Pass	
2472	-50.12	-13	-37.12	-65.8	-52	1.28	5.32	H	Pass	
3298	-49.58	-13	-36.58	-66.08	-53	1.54	7.11	H	Pass	

Band :	GSM850						Temperature :	23~25°C		
Test Mode :	EDGE class 8 Link (8PSK) + USB Cable 1 (Charging from Adapter 1) + Earphone 1						Relative Humidity :	46~48%		
Test Engineer :	Eric Shih, Stan Hsieh, Ken Wu and Derreck Chen						Polarization :	Vertical		
Remark :	Spurious emissions within 30-1000MHz were found more than 20dB below limit line.									
Frequency (MHz)	ERP (dBm)	Limit (dBm)	Over Limit (dB)	SPA Reading (dBm)	S.G. Power (dBm)	TX Cable loss (dB)	TX Antenna Gain (dBi)	Polarization (H/V)	Result	
1648	-50.34	-13	-37.34	-63.72	-52.1	0.98	4.89	V	Pass	
2472	-50.02	-13	-37.02	-66.03	-51.9	1.28	5.32	V	Pass	
3298	-48.18	-13	-35.18	-65.91	-51.6	1.54	7.11	V	Pass	



<Middle Channel>

Band :	GSM850						Temperature :	23~25°C		
Test Mode :	EDGE class 8 Link (8PSK) + USB Cable 1 (Charging from Adapter 1) + Earphone 1						Relative Humidity :	46~48%		
Test Engineer :	Eric Shih, Stan Hsieh, Ken Wu and Derreck Chen						Polarization :	Horizontal		
Remark :	Spurious emissions within 30-1000MHz were found more than 20dB below limit line.									
Frequency (MHz)	ERP (dBm)	Limit (dBm)	Over Limit (dB)	SPA Reading (dBm)	S.G. Power (dBm)	TX Cable loss (dB)	TX Antenna Gain (dBi)	Polarization (H/V)	Result	
1672	-53.42	-13	-40.42	-64.88	-55.1	0.99	4.82	H	Pass	
2512	-49.43	-13	-36.43	-65.28	-51.4	1.29	5.41	H	Pass	
3345	-49.99	-13	-36.99	-66.42	-53.6	1.56	7.32	H	Pass	

Band :	GSM850						Temperature :	23~25°C		
Test Mode :	EDGE class 8 Link (8PSK) + USB Cable 1 (Charging from Adapter 1) + Earphone 1						Relative Humidity :	46~48%		
Test Engineer :	Eric Shih, Stan Hsieh, Ken Wu and Derreck Chen						Polarization :	Vertical		
Remark :	Spurious emissions within 30-1000MHz were found more than 20dB below limit line.									
Frequency (MHz)	ERP (dBm)	Limit (dBm)	Over Limit (dB)	SPA Reading (dBm)	S.G. Power (dBm)	TX Cable loss (dB)	TX Antenna Gain (dBi)	Polarization (H/V)	Result	
1672	-50.62	-13	-37.62	-64.24	-52.3	0.99	4.82	V	Pass	
2512	-48.93	-13	-35.93	-65.34	-50.9	1.29	5.41	V	Pass	
3345	-48.09	-13	-35.09	-66.13	-51.7	1.56	7.32	V	Pass	



<High Channel>

Band :	GSM850						Temperature :	23~25°C		
Test Mode :	EDGE class 8 Link (8PSK) + USB Cable 1 (Charging from Adapter 1) + Earphone 1						Relative Humidity :	46~48%		
Test Engineer :	Eric Shih, Stan Hsieh, Ken Wu and Derreck Chen						Polarization :	Horizontal		
Remark :	Spurious emissions within 30-1000MHz were found more than 20dB below limit line.									
Frequency (MHz)	ERP (dBm)	Limit (dBm)	Over Limit (dB)	SPA Reading (dBm)	S.G. Power (dBm)	TX Cable loss (dB)	TX Antenna Gain (dBi)	Polarization (H/V)	Result	
1696	-53.50	-13	-40.50	-64.97	-55.1	1.00	4.75	H	Pass	
2544	-52.32	-13	-39.32	-65.38	-54.3	1.30	5.44	H	Pass	
3393	-49.79	-13	-36.79	-66.51	-53.6	1.57	7.53	H	Pass	

Band :	GSM850						Temperature :	23~25°C		
Test Mode :	EDGE class 8 Link (8PSK) + USB Cable 1 (Charging from Adapter 1) + Earphone 1						Relative Humidity :	46~48%		
Test Engineer :	Eric Shih, Stan Hsieh, Ken Wu and Derreck Chen						Polarization :	Vertical		
Remark :	Spurious emissions within 30-1000MHz were found more than 20dB below limit line.									
Frequency (MHz)	ERP (dBm)	Limit (dBm)	Over Limit (dB)	SPA Reading (dBm)	S.G. Power (dBm)	TX Cable loss (dB)	TX Antenna Gain (dBi)	Polarization (H/V)	Result	
1696	-50.00	-13	-37.00	-63.58	-51.6	1.00	4.75	V	Pass	
2544	-48.97	-13	-35.97	-65.4	-53.1	1.30	5.44	V	Pass	
3393	-47.64	-13	-34.64	-65.53	-53.6	1.57	7.53	V	Pass	



<Low Channel>

Band :	GSM1900	Temperature :	23~25°C						
Test Mode :	GPRS class 8 Link (GMSK) + USB Cable 1 (Charging from Adapter 1) + Earphone 1	Relative Humidity :	46~48%						
Test Engineer :	Eric Shih, Stan Hsieh, Ken Wu and Derreck Chen	Polarization :	Horizontal						
Remark :	Spurious emissions within 30-1000MHz were found more than 20dB below limit line.								
Frequency (MHz)	EIRP (dBm)	Limit (dBm)	Over Limit (dB)	SPA Reading (dBm)	S.G. Power (dBm)	TX Cable loss (dB)	TX Antenna Gain (dBi)	Polarization (H/V)	Result
3700	-48.64	-13	-35.64	-65.92	-55.21	1.67	8.24	H	Pass
5550.6	-43.95	-13	-30.95	-66.88	-51.02	2.65	9.72	H	Pass
7400.8	-32.01	-13	-19.01	-61.31	-41.15	2.46	11.60	H	Pass

Band :	GSM1900	Temperature :	23~25°C						
Test Mode :	GPRS class 8 Link (GMSK) + USB Cable 1 (Charging from Adapter 1) + Earphone 1	Relative Humidity :	46~48%						
Test Engineer :	Eric Shih, Stan Hsieh, Ken Wu and Derreck Chen	Polarization :	Vertical						
Remark :	Spurious emissions within 30-1000MHz were found more than 20dB below limit line.								
Frequency (MHz)	EIRP (dBm)	Limit (dBm)	Over Limit (dB)	SPA Reading (dBm)	S.G. Power (dBm)	TX Cable loss (dB)	TX Antenna Gain (dBi)	Polarization (H/V)	Result
3700	-47.69	-13	-34.69	-66.29	-54.26	1.67	8.24	V	Pass
5550.6	-45.94	-13	-32.94	-67.96	-53.01	2.65	9.72	V	Pass
7400.8	-29.27	-13	-16.27	-58.18	-38.41	2.46	11.60	V	Pass



<Middle Channel>

Band :	GSM1900	Temperature :	23~25°C						
Test Mode :	GPRS class 8 Link (GMSK) + USB Cable 1 (Charging from Adapter 1) + Earphone 1	Relative Humidity :	46~48%						
Test Engineer :	Eric Shih, Stan Hsieh, Ken Wu and Derreck Chen	Polarization :	Horizontal						
Remark :	Spurious emissions within 30-1000MHz were found more than 20dB below limit line.								
Frequency (MHz)	EIRP (dBm)	Limit (dBm)	Over Limit (dB)	SPA Reading (dBm)	S.G. Power (dBm)	TX Cable loss (dB)	TX Antenna Gain (dBi)	Polarization (H/V)	Result
3756	-49.59	-13	-36.59	-67.03	-56.21	1.68	8.31	H	Pass
5640	-44.27	-13	-31.27	-66.66	-51.32	2.71	9.76	H	Pass
7522	-30.80	-13	-17.80	-59.79	-40.19	2.42	11.81	H	Pass

Band :	GSM1900	Temperature :	23~25°C						
Test Mode :	GPRS class 8 Link (GMSK) + USB Cable 1 (Charging from Adapter 1) + Earphone 1	Relative Humidity :	46~48%						
Test Engineer :	Eric Shih, Stan Hsieh, Ken Wu and Derreck Chen	Polarization :	Vertical						
Remark :	Spurious emissions within 30-1000MHz were found more than 20dB below limit line.								
Frequency (MHz)	EIRP (dBm)	Limit (dBm)	Over Limit (dB)	SPA Reading (dBm)	S.G. Power (dBm)	TX Cable loss (dB)	TX Antenna Gain (dBi)	Polarization (H/V)	Result
3756	-44.59	-13	-31.59	-62.86	-51.21	1.68	8.31	V	Pass
5640	-42.27	-13	-29.27	-64.41	-49.32	2.71	9.76	V	Pass
7520	-30.12	-13	-17.12	-59.37	-39.51	2.42	11.81	V	Pass



<High Channel>

Band :	GSM1900	Temperature :	23~25°C						
Test Mode :	GPRS class 8 Link (GMSK) + USB Cable 1 (Charging from Adapter 1) + Earphone 1	Relative Humidity :	46~48%						
Test Engineer :	Eric Shih, Stan Hsieh, Ken Wu and Derreck Chen	Polarization :	Horizontal						
Remark :	Spurious emissions within 30-1000MHz were found more than 20dB below limit line.								
Frequency (MHz)	EIRP (dBm)	Limit (dBm)	Over Limit (dB)	SPA Reading (dBm)	S.G. Power (dBm)	TX Cable loss (dB)	TX Antenna Gain (dBi)	Polarization (H/V)	Result
3819	-46.53	-13	-33.53	-64.57	-53.21	1.70	8.38	H	Pass
5729.4	-42.28	-13	-29.28	-65.08	-49.31	2.76	9.79	H	Pass
7639.2	-31.78	-13	-18.78	-59.92	-41.28	2.38	11.88	H	Pass

Band :	GSM1900	Temperature :	23~25°C						
Test Mode :	GPRS class 8 Link (GMSK) + USB Cable 1 (Charging from Adapter 1) + Earphone 1	Relative Humidity :	46~48%						
Test Engineer :	Eric Shih, Stan Hsieh, Ken Wu and Derreck Chen	Polarization :	Vertical						
Remark :	Spurious emissions within 30-1000MHz were found more than 20dB below limit line.								
Frequency (MHz)	EIRP (dBm)	Limit (dBm)	Over Limit (dB)	SPA Reading (dBm)	S.G. Power (dBm)	TX Cable loss (dB)	TX Antenna Gain (dBi)	Polarization (H/V)	Result
3819.6	-46.61	-13	-33.61	-64.94	-53.29	1.70	8.38	V	Pass
5729.4	-43.36	-13	-30.36	-65.82	-50.39	2.76	9.79	V	Pass
7639.2	-28.71	-13	-15.71	-57.55	-38.21	2.38	11.88	V	Pass



<Low Channel>

Band :	GSM1900		Temperature :	23~25°C					
Test Mode :	GPRS class 8 Link (GMSK) + PMA Charger + Earphone 1		Relative Humidity :	46~48%					
Test Engineer :	Eric Shih, Stan Hsieh, Ken Wu and Derreck Chen		Polarization :	Horizontal					
Remark :	Spurious emissions within 30-1000MHz were found more than 20dB below limit line.								
Frequency (MHz)	EIRP (dBm)	Limit (dBm)	Over Limit (dB)	SPA Reading (dBm)	S.G. Power (dBm)	TX Cable loss (dB)	TX Antenna Gain (dBi)	Polarization (H/V)	Result
3700	-48.90	-13	-35.90	-66.42	-55.47	1.67	8.24	H	Pass
5550.6	-44.22	-13	-31.22	-66.55	-51.29	2.65	9.72	H	Pass
7400.8	-33.31	-13	-20.31	-62.65	-42.45	2.46	11.60	H	Pass

Band :	GSM1900		Temperature :	23~25°C					
Test Mode :	GPRS class 8 Link (GMSK) + PMA Charger + Earphone 1		Relative Humidity :	46~48%					
Test Engineer :	Eric Shih, Stan Hsieh, Ken Wu and Derreck Chen		Polarization :	Vertical					
Remark :	Spurious emissions within 30-1000MHz were found more than 20dB below limit line.								
Frequency (MHz)	EIRP (dBm)	Limit (dBm)	Over Limit (dB)	SPA Reading (dBm)	S.G. Power (dBm)	TX Cable loss (dB)	TX Antenna Gain (dBi)	Polarization (H/V)	Result
3700	-47.71	-13	-34.71	-66.31	-54.28	1.67	8.24	V	Pass
5550.6	-44.02	-13	-31.02	-66.19	-51.09	2.65	9.72	V	Pass
7400.8	-29.99	-13	-16.99	-58.65	-39.13	2.46	11.60	V	Pass



<Middle Channel>

Band :	GSM1900	Temperature :	23~25°C						
Test Mode :	GPRS class 8 Link (GMSK) + PMA Charger + Earphone 1	Relative Humidity :	46~48%						
Test Engineer :	Eric Shih, Stan Hsieh, Ken Wu and Derreck Chen	Polarization :	Horizontal						
Remark :	Spurious emissions within 30-1000MHz were found more than 20dB below limit line.								
Frequency (MHz)	EIRP (dBm)	Limit (dBm)	Over Limit (dB)	SPA Reading (dBm)	S.G. Power (dBm)	TX Cable loss (dB)	TX Antenna Gain (dBi)	Polarization (H/V)	Result
3763	-48.99	-13	-35.99	-66.76	-55.62	1.69	8.32	H	Pass
5640	-44.18	-13	-31.18	-66.81	-51.23	2.71	9.76	H	Pass
7520	-33.70	-13	-20.70	-63.23	-43.09	2.42	11.81	H	Pass

Band :	GSM1900	Temperature :	23~25°C						
Test Mode :	GPRS class 8 Link (GMSK) + PMA Charger + Earphone 1	Relative Humidity :	46~48%						
Test Engineer :	Eric Shih, Stan Hsieh, Ken Wu and Derreck Chen	Polarization :	Vertical						
Remark :	Spurious emissions within 30-1000MHz were found more than 20dB below limit line.								
Frequency (MHz)	EIRP (dBm)	Limit (dBm)	Over Limit (dB)	SPA Reading (dBm)	S.G. Power (dBm)	TX Cable loss (dB)	TX Antenna Gain (dBi)	Polarization (H/V)	Result
3763	-47.76	-13	-34.76	-66.38	-54.39	1.69	8.32	V	Pass
5640	-41.96	-13	-28.96	-64.16	-49.01	2.71	9.76	V	Pass
7520	-30.90	-13	-17.90	-60.15	-40.29	2.42	11.81	V	Pass



<High Channel>

Band :	GSM1900		Temperature :	23~25°C					
Test Mode :	GPRS class 8 Link (GMSK) + PMA Charger + Earphone 1		Relative Humidity :	46~48%					
Test Engineer :	Eric Shih, Stan Hsieh, Ken Wu and Derreck Chen		Polarization :	Horizontal					
Remark :	Spurious emissions within 30-1000MHz were found more than 20dB below limit line.								
Frequency (MHz)	EIRP (dBm)	Limit (dBm)	Over Limit (dB)	SPA Reading (dBm)	S.G. Power (dBm)	TX Cable loss (dB)	TX Antenna Gain (dBi)	Polarization (H/V)	Result
3819	-48.33	-13	-35.33	-66.35	-55.01	1.70	8.38	H	Pass
5729.4	-43.55	-13	-30.55	-66.59	-50.58	2.76	9.79	H	Pass
7639.2	-33.11	-13	-20.11	-61.34	-42.61	2.38	11.88	H	Pass

Band :	GSM1900		Temperature :	23~25°C					
Test Mode :	GPRS class 8 Link (GMSK) + PMA Charger + Earphone 1		Relative Humidity :	46~48%					
Test Engineer :	Eric Shih, Stan Hsieh, Ken Wu and Derreck Chen		Polarization :	Vertical					
Remark :	Spurious emissions within 30-1000MHz were found more than 20dB below limit line.								
Frequency (MHz)	EIRP (dBm)	Limit (dBm)	Over Limit (dB)	SPA Reading (dBm)	S.G. Power (dBm)	TX Cable loss (dB)	TX Antenna Gain (dBi)	Polarization (H/V)	Result
3819	-47.71	-13	-34.71	-66.88	-54.39	1.70	8.38	V	Pass
5729.4	-41.28	-13	-28.28	-64.05	-48.31	2.76	9.79	V	Pass
7639.2	-31.11	-13	-18.11	-59.52	-40.61	2.38	11.88	V	Pass



<Low Channel>

Band :	GSM1900						Temperature :	23~25°C	
Test Mode :	GPRS class 8 Link (GMSK) + WPC Charger + Earphone 1						Relative Humidity :	46~48%	
Test Engineer :	Eric Shih, Stan Hsieh, Ken Wu and Derreck Chen						Polarization :	Horizontal	
Remark :	Spurious emissions within 30-1000MHz were found more than 20dB below limit line.								
Frequency (MHz)	EIRP (dBm)	Limit (dBm)	Over Limit (dB)	SPA Reading (dBm)	S.G. Power (dBm)	TX Cable loss (dB)	TX Antenna Gain (dBi)	Polarization (H/V)	Result
3700	-49.09	-13	-36.09	-66.76	-55.66	1.67	8.24	H	Pass
5548	-44.21	-13	-31.21	-67.17	-51.28	2.65	9.72	H	Pass
7403	-33.24	-13	-20.24	-62.98	-42.39	2.46	11.61	H	Pass

Band :	GSM1900						Temperature :	23~25°C	
Test Mode :	GPRS class 8 Link (GMSK) + WPC Charger + Earphone 1						Relative Humidity :	46~48%	
Test Engineer :	Eric Shih, Stan Hsieh, Ken Wu and Derreck Chen						Polarization :	Vertical	
Remark :	Spurious emissions within 30-1000MHz were found more than 20dB below limit line.								
Frequency (MHz)	EIRP (dBm)	Limit (dBm)	Over Limit (dB)	SPA Reading (dBm)	S.G. Power (dBm)	TX Cable loss (dB)	TX Antenna Gain (dBi)	Polarization (H/V)	Result
3700	-48.57	-13	-35.57	-67.25	-55.14	1.67	8.24	V	Pass
5548	-43.86	-13	-30.86	-66.54	-50.93	2.65	9.72	V	Pass
7403	-30.85	-13	-17.85	-60.37	-40	2.46	11.61	V	Pass



<Middle Channel>

Band :	GSM1900		Temperature :	23~25°C					
Test Mode :	GPRS class 8 Link (GMSK) + WPC Charger + Earphone 1		Relative Humidity :	46~48%					
Test Engineer :	Eric Shih, Stan Hsieh, Ken Wu and Derreck Chen		Polarization :	Horizontal					
Remark :	Spurious emissions within 30-1000MHz were found more than 20dB below limit line.								
Frequency (MHz)	EIRP (dBm)	Limit (dBm)	Over Limit (dB)	SPA Reading (dBm)	S.G. Power (dBm)	TX Cable loss (dB)	TX Antenna Gain (dBi)	Polarization (H/V)	Result
3763	-48.83	-13	-35.83	-66.75	-55.46	1.69	8.32	H	Pass
5639	-41.53	-13	-28.53	-64.81	-48.58	2.71	9.76	H	Pass
7522	-32.71	-13	-19.71	-62.5	-42.1	2.42	11.81	H	Pass

Band :	GSM1900		Temperature :	23~25°C					
Test Mode :	GPRS class 8 Link (GMSK) + WPC Charger + Earphone 1		Relative Humidity :	46~48%					
Test Engineer :	Eric Shih, Stan Hsieh, Ken Wu and Derreck Chen		Polarization :	Vertical					
Remark :	Spurious emissions within 30-1000MHz were found more than 20dB below limit line.								
Frequency (MHz)	EIRP (dBm)	Limit (dBm)	Over Limit (dB)	SPA Reading (dBm)	S.G. Power (dBm)	TX Cable loss (dB)	TX Antenna Gain (dBi)	Polarization (H/V)	Result
3763	-48.13	-13	-35.13	-66.96	-54.76	1.69	8.32	V	Pass
5639	-42.17	-13	-29.17	-65.26	-49.22	2.71	9.76	V	Pass
7522	-29.84	-13	-16.84	-59.42	-39.23	2.42	11.81	V	Pass



<High Channel>

Band :	GSM1900	Temperature :	23~25°C						
Test Mode :	GPRS class 8 Link (GMSK) + WPC Charger + Earphone 1	Relative Humidity :	46~48%						
Test Engineer :	Eric Shih, Stan Hsieh, Ken Wu and Derreck Chen	Polarization :	Horizontal						
Remark :	Spurious emissions within 30-1000MHz were found more than 20dB below limit line.								
Frequency (MHz)	EIRP (dBm)	Limit (dBm)	Over Limit (dB)	SPA Reading (dBm)	S.G. Power (dBm)	TX Cable loss (dB)	TX Antenna Gain (dBi)	Polarization (H/V)	Result
3819	-46.70	-13	-33.70	-64.86	-53.38	1.70	8.38	H	Pass
5730	-40.66	-13	-27.66	-64.22	-47.69	2.76	9.79	H	Pass
7641	-29.27	-13	-16.27	-58.05	-38.77	2.38	11.88	H	Pass

Band :	GSM1900	Temperature :	23~25°C						
Test Mode :	GPRS class 8 Link (GMSK) + WPC Charger + Earphone 1	Relative Humidity :	46~48%						
Test Engineer :	Eric Shih, Stan Hsieh, Ken Wu and Derreck Chen	Polarization :	Vertical						
Remark :	Spurious emissions within 30-1000MHz were found more than 20dB below limit line.								
Frequency (MHz)	EIRP (dBm)	Limit (dBm)	Over Limit (dB)	SPA Reading (dBm)	S.G. Power (dBm)	TX Cable loss (dB)	TX Antenna Gain (dBi)	Polarization (H/V)	Result
3819	-47.64	-13	-34.64	-66.64	-54.32	1.70	8.38	V	Pass
5730	-43.81	-13	-30.81	-67.18	-50.84	2.76	9.79	V	Pass
7641	-30.00	-13	-17.00	-58.75	-39.5	2.38	11.88	V	Pass



<Low Channel>

Band :	GSM1900						Temperature :	23~25°C		
Test Mode :	EDGE class 8 Link (8PSK) + USB Cable 1 (Charging from Adapter 1) + Earphone 1						Relative Humidity :	46~48%		
Test Engineer :	Eric Shih, Stan Hsieh, Ken Wu and Derreck Chen						Polarization :	Horizontal		
Remark :	Spurious emissions within 30-1000MHz were found more than 20dB below limit line.									
Frequency (MHz)	EIRP (dBm)	Limit (dBm)	Over Limit (dB)	SPA Reading (dBm)	S.G. Power (dBm)	TX Cable loss (dB)	TX Antenna Gain (dBi)	Polarization (H/V)	Result	
3700	-48.70	-13	-35.70	-66.36	-55.27	1.67	8.24	H	Pass	
5550.6	-45.24	-13	-32.24	-67.76	-52.31	2.65	9.72	H	Pass	
7400.8	-34.91	-13	-21.91	-64.2	-44.05	2.46	11.60	H	Pass	

Band :	GSM1900						Temperature :	23~25°C		
Test Mode :	EDGE class 8 Link (8PSK) + USB Cable 1 (Charging from Adapter 1) + Earphone 1						Relative Humidity :	46~48%		
Test Engineer :	Eric Shih, Stan Hsieh, Ken Wu and Derreck Chen						Polarization :	Vertical		
Remark :	Spurious emissions within 30-1000MHz were found more than 20dB below limit line.									
Frequency (MHz)	EIRP (dBm)	Limit (dBm)	Over Limit (dB)	SPA Reading (dBm)	S.G. Power (dBm)	TX Cable loss (dB)	TX Antenna Gain (dBi)	Polarization (H/V)	Result	
3700	-47.44	-13	-34.44	-65.93	-54.01	1.67	8.24	V	Pass	
5550.6	-45.32	-13	-32.32	-67.36	-52.39	2.65	9.72	V	Pass	
7400.8	-33.72	-13	-20.72	-62.59	-42.86	2.46	11.60	V	Pass	



<Middle Channel>

Band :	GSM1900	Temperature :	23~25°C						
Test Mode :	EDGE class 8 Link (8PSK) + USB Cable 1 (Charging from Adapter 1) + Earphone 1	Relative Humidity :	46~48%						
Test Engineer :	Eric Shih, Stan Hsieh, Ken Wu and Derreck Chen	Polarization :	Horizontal						
Remark :	Spurious emissions within 30-1000MHz were found more than 20dB below limit line.								
Frequency (MHz)	EIRP (dBm)	Limit (dBm)	Over Limit (dB)	SPA Reading (dBm)	S.G. Power (dBm)	TX Cable loss (dB)	TX Antenna Gain (dBi)	Polarization (H/V)	Result
3763	-49.09	-13	-36.09	-66.9	-55.72	1.69	8.32	H	Pass
5640	-44.24	-13	-31.24	-66.71	-51.29	2.71	9.76	H	Pass
7520	-35.32	-13	-22.32	-64.43	-44.71	2.42	11.81	H	Pass

Band :	GSM1900	Temperature :	23~25°C						
Test Mode :	EDGE class 8 Link (8PSK) + USB Cable 1 (Charging from Adapter 1) + Earphone 1	Relative Humidity :	46~48%						
Test Engineer :	Eric Shih, Stan Hsieh, Ken Wu and Derreck Chen	Polarization :	Vertical						
Remark :	Spurious emissions within 30-1000MHz were found more than 20dB below limit line.								
Frequency (MHz)	EIRP (dBm)	Limit (dBm)	Over Limit (dB)	SPA Reading (dBm)	S.G. Power (dBm)	TX Cable loss (dB)	TX Antenna Gain (dBi)	Polarization (H/V)	Result
3763	-47.08	-13	-34.08	-65.84	-53.71	1.69	8.32	V	Pass
5640	-44.59	-13	-31.59	-66.78	-51.64	2.71	9.76	V	Pass
7520	-34.24	-13	-21.24	-63.59	-43.63	2.42	11.81	V	Pass



<High Channel>

Band :	GSM1900	Temperature :	23~25°C						
Test Mode :	EDGE class 8 Link (8PSK) + USB Cable 1 (Charging from Adapter 1) + Earphone 1	Relative Humidity :	46~48%						
Test Engineer :	Eric Shih, Stan Hsieh, Ken Wu and Derreck Chen	Polarization :	Horizontal						
Remark :	Spurious emissions within 30-1000MHz were found more than 20dB below limit line.								
Frequency (MHz)	EIRP (dBm)	Limit (dBm)	Over Limit (dB)	SPA Reading (dBm)	S.G. Power (dBm)	TX Cable loss (dB)	TX Antenna Gain (dBi)	Polarization (H/V)	Result
3819.6	-48.54	-13	-35.54	-66.44	-55.22	1.70	8.38	H	Pass
5729.4	-44.24	-13	-31.24	-67.32	-51.27	2.76	9.79	H	Pass
7641	-33.34	-13	-20.34	-61.83	-42.84	2.38	11.88	H	Pass

Band :	GSM1900	Temperature :	23~25°C						
Test Mode :	EDGE class 8 Link (8PSK) + USB Cable 1 (Charging from Adapter 1) + Earphone 1	Relative Humidity :	46~48%						
Test Engineer :	Eric Shih, Stan Hsieh, Ken Wu and Derreck Chen	Polarization :	Vertical						
Remark :	Spurious emissions within 30-1000MHz were found more than 20dB below limit line.								
Frequency (MHz)	EIRP (dBm)	Limit (dBm)	Over Limit (dB)	SPA Reading (dBm)	S.G. Power (dBm)	TX Cable loss (dB)	TX Antenna Gain (dBi)	Polarization (H/V)	Result
3819	-48.59	-13	-35.59	-66.93	-55.27	1.70	8.38	V	Pass
5729.4	-44.90	-13	-31.90	-67.9	-51.93	2.76	9.79	V	Pass
7639.2	-32.91	-13	-19.91	-61.34	-42.41	2.38	11.88	V	Pass



<Low Channel>

Band :	WCDMA Band V							Temperature :	23~25°C	
Test Mode :	RMC 12.2Kbps Link (QPSK) + USB Cable 1 (Charging from Adapter 1) + Earphone 1							Relative Humidity :	46~48%	
Test Engineer :	Eric Shih, Stan Hsieh, Ken Wu and Derreck Chen							Polarization :	Horizontal	
Remark :	Spurious emissions within 30-1000MHz were found more than 20dB below limit line.									
Frequency (MHz)	ERP (dBm)	Limit (dBm)	Over Limit (dB)	SPA Reading (dBm)	S.G. Power (dBm)	TX Cable loss (dB)	TX Antenna Gain (dBi)	Polarization (H/V)	Result	
1653	-53.26	-13	-40.26	-64.5	-55	0.98	4.87	H	Pass	
2479	-49.30	-13	-36.30	-64.87	-51.2	1.28	5.34	H	Pass	
3305	-50.25	-13	-37.25	-66.72	-53.7	1.54	7.14	H	Pass	

Band :	WCDMA Band V							Temperature :	23~25°C	
Test Mode :	RMC 12.2Kbps Link (QPSK) + USB Cable 1 (Charging from Adapter 1) + Earphone 1							Relative Humidity :	46~48%	
Test Engineer :	Eric Shih, Stan Hsieh, Ken Wu and Derreck Chen							Polarization :	Vertical	
Remark :	Spurious emissions within 30-1000MHz were found more than 20dB below limit line.									
Frequency (MHz)	ERP (dBm)	Limit (dBm)	Over Limit (dB)	SPA Reading (dBm)	S.G. Power (dBm)	TX Cable loss (dB)	TX Antenna Gain (dBi)	Polarization (H/V)	Result	
1653	-50.76	-13	-37.76	-64.28	-52.5	0.98	4.87	V	Pass	
2479	-49.30	-13	-36.30	-65.29	-51.2	1.28	5.34	V	Pass	
3305	-48.55	-13	-35.55	-66.56	-52	1.54	7.14	V	Pass	



<Middle Channel>

Band :	WCDMA Band V							Temperature :	23~25°C	
Test Mode :	RMC 12.2Kbps Link (QPSK) + USB Cable 1 (Charging from Adapter 1) + Earphone 1							Relative Humidity :	46~48%	
Test Engineer :	Eric Shih, Stan Hsieh, Ken Wu and Derreck Chen							Polarization :	Horizontal	
Remark :	Spurious emissions within 30-1000MHz were found more than 20dB below limit line.									
Frequency (MHz)	ERP (dBm)	Limit (dBm)	Over Limit (dB)	SPA Reading (dBm)	S.G. Power (dBm)	TX Cable loss (dB)	TX Antenna Gain (dBi)	Polarization (H/V)	Result	
1672	-53.72	-13	-40.72	-65.32	-55.4	0.99	4.82	H	Pass	
2510	-48.94	-13	-35.94	-64.78	-50.9	1.29	5.41	H	Pass	
3345	-49.99	-13	-36.99	-66.3	-53.6	1.56	7.32	H	Pass	

Band :	WCDMA Band V							Temperature :	23~25°C	
Test Mode :	RMC 12.2Kbps Link (QPSK) + USB Cable 1 (Charging from Adapter 1) + Earphone 1							Relative Humidity :	46~48%	
Test Engineer :	Eric Shih, Stan Hsieh, Ken Wu and Derreck Chen							Polarization :	Vertical	
Remark :	Spurious emissions within 30-1000MHz were found more than 20dB below limit line.									
Frequency (MHz)	ERP (dBm)	Limit (dBm)	Over Limit (dB)	SPA Reading (dBm)	S.G. Power (dBm)	TX Cable loss (dB)	TX Antenna Gain (dBi)	Polarization (H/V)	Result	
1672	-51.22	-13	-38.22	-64.99	-52.9	0.99	4.82	V	Pass	
2510	-48.64	-13	-35.64	-64.54	-50.6	1.29	5.41	V	Pass	
3345	-48.19	-13	-35.19	-66.36	-51.8	1.56	7.32	V	Pass	



<High Channel>

Band :	WCDMA Band V							Temperature :	23~25°C	
Test Mode :	RMC 12.2Kbps Link (QPSK) + USB Cable 1 (Charging from Adapter 1) + Earphone 1							Relative Humidity :	46~48%	
Test Engineer :	Eric Shih, Stan Hsieh, Ken Wu and Derreck Chen							Polarization :	Horizontal	
Remark :	Spurious emissions within 30-1000MHz were found more than 20dB below limit line.									
Frequency (MHz)	ERP (dBm)	Limit (dBm)	Over Limit (dB)	SPA Reading (dBm)	S.G. Power (dBm)	TX Cable loss (dB)	TX Antenna Gain (dBi)	Polarization (H/V)	Result	
1693	-53.09	-13	-40.09	-64.65	-54.7	1.00	4.76	H	Pass	
2540	-49.62	-13	-36.62	-65.46	-51.6	1.30	5.43	H	Pass	
3386	-49.72	-13	-36.72	-66.28	-53.5	1.57	7.50	H	Pass	

Band :	WCDMA Band V							Temperature :	23~25°C	
Test Mode :	RMC 12.2Kbps Link (QPSK) + USB Cable 1 (Charging from Adapter 1) + Earphone 1							Relative Humidity :	46~48%	
Test Engineer :	Eric Shih, Stan Hsieh, Ken Wu and Derreck Chen							Polarization :	Vertical	
Remark :	Spurious emissions within 30-1000MHz were found more than 20dB below limit line.									
Frequency (MHz)	ERP (dBm)	Limit (dBm)	Over Limit (dB)	SPA Reading (dBm)	S.G. Power (dBm)	TX Cable loss (dB)	TX Antenna Gain (dBi)	Polarization (H/V)	Result	
1693	-50.79	-13	-37.79	-64.29	-52.4	1.00	4.76	V	Pass	
2540	-49.32	-13	-36.32	-65.58	-51.3	1.30	5.43	V	Pass	
3386	-48.92	-13	-35.92	-66.72	-52.7	1.57	7.50	V	Pass	



<Low Channel>

Band :	WCDMA Band II	Temperature :	23~25°C						
Test Mode :	RMC 12.2Kbps Link (QPSK) + USB Cable 1 (Charging from Adapter 1) + Earphone 1	Relative Humidity :	46~48%						
Test Engineer :	Eric Shih, Stan Hsieh, Ken Wu and Derreck Chen	Polarization :	Horizontal						
Remark :	Spurious emissions within 30-1000MHz were found more than 20dB below limit line.								
Frequency (MHz)	EIRP (dBm)	Limit (dBm)	Over Limit (dB)	SPA Reading (dBm)	S.G. Power (dBm)	TX Cable loss (dB)	TX Antenna Gain (dBi)	Polarization (H/V)	Result
3707	-48.63	-13	-35.63	-65.94	-55.21	1.67	8.25	H	Pass
5557.2	-44.23	-13	-31.23	-66.7	-51.29	2.66	9.72	H	Pass
7409.6	-37.63	-13	-24.63	-67.43	-46.79	2.46	11.62	H	Pass

Band :	WCDMA Band II	Temperature :	23~25°C						
Test Mode :	RMC 12.2Kbps Link (QPSK) + USB Cable 1 (Charging from Adapter 1) + Earphone 1	Relative Humidity :	46~48%						
Test Engineer :	Eric Shih, Stan Hsieh, Ken Wu and Derreck Chen	Polarization :	Vertical						
Remark :	Spurious emissions within 30-1000MHz were found more than 20dB below limit line.								
Frequency (MHz)	EIRP (dBm)	Limit (dBm)	Over Limit (dB)	SPA Reading (dBm)	S.G. Power (dBm)	TX Cable loss (dB)	TX Antenna Gain (dBi)	Polarization (H/V)	Result
3707	-48.43	-13	-35.43	-66.8	-55.01	1.67	8.25	V	Pass
5557.2	-45.30	-13	-32.30	-67.31	-52.36	2.66	9.72	V	Pass
7409.6	-35.87	-13	-22.87	-67.94	-45.03	2.46	11.62	V	Pass



<Middle Channel>

Band :	WCDMA Band II	Temperature :	23~25°C						
Test Mode :	RMC 12.2Kbps Link (QPSK) + USB Cable 1 (Charging from Adapter 1) + Earphone 1	Relative Humidity :	46~48%						
Test Engineer :	Eric Shih, Stan Hsieh, Ken Wu and Derreck Chen	Polarization :	Horizontal						
Remark :	Spurious emissions within 30-1000MHz were found more than 20dB below limit line.								
Frequency (MHz)	EIRP (dBm)	Limit (dBm)	Over Limit (dB)	SPA Reading (dBm)	S.G. Power (dBm)	TX Cable loss (dB)	TX Antenna Gain (dBi)	Polarization (H/V)	Result
3763	-49.58	-13	-36.58	-67.03	-56.21	1.69	8.32	H	Pass
5640	-44.38	-13	-31.38	-66.72	-51.43	2.71	9.76	H	Pass
7520	-38.42	-13	-25.42	-67.75	-47.81	2.42	11.81	H	Pass

Band :	WCDMA Band II	Temperature :	23~25°C						
Test Mode :	RMC 12.2Kbps Link (QPSK) + USB Cable 1 (Charging from Adapter 1) + Earphone 1	Relative Humidity :	46~48%						
Test Engineer :	Eric Shih, Stan Hsieh, Ken Wu and Derreck Chen	Polarization :	Vertical						
Remark :	Spurious emissions within 30-1000MHz were found more than 20dB below limit line.								
Frequency (MHz)	EIRP (dBm)	Limit (dBm)	Over Limit (dB)	SPA Reading (dBm)	S.G. Power (dBm)	TX Cable loss (dB)	TX Antenna Gain (dBi)	Polarization (H/V)	Result
3763	-48.66	-13	-35.66	-66.9	-55.29	1.69	8.32	V	Pass
5640	-44.26	-13	-31.26	-66.96	-51.31	2.71	9.76	V	Pass
7520	-39.22	-13	-26.22	-68.24	-48.61	2.42	11.81	V	Pass



<High Channel>

Band :	WCDMA Band II	Temperature :	23~25°C						
Test Mode :	RMC 12.2Kbps Link (QPSK) + USB Cable 1 (Charging from Adapter 1) + Earphone 1	Relative Humidity :	46~48%						
Test Engineer :	Eric Shih, Stan Hsieh, Ken Wu and Derreck Chen	Polarization :	Horizontal						
Remark :	Spurious emissions within 30-1000MHz were found more than 20dB below limit line.								
Frequency (MHz)	EIRP (dBm)	Limit (dBm)	Over Limit (dB)	SPA Reading (dBm)	S.G. Power (dBm)	TX Cable loss (dB)	TX Antenna Gain (dBi)	Polarization (H/V)	Result
38123	-49.06	-13	-36.06	-67.04	-59.22	3.74	13.90	H	Pass
5722	-45.32	-13	-32.32	-68.05	-52.36	2.75	9.79	H	Pass
7630	-39.12	-13	-26.12	-67.24	-48.61	2.39	11.88	H	Pass

Band :	WCDMA Band II	Temperature :	23~25°C						
Test Mode :	RMC 12.2Kbps Link (QPSK) + USB Cable 1 (Charging from Adapter 1) + Earphone 1	Relative Humidity :	46~48%						
Test Engineer :	Eric Shih, Stan Hsieh, Ken Wu and Derreck Chen	Polarization :	Vertical						
Remark :	Spurious emissions within 30-1000MHz were found more than 20dB below limit line.								
Frequency (MHz)	EIRP (dBm)	Limit (dBm)	Over Limit (dB)	SPA Reading (dBm)	S.G. Power (dBm)	TX Cable loss (dB)	TX Antenna Gain (dBi)	Polarization (H/V)	Result
3812	-47.57	-13	-34.57	-66.61	-54.24	1.70	8.37	V	Pass
5722.8	-43.45	-13	-30.45	-66.44	-50.49	2.75	9.79	V	Pass
7630.4	-38.58	-13	-25.58	-67.14	-48.07	2.39	11.88	V	Pass



<Low Channel>

Band :	CDMA2000 BC0	Temperature :	23~25°C						
Test Mode :	1xRTT_RC3+SO32 (QPSK) + USB Cable 1 (Charging from Adapter 1) + Earphone 1	Relative Humidity :	46~48%						
Test Engineer :	Eric Shih, Stan Hsieh, Ken Wu and Derreck Chen	Polarization :	Horizontal						
Remark :	Spurious emissions within 30-1000MHz were found more than 20dB below limit line.								
Frequency (MHz)	ERP (dBm)	Limit (dBm)	Over Limit (dB)	SPA Reading (dBm)	S.G. Power (dBm)	TX Cable loss (dB)	TX Antenna Gain (dBi)	Polarization (H/V)	Result
1648	-50.14	-13	-37.14	-61.39	-51.9	0.98	4.89	H	Pass
2474	-49.81	-13	-36.81	-65.56	-51.7	1.28	5.32	H	Pass
3298	-49.68	-13	-36.68	-65.94	-53.1	1.54	7.11	H	Pass

Band :	CDMA2000 BC0	Temperature :	23~25°C						
Test Mode :	1xRTT_RC3+SO32 (QPSK) + USB Cable 1 (Charging from Adapter 1) + Earphone 1	Relative Humidity :	46~48%						
Test Engineer :	Eric Shih, Stan Hsieh, Ken Wu and Derreck Chen	Polarization :	Vertical						
Remark :	Spurious emissions within 30-1000MHz were found more than 20dB below limit line.								
Frequency (MHz)	ERP (dBm)	Limit (dBm)	Over Limit (dB)	SPA Reading (dBm)	S.G. Power (dBm)	TX Cable loss (dB)	TX Antenna Gain (dBi)	Polarization (H/V)	Result
1648	-49.54	-13	-36.54	-62.54	-51.3	0.98	4.89	V	Pass
2474	-49.41	-13	-36.41	-65.4	-51.3	1.28	5.32	V	Pass
3298	-48.18	-13	-35.18	-66.09	-51.6	1.54	7.11	V	Pass



<Middle Channel>

Band :	CDMA2000 BC0	Temperature :	23~25°C						
Test Mode :	1xRTT_RC3+SO32 (QPSK) + USB Cable 1 (Charging from Adapter 1) + Earphone 1	Relative Humidity :	46~48%						
Test Engineer :	Eric Shih, Stan Hsieh, Ken Wu and Derreck Chen	Polarization :	Horizontal						
Remark :	Spurious emissions within 30-1000MHz were found more than 20dB below limit line.								
Frequency (MHz)	ERP (dBm)	Limit (dBm)	Over Limit (dB)	SPA Reading (dBm)	S.G. Power (dBm)	TX Cable loss (dB)	TX Antenna Gain (dBi)	Polarization (H/V)	Result
1672	-52.22	-13	-39.22	-63.67	-53.9	0.99	4.82	H	Pass
2510	-48.94	-13	-35.94	-64.59	-50.9	1.29	5.41	H	Pass
3346	-50.18	-13	-37.18	-66.61	-53.8	1.56	7.32	H	Pass

Band :	CDMA2000 BC0	Temperature :	23~25°C						
Test Mode :	1xRTT_RC3+SO32 (QPSK) + USB Cable 1 (Charging from Adapter 1) + Earphone 1	Relative Humidity :	46~48%						
Test Engineer :	Eric Shih, Stan Hsieh, Ken Wu and Derreck Chen	Polarization :	Vertical						
Remark :	Spurious emissions within 30-1000MHz were found more than 20dB below limit line.								
Frequency (MHz)	ERP (dBm)	Limit (dBm)	Over Limit (dB)	SPA Reading (dBm)	S.G. Power (dBm)	TX Cable loss (dB)	TX Antenna Gain (dBi)	Polarization (H/V)	Result
1672	-48.42	-13	-35.42	-62.05	-50.1	0.99	4.82	V	Pass
2510	-49.64	-13	-36.64	-65.68	-51.6	1.29	5.41	V	Pass
3346	-48.48	-13	-35.48	-66.16	-52.1	1.56	7.32	V	Pass



<High Channel>

Band :	CDMA2000 BC0	Temperature :	23~25°C						
Test Mode :	1xRTT_RC3+SO32 (QPSK) + USB Cable 1 (Charging from Adapter 1) + Earphone 1	Relative Humidity :	46~48%						
Test Engineer :	Eric Shih, Stan Hsieh, Ken Wu and Derreck Chen	Polarization :	Horizontal						
Remark :	Spurious emissions within 30-1000MHz were found more than 20dB below limit line.								
Frequency (MHz)	ERP (dBm)	Limit (dBm)	Over Limit (dB)	SPA Reading (dBm)	S.G. Power (dBm)	TX Cable loss (dB)	TX Antenna Gain (dBi)	Polarization (H/V)	Result
1696	-50.80	-13	-37.80	-62.34	-52.4	1.00	4.75	H	Pass
2544	-48.92	-13	-35.92	-64.56	-50.9	1.30	5.44	H	Pass
3393	-49.79	-13	-36.79	-66.13	-53.6	1.57	7.53	H	Pass

Band :	CDMA2000 BC0	Temperature :	23~25°C						
Test Mode :	1xRTT_RC3+SO32 (QPSK) + USB Cable 1 (Charging from Adapter 1) + Earphone 1	Relative Humidity :	46~48%						
Test Engineer :	Eric Shih, Stan Hsieh, Ken Wu and Derreck Chen	Polarization :	Vertical						
Remark :	Spurious emissions within 30-1000MHz were found more than 20dB below limit line.								
Frequency (MHz)	ERP (dBm)	Limit (dBm)	Over Limit (dB)	SPA Reading (dBm)	S.G. Power (dBm)	TX Cable loss (dB)	TX Antenna Gain (dBi)	Polarization (H/V)	Result
1696	-48.50	-13	-35.50	-62.2	-50.1	1.00	4.75	V	Pass
2544	-49.22	-13	-36.22	-65.34	-51.2	1.30	5.44	V	Pass
3393	-48.39	-13	-35.39	-66.23	-52.2	1.57	7.53	V	Pass



<Low Channel>

Band :	CDMA2000 BC1	Temperature :	23~25°C						
Test Mode :	1xRTT_RC3+SO32 (QPSK) + USB Cable 1 (Charging from Adapter 1) + Earphone 1	Relative Humidity :	46~48%						
Test Engineer :	Eric Shih, Stan Hsieh, Ken Wu and Derreck Chen	Polarization :	Horizontal						
Remark :	Spurious emissions within 30-1000MHz were found more than 20dB below limit line.								
Frequency (MHz)	EIRP (dBm)	Limit (dBm)	Over Limit (dB)	SPA Reading (dBm)	S.G. Power (dBm)	TX Cable loss (dB)	TX Antenna Gain (dBi)	Polarization (H/V)	Result
3700	-49.33	-13	-36.33	-66.66	-55.9	1.67	8.24	H	Pass
5554	-43.73	-13	-30.73	-66.68	-50.8	2.66	9.72	H	Pass
7405	-38.95	-13	-25.95	-68.47	-48.1	2.46	11.61	H	Pass

Band :	CDMA2000 BC1	Temperature :	23~25°C						
Test Mode :	1xRTT_RC3+SO32 (QPSK) + USB Cable 1 (Charging from Adapter 1) + Earphone 1	Relative Humidity :	46~48%						
Test Engineer :	Eric Shih, Stan Hsieh, Ken Wu and Derreck Chen	Polarization :	Vertical						
Remark :	Spurious emissions within 30-1000MHz were found more than 20dB below limit line.								
Frequency (MHz)	EIRP (dBm)	Limit (dBm)	Over Limit (dB)	SPA Reading (dBm)	S.G. Power (dBm)	TX Cable loss (dB)	TX Antenna Gain (dBi)	Polarization (H/V)	Result
3700	-47.93	-13	-34.93	-66.54	-54.5	1.67	8.24	V	Pass
5554	-44.73	-13	-31.73	-67.39	-51.8	2.66	9.72	V	Pass
7405	-37.75	-13	-24.75	-66.9	-46.9	2.46	11.61	V	Pass



<Middle Channel>

Band :	CDMA2000 BC1	Temperature :	23~25°C						
Test Mode :	1xRTT_RC3+SO32 (QPSK) + USB Cable 1 (Charging from Adapter 1) + Earphone 1	Relative Humidity :	46~48%						
Test Engineer :	Eric Shih, Stan Hsieh, Ken Wu and Derreck Chen	Polarization :	Horizontal						
Remark :	Spurious emissions within 30-1000MHz were found more than 20dB below limit line.								
Frequency (MHz)	EIRP (dBm)	Limit (dBm)	Over Limit (dB)	SPA Reading (dBm)	S.G. Power (dBm)	TX Cable loss (dB)	TX Antenna Gain (dBi)	Polarization (H/V)	Result
3763	-47.58	-13	-34.58	-65.1	-54.21	1.69	8.32	H	Pass
5640	-44.96	-13	-31.96	-67.35	-52.01	2.71	9.76	H	Pass
7520	-38.24	-13	-25.24	-67.59	-47.63	2.42	11.81	H	Pass

Band :	CDMA2000 BC1	Temperature :	23~25°C						
Test Mode :	1xRTT_RC3+SO32 (QPSK) + USB Cable 1 (Charging from Adapter 1) + Earphone 1	Relative Humidity :	46~48%						
Test Engineer :	Eric Shih, Stan Hsieh, Ken Wu and Derreck Chen	Polarization :	Vertical						
Remark :	Spurious emissions within 30-1000MHz were found more than 20dB below limit line.								
Frequency (MHz)	EIRP (dBm)	Limit (dBm)	Over Limit (dB)	SPA Reading (dBm)	S.G. Power (dBm)	TX Cable loss (dB)	TX Antenna Gain (dBi)	Polarization (H/V)	Result
3763	-47.66	-13	-34.66	-66.69	-54.29	1.69	8.32	V	Pass
5640	-44.16	-13	-31.16	-66.82	-51.21	2.71	9.76	V	Pass
7520	-39.24	-13	-26.24	-68.23	-48.63	2.42	11.81	V	Pass



<High Channel>

Band :	CDMA2000 BC1	Temperature :	23~25°C						
Test Mode :	1xRTT_RC3+SO32 (QPSK) + USB Cable 1 (Charging from Adapter 1) + Earphone 1	Relative Humidity :	46~48%						
Test Engineer :	Eric Shih, Stan Hsieh, Ken Wu and Derreck Chen	Polarization :	Horizontal						
Remark :	Spurious emissions within 30-1000MHz were found more than 20dB below limit line.								
Frequency (MHz)	EIRP (dBm)	Limit (dBm)	Over Limit (dB)	SPA Reading (dBm)	S.G. Power (dBm)	TX Cable loss (dB)	TX Antenna Gain (dBi)	Polarization (H/V)	Result
3819	-49.52	-13	-36.52	-67.51	-56.2	1.70	8.38	H	Pass
5726	-44.86	-13	-31.86	-67.93	-51.9	2.76	9.79	H	Pass
7635	-38.80	-13	-25.80	-67.64	-48.3	2.39	11.88	H	Pass

Band :	CDMA2000 BC1	Temperature :	23~25°C						
Test Mode :	1xRTT_RC3+SO32 (QPSK) + USB Cable 1 (Charging from Adapter 1) + Earphone 1	Relative Humidity :	46~48%						
Test Engineer :	Eric Shih, Stan Hsieh, Ken Wu and Derreck Chen	Polarization :	Vertical						
Remark :	Spurious emissions within 30-1000MHz were found more than 20dB below limit line.								
Frequency (MHz)	EIRP (dBm)	Limit (dBm)	Over Limit (dB)	SPA Reading (dBm)	S.G. Power (dBm)	TX Cable loss (dB)	TX Antenna Gain (dBi)	Polarization (H/V)	Result
3819	-48.42	-13	-35.42	-67.37	-55.1	1.70	8.38	V	Pass
5726	-44.46	-13	-31.46	-67.64	-51.5	2.76	9.79	V	Pass
7635	-38.90	-13	-25.90	-67.37	-48.4	2.39	11.88	V	Pass



3.8 Frequency Stability Measurement

3.8.1 Description of Frequency Stability Measurement

The frequency stability shall be measured by variation of ambient temperature and variation of primary supply voltage to ensure that the fundamental emission stays within the authorized frequency block. The frequency stability of the transmitter shall be maintained within $\pm 0.00025\%$ ($\pm 2.5\text{ppm}$) of the center frequency.

3.8.2 Measuring Instruments

The measuring equipment is listed in the section 4 of this test report.

3.8.3 Test Procedures for Temperature Variation

1. The testing follows FCC KDB 971168 v02r02 Section 9.0.
2. The EUT was set up in the thermal chamber and connected with the system simulator.
3. With power OFF, the temperature was decreased to -30°C and the EUT was stabilized before testing. Power was applied and the maximum change in frequency was recorded within one minute.
4. With power OFF, the temperature was raised in 10°C steps up to 50°C . The EUT was stabilized at each step for at least half an hour. Power was applied and the maximum frequency change was recorded within one minute.

3.8.4 Test Procedures for Voltage Variation

1. The testing follows FCC KDB 971168 v02r02 Section 9.0.
2. The EUT was placed in a temperature chamber at $25\pm 5^{\circ}\text{C}$ and connected with the system simulator.
3. The power supply voltage to the EUT was varied from BEP to 115% of the nominal value measured at the input to the EUT.
4. The variation in frequency was measured for the worst case.

3.8.5 Test Setup

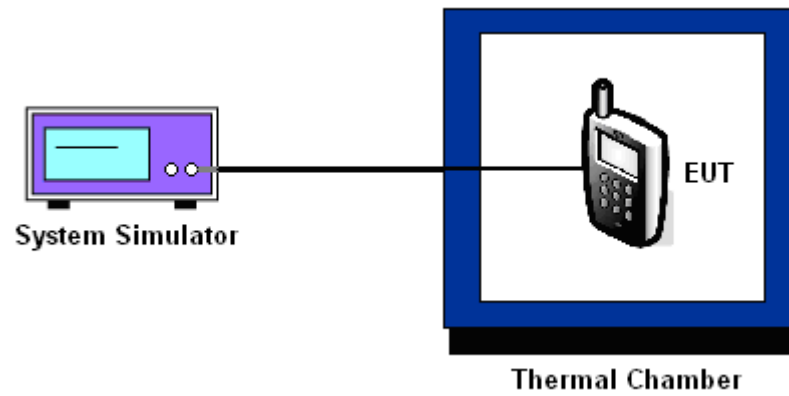



3.8.6 Test Result of Temperature Variation

Band :	GSM 850	Channel :	189
Limit (ppm) :	2.5	Frequency :	836.4 MHz

Temperature (°C)	GPRS class 8	EDGE class 8	Result
	Deviation (ppm)	Deviation (ppm)	
50	0.0143	0.0084	PASS
40	0.0120	0.0048	
30	0.0024	0.0024	
20(Ref.)	0.0000	0.0000	
10	0.0024	0.0012	
0	0.0060	0.0024	
-10	0.0084	0.0012	
-20	0.0108	0.0036	
-30	0.0096	0.0060	

Band :	GSM 1900	Channel :	661
Limit (ppm) :	within authorized band	Frequency :	1880.0 MHz

Temperature (°C)	GPRS class 8	EDGE class 8	Result
	Deviation (ppm)	Deviation (ppm)	
50	0.0207	0.0021	PASS
40	0.0005	0.0011	
30	0.0021	0.0027	
20(Ref.)	0.0000	0.0000	
10	0.0016	0.0016	
0	0.0186	0.0005	
-10	0.0027	0.0005	
-20	0.0011	0.0011	
-30	0.0037	0.0037	

Note: The frequency fundamental emissions stay within the authorized frequency block based on the frequency deviation measured is small.



Band :	WCDMA Band V	Channel :	4182
Limit (ppm) :	2.5	Frequency :	836.4 MHz

Temperature (°C)	RMC 12.2Kbps	Result
	Deviation (ppm)	
50	0.0143	PASS
40	0.0120	
30	0.0108	
20(Ref.)	0.0000	
10	0.0096	
0	0.0108	
-10	0.0024	
-20	0.0012	
-30	0.0132	

Band :	WCDMA Band II	Channel :	9400
Limit (ppm) :	within authorized band	Frequency :	1880.0 MHz

Temperature (°C)	RMC 12.2Kbps	Result
	Deviation (ppm)	
50	0.0027	PASS
40	0.0011	
30	0.0005	
20(Ref.)	0.0000	
10	0.0005	
0	0.0005	
-10	0.0027	
-20	0.0016	
-30	0.0032	

Note: The frequency fundamental emissions stay within the authorized frequency block based on the frequency deviation measured is small.



Band :	CDMA2000 BC0 1xRTT_RC3+SO32	Channel :	384
Limit (ppm) :	2.5	Frequency :	836.52 MHz

Temperature (°C)	Deviation (ppm)	Result
50	0.0311	PASS
40	0.0275	
30	0.0299	
20(Ref.)	0.0000	
10	0.0012	
0	0.0036	
-10	0.0287	
-20	0.0048	
-30	0.0060	

Band :	CDMA2000 BC1 1xRTT_RC3+SO32	Channel :	600
Limit (ppm) :	within authorized band	Frequency :	1880.0 MHz

Temperature (°C)	Deviation (ppm)	Result
50	0.0011	PASS
40	0.0021	
30	0.0005	
20(Ref.)	0.0000	
10	0.0016	
0	0.0021	
-10	0.0005	
-20	0.0011	
-30	0.0000	

Note: The frequency fundamental emissions stay within the authorized frequency block based on the frequency deviation measured is small.



3.8.7 Test Result of Voltage Variation

Band & Channel	Mode	Voltage(Volt)	Deviation (ppm)	Limit (ppm)	Result
GSM 850 CH189	GPRS class 8	4.2	0.0036	2.5	PASS
		3.8	0.0000		
		BEP	0.0072		
	EDGE class 8	4.2	0.0012		
		3.8	0.0024		
		BEP	0.0048		
GSM 1900 CH661	GPRS class 8	4.2	0.0011	(Note 3.)	
		3.8	0.0043		
		BEP	0.0059		
	EDGE class 8	4.2	0.0213		
		3.8	0.0027		
		BEP	0.0005		
WCDMA Band V CH4182	RMC 12.2Kbps	4.2	0.0000	2.5	
		3.8	0.0108		
		BEP	0.0096		
WCDMA Band II CH9400	RMC 12.2Kbps	4.2	0.0005	(Note 3.)	
		3.8	0.0016		
		BEP	0.0011		
CDMA2000 BC0 CH384	1xRTT RC3+SO32	4.2	0.0000	2.5	
		3.8	0.0275		
		BEP	0.0012		
CDMA2000 BC1 CH600	1xRTT RC3+SO32	4.2	0.0011	(Note 3.)	
		3.8	0.0005		
		BEP	0.0016		

Note:

1. Normal Voltage = 3.8V.
2. Battery End Point (BEP) = 3.6 V.
3. The frequency fundamental emissions stay within the authorized frequency block based on the frequency deviation measured is small.



4 List of Measuring Equipment

Instrument	Manufacturer	Model No.	Serial No.	Characteristics	Calibration Date	Test Date	Due Date	Remark
System Simulator	Rohde & Schwarz	CMU200	117995	N/A	Jul. 29, 2014	Aug. 04, 2014~ Nov. 05, 2014	Jul. 28, 2015	Conducted (TH02-HY)
Spectrum Analyzer	Rohde & Schwarz	FSP40	100055	9kHz~40GHz	Jun. 09, 2014	Aug. 04, 2014~ Nov. 05, 2014	Jun. 08, 2015	Conducted (TH02-HY)
Thermal Chamber	Ten Billion	TTH-D3SP	TBN-9307 01	N/A	Jul. 17, 2014	Aug. 04, 2014~ Nov. 05, 2014	Jul. 16, 2015	Conducted (TH02-HY)
Spectrum Analyzer	Rohde & Schwarz	FSV30	101749	10Hz ~ 30GHz	Feb. 10, 2014	Oct. 28, 2014	Feb. 09, 2015	Radiation (03CH07-HY)
Bilog Antenna	Schaffner	CBL6111C	2726	30MHz ~ 1GHz	Sep. 27, 2014	Oct. 28, 2014	Sep. 26, 2015	Radiation (03CH07-HY)
Double Ridge Horn Antenna	ESCO	3117	75962	1GHz~18GHz	Aug. 19, 2014	Oct. 28, 2014	Aug. 18, 2015	Radiation (03CH07-HY)
Preamplifier	COM-POWER	PA-103A	161241	10 MHz ~ 1000MHz	Mar. 17, 2014	Oct. 28, 2014	Mar. 16, 2015	Radiation (03CH07-HY)
Preamplifier	Agilent	8449B	3008A023 62	1 GHz~26.5 GHz	Nov. 29, 2013	Oct. 28, 2014	Nov. 28, 2014	Radiation (03CH07-HY)
Turn Table	ChainTek	ChainTek 3000	N/A	0 ~ 360 degree	N/A	Oct. 28, 2014	N/A	Radiation (03CH07-HY)
Antenna Mast	ChainTek	M-400-0	114/80006 04/L	N/A	N/A	Oct. 28, 2014	N/A	Radiation (03CH07-HY)
SHF-EHF Horn Antenna	SCHWARZBE CK	BBHA 9170	BBHA9170 251	18GHz~40GHz	Oct. 02, 2014	Oct. 28, 2014	Oct. 01, 2015	Radiation (03CH07-HY)



5 Uncertainty of Evaluation

Uncertainty of Radiated Emission Measurement (30 MHz ~ 1000 MHz)

Measuring Uncertainty for a Level of Confidence of 95% ($U = 2Uc(y)$)	4.50
---	------