	Document <b>Hearing Aid Compatibility RF Emissions Test Report for the BlackBerry® Smartphone model RHA111LW</b>		Page <b>1(25)</b>
	Author Data <b>Daoud Attayi</b>	Dates of Test <b>March 18-24, July 14-15, 2014</b>	Report No <b>RTS-6058-1407-06 Rev 2</b>

# Hearing Aid Compatibility RF Emissions Test Report

<b>Testing Lab:</b>	BlackBerry RTS 440 Phillip Street Waterloo, Ontario Canada N2L 5R9 Phone: 519-888-7465 Fax: 519-746-0189	<b>Applicant:</b>	BlackBerry Limited 2200 University Ave. East Waterloo, Ontario Canada N2L 3W8 Phone: 519-888-7465 Fax: 519-888-6906 Web site: www.blackberry.com
---------------------	---	-------------------	--

**Statement of Compliance:** BlackBerry RTS declares that the product was tested in accordance with the appropriate measurement standards, guidelines and recommended practices.

This BlackBerry® Smartphone is a wireless portable device and has been shown to be in compliance with FCC 20.19 (2013-10-1), Hearing Aid-Compatible Mobile Handset and FCC Guidance KDB 285076 D01, V03r01, April 2013 and has been tested as per ANSI C63.19-2011.

---

Daoud Attayi  
Compliance Systems Analyst II  
(SAR/HAC) Compliance Lead  
(Verification and responsible of the Test Report)

---

Masud S. Attayi  
Manager, Regulatory Compliance  
(Approval of the Test Report)

**RTS is accredited  
according to  
EN ISO/IEC 17025 by:**



**592**

		Document <b>Hearing Aid Compatibility RF Emissions Test Report for the BlackBerry® Smartphone model RHA111LW</b>	Page <b>2(25)</b>
Author Data <b>Daoud Attayi</b>	Dates of Test <b>March 18-24, July 14-15, 2014</b>	Report No <b>RTS-6058-1407-06 Rev 2</b>	FCC ID <b>L6ARHA110LW</b>

Original Report issue date: August 11, 2014.

Report was revised to **RTS-6058-1407-06 Rev 2** on September 02, 2014.  
Referenced to the latest FCC standard publication date.

**Note:**

No associated T-coil measurement has been made in accordance with the guidance issued by OET in KDB publication 285076 D02 T-Coil testing for CMRS IP.

		Document <b>Hearing Aid Compatibility RF Emissions Test Report for the BlackBerry® Smartphone model RHA111LW</b>	Page <b>3(25)</b>
Author Data <b>Daoud Attayi</b>	Dates of Test <b>March 18-24, July 14-15, 2014</b>	Report No <b>RTS-6058-1407-06 Rev 2</b>	FCC ID <b>L6ARHA110LW</b>

CONTENTS

1.0 Introduction ..... 4

2.0 Applicable references ..... 5

3.0 Equipment unit tested ..... 6

    3.1 Picture of device ..... 6

    3.2 Device description ..... 6

    3.3 Battery ..... 9

    3.4 Antenna description ..... 9

4.0 List of test equipment ..... 9

5.0 Measurement procedures and measurement system ..... 10

    5.1 System/Dipole Validation ..... 10

    5.2 Modulation interference factor (MIF) ..... 12

    5.3 Evaluation of Interference Potential ..... 12

    5.4 AIA Audio Interference Analyzer ..... 13

    5.5 MIF Measurement using AIA ..... 13

    5.6 Near-Field RF Emission ..... 17

6.0 Summary of results ..... 20

    6.1 Conclusion ..... 23

7.0 Measurement uncertainty ..... 24

    Table 7.1. Worst-Case uncertainty budget ..... 24

    7.1 Site-Specific Uncertainty ..... 25

Annex A: Measurement plots and data

- A.1 MIF validation plots
- A.2 Dipole validation plots
- A.3 RF emission field plots

Annex B: Probe and dipole descriptions and calibration certificates

- B.1 Probe and measurement chain description and specifications
- B.2 Probe and dipole calibration certificates

Annex C: Test set up photos

		Document <b>Hearing Aid Compatibility RF Emissions Test Report for the BlackBerry® Smartphone model RHA111LW</b>	Page <b>4(25)</b>
Author Data <b>Daoud Attayi</b>	Dates of Test <b>March 18-24, July 14-15, 2014</b>	Report No <b>RTS-6058-1407-06 Rev 2</b>	FCC ID <b>L6ARHA110LW</b>

## 1.0 Introduction

This test report documents the measurements of the near electric/ RF Audio Interference Level generated by a wireless communication device in the region where a hearing aid would be used. The measurement procedures of ANSI C63.19-2011 were followed along with the guidance provided by the FCC.

The electric field from a wireless device is measured using a SPEAG DASY5 automated system with HAC extension and free-space probes (ER3DVx) in a 5cm x 5cm area, 15mm above the wireless device's acoustic output and the centre point of the probe element. The area is divided into 9 sub-grids and the maximum values of the electrical field scans are evaluated automatically according to the rules defined in the standard and the device is assigned a certain category. Should the wireless device's maximum T-Coil output occur in a location other than the centre of acoustic output, then the RF field scans are repeated with the measurement area centered on the maximum T-Coil output location.

The DASY5 HAC Extension consists of the following parts: the Test Arch phantom, three validation dipoles, dipole and DUT holders, electric field probes and DASY5 software. The field probes and measurement electronics are described in Annex B.1.

The specially designed Test Arch allows high precision positioning of both the device and any of the validation dipoles. The broadband dipoles are calibrated at a single frequency and are used for system performance checks.

In order to correlate the usability of a hearing aid with a wireless device (WD), the WD's radio frequency (RF) and audio band emissions are measured. ANSI C63.19 requires:

- Radio frequency (RF) measurements of the near-field electric and magnetic fields emitted by a WD in the vicinity of the audio output to categorize these emissions for correlation with the RF immunity of the microphone mode of operation of a hearing aid.
- Audio frequency magnetic field measurements of a WD emitted in the vicinity of the audio output to categorize these emissions for correlation with the T-Coil mode of operation of a hearing aid.

Hence, the following measurements are made for the WDs:

1. RF E-Field emissions.
2. T-Coil mode, magnetic signal strength in the audio band.
3. T-Coil mode, magnetic signal and noise articulation index.
4. T-Coil mode, magnetic signal frequency response through the audio band.
5. RF T-Coil environment: The worst case M rating from E-field 5x5 cm scan centered at the axial T-coil highest peak location.

		Document <b>Hearing Aid Compatibility RF Emissions Test Report for the BlackBerry® Smartphone model RHA111LW</b>	Page <b>5(25)</b>
Author Data <b>Daoud Attayi</b>	Dates of Test <b>March 18-24, July 14-15, 2014</b>	Report No <b>RTS-6058-1407-06 Rev 2</b>	FCC ID <b>L6ARHA110LW</b>

## 2.0 Applicable references

- 1] ANSI C63.19-2011, American National Standard for Methods of Measurement of Compatibility between Wireless Communication Devices and Hearing Aids.
- [2] FCC 47CFR § 20.19, Hearing Aid-Compatible Mobile Handsets, October, 2013
- [3] SPEAG DASY5 user manual, March 2013.
- [4] Equipment Authorization Guidance on Hearing Aid Compatibility, KDB 285076 D01 HAC Guidance v03 R01, April, 2013.

		Document <b>Hearing Aid Compatibility RF Emissions Test Report for the BlackBerry® Smartphone model RHA111LW</b>	Page <b>6(25)</b>
Author Data <b>Daoud Attayi</b>	Dates of Test <b>March 18-24, July 14-15, 2014</b>	Report No <b>RTS-6058-1407-06 Rev 2</b>	FCC ID <b>L6ARHA110LW</b>

### 3.0 Equipment unit tested

#### 3.1 Picture of device

Please refer to Annex C.

**Figure 3.1-1. BlackBerry® smartphone**

#### 3.2 Device description

<b>Device Model</b>	RHA111LW			
<b>FCC ID</b>	L6ARHA110LW			
<b>PIN</b>	Radiated: 2FFEB280 (Rev 1), 2FFEC30B (Rev 2) Conducted: 2FFEB292 (Rev 1), 2FFEC30D (Rev 2),			
<b>Hardware Rev</b>	Rev 1-001-00, Rev 2-001-01			
<b>Software Version</b>	10.3.0.686/890			
<b>Prototype or Production Unit</b>	Production			
<b>Mode(s) of Operation</b>	1-slot GSM 850 GSM 1900	2-slots EDGE/GPRS 850/1900	3-slots EDGE/GPRS 850/1900	4-slots EDGE/GPRS 850/1900
<b>Nominal Maximum conducted RF Output Power (dBm)</b>	33.3 28.8	30.5 28.5	29.5 26.0	27.3 25.5
<b>Tolerance in Power Setting on centre channel (dB)</b>	± 0.6	± 0.5	± 0.5	± 0.5
<b>Duty Cycle</b>	1:8	2:8	3:8	4:8
<b>Transmitting Frequency Range (MHz)</b>	824.2 – 848.8 1850.2 – 1909.8	824.2 – 848.8 1850.2 – 1909.8	824.2 – 848.8 1850.2 – 1909.8	824.2 – 848.8 1850.2 – 1909.8
<b>Mode(s) of Operation</b>	802.11b	802.11g	802.11n	Bluetooth
<b>Nominal Maximum conducted RF Output Power (dBm)</b>	20.0	19.0	17.0	10.2
<b>Tolerance in Power Setting on centre channel (dB)</b>	± 2.0	± 2.0	± 2.0	± 0.75
<b>Duty Cycle</b>	1:1	1:1	1:1	N/A
<b>Transmitting Frequency Range (MHz)</b>	2412-2462	2412-2462	2412-2462	2402-2483
<b>Mode(s) of Operation</b>	802.11a (low band)	802.11a (middle band)	802.11a (upper band I)	802.11a (upper band II)
<b>Nominal Maximum conducted RF Output Power (dBm)</b>	19.0	19.0	19.0	16.6
<b>Tolerance in Power Setting on centre channel (dB)</b>	± 2.0	± 2.0	± 2.0	± 2.0
<b>Duty Cycle</b>	1:1	1:1	1:1	1:1
<b>Transmitting Frequency Range (MHz)</b>	5180-5240	5260-5320	5520-5700	5745-5825

		Document <b>Hearing Aid Compatibility RF Emissions Test Report for the BlackBerry® Smartphone model RHA111LW</b>		Page 7(25)
Author Data <b>Daoud Attayi</b>	Dates of Test <b>March 18-24, July 14-15, 2014</b>	Report No <b>RTS-6058-1407-06 Rev 2</b>	FCC ID <b>L6ARHA110LW</b>	

Mode(s) of Operation	HSPA+/ WCDMA / UMTS FDD V (850)	HSPA+/ WCDMA / UMTS FDD II (1900)	NFC	
Nominal Maximum conducted RF Output Power (dBm)	24.0	22.7	N/A	
Tolerance in Power Setting on centre channel (dB)	± 0.6	± 0.6	N/A	
Duty Cycle	1:1	1:1	N/A	
Transmitting Frequency Range (MHz)	824.6 – 846.6	1852.4 – 1907.6	13.56	

**Table 1.3-1 Test device characterization for U.S. wireless operating modes/bands**

**Note 1:** BT and NFC are not activated during test because are not held-to-ear service.

<b>Device Model</b>	RHA111LW					
<b>FCC ID</b>	L6ARHA110LW					
<b>PIN</b>	Radiated: 2FFEB280 (Rev 1), 2FFEC30B (Rev 2), Conducted: 2FFEB292 (Rev 1), 2FFEC30D (Rev 2),					
<b>Hardware Rev</b>	Rev 1-001-00, Rev 2-001-01					
<b>Software Version</b>	10.3.0.686/890					
<b>Prototype or Production Unit</b>	Production					
<b>Transmission channel bandwidth</b>	Band 2: 1.4 MHz , 3 MHz , 5 MHz, 10 MHz, 15 MHz, 20 MHz Band 4: 1.4 MHz , 3 MHz , 5 MHz, 10 MHz, 15 MHz, 20 MHz Band 5: 1.4 MHz , 3 MHz , 5 MHz, 10 MHz Band 17: 5 MHz, 10 MHz					
<b>Transmission channel number and frequencies</b>						
	<b>LTE band 2</b>		<b>LTE band 4</b>		<b>LTE band 5</b>	
	<b>f (MHz)</b>	<b>Chan.</b>	<b>f (MHz)</b>	<b>Chan.</b>	<b>f (MHz)</b>	<b>Chan.</b>
<b>L</b>	1860.0	18700	1720.0	20050	829.0	20450
<b>M</b>	1880.0	18900	1732.5	20175	836.5	20525
<b>H</b>	1900.0	19100	1745.0	20300	844.0	20600
	<b>LTE band 17</b>					
	<b>f (MHz)</b>	<b>Chan.</b>				
<b>L</b>	709.0	23780				
<b>M</b>	710.0	23790				
<b>H</b>	711.0	23800				
<b>UE Category</b>	Category 3					
<b>Modulation supported in uplink</b>	QPSK, 16QAM					
<b>Description of LTE antenna</b>	1 Tx/Rx Ant, Sharing with GSM/UMTS					
<b>LTE voice available/supported</b>	Possible					
<b>Hotspot with LTE+WiFi</b>	Yes					
<b>Hotspot with LTE+WiFi active with GSM/UMTS voice</b>	No					
<b>LTE MPR permanently built-in by design</b>	Yes					

	Document <b>Hearing Aid Compatibility RF Emissions Test Report for the BlackBerry® Smartphone model RHA111LW</b>		Page <b>8(25)</b>
	Author Data <b>Daoud Attayi</b>	Dates of Test <b>March 18-24, July 14-15, 2014</b>	Report No <b>RTS-6058-1407-06 Rev 2</b>

<b>LTE A-MPR</b>	Disabled during testing , by setting NV value to NV_01 on the CMW500		
<b>Nominal Maximum conducted RF Output Power (dBm) +/- Tolerance in Power Setting on centre channel (dB)</b>	Band 2: 22.2 +/- 0.50 Band 4: 23.6 +/- 0.50 Band 5: 23.6 +/- 0.50 Band 17: 23.6 +/- 0.50		
<b>Other non-LTE U.S. wireless operating modes/bands</b>	GSM//WCDMA/HSPA <sup>+</sup>	GSM 850 MHz UMTS/WCDMA 850 MHz GSM 1900 MHz UMTS/WCDMA 1900 MHz	
	802.11 a/b/g/n	2.4 GHz Wi-Fi 5 GHz Wi-Fi 2.4 GHz BT	

**Table 1.3-2 Test device characterization all North American wireless operating modes/bands**



		Document <b>Hearing Aid Compatibility RF Emissions Test Report for the BlackBerry® Smartphone model RHA111LW</b>	Page <b>9(25)</b>
Author Data <b>Daoud Attayi</b>	Dates of Test <b>March 18-24, July 14-15, 2014</b>	Report No <b>RTS-6058-1407-06 Rev 2</b>	FCC ID <b>L6ARHA110LW</b>

### 3.3 Battery

BAT-52961-00x

### 3.4 Antenna description

<b>Type</b>	Internal fixed antenna
<b>Location</b>	Bottom back
<b>Configuration</b>	Internal fixed antenna

**Table 3.4-1. Antenna description**

### 4.0 List of test equipment

<b>Manufacturer</b>	<b>Test Equipment</b>	<b>Model Number</b>	<b>Serial Number</b>	<b>Calibration Due Date (MM/DD/YY)</b>
SCHMID & Partner Engineering AG	Data Acquisition Electronics (DAE4)	DAE4 V1	472	03/18/2015
SCHMID & Partner Engineering AG	Data Acquisition Electronics (DAE4)	DAE4 V1	473	01/15/2015
SCHMID & Partner Engineering AG	3-Dimensional E-Field Probe for Near-Field	ER3DV6	2286	01/17/2015
SCHMID & Partner Engineering AG	Audio Interference Analyzer AIA	SE UMS 170 CA	1016	CNR
Rohde & Schwarz	Base Station Simulator	CMU200	109747	11/28/2015
Rohde & Schwarz	Base Station Simulator	CMW500	136298	04/22/2015
Agilent Technologies	Signal generator	8648C	4037U03155	09/25/2015
Agilent Technologies	Power meter	E4419B	GB40202821	09/25/2015
Agilent Technologies	Power sensor	8481A	MY41095417	09/26/2014
Agilent Technologies	Power sensor	8481A	MY41095233	09/27/2014
Agilent Technologies	Power meter	N1911A	MY45100905	05/29/2015
Agilent Technologies	Power sensor	N1921A	SG45240281	12/04/2014
Amplifier Research	Amplifier	5S1G4M3	300986	CNR
SCHMID & Partner Engineering AG	Validation Dipole	CD835V3	1089	01/15/2015
SCHMID & Partner Engineering AG	Validation Dipole	CD1880V3	1068	01/15/2015

**Table 4.1-1 List of test equipment**

		Document <b>Hearing Aid Compatibility RF Emissions Test Report for the BlackBerry® Smartphone model RHA111LW</b>	Page <b>10(25)</b>
Author Data <b>Daoud Attayi</b>	Dates of Test <b>March 18-24, July 14-15, 2014</b>	Report No <b>RTS-6058-1407-06 Rev 2</b>	FCC ID <b>L6ARHA110LW</b>

## 5.0 Measurement procedures and measurement system

### 5.1 System/Dipole Validation

The test setup should be validated when first configured and verified periodically thereafter to ensure proper function.

The HAC validation dipole antenna serves as a known source for an electrical and magnetic RF output.

1. The dipole antenna was placed in the position normally occupied by the WD.
2. The dipole was energized with a 20 dBm un-modulated continuous-wave signal.
3. The center point of the probe element(s) are 15 mm from the closest surface of the dipole elements.
4. The length of the dipole was scanned with E-field probe and the maximum value was recorded.
5. The readings were compared with the values provided by the probe manufacturer and were found to agree within tolerance of +/- 10%. Please refer to Annex A.2 for Dipole Validation Plots.

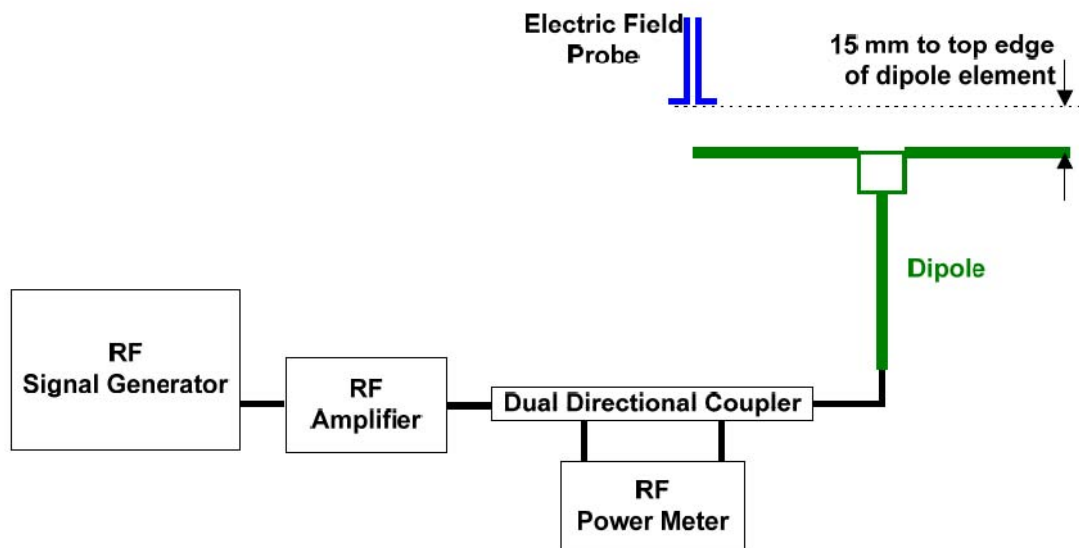
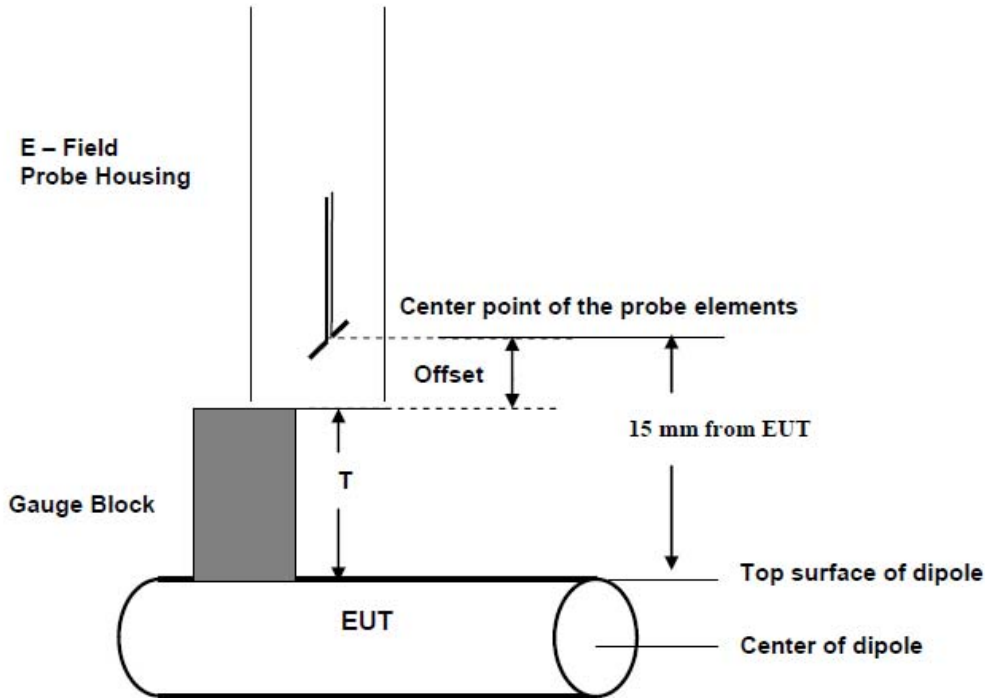

Figure 5.1-1: Dipole validation procedure



**Figure 5.1-2: Gauge Block with E-Field probe**

f (MHz)	Signal Type	Peak Power (dBm)	Measured E-Field (V/m)	Target E-Field (V/m)	Delta (%)
835	CW	20.00	110.4	108.5	1.61
1880	CW	20.00	85.1	90.3	-5.76

**Table 5.1-1: Dipole Validation measurement data**

Please refer to Annex A.2 for the plots.

		Document	Page
		<b>Hearing Aid Compatibility RF Emissions Test Report for the BlackBerry® Smartphone model RHA111LW</b>	12(25)
Author Data	Dates of Test	Report No	FCC ID
<b>Daoud Attayi</b>	<b>March 18-24, July 14-15, 2014</b>	<b>RTS-6058-1407-06 Rev 2</b>	<b>L6ARHA110LW</b>

## 5.2 Modulation interference factor (MIF)

*For a modulated signal, the difference, in dB, determined by subtracting the signal's steady-state level, in dB, from its radio-frequency (RF) audio interference level, in dB.*

MIF is the weighted envelope of a square law detector, relative to its carrier. The weighting consists of a spectral part (extracting the audible parts with a weighting similar to an A-weighting curve) followed by a quasi peak detector. Because it is used to scale the power-averaged field, the weighted quantity is relative to the carrier signal. The unmodulated carrier would not pass the spectral\_filter; therefore the reference signal is defined for the carrier when the amplitude is modulated with 1 kHz and 80% AM depth.

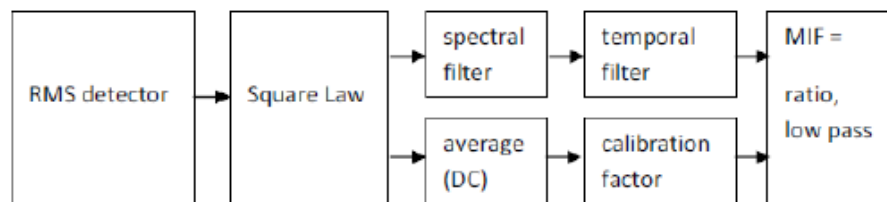

**5.2-1 RF interference level measurement**

For any specific fixed and repeatable modulated signal, a modulation interference factor (MIF, expressed in dB) may be developed that relates its interference potential to its steady-state rms signal level or average power level. This factor is a function only of the audio-frequency amplitude modulation characteristics of the signal and is the same for field-strength and conducted power measurements.

A Wireless Device's interference potential is a function both of the WD's average near-field field strength and of the signal's audio-frequency amplitude modulation characteristics. The portion of the interference potential attributable to the modulation characteristic can be evaluated independently of any particular WD. This evaluation of this interference potential relative to a signal's average field strength is described, and it is called its modulation interference factor (MIF).

## 5.3 Evaluation of Interference Potential

A WD's interference potential is a function both of the WD's average near-field field strength and of the signal's audio-frequency amplitude modulation characteristics. The portion of the interference potential attributable to the modulation characteristic can be evaluated independently of any particular WD. This evaluation of this interference potential relative to a signal's average field strength and its modulation interference factor (MIF). The MIF may be determined through analysis and simulation, allowing evaluation of an RF technology's RF interference potential in advance of actual product development.

		Document <b>Hearing Aid Compatibility RF Emissions Test Report for the BlackBerry® Smartphone model RHA111LW</b>	Page <b>13(25)</b>
Author Data <b>Daoud Attayi</b>	Dates of Test <b>March 18-24, July 14-15, 2014</b>	Report No <b>RTS-6058-1407-06 Rev 2</b>	FCC ID <b>L6ARHA110LW</b>

#### 5.4 AIA Audio Interference Analyzer

The AIA is an USB powered electronic sensor to evaluate signals in the frequency range 698 MHz - 6 GHz. It contains RMS detector and audio frequency circuits for sampling of the RF envelope. In addition to the measurement circuits, the AIA contains calibration circuits which are activated immediately before the measurement for system verification. After the calibration interval is completed, the applied signal is evaluated. All filtering and evaluation is applied to the digitized raw signal with digital IIR\_filters in the DASY52 software.

The RF input signal can be directly connected to the RF. The resulting coupling factor (CF) can be compensated for in the software settings to obtain the averaged power reading for evaluation of the RF Audio Interference Potential (RFAIP).



**Figure 5.3-1: Audio Interference Analyzer**

#### 5.5 MIF Measurement using AIA

The DASY52 MIF measurement job and Audio Interference Analyzer (AIA) manufactured by SPEAG, part number: **SE UMS 170 CA, serial number:1016** were used to evaluate the MIF, PMF, RF level at the internal detector and RF Audio Interference Potential (RFAIP) of RF signals.

MIF measurement is done as follows:

- AIA is connected to the DASY5 via USB.
- RF signal is connected conducted with enough attenuation to be evaluated to an AIA via cable.
- Prepare and run a MIF measurement job with correct measurement port and timing.

		Document <b>Hearing Aid Compatibility RF Emissions Test Report for the BlackBerry® Smartphone model RHA111LW</b>	Page <b>14(25)</b>
Author Data <b>Daoud Attayi</b>	Dates of Test <b>March 18-24, July 14-15, 2014</b>	Report No <b>RTS-6058-1407-06 Rev 2</b>	FCC ID <b>L6ARHA110LW</b>

- Report results via post processor.



Document

**Hearing Aid Compatibility RF Emissions Test Report for the BlackBerry® Smartphone model RHA111LW**

Page

15(25)

Author Data

**Daoud Attayi**

Dates of Test

**March 18-24, July 14-15, 2014**

Report No

**RTS-6058-1407-06 Rev 2**

FCC ID

**L6ARHA110LW**

Signal Type	Settings	Measured MIF (dB)	Target MIF (dB)	Delta (dB)
AM 80%	1 kHz	-1.29	-1.2	-0.09
AM 10%	1 kHz	-9.22	-9.1	-0.12
AM 1%	1 kHz	-19.18	-19.1	-0.08
GSM	Full-Rate Version 2, Speech Codec/ Handset Low	<b>3.44</b>	3.5	-0.06
WCDMA	Speech Codec Low, AMR 12.2 kbps	<b>-25.91</b>	-20.0	-5.91
WiFi	802.11b, 1 Mbps, BPSK	-12.65		
WiFi	802.11b, 2 Mbps, DQPSK	-11.97		
WiFi	802.11b, 5.5 Mbps, DQPSK/	-9.49		
WiFi	802.11b, 11 Mbps, DQPSK	-8.71		
WiFi	802.11g, 6 Mbps, BPSK	-10.27		
WiFi	802.11g, 9 Mbps, BPSK	-9.52		
WiFi	802.11g, 18 Mbps, BPSK	-8.31		
WiFi	802.11g, 54 Mbps, 64-QAM	-8.68		
WiFi	802.11a, 6 Mbps, OFDM	-10.40		
WiFi	802.11a, 24 Mbps, OFDM	-10.43		
WiFi	802.11a, 54 Mbps, OFDM	-10.43		
WiFi	802.11n, 6.5 Mbps, MCS0	-10.40		
WiFi	802.11n, 39 Mbps, MCS4	-10.43		
WiFi	802.11n, 65 Mbps, MCS7	-10.43		
LTE	20 MHz BW, QPSK_RB1-Offset 0	-14.58		
LTE	20 MHz BW, QPSK_RB1-Offset 50	-14.57		
LTE	20 MHz BW, QPSK_RB1-Offset 99	-14.47		
LTE	20 MHz BW, QPSK_RB50-Offset 0	-21.01		
LTE	20 MHz BW, QPSK_RB100-Offset 0	-21.97		
LTE	15 MHz BW, QPSK_RB1-Offset 0	-14.75		
LTE	10 MHz BW, QPSK_RB1-Offset 0	-14.93		
LTE	5 MHz BW, QPSK_RB1-Offset 0	-14.74		
LTE	3 MHz BW, QPSK_RB1-Offset 0	-14.70		
LTE	1.4 MHz BW, QPSK_RB1-Offset 0	-14.84		
LTE	20 MHz BW, 16 QAM_RB1-Offset 0	-10.58		
LTE	20 MHz BW, 16 QAM_RB1-Offset 50	-10.56		
LTE	20 MHz BW, 16 QAM_RB1-Offset 99	-10.55		
LTE	20 MHz BW, 16 QAM_RB24-Offset 0	-16.41		
LTE	20 MHz BW, 16 QAM_RB100-Offset 0	-17.67		
LTE	15 MHz BW, 16 QAM_RB1-Offset 0	-10.07		
LTE	10 MHz BW, 16 QAM_RB1-Offset 0	-10.03		
LTE	5 MHz BW, 16 QAM_RB1-Offset 0	-10.98		
LTE	3 MHz BW, 16 QAM_RB1-Offset 0	-10.15		
LTE	1.4 MHz BW, 16 QAM_RB1-Offset 0	-10.41		

**Table 5.4-1: MIF measurement data**

Please refer to Annex A.2 for MIF measurement data.

		Document <b>Hearing Aid Compatibility RF Emissions Test Report for the BlackBerry® Smartphone model RHA111LW</b>		Page <b>16(25)</b>
Author Data <b>Daoud Attayi</b>	Dates of Test <b>March 18-24, July 14-15, 2014</b>	Report No <b>RTS-6058-1407-06 Rev 2</b>	FCC ID <b>L6ARHA110LW</b>	

**Justification for lower measured MIF than the target values:**

Delta between measured and target MIF values for GSM signal is -0.06 dB which is insignificant and expected within measurement uncertainty.

Delta between measured and target MIF values for WCDMA signal is -5.91 dB due to different equipment, software and system being used. Worst case HAC RF rating is M4 with over 30 dB margin from FCC limit. By adding 5.91 dB MIF delta to the measured RF Audio Interference Level, the rating would still be M4 with ~ 20 dB margin.



		Document <b>Hearing Aid Compatibility RF Emissions Test Report for the BlackBerry® Smartphone model RHA111LW</b>	Page <b>17(25)</b>
Author Data <b>Daoud Attayi</b>	Dates of Test <b>March 18-24, July 14-15, 2014</b>	Report No <b>RTS-6058-1407-06 Rev 2</b>	FCC ID <b>L6ARHA110LW</b>

## 5.6 Near-Field RF Emission

The following procedure was used to measure RF near E-field emission:

1. Proper operation of the field probe, probe measurement system, other instrumentation, and the positioning system was confirmed.
2. The WD was oriented in its intended test position with the reference plane in the horizontal plane and was secured in the device holder to maintain position accuracy.
3. A CMU 200 Base Station Simulator was used to place a normal voice call to the WD on the desired channel and to transmit at maximum power.
4. The DASY5 system measures power drift as part of each scan. If the power during a scan drifted by more than 0.20 dB, the scan was repeated. Power drift measurements for the worst-case scans are included in Annex A.3. A fully charged battery was used for each test.
5. The 5cm x 5cm measurement grid was centered on the center of the acoustic output or the T-Coil output, as appropriate. The field probe was located at the initial position at the center of the measurement grid.
6. A surface verification was performed before each setup change to ensure repeatable spacing and proper maintenance of the measurement plane.
7. The electric field probe was used to measure the highest field strength in the 5cm x 5cm reference plane. The center point of the probe measurement element(s) shall be held 15 mm from the WD reference plane.
8. The entire 5cm x 5cm region was scanned with a 5mm step size. The reading was recorded at each measurement location. Justification of the step size and interpolation used is provided at the end of Annex A.2.
9. Around the center sub-grid, five contiguous sub-grids were identified with the lowest maximum field strength readings. Please note that a maximum of five sub-grids can be excluded.
10. The highest field reading was identified within the non-excluded sub-grids
11. The highest field reading was converted from average to **RF Audio Interference Level dB (V/m)**, as appropriate. This conversion was done by the DASY5 SEMCAD processor after inputting measured MIF.
12. The highest reading was compared to the categories defined in C63.19.

- If a WD has more than one antenna position, it is necessary to test the WD only in the condition of maximum antenna efficiency, i.e. antenna extended.
- The WD's backlight shuts off automatically a short time after a call is established.

Emission categories	<960 MHz	
	E-field emissions	
Category M1	50 to 55	dB (V/m)
Category M2	45 to 50	dB (V/m)
Category M3	40 to 45	dB (V/m)
Category M4	<40	dB (V/m)

Emission categories	>960 MHz	
	E-field emissions	
Category M1	40 to 45	dB (V/m)
Category M2	35 to 40	dB (V/m)
Category M3	30 to 35	dB (V/m)
Category M4	<30	dB (V/m)

**Table 5.5-1: Wireless Device near-field categories**



**Figure 5.5-2: WD reference plane for RF emission measurement**

	Document <b>Hearing Aid Compatibility RF Emissions Test Report for the BlackBerry® Smartphone model RHA111LW</b>		Page <b>19(25)</b>
	Author Data <b>Daoud Attayi</b>	Dates of Test <b>March 18-24, July 14-15, 2014</b>	Report No <b>RTS-6058-1407-06 Rev 2</b>

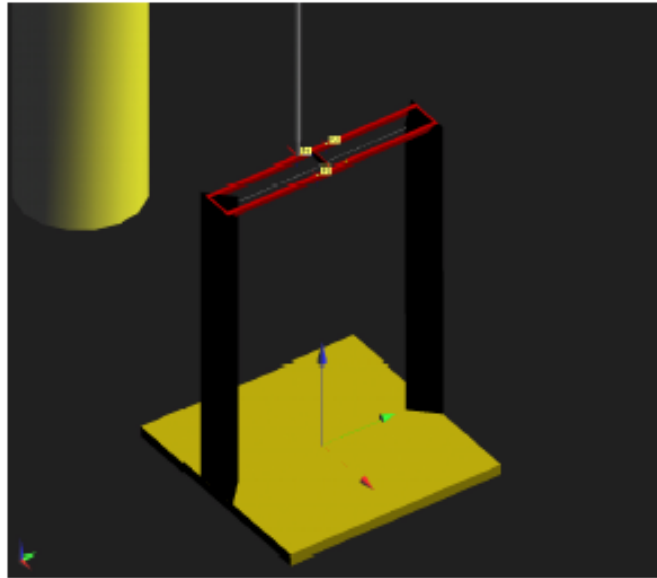

**Figure 5.5-3: HAC Measurement Test Arch**

	Document <b>Hearing Aid Compatibility RF Emissions Test Report for the BlackBerry® Smartphone model RHA111LW</b>		Page <b>20(25)</b>
	Author Data <b>Daoud Attayi</b>	Dates of Test <b>March 18-24, July 14-15, 2014</b>	Report No <b>RTS-6058-1407-06 Rev 2</b>
			FCC ID <b>L6ARHA110LW</b>

## 6.0 Summary of results

RF Emissions Test								
Mode	f (MHz)	Cond. Pwr. (dBm)	RF Audio Interference Level (dB V/m)	FCC Limit (dB V/m)	FCC Margin (dB)	Measured MIF	Center of Speaker or Telecoil	M-Rating
GSM 850	824.2	33.9	38.42	40.00	-1.58	3.44	Speaker	4
	836.8	33.9	39.60	40.00	-0.4	3.44	Speaker	4
	848.8	33.6	39.10	40.00	-0.9	3.44	Speaker	4
	848.8	33.6	39.29	40.00	-0.71	3.44	Telecoil	4
GSM 1900	1850.2	28.9	28.65	30.00	-1.35	3.44	Speaker	4
	1880.0	29.1	29.12	30.00	-0.88	3.44	Speaker	4
	1909.8	28.8	27.56	30.00	-2.44	3.44	Speaker	4
	1880.0	29.1	27.42	30.00	-2.58	3.44	Telecoil	4
WCDMA band V	826.4	24.7	10.15	40.00	-29.85	-25.91	Speaker	4
	836.4	24.5	9.18	40.00	-30.82	-25.91	Speaker	4
	846.6	24.4	10.16	40.00	-29.84	-25.91	Speaker	4
	846.6	24.4	10.21	40.00	-29.79	-25.91	Telecoil	4
WCDMA band II	1852.4	22.8	1.45	30.00	-28.55	-25.91	Speaker	4
	1880.0	22.8	1.26	30.00	-28.74	-25.91	Speaker	4
	1907.6	22.8	1.66	30.00	-28.34	-25.91	Speaker	4
	1907.6	22.8	2.23	30.00	-27.77	-25.91	Telecoil	4
<b>Overall M-Rating:</b>								<b>4</b>

**Table 6.1–E-Field Data Summary**

	Document <b>Hearing Aid Compatibility RF Emissions Test Report for the BlackBerry® Smartphone model RHA111LW</b>		Page <b>21(25)</b>
	Author Data <b>Daoud Attayi</b>	Dates of Test <b>March 18-24, July 14-15, 2014</b>	Report No <b>RTS-6058-1407-06 Rev 2</b>
			FCC ID <b>L6ARHA110LW</b>

Mode	Band, data rate	Measured MIF (dB)	Maximum Nominal Cond. Output Pwr. (dBm) + Tolerance	MIF + Cond. Power (dBm)	M-Rating
LTE	20 MHz BW, QPSK_RB1-Offset 99	-14.47	24.10	9.63	4
LTE	15 MHz BW, QPSK_RB1-Offset 0	-14.75	24.10	9.35	4
LTE	5 MHz BW, QPSK_RB1-Offset 0	-14.74	24.10	9.36	4
LTE	3 MHz BW, QPSK_RB1-Offset 0	-14.70	24.10	9.40	4
LTE	20 MHz BW, 16 QAM_RB1-Offset 99	-10.55	23.10	12.55	4
LTE	10 MHz BW, 16 QAM_RB1-Offset 0	-10.03	23.10	13.07	4
LTE	1.4 MHz BW, 16 QAM_RB1-Offset 0	-10.41	23.10	12.69	4
<b>Overall M-rating:</b>					<b>4</b>

**Table 6.3–E-Field Data Summary**

**As per C63.19-2011:** RF air interface technologies that have low power have been found to produce sufficiently low RF interference potential, so that it is possible to exempt them from the product testing. Evaluation of the MIF for the worst-case operating mode. An RF air interface technology of a device is exempt from testing when its average antenna input power plus its MIF is  $\leq 17$  dBm for any of its operating modes. An RF air interface technology that is exempted from testing by either method shall be rated as M4.

	Document <b>Hearing Aid Compatibility RF Emissions Test Report for the BlackBerry® Smartphone model RHA111LW</b>		Page <b>22(25)</b>
	Author Data <b>Daoud Attayi</b>	Dates of Test <b>March 18-24, July 14-15, 2014</b>	Report No <b>RTS-6058-1407-06 Rev 2</b>
			FCC ID <b>L6ARHA110LW</b>

Mode	Band, data rate	Measured MIF (dB)	Maximum Nominal Cond. Output Pwr. (dBm) + Tolerance	MIF + Cond. Power (dBm)	M-Rating
WiFi	802.11b, 1 Mbps	-12.65	22.0	9.35	4
WiFi	802.11b, 2 Mbps	-11.97	22.0	10.03	4
WiFi	802.11b, 5.5 Mbps	-9.49	22.0	12.51	4
WiFi	802.11b, 11 Mbps	-8.71	22.0	23.29	4
WiFi	802.11g, 6 Mbps	-10.27	21.0	10.73	4
WiFi	802.11g, 9 Mbps	-9.52	21.0	11.48	4
WiFi	802.11g, 18 Mbps	-8.31	20.0	11.69	4
WiFi	802.11g, 54 Mbps	-8.68	18.0	9.32	4
WiFi	802.11a, 6 Mbps	-10.40	21.0	10.6	4
WiFi	802.11a, 24 Mbps	-10.43	18.0	7.57	4
WiFi	802.11a, 54 Mbps	-10.43	17.0	6.57	4
WiFi	802.11n, 6.5 Mbps	-10.40	19.0	8.60	4
WiFi	802.11n, 39 Mbps	-10.43	19.0	8.57	4
WiFi	802.11n, 65 Mbps	-10.43	17.0	6.57	4
<b>Overall M-rating:</b>					<b>4</b>

**Table 6.4–E-Field Data Summary**

**As per C63.19-2011:** RF air interface technologies that have low power have been found to produce sufficiently low RF interference potential, so that it is possible to exempt them from the product testing. Evaluation of the MIF for the worst-case operating mode. An RF air interface technology of a device is exempt from testing when its average antenna input power plus its MIF is  $\leq 17$  dBm for any of its operating modes. An RF air interface technology that is exempted from testing by either method shall be rated as M4.

		Document <b>Hearing Aid Compatibility RF Emissions Test Report for the BlackBerry® Smartphone model RHA111LW</b>	Page <b>23(25)</b>
Author Data <b>Daoud Attayi</b>	Dates of Test <b>March 18-24, July 14-15, 2014</b>	Report No <b>RTS-6058-1407-06 Rev 2</b>	FCC ID <b>L6ARHA110LW</b>

## 6.1 Conclusion

The BlackBerry® Smartphone Model: **RHA111LW** is categorized to be **M4T4** based on HAC RF Emission and HAC T-Coil Audio Band Magnetic Field performance in accordance with ANSI C63.19-2011: American National Standard for Methods of Measurement of Compatibility between Wireless Communication Devices and Hearing Aids.

Therefore, the device is found to be in compliance with the requirements of FCC 47 CFR 20.19 (2013-10-01) Hearing Aid-Compatible Mobile Handsets.

## 7.0 Measurement uncertainty

<b>HAC Uncertainty Budget</b> According to ANSI C63.19 [1], [2]							
Error Description	Uncert. value	Prob. Dist.	Div.	( $c_i$ ) E	( $c_i$ ) H	Std. Unc. E	Std. Unc. H
<b>Measurement System</b>							
Probe Calibration	±5.1%	N	1	1	1	±5.1%	±5.1%
Axial Isotropy	±4.7%	R	$\sqrt{3}$	1	1	±2.7%	±2.7%
Sensor Displacement	±16.5%	R	$\sqrt{3}$	1	0.145	±9.5%	±1.4%
Boundary Effects	±2.4%	R	$\sqrt{3}$	1	1	±1.4%	±1.4%
Phantom Boundary Effect	±7.2%	R	$\sqrt{3}$	1	0	±4.1%	±0.0%
Linearity	±4.7%	R	$\sqrt{3}$	1	1	±2.7%	±2.7%
Scaling with PMR calibration	±10.0%	R	$\sqrt{3}$	1	1	±5.8%	±5.8%
System Detection Limit	±1.0%	R	$\sqrt{3}$	1	1	±0.6%	±0.6%
Readout Electronics	±0.3%	N	1	1	1	±0.3%	±0.3%
Response Time	±0.8%	R	$\sqrt{3}$	1	1	±0.5%	±0.5%
Integration Time	±2.6%	R	$\sqrt{3}$	1	1	±1.5%	±1.5%
RF Ambient Conditions	±3.0%	R	$\sqrt{3}$	1	1	±1.7%	±1.7%
RF Reflections	±12.0%	R	$\sqrt{3}$	1	1	±6.9%	±6.9%
Probe Positioner	±1.2%	R	$\sqrt{3}$	1	0.67	±0.7%	±0.5%
Probe Positioning	±4.7%	R	$\sqrt{3}$	1	0.67	±2.7%	±1.8%
Extrap. and Interpolation	±1.0%	R	$\sqrt{3}$	1	1	±0.6%	±0.6%
<b>Test Sample Related</b>							
Device Positioning Vertical	±4.7%	R	$\sqrt{3}$	1	0.67	±2.7%	±1.8%
Device Positioning Lateral	±1.0%	R	$\sqrt{3}$	1	1	±0.6%	±0.6%
Device Holder and Phantom	±2.4%	R	$\sqrt{3}$	1	1	±1.4%	±1.4%
Power Drift	±5.0%	R	$\sqrt{3}$	1	1	±2.9%	±2.9%
<b>Phantom and Setup Related</b>							
Phantom Thickness	±2.4%	R	$\sqrt{3}$	1	0.67	±1.4%	±0.9%
Combined Std. Uncertainty						±16.3%	±12.3%
Expanded Std. Uncertainty on Power						±32.6%	±24.6%
Expanded Std. Uncertainty on Field						±16.3%	±12.3%

**Table 7.1. Worst-Case uncertainty budget for HAC free field assessment according to ANSI C63.19 [1], [2]. The budget is valid for the frequency range 700 MHz - 3 GHz and represents a worstcase analysis.**



		Document <b>Hearing Aid Compatibility RF Emissions Test Report for the BlackBerry® Smartphone model RHA111LW</b>	Page <b>25(25)</b>
Author Data <b>Daoud Attayi</b>	Dates of Test <b>March 18-24, July 14-15, 2014</b>	Report No <b>RTS-6058-1407-06 Rev 2</b>	FCC ID <b>L6ARHA110LW</b>

## 7.1 Site-Specific Uncertainty

### RF Reflections

Section 4.2 of ANSI C63.19 requires that any RF reflecting objects are a minimum distance of 2 wavelengths away from the WD under test. For this WD, the longest wavelength occurs when the WD is transmitting at 824.7MHz. The wavelength is:

$$\lambda = \frac{c}{f} = \frac{3 \cdot 10^8 \text{ m/s}}{824.7 \text{ MHz}} = 0.364 \text{ m}$$

Therefore, 2 wavelengths result in a distance of 0.73m. Tests are performed in an RF shielded chamber. The distance to the nearest wall is > 1m and the distance to the robot's safety guardrail is ~1.0m, both satisfying the requirement. In addition, RF absorbing cones are placed at the base of the robot to further reduce reflections. The HAC phantom arch is made of low dielectric constant plastic and should not be a source of reflections.

### Environmental Conditions

During measurements, the temperature of the test lab was kept between 21°C and 25°C and relative humidity was maintained between 20% and 55%.

### Ambient Noise

ANSI C63.19 standard requires RF ambient noise to be at least 20dB below the measurement level. Scans of RF ambient noise fields were previously performed for verification and was determined to be < 20 dB than the measured WD RF field levels.