		Document Appendix D for the BlackBerry® Smartphone Model RGB141LW SAR Report Rev 4		Page 1(69)
Author Data Andrew Becker	Dates of Test June 11 – August 16, 2013 March 24-26, 2014 December 8 – 12, 2014	Test Report No RTS-6046-1308-39 Rev 6	FCC ID: L6ARGB140LW	IC

APPENDIX D: PROBE & DIPOLE CALIBRATION DATA

Revision History		
Rev. Number	Date	Changes
Initial	Aug 21, 2013	-----
Rev 2	Sep 16, 2013	Separated data and report for model: RGB141LW and added more information to address FCC requirements.
Rev 3	Sep 18, 2013	Reused SAR data from model RFX101W was added to this report to address FCC OET requirement.
Rev 4	Dec 15, 2014	Added calibration files used for 802.11a Hotspot mode testing <ul style="list-style-type: none"> • Page 51 – 69

	Document Appendix D for the BlackBerry® Smartphone Model RGB141LW SAR Report Rev 4		Page 2(69)
	Author Data Andrew Becker	Dates of Test June 11 – August 16, 2013 March 24-26, 2014 December 8 – 12, 2014	Test Report No RTS-6046-1308-39 Rev 6
		FCC ID: L6ARGB140LW	IC

**Calibration Laboratory of
Schmid & Partner
Engineering AG**
Zeughausstrasse 43, 8004 Zurich, Switzerland



S Schweizerischer Kalibrierdienst
S Service suisse d'étalonnage
S Servizio svizzero di taratura
S Swiss Calibration Service

Accredited by the Swiss Accreditation Service (SAS)
The Swiss Accreditation Service is one of the signatories to the EA
Multilateral Agreement for the recognition of calibration certificates

Accreditation No.: **SCS 108**

Client **RTS (RIM Testing Services)**

Certificate No: **ES3-3225_Jan13**

CALIBRATION CERTIFICATE

Object	ES3DV3 - SN:3225
Calibration procedure(s)	QA CAL-01.v8, QA CAL-23.v4, QA CAL-25.v4 Calibration procedure for dosimetric E-field probes
Calibration date:	January 10, 2013
This calibration certificate documents the traceability to national standards, which realize the physical units of measurements (SI). The measurements and the uncertainties with confidence probability are given on the following pages and are part of the certificate.	
All calibrations have been conducted in the closed laboratory facility: environment temperature (22 ± 3)°C and humidity < 70%.	
Calibration Equipment used (M&TE critical for calibration)	

Primary Standards	ID	Cal Date (Certificate No.)	Scheduled Calibration
Power meter E4419B	GB41293874	29-Mar-12 (No. 217-01508)	Apr-13
Power sensor E4412A	MY41498087	29-Mar-12 (No. 217-01508)	Apr-13
Reference 3 dB Attenuator	SN: S5054 (3c)	27-Mar-12 (No. 217-01531)	Apr-13
Reference 20 dB Attenuator	SN: S5086 (20b)	27-Mar-12 (No. 217-01529)	Apr-13
Reference 30 dB Attenuator	SN: S5129 (30b)	27-Mar-12 (No. 217-01532)	Apr-13
Reference Probe ES3DV2	SN: 3013	28-Dec-12 (No. ES3-3013_Dec12)	Dec-13
DAE4	SN: 660	20-Jun-12 (No. DAE4-660_Jun12)	Jun-13
Secondary Standards	ID	Check Date (in house)	Scheduled Check
RF generator HP 8648C	US3642U01700	4-Aug-99 (in house check Apr-11)	In house check: Apr-13
Network Analyzer HP 8753E	US37390585	18-Oct-01 (in house check Oct-12)	In house check: Oct-13

Calibrated by:	Name Jeton Kastrati	Function Laboratory Technician	Signature
Approved by:	Name Katja Pokovic	Function Technical Manager	Signature
			Issued: January 14, 2013
This calibration certificate shall not be reproduced except in full without written approval of the laboratory.			

	Document Appendix D for the BlackBerry® Smartphone Model RGB141LW SAR Report Rev 4		Page 3(69)
	Author Data Andrew Becker	Dates of Test June 11 – August 16, 2013 March 24-26, 2014 December 8 – 12, 2014	Test Report No RTS-6046-1308-39 Rev 6
		FCC ID: L6ARGB140LW	IC

Calibration Laboratory of
Schmid & Partner
Engineering AG
Zeughausstrasse 43, 8004 Zurich, Switzerland



S Schweizerischer Kalibrierdienst
S Service suisse d'étalonnage
S Servizio svizzero di taratura
S Swiss Calibration Service

Accredited by the Swiss Accreditation Service (SAS)
The Swiss Accreditation Service is one of the signatories to the EA
Multilateral Agreement for the recognition of calibration certificates

Accreditation No.: SCS 108

Glossary:

TSL tissue simulating liquid
 NORM_{x,y,z} sensitivity in free space
 ConvF sensitivity in TSL / NORM_{x,y,z}
 DCP diode compression point
 CF crest factor (1/duty_cycle) of the RF signal
 A, B, C, D modulation dependent linearization parameters
 Polarization φ φ rotation around probe axis
 Polarization ϑ ϑ rotation around an axis that is in the plane normal to probe axis (at measurement center),
 i.e., $\vartheta = 0$ is normal to probe axis

Calibration is Performed According to the Following Standards:

- IEEE Std 1528-2003, "IEEE Recommended Practice for Determining the Peak Spatial-Averaged Specific Absorption Rate (SAR) in the Human Head from Wireless Communications Devices: Measurement Techniques", December 2003
- IEC 62209-1, "Procedure to measure the Specific Absorption Rate (SAR) for hand-held devices used in close proximity to the ear (frequency range of 300 MHz to 3 GHz)", February 2005

Methods Applied and Interpretation of Parameters:

- NORM_{x,y,z}:** Assessed for E-field polarization $\vartheta = 0$ ($f \leq 900$ MHz in TEM-cell; $f > 1800$ MHz: R22 waveguide). NORM_{x,y,z} are only intermediate values, i.e., the uncertainties of NORM_{x,y,z} does not affect the E²-field uncertainty inside TSL (see below ConvF).
- NORM(f)_{x,y,z} = NORM_{x,y,z} * frequency_response** (see Frequency Response Chart). This linearization is implemented in DASY4 software versions later than 4.2. The uncertainty of the frequency response is included in the stated uncertainty of ConvF.
- DCP_{x,y,z}:** DCP are numerical linearization parameters assessed based on the data of power sweep with CW signal (no uncertainty required). DCP does not depend on frequency nor media.
- PAR:** PAR is the Peak to Average Ratio that is not calibrated but determined based on the signal characteristics
- A_{x,y,z}; B_{x,y,z}; C_{x,y,z}; D_{x,y,z}; VR_{x,y,z}:** A, B, C, D are numerical linearization parameters assessed based on the data of power sweep for specific modulation signal. The parameters do not depend on frequency nor media. VR is the maximum calibration range expressed in RMS voltage across the diode.
- ConvF and Boundary Effect Parameters:** Assessed in flat phantom using E-field (or Temperature Transfer Standard for $f \leq 800$ MHz) and inside waveguide using analytical field distributions based on power measurements for $f > 800$ MHz. The same setups are used for assessment of the parameters applied for boundary compensation (alpha, depth) of which typical uncertainty values are given. These parameters are used in DASY4 software to improve probe accuracy close to the boundary. The sensitivity in TSL corresponds to NORM_{x,y,z} * ConvF whereby the uncertainty corresponds to that given for ConvF. A frequency dependent ConvF is used in DASY version 4.4 and higher which allows extending the validity from ± 50 MHz to ± 100 MHz.
- Spherical isotropy (3D deviation from isotropy):** in a field of low gradients realized using a flat phantom exposed by a patch antenna.
- Sensor Offset:** The sensor offset corresponds to the offset of virtual measurement center from the probe tip (on probe axis). No tolerance required.

	Document Appendix D for the BlackBerry® Smartphone Model RGB141LW SAR Report Rev 4		Page 4(69)
Author Data Andrew Becker	Dates of Test June 11 – August 16, 2013 March 24-26, 2014 December 8 – 12, 2014	Test Report No RTS-6046-1308-39 Rev 6	FCC ID: L6ARGB140LW IC

ES3DV3 – SN:3225

January 10, 2013

Probe ES3DV3

SN:3225

Manufactured: September 1, 2009
 Calibrated: January 10, 2013

Calibrated for DASY/EASY Systems
 (Note: non-compatible with DASY2 system!)

	Document			Page
	Appendix D for the BlackBerry® Smartphone Model RGB141LW SAR Report Rev 4			5(69)
Author Data	Dates of Test	Test Report No	FCC ID:	IC
Andrew Becker	June 11 – August 16, 2013 March 24-26, 2014 December 8 – 12, 2014	RTS-6046-1308-39 Rev 6	L6ARGB140LW	

ES3DV3- SN:3225

January 10, 2013

DASY/EASY - Parameters of Probe: ES3DV3 - SN:3225

Basic Calibration Parameters

	Sensor X	Sensor Y	Sensor Z	Unc (k=2)
Norm ($\mu\text{V}/(\text{V}/\text{m})^2$) ^A	1.29	1.19	1.31	$\pm 10.1\%$
DCP (mV) ^B	100.5	101.5	99.9	

Modulation Calibration Parameters

UID	Communication System Name		A dB	B dB $\sqrt{\mu\text{V}}$	C	D dB	VR mV	Unc ^E (k=2)
0	CW	X	0.0	0.0	1.0	0.00	157.5	$\pm 2.7\%$
		Y	0.0	0.0	1.0		158.4	
		Z	0.0	0.0	1.0		165.9	

The reported uncertainty of measurement is stated as the standard uncertainty of measurement multiplied by the coverage factor k=2, which for a normal distribution corresponds to a coverage probability of approximately 95%.

^A The uncertainties of Norm X,Y,Z do not affect the E²-field uncertainty inside TSL (see Pages 5 and 6).

^B Numerical linearization parameter: uncertainty not required.

^E Uncertainty is determined using the max. deviation from linear response applying rectangular distribution and is expressed for the square of the field value.

	Document Appendix D for the BlackBerry® Smartphone Model RGB141LW SAR Report Rev 4			Page 6(69)
	Author Data Andrew Becker	Dates of Test June 11 – August 16, 2013 March 24-26, 2014 December 8 – 12, 2014	Test Report No RTS-6046-1308-39 Rev 6	FCC ID: L6ARGB140LW

ES3DV3– SN:3225

January 10, 2013

DASY/EASY - Parameters of Probe: ES3DV3 - SN:3225

Calibration Parameter Determined in Head Tissue Simulating Media

f (MHz) ^C	Relative Permittivity ^F	Conductivity (S/m) ^F	ConvF X	ConvF Y	ConvF Z	Alpha	Depth (mm)	Unct. (k=2)
750	41.9	0.89	6.56	6.56	6.56	0.42	1.54	± 12.0 %
900	41.5	0.97	6.19	6.19	6.19	0.43	1.52	± 12.0 %
1810	40.0	1.40	5.35	5.35	5.35	0.63	1.39	± 12.0 %
1950	40.0	1.40	5.09	5.09	5.09	0.80	1.23	± 12.0 %
2450	39.2	1.80	4.65	4.65	4.65	0.61	1.63	± 12.0 %
2600	39.0	1.96	4.43	4.43	4.43	0.80	1.32	± 12.0 %

^C Frequency validity of ± 100 MHz only applies for DASY v4.4 and higher (see Page 2), else it is restricted to ± 50 MHz. The uncertainty is the RSS of the ConvF uncertainty at calibration frequency and the uncertainty for the indicated frequency band.

^F At frequencies below 3 GHz, the validity of tissue parameters (ϵ and σ) can be relaxed to ± 10% if liquid compensation formula is applied to measured SAR values. At frequencies above 3 GHz, the validity of tissue parameters (ϵ and σ) is restricted to ± 5%. The uncertainty is the RSS of the ConvF uncertainty for indicated target tissue parameters.

	Document Appendix D for the BlackBerry® Smartphone Model RGB141LW SAR Report Rev 4			Page 7(69)
	Author Data Andrew Becker	Dates of Test June 11 – August 16, 2013 March 24-26, 2014 December 8 – 12, 2014	Test Report No RTS-6046-1308-39 Rev 6	FCC ID: L6ARGB140LW

ES3DV3– SN:3225

January 10, 2013

DASY/EASY - Parameters of Probe: ES3DV3 - SN:3225

Calibration Parameter Determined in Body Tissue Simulating Media

f (MHz) ^C	Relative Permittivity ^F	Conductivity (S/m) ^F	ConvF X	ConvF Y	ConvF Z	Alpha	Depth (mm)	Unct. (k=2)
750	55.5	0.96	6.27	6.27	6.27	0.48	1.51	± 12.0 %
900	55.0	1.05	6.12	6.12	6.12	0.73	1.25	± 12.0 %
1810	53.3	1.52	5.04	5.04	5.04	0.57	1.47	± 12.0 %
1950	53.3	1.52	4.94	4.94	4.94	0.58	1.50	± 12.0 %
2450	52.7	1.95	4.35	4.35	4.35	0.70	1.16	± 12.0 %
2600	52.5	2.16	4.11	4.11	4.11	0.67	0.99	± 12.0 %

^C Frequency validity of ± 100 MHz only applies for DASY v4.4 and higher (see Page 2), else it is restricted to ± 50 MHz. The uncertainty is the RSS of the ConvF uncertainty at calibration frequency and the uncertainty for the indicated frequency band.

^F At frequencies below 3 GHz, the validity of tissue parameters (ϵ and σ) can be relaxed to ± 10% if liquid compensation formula is applied to measured SAR values. At frequencies above 3 GHz, the validity of tissue parameters (ϵ and σ) is restricted to ± 5%. The uncertainty is the RSS of the ConvF uncertainty for indicated target tissue parameters.

	Document Appendix D for the BlackBerry® Smartphone Model RGB141LW SAR Report Rev 4		Page 8(69)
	Author Data Andrew Becker	Dates of Test June 11 – August 16, 2013 March 24-26, 2014 December 8 – 12, 2014	Test Report No RTS-6046-1308-39 Rev 6

ES3DV3- SN:3225

January 10, 2013

Frequency Response of E-Field (TEM-Cell:ifi110 EXX, Waveguide: R22)

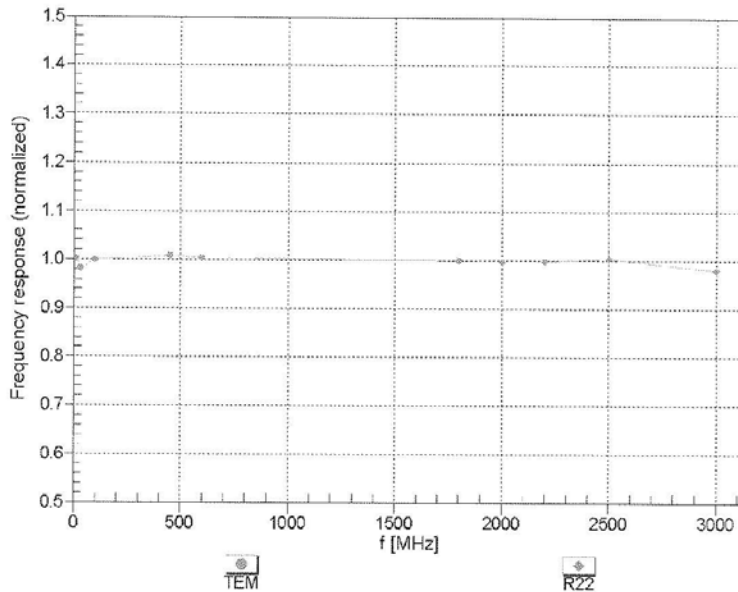

Uncertainty of Frequency Response of E-field: $\pm 6.3\%$ (k=2)

	Document Appendix D for the BlackBerry® Smartphone Model RGB141LW SAR Report Rev 4	Page 9(69)
Author Data Andrew Becker	Dates of Test June 11 – August 16, 2013 March 24-26, 2014 December 8 – 12, 2014	Test Report No RTS-6046-1308-39 Rev 6
FCC ID: L6ARGB140LW		IC

ES3DV3– SN:3225

January 10, 2013

Receiving Pattern (ϕ), $\theta = 0^\circ$

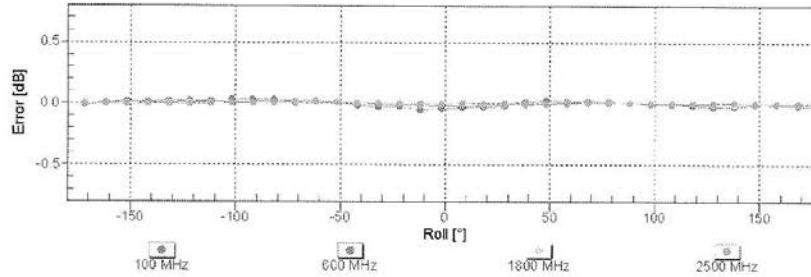
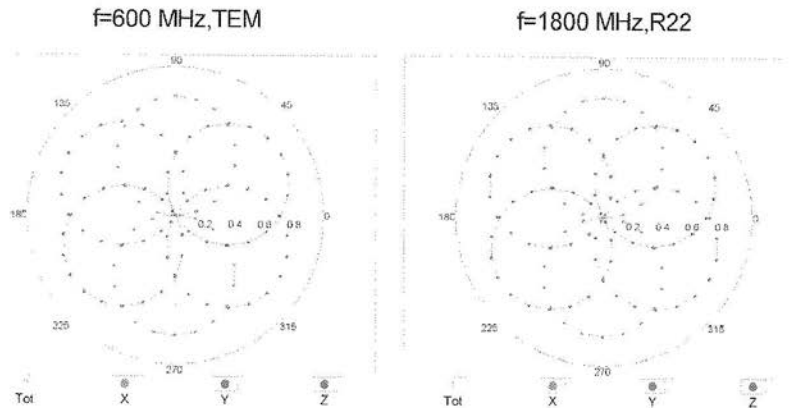

Uncertainty of Axial Isotropy Assessment: $\pm 0.5\%$ ($k=2$)

	Document Appendix D for the BlackBerry® Smartphone Model RGB141LW SAR Report Rev 4	Page 10(69)		
Author Data Andrew Becker	Dates of Test June 11 – August 16, 2013 March 24-26, 2014 December 8 – 12, 2014	Test Report No RTS-6046-1308-39 Rev 6	FCC ID: L6ARGB140LW	IC

ES3DV3- SN:3225

January 10, 2013

Dynamic Range $f(\text{SAR}_{\text{head}})$ (TEM cell , $f = 900 \text{ MHz}$)

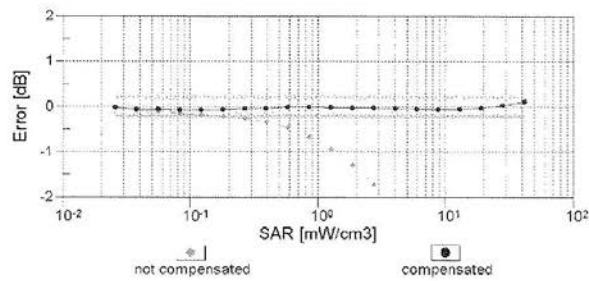
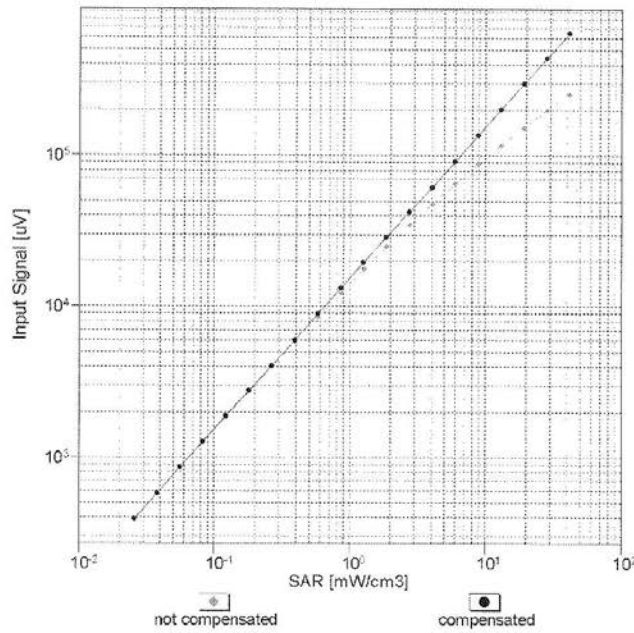

Uncertainty of Linearity Assessment: $\pm 0.6\%$ ($k=2$)

	Document Appendix D for the BlackBerry® Smartphone Model RGB141LW SAR Report Rev 4		Page 11(69)
	Author Data Andrew Becker	Dates of Test June 11 – August 16, 2013 March 24-26, 2014 December 8 – 12, 2014	Test Report No RTS-6046-1308-39 Rev 6

ES3DV3- SN:3225

January 10, 2013

Conversion Factor Assessment

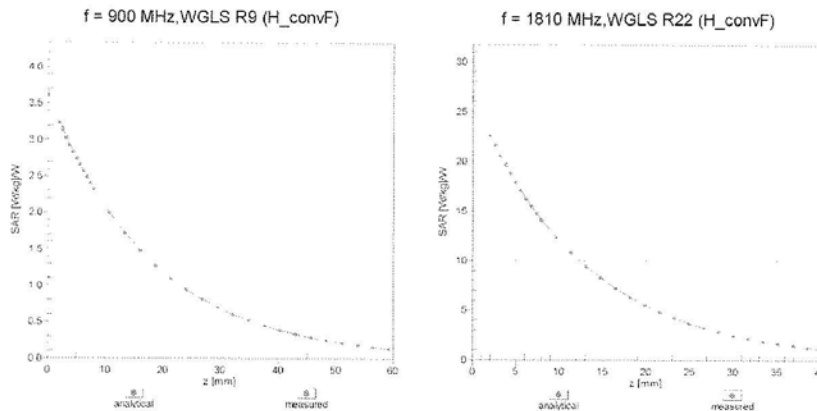

Deviation from Isotropy in Liquid Error (ϕ, θ), f = 900 MHz

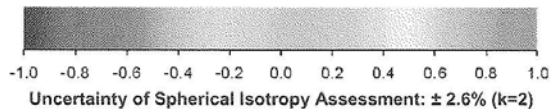
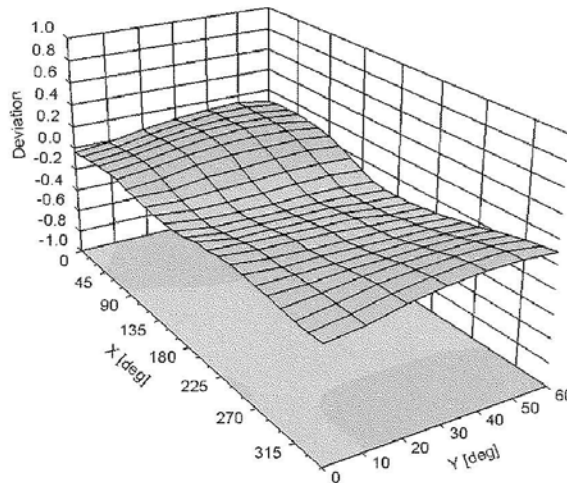

	Document			Page
	Appendix D for the BlackBerry® Smartphone Model RGB141LW SAR Report Rev 4			12(69)
Author Data	Dates of Test	Test Report No	FCC ID:	IC
Andrew Becker	June 11 – August 16, 2013 March 24-26, 2014 December 8 – 12, 2014	RTS-6046-1308-39 Rev 6	L6ARGB140LW	

ES3DV3- SN:3225

January 10, 2013

DASY/EASY - Parameters of Probe: ES3DV3 - SN:3225

Other Probe Parameters

Sensor Arrangement	Triangular
Connector Angle (°)	8.3
Mechanical Surface Detection Mode	enabled
Optical Surface Detection Mode	disabled
Probe Overall Length	337 mm
Probe Body Diameter	10 mm
Tip Length	10 mm
Tip Diameter	4 mm
Probe Tip to Sensor X Calibration Point	2 mm
Probe Tip to Sensor Y Calibration Point	2 mm
Probe Tip to Sensor Z Calibration Point	2 mm
Recommended Measurement Distance from Surface	3 mm

	Document Appendix D for the BlackBerry® Smartphone Model RGB141LW SAR Report Rev 4		Page 13(69)
	Author Data Andrew Becker	Dates of Test June 11 – August 16, 2013 March 24-26, 2014 December 8 – 12, 2014	Test Report No RTS-6046-1308-39 Rev 6
		FCC ID: L6ARGB140LW	IC

**Calibration Laboratory of
Schmid & Partner
Engineering AG**
Zeughausstrasse 43, 8004 Zurich, Switzerland



S Schweizerischer Kalibrierdienst
S Service suisse d'étalonnage
C Servizio svizzero di taratura
S Swiss Calibration Service

Accredited by the Swiss Accreditation Service (SAS)
The Swiss Accreditation Service is one of the signatories to the EA
Multilateral Agreement for the recognition of calibration certificates

Accreditation No.: **SCS 108**

Client **RTS (RIM Testing Services)**

Certificate No: **EX3-3548_Jan13**

CALIBRATION CERTIFICATE

Object	EX3DV4 - SN:3548
Calibration procedure(s)	QA CAL-01.v8, QA CAL-14.v3, QA CAL-23.v4, QA CAL-25.v4 Calibration procedure for dosimetric E-field probes
Calibration date:	January 15, 2013

This calibration certificate documents the traceability to national standards, which realize the physical units of measurements (SI).
The measurements and the uncertainties with confidence probability are given on the following pages and are part of the certificate.

All calibrations have been conducted in the closed laboratory facility: environment temperature (22 ± 3)°C and humidity < 70%.

Calibration Equipment used (M&TE critical for calibration)

Primary Standards	ID	Cal Date (Certificate No.)	Scheduled Calibration
Power meter E4419B	GB41293674	29-Mar-12 (No. 217-01508)	Apr-13
Power sensor E4412A	MY41499087	29-Mar-12 (No. 217-01508)	Apr-13
Reference 3 dB Attenuator	SN: S5054 (3c)	27-Mar-12 (No. 217-01531)	Apr-13
Reference 20 dB Attenuator	SN: S5086 (20b)	27-Mar-12 (No. 217-01529)	Apr-13
Reference 30 dB Attenuator	SN: S5129 (30b)	27-Mar-12 (No. 217-01532)	Apr-13
Reference Probe ES3DV2	SN: 3013	28-Dec-12 (No. ES3-3013_Dec12)	Dec-13
DAE4	SN: 660	20-Jun-12 (No. DAE4-660_Jun12)	Jun-13
Secondary Standards	ID	Check Date (in house)	Scheduled Check
RF generator HP 8548C	US3642UD1700	4-Aug-99 (in house check Apr-11)	In house check: Apr-13
Network Analyzer HP 8753E	US37390585	18-Oct-01 (in house check Oct-12)	In house check: Oct-13

Calibrated by:	Name Jeton Kastrati	Function Laboratory Technician	Signature
Approved by:	Name Katja Pokovic	Technical Manager	

Issued: January 15, 2013

This calibration certificate shall not be reproduced except in full without written approval of the laboratory.

	Document Appendix D for the BlackBerry® Smartphone Model RGB141LW SAR Report Rev 4		Page 14(69)
	Author Data Andrew Becker	Dates of Test June 11 – August 16, 2013 March 24-26, 2014 December 8 – 12, 2014	Test Report No RTS-6046-1308-39 Rev 6
		FCC ID: L6ARGB140LW	IC

**Calibration Laboratory of
Schmid & Partner
Engineering AG**
Zeughausstrasse 43, 8004 Zurich, Switzerland



S Schweizerischer Kalibrierdienst
S Service suisse d'étalonnage
S Servizio svizzero di taratura
S Swiss Calibration Service

Accredited by the Swiss Accreditation Service (SAS)
The Swiss Accreditation Service is one of the signatories to the EA
Multilateral Agreement for the recognition of calibration certificates

Accreditation No.: **SCS 108**

Glossary:

TSL	tissue simulating liquid
NORM _{x,y,z}	sensitivity in free space
ConvF	sensitivity in TSL / NORM _{x,y,z}
DCP	diode compression point
CF	crest factor (1/duty_cycle) of the RF signal
A, B, C, D	modulation dependent linearization parameters
Polarization φ	φ rotation around probe axis
Polarization θ	θ rotation around an axis that is in the plane normal to probe axis (at measurement center), i.e., $\theta = 0$ is normal to probe axis

Calibration is Performed According to the Following Standards:

- IEEE Std 1528-2003, "IEEE Recommended Practice for Determining the Peak Spatial-Averaged Specific Absorption Rate (SAR) in the Human Head from Wireless Communications Devices: Measurement Techniques", December 2003
- IEC 62209-1, "Procedure to measure the Specific Absorption Rate (SAR) for hand-held devices used in close proximity to the ear (frequency range of 300 MHz to 3 GHz)", February 2005

Methods Applied and Interpretation of Parameters:

- NORM_{x,y,z}:** Assessed for E-field polarization $\theta = 0$ ($f \leq 900$ MHz in TEM-cell; $f > 1800$ MHz: R22 waveguide). NORM_{x,y,z} are only intermediate values, i.e., the uncertainties of NORM_{x,y,z} does not affect the E²-field uncertainty inside TSL (see below ConvF).
- NORM(f)_{x,y,z} = NORM_{x,y,z} * frequency_response** (see Frequency Response Chart). This linearization is implemented in DASY4 software versions later than 4.2. The uncertainty of the frequency response is included in the stated uncertainty of ConvF.
- DCP_{x,y,z}:** DCP are numerical linearization parameters assessed based on the data of power sweep with CW signal (no uncertainty required). DCP does not depend on frequency nor media.
- PAR:** PAR is the Peak to Average Ratio that is not calibrated but determined based on the signal characteristics
- A_{x,y,z}; B_{x,y,z}; C_{x,y,z}; D_{x,y,z}; VR_{x,y,z}:** A, B, C, D are numerical linearization parameters assessed based on the data of power sweep for specific modulation signal. The parameters do not depend on frequency nor media. VR is the maximum calibration range expressed in RMS voltage across the diode.
- ConvF and Boundary Effect Parameters:** Assessed in flat phantom using E-field (or Temperature Transfer Standard for $f \leq 800$ MHz) and inside waveguide using analytical field distributions based on power measurements for $f > 800$ MHz. The same setups are used for assessment of the parameters applied for boundary compensation (alpha, depth) of which typical uncertainty values are given. These parameters are used in DASY4 software to improve probe accuracy close to the boundary. The sensitivity in TSL corresponds to NORM_{x,y,z} * ConvF whereby the uncertainty corresponds to that given for ConvF. A frequency dependent ConvF is used in DASY version 4.4 and higher which allows extending the validity from ± 50 MHz to ± 100 MHz.
- Spherical isotropy (3D deviation from isotropy):** in a field of low gradients realized using a flat phantom exposed by a patch antenna.
- Sensor Offset:** The sensor offset corresponds to the offset of virtual measurement center from the probe tip (on probe axis). No tolerance required.

	Document Appendix D for the BlackBerry® Smartphone Model RGB141LW SAR Report Rev 4			Page 15(69)
Author Data Andrew Becker	Dates of Test June 11 – August 16, 2013 March 24-26, 2014 December 8 – 12, 2014	Test Report No RTS-6046-1308-39 Rev 6	FCC ID: L6ARGB140LW	IC

EX3DV4 – SN:3548

January 15, 2013

Probe EX3DV4

SN:3548

Manufactured: November 16, 2004
 Calibrated: January 15, 2013

Calibrated for DASY/EASY Systems
 (Note: non-compatible with DASY2 system!)

	Document			Page
	Appendix D for the BlackBerry® Smartphone Model RGB141LW SAR Report Rev 4			16(69)
Author Data	Dates of Test	Test Report No	FCC ID:	IC
Andrew Becker	June 11 – August 16, 2013 March 24-26, 2014 December 8 – 12, 2014	RTS-6046-1308-39 Rev 6	L6ARGB140LW	

EX3DV4- SN:3548

January 15, 2013

DASY/EASY - Parameters of Probe: EX3DV4 - SN:3548

Basic Calibration Parameters

	Sensor X	Sensor Y	Sensor Z	Unc (k=2)
Norm ($\mu\text{V}/(\text{V}/\text{m})^2$) ^A	0.36	0.44	0.43	± 10.1 %
DCP (mV) ^B	103.2	98.0	98.7	

Modulation Calibration Parameters

UID	Communication System Name		A	B	C	D	VR	Unc ^E
			dB	dB $\sqrt{\mu\text{V}}$		dB	mV	(k=2)
0	CW	X	0.0	0.0	1.0	0.00	181.3	±3.3 %
		Y	0.0	0.0	1.0		149.2	
		Z	0.0	0.0	1.0		198.9	

The reported uncertainty of measurement is stated as the standard uncertainty of measurement multiplied by the coverage factor k=2, which for a normal distribution corresponds to a coverage probability of approximately 95%.

^A The uncertainties of NormX,Y,Z do not affect the E²-field uncertainty inside TSL (see Pages 5 and 6).

^B Numerical linearization parameter: uncertainty not required.

^E Uncertainty is determined using the max. deviation from linear response applying rectangular distribution and is expressed for the square of the field value.

	Document			Page
	Appendix D for the BlackBerry® Smartphone Model RGB141LW SAR Report Rev 4			17(69)
Author Data	Dates of Test	Test Report No	FCC ID:	IC
Andrew Becker	June 11 – August 16, 2013 March 24-26, 2014 December 8 – 12, 2014	RTS-6046-1308-39 Rev 6	L6ARGB140LW	

EX3DV4- SN:3548

January 15, 2013

DASY/EASY - Parameters of Probe: EX3DV4 - SN:3548

Calibration Parameter Determined in Head Tissue Simulating Media

f (MHz) ^C	Relative Permittivity ^F	Conductivity (S/m) ^F	ConvF X	ConvF Y	ConvF Z	Alpha	Depth (mm)	Unct. (k=2)
2600	39.0	1.96	7.15	7.15	7.15	0.47	0.86	± 12.0 %
5200	36.0	4.66	5.13	5.13	5.13	0.40	1.80	± 13.1 %
5500	35.6	4.96	4.79	4.79	4.79	0.40	1.80	± 13.1 %
5800	35.3	5.27	4.61	4.61	4.61	0.45	1.80	± 13.1 %

^C Frequency validity of ± 100 MHz only applies for DASY v4.4 and higher (see Page 2), else it is restricted to ± 50 MHz. The uncertainty is the RSS of the ConvF uncertainty at calibration frequency and the uncertainty for the indicated frequency band.

^F At frequencies below 3 GHz, the validity of tissue parameters (ϵ and α) can be relaxed to ± 10% if liquid compensation formula is applied to measured SAR values. At frequencies above 3 GHz, the validity of tissue parameters (ϵ and α) is restricted to ± 5%. The uncertainty is the RSS of the ConvF uncertainty for indicated target tissue parameters.

	Document			Page
	Appendix D for the BlackBerry® Smartphone Model RGB141LW SAR Report Rev 4			18(69)
Author Data	Dates of Test	Test Report No	FCC ID:	IC
Andrew Becker	June 11 – August 16, 2013 March 24-26, 2014 December 8 – 12, 2014	RTS-6046-1308-39 Rev 6	L6ARGB140LW	

EX3DV4- SN:3548

January 15, 2013

DASY/EASY - Parameters of Probe: EX3DV4 - SN:3548

Calibration Parameter Determined in Body Tissue Simulating Media

f (MHz) ^C	Relative Permittivity ^F	Conductivity (S/m) ^F	ConvF X	ConvF Y	ConvF Z	Alpha	Depth (mm)	Unct. (k=2)
2600	52.5	2.16	7.08	7.08	7.08	0.80	0.50	± 12.0 %
5200	49.0	5.30	4.68	4.68	4.68	0.52	1.90	± 13.1 %
5500	48.6	5.65	4.15	4.15	4.15	0.52	1.90	± 13.1 %
5800	48.2	6.00	4.19	4.19	4.19	0.60	1.90	± 13.1 %

^C Frequency validity of ± 100 MHz only applies for DASY v4.4 and higher (see Page 2), else it is restricted to ± 50 MHz. The uncertainty is the RSS of the ConvF uncertainty at calibration frequency and the uncertainty for the indicated frequency band.

^F At frequencies below 3 GHz, the validity of tissue parameters (ϵ and σ) can be relaxed to ± 10% if liquid compensation formula is applied to measured SAR values. At frequencies above 3 GHz, the validity of tissue parameters (ϵ and σ) is restricted to ± 5%. The uncertainty is the RSS of the ConvF uncertainty for indicated target tissue parameters.

	Document Appendix D for the BlackBerry® Smartphone Model RGB141LW SAR Report Rev 4		Page 19(69)
	Author Data Andrew Becker	Dates of Test June 11 – August 16, 2013 March 24-26, 2014 December 8 – 12, 2014	Test Report No RTS-6046-1308-39 Rev 6

EX3DV4- SN:3548

January 15, 2013

Frequency Response of E-Field (TEM-Cell:ifi110 EXX, Waveguide: R22)

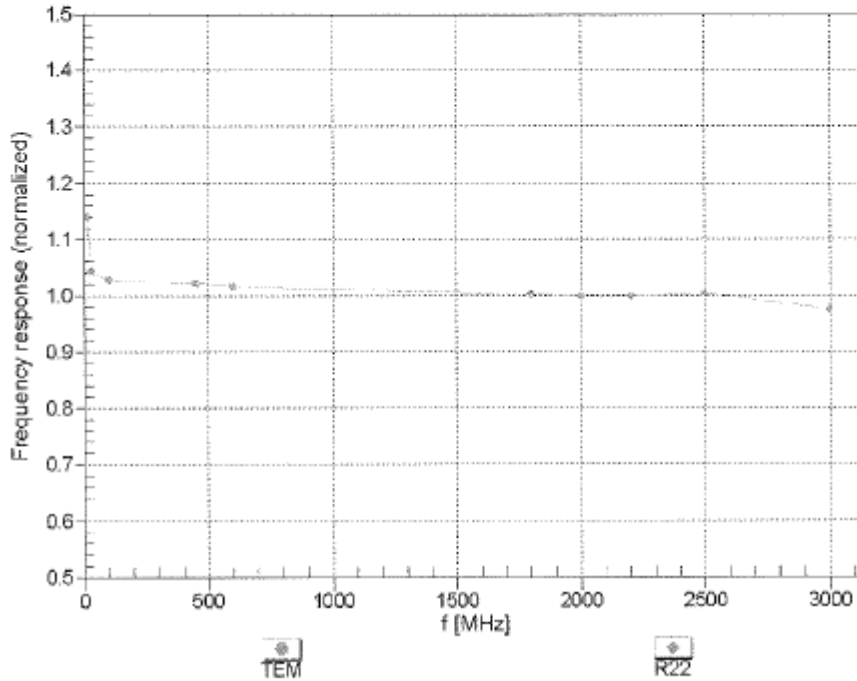

Uncertainty of Frequency Response of E-field: $\pm 6.3\%$ (k=2)

	Document Appendix D for the BlackBerry® Smartphone Model RGB141LW SAR Report Rev 4		Page 20(69)
	Author Data Andrew Becker	Dates of Test June 11 – August 16, 2013 March 24-26, 2014 December 8 – 12, 2014	Test Report No RTS-6046-1308-39 Rev 6

EX3DV4- SN:3548

January 15, 2013

Receiving Pattern (ϕ), $\theta = 0^\circ$

f=600 MHz, TEM

f=1800 MHz, R22

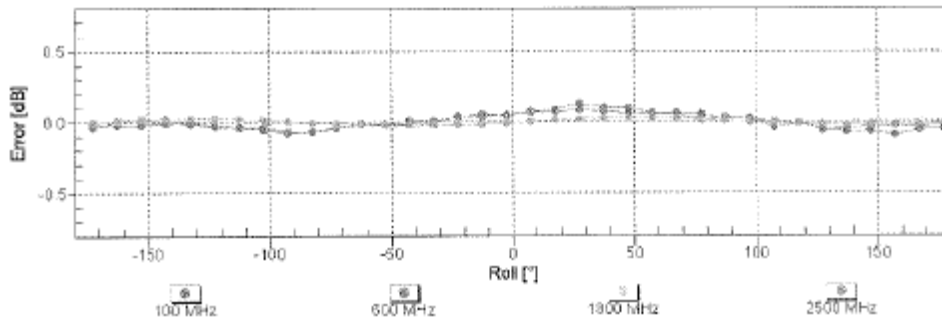
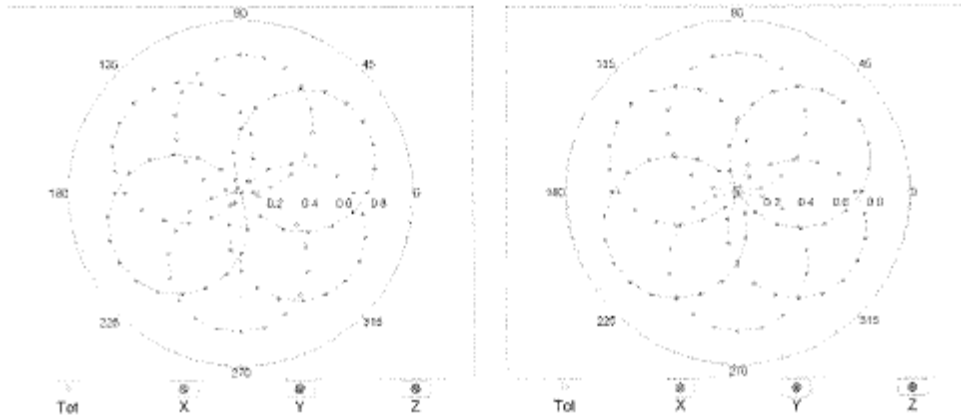

Uncertainty of Axial Isotropy Assessment: $\pm 0.5\%$ (k=2)

	Document Appendix D for the BlackBerry® Smartphone Model RGB141LW SAR Report Rev 4		Page 21(69)
	Author Data Andrew Becker	Dates of Test June 11 – August 16, 2013 March 24-26, 2014 December 8 – 12, 2014	Test Report No RTS-6046-1308-39 Rev 6

EX3DV4- SN:3548

January 15, 2013

Dynamic Range f(SAR_{head}) (TEM cell , f = 900 MHz)

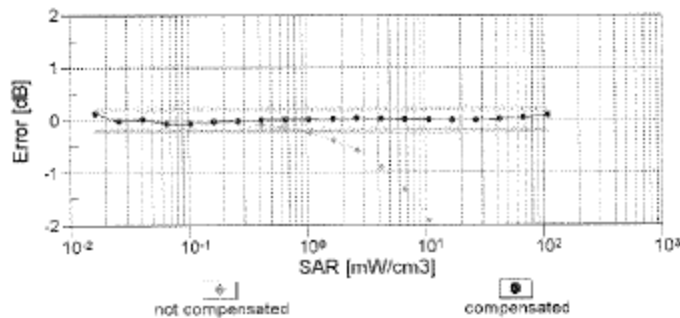
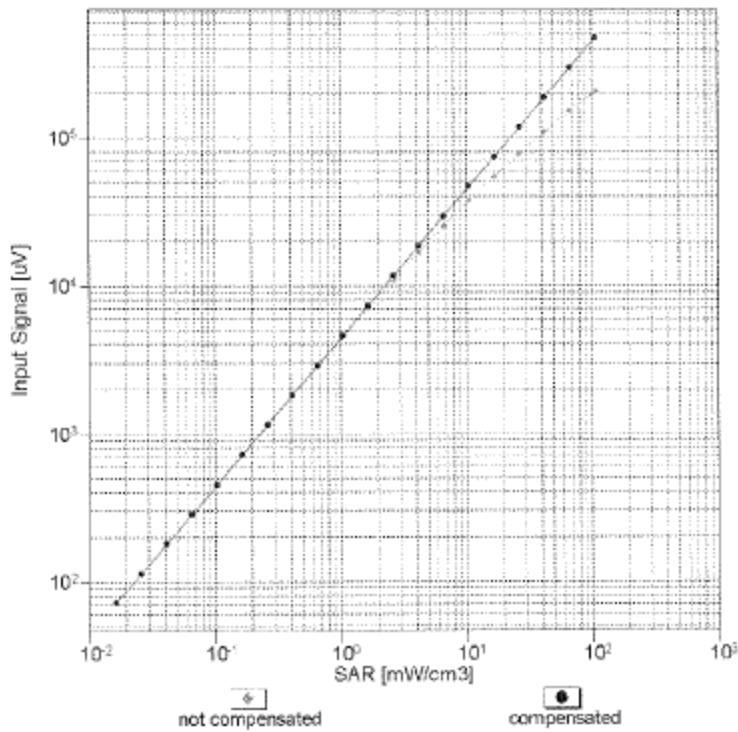

Uncertainty of Linearity Assessment: ± 0.6% (k=2)

	Document Appendix D for the BlackBerry® Smartphone Model RGB141LW SAR Report Rev 4		Page 22(69)
	Author Data Andrew Becker	Dates of Test June 11 – August 16, 2013 March 24-26, 2014 December 8 – 12, 2014	Test Report No RTS-6046-1308-39 Rev 6

EX3DV4- SN:3548

January 15, 2013

Conversion Factor Assessment

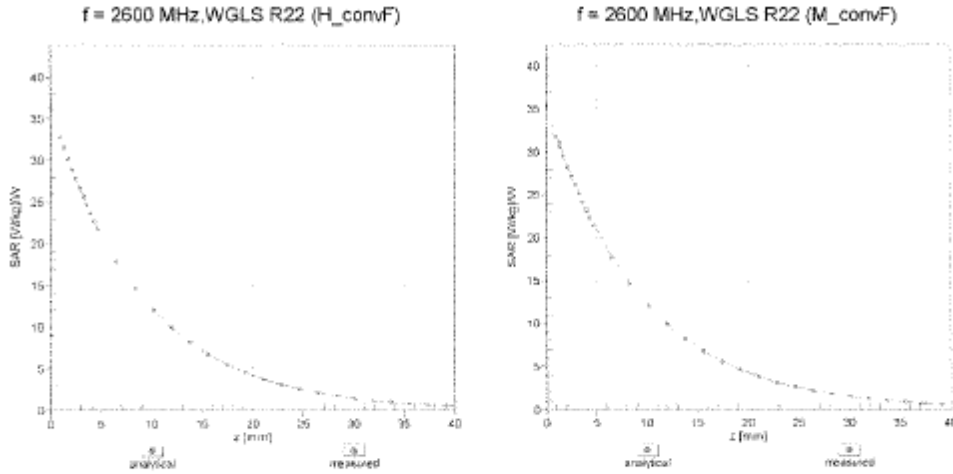

Deviation from Isotropy in Liquid

Error (ϕ , θ), $f = 900$ MHz

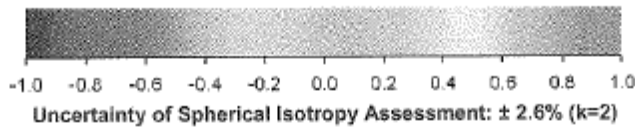
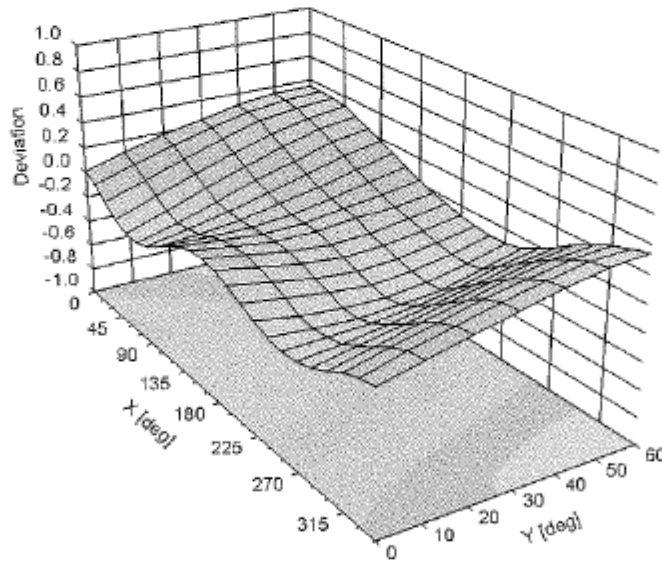

	Document Appendix D for the BlackBerry® Smartphone Model RGB141LW SAR Report Rev 4			Page 23(69)
	Author Data Andrew Becker	Dates of Test June 11 – August 16, 2013 March 24-26, 2014 December 8 – 12, 2014	Test Report No RTS-6046-1308-39 Rev 6	FCC ID: L6ARGB140LW

EX3DV4- SN:3548

January 15, 2013

DASY/EASY - Parameters of Probe: EX3DV4 - SN:3548

Other Probe Parameters

Sensor Arrangement	Triangular
Connector Angle (°)	-72.5
Mechanical Surface Detection Mode	enabled
Optical Surface Detection Mode	disabled
Probe Overall Length	337 mm
Probe Body Diameter	10 mm
Tip Length	9 mm
Tip Diameter	2.5 mm
Probe Tip to Sensor X Calibration Point	1 mm
Probe Tip to Sensor Y Calibration Point	1 mm
Probe Tip to Sensor Z Calibration Point	1 mm
Recommended Measurement Distance from Surface	2 mm

	Document Appendix D for the BlackBerry® Smartphone Model RGB141LW SAR Report Rev 4		Page 24(69)
	Author Data Andrew Becker	Dates of Test June 11 – August 16, 2013 March 24-26, 2014 December 8 – 12, 2014	Test Report No RTS-6046-1308-39 Rev 6
		FCC ID: L6ARGB140LW	IC

**Calibration Laboratory of
Schmid & Partner
Engineering AG**
Zeughausstrasse 43, 8004 Zurich, Switzerland



S Schweizerischer Kalibrierdienst
S Service suisse d'étalonnage
C Servizio svizzero di taratura
S Swiss Calibration Service

Accredited by the Swiss Accreditation Service (SAS)
The Swiss Accreditation Service is one of the signatories to the EA
Multilateral Agreement for the recognition of calibration certificates

Accreditation No.: **SCS 108**

Client **RTS (RIM Testing Services)**

Certificate No: **D835V2-446_Jan13**

CALIBRATION CERTIFICATE			
Object	D835V2 - SN: 446		
Calibration procedure(s)	QA CAL-05.v9 Calibration procedure for dipole validation kits above 700 MHz		
Calibration date:	January 07, 2013		
This calibration certificate documents the traceability to national standards, which realize the physical units of measurements (SI). The measurements and the uncertainties with confidence probability are given on the following pages and are part of the certificate.			
All calibrations have been conducted in the closed laboratory facility: environment temperature (22 ± 3)°C and humidity < 70%.			
Calibration Equipment used (M&TE critical for calibration)			
Primary Standards	ID #	Cal Date (Certificate No.)	Scheduled Calibration
Power meter EPM-442A	GB37480704	01-Nov-12 (No. 217-01640)	Oct-13
Power sensor HP 8481A	US37292783	01-Nov-12 (No. 217-01640)	Oct-13
Reference 20 dB Attenuator	SN: 5058 (20k)	27-Mar-12 (No. 217-01530)	Apr-13
Type-N mismatch combination	SN: 5047.3 / 06327	27-Mar-12 (No. 217-01533)	Apr-13
Reference Probe ES3DV3	SN: 3205	28-Dec-12 (No. ES3-3205_Dec12)	Dec-13
DAE4	SN: 601	27-Jun-12 (No. DAE4-601_Jun12)	Jun-13
Secondary Standards	ID #	Check Date (in house)	Scheduled Check
Power sensor HP 8481A	MY41092317	18-Oct-02 (in house check Oct-11)	In house check: Oct-13
RF generator R&S SMT-06	100005	04-Aug-99 (in house check Oct-11)	In house check: Oct-13
Network Analyzer HP 8753E	US37390585 S4206	18-Oct-01 (in house check Oct-12)	In house check: Oct-13
Calibrated by:	Name Leif Klynsner	Function Laboratory Technician	Signature
Approved by:	Name Katja Pokovic	Technical Manager	
			Issued: January 8, 2013
This calibration certificate shall not be reproduced except in full without written approval of the laboratory.			

Certificate No: D835V2-446_Jan13

Page 1 of 6

	Document Appendix D for the BlackBerry® Smartphone Model RGB141LW SAR Report Rev 4		Page 25(69)
	Author Data Andrew Becker	Dates of Test June 11 – August 16, 2013 March 24-26, 2014 December 8 – 12, 2014	Test Report No RTS-6046-1308-39 Rev 6
		FCC ID: L6ARGB140LW	IC

**Calibration Laboratory of
Schmid & Partner
Engineering AG**
Zeughausstrasse 43, 8004 Zurich, Switzerland



S Schweizerischer Kalibrierdienst
S Service suisse d'étalonnage
C Servizio svizzero di taratura
S Swiss Calibration Service

Accredited by the Swiss Accreditation Service (SAS)
The Swiss Accreditation Service is one of the signatories to the EA
Multilateral Agreement for the recognition of calibration certificates

Accreditation No.: **SCS 108**

Glossary:

TSL tissue simulating liquid
ConvF sensitivity in TSL / NORM x,y,z
N/A not applicable or not measured

Calibration is Performed According to the Following Standards:

- a) IEEE Std 1528-2003, "IEEE Recommended Practice for Determining the Peak Spatial-Averaged Specific Absorption Rate (SAR) in the Human Head from Wireless Communications Devices: Measurement Techniques", December 2003
- b) IEC 62209-1, "Procedure to measure the Specific Absorption Rate (SAR) for hand-held devices used in close proximity to the ear (frequency range of 300 MHz to 3 GHz)", February 2005
- c) Federal Communications Commission Office of Engineering & Technology (FCC OET), "Evaluating Compliance with FCC Guidelines for Human Exposure to Radiofrequency Electromagnetic Fields; Additional Information for Evaluating Compliance of Mobile and Portable Devices with FCC Limits for Human Exposure to Radiofrequency Emissions", Supplement C (Edition 01-01) to Bulletin 65

Additional Documentation:

- d) DASY4/5 System Handbook

Methods Applied and Interpretation of Parameters:

- *Measurement Conditions:* Further details are available from the Validation Report at the end of the certificate. All figures stated in the certificate are valid at the frequency indicated.
- *Antenna Parameters with TSL:* The dipole is mounted with the spacer to position its feed point exactly below the center marking of the flat phantom section, with the arms oriented parallel to the body axis.
- *Feed Point Impedance and Return Loss:* These parameters are measured with the dipole positioned under the liquid filled phantom. The impedance stated is transformed from the measurement at the SMA connector to the feed point. The Return Loss ensures low reflected power. No uncertainty required.
- *Electrical Delay:* One-way delay between the SMA connector and the antenna feed point. No uncertainty required.
- *SAR measured:* SAR measured at the stated antenna input power.
- *SAR normalized:* SAR as measured, normalized to an input power of 1 W at the antenna connector.
- *SAR for nominal TSL parameters:* The measured TSL parameters are used to calculate the nominal SAR result.

The reported uncertainty of measurement is stated as the standard uncertainty of measurement multiplied by the coverage factor k=2, which for a normal distribution corresponds to a coverage probability of approximately 95%.

	Document Appendix D for the BlackBerry® Smartphone Model RGB141LW SAR Report Rev 4		Page 26(69)
	Author Data Andrew Becker	Dates of Test June 11 – August 16, 2013 March 24-26, 2014 December 8 – 12, 2014	Test Report No RTS-6046-1308-39 Rev 6
		FCC ID: L6ARGB140LW	IC

Measurement Conditions

DASY system configuration, as far as not given on page 1.

DASY Version	DASY5	V52.8.4
Extrapolation	Advanced Extrapolation	
Phantom	Modular Flat Phantom	
Distance Dipole Center - TSL	15 mm	with Spacer
Zoom Scan Resolution	dx, dy, dz = 5 mm	
Frequency	835 MHz ± 1 MHz	

Head TSL parameters

The following parameters and calculations were applied.

	Temperature	Permittivity	Conductivity
Nominal Head TSL parameters	22.0 °C	41.5	0.90 mho/m
Measured Head TSL parameters	(22.0 ± 0.2) °C	42.0 ± 6 %	0.92 mho/m ± 6 %
Head TSL temperature change during test	< 0.5 °C	----	----

SAR result with Head TSL

SAR averaged over 1 cm ³ (1 g) of Head TSL	Condition	
SAR measured	250 mW input power	2.38 W/kg
SAR for nominal Head TSL parameters	normalized to 1W	9.39 W/kg ± 17.0 % (k=2)

SAR averaged over 10 cm ³ (10 g) of Head TSL	condition	
SAR measured	250 mW input power	1.55 W/kg
SAR for nominal Head TSL parameters	normalized to 1W	6.13 W/kg ± 16.5 % (k=2)

	Document		Page
	Appendix D for the BlackBerry® Smartphone Model RGB141LW SAR Report Rev 4		27(69)
Author Data	Dates of Test	Test Report No	FCC ID:
Andrew Becker	June 11 – August 16, 2013 March 24-26, 2014 December 8 – 12, 2014	RTS-6046-1308-39 Rev 6	L6ARGB140LW
			IC

Appendix

Antenna Parameters with Head TSL

Impedance, transformed to feed point	50.1 Ω - 6.5 j Ω
Return Loss	- 23.7 dB

General Antenna Parameters and Design

Electrical Delay (one direction)	1.385 ns
----------------------------------	----------

After long term use with 100W radiated power, only a slight warming of the dipole near the feedpoint can be measured.

The dipole is made of standard semirigid coaxial cable. The center conductor of the feeding line is directly connected to the second arm of the dipole. The antenna is therefore short-circuited for DC-signals. On some of the dipoles, small end caps are added to the dipole arms in order to improve matching when loaded according to the position as explained in the "Measurement Conditions" paragraph. The SAR data are not affected by this change. The overall dipole length is still according to the Standard.

No excessive force must be applied to the dipole arms, because they might bend or the soldered connections near the feedpoint may be damaged.

Additional EUT Data

Manufactured by	SPEAG
Manufactured on	October 24, 2001

	Document Appendix D for the BlackBerry® Smartphone Model RGB141LW SAR Report Rev 4		Page 28(69)
	Author Data Andrew Becker	Dates of Test June 11 – August 16, 2013 March 24-26, 2014 December 8 – 12, 2014	Test Report No RTS-6046-1308-39 Rev 6
		FCC ID: L6ARGB140LW	IC

DASY5 Validation Report for Head TSL

Date: 07.01.2013

Test Laboratory: SPEAG, Zurich, Switzerland

DUT: Dipole 835 MHz; Type: D835V2; Serial: D835V2 - SN: 446

Communication System: CW; Frequency: 835 MHz
 Medium parameters used: $f = 835 \text{ MHz}$; $\sigma = 0.92 \text{ S/m}$; $\epsilon_r = 42$; $\rho = 1000 \text{ kg/m}^3$
 Phantom section: Flat Section
 Measurement Standard: DASY5 (IEEE/IEC/ANSI C63.19-2007)

DASY52 Configuration:

- Probe: ES3DV3 - SN3205; ConvF(6.05, 6.05, 6.05); Calibrated: 28.12.2012;
- Sensor-Surface: 3mm (Mechanical Surface Detection)
- Electronics: DAE4 Sn601; Calibrated: 27.06.2012
- Phantom: Flat Phantom 4.9L; Type: QD000P49AA; Serial: 1001
- DASY52 52.8.4(1052); SEMCAD X 14.6.8(7028)

Dipole Calibration for Head Tissue/Pin=250 mW, d=15mm/Zoom Scan (7x7x7)/Cube 0:

Measurement grid: $dx=5\text{mm}$, $dy=5\text{mm}$, $dz=5\text{mm}$
 Reference Value = 56.650 V/m; Power Drift = 0.01 dB
 Peak SAR (extrapolated) = 3.61 W/kg
SAR(1 g) = 2.38 W/kg; SAR(10 g) = 1.55 W/kg
 Maximum value of SAR (measured) = 2.79 W/kg

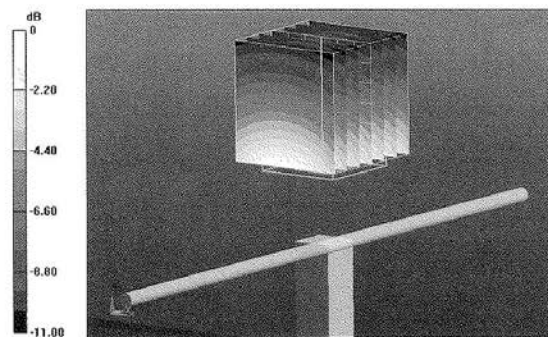

0 dB = 2.79 W/kg = 4.46 dBW/kg

	Document Appendix D for the BlackBerry® Smartphone Model RGB141LW SAR Report Rev 4		Page 29(69)
Author Data Andrew Becker	Dates of Test June 11 – August 16, 2013 March 24-26, 2014 December 8 – 12, 2014	Test Report No RTS-6046-1308-39 Rev 6	FCC ID: L6ARGB140LW

Impedance Measurement Plot for Head TSL

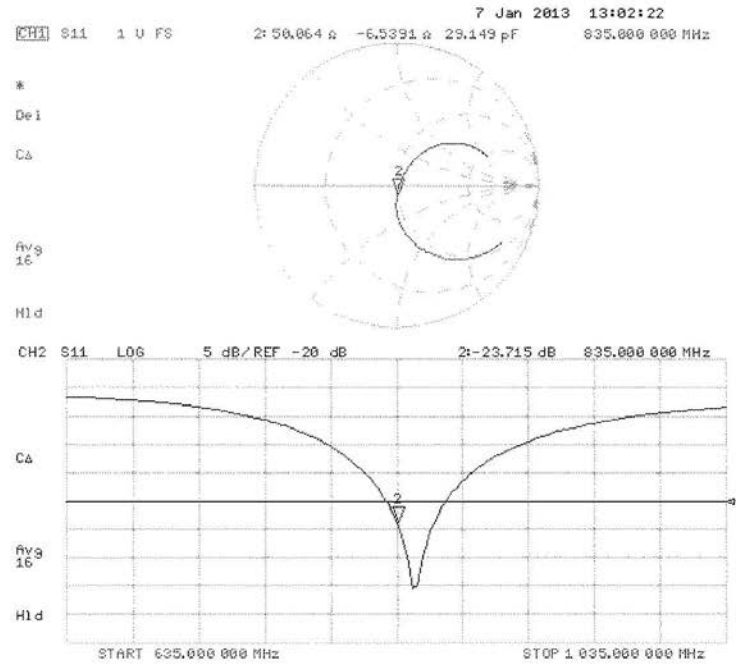

	Document Appendix D for the BlackBerry® Smartphone Model RGB141LW SAR Report Rev 4		Page 30(69)
	Author Data Andrew Becker	Dates of Test June 11 – August 16, 2013 March 24-26, 2014 December 8 – 12, 2014	Test Report No RTS-6046-1308-39 Rev 6
		FCC ID: L6ARGB140LW	IC

**Calibration Laboratory of
Schmid & Partner
Engineering AG**
Zeughausstrasse 43, 8004 Zurich, Switzerland



S Schweizerischer Kalibrierdienst
S Service suisse d'étalonnage
C Servizio svizzero di taratura
S Swiss Calibration Service

Accredited by the Swiss Accreditation Service (SAS)
The Swiss Accreditation Service is one of the signatories to the EA
Multilateral Agreement for the recognition of calibration certificates

Accreditation No.: **SCS 108**

Client **RTS (RIM Testing Services)**

Certificate No: **D1900V2-545_Jan13**

CALIBRATION CERTIFICATE

Object	D1900V2 - SN: 545		
Calibration procedure(s)	QA CAL-05.v9 Calibration procedure for dipole validation kits above 700 MHz		
Calibration date:	January 09, 2013		
<p>This calibration certificate documents the traceability to national standards, which realize the physical units of measurements (SI). The measurements and the uncertainties with confidence probability are given on the following pages and are part of the certificate.</p> <p>All calibrations have been conducted in the closed laboratory facility: environment temperature (22 ± 3)°C and humidity < 70%.</p> <p>Calibration Equipment used (M&TE critical for calibration)</p>			
Primary Standards	ID #	Cal Date (Certificate No.)	Scheduled Calibration
Power meter EPM-442A	GB37480704	01-Nov-12 (No. 217-01640)	Oct-13
Power sensor HP 8481A	US37292783	01-Nov-12 (No. 217-01640)	Oct-13
Reference 20 dB Attenuator	SN: 5058 (20k)	27-Mar-12 (No. 217-01530)	Apr-13
Type-N mismatch combination	SN: 5047.3 / 06327	27-Mar-12 (No. 217-01533)	Apr-13
Reference Probe ES3DV3	SN: 3205	28-Dec-12 (No. ES3-3205_Dec12)	Dec-13
DAE4	SN: 601	27-Jun-12 (No. DAE4-601_Jun12)	Jun-13
Secondary Standards	ID #	Check Date (in house)	Scheduled Check
Power sensor HP 8481A	MY41092317	18-Oct-02 (in house check Oct-11)	In house check: Oct-13
RF generator R&S SMT-06	100005	04-Aug-99 (in house check Oct-11)	In house check: Oct-13
Network Analyzer HP 8753E	US37390585 S4206	18-Oct-01 (in house check Oct-12)	In house check: Oct-13
Calibrated by:	Name Israe El-Naouq	Function Laboratory Technician	Signature
Approved by:	Name Katja Pokovic	Function Technical Manager	Signature
			Issued: January 9, 2013
This calibration certificate shall not be reproduced except in full without written approval of the laboratory.			

	Document Appendix D for the BlackBerry® Smartphone Model RGB141LW SAR Report Rev 4		Page 31(69)
	Author Data Andrew Becker	Dates of Test June 11 – August 16, 2013 March 24-26, 2014 December 8 – 12, 2014	Test Report No RTS-6046-1308-39 Rev 6
		FCC ID: L6ARGB140LW	IC

**Calibration Laboratory of
Schmid & Partner
Engineering AG**
Zeughausstrasse 43, 8004 Zurich, Switzerland



S Schweizerischer Kalibrierdienst
S Service suisse d'étalonnage
C Servizio svizzero di taratura
S Swiss Calibration Service

Accredited by the Swiss Accreditation Service (SAS)
The Swiss Accreditation Service is one of the signatories to the EA
Multilateral Agreement for the recognition of calibration certificates

Accreditation No.: **SCS 108**

Glossary:

TSL tissue simulating liquid
ConvF sensitivity in TSL / NORM x,y,z
N/A not applicable or not measured

Calibration is Performed According to the Following Standards:

- a) IEEE Std 1528-2003, "IEEE Recommended Practice for Determining the Peak Spatial-Averaged Specific Absorption Rate (SAR) in the Human Head from Wireless Communications Devices: Measurement Techniques", December 2003
- b) IEC 62209-1, "Procedure to measure the Specific Absorption Rate (SAR) for hand-held devices used in close proximity to the ear (frequency range of 300 MHz to 3 GHz)", February 2005
- c) Federal Communications Commission Office of Engineering & Technology (FCC OET), "Evaluating Compliance with FCC Guidelines for Human Exposure to Radiofrequency Electromagnetic Fields; Additional Information for Evaluating Compliance of Mobile and Portable Devices with FCC Limits for Human Exposure to Radiofrequency Emissions", Supplement C (Edition 01-01) to Bulletin 65

Additional Documentation:

- d) DASY4/5 System Handbook

Methods Applied and Interpretation of Parameters:

- *Measurement Conditions:* Further details are available from the Validation Report at the end of the certificate. All figures stated in the certificate are valid at the frequency indicated.
- *Antenna Parameters with TSL:* The dipole is mounted with the spacer to position its feed point exactly below the center marking of the flat phantom section, with the arms oriented parallel to the body axis.
- *Feed Point Impedance and Return Loss:* These parameters are measured with the dipole positioned under the liquid filled phantom. The impedance stated is transformed from the measurement at the SMA connector to the feed point. The Return Loss ensures low reflected power. No uncertainty required.
- *Electrical Delay:* One-way delay between the SMA connector and the antenna feed point. No uncertainty required.
- *SAR measured:* SAR measured at the stated antenna input power.
- *SAR normalized:* SAR as measured, normalized to an input power of 1 W at the antenna connector.
- *SAR for nominal TSL parameters:* The measured TSL parameters are used to calculate the nominal SAR result.

The reported uncertainty of measurement is stated as the standard uncertainty of measurement multiplied by the coverage factor k=2, which for a normal distribution corresponds to a coverage probability of approximately 95%.

	Document Appendix D for the BlackBerry® Smartphone Model RGB141LW SAR Report Rev 4		Page 32(69)
	Author Data Andrew Becker	Dates of Test June 11 – August 16, 2013 March 24-26, 2014 December 8 – 12, 2014	Test Report No RTS-6046-1308-39 Rev 6
		FCC ID: L6ARGB140LW	IC

Measurement Conditions

DASY system configuration, as far as not given on page 1.

DASY Version	DASY5	V52.8.4
Extrapolation	Advanced Extrapolation	
Phantom	Modular Flat Phantom	
Distance Dipole Center - TSL	10 mm	with Spacer
Zoom Scan Resolution	dx, dy, dz = 5 mm	
Frequency	1900 MHz ± 1 MHz	

Head TSL parameters

The following parameters and calculations were applied.

	Temperature	Permittivity	Conductivity
Nominal Head TSL parameters	22.0 °C	40.0	1.40 mho/m
Measured Head TSL parameters	(22.0 ± 0.2) °C	39.4 ± 6 %	1.38 mho/m ± 6 %
Head TSL temperature change during test	< 0.5 °C	----	----

SAR result with Head TSL

SAR averaged over 1 cm ³ (1 g) of Head TSL	Condition	
SAR measured	250 mW input power	10.0 W/kg
SAR for nominal Head TSL parameters	normalized to 1W	40.2 W/kg ± 17.0 % (k=2)

SAR averaged over 10 cm ³ (10 g) of Head TSL	condition	
SAR measured	250 mW input power	5.26 W/kg
SAR for nominal Head TSL parameters	normalized to 1W	21.1 W/kg ± 16.5 % (k=2)

	Document		Page
	Appendix D for the BlackBerry® Smartphone Model RGB141LW SAR Report Rev 4		33(69)
Author Data	Dates of Test	Test Report No	FCC ID:
Andrew Becker	June 11 – August 16, 2013 March 24-26, 2014 December 8 – 12, 2014	RTS-6046-1308-39 Rev 6	L6ARGB140LW
			IC

Appendix

Antenna Parameters with Head TSL

Impedance, transformed to feed point	51.0 Ω + 1.7 jΩ
Return Loss	- 34.3 dB

General Antenna Parameters and Design

Electrical Delay (one direction)	1.198 ns
----------------------------------	----------

After long term use with 100W radiated power, only a slight warming of the dipole near the feedpoint can be measured.

The dipole is made of standard semirigid coaxial cable. The center conductor of the feeding line is directly connected to the second arm of the dipole. The antenna is therefore short-circuited for DC-signals. On some of the dipoles, small end caps are added to the dipole arms in order to improve matching when loaded according to the position as explained in the "Measurement Conditions" paragraph. The SAR data are not affected by this change. The overall dipole length is still according to the Standard.

No excessive force must be applied to the dipole arms, because they might bend or the soldered connections near the feedpoint may be damaged.

Additional EUT Data

Manufactured by	SPEAG
Manufactured on	November 15, 2001

	Document Appendix D for the BlackBerry® Smartphone Model RGB141LW SAR Report Rev 4		Page 34(69)
	Author Data Andrew Becker	Dates of Test June 11 – August 16, 2013 March 24-26, 2014 December 8 – 12, 2014	Test Report No RTS-6046-1308-39 Rev 6

DASY5 Validation Report for Head TSL

Date: 09.01.2013

Test Laboratory: SPEAG, Zurich, Switzerland

DUT: Dipole 1900 MHz; Type: D1900V2; Serial: D1900V2 - SN: 545

Communication System: CW; Frequency: 1900 MHz
Medium parameters used: $f = 1900 \text{ MHz}$; $\sigma = 1.38 \text{ S/m}$; $\epsilon_r = 39.4$; $\rho = 1000 \text{ kg/m}^3$
Phantom section: Flat Section
Measurement Standard: DASY5 (IEEE/IEC/ANSI C63.19-2007)

DASY52 Configuration:

- Probe: ES3DV3 - SN3205; ConvF(4.98, 4.98, 4.98); Calibrated: 28.12.2012;
- Sensor-Surface: 3mm (Mechanical Surface Detection)
- Electronics: DAE4 Sn601; Calibrated: 27.06.2012
- Phantom: Flat Phantom 5.0 (front); Type: QD000P50AA; Serial: 1001
- DASY52 52.8.4(1052); SEMCAD X 14.6.8(7028)

Dipole Calibration for Head Tissue/Pin=250 mW, d=10mm/Zoom Scan (7x7x7)/Cube 0:

Measurement grid: $dx=5\text{mm}$, $dy=5\text{mm}$, $dz=5\text{mm}$
Reference Value = 95.493 V/m; Power Drift = 0.05 dB
Peak SAR (extrapolated) = 18.1 W/kg
SAR(1 g) = 10 W/kg; SAR(10 g) = 5.26 W/kg
Maximum value of SAR (measured) = 12.2 W/kg

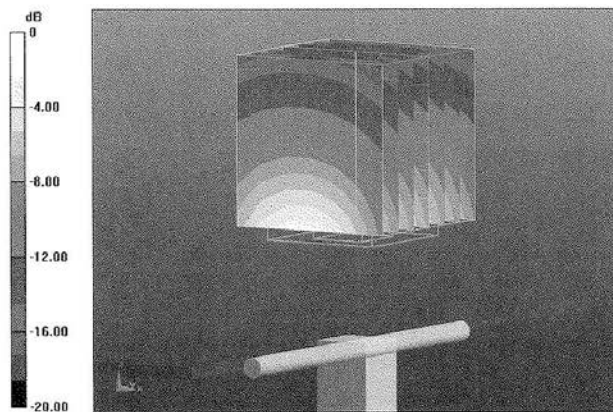

0 dB = 12.2 W/kg = 10.86 dBW/kg

	Document		Page
	Appendix D for the BlackBerry® Smartphone Model RGB141LW SAR Report Rev 4		35(69)
Author Data	Dates of Test	Test Report No	FCC ID:
Andrew Becker	June 11 – August 16, 2013 March 24-26, 2014 December 8 – 12, 2014	RTS-6046-1308-39 Rev 6	L6ARGB140LW
			IC

Impedance Measurement Plot for Head TSL

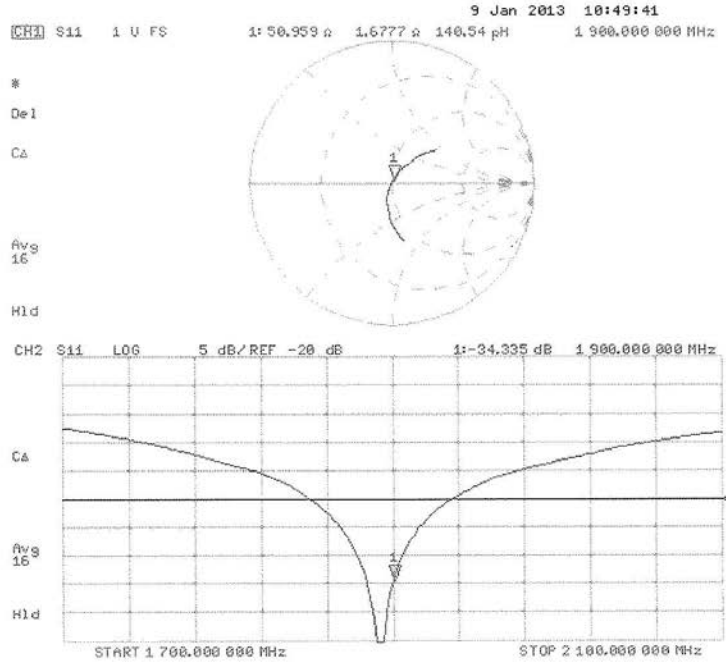

	Document	Appendix D for the BlackBerry® Smartphone Model RGB141LW SAR Report Rev 4		Page	36(69)
	Author Data	Dates of Test	Test Report No	FCC ID:	IC
Andrew Becker	June 11 – August 16, 2013 March 24-26, 2014 December 8 – 12, 2014	RTS-6046-1308-39 Rev 6	L6ARGB140LW		

Calibration Laboratory of Schmid & Partner Engineering AG
Zeughausstrasse 43, 8004 Zurich, Switzerland



S Schweizerischer Kalibrierdienst
C Service suisse d'étalonnage
S Servizio svizzero di taratura
S Swiss Calibration Service

Accredited by the Swiss Accreditation Service (SAS)
The Swiss Accreditation Service is one of the signatories to the EA Multilateral Agreement for the recognition of calibration certificates

Accreditation No.: SCS 108

Client **RTS (RIM Testing Services)**

Certificate No: D2450V2-747_Nov11

CALIBRATION CERTIFICATE

Object	D2450V2 - SN: 747																																														
Calibration procedure(s)	QA CAL-05.v8 Calibration procedure for dipole validation kits above 700 MHz																																														
Calibration date:	November 09, 2011																																														
<p>This calibration certificate documents the traceability to national standards, which realize the physical units of measurements (SI). The measurements and the uncertainties with confidence probability are given on the following pages and are part of the certificate.</p> <p>All calibrations have been conducted in the closed laboratory facility: environment temperature (22 ± 3)°C and humidity < 70%.</p> <p>Calibration Equipment used (M&TE critical for calibration)</p> <table border="1"> <thead> <tr> <th>Primary Standards</th> <th>ID #</th> <th>Cal Date (Certificate No.)</th> <th>Scheduled Calibration</th> </tr> </thead> <tbody> <tr> <td>Power meter EPM-442A</td> <td>GB37480704</td> <td>05-Oct-11 (No. 217-01451)</td> <td>Oct-12</td> </tr> <tr> <td>Power sensor HP 8481A</td> <td>US37292783</td> <td>05-Oct-11 (No. 217-01451)</td> <td>Oct-12</td> </tr> <tr> <td>Reference 20 dB Attenuator</td> <td>SN: 5086 (20g)</td> <td>29-Mar-11 (No. 217-01368)</td> <td>Apr-12</td> </tr> <tr> <td>Type-N mismatch combination</td> <td>SN: 5047.2 / 06327</td> <td>29-Mar-11 (No. 217-01371)</td> <td>Apr-12</td> </tr> <tr> <td>Reference Probe ES3DV3</td> <td>SN: 3205</td> <td>29-Apr-11 (No. ES3-3205_Apr11)</td> <td>Apr-12</td> </tr> <tr> <td>DAE4</td> <td>SN: 601</td> <td>04-Jul-11 (No. DAE4-601_Jul11)</td> <td>Jul-12</td> </tr> </tbody> </table> <table border="1"> <thead> <tr> <th>Secondary Standards</th> <th>ID #</th> <th>Check Date (in house)</th> <th>Scheduled Check</th> </tr> </thead> <tbody> <tr> <td>Power sensor HP 8481A</td> <td>MY41092317</td> <td>18-Oct-02 (in house check Oct-11)</td> <td>In house check: Oct-13</td> </tr> <tr> <td>RF generator R&S SMT-06</td> <td>100005</td> <td>04-Aug-99 (in house check Oct-11)</td> <td>In house check: Oct-13</td> </tr> <tr> <td>Network Analyzer HP 8753E</td> <td>US37390585 S4206</td> <td>18-Oct-01 (in house check Oct-11)</td> <td>In house check: Oct-12</td> </tr> </tbody> </table>				Primary Standards	ID #	Cal Date (Certificate No.)	Scheduled Calibration	Power meter EPM-442A	GB37480704	05-Oct-11 (No. 217-01451)	Oct-12	Power sensor HP 8481A	US37292783	05-Oct-11 (No. 217-01451)	Oct-12	Reference 20 dB Attenuator	SN: 5086 (20g)	29-Mar-11 (No. 217-01368)	Apr-12	Type-N mismatch combination	SN: 5047.2 / 06327	29-Mar-11 (No. 217-01371)	Apr-12	Reference Probe ES3DV3	SN: 3205	29-Apr-11 (No. ES3-3205_Apr11)	Apr-12	DAE4	SN: 601	04-Jul-11 (No. DAE4-601_Jul11)	Jul-12	Secondary Standards	ID #	Check Date (in house)	Scheduled Check	Power sensor HP 8481A	MY41092317	18-Oct-02 (in house check Oct-11)	In house check: Oct-13	RF generator R&S SMT-06	100005	04-Aug-99 (in house check Oct-11)	In house check: Oct-13	Network Analyzer HP 8753E	US37390585 S4206	18-Oct-01 (in house check Oct-11)	In house check: Oct-12
Primary Standards	ID #	Cal Date (Certificate No.)	Scheduled Calibration																																												
Power meter EPM-442A	GB37480704	05-Oct-11 (No. 217-01451)	Oct-12																																												
Power sensor HP 8481A	US37292783	05-Oct-11 (No. 217-01451)	Oct-12																																												
Reference 20 dB Attenuator	SN: 5086 (20g)	29-Mar-11 (No. 217-01368)	Apr-12																																												
Type-N mismatch combination	SN: 5047.2 / 06327	29-Mar-11 (No. 217-01371)	Apr-12																																												
Reference Probe ES3DV3	SN: 3205	29-Apr-11 (No. ES3-3205_Apr11)	Apr-12																																												
DAE4	SN: 601	04-Jul-11 (No. DAE4-601_Jul11)	Jul-12																																												
Secondary Standards	ID #	Check Date (in house)	Scheduled Check																																												
Power sensor HP 8481A	MY41092317	18-Oct-02 (in house check Oct-11)	In house check: Oct-13																																												
RF generator R&S SMT-06	100005	04-Aug-99 (in house check Oct-11)	In house check: Oct-13																																												
Network Analyzer HP 8753E	US37390585 S4206	18-Oct-01 (in house check Oct-11)	In house check: Oct-12																																												
Calibrated by:	Name Jeton Kastrioti	Function Laboratory Technician	Signature 																																												
Approved by:	Name Katja Pokovic	Function Technical Manager	Signature 																																												
			Issued: November 9, 2011																																												
This calibration certificate shall not be reproduced except in full without written approval of the laboratory.																																															

	Document Appendix D for the BlackBerry® Smartphone Model RGB141LW SAR Report Rev 4		Page 37(69)
	Author Data Andrew Becker	Dates of Test June 11 – August 16, 2013 March 24-26, 2014 December 8 – 12, 2014	Test Report No RTS-6046-1308-39 Rev 6
		FCC ID: L6ARGB140LW	IC

**Calibration Laboratory of
Schmid & Partner
Engineering AG**
Zeughausstrasse 43, 8004 Zurich, Switzerland



S Schweizerischer Kalibrierdienst
S Service suisse d'étalonnage
S Servizio svizzero di taratura
S Swiss Calibration Service

Accredited by the Swiss Accreditation Service (SAS)
The Swiss Accreditation Service is one of the signatories to the EA
Multilateral Agreement for the recognition of calibration certificates

Accreditation No.: **SCS 108**

Glossary:

TSL tissue simulating liquid
ConvF sensitivity in TSL / NORM x,y,z
N/A not applicable or not measured

Calibration is Performed According to the Following Standards:

- a) IEEE Std 1528-2003, "IEEE Recommended Practice for Determining the Peak Spatial-Averaged Specific Absorption Rate (SAR) in the Human Head from Wireless Communications Devices: Measurement Techniques", December 2003
- b) IEC 62209-1, "Procedure to measure the Specific Absorption Rate (SAR) for hand-held devices used in close proximity to the ear (frequency range of 300 MHz to 3 GHz)", February 2005
- c) Federal Communications Commission Office of Engineering & Technology (FCC OET), "Evaluating Compliance with FCC Guidelines for Human Exposure to Radiofrequency Electromagnetic Fields; Additional Information for Evaluating Compliance of Mobile and Portable Devices with FCC Limits for Human Exposure to Radiofrequency Emissions", Supplement C (Edition 01-01) to Bulletin 65

Additional Documentation:

- d) DASY4/5 System Handbook

Methods Applied and Interpretation of Parameters:

- *Measurement Conditions:* Further details are available from the Validation Report at the end of the certificate. All figures stated in the certificate are valid at the frequency indicated.
- *Antenna Parameters with TSL:* The dipole is mounted with the spacer to position its feed point exactly below the center marking of the flat phantom section, with the arms oriented parallel to the body axis.
- *Feed Point Impedance and Return Loss:* These parameters are measured with the dipole positioned under the liquid filled phantom. The impedance stated is transformed from the measurement at the SMA connector to the feed point. The Return Loss ensures low reflected power. No uncertainty required.
- *Electrical Delay:* One-way delay between the SMA connector and the antenna feed point. No uncertainty required.
- *SAR measured:* SAR measured at the stated antenna input power.
- *SAR normalized:* SAR as measured, normalized to an input power of 1 W at the antenna connector.
- *SAR for nominal TSL parameters:* The measured TSL parameters are used to calculate the nominal SAR result.

	Document Appendix D for the BlackBerry® Smartphone Model RGB141LW SAR Report Rev 4		Page 38(69)
	Author Data Andrew Becker	Dates of Test June 11 – August 16, 2013 March 24-26, 2014 December 8 – 12, 2014	Test Report No RTS-6046-1308-39 Rev 6
		FCC ID: L6ARGB140LW	IC

Measurement Conditions

DASY system configuration, as far as not given on page 1.

DASY Version	DASY5	V52.6.2
Extrapolation	Advanced Extrapolation	
Phantom	Modular Flat Phantom	
Distance Dipole Center - TSL	10 mm	with Spacer
Zoom Scan Resolution	dx, dy, dz = 5 mm	
Frequency	2450 MHz ± 1 MHz	

Head TSL parameters

The following parameters and calculations were applied.

	Temperature	Permittivity	Conductivity
Nominal Head TSL parameters	22.0 °C	39.2	1.80 mho/m
Measured Head TSL parameters	(22.0 ± 0.2) °C	37.7 ± 6 %	1.84 mho/m ± 6 %
Head TSL temperature change during test	< 0.5 °C	----	----

SAR result with Head TSL

SAR averaged over 1 cm³ (1 g) of Head TSL	Condition	
SAR measured	250 mW input power	13.8 mW / g
SAR for nominal Head TSL parameters	normalized to 1W	54.1 mW /g ± 17.0 % (k=2)
SAR averaged over 10 cm³ (10 g) of Head TSL	condition	
SAR measured	250 mW input power	6.39 mW / g
SAR for nominal Head TSL parameters	normalized to 1W	25.3 mW /g ± 16.5 % (k=2)

	Document			Page
	Appendix D for the BlackBerry® Smartphone Model RGB141LW SAR Report Rev 4			39(69)
Author Data	Dates of Test	Test Report No	FCC ID:	IC
Andrew Becker	June 11 – August 16, 2013 March 24-26, 2014 December 8 – 12, 2014	RTS-6046-1308-39 Rev 6	L6ARGB140LW	

Appendix

Antenna Parameters with Head TSL

Impedance, transformed to feed point	52.5 Ω + 1.3 jΩ
Return Loss	- 31.2 dB

General Antenna Parameters and Design

Electrical Delay (one direction)	1.161 ns
----------------------------------	----------

After long term use with 100W radiated power, only a slight warming of the dipole near the feedpoint can be measured.

The dipole is made of standard semirigid coaxial cable. The center conductor of the feeding line is directly connected to the second arm of the dipole. The antenna is therefore short-circuited for DC-signals.

No excessive force must be applied to the dipole arms, because they might bend or the soldered connections near the feedpoint may be damaged.

Additional EUT Data

Manufactured by	SPEAG
Manufactured on	December 01, 2003

	Document Appendix D for the BlackBerry® Smartphone Model RGB141LW SAR Report Rev 4		Page 40(69)
	Author Data Andrew Becker	Dates of Test June 11 – August 16, 2013 March 24-26, 2014 December 8 – 12, 2014	Test Report No RTS-6046-1308-39 Rev 6

DASY5 Validation Report for Head TSL

Date: 09.11.2011

Test Laboratory: SPEAG, Zurich, Switzerland

DUT: Dipole 2450 MHz; Type: D2450V2; Serial: D2450V2 - SN: 747

Communication System: CW; Frequency: 2450 MHz
Medium parameters used: $f = 2450$ MHz; $\sigma = 1.84$ mho/m; $\epsilon_r = 37.7$; $\rho = 1000$ kg/m³
Phantom section: Flat Section
Measurement Standard: DASY5 (IEEE/IEC/ANSI C63.19-2007)

DASY52 Configuration:

- Probe: ES3DV3 - SN3205; ConvF(4.45, 4.45, 4.45); Calibrated: 29.04.2011
- Sensor-Surface: 3mm (Mechanical Surface Detection)
- Electronics: DAE4 Sn601; Calibrated: 04.07.2011
- Phantom: Flat Phantom 5.0 (front); Type: QD000P50AA; Serial: 1001
- DASY52 52.6.2(482); SEMCAD X 14.4.5(3634)

Dipole Calibration for Head Tissue/Pin=250 mW, d=10mm/Zoom Scan (7x7x7)/Cube 0:

Measurement grid: dx=5mm, dy=5mm, dz=5mm
Reference Value = 102.1 V/m; Power Drift = 0.04 dB
Peak SAR (extrapolated) = 28.853 W/kg
SAR(1 g) = 13.8 mW/g; SAR(10 g) = 6.39 mW/g
Maximum value of SAR (measured) = 17.782 mW/g

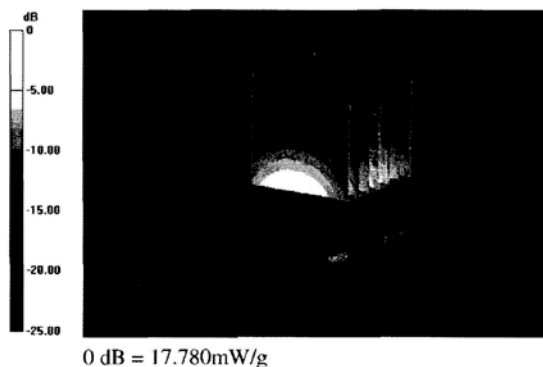

	Document Appendix D for the BlackBerry® Smartphone Model RGB141LW SAR Report Rev 4		Page 41(69)
	Author Data Andrew Becker	Dates of Test June 11 – August 16, 2013 March 24-26, 2014 December 8 – 12, 2014	Test Report No RTS-6046-1308-39 Rev 6

Impedance Measurement Plot for Head TSL

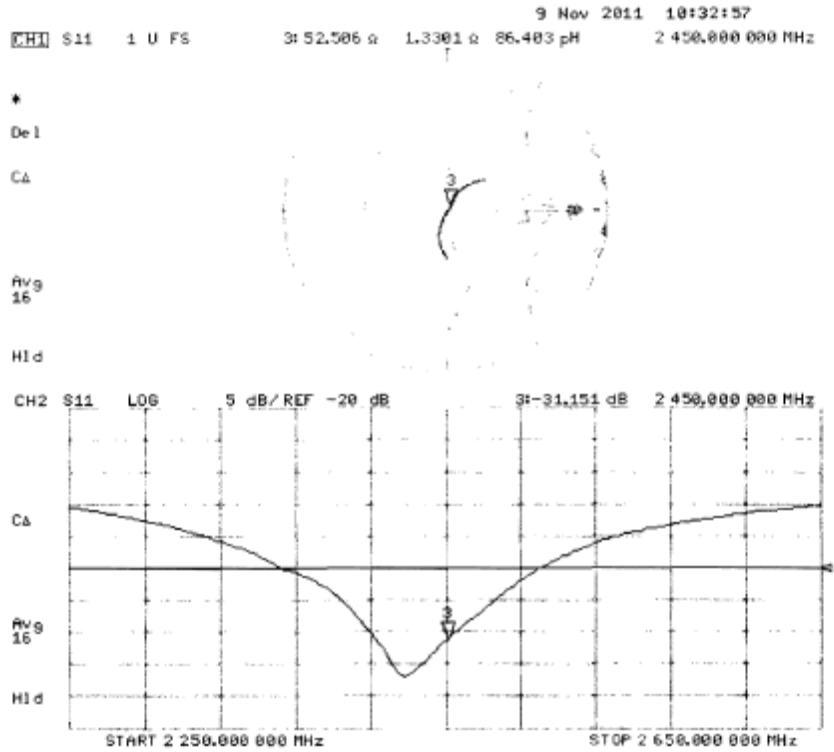

	Document Appendix D for the BlackBerry® Smartphone Model RGB141LW SAR Report Rev 4		Page 42(69)
	Author Data Andrew Becker	Dates of Test June 11 – August 16, 2013 March 24-26, 2014 December 8 – 12, 2014	Test Report No RTS-6046-1308-39 Rev 6
		FCC ID: L6ARGB140LW	IC

Calibration Laboratory of Schmid & Partner Engineering AG
Zeughausstrasse 43, 8004 Zurich, Switzerland





S Schweizerischer Kalibrierdienst
S Service suisse d'étalonnage
C Servizio svizzero di taratura
S Swiss Calibration Service

Accredited by the Swiss Accreditation Service (SAS)
The Swiss Accreditation Service is one of the signatories to the EA Multilateral Agreement for the recognition of calibration certificates

Accreditation No.: **SCS 108**

Client **RTS (RIM Testing Services)**

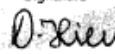
Certificate No: **D5GHzV2-1033_Nov11**

CALIBRATION CERTIFICATE																																															
Object	D5GHzV2 - SN: 1033																																														
Calibration procedure(s)	QA CAL-22.v1 Calibration procedure for dipole validation kits between 3-6 GHz																																														
Calibration date:	November 15, 2011																																														
<p>This calibration certificate documents the traceability to national standards, which realize the physical units of measurements (SI). The measurements and the uncertainties with confidence probability are given on the following pages and are part of the certificate.</p> <p>All calibrations have been conducted in the closed laboratory facility: environment temperature (22 ± 3)°C and humidity < 70%.</p> <p>Calibration Equipment used (M&TE critical for calibration)</p> <table border="1"> <thead> <tr> <th>Primary Standards</th> <th>ID #</th> <th>Cal Date (Certificate No.)</th> <th>Scheduled Calibration</th> </tr> </thead> <tbody> <tr> <td>Power meter EPM-442A</td> <td>GB37480704</td> <td>05-Oct-11 (No. 217-01451)</td> <td>Oct-12</td> </tr> <tr> <td>Power sensor HP B481A</td> <td>US37292783</td> <td>05-Oct-11 (No. 217-01451)</td> <td>Oct-12</td> </tr> <tr> <td>Reference 20 dB Attenuator</td> <td>SN: 5086 (20g)</td> <td>29-Mar-11 (No. 217-01368)</td> <td>Apr-12</td> </tr> <tr> <td>Type-N mismatch combination</td> <td>SN: 5047.2 / 06327</td> <td>29-Mar-11 (No. 217-01371)</td> <td>Apr-12</td> </tr> <tr> <td>Reference Probe EX3DV4</td> <td>SN: 3503</td> <td>04-Mar-11 (No. EX3-3503_Mar11)</td> <td>Mar-12</td> </tr> <tr> <td>DAE4</td> <td>SN: 601</td> <td>04-Jul-11 (No. DAE4-601_Jul11)</td> <td>Jul-12</td> </tr> </tbody> </table> <table border="1"> <thead> <tr> <th>Secondary Standards</th> <th>ID #</th> <th>Check Date (in house)</th> <th>Scheduled Check</th> </tr> </thead> <tbody> <tr> <td>Power sensor HP B481A</td> <td>MY41092317</td> <td>18-Oct-02 (in house check Oct-11)</td> <td>In house check: Oct-13</td> </tr> <tr> <td>RF generator R&S SMT-06</td> <td>100005</td> <td>04-Aug-99 (in house check Oct-11)</td> <td>In house check: Oct-13</td> </tr> <tr> <td>Network Analyzer HP 8753E</td> <td>US37390585 S4206</td> <td>18-Oct-01 (in house check Oct-11)</td> <td>In house check: Oct-12</td> </tr> </tbody> </table>				Primary Standards	ID #	Cal Date (Certificate No.)	Scheduled Calibration	Power meter EPM-442A	GB37480704	05-Oct-11 (No. 217-01451)	Oct-12	Power sensor HP B481A	US37292783	05-Oct-11 (No. 217-01451)	Oct-12	Reference 20 dB Attenuator	SN: 5086 (20g)	29-Mar-11 (No. 217-01368)	Apr-12	Type-N mismatch combination	SN: 5047.2 / 06327	29-Mar-11 (No. 217-01371)	Apr-12	Reference Probe EX3DV4	SN: 3503	04-Mar-11 (No. EX3-3503_Mar11)	Mar-12	DAE4	SN: 601	04-Jul-11 (No. DAE4-601_Jul11)	Jul-12	Secondary Standards	ID #	Check Date (in house)	Scheduled Check	Power sensor HP B481A	MY41092317	18-Oct-02 (in house check Oct-11)	In house check: Oct-13	RF generator R&S SMT-06	100005	04-Aug-99 (in house check Oct-11)	In house check: Oct-13	Network Analyzer HP 8753E	US37390585 S4206	18-Oct-01 (in house check Oct-11)	In house check: Oct-12
Primary Standards	ID #	Cal Date (Certificate No.)	Scheduled Calibration																																												
Power meter EPM-442A	GB37480704	05-Oct-11 (No. 217-01451)	Oct-12																																												
Power sensor HP B481A	US37292783	05-Oct-11 (No. 217-01451)	Oct-12																																												
Reference 20 dB Attenuator	SN: 5086 (20g)	29-Mar-11 (No. 217-01368)	Apr-12																																												
Type-N mismatch combination	SN: 5047.2 / 06327	29-Mar-11 (No. 217-01371)	Apr-12																																												
Reference Probe EX3DV4	SN: 3503	04-Mar-11 (No. EX3-3503_Mar11)	Mar-12																																												
DAE4	SN: 601	04-Jul-11 (No. DAE4-601_Jul11)	Jul-12																																												
Secondary Standards	ID #	Check Date (in house)	Scheduled Check																																												
Power sensor HP B481A	MY41092317	18-Oct-02 (in house check Oct-11)	In house check: Oct-13																																												
RF generator R&S SMT-06	100005	04-Aug-99 (in house check Oct-11)	In house check: Oct-13																																												
Network Analyzer HP 8753E	US37390585 S4206	18-Oct-01 (in house check Oct-11)	In house check: Oct-12																																												
Calibrated by:	Name Dimce Iliev	Function Laboratory Technician	Signature 																																												
Approved by:	Name Katja Pokovic	Function Technical Manager	Signature 																																												
<p>Issued: November 16, 2011</p> <p>This calibration certificate shall not be reproduced except in full without written approval of the laboratory.</p>																																															

	Document Appendix D for the BlackBerry® Smartphone Model RGB141LW SAR Report Rev 4		Page 43(69)	
	Author Data Andrew Becker	Dates of Test June 11 – August 16, 2013 March 24-26, 2014 December 8 – 12, 2014	Test Report No RTS-6046-1308-39 Rev 6	FCC ID: L6ARGB140LW

**Calibration Laboratory of
Schmid & Partner
Engineering AG**
Zeughausstrasse 43, 8004 Zurich, Switzerland



S Schweizerischer Kalibrierdienst
S Service suisse d'étalonnage
C Servizio svizzero di taratura
S Swiss Calibration Service

Accredited by the Swiss Accreditation Service (SAS)
The Swiss Accreditation Service is one of the signatories to the EA
Multilateral Agreement for the recognition of calibration certificates

Accreditation No.: **SCS 108**

Glossary:

TSL tissue simulating liquid
ConvF sensitivity in TSL / NORM x,y,z
N/A not applicable or not measured

Calibration is Performed According to the Following Standards:

- IEEE Std 1528-2003, "IEEE Recommended Practice for Determining the Peak Spatial-Averaged Specific Absorption Rate (SAR) in the Human Head from Wireless Communications Devices: Measurement Techniques", December 2003
- IEC 62209-1, "Procedure to measure the Specific Absorption Rate (SAR) for hand-held devices used in close proximity to the ear (frequency range of 300 MHz to 3 GHz)", February 2005
- Federal Communications Commission Office of Engineering & Technology (FCC OET), "Evaluating Compliance with FCC Guidelines for Human Exposure to Radiofrequency Electromagnetic Fields; Additional Information for Evaluating Compliance of Mobile and Portable Devices with FCC Limits for Human Exposure to Radiofrequency Emissions", Supplement C (Edition 01-01) to Bulletin 65

Additional Documentation:

- DASY4/5 System Handbook

Methods Applied and Interpretation of Parameters:

- Measurement Conditions:* Further details are available from the Validation Report at the end of the certificate. All figures stated in the certificate are valid at the frequency indicated.
- Antenna Parameters with TSL:* The dipole is mounted with the spacer to position its feed point exactly below the center marking of the flat phantom section, with the arms oriented parallel to the body axis.
- Feed Point Impedance and Return Loss:* These parameters are measured with the dipole positioned under the liquid filled phantom. The impedance stated is transformed from the measurement at the SMA connector to the feed point. The Return Loss ensures low reflected power. No uncertainty required.
- Electrical Delay:* One-way delay between the SMA connector and the antenna feed point. No uncertainty required.
- SAR measured:* SAR measured at the stated antenna input power.
- SAR normalized:* SAR as measured, normalized to an input power of 1 W at the antenna connector.
- SAR for nominal TSL parameters:* The measured TSL parameters are used to calculate the nominal SAR result.

	Document Appendix D for the BlackBerry® Smartphone Model RGB141LW SAR Report Rev 4		Page 44(69)
	Author Data Andrew Becker	Dates of Test June 11 – August 16, 2013 March 24-26, 2014 December 8 – 12, 2014	Test Report No RTS-6046-1308-39 Rev 6
		FCC ID: L6ARGB140LW	IC

Measurement Conditions

DASY system configuration, as far as not given on page 1.

DASY Version	DASY5	V52.6.2
Extrapolation	Advanced Extrapolation	
Phantom	Modular Flat Phantom V5.0	
Distance Dipole Center - TSL	10 mm	with Spacer
Zoom Scan Resolution	dx, dy = 4.0 mm, dz = 1.4 mm	Graded Ratio = 1.4 (Z direction)
Frequency	5200 MHz ± 1 MHz 5500 MHz ± 1 MHz 5800 MHz ± 1 MHz	

Head TSL parameters at 5200 MHz

The following parameters and calculations were applied.

	Temperature	Permittivity	Conductivity
Nominal Head TSL parameters	22.0 °C	36.0	4.66 mho/m
Measured Head TSL parameters	(22.0 ± 0.2) °C	34.6 ± 6 %	4.46 mho/m ± 6 %
Head TSL temperature change during test	< 0.5 °C	----	----

SAR result with Head TSL at 5200 MHz

SAR averaged over 1 cm³ (1 g) of Head TSL	Condition	
SAR measured	100 mW input power	8.16 mW / g
SAR for nominal Head TSL parameters	normalized to 1W	80.8 mW / g ± 17.0 % (k=2)

SAR averaged over 10 cm³ (10 g) of Head TSL	condition	
SAR measured	100 mW input power	2.33 mW / g
SAR for nominal Head TSL parameters	normalized to 1W	23.0 mW / g ± 16.5 % (k=2)

Head TSL parameters at 5500 MHz

The following parameters and calculations were applied.

	Temperature	Permittivity	Conductivity
Nominal Head TSL parameters	22.0 °C	35.6	4.96 mho/m
Measured Head TSL parameters	(22.0 ± 0.2) °C	34.2 ± 6 %	4.75 mho/m ± 6 %
Head TSL temperature change during test	< 0.5 °C	----	----

SAR result with Head TSL at 5500 MHz

SAR averaged over 1 cm³ (1 g) of Head TSL	Condition	
SAR measured	100 mW input power	8.82 mW / g
SAR for nominal Head TSL parameters	normalized to 1W	87.3 mW / g ± 17.0 % (k=2)

SAR averaged over 10 cm³ (10 g) of Head TSL	condition	
SAR measured	100 mW input power	2.50 mW / g
SAR for nominal Head TSL parameters	normalized to 1W	24.7 mW / g ± 16.5 % (k=2)

	Document		Page
	Appendix D for the BlackBerry® Smartphone Model RGB141LW SAR Report Rev 4		45(69)
Author Data Andrew Becker	Dates of Test June 11 – August 16, 2013 March 24-26, 2014 December 8 – 12, 2014	Test Report No RTS-6046-1308-39 Rev 6	FCC ID: L6ARGB140LW IC

Head TSL parameters at 5800 MHz

The following parameters and calculations were applied.

	Temperature	Permittivity	Conductivity
Nominal Head TSL parameters	22.0 °C	35.3	5.27 mho/m
Measured Head TSL parameters	(22.0 ± 0.2) °C	33.7 ± 6 %	5.03 mho/m ± 6 %
Head TSL temperature change during test	< 0.5 °C	----	----

SAR result with Head TSL at 5800 MHz

SAR averaged over 1 cm ³ (1 g) of Head TSL	Condition	
SAR measured	100 mW input power	8.03 mW / g
SAR for nominal Head TSL parameters	normalized to 1W	79.4 mW / g ± 17.0 % (k=2)

SAR averaged over 10 cm ³ (10 g) of Head TSL	condition	
SAR measured	100 mW input power	2.28 mW / g
SAR for nominal Head TSL parameters	normalized to 1W	22.5 mW / g ± 16.5 % (k=2)

	Document		Page
	Appendix D for the BlackBerry® Smartphone Model RGB141LW SAR Report Rev 4		46(69)
Author Data Andrew Becker	Dates of Test June 11 – August 16, 2013 March 24-26, 2014 December 8 – 12, 2014	Test Report No RTS-6046-1308-39 Rev 6	FCC ID: L6ARGB140LW IC

Appendix

Antenna Parameters with Head TSL at 5200 MHz

Impedance, transformed to feed point	51.1 Ω - 8.7 j Ω
Return Loss	- 21.2 dB

Antenna Parameters with Head TSL at 5500 MHz

Impedance, transformed to feed point	52.3 Ω - 2.7 j Ω
Return Loss	- 29.2 dB

Antenna Parameters with Head TSL at 5800 MHz

Impedance, transformed to feed point	56.7 Ω - 4.3 j Ω
Return Loss	- 22.6 dB

General Antenna Parameters and Design

Electrical Delay (one direction)	1.202 ns
----------------------------------	----------

After long term use with 100W radiated power, only a slight warming of the dipole near the feedpoint can be measured.

The dipole is made of standard semirigid coaxial cable. The center conductor of the feeding line is directly connected to the second arm of the dipole. The antenna is therefore short-circuited for DC-signals.

No excessive force must be applied to the dipole arms, because they might bend or the soldered connections near the feedpoint may be damaged.

Additional EUT Data

Manufactured by	SPEAG
Manufactured on	July 09, 2004

	Document Appendix D for the BlackBerry® Smartphone Model RGB141LW SAR Report Rev 4		Page 47(69)
	Author Data Andrew Becker	Dates of Test June 11 – August 16, 2013 March 24-26, 2014 December 8 – 12, 2014	Test Report No RTS-6046-1308-39 Rev 6

DASY5 Validation Report for Head TSL

Date: 15.11.2011

Test Laboratory: SPEAG, Zurich, Switzerland

DUT: Dipole 5GHz; Type: D5GHzV2; Serial: D5GHzV2 - SN: 1033

Communication System: CW; Frequency: 5200 MHz, Frequency: 5500 MHz, Frequency: 5800 MHz
Medium parameters used: $f = 5200$ MHz; $\sigma = 4.46$ mho/m; $\epsilon_r = 34.6$; $\rho = 1000$ kg/m³, Medium parameters used: $f = 5500$ MHz; $\sigma = 4.75$ mho/m; $\epsilon_r = 34.2$; $\rho = 1000$ kg/m³, Medium parameters used: $f = 5800$ MHz; $\sigma = 5.03$ mho/m; $\epsilon_r = 33.7$; $\rho = 1000$ kg/m³

Phantom section: Flat Section

Measurement Standard: DASY5 (IEEE/IEC/ANSI C63.19-2007)

DASY52 Configuration:

- Probe: EX3DV4 - SN3503; ConvF(5.41, 5.41, 5.41), ConvF(4.91, 4.91, 4.91), ConvF(4.81, 4.81, 4.81); Calibrated: 04.03.2011
- Sensor-Surface: 1.4mm (Mechanical Surface Detection)
- Electronics: DAE4 Sn601; Calibrated: 04.07.2011
- Phantom: Flat Phantom 5.0 (front); Type: QD000P50AA; Serial: 1001
- DASY52 52.6.2(482); SEMCAD X 14.4.5(3634)

Dipole Calibration for Head Tissue/Pin=100mW, dist=10mm, f=5200 MHz/Zoom Scan,

dist=1.4mm (8x8x7)/Cube 0: Measurement grid: dx=4mm, dy=4mm, dz=1.4mm

Reference Value = 65.595 V/m; Power Drift = 0.07 dB

Peak SAR (extrapolated) = 30.134 W/kg

SAR(1 g) = 8.16 mW/g; SAR(10 g) = 2.33 mW/g

Maximum value of SAR (measured) = 18.725 mW/g

Dipole Calibration for Head Tissue/Pin=100mW, dist=10mm, f=5500 MHz/Zoom Scan,

dist=1.4mm (8x8x7)/Cube 0: Measurement grid: dx=4mm, dy=4mm, dz=1.4mm

Reference Value = 66.819 V/m; Power Drift = 0.03 dB

Peak SAR (extrapolated) = 35.056 W/kg

SAR(1 g) = 8.82 mW/g; SAR(10 g) = 2.5 mW/g

Maximum value of SAR (measured) = 21.019 mW/g

Dipole Calibration for Head Tissue/Pin=100mW, dist=10mm, f=5800 MHz/Zoom Scan,

dist=1.4mm (8x8x7)/Cube 0: Measurement grid: dx=4mm, dy=4mm, dz=1.4mm

Reference Value = 62.220 V/m; Power Drift = 0.04 dB

Peak SAR (extrapolated) = 33.743 W/kg

SAR(1 g) = 8.03 mW/g; SAR(10 g) = 2.28 mW/g

Maximum value of SAR (measured) = 19.463 mW/g

	Document Appendix D for the BlackBerry® Smartphone Model RGB141LW SAR Report Rev 4			Page 48(69)
Author Data Andrew Becker	Dates of Test June 11 – August 16, 2013 March 24-26, 2014 December 8 – 12, 2014	Test Report No RTS-6046-1308-39 Rev 6	FCC ID: L6ARGB140LW	IC

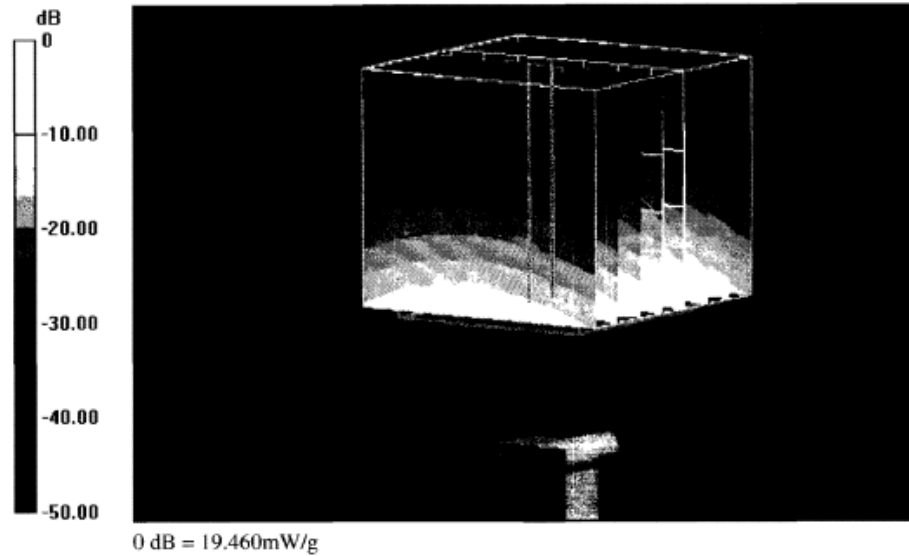

	Document Appendix D for the BlackBerry® Smartphone Model RGB141LW SAR Report Rev 4	Page 49(69)		
Author Data Andrew Becker	Dates of Test June 11 – August 16, 2013 March 24-26, 2014 December 8 – 12, 2014	Test Report No RTS-6046-1308-39 Rev 6	FCC ID: L6ARGB140LW	IC

Impedance Measurement Plot for Head TSL

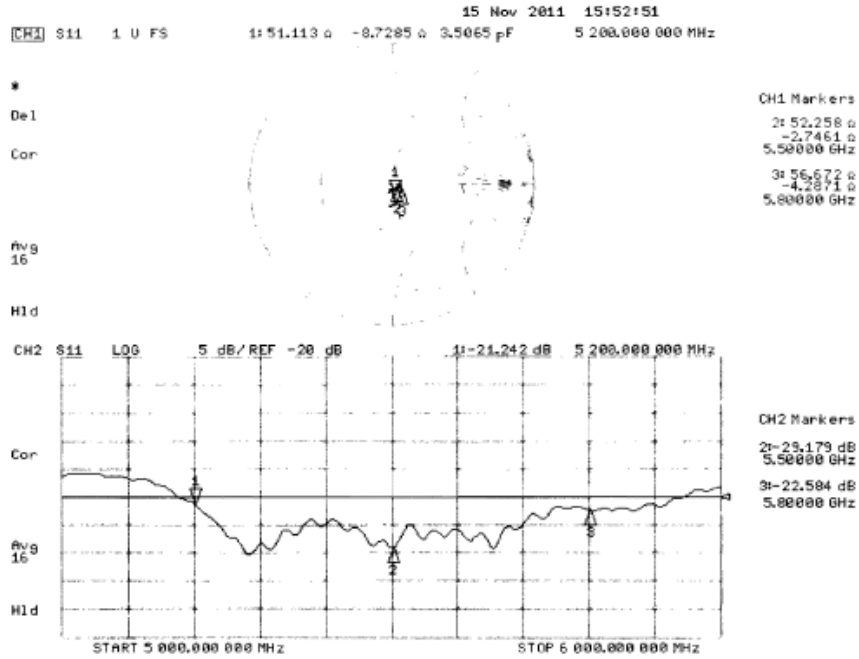

	Document Appendix D for the BlackBerry® Smartphone Model RGB141LW SAR Report Rev 4			Page 50(69)
Author Data Andrew Becker	Dates of Test June 11 – August 16, 2013 March 24-26, 2014 December 8 – 12, 2014	Test Report No RTS-6046-1308-39 Rev 6	FCC ID: L6ARGB140LW	IC

	Document	Appendix D for the BlackBerry® Smartphone Model RGB141LW SAR Report Rev 4		Page	51(69)
	Author Data	Dates of Test	Test Report No	FCC ID:	IC
Andrew Becker	June 11 – August 16, 2013 March 24-26, 2014 December 8 – 12, 2014	RTS-6046-1308-39 Rev 6	L6ARGB140LW		

Probe 3592

**Calibration Laboratory of
Schmid & Partner
Engineering AG**
Zeughausstrasse 43, 8004 Zurich, Switzerland



SCS Schweizerischer Kalibrierdienst
Service suisse d'étalonnage
Servizio svizzero di taratura
Swiss Calibration Service

Accredited by the Swiss Accreditation Service (SAS)
The Swiss Accreditation Service is one of the signatories to the EA
Multilateral Agreement for the recognition of calibration certificates

Accreditation No.: SCS 108

Client **Blackberry Waterloo**

Certificate No: **EX3-3592_Nov14**

CALIBRATION CERTIFICATE

Object: **EX3DV4 - SN:3592**

Calibration procedure(s): **QA CAL-01.v9, QA CAL-14.v4, QA CAL-23.v5, QA CAL-25.v6**
Calibration procedure for dosimetric E-field probes

Calibration date: **November 10, 2014**

This calibration certificate documents the traceability to national standards, which realize the physical units of measurements (SI).
The measurements and the uncertainties with confidence probability are given on the following pages and are part of the certificate.

All calibrations have been conducted in the closed laboratory facility: environment temperature (22 ± 3)°C and humidity < 70%.

Calibration Equipment used (M&T critical for calibration)

Primary Standards	ID	Cal Date (Certificate No.)	Scheduled Calibration
Power meter E4419B	GB41293874	03-Apr-14 (No. 217-01911)	Apr-15
Power sensor E4412A	MY41498087	03-Apr-14 (No. 217-01911)	Apr-15
Reference 3 dB Attenuator	SN: S5054 (3c)	03-Apr-14 (No. 217-01915)	Apr-15
Reference 20 dB Attenuator	SN: S5277 (20x)	03-Apr-14 (No. 217-01919)	Apr-15
Reference 30 dB Attenuator	SN: S5129 (30b)	03-Apr-14 (No. 217-01920)	Apr-15
Reference Probe ES3DV2	SN: 3013	30-Dec-13 (No. ES3-3013_Dec13)	Dec-14
DAE4	SN: 680	13-Dec-13 (No. DAE4-660_Dec13)	Dec-14
Secondary Standards	ID	Check Date (in house)	Scheduled Check
RF generator HP 8648C	US3642U01700	4-Aug-09 (in house check Apr-13)	In house check: Apr-16
Network Analyzer HP 8753F	US37390585	18-Oct-01 (in house check Oct-14)	In house check: Oct-15

Calibrated by:	Name Leif Klysner	Function Laboratory Technician	Signature
Approved by:	Name Katja Pokovic	Function Technical Manager	Signature

Issued: November 10, 2014

This calibration certificate shall not be reproduced except in full without written approval of the laboratory.

Certificate No: EX3-3592_Nov14

Page 1 of 11

	Document Appendix D for the BlackBerry® Smartphone Model RGB141LW SAR Report Rev 4		Page 52(69)
	Author Data Andrew Becker	Dates of Test June 11 – August 16, 2013 March 24-26, 2014 December 8 – 12, 2014	Test Report No RTS-6046-1308-39 Rev 6
		FCC ID: L6ARGB140LW	IC

**Calibration Laboratory of
Schmid & Partner
Engineering AG**
Zoughausstrasse 43, 8004 Zurich, Switzerland



SCS Schweizerischer Kalibrierdienst
Service suisse d'étalonnage
Servizio svizzero di taratura
Swiss Calibration Service

Accredited by the Swiss Accreditation Service (SAS)
The Swiss Accreditation Service is one of the signatories to the EA
Multilateral Agreement for the recognition of calibration certificates

Accreditation No.: **SCS 108**

Glossary:

TSL	tissue simulating liquid
NORM _{x,y,z}	sensitivity in free space
ConvF	sensitivity in TSL / NORM _{x,y,z}
DCP	diode compression point
CF	crest factor (1/duty_cycle) of the RF signal
A, B, C, D	modulation dependent linearization parameters
Polarization φ	φ rotation around probe axis
Polarization θ	θ rotation around an axis that is in the plane normal to probe axis (at measurement center), i.e., θ = 0 is normal to probe axis
Connector Angle	information used in DASY system to align probe sensor X to the robot coordinate system

Calibration is Performed According to the Following Standards:

- IEEE Std 1528-2013, "IEEE Recommended Practice for Determining the Peak Spatial-Averaged Specific Absorption Rate (SAR) in the Human Head from Wireless Communications Devices: Measurement Techniques", June 2013
- IEC 62209-1, "Procedure to measure the Specific Absorption Rate (SAR) for hand-held devices used in close proximity to the ear (frequency range of 300 MHz to 3 GHz)", February 2005

Methods Applied and Interpretation of Parameters:

- NORM_{x,y,z}:** Assessed for E-field polarization θ = 0 (f ≤ 900 MHz in TEM-cell; f > 1800 MHz: R22 waveguide). NORM_{x,y,z} are only intermediate values, i.e., the uncertainties of NORM_{x,y,z} does not affect the E²-field uncertainty inside TSL (see below ConvF).
- NORM(f)_{x,y,z} = NORM_{x,y,z} * frequency response** (see Frequency Response Chart). This linearization is implemented in DASY4 software versions later than 4.2. The uncertainty of the frequency response is included in the stated uncertainty of ConvF.
- DCP_{x,y,z}:** DCP are numerical linearization parameters assessed based on the data of power sweep with CW signal (no uncertainty required). DCP does not depend on frequency nor media.
- PAR:** PAR is the Peak to Average Ratio that is not calibrated but determined based on the signal characteristics
- A_{x,y,z}; B_{x,y,z}; C_{x,y,z}; D_{x,y,z}; VR_{x,y,z}:** A, B, C, D are numerical linearization parameters assessed based on the data of power sweep for specific modulation signal. The parameters do not depend on frequency nor media. VR is the maximum calibration range expressed in RMS voltage across the diode.
- ConvF and Boundary Effect Parameters:** Assessed in flat phantom using E-field (or Temperature Transfer Standard for f < 800 MHz) and inside waveguide using analytical field distributions based on power measurements for f > 800 MHz. The same setups are used for assessment of the parameters applied for boundary compensation (alpha, depth) of which typical uncertainty values are given. These parameters are used in DASY4 software to improve probe accuracy close to the boundary. The sensitivity in TSL corresponds to NORM_{x,y,z} * ConvF whereby the uncertainty corresponds to that given for ConvF. A frequency dependent ConvF is used in DASY version 4.4 and higher which allows extending the validity from ± 50 MHz to ± 100 MHz.
- Spherical Isotropy (3D deviation from isotropy):** in a field of low gradients realized using a flat phantom exposed by a patch antenna
- Sensor Offset:** The sensor offset corresponds to the offset of virtual measurement center from the probe tip (on probe axis). No tolerance required.
- Connector Angle:** The angle is assessed using the information gained by determining the NORM_x (no uncertainty required).

	Document Appendix D for the BlackBerry® Smartphone Model RGB141LW SAR Report Rev 4			Page 53(69)
Author Data Andrew Becker	Dates of Test June 11 – August 16, 2013 March 24-26, 2014 December 8 – 12, 2014	Test Report No RTS-6046-1308-39 Rev 6	FCC ID: L6ARGB140LW	IC

EX3DV4 – SN:3592

November 10, 2014

Probe EX3DV4

SN:3592

Manufactured: September 18, 2006
 Calibrated: November 10, 2014

Calibrated for DASY/EASY Systems
 (Note: non-compatible with DASY2 system!)

	Document			Page
	Appendix D for the BlackBerry® Smartphone Model RGB141LW SAR Report Rev 4			54(69)
Author Data Andrew Becker	Dates of Test June 11 – August 16, 2013 March 24-26, 2014 December 8 – 12, 2014	Test Report No RTS-6046-1308-39 Rev 6	FCC ID: L6ARGB140LW	IC

EX3DV4- SN:3592

November 10, 2014

DASY/EASY - Parameters of Probe: EX3DV4 - SN:3592

Basic Calibration Parameters

	Sensor X	Sensor Y	Sensor Z	Unc (k=2)
Norm ($\mu\text{V}/(\text{V}/\text{m})^2$) ^A	0.48	0.47	0.40	± 10.1 %
DCP (mV) ^A	95.2	98.0	98.8	

Modulation Calibration Parameters

UID	Communication System Name		A dB	B dB $\sqrt{\mu\text{V}}$	C	D dB	VR mV	Unc ^E (k=2)
0	CW	X	0.0	0.0	1.0	0.00	145.9	±3.3 %
		Y	0.0	0.0	1.0		156.9	
		Z	0.0	0.0	1.0		149.1	

The reported uncertainty of measurement is stated as the standard uncertainty of measurement multiplied by the coverage factor k=2, which for a normal distribution corresponds to a coverage probability of approximately 95%.

^A The uncertainties of Norm X,Y,Z do not affect the E²-field uncertainty inside TSL (see Pages 5 and 6).

^B Numerical linearization parameter; uncertainty not required.

^E Uncertainty is determined using the max. deviation from linear response applying rectangular distribution and is expressed for the square of the field value.

	Document			Page
	Appendix D for the BlackBerry® Smartphone Model RGB141LW SAR Report Rev 4			55(69)
Author Data	Dates of Test	Test Report No	FCC ID:	IC
Andrew Becker	June 11 – August 16, 2013 March 24-26, 2014 December 8 – 12, 2014	RTS-6046-1308-39 Rev 6	L6ARGB140LW	

EX3DV4- SN:3592

November 10, 2014

DASY/EASY - Parameters of Probe: EX3DV4 - SN:3592

Calibration Parameter Determined in Head Tissue Simulating Media

f (MHz) ^C	Relative Permittivity ^F	Conductivity (S/m) ^F	ConvF X	ConvF Y	ConvF Z	Alpha ^G	Depth (mm) ^G	Unct. (k=2)
2600	39.0	1.96	6.80	6.80	6.80	0.36	0.93	± 12.0 %
5250	35.9	4.71	4.63	4.63	4.63	0.35	1.80	± 13.1 %
5600	35.5	6.07	4.20	4.20	4.20	0.40	1.80	± 13.1 %
5750	35.4	6.22	4.34	4.34	4.34	0.40	1.80	± 13.1 %

^C Frequency validity above 300 MHz of ± 100 MHz only applies for DASY v1.4 and higher (see Page 2), else it is restricted to ± 50 MHz. The uncertainty is the RSS of the ConvF uncertainty at calibration frequency and the uncertainty for the indicated frequency band. Frequency validity below 300 MHz is ± 10, 25, 40, 50 and 70 MHz for ConvF assessments at 30, 64, 128, 150 and 220 MHz respectively. Above 5 GHz frequency validity can be extended to ± 110 MHz.

^F At frequencies below 3 GHz, the validity of tissue parameters (ϵ and σ) can be relaxed to + 10% if liquid compensation formula is applied to measured SAR values. At frequencies above 3 GHz, the validity of tissue parameters (ϵ and σ) is restricted to ± 5%. The uncertainty is the RSS of the ConvF uncertainty for indicated target tissue parameters.

^G Alpha/Depth are determined during calibration. SPFAC warrants that the remaining deviation due to the boundary effect after compensation is always less than ± 1% for frequencies below 3 GHz and below ± 2% for frequencies between 3-6 GHz at any distance larger than half the probe tip diameter from the boundary.

	Document			Page
	Appendix D for the BlackBerry® Smartphone Model RGB141LW SAR Report Rev 4			56(69)
Author Data	Dates of Test	Test Report No	FCC ID:	IC
Andrew Becker	June 11 – August 16, 2013 March 24-26, 2014 December 8 – 12, 2014	RTS-6046-1308-39 Rev 6	L6ARGB140LW	

EX3DV4– SN:3592

November 10, 2014

DASY/EASY - Parameters of Probe: EX3DV4 - SN:3592

Calibration Parameter Determined in Body Tissue Simulating Media

f (MHz) ^C	Relative Permittivity ^F	Conductivity (S/m) ^F	ConvF X	ConvF Y	ConvF Z	Alpha ^G	Depth (mm) ^G	Unct. (k=2)
2600	52.5	2.16	6.84	6.84	6.84	0.78	0.62	± 12.0 %
5250	48.9	5.36	4.06	4.06	4.06	0.45	1.90	± 13.1 %
5600	48.5	5.77	3.78	3.78	3.78	0.45	1.90	± 13.1 %
5750	48.3	5.94	3.81	3.81	3.81	0.50	1.90	± 13.1 %

^C Frequency validity above 300 MHz of ± 10% MHz only applies for DASY v4.4 and higher (see Page 2), else it is restricted to ± 50 MHz. The uncertainty is the RSS of the ConvF uncertainty at calibration frequency and the uncertainty for the indicated frequency band. Frequency validity below 300 MHz is ± 10, 25, 40, 50 and 70 MHz for ConvF assessments at 30, 64, 128, 150 and 220 MHz respectively. Above 5 GHz frequency validity can be extended to ± 110 MHz.

^F At frequencies below 3 GHz, the validity of tissue parameters (ϵ and σ) can be relaxed to ± 10% if liquid compensation formula is applied to measured SAR values. At frequencies above 3 GHz, the validity of tissue parameters (ϵ and σ) is restricted to ± 5%. The uncertainty is the RSS of the ConvF uncertainty for indicated target tissue parameters.

^G Alpha/Depth are determined during calibration. SPEAG warrants that the remaining deviation due to the boundary effect after compensation is always less than ± 1% for frequencies below 3 GHz and below ± 2% for frequencies between 3-6 GHz at any distance larger than half the probe tip diameter from the boundary.

	Document Appendix D for the BlackBerry® Smartphone Model RGB141LW SAR Report Rev 4		Page 57(69)
	Author Data Andrew Becker	Dates of Test June 11 – August 16, 2013 March 24-26, 2014 December 8 – 12, 2014	Test Report No RTS-6046-1308-39 Rev 6

EX3DV4- SN:3592

November 10, 2014

Frequency Response of E-Field (TEM-Cell:ifi110 EXX, Waveguide: R22)

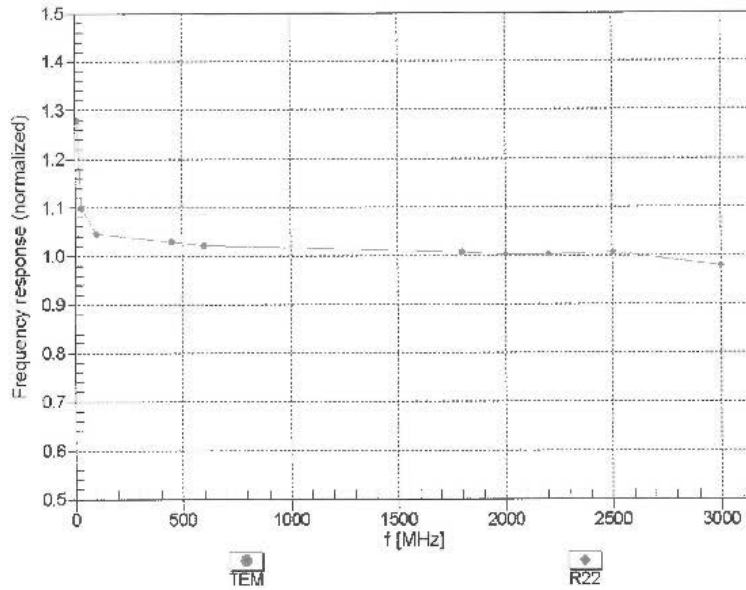

Uncertainty of Frequency Response of E-field: $\pm 6.3\%$ (k=2)

	Document Appendix D for the BlackBerry® Smartphone Model RGB141LW SAR Report Rev 4		Page 58(69)
Author Data Andrew Becker	Dates of Test June 11 – August 16, 2013 March 24-26, 2014 December 8 – 12, 2014	Test Report No RTS-6046-1308-39 Rev 6	FCC ID: L6ARGB140LW

EX3DV4- SN:3592

November 10, 2014

Receiving Pattern (ϕ), $\theta = 0^\circ$

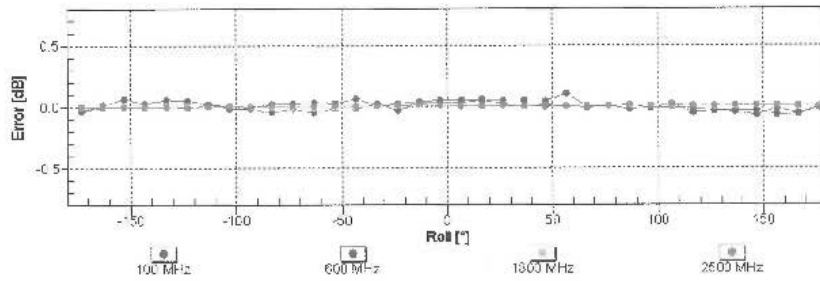
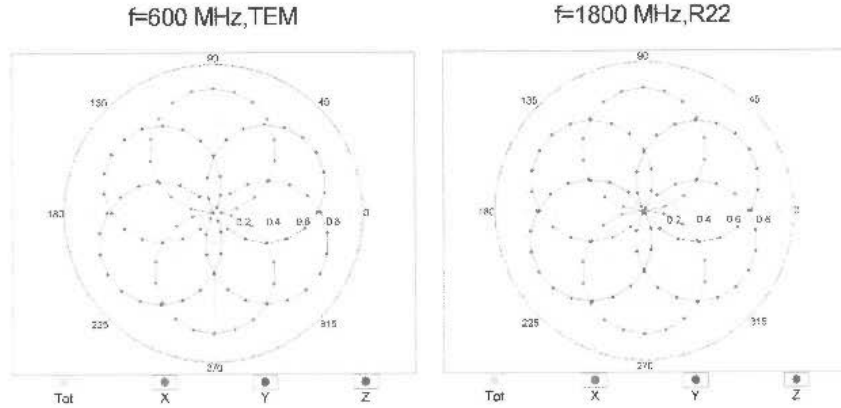

Uncertainty of Axial Isotropy Assessment: $\pm 0.5\%$ (k=2)

	Document Appendix D for the BlackBerry® Smartphone Model RGB141LW SAR Report Rev 4	Page 59(69)
Author Data Andrew Becker	Dates of Test June 11 – August 16, 2013 March 24-26, 2014 December 8 – 12, 2014	Test Report No RTS-6046-1308-39 Rev 6
FCC ID: L6ARGB140LW		IC

EX3DV4-SN:3592

November 10, 2014

Dynamic Range $f(SAR_{head})$
(TEM cell, $f_{eval} = 1900$ MHz)

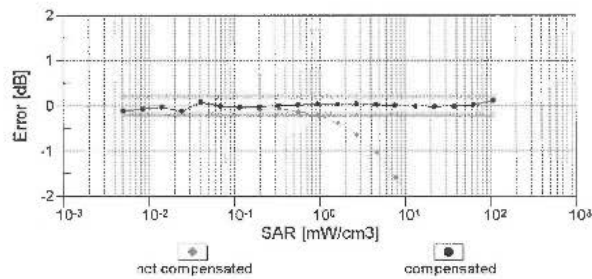
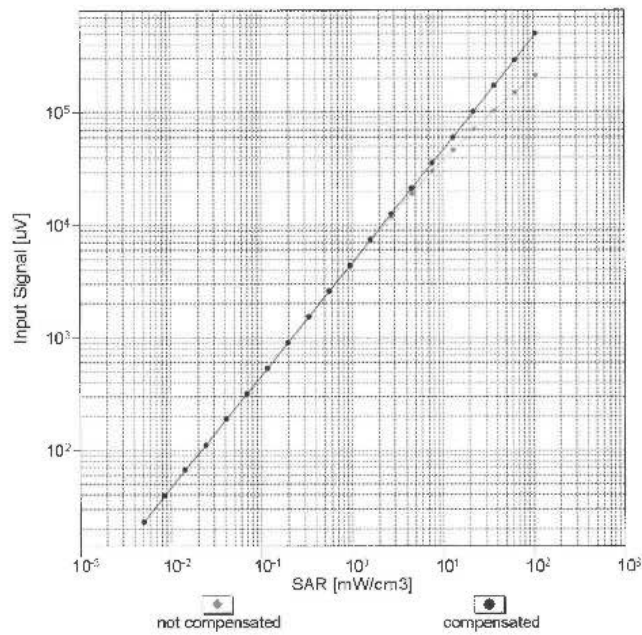

Uncertainty of Linearity Assessment: $\pm 0.6\%$ (k=2)

	Document Appendix D for the BlackBerry® Smartphone Model RGB141LW SAR Report Rev 4		Page 60(69)
	Author Data Andrew Becker	Dates of Test June 11 – August 16, 2013 March 24-26, 2014 December 8 – 12, 2014	Test Report No RTS-6046-1308-39 Rev 6

EX3DV4– SN:3592

November 10, 2014

Conversion Factor Assessment

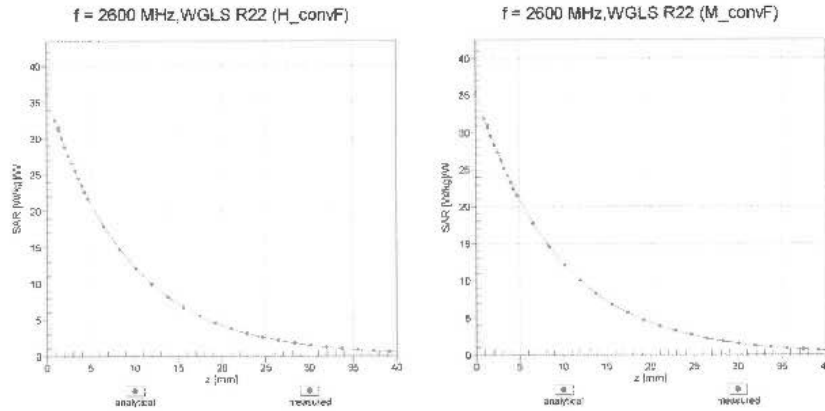

Deviation from Isotropy in Liquid Error (ϕ , θ), $f = 900$ MHz

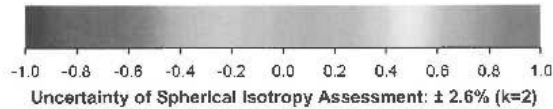
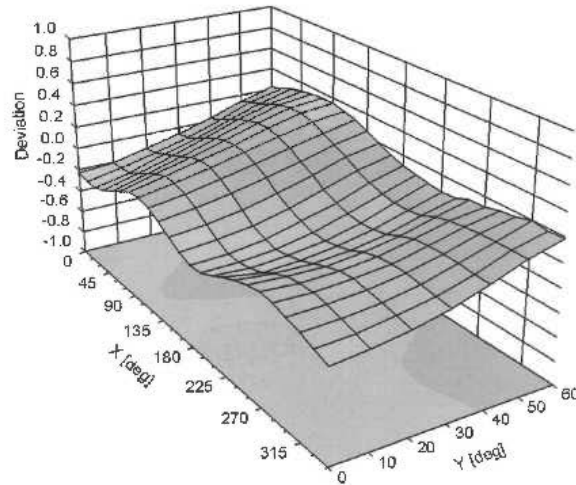

	Document			Page
	Appendix D for the BlackBerry® Smartphone Model RGB141LW SAR Report Rev 4			61(69)
Author Data	Dates of Test	Test Report No	FCC ID:	IC
Andrew Becker	June 11 – August 16, 2013 March 24-26, 2014 December 8 – 12, 2014	RTS-6046-1308-39 Rev 6	L6ARGB140LW	

EX3DV4- SN:3592

November 10, 2014

DASY/EASY - Parameters of Probe: EX3DV4 - SN:3592

Other Probe Parameters

Sensor Arrangement	Triangular
Connector Angle (°)	-13.3
Mechanical Surface Detection Mode	enabled
Optical Surface Detection Mode	disabled
Probe Overall Length	337 mm
Probe Body Diameter	10 mm
Tip Length	9 mm
Tip Diameter	2.5 mm
Probe Tip to Sensor X Calibration Point	1 mm
Probe Tip to Sensor Y Calibration Point	1 mm
Probe Tip to Sensor Z Calibration Point	1 mm
Recommended Measurement Distance from Surface	1.4 mm

	Document Appendix D for the BlackBerry® Smartphone Model RGB141LW SAR Report Rev 4		Page 62(69)
	Author Data Andrew Becker	Dates of Test June 11 – August 16, 2013 March 24-26, 2014 December 8 – 12, 2014	Test Report No RTS-6046-1308-39 Rev 6
		FCC ID: L6ARGB140LW	IC

5000 Dipole

**Calibration Laboratory of
Schmid & Partner
Engineering AG**
Zeughausstrasse 43, 8004 Zurich, Switzerland



S Schweizerischer Kallbrierdienst
S Service suisse d'étalonnage
S Servizio svizzero di taratura
S Swiss Calibration Service

Accredited by the Swiss Accreditation Service (SAS)
The Swiss Accreditation Service is one of the signatories to the EA
Multilateral Agreement for the recognition of calibration certificates

Accreditation No.: **SCS 108**

Client **Blackberry Waterloo**

Certificate No: **D5GHzV2-1033_Nov13**

CALIBRATION CERTIFICATE			
Object	D5GHzV2 - SN: 1033		
Calibration procedure(s)	QA CAL-22.v2 Calibration procedure for dipole validation kits between 3-6 GHz		
Calibration date:	November 08, 2013		
<p>This calibration certificate documents the traceability to national standards, which realize the physical units of measurements (SI). The measurements and the uncertainties with confidence probability are given on the following pages and are part of the certificate.</p> <p>All calibrations have been conducted in the closed laboratory facility: environment temperature (22 ± 3)°C and humidity < 70%.</p> <p>Calibration Equipment used (M&TE critical for calibration)</p>			
Primary Standards	ID #	Cal Date (Certificate No.)	Scheduled Calibration
Power meter EPM-442A	GB37480704	09-Oct-13 (No. 217-01827)	Oct-14
Power sensor HP 8481A	US37292783	09-Oct-13 (No. 217-01827)	Oct-14
Power sensor HP 8481A	MY41092317	09-Oct-13 (No. 217-01828)	Oct-14
Reference 20 dB Attenuator	SN: 5058 (20k)	04-Apr-13 (No. 217-01736)	Apr-14
Type-N mismatch combination	SN: 5047.3 / 06327	04-Apr-13 (No. 217-01739)	Apr-14
Reference Probe ES3DV3	SN: 3205	28-Dec-12 (No. ES3-3205_Dec12)	Dec-13
DAE4	SN: 601	25-Apr-13 (No. DAE4-601_Apr13)	Apr-14
Secondary Standards	ID #	Check Date (in house)	Scheduled Check
RF generator R&S SMT-06	100005	04-Aug-99 (in house check Oct-13)	In house check; Oct-15
Network Analyzer HP 8753E	US37390585 S4206	18-Oct-01 (in house check Oct-13)	In house check; Oct-14
Calibrated by:	Name Claudio Leubler	Function Laboratory Technician	Signature
Approved by:	Name Katja Pokovic	Function Technical Manager	Signature
			Issued: November 8, 2013
This calibration certificate shall not be reproduced except in full without written approval of the laboratory.			

Certificate No: D5GHzV2-1033_Nov13

Page 1 of 8

	Document Appendix D for the BlackBerry® Smartphone Model RGB141LW SAR Report Rev 4		Page 63(69)
	Author Data Andrew Becker	Dates of Test June 11 – August 16, 2013 March 24-26, 2014 December 8 – 12, 2014	Test Report No RTS-6046-1308-39 Rev 6
		FCC ID: L6ARGB140LW	IC

**Calibration Laboratory of
Schmid & Partner
Engineering AG**
Zeughausstrasse 43, 8004 Zurich, Switzerland



S Schweizerischer Kalibrierdienst
C Service suisse d'étalonnage
S Servizio svizzero di taratura
S Swiss Calibration Service

Accredited by the Swiss Accreditation Service (SAS)
The Swiss Accreditation Service is one of the signatories to the EA
Multilateral Agreement for the recognition of calibration certificates

Accreditation No.: **SCS 108**

Glossary:

TSL tissue simulating liquid
ConvF sensitivity in TSL / NORM x,y,z
N/A not applicable or not measured

Calibration is Performed According to the Following Standards:

- IEC 62209-2, "Evaluation of Human Exposure to Radio Frequency Fields from Handheld and Body-Mounted Wireless Communication Devices in the Frequency Range of 30 MHz to 6 GHz: Human models, Instrumentation, and Procedures"; Part 2: "Procedure to determine the Specific Absorption Rate (SAR) for including accessories and multiple transmitters", March 2010
- KDB 865664, "SAR Measurement Requirements for 100 MHz to 6 GHz"
- IEEE Std 1528-2013, "IEEE Recommended Practice for Determining the Peak Spatial-Averaged Specific Absorption Rate (SAR) in the Human Head from Wireless Communications Devices: Measurement Techniques", June 2013

Additional Documentation:

- DASY4/5 System Handbook

Methods Applied and Interpretation of Parameters:

- Measurement Conditions:** Further details are available from the Validation Report at the end of the certificate. All figures stated in the certificate are valid at the frequency indicated.
- Antenna Parameters with TSL:** The dipole is mounted with the spacer to position its feed point exactly below the center marking of the flat phantom section, with the arms oriented parallel to the body axis.
- Feed Point Impedance and Return Loss:** These parameters are measured with the dipole positioned under the liquid filled phantom. The impedance stated is transformed from the measurement at the SMA connector to the feed point. The Return Loss ensures low reflected power. No uncertainty required.
- Electrical Delay:** One-way delay between the SMA connector and the antenna feed point. No uncertainty required.
- SAR measured:** SAR measured at the stated antenna input power.
- SAR normalized:** SAR as measured, normalized to an input power of 1 W at the antenna connector.
- SAR for nominal TSL parameters:** The measured TSL parameters are used to calculate the nominal SAR result.

The reported uncertainty of measurement is stated as the standard uncertainty of measurement multiplied by the coverage factor k=2, which for a normal distribution corresponds to a coverage probability of approximately 95%.

	Document Appendix D for the BlackBerry® Smartphone Model RGB141LW SAR Report Rev 4		Page 64(69)
	Author Data Andrew Becker	Dates of Test June 11 – August 16, 2013 March 24-26, 2014 December 8 – 12, 2014	Test Report No RTS-6046-1308-39 Rev 6
		FCC ID: L6ARGB140LW	IC

Measurement Conditions

DASY system configuration, as far as not given on page 1.

DASY Version	DASY5	V52.8.7
Extrapolation	Advanced Extrapolation	
Phantom	Modular Flat Phantom V5.0	
Distance Dipole Center - TSL	10 mm	with Spacer
Zoom Scan Resolution	dx, dy = 4.0 mm, dz = 1.4 mm	Graded Ratio = 1.4 (Z direction)
Frequency	5200 MHz ± 1 MHz 5500 MHz ± 1 MHz 5800 MHz ± 1 MHz	

Head TSL parameters at 5200 MHz

The following parameters and calculations were applied.

	Temperature	Permittivity	Conductivity
Nominal Head TSL parameters	22.0 °C	36.0	4.66 mho/m
Measured Head TSL parameters	(22.0 ± 0.2) °C	35.0 ± 6 %	4.46 mho/m ± 6 %
Head TSL temperature change during test	< 0.5 °C	---	---

SAR result with Head TSL at 5200 MHz

SAR averaged over 1 cm ³ (1 g) of Head TSL	Condition	
SAR measured	100 mW input power	7.99 W/kg
SAR for nominal Head TSL parameters	normalized to 1W	79.4 W/kg ± 19.9 % (k=2)

SAR averaged over 10 cm ³ (10 g) of Head TSL	condition	
SAR measured	100 mW input power	2.28 W/kg
SAR for nominal Head TSL parameters	normalized to 1W	22.6 W/kg ± 19.5 % (k=2)

Head TSL parameters at 5500 MHz

The following parameters and calculations were applied.

	Temperature	Permittivity	Conductivity
Nominal Head TSL parameters	22.0 °C	35.6	4.96 mho/m
Measured Head TSL parameters	(22.0 ± 0.2) °C	34.6 ± 6 %	4.75 mho/m ± 6 %
Head TSL temperature change during test	< 0.5 °C	---	---

SAR result with Head TSL at 5500 MHz

SAR averaged over 1 cm ³ (1 g) of Head TSL	Condition	
SAR measured	100 mW input power	8.51 W/kg
SAR for nominal Head TSL parameters	normalized to 1W	84.4 W / kg ± 19.9 % (k=2)

SAR averaged over 10 cm ³ (10 g) of Head TSL	condition	
SAR measured	100 mW input power	2.41 W/kg
SAR for nominal Head TSL parameters	normalized to 1W	23.9 W/kg ± 19.5 % (k=2)

	Document		Page
	Appendix D for the BlackBerry® Smartphone Model RGB141LW SAR Report Rev 4		65(69)
Author Data Andrew Becker	Dates of Test June 11 – August 16, 2013 March 24-26, 2014 December 8 – 12, 2014	Test Report No RTS-6046-1308-39 Rev 6	FCC ID: L6ARGB140LW

Head TSL parameters at 5800 MHz

The following parameters and calculations were applied.

	Temperature	Permittivity	Conductivity
Nominal Head TSL parameters	22.0 °C	35.3	5.27 mho/m
Measured Head TSL parameters	(22.0 ± 0.2) °C	34.2 ± 6 %	5.06 mho/m ± 6 %
Head TSL temperature change during test	< 0.5 °C	---	---

SAR result with Head TSL at 5800 MHz

SAR averaged over 1 cm ³ (1 g) of Head TSL	Condition	
SAR measured	100 mW input power	8.01 W/kg
SAR for nominal Head TSL parameters	normalized to 1W	79.4 W/kg ± 19.9 % (k=2)

SAR averaged over 10 cm ³ (10 g) of Head TSL	condition	
SAR measured	100 mW input power	2.28 W/kg
SAR for nominal Head TSL parameters	normalized to 1W	22.6 W/kg ± 19.5 % (k=2)

	Document		Page
	Appendix D for the BlackBerry® Smartphone Model RGB141LW SAR Report Rev 4		66(69)
Author Data	Dates of Test	Test Report No	FCC ID:
Andrew Becker	June 11 – August 16, 2013 March 24-26, 2014 December 8 – 12, 2014	RTS-6046-1308-39 Rev 6	L6ARGB140LW
			IC

Appendix

Antenna Parameters with Head TSL at 5200 MHz

Impedance, transformed to feed point	49.1 Ω - 9.6 $j\Omega$
Return Loss	- 20.3 dB

Antenna Parameters with Head TSL at 5500 MHz

Impedance, transformed to feed point	50.3 Ω - 4.1 $j\Omega$
Return Loss	- 27.7 dB

Antenna Parameters with Head TSL at 5800 MHz

Impedance, transformed to feed point	57.8 Ω - 4.0 $j\Omega$
Return Loss	- 21.8 dB

General Antenna Parameters and Design

Electrical Delay (one direction)	1.213 ns
----------------------------------	----------

After long term use with 100W radiated power, only a slight warming of the dipole near the feedpoint can be measured.

The dipole is made of standard semirigid coaxial cable. The center conductor of the feeding line is directly connected to the second arm of the dipole. The antenna is therefore short-circuited for DC-signals. On some of the dipoles, small end caps are added to the dipole arms in order to improve matching when loaded according to the position as explained in the "Measurement Conditions" paragraph. The SAR data are not affected by this change. The overall dipole length is still according to the Standard.

No excessive force must be applied to the dipole arms, because they might bend or the soldered connections near the feedpoint may be damaged.

Additional EUT Data

Manufactured by	SPEAG
Manufactured on	July 09, 2004

	Document Appendix D for the BlackBerry® Smartphone Model RGB141LW SAR Report Rev 4		Page 67(69)
	Author Data Andrew Becker	Dates of Test June 11 – August 16, 2013 March 24-26, 2014 December 8 – 12, 2014	Test Report No RTS-6046-1308-39 Rev 6
		FCC ID: L6ARGB140LW	IC

DASY5 Validation Report for Head TSL

Date: 08.11.2013

Test Laboratory: SPEAG, Zurich, Switzerland

DUT: Dipole 5GHz; Type: D5GHzV2; Serial: D5GHzV2 - SN: 1033

Communication System: UID 0 - CW ; Frequency: 5200 MHz, Frequency: 5500 MHz, Frequency: 5800 MHz

Medium parameters used: $f = 5200$ MHz; $\sigma = 4.46$ S/m; $\epsilon_r = 35$; $\rho = 1000$ kg/m³,

Medium parameters used: $f = 5500$ MHz; $\sigma = 4.75$ S/m; $\epsilon_r = 34.6$; $\rho = 1000$ kg/m³,

Medium parameters used: $f = 5800$ MHz; $\sigma = 5.06$ S/m; $\epsilon_r = 34.2$; $\rho = 1000$ kg/m³

Phantom section: Flat Section

Measurement Standard: DASY5 (IEEE/IEC/ANSI C63.19-2007)

DASY52 Configuration:

- Probe: EX3DV4 - SN3503; ConvF(5.41, 5.41, 5.41); Calibrated: 28.12.2012, ConvF(4.91, 4.91, 4.91); Calibrated: 28.12.2012, ConvF(4.81, 4.81, 4.81); Calibrated: 28.12.2012;
- Sensor-Surface: 1.4mm (Mechanical Surface Detection)
- Electronics: DAE4 Sn601; Calibrated: 25.04.2013
- Phantom: Flat Phantom 5.0 (front); Type: QD000P50AA; Serial: 1001
- DASY52 52.8.7(1137); SEMCAD X 14.6.10(7164)

Dipole Calibration for Head Tissue/Pin=100mW, dist=10mm, f=5200 MHz/Zoom Scan, dist=1.4mm (8x8x7)/Cube 0: Measurement grid: dx=4mm, dy=4mm, dz=1.4mm
Reference Value = 64.635 V/m; Power Drift = -0.04 dB
Peak SAR (extrapolated) = 29.5 W/kg
SAR(1 g) = 7.99 W/kg; SAR(10 g) = 2.28 W/kg
Maximum value of SAR (measured) = 18.4 W/kg

Dipole Calibration for Head Tissue/Pin=100mW, dist=10mm, f=5500 MHz/Zoom Scan, dist=1.4mm (8x8x7)/Cube 0: Measurement grid: dx=4mm, dy=4mm, dz=1.4mm
Reference Value = 64.397 V/m; Power Drift = 0.02 dB
Peak SAR (extrapolated) = 33.8 W/kg
SAR(1 g) = 8.51 W/kg; SAR(10 g) = 2.41 W/kg
Maximum value of SAR (measured) = 20.3 W/kg

Dipole Calibration for Head Tissue/Pin=100mW, dist=10mm, f=5800 MHz/Zoom Scan, dist=1.4mm (8x8x7)/Cube 0: Measurement grid: dx=4mm, dy=4mm, dz=1.4mm
Reference Value = 61.128 V/m; Power Drift = 0.08 dB
Peak SAR (extrapolated) = 33.0 W/kg
SAR(1 g) = 8.01 W/kg; SAR(10 g) = 2.28 W/kg
Maximum value of SAR (measured) = 19.2 W/kg

	Document Appendix D for the BlackBerry® Smartphone Model RGB141LW SAR Report Rev 4			Page 68(69)
Author Data Andrew Becker	Dates of Test June 11 – August 16, 2013 March 24-26, 2014 December 8 – 12, 2014	Test Report No RTS-6046-1308-39 Rev 6	FCC ID: L6ARGB140LW	IC

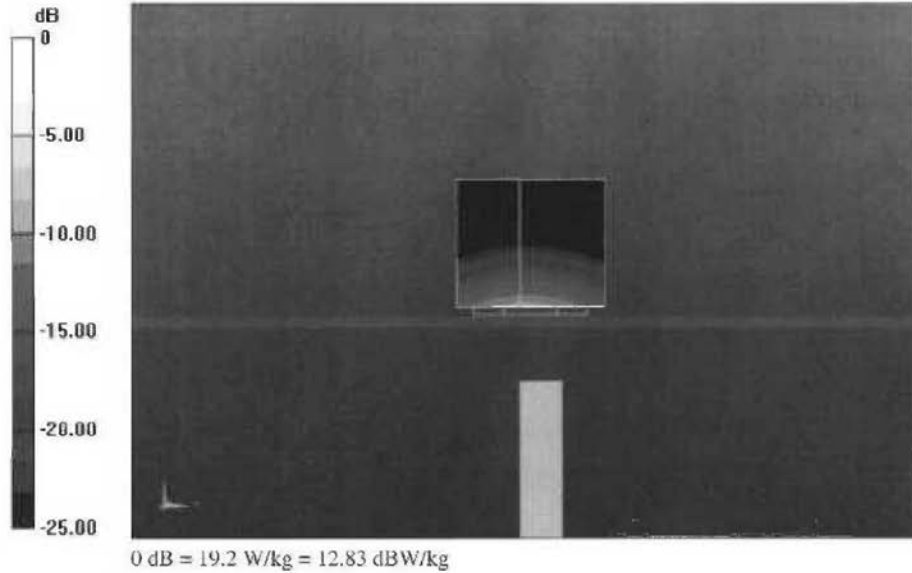

	Document Appendix D for the BlackBerry® Smartphone Model RGB141LW SAR Report Rev 4	Page 69(69)
Author Data Andrew Becker	Dates of Test June 11 – August 16, 2013 March 24-26, 2014 December 8 – 12, 2014	Test Report No RTS-6046-1308-39 Rev 6
FCC ID: L6ARGB140LW		IC

Impedance Measurement Plot for Head TSL

