	Document Hearing Aid Compatibility Audio Band Magnetic (ABM) T-Coil Test Report for BlackBerry® Smartphone model RFV121LW Rev 2		Page 1(25)
	Author Data Daoud Attayi	Dates of Test May 31-June 06, 2013	Report No RTS-6046-1310-33 Rev 2

Hearing Aid Compatibility Audio Band Magnetic (ABM) T-Coil Test Report

Testing Lab: BlackBerry RTS 440 Phillip Street Waterloo, Ontario Canada N2L 5R9 Phone: 519-888-7465 Fax: 519-746-0189	Applicant: BlackBerry Limited 295 Phillip Street Waterloo, Ontario Canada N2L 3W8 Phone: 519-888-7465 Fax: 519-888-6906 Web site: www.blackberry.com
---------------------------------------------------------------------------------------------------------------------------------------------	-------------------------------------------------------------------------------------------------------------------------------------------------------------------------------

Statement of Compliance: BlackBerry RTS declares that the product was tested in accordance with the appropriate measurement standards, guidelines and recommended practices.

This Blackberry® Smartphone is a wireless portable device and has been shown to be in compliance with FCC 20.19 (10-1-07 Edition), Hearing Aid-Compatible Mobile Handset, FCC Report and FCC Report and Order, DA 12-550, April 2012 and FCC Guidance KDB 285076 D01, V03r01, April 2013 and has been tested as per ANSI C63.19-2011.

Andrew Becker
SAR & HAC Compliance Specialist
(Verification of the Test Report)

Daoud Attayi
Compliance Manager (SAR/HAC)
(Author of the Test report)

Masud S. Attayi
Manager, Regulatory Compliance

**RTS is accredited
according to
EN ISO/IEC 17025 by:**



592

Report re-issue date: December 02, 2013

	Document Hearing Aid Compatibility Audio Band Magnetic (ABM) T-Coil Test Report for BlackBerry® Smartphone model RFV121LW Rev 2		Page 2(25)
	Author Data Daoud Attayi	Dates of Test May 31-June 06, 2013	Report No RTS-6046-1310-33 Rev 2

Revision History:

Changes in RTS-6046-1310-33 Rev 2, revised December 02, 2013

Not tested in accordance with the guidance issued by OET in KDB publication 285076 D02 T-Coil testing for CMRS IP.

Currently there is no equipment defined and available to test HAC T-coil on WiFi VoIP applications and we request for exclusion.

	Document		Page
	Hearing Aid Compatibility Audio Band Magnetic (ABM) T-Coil Test Report for BlackBerry® Smartphone model RFV121LW Rev 2		3(25)
Author Data	Dates of Test	Report No	FCC ID
Daoud Attayi	May 31-June 06, 2013	RTS-6046-1310-33 Rev 2	L6ARFV120LW

CONTENTS

1.0 Introduction 4

2.0 Applicable references 5

3.0 Equipment unit tested 6

 3.1 Picture of device 6

 3.2 Device description 6

 3.3 Antenna description 8

 3.4 Battery 8

4.0 List of test equipment 8

5.0 DASY5 HAC T-Coil measurement system and setup 9

 5.1 Audio signals 9

 5.2 Input level measurement 9

 5.3 Bandwidth compensation 9

 5.4 Phantom 10

 5.5 AMCC 10

 5.6 AM1D probe 11

 5.7 AMMI 13

 5.8 Cabling 13

6.0 Measurement procedures 14

 6.1 Surface check and probe sensitivity measurements 14

 6.2 Audio band magnetic ambient noise measurement 15

 6.3 Reference check/system validation using a TMFS 15

 6.4 ABM1 / ABM2 detailed math and probe factor 16

 6.5 Test measurement 17

7.0 Summary of test results 21

 7.1 Conclusion 22

8.0 Measurement uncertainty 23

 8.1 Site-Specific Uncertainty 24

Annex A: Probe sensitivity and reference signal measurement plots

Annex B: TMFS system validation and ambient data/plots

Annex C: Audio Band Magnetic measurement data and plots

Annex D: Probe/TMFS calibration certificate and equipment spec

Annex E: HAC T-Coil_Setup_Photos

	Document Hearing Aid Compatibility Audio Band Magnetic (ABM) T-Coil Test Report for BlackBerry® Smartphone model RFV121LW Rev 2		Page 4(25)
	Author Data Daoud Attayi	Dates of Test May 31-June 06, 2013	Report No RTS-6046-1310-33 Rev 2

1.0 Introduction

This test report demonstrates measurement of the Audio Band Magnetic fields (ABM) generated by a wireless communication device in the region where a hearing aid would be used in the T-Coil mode.

Three quantities are measured and evaluated. The first is the field intensity of the desired signal at the center of the audio band. The second is the frequency response of the desired signal measured across the audio band. The third is the signal quality, which is defined as the ratio between the desired and undesired magnetic field levels.

The SPEAG DASY5 T-Coil extension together with the HAC RF extension allows complete characterization of the emissions of a wireless device (WD). The signals measured during these tests represent the field picked up by the T-Coil of a hearing aid. Using DASY5, two orthogonal axes are scanned with a probe incorporating a sensor coil: one axial (perpendicular), and one radial (transverse) direction with respect to the plane and main axis of the WD.

The WD is mounted on the Test Arch phantom (provided with the HAC RF extension). Its acoustic center is centered and represents the reference for the combination of ABM and RF field evaluation. The ABM fields of the WD (frequency range <20 kHz) are scanned with a fully RF shielded active 1D magnetic probe. The probe axis is oriented in space diagonal to the two orthogonal axes, and its single sensor can be oriented to the axes by 120° rotation. The probe signal is evaluated by an Audio Magnetic Measurement Instrument (AMMI) which is interfaced to the DASY5 computer via USB. The AMMI also provides test and calibration signals and interfaces to the Helmholtz Audio Magnetic Calibration Coil (AMCC).

Predefined or user-definable audio signals for injection into the WD during the test are available at a connector of the AMMI. The DASY5 software allows flexible control of scan, rotation, measurement duration, as well as selection of the measurement mode and signal source for all ABM measurements. Filtering as specified by the standard is applied to the sampled signal resulting in the signal level, (weighted) noise level and a third-octave resolution spectrum for the frequency response. This information is represented numerically and graphically during the scans and graphically evaluated in the postprocessor. The combination of the quantities (signal level, frequency response, signal to noise ratio) leads to an overall classification according to ANSI-C63.19. Coarse, fine and point scan together with user selectable test signals, minimize the time to find the "optimal point" with the highest class for the WD.

For each probe orientation, the background noise is measured for each probe orientation without an active WD in the area of the WD scan and should be < 10 dB than the lowest ABM2 measurement, where applicable.

	Document Hearing Aid Compatibility Audio Band Magnetic (ABM) T-Coil Test Report for BlackBerry® Smartphone model RFV121LW Rev 2		Page 5(25)
	Author Data Daoud Attayi	Dates of Test May 31-June 06, 2013	Report No RTS-6046-1310-33 Rev 2

2.0 Applicable references

[1] ANSI C63.19-2011, American National Standard for Methods of Measurement of Compatibility between Wireless Communication Devices and Hearing Aids.

[2] FCC 47CFR § 20.19 (10-1-07 Edition), Hearing Aid-Compatible Mobile Handsets.

[3] SPEAG DASY52 user manual, March 2013.

[4] Equipment Authorization Guidance on Hearing Aid Compatibility, KDB 285076 D01 HAC Guidance v03 R01, April, 2013.

[5] FCC Report and Order, DA 12-550, April 2012.

	Document Hearing Aid Compatibility Audio Band Magnetic (ABM) T-Coil Test Report for BlackBerry® Smartphone model RFV121LW Rev 2		Page 6(25)
	Author Data Daoud Attayi	Dates of Test May 31-June 06, 2013	Report No RTS-6046-1310-33 Rev 2

3.0 Equipment unit tested

3.1 Picture of device

Please refer to Annex E.

Figure 3.1-1 BlackBerry smartphone

3.2 Device description

Device Model	RFV121LW			
FCC ID	L6ARFV120LW			
PIN	Radiated: 2FFFE967 (Rev2), 2FFFE9A7 (Rev2) Conducted: 2FFFE9B6 (Rev2)			
Hardware Rev	Rev2-x08-00/01			
Software Version	10.2.0.519/1512			
Prototype or Production Unit	Production			
Mode(s) of Operation	1-slot GSM 850 GSM 1900	2-slots EDGE/GPRS 850/1900	3-slots EDGE/GPRS 850/1900	4-slots EDGE/GPRS 850/1900
Nominal Maximum conducted RF Output Power (dBm)	32.5 30.0	30.0 27.5	28.5 25.5	27.0 24.0
Tolerance in Power Setting on centre channel (dB)	± 1.0	± 1.0	± 1.0	± 1.0
Duty Cycle	1:8	2:8	3:8	4:8
Transmitting Frequency Range (MHz)	824.2 – 848.8 1850.2 – 1909.8	824.2 – 848.8 1850.2 – 1909.8	824.2 – 848.8 1850.2 – 1909.8	824.2 – 848.8 1850.2 – 1909.8
Mode(s) of Operation	802.11b	802.11g	802.11n	Bluetooth
Nominal Maximum conducted RF Output Power (dBm)	19.0	18.0	17.0	9.8
Tolerance in Power Setting on centre channel (dB)	± 1.5	± 1.5	± 1.5	N/A
Duty Cycle	1:1	1:1	1:1	N/A
Transmitting Frequency Range (MHz)	2412-2462	2412-2462	2412-2462	2402-2483
Mode(s) of Operation	802.11a/n (low band)	802.11a/n (middle band)	802.11a/n (upper band I)	802.11a/n (upper band II)
Nominal Maximum conducted RF Output Power (dBm)	13.5	15.0	17.5	17.0
Tolerance in Power Setting on centre channel (dB)	± 1.5	± 1.5	± 1.5	± 1.5
Duty Cycle	1:1	1:1	1:1	1:1
Transmitting Frequency Range (MHz)	5180-5240	5260-5320	5520-5700	5745-5825

	Document Hearing Aid Compatibility Audio Band Magnetic (ABM) T-Coil Test Report for BlackBerry® Smartphone model RFV121LW Rev 2		Page 7(25)
	Author Data Daoud Attayi	Dates of Test May 31-June 06, 2013	Report No RTS-6046-1310-33 Rev 2

Mode(s) of Operation	HSPA ⁺ / WCDMA / UMTS FDD V (850)	HSPA ⁺ / WCDMA / UMTS FDD IV (1800)	HSPA ⁺ / WCDMA / UMTS FDD II (1900)	NFC
Nominal Maximum conducted RF Output Power (dBm)	23.0	22.5	22.5	N/A
Tolerance in Power Setting on centre channel (dB)	± 0.5	± 0.5	± 0.5	N/A
Duty Cycle	1:1	1:1	1:1	N/A
Transmitting Frequency Range (MHz)	824.6 – 846.6	1712.4 – 1752.6	1852.4 – 1907.6	13.56

Table 1.3-1 Test device characterization for U.S. wireless operating modes/bands

Note 1: BT and NFC are not activated during test because it is not held-to-ear service.

Note 2: The device also supports North American LTE band: 2, 4, 5 and 17, however LTE bands were not activated during test because VoLTE is not supported.

	Document Hearing Aid Compatibility Audio Band Magnetic (ABM) T-Coil Test Report for BlackBerry® Smartphone model RFV121LW Rev 2		Page 8(25)
	Author Data Daoud Attayi	Dates of Test May 31-June 06, 2013	Report No RTS-6046-1310-33 Rev 2

3.3 Antenna description

Type	Internal fixed antenna
Location	Bottom back centre (main licensed transmitter)
Configuration	Internal fixed antenna

Table 3.3-1 Antenna description

3.4 Battery

- 1) BAT-51585-00x

4.0 List of test equipment

Manufacturer	Test Equipment	Model Number	Serial Number	Calibration Due Date (MM/DD/YY)
SCHMID & Partner Engineering AG	Data Acquisition Electronics	DAE4	881	01/14/2014
SCHMID & Partner Engineering AG	Helmholtz Coil AMCC	N/A	1021	CNR
SCHMID & Partner Engineering AG	Audio Band Magnetic Measuring Instrument (AMMI)	N/A	1103	CNR
Rohde & Schwarz	Base Station Simulator	CMU200	109747	11/19/2013
Rohde & Schwarz	Telephone Magnetic Field Simulator	TMFS	1003	11/30/2013
SCHMID & Partner Engineering AG	Audio Band Magnetic Probe	AM1DV3	3062	01/10/2014

Table 4.0-1 List of test equipment

	Document Hearing Aid Compatibility Audio Band Magnetic (ABM) T-Coil Test Report for BlackBerry® Smartphone model RFV121LW Rev 2		Page 9(25)
	Author Data Daoud Attayi	Dates of Test May 31-June 06, 2013	Report No RTS-6046-1310-33 Rev 2

5.0 DASYS5 HAC T-Coil measurement system and setup

5.1 Audio signals

The following audio signal files are used for calibration and measurements:

48k_voice_1kHz_1s: Used according to [1] 6.3.1 step 2, The bandwidth is suited for signal quality or signal level measurements.

Multisine signal 50 Hz – 5 kHz (duration 10 s): Signal with carrier centered in each third-octave band, as used during the calibration.

48k_voice_300-3000 (duration 2 s): The signal is voice like and has been processed to have a duration of 2 seconds for fast measurement. The bandwidth is suited for frequency response measurement.

Signal type	48k_voice_1kHz_1s	48k_voice_300-3000_2s
Measurement Window Start (ms)	300	300 or 2000
Measurement Window Length (ms)	1000	6000 or 4000

Table 5.1-1 Audio files length and averaging times

5.2 Input level measurement

To determine correct input level, the Encoder / Decoder of a Rohde & Schwarz CMU 200 base station simulator was calibrated for measured full-scale input voltage level.

For this particular CMU200 SN: 109747, the measured full-scale voltage level, the equivalent input voltage level of -16 dBm0 was calculated to be - 18.69 dBV (116 mV) and for voltage level of -18 dBm0 was calculated to be -20.70 dBV (92.3 mV).

Time averaging was used with an artificial speech based signal when setting the input reference level. The averaging period was adequate to cover the signal period and the averaging method was the same for setting the reference level and performing the measurement.

5.3 Bandwidth compensation

ABM1 values and deduced quantities (SNR and frequency response scaling) are based on the measured field in the 1 kHz third-octave filter. Bandwidth compensated values are available under the following conditions:

- A reference measurement with the same signal type is available (T-Coil job marked with “use as reference”) before the job to be compensated.
- The reference measurement is taken in the AMCC (z orientation), evaluating the coil signal.

	Document Hearing Aid Compatibility Audio Band Magnetic (ABM) T-Coil Test Report for BlackBerry® Smartphone model RFV121LW Rev 2		Page 10(25)
	Author Data Daoud Attayi	Dates of Test May 31-June 06, 2013	Report No RTS-6046-1310-33 Rev 2

- The reference measurement precedes the job within the same procedure.
- Before displaying the desired value based on the measured ABM1 value, a pop-up window appears, proposing a default value based on the reference measurement.

The proposed value is calculated as the ratio of (power sum of third-octave filters from 100 Hz to 5 kHz) / (ABM1 in 1 kHz third-octave filter). This factor leads to the “ABM1 bandwidth compensated” which is an estimation of the signal level of a narrowband ABM1 signal with the same input amplitude. The estimated value may however differ from a measurement with a narrowband signal due to nonlinearity effects or contribution of noise and interference available during the reference measurement.

If an input signal is completely within the 1 kHz third-octave band is used (narrow band signal), no compensation is required. If the test signal contains spectral components in other third-octave bands, the power in the 1 kHz subband is lower for the same overall power, and the reading from the 1 kHz band is consequently reduced. This reduction shall be compensated to give the equivalent reading as when using a narrowband signal. The reduction - when using a wideband signal with the same overall RMS power - is the ratio between the overall RMS power and the RMS power in the 1 kHz band. For signal with limited bandwidth (e.g. from 300 Hz to 3 kHz), the power is determined by summing up their contribution in all third-octave subbands. The correction is the ratio "sum power / 1 kHz power" (linear) or the equivalent value in dB ($20 * \log(V_{rms\ total} / V_{rms\ 1k})$).

For 1025 Hz, the proposed factor is very close to 0 dB (linear 1), because the signal is completely within the 1 kHz subband. Small deviations may occur due to noise during the reference measurement, or due to other spectral components. Differences between the narrowband and the voice signal test: ABM1 (without BWC) for the same RMS reading is smaller for the wideband (voice) signal compared to the narrowband signal by the BWC. For the “**48k_voice_300-3000 (duration 2 s)**” predefined signals, the difference is provided by SPEAG to be 10.8 dB.

During the reference measurement, the spectral distribution of the input signal is determined. A spectral distribution results which is equivalent to the input distribution plus the response of the WD. To determine the response of the WD, the spectrum from the WD is deducted. The response is then compared to the limits, which are level dependent (based on the ABM1 signal level). For the display, the spectrum is displayed with the BWC applied.

5.4 Phantom

Figure 5.1 shows the phantom setup in a DASY5 system. The AMCC is mounted on the same plane as the HAC Test Arch phantom available from the HAC RF extension.

5.5 AMCC

The Audio Magnetic Calibration Coil is a Helmholtz Coil designed according to [1], section D.9 for calibration of the AM1D probe. The two horizontal coils generate a homogeneous magnetic field in the z direction.

	Document Hearing Aid Compatibility Audio Band Magnetic (ABM) T-Coil Test Report for BlackBerry® Smartphone model RFV121LW Rev 2		Page 11(25)
	Author Data Daoud Attayi	Dates of Test May 31-June 06, 2013	Report No RTS-6046-1310-33 Rev 2

Shunt sensitivity $H_c = 1$ A/m per 100mV according to formula:

$$H_c = (U / R) * N / r / (1.25 \wedge 1.5)$$

Number of turns $N = 20$ per coil
Coil radius $r = 143$ mm
Shunt resistance $R = 10.00$ Ohm

Please refer to the certificate of conformity doc No 880-SD HAC P02 A-A in Annex D for more detail.

5.6 AM1D probe

The AM1D probe is an active probe with a single sensor according to [1] section D.8. It is fully RF shielded and has a rounded tip of 6 mm diameter incorporating a pickup coil with its center offset 3mm from the tip and the sides.

SPEAG, the manufacturer of the T-Coil system tested the probe frequency response and its dynamic range. Compliance with [1] is stated in the Certificate of conformity document 880-SPAM1001A-A. Also the probe frequency has been verified and the response deviation from the ideal differentiator was within +0.05 and - 0.46 dB in the range 100 Hz to 10 kHz on the center frequencies of the third-octave bands. Note that this verification includes the probe preamplifier and the AMMI internal preamplifiers, filters and processing.

Frequency response:

The frequency response has been tested to be within +/- 0.5 dB of ideal differentiator from 100 Hz to 10 kHz. The test was performed with the real integrator and deducting the ideal integrator values. The reference signal was the Helmholtz calibration coil current which is equivalent to the field. The coil is qualified according to the probe manufacturer certificate.

The test data up to 5 kHz are visible directly in the calibration job result (coil current / shut voltage and probe voltage). Separate measurements were made for a very wide frequency range, including higher frequencies. The third-octave bands up to 5 kHz do not exceed + 0.05 dB and decay by < 0.2 dB to 5 kHz and by < 0.5 dB to 10 kHz , as required.

Dynamic range:

maximum + 21 dB A/m @ 1 kHz
Noise level typically -70 dB A/m @ 1 kHz
ABM2 typically -60 dB A/m

Linearity

Within < 0.1 dB from 5 dB
below limitation to 16 dB above noise level

Linearity has also been tested and is stated in the certificate. Deviation was not measurable from 5 dB below limitation to 26 dB above noise level. For lower levels, the deviation increased to 0.1 dB at 16 dB above noise level, which corresponds to the theoretical value of 0.11 dB expected at that noise suppression level.

Significant noise contribution beyond 10 kHz will be attenuated by the convolution A-filter. Such interferences also contribute to ABM2 represented as numerical value from the integration.

	Document Hearing Aid Compatibility Audio Band Magnetic (ABM) T-Coil Test Report for BlackBerry® Smartphone model RFV121LW Rev 2		Page 12(25)
	Author Data Daoud Attayi	Dates of Test May 31-June 06, 2013	Report No RTS-6046-1310-33 Rev 2

Sensitivity

Typically -24 dBV / A/m @ 1 kHz probe output

For detailed T-Coil probe's dynamic range, linearity and frequency response demonstration, the manufacturer has supplied a report directly to the FCC which is not intended for publication.



Figure 5.0-1: T-Coil set up with HAC Test Arch with Helmholtz Coil (AMCC)

	Document Hearing Aid Compatibility Audio Band Magnetic (ABM) T-Coil Test Report for BlackBerry® Smartphone model RFV121LW Rev 2		Page 13(25)
	Author Data Daoud Attayi	Dates of Test May 31-June 06, 2013	Report No RTS-6046-1310-33 Rev 2

5.7 AMMI

The Audio Magnetic Measuring Instrument (AMMI) is a desktop 19-inch unit containing a sampling unit, a waveform generator for test and calibration signals and a USB interface.

Audio Out BNC, audio signal to the base station simulator, for > 500 Ohm load
Coil Out BNC, test and calibration signal to the AMCC (top connector), for 50 Ohm load
Coil In XLR, monitor signal from the AMCC BNO connector, 600 Ohm
Probe In XLR, probe signal and phantom supply to the probe connector



Figure 5.0-2. The Audio band Magnetic field Measuring Instrument (AMMI)

5.8 Cabling

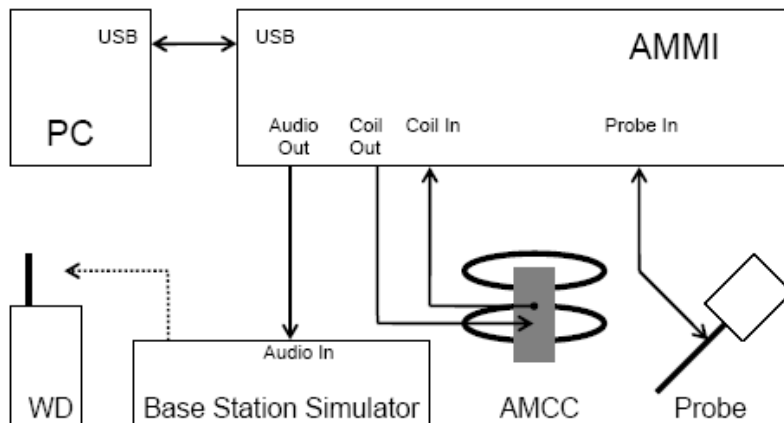



Figure 5.0-3. T-Coil set up cabling

	Document Hearing Aid Compatibility Audio Band Magnetic (ABM) T-Coil Test Report for BlackBerry® Smartphone model RFV121LW Rev 2		Page 14(25)
	Author Data Daoud Attayi	Dates of Test May 31-June 06, 2013	Report No RTS-6046-1310-33 Rev 2

6.0 Measurement procedures

6.1 Surface check and probe sensitivity measurements

Calibrate HAC phantom: After teaching of the reference points P1, P2 and P3 of the HAC Test Arch and installation of a WD below the Test Arch, the plane defined by the 3 points may correspond to the top plane of the Test Arch. This option of the Surface Check job measures the mechanical surface with the probe in vertical position, using all 4 points and determines the optimal plane for all the following measurements. The coordinate system of the whole setup is adjusted to the resulting plane.

Calibrate AM1D probe: This option allows the adjustment of the sensor center of the AM1D probe accurately at the desired measurement point. In Southwest tilting mode, the probe center should be aligned to the position 3.0mm above point P1 by shifting the x, y and z coordinates. The probe surface is in this situation directly located at the center of point P1. The offset resulting from this teaching process is stored in the installation of the phantom for further use with the same configuration.

Calibration

If the "Calibration" signal is selected in the T-Coil measurement job, a 3-phase calibration is performed.

In phase 1, the audio output is switched off, and a 200 mV_{pp} symmetric rectangular signal of 1 kHz is generated and internally connected directly to both channels of the sampling unit (coil in, probe in).

In phase 2, the audio output is off, and a 20 mV_{pp} symmetric 100 Hz signal is internally connected.

The signals during these phases are available at the output on the rear panel of the AMMI. The output must however not be loaded in order not to influence the calibration. After the first two phases, the two input channels are both calibrated for absolute measurements. The resulting factors are displayed above the multimeter window.

In phase 3, a multisine signal covering each third-octave band from 50 Hz to 5 kHz is generated and applied to both audio outputs. The probe should be positioned in the center of the AMCC (user point "coil center") and aligned in the z-direction, the field orientation of the AMCC. The Coil In channel is measuring the voltage over the AMCC internal shunt, which is proportional to the magnetic field in the AMCC. At the same time, the Probe In channel samples the amplified signal picked up by the probe coil. The ratio of the two voltages – in each third-octave filter

Leads to the calibration factor of the probe over the frequency band of interest for the spectral representation.

The measured probe sensitivity, target and delta values are shown below:

	Document Hearing Aid Compatibility Audio Band Magnetic (ABM) T-Coil Test Report for BlackBerry® Smartphone model RFV121LW Rev 2		Page 15(25)
	Author Data Daoud Attayi	Dates of Test May 31-June 06, 2013	Report No RTS-6046-1310-33 Rev 2
		FCC ID L6ARFV120LW	

Measured probe sensitivity V / (A/m)	Target manufacturer probe sensitivity V / (A/m)
0.007410	0.007415

Table 6.1-1 Measured probe (AM1DV3) sensitivity value

6.2 Audio band magnetic ambient noise measurement

For each probe orientation, the background noise was measured without an active WD in the area of the scan and the noise was determined to be < 10 dB than the lowest ABM2 measurement, where applicable.

6.3 Reference check/system validation using a TMFS

A reference check of the test setup and instrumentation was performed using a reference TMFS (Telephone Magnetic Field Simulator).

The TMFS was positioned into the test setup at the position to be occupied by the WD. The emissions from the TMFS were measured and confirmed to be within tolerance of the expected values.

Distance TMFS top-probe centre	10 mm
Scan resolution dx, dy	2-5 mm
Scan area	50 x 50 mm
Frequency	1 KHz
Signal level to TMFS for field scan	500 mV rms
Signal type for field scan	1 KHz sine
Signal type for frequency reponse	Multisine signal 50-5000 Hz

Table 6.3-1. Setup and configuration for system validation using TMFS

	Measured Value dB (A/m)	Manufacturer Target Value dB(a/m)	Ambient Noise dB (A/m)
Axial	-20.19	-20.36	-56.02
Radial T	-26.38	-25.95	-55.98
Frequency Response	Flat	Flat	N/A

Table 6.3-2 Maximum measured, target field and delta values for system validation using TMFS

	Document Hearing Aid Compatibility Audio Band Magnetic (ABM) T-Coil Test Report for BlackBerry® Smartphone model RFV121LW Rev 2		Page 16(25)
	Author Data Daoud Attayi	Dates of Test May 31-June 06, 2013	Report No RTS-6046-1310-33 Rev 2

6.4 ABM1 / ABM2 detailed math and probe factor

ABM1 measurement flow chart:

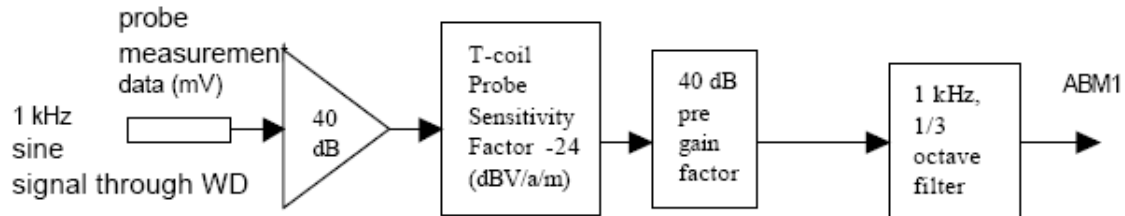

Figure 6.4-1. ABM1 block diagram

Sine tone:

RTA 1 kHz (data + probe sensitivity of (24.0 dB V/(a/m)) – 40 dB pre-gain) = ABM1 (in dB (A/m))

ABM2 measurement flow chart:

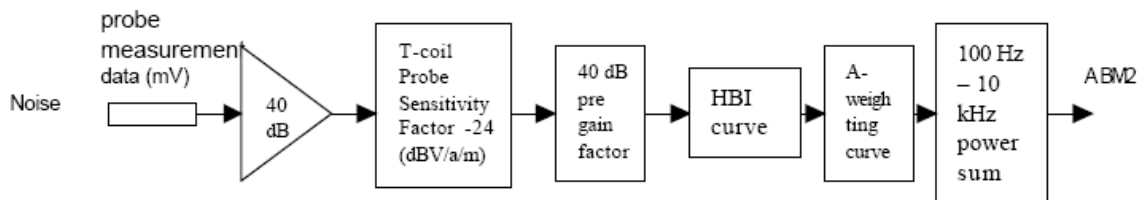



Figure 6.4-2. ABM2 block diagram

Broadband noise:

Power Sum 1/3 octave, 0.1 - 10 kHz [RTA 0.1 – 10 kHz (data + probe sensitivity of (24.0 dB V/(A/m)) – 40 dB pre-gain)] + HBI curve + A_weighting curve = ABM2 (in dB (A/m))

ABM2 includes HBI as well as A-weighting curves as shown above.

The numerical values (ABM Noise) are the final result of the weighted integral. DASY5 uses filters by applying convolution in the time-domain. Therefore, significant contributions beyond 10 kHz would appear in the ABM2 result, even if they are not directly visible in the visualized spectrum.

	Document Hearing Aid Compatibility Audio Band Magnetic (ABM) T-Coil Test Report for BlackBerry® Smartphone model RFV121LW Rev 2		Page 17(25)
	Author Data Daoud Attayi	Dates of Test May 31-June 06, 2013	Report No RTS-6046-1310-33 Rev 2

6.5 Test measurement

1. Calibrate the AM1D probe using a Helmholtz coil with reference calibration signal as per section 6.1.
2. For each probe orientation, measure ambient noise.
3. A reference check of the test setup and instrumentation may be performed using a TMFS. Position the TMFS into the test setup at the position to be occupied by the WD. Measure the emissions from the TMFS and confirm that they are within tolerance of the expected values.
4. Position the WD in the test setup as shown on Figure 5.1 and connect the WD RF connector to a base station simulator.
5. Set the reference drive level for the system and set volume any level up to maximum control setting. The drive level is set such that the reference input level is input to the base station in the 1 kHz, 1/3 octave band. This drive level shall be used for the audio band signal test (ABM1 at fi). Either a sine wave at 1025 Hz or a voice-like signal shall be used for the reference audio signal. If interference is found at 1025 Hz an alternate reference audio signal frequency may be used. The same drive level will be used for the ABM1 frequency response measurements at each 1/3 octave band center frequency.
6. Determine the peak audio magnetic measurement for the WD device by scanning a 50x50 mm coarse (5 mm step) and a fine scan of 8x8 mm (2 mm step) for each probe orientation.
7. At each peak field measurement location measure and record the desired audio band magnetic signals (ABM1 at fi). The desired audio band input frequency (fi) shall be centered in each 1/3 octave band maintaining the same drive level and the reading taken for that band.
8. The separation distance of 1 cm is controlled between the center of the probe sensor and the top highest surface of the WD, throughout the measurement.

The following reference input levels that correlate to a normal speech input level shall be used for the standard transmission protocols.

STANDARD	TECHNOLOGY	INPUT (dBm0)
TIA/EIA/IS-2000	CDMA	-18
TIA/EIA/IS-136	TDMA (50 Hz)	-18
J-STD-007	GSM (217 Hz)	-16
IDEN	TDMA (22 and 11 Hz)	-18
T1/T1P1/3GPP	UMTS (WCDMA)	-16

Table 6.5-1 Normal speech input levels

Note: For protocols not listed, use the normal speech input level as defined in the relevant specifications for that air interface.

8. At each peak field measurement location measure and record the undesired broadband audio magnetic signal (ABM2) with no signal applied (or digital zero applied, if appropriate) using A-weighting, and calculate the ratio of the desired to undesired signal strength (i.e. – signal quality)
9. From the measured signal to noise ratio, classify signal quality as T1 to T4 using the limits from Table 6.5-2.

	Document Hearing Aid Compatibility Audio Band Magnetic (ABM) T-Coil Test Report for BlackBerry® Smartphone model RFV121LW Rev 2		Page 18(25)
	Author Data Daoud Attayi	Dates of Test May 31-June 06, 2013	Report No RTS-6046-1310-33 Rev 2

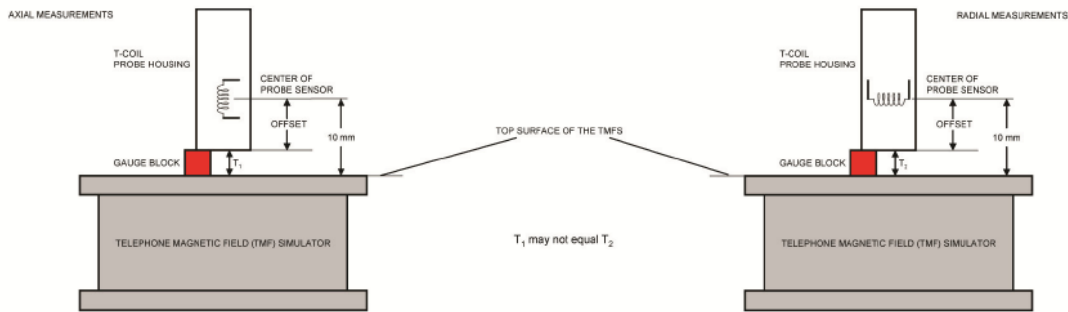

Figure 6.5-1 -Coil measurement setup verification using the TMFS

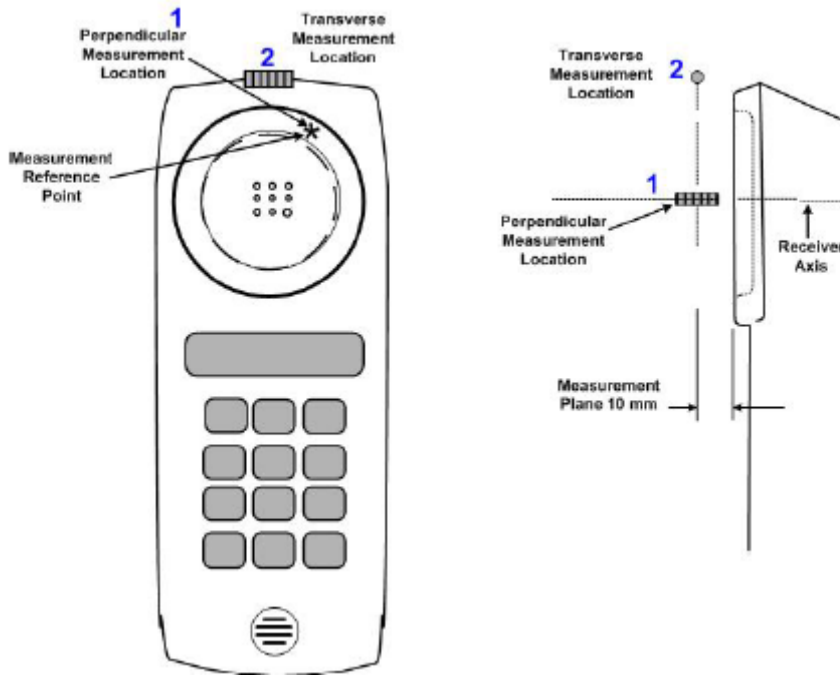



Figure 6.5-2 Axis & planes for WD audio band magnetic field measurements

	Document Hearing Aid Compatibility Audio Band Magnetic (ABM) T-Coil Test Report for BlackBerry® Smartphone model RFV121LW Rev 2		Page 19(25)
	Author Data Daoud Attayi	Dates of Test May 31-June 06, 2013	Report No RTS-6046-1310-33 Rev 2
		FCC ID L6ARFV120LW	

Category	Telephone parameters WD signal quality [(signal + noise)-to-noise ratio in decibels]
Category T1	0 dB to 10 dB
Category T2	10 dB to 20 dB
Category T3	20 dB to 30 dB
Category T4	> 30 dB

Table 6.5-2 T-Coil signal quality categories

Field orientation	At frequency (KHz)	Audio Filter	Limit dB (A/m)
Axial, Radial T	1.025	1/3 octave band	≥ -18

Table 6.5-3 Field Intensity (ABM1 signal) Limit

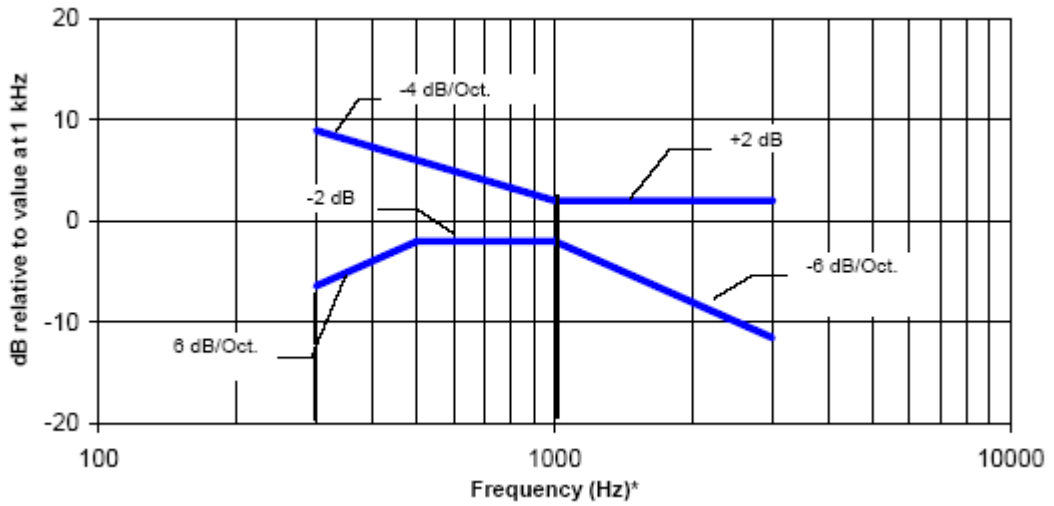

Figure 6.5-3 Magnetic field frequency response for WDs with a field between 10 dB and -13 dB (A/m) at 1 kHz

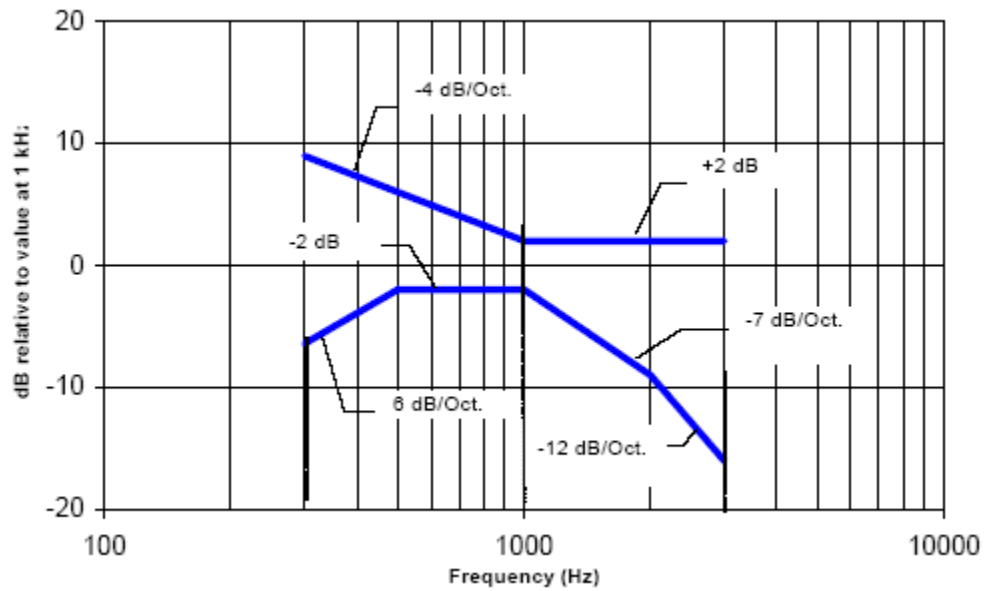



Figure 6.5-4 Magnetic field frequency response for WDs with a field that exceeds -10 dB(A/m) at 1 kHz

7.0 Summary of test results

Mode	Probe orientation	f (MHz)	Cond. Pwr. (dBm)	ABM1 dB (A/m)	ABM2 dB (A/m)	ABM1/ABM2 dB	Freq. Resp. Verd.	T-Rating
GSM 850	Axial	824.2	33.4	3.86	-32.2	36.06	P	4
	Radial T	824.2	33.4	-5.60	-51.92	46.32	N/A	4
	Axial	836.8	33.2	3.83	-32.4	36.23	P	4
	Radial T	836.8	33.2	-5.60	-51.48	45.88	N/A	4
	Axial	848.8	33.0	3.83	-32.71	36.54	P	4
	Radial T	848.8	33.0	-5.68	-52.25	46.57	N/A	4
GSM 1900	Axial	1850.2	29.9	2.67	-37.2	39.87	P	4
	Radial T	1850.2	29.9	-6.70	-53.07	46.37	N/A	4
	Axial	1880	30.3	2.59	-37.38	39.97	P	4
	Radial T	1880	30.3	-6.76	-53.2	46.44	N/A	4
	Axial	1909.8	30.3	2.65	-37.27	39.92	P	4
	Radial T	1909.8	30.3	-7.07	-53.43	46.36	N/A	4
WCDMA Band V	Axial	826.4	23.1	3.41	-52.7	56.11	P	4
	Radial T	826.4	23.1	-4.98	-54.82	49.84	N/A	4
	Axial	836.4	23.2	3.43	-52.8	56.23	P	4
	Radial T	836.4	23.2	-4.50	-54.74	50.24	N/A	4
	Axial	846.4	23.1	3.40	-52.59	55.99	P	4
	Radial T	846.4	23.1	-4.53	-54.63	50.10	N/A	4
WCDMA Band IV	Axial	1712.4	23.0	4.12	-52.69	56.81	P	4
	Radial T	1712.4	23.0	-4.08	-54.64	50.56	N/A	4
	Axial	1732.6	23.0	4.09	-52.28	56.37	P	4
	Radial T	1732.6	23.0	-4.61	-54.98	50.37	N/A	4
	Axial	1752.6	22.9	4.10	-52.31	56.41	P	4
	Radial T	1752.6	22.9	-4.23	-54.71	50.48	N/A	4
WCDMA Band II	Axial	1852.4	22.7	3.39	-52.54	55.93	P	4
	Radial T	1852.4	22.7	-4.53	-54.44	49.91	N/A	4
	Axial	1880	22.6	3.33	-52.51	55.84	P	4
	Radial T	1880	22.6	-4.53	-54.46	49.93	N/A	4
	Axial	1907.7	22.8	3.36	-52.49	55.85	P	4
	Radial T	1907.7	22.8	-4.58	-54.51	49.93	N/A	4
Overall T-Rating								4
M-rating								3

Table 7.1 ABM test data summary

	Document Hearing Aid Compatibility Audio Band Magnetic (ABM) T-Coil Test Report for BlackBerry® Smartphone model RFV121LW Rev 2		Page 22(25)
	Author Data Daoud Attayi	Dates of Test May 31-June 06, 2013	Report No RTS-6046-1310-33 Rev 2

7.1 Conclusion

The BlackBerry® Smartphone Model: **RFV121LW** is categorized to be **M3T4** based on HAC RF Emission and ABM T-Coil performance in accordance with ANSI C63.19-2011: American National Standard for Methods of Measurement of Compatibility between Wireless Communication Devices and Hearing Aids.

Therefore, the device is found to be in compliance with the requirements of FCC 20.19 (10-1-07 Edition) Hearing Aid-Compatible Mobile Handsets and FCC Report and Order, DA 12-550 (April, 2012).

8.0 Measurement uncertainty

Error Description	Uncertainty value [%]	Prob. Dist.	Div.	c ABM1	c ABM2	Std. Unc. ABM1	Std. Unc. ABM2
PROBE SENSITIVITY							
Reference level	3.0	N	1.0	1	1	3.0	3.0
AMCC geometry	0.4	R	1.7	1	1	0.2	0.2
AMCC current	0.6	R	1.7	1	1	0.4	0.4
Probe positioning during calibration	1.0	R	1.7	1	1	0.6	0.6
Noise contribution	0.7	R	1.7	0.014	1	0.0	0.4
Frequency slope	5.9	R	1.7	0.1	1.0	0.3	3.5
PROBE SYSTEM							
Repeatability / Drift	1.0	R	1.7	1	1	0.6	0.6
Linearity / Dynamic range	0.6	R	1.7	1	1	0.4	0.4
Acoustic noise	1.0	R	1.7	0.1	1	0.1	0.6
Probe angle	2.3	R	1.7	1	1	1.4	1.4
Spectral processing	0.9	R	1.7	1	1	0.5	0.5
Integration time	0.6	N	1.0	1	5	0.6	3.0
Field disturbance	0.2	R	1.7	1	1	0.1	0.1
TEST SIGNAL							
Reference signal spectral response	0.6	R	1.7	0	1	0.0	0.4
POSITIONING							
Probe positioning	1.9	R	1.7	1	1	1.1	1.1
Phantom thickness	0.9	R	1.7	1	1	0.5	0.5
DUT positioning	1.9	R	1.7	1	1	1.1	1.1
EXTERNAL CONTRIBUTIONS							
RF interference	0.0	R	1.7	1	1	0.0	0.0
Test signal variation	2.0	R	1.7	1	1	1.2	1.2
COMBINED UNCERTAINTY							
Combined Std. uncertainty (ABM field)						4.1	6.2
Expanded Std. uncertainty [%]						8.2	12.3

Table 8.1-1 Worst-Case uncertainty budget for HAC T-Coil assessment according to ANSI C63.19.

	Document Hearing Aid Compatibility Audio Band Magnetic (ABM) T-Coil Test Report for BlackBerry® Smartphone model RFV121LW Rev 2		Page 24(25)
	Author Data Daoud Attayi	Dates of Test May 31-June 06, 2013	Report No RTS-6046-1310-33 Rev 2

8.1 Site-Specific Uncertainty

RF Reflections

ANSI C63.19 requires that any RF reflecting objects are a minimum distance of 2 wavelengths away from the WD under test. For this WD, the longest wavelength occurs when the WD is transmitting at 824.7MHz. The wavelength is:

$$\lambda = \frac{c}{f} = \frac{3 \cdot 10^8 \text{ m/s}}{824.7 \text{ MHz}} = 0.364 \text{ m}$$

Therefore, 2 wavelengths result in a distance of 0.73m. Tests are performed in an RF shielded chamber. The distance to the nearest wall is >1m and the distance to the robot's safety guardrail is > 1.0m, both satisfying the requirement. In addition, RF absorbing cones are placed at the base of the robot to further reduce reflections. The HAC phantom arch is made of low dielectric constant plastic and should not be a source of reflections.

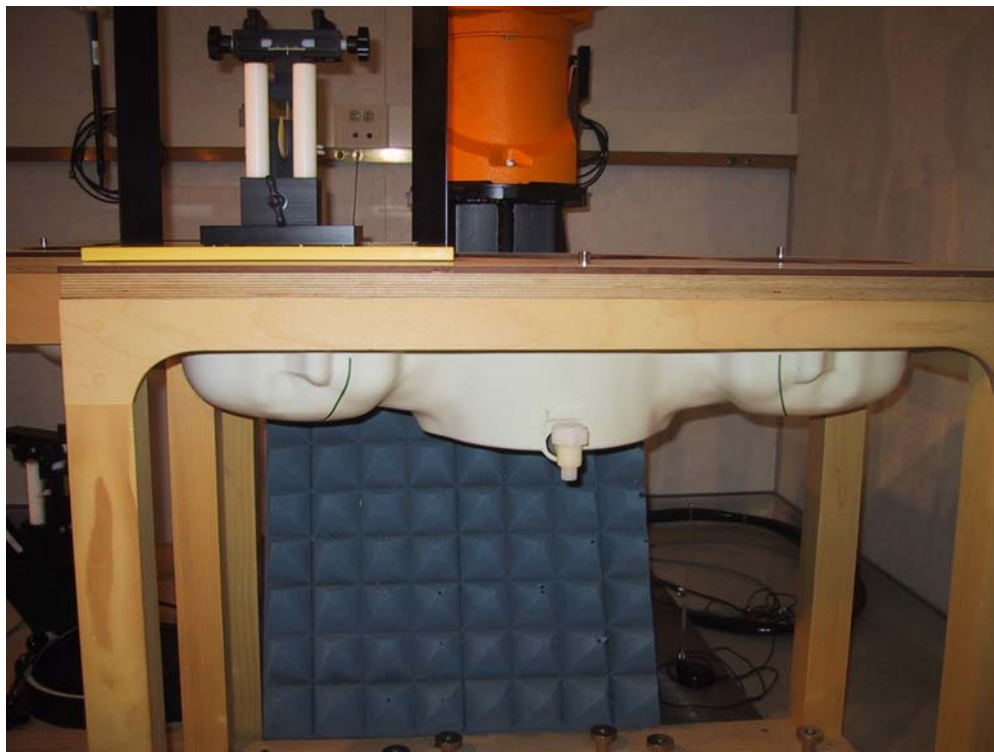



Figure 8.1-2 DASYS5 system with absorbing material

Environmental Conditions

During measurements, the temperature of the test lab was kept between 21°C and 25°C and relative humidity was maintained between 20% and 55%.

	Document Hearing Aid Compatibility Audio Band Magnetic (ABM) T-Coil Test Report for BlackBerry® Smartphone model RFV121LW Rev 2		Page 25(25)
	Author Data Daoud Attayi	Dates of Test May 31-June 06, 2013	Report No RTS-6046-1310-33 Rev 2

Ambient Noise

ANSI C63.19 section 6 requires the ambient noise to be at least 10 dB below the measurement level, where applicable. Measurement of the ambient magnetic field was performed for each probe orientation and the levels are shown in the Table 6.3 and Annex B plots to be lower than ABM1 and ABM2 by at least 10 dB.